

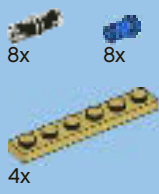

10214





# 52

1



2



3



4





5



4x

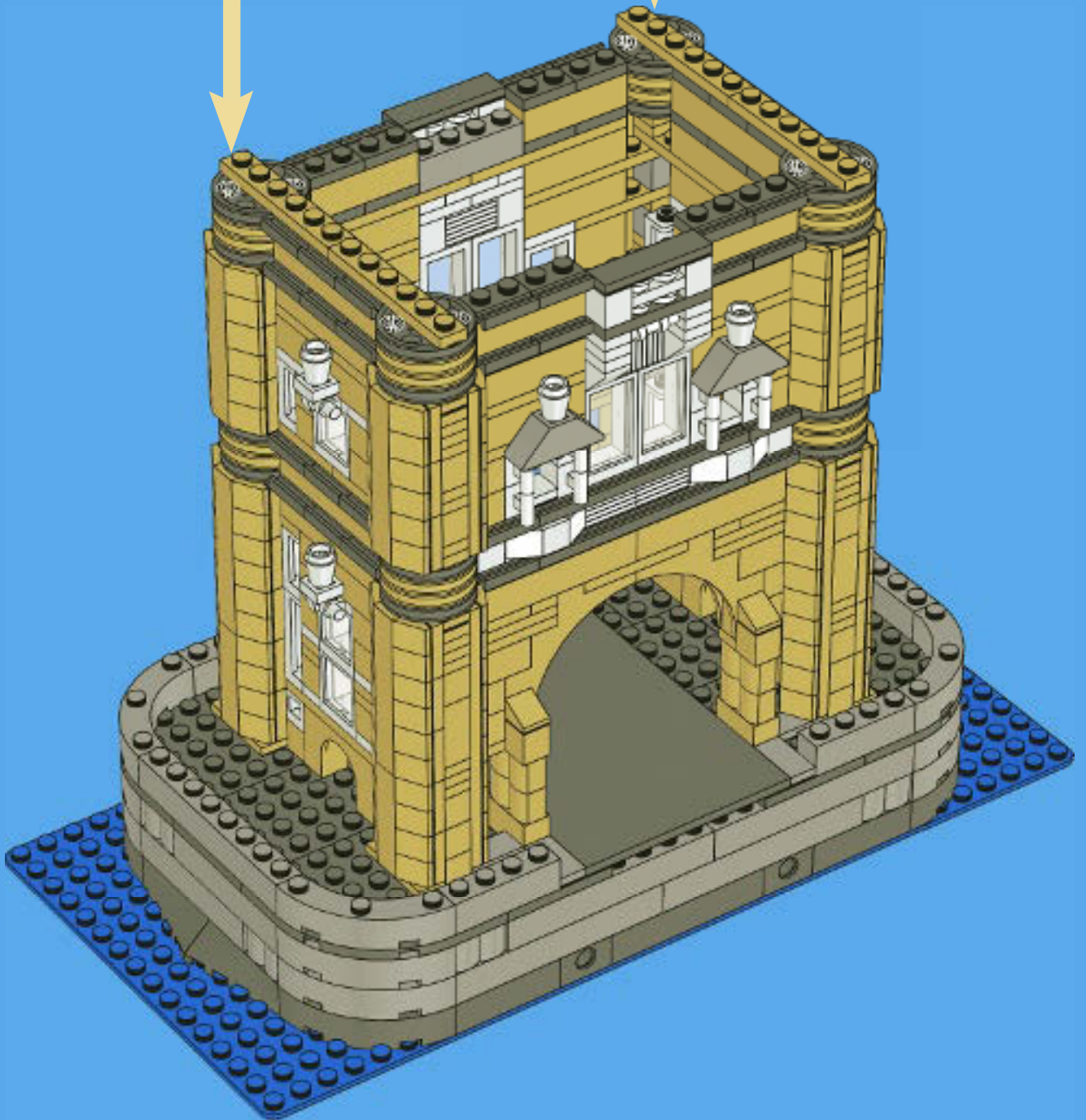



4x



10x



10x

# 53

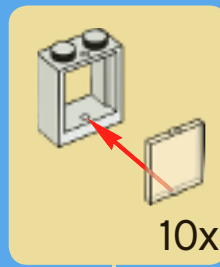

10x







24x



4x



4x



12x

# 54





4x



4x

# 55

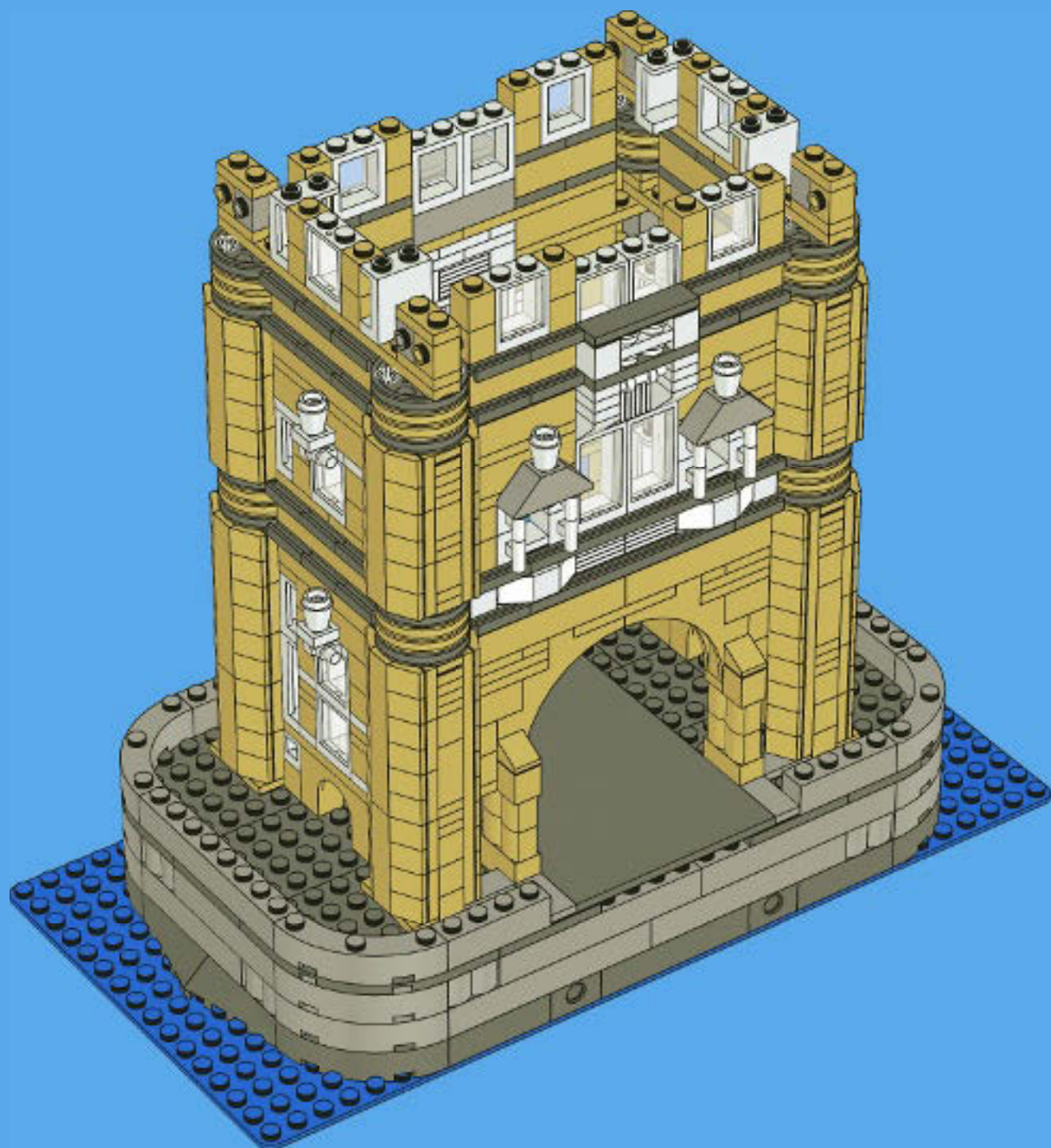



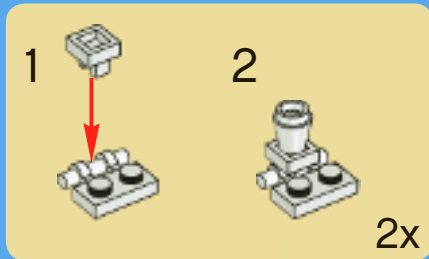
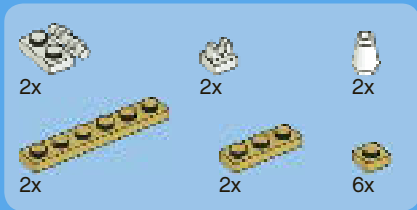

56



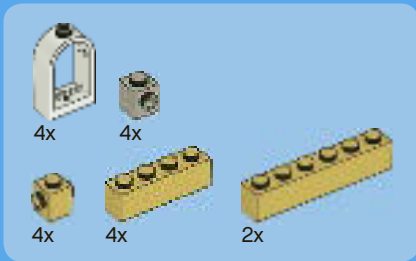

57







4x



4x

# 58



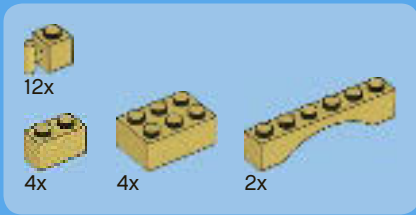

# 59







4x



18x



4x



4x



4x

1



2



4x

# 60





4x



24x

# 61

1



2

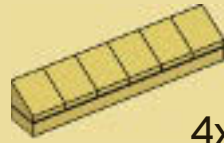

4x





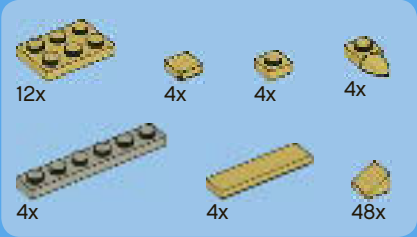

# 62

1

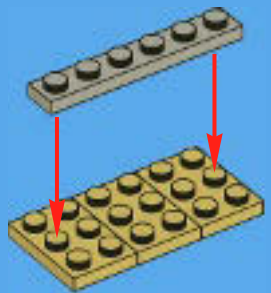

2



3



4

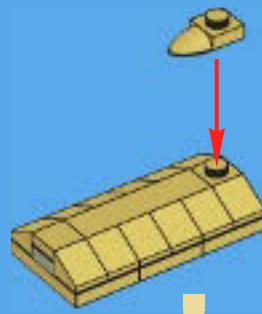

4x

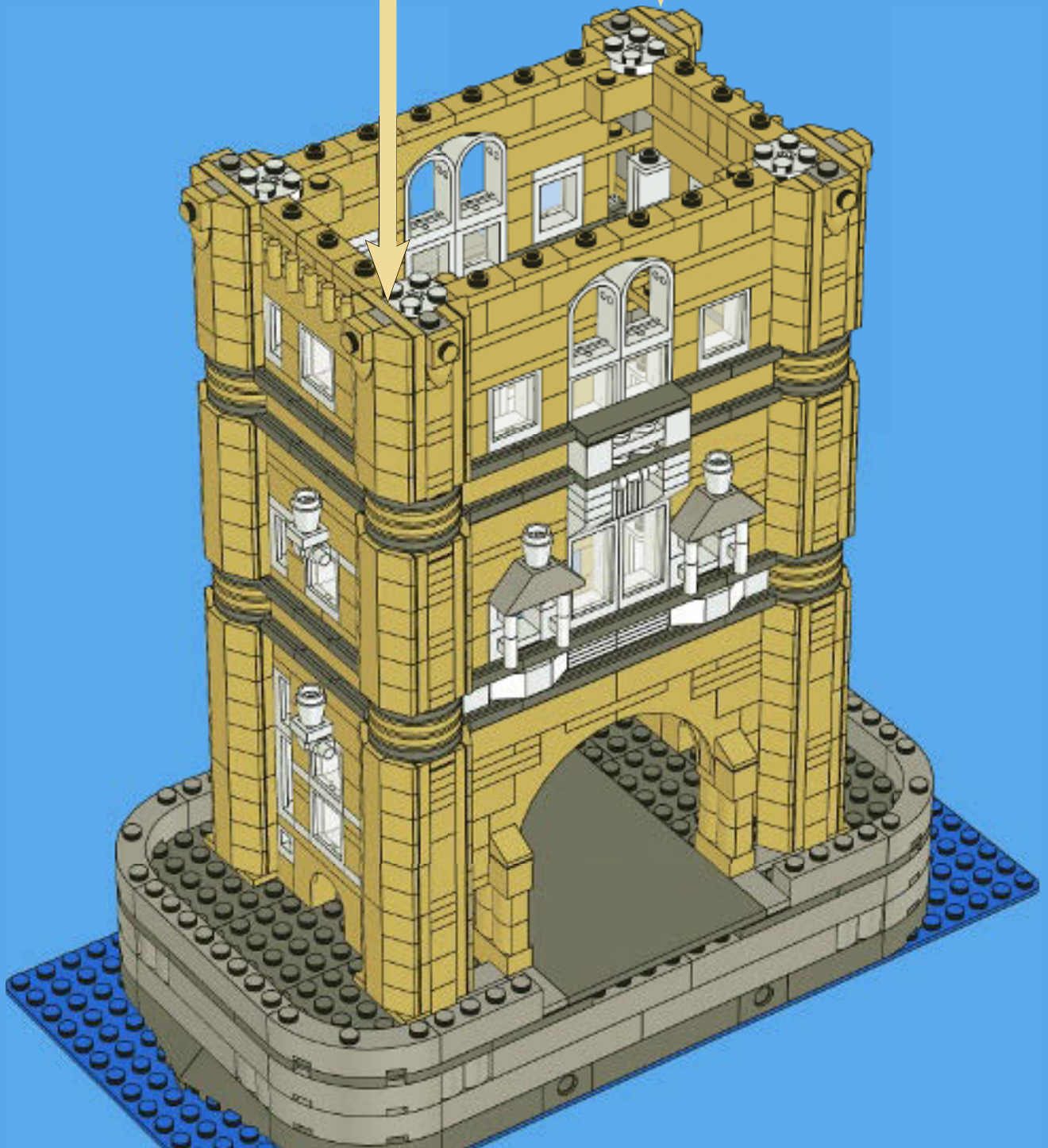



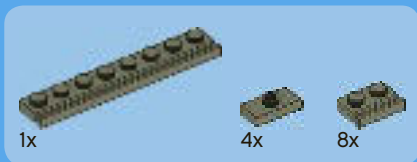

# 63





2x



4x

# 64







65



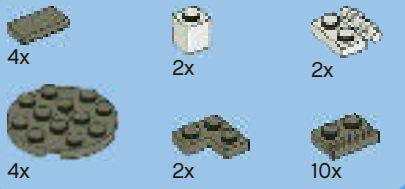

66

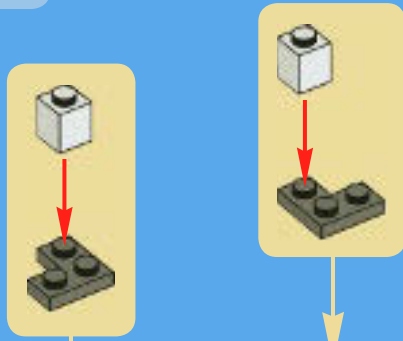



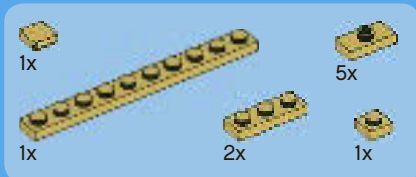

67





2x



2x



8x



2x

# 68





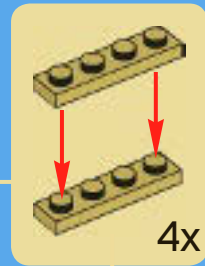
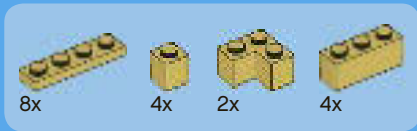

69



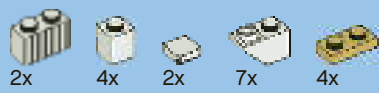

70





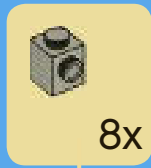
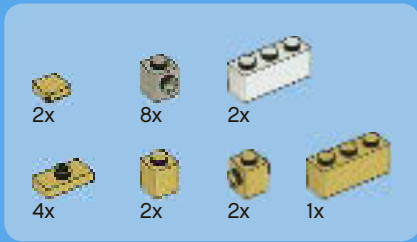

71

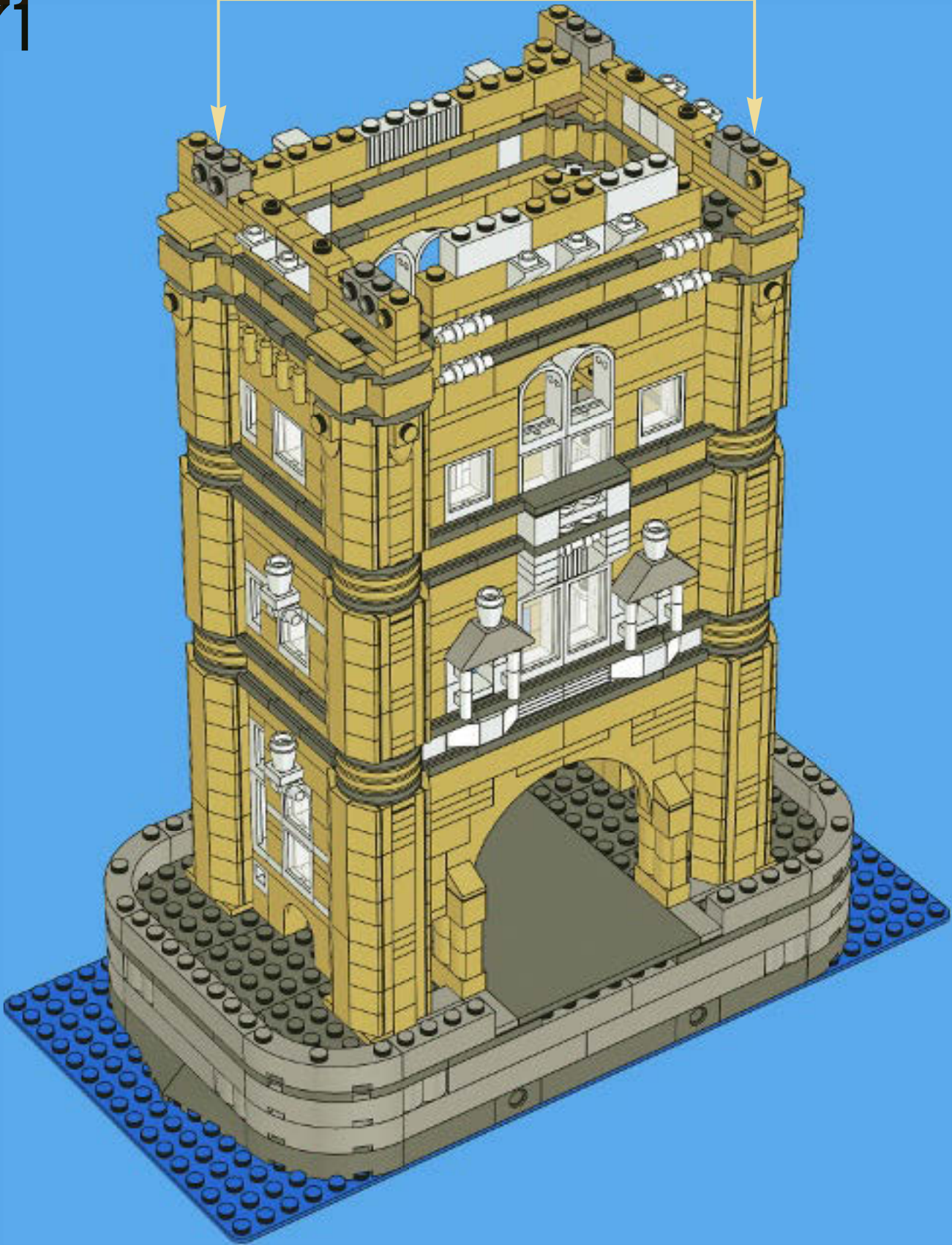





2x



8x

# 72

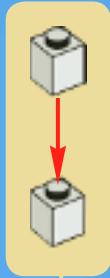
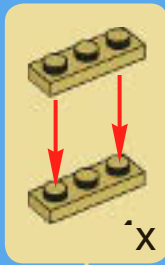



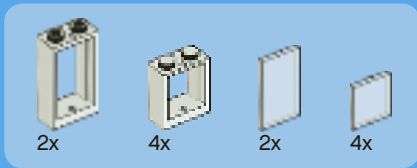

73

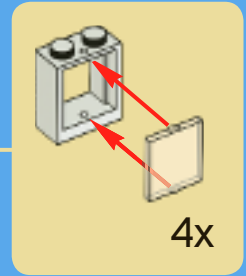
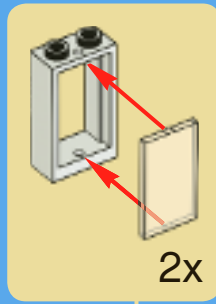





14x



2x



8x

# 74



4x

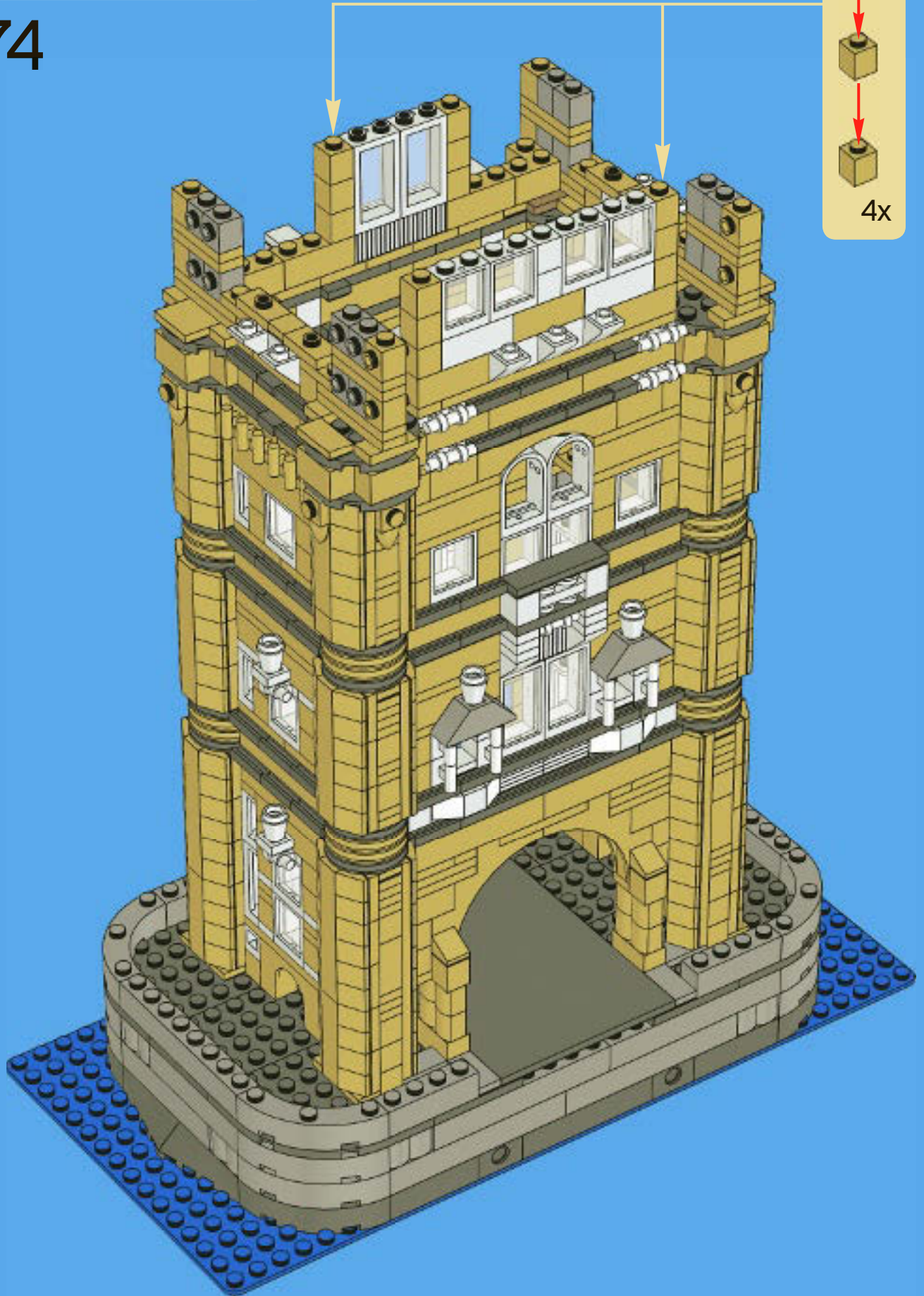





75



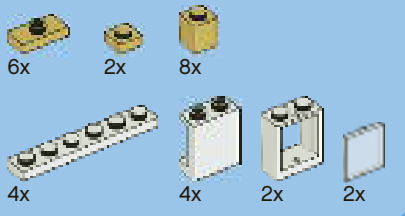

# 76

1

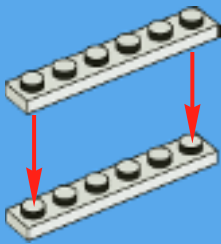

2

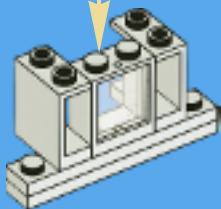
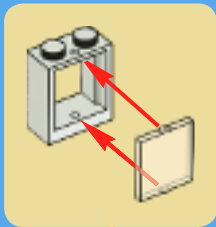

3

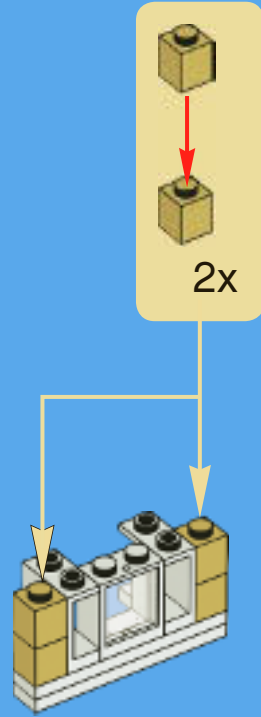

4

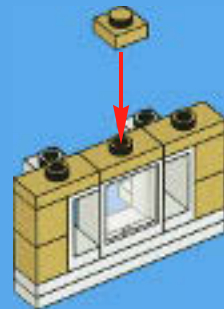

2x







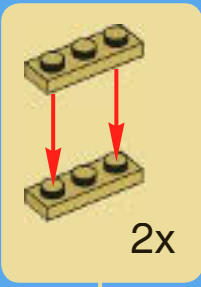
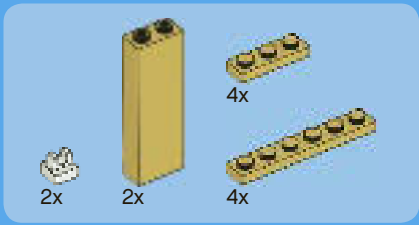

77







2x



2x



8x



4x

# 78





79

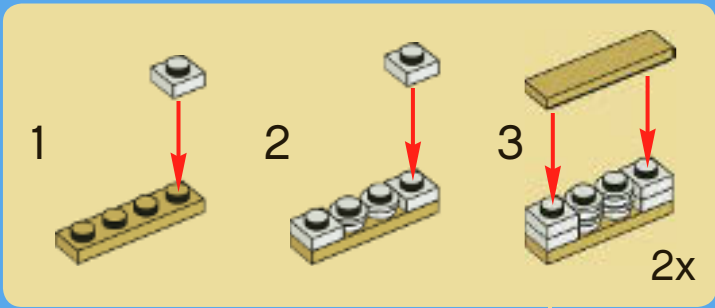



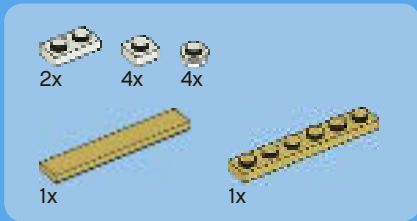

80

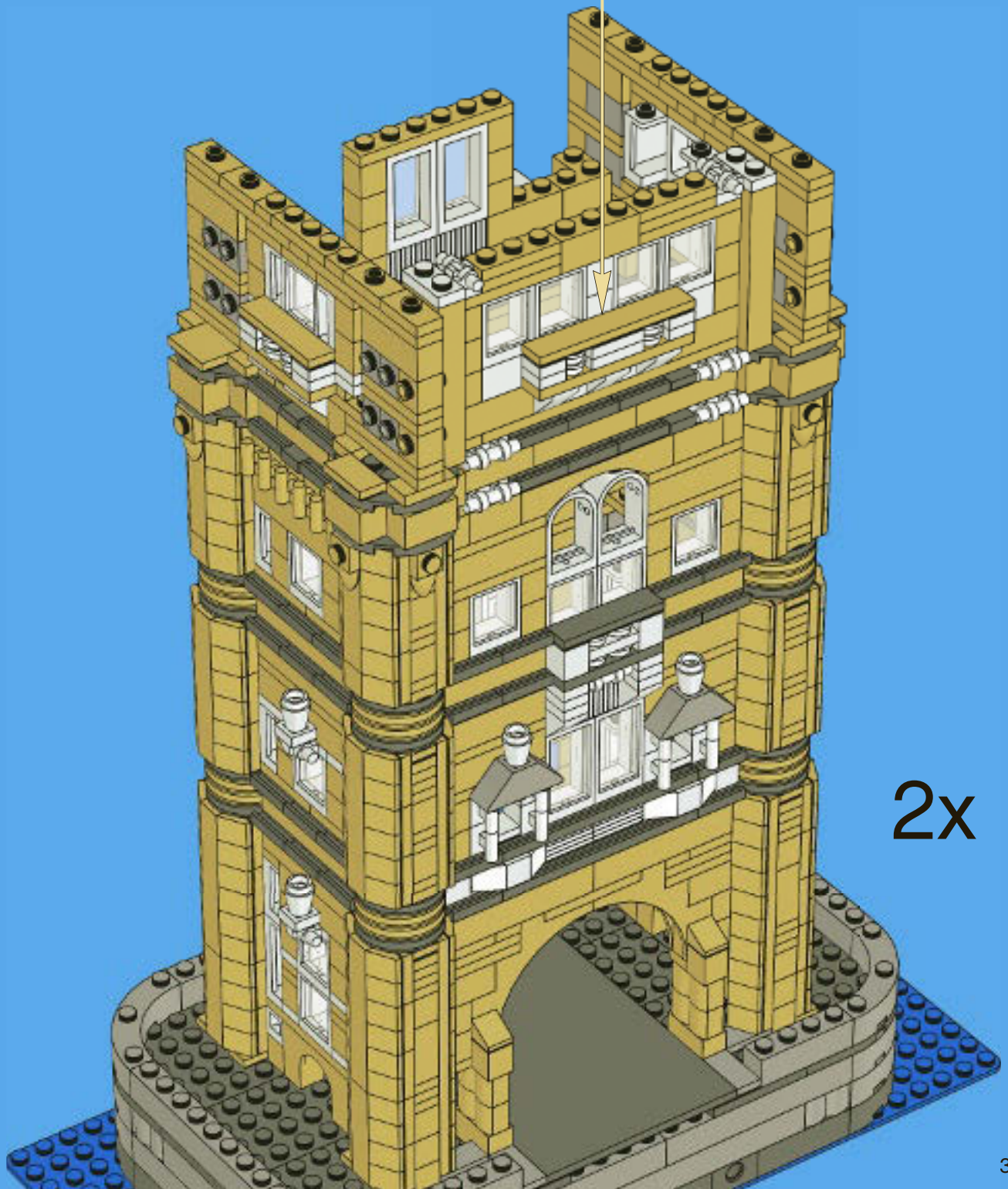
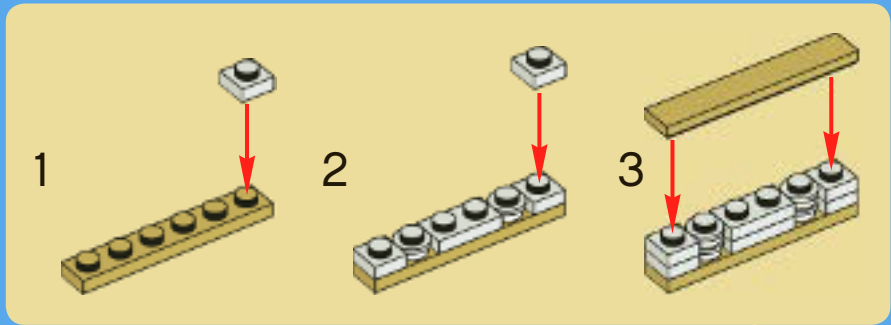

81

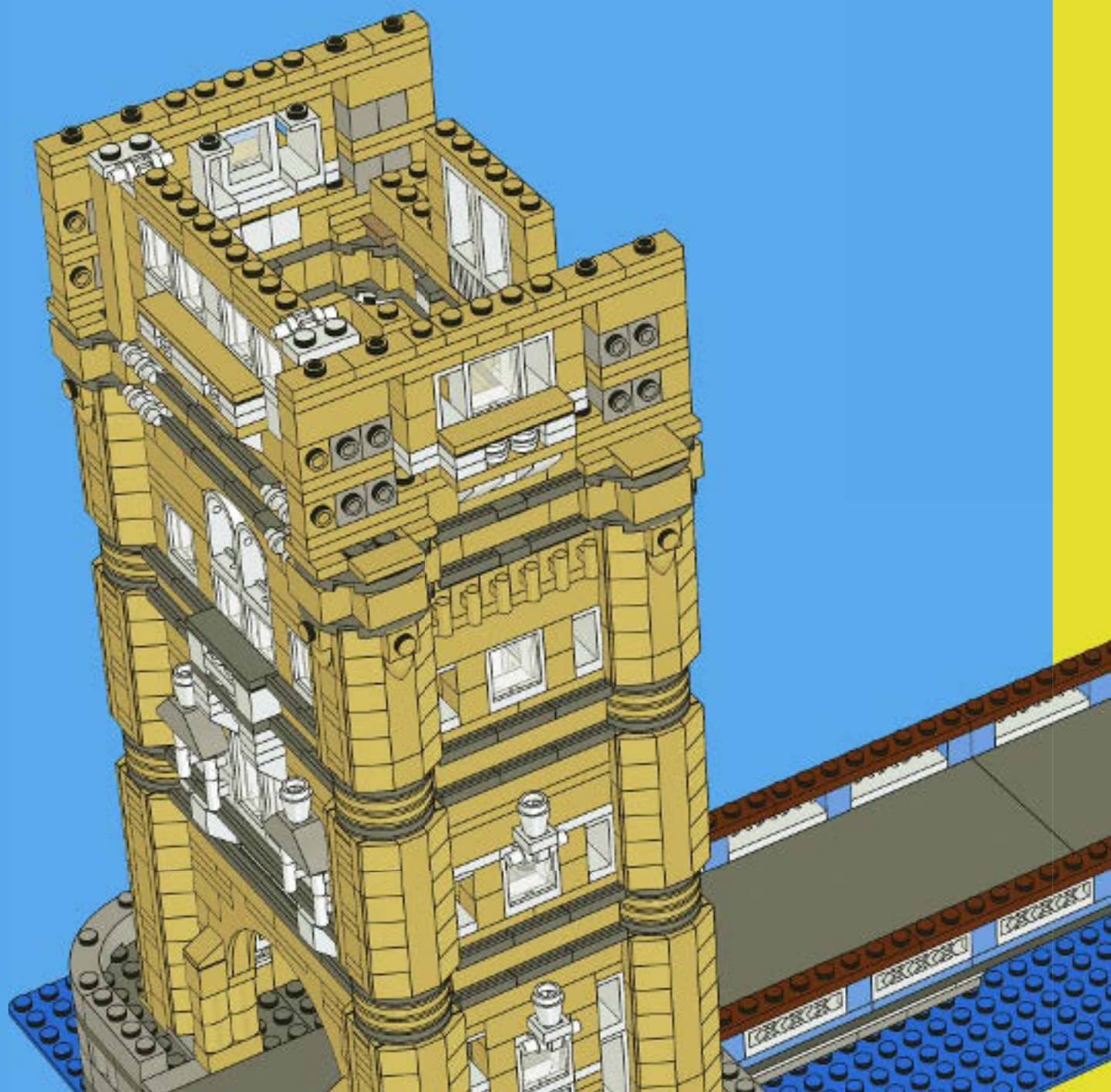





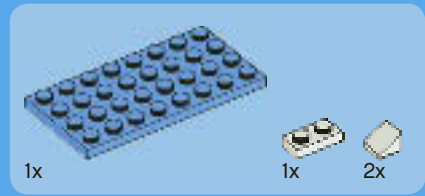
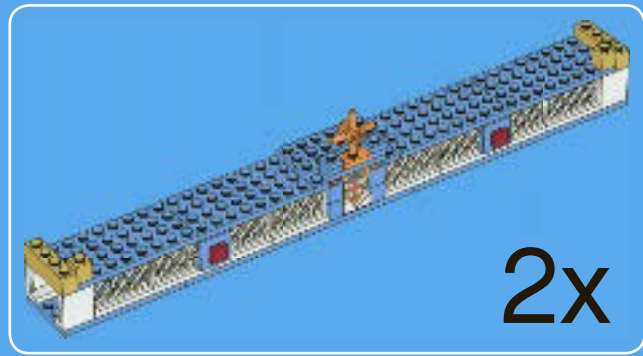

1

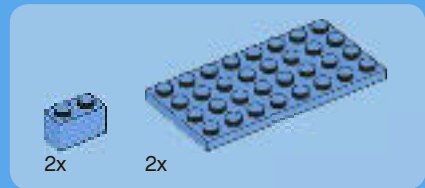

2

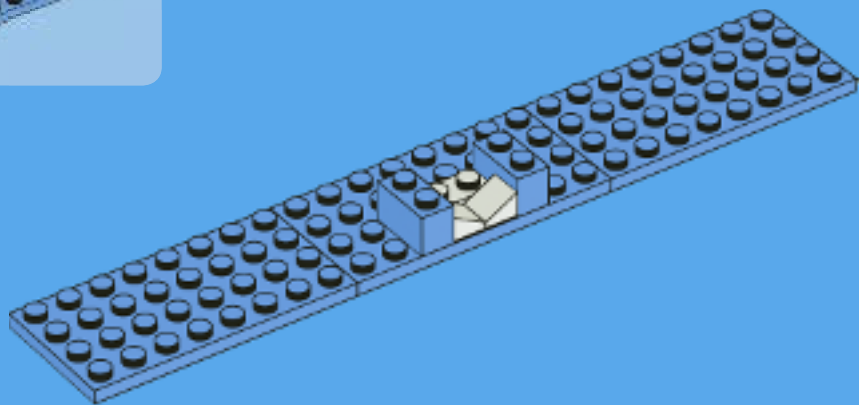



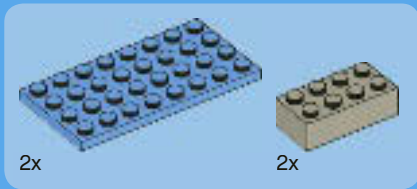

3

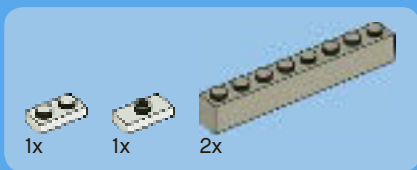
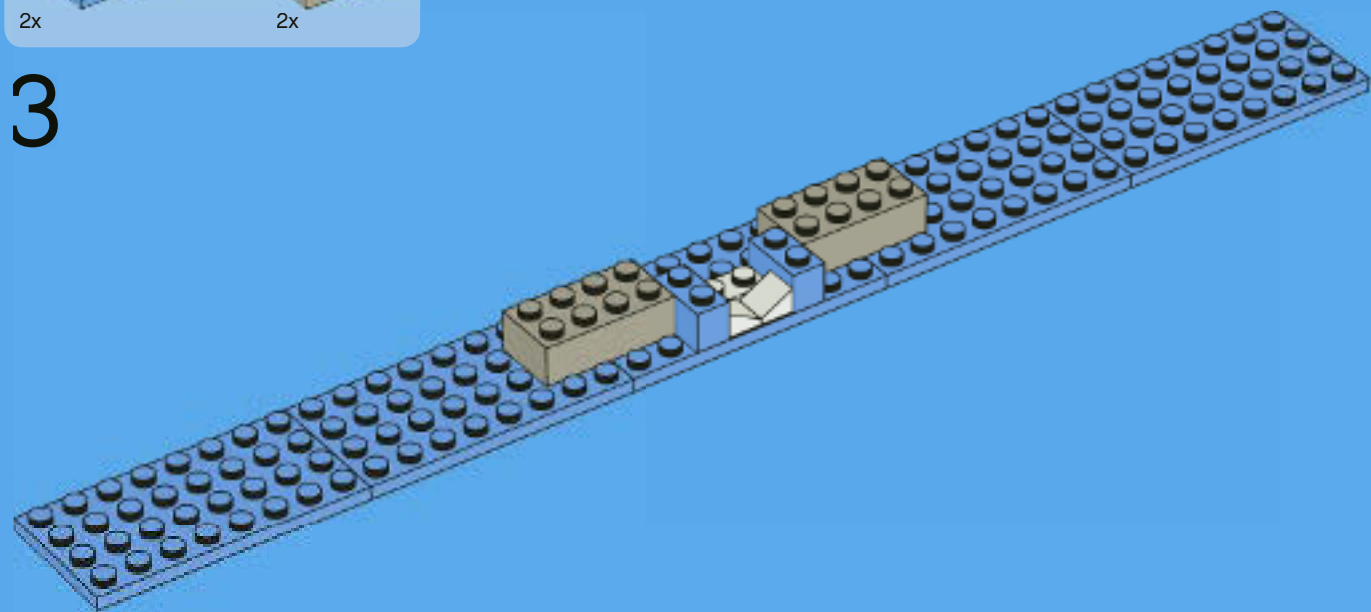

4

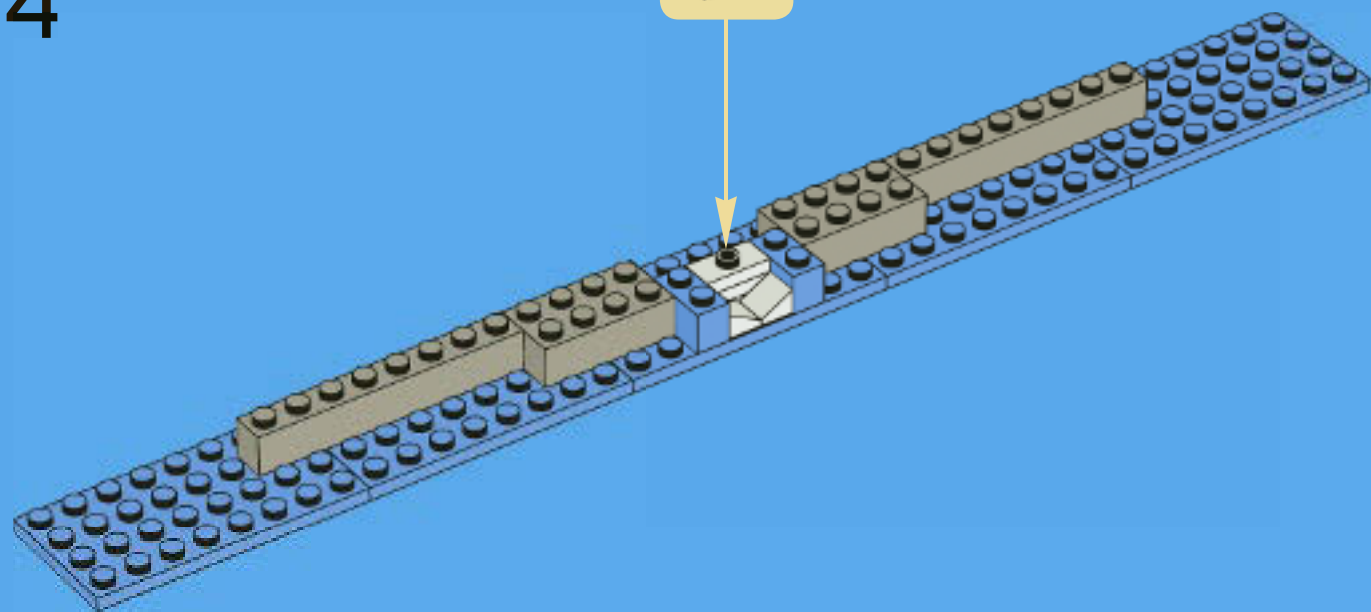
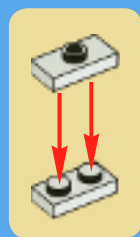

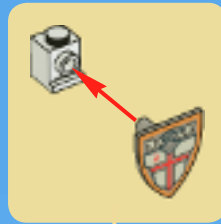
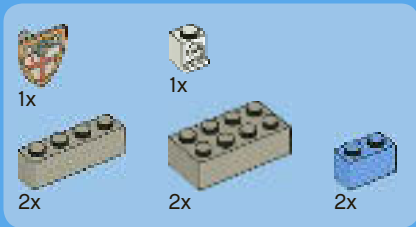

5

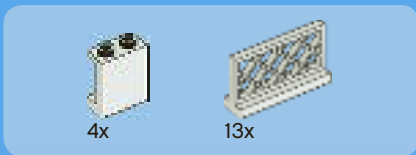
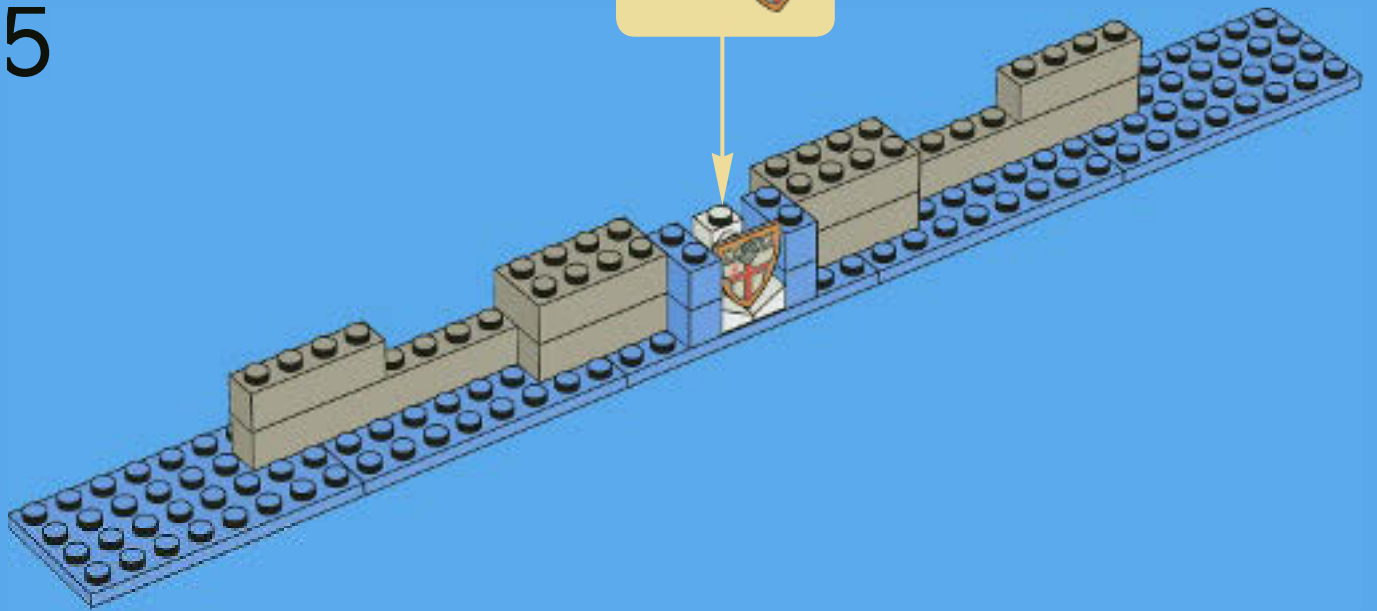

6

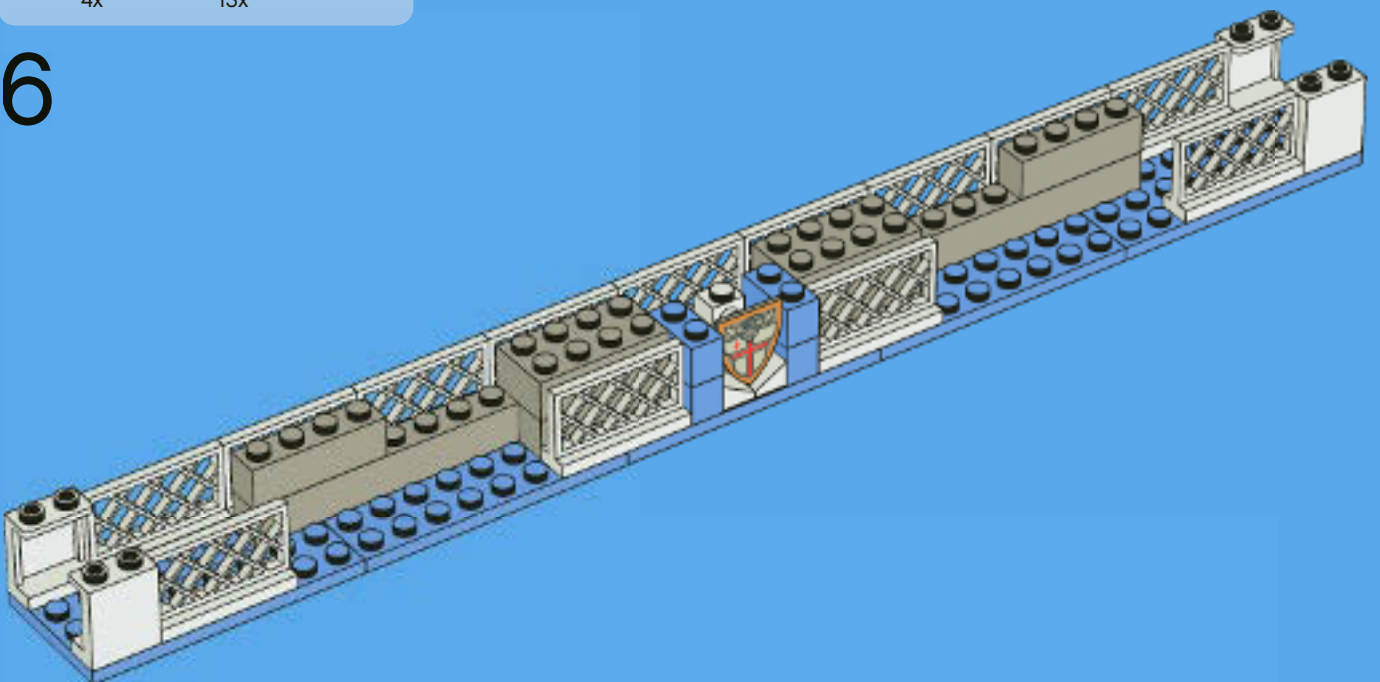



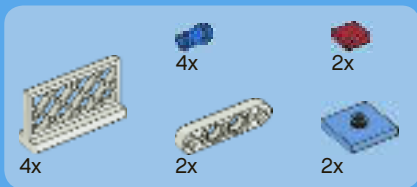

7

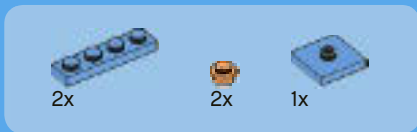
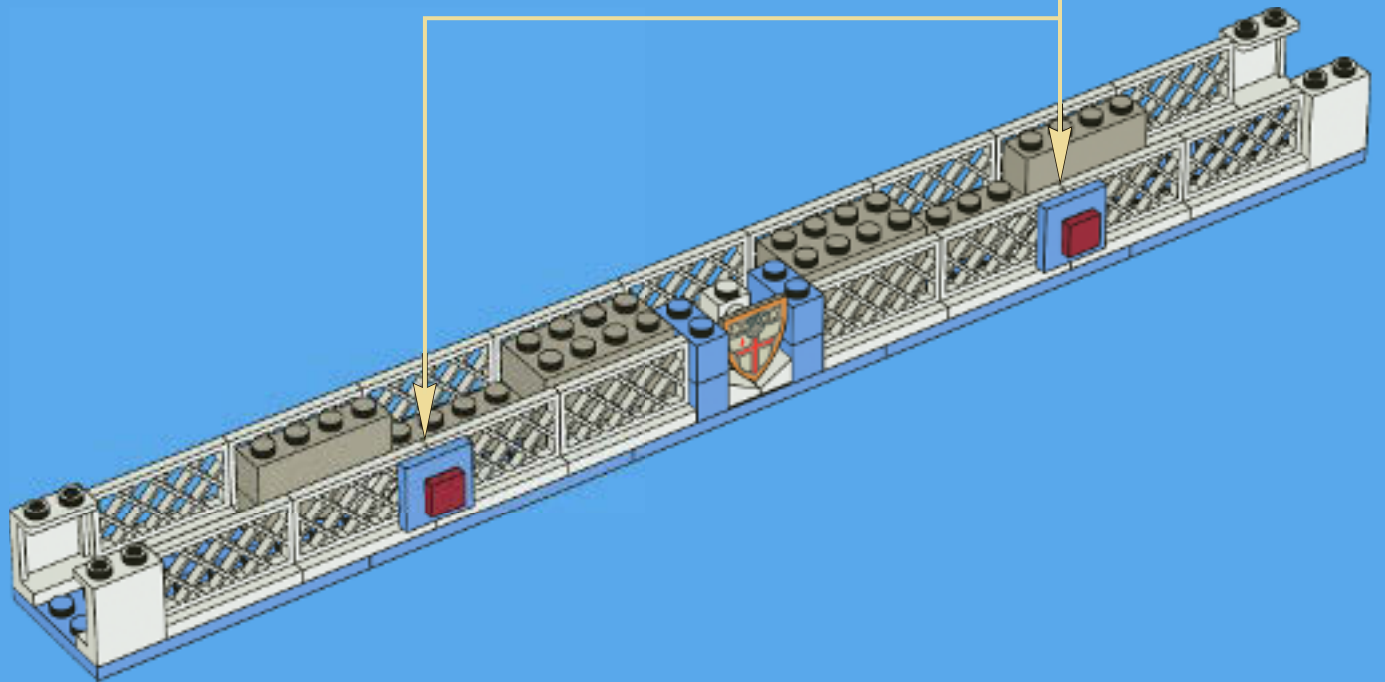
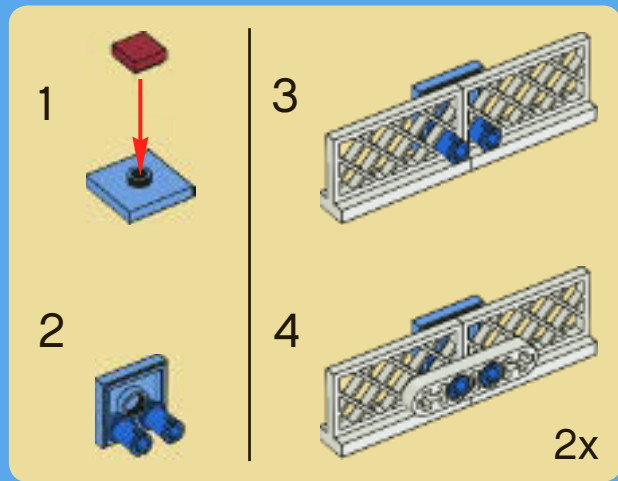

8

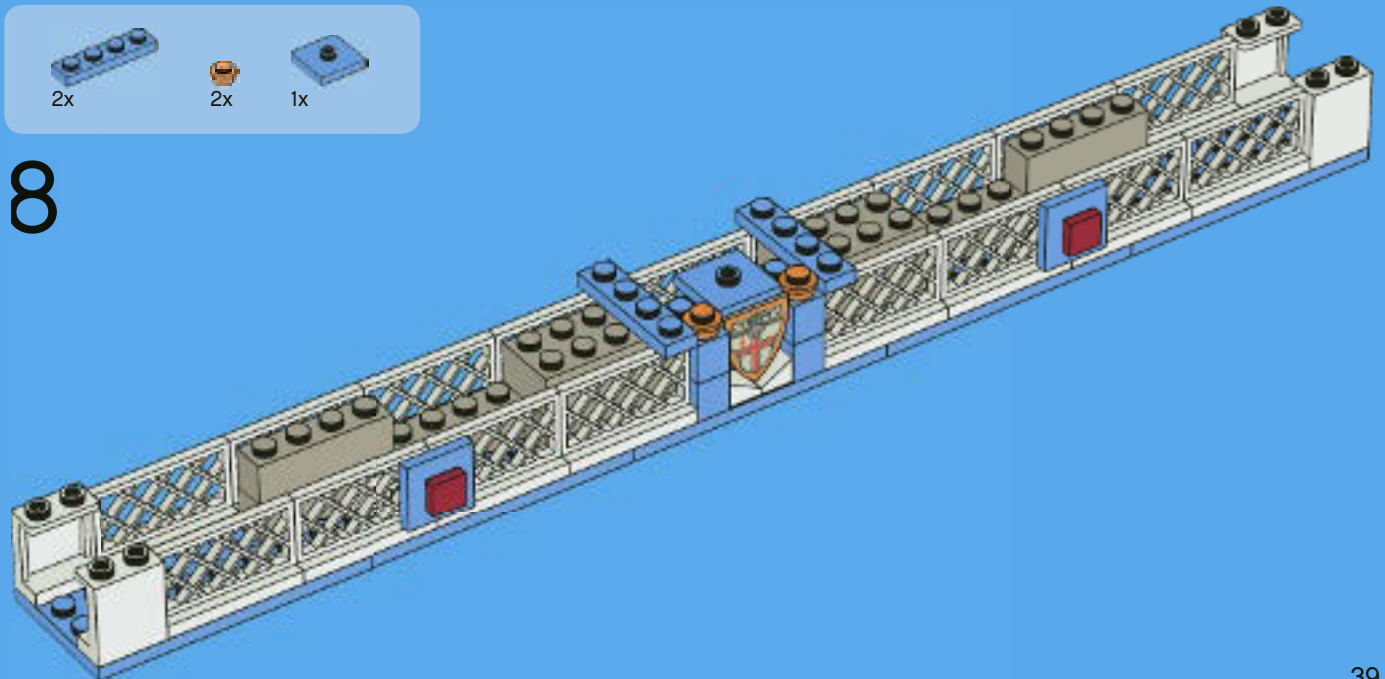

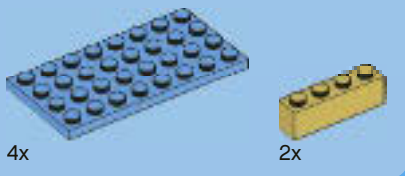

9

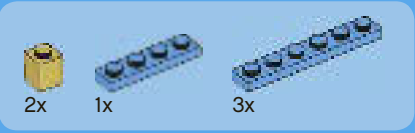
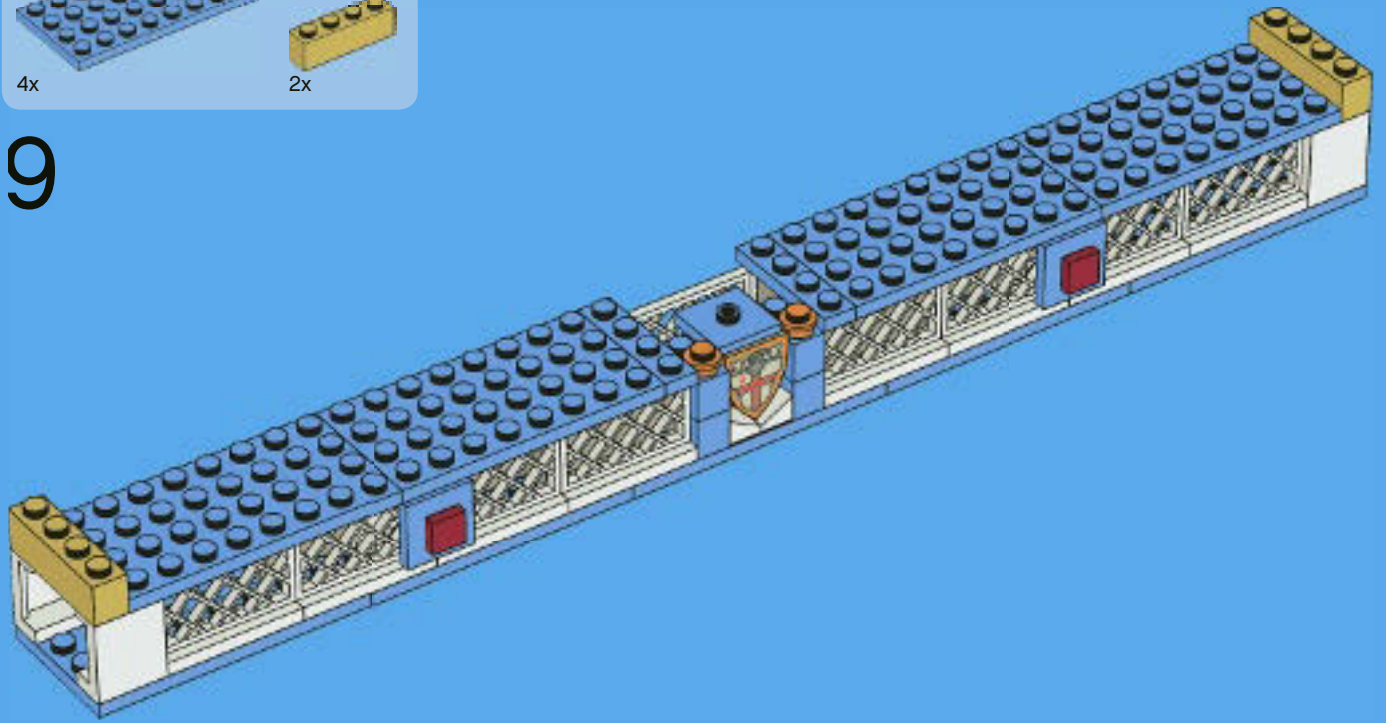

10

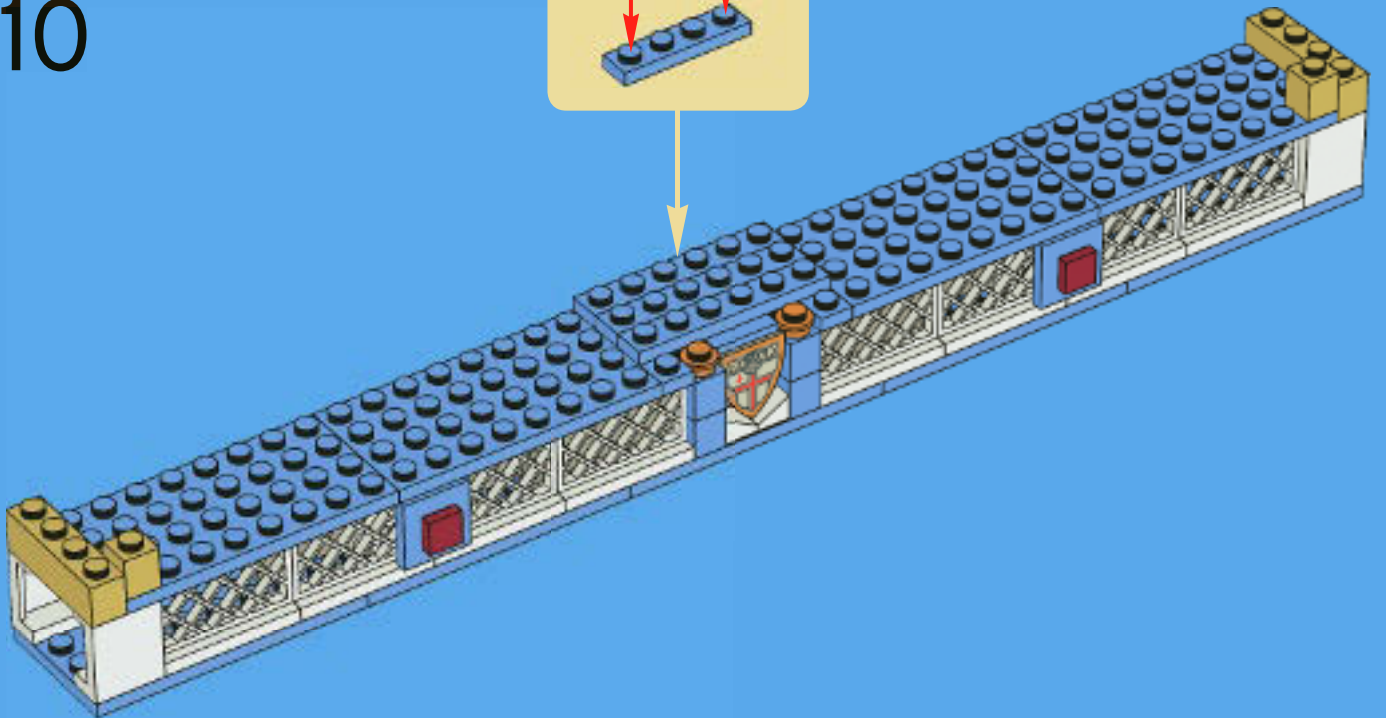
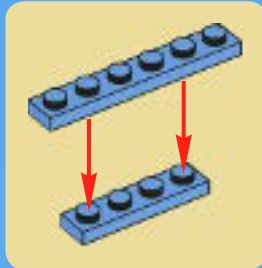





# 11

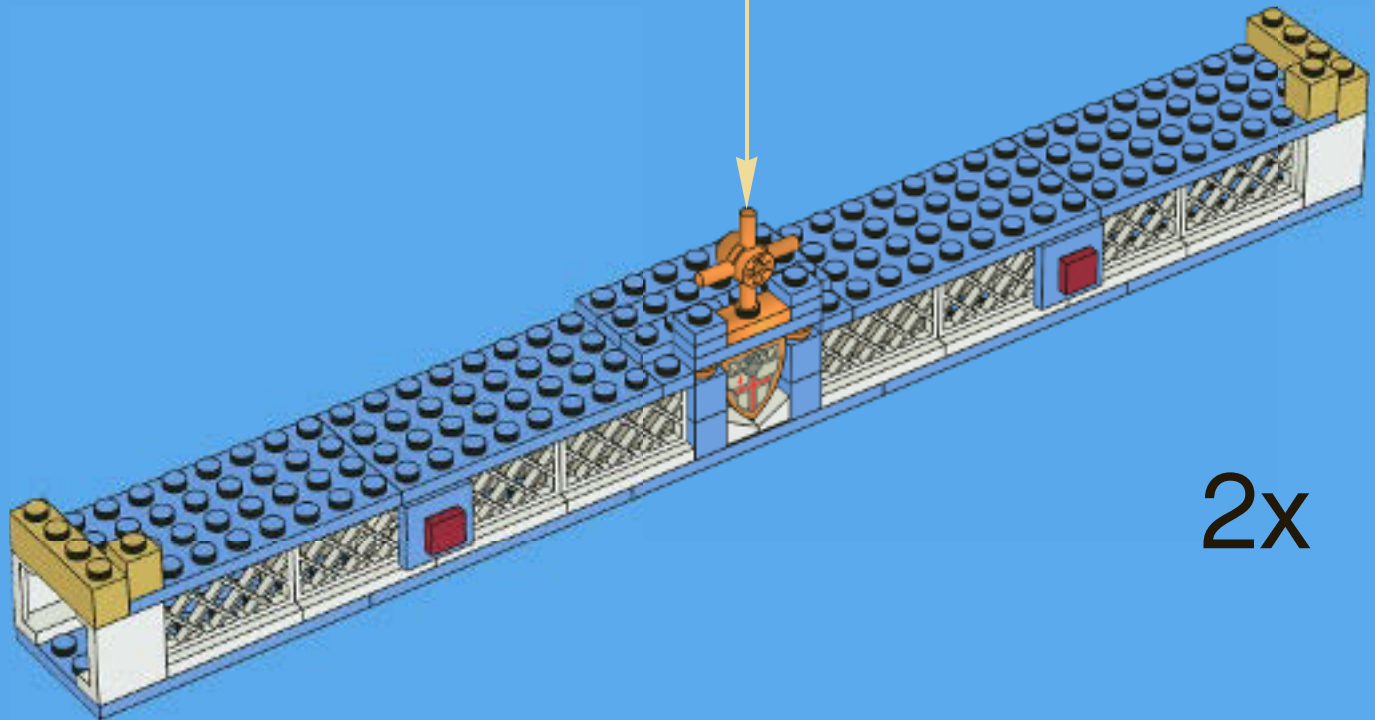
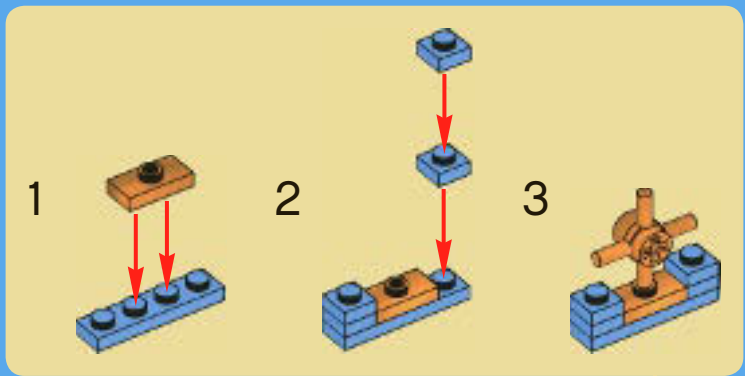

2x

12

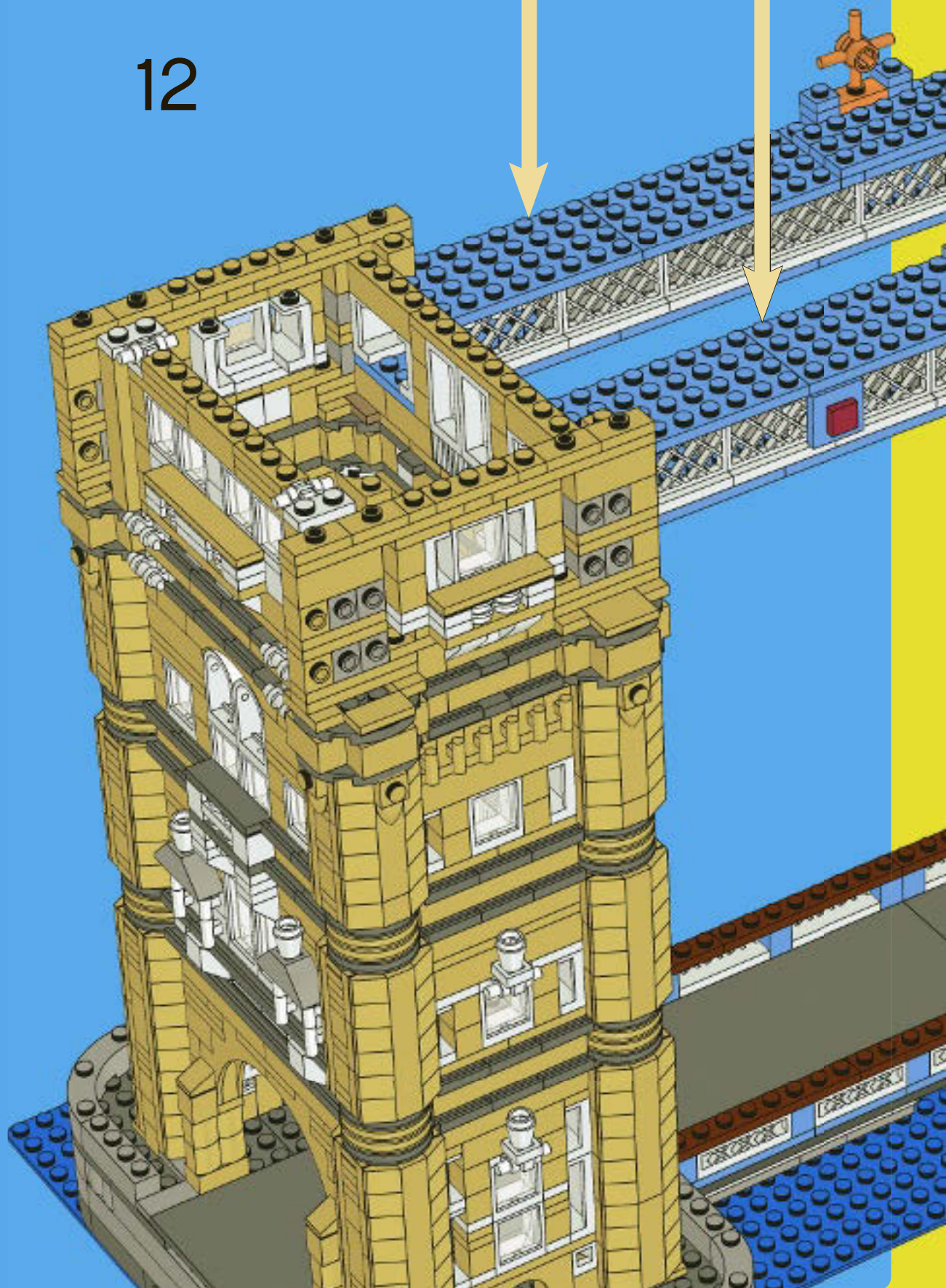



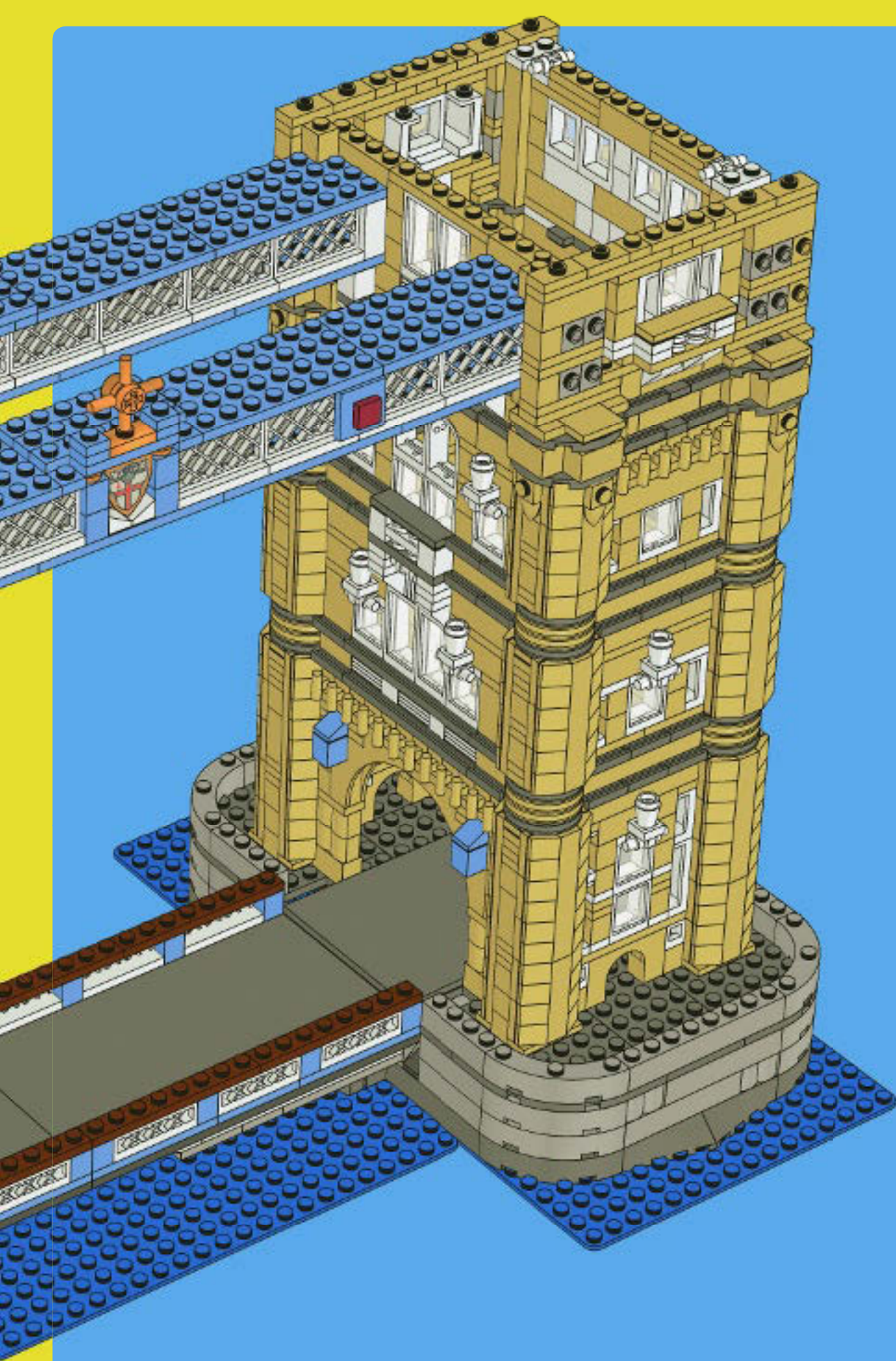





2x



4x

# 13

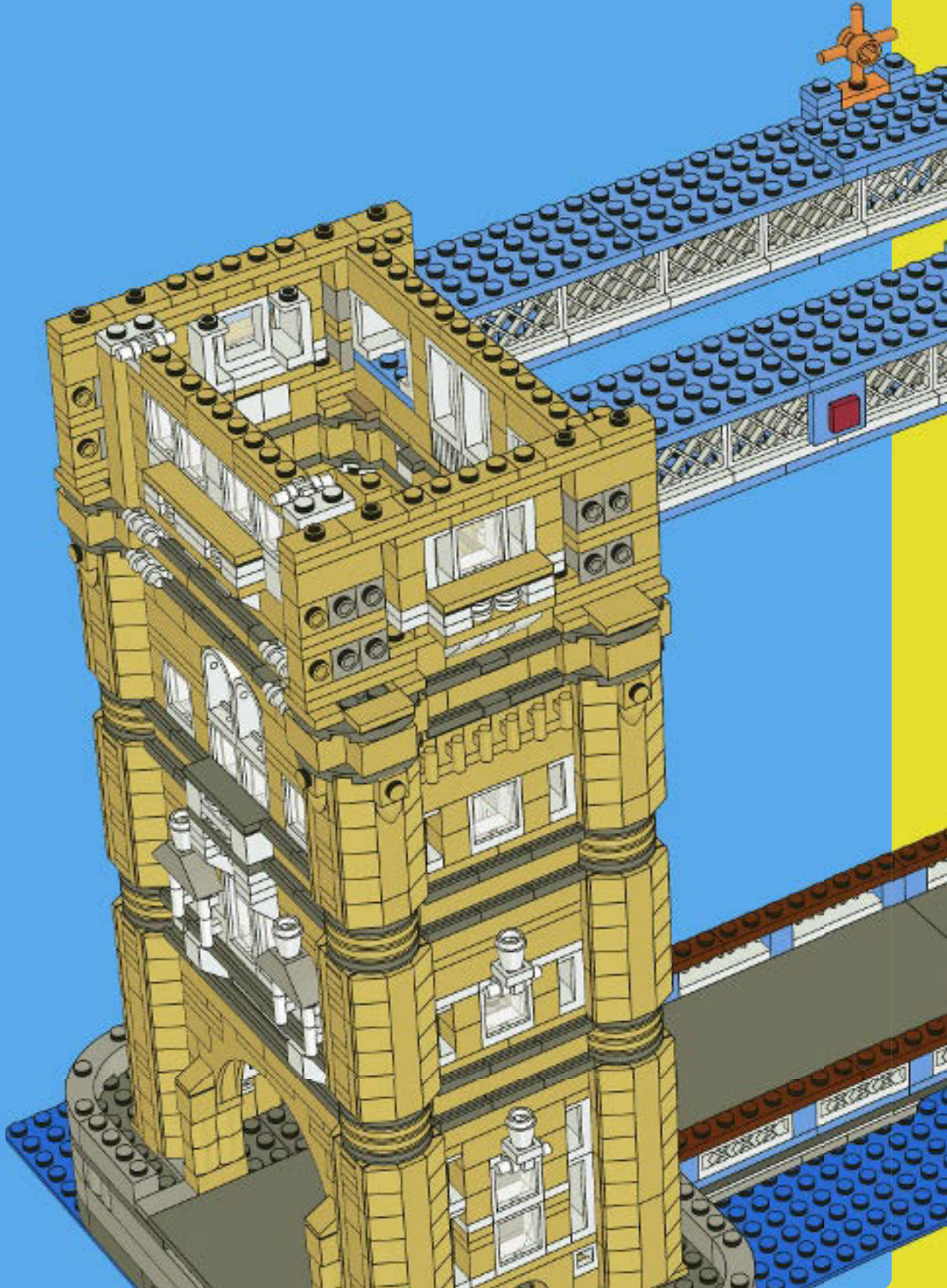









4x



12x

# 14

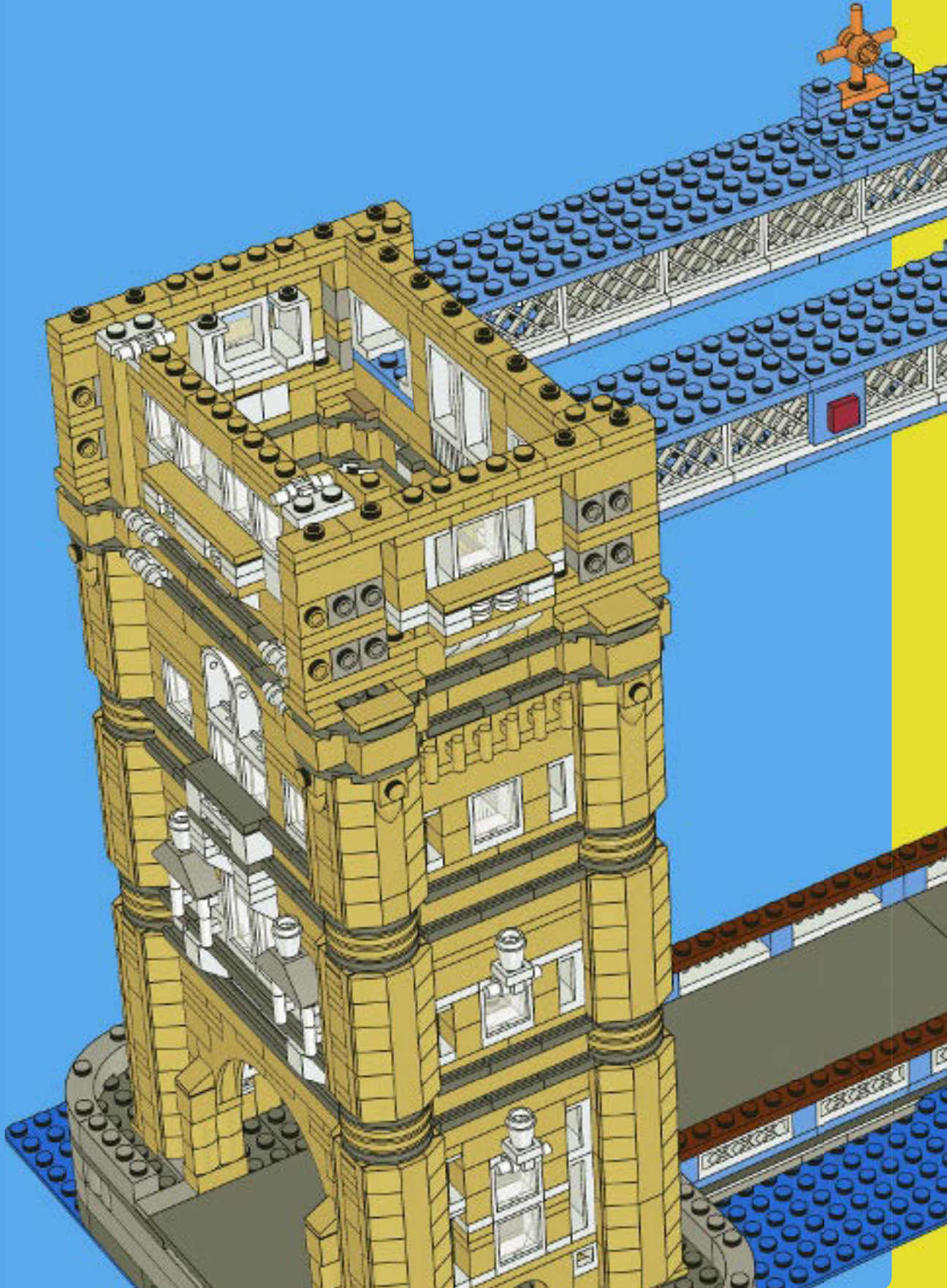







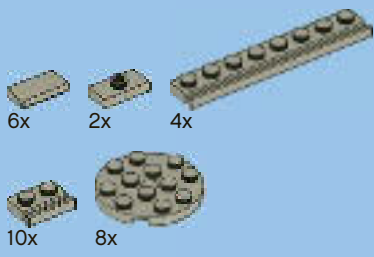

15

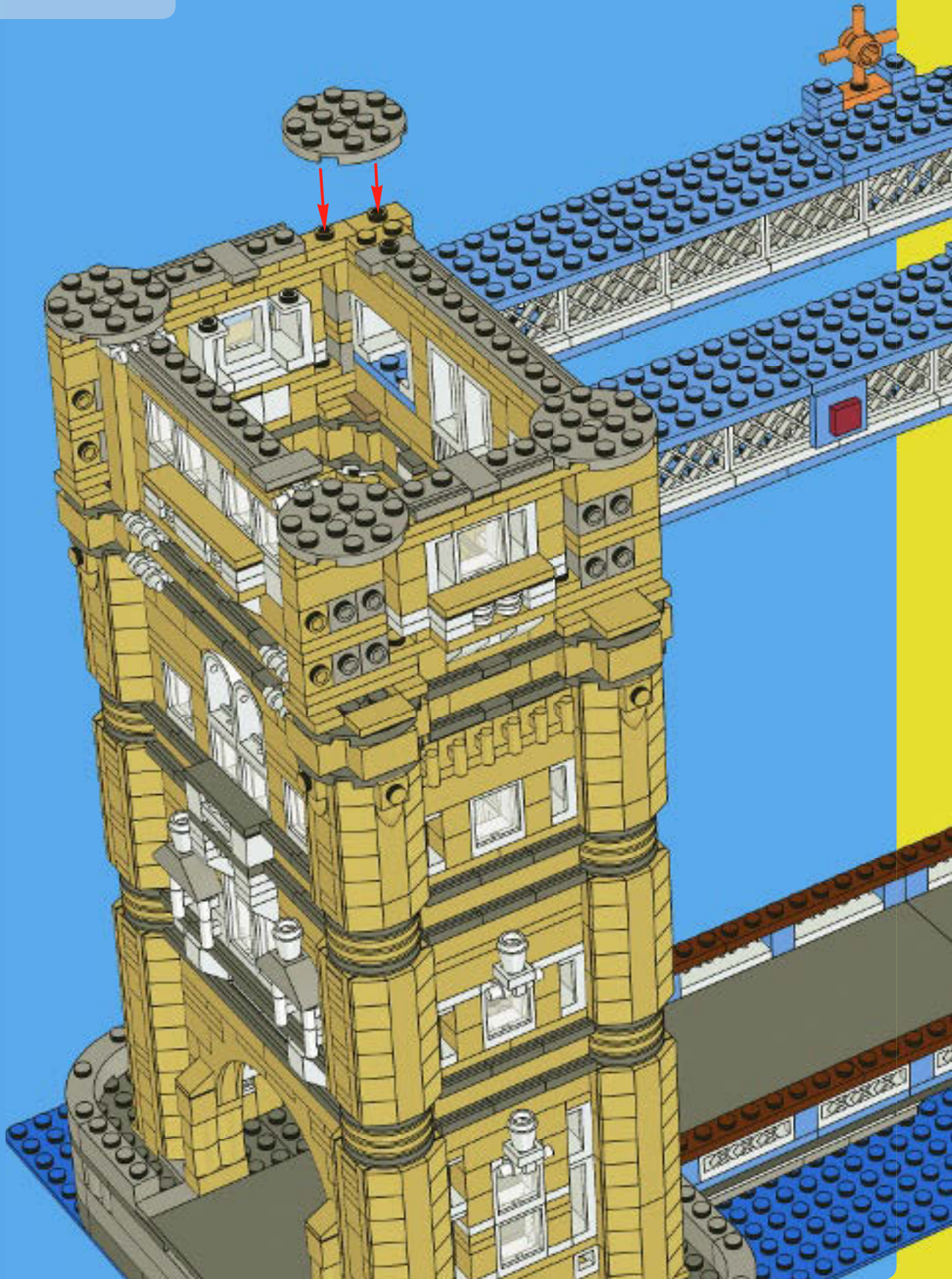



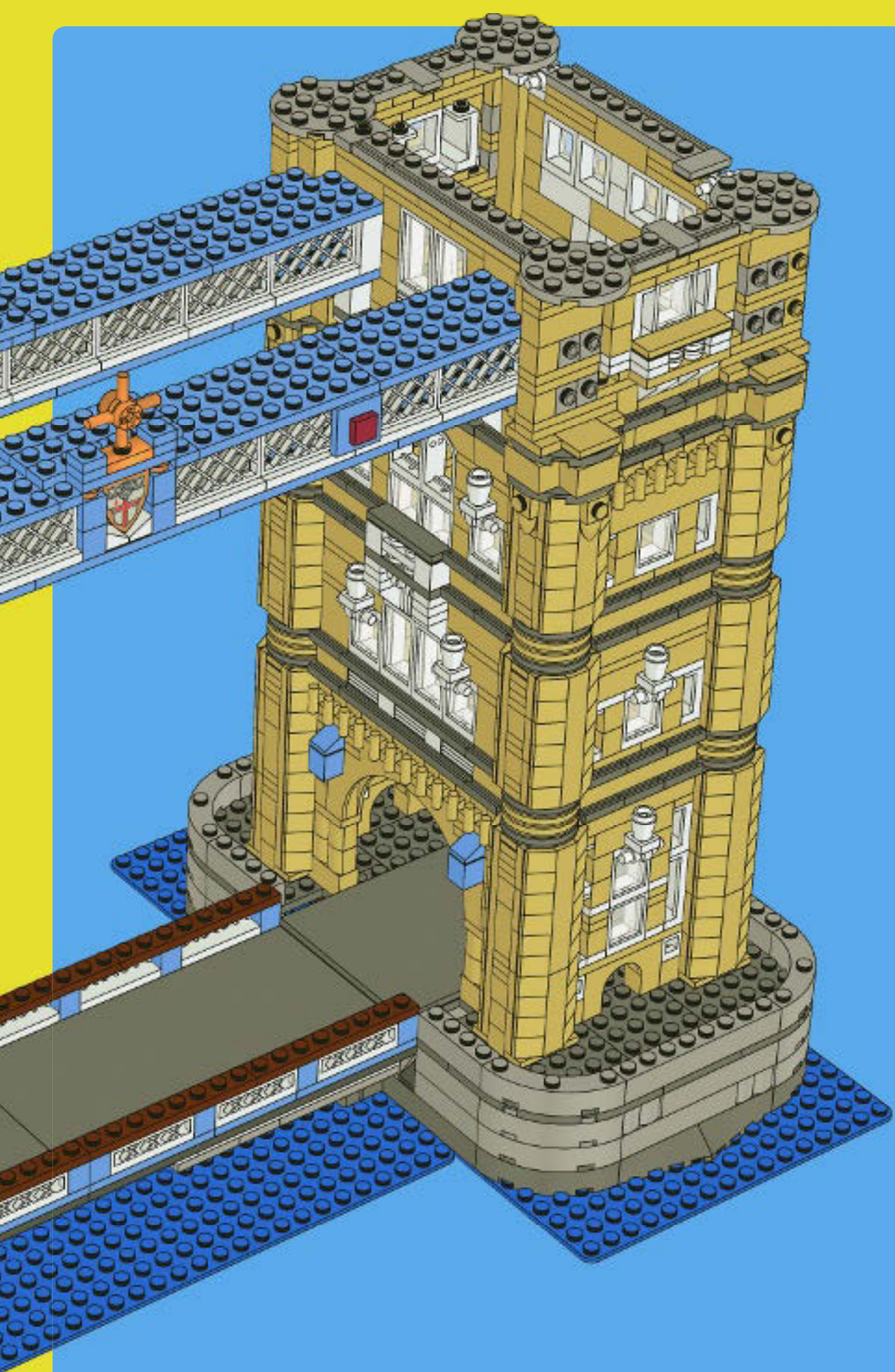





4x



24x

# 16

1

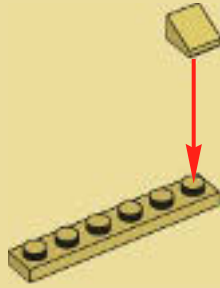

2

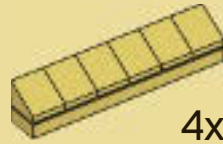

4x

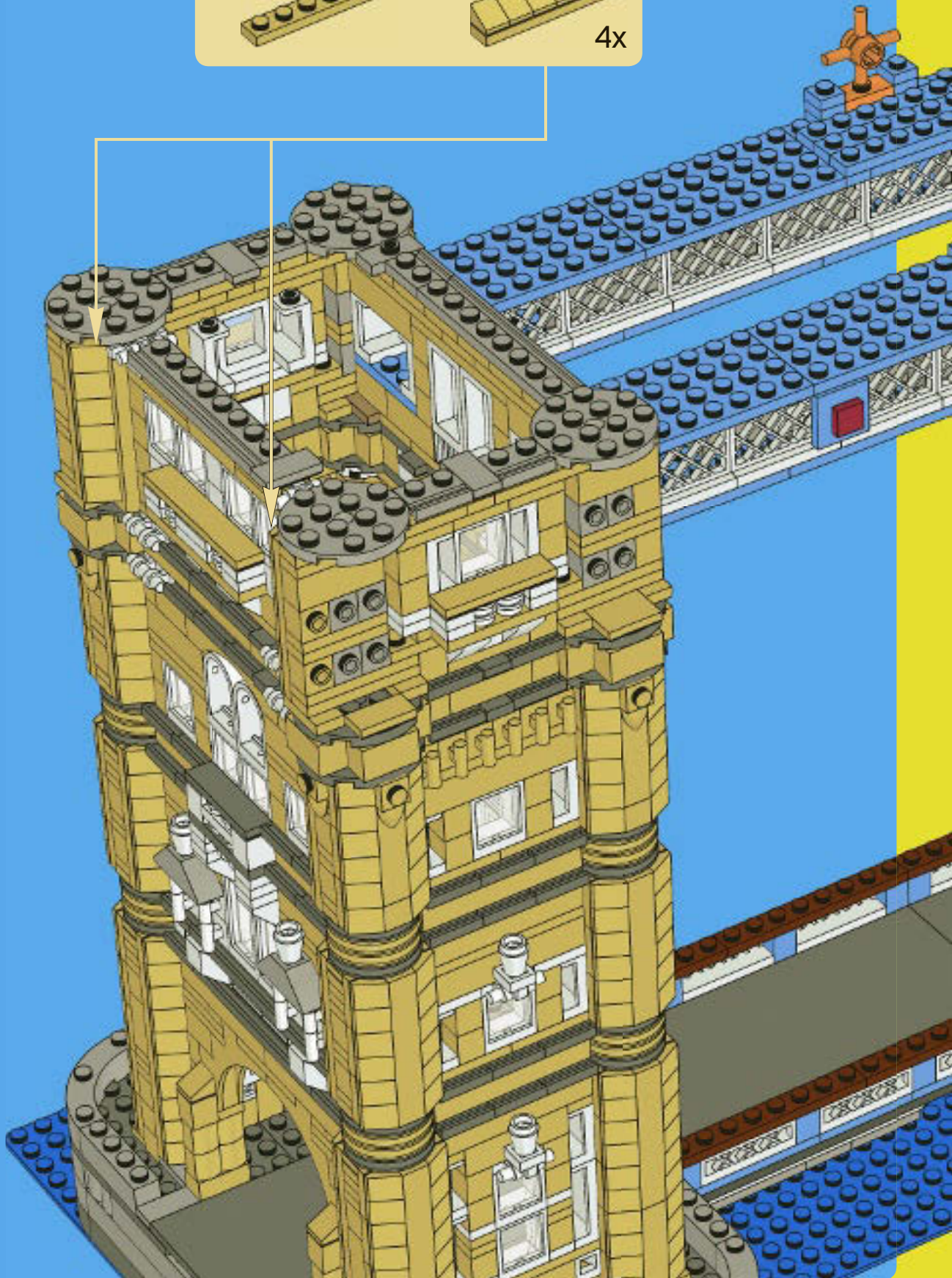









48x



16x

# 17

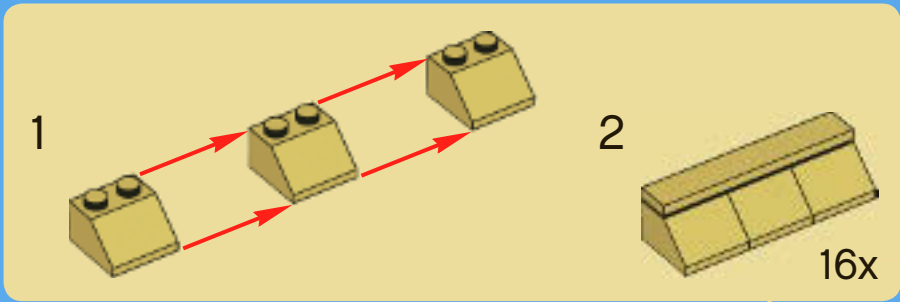



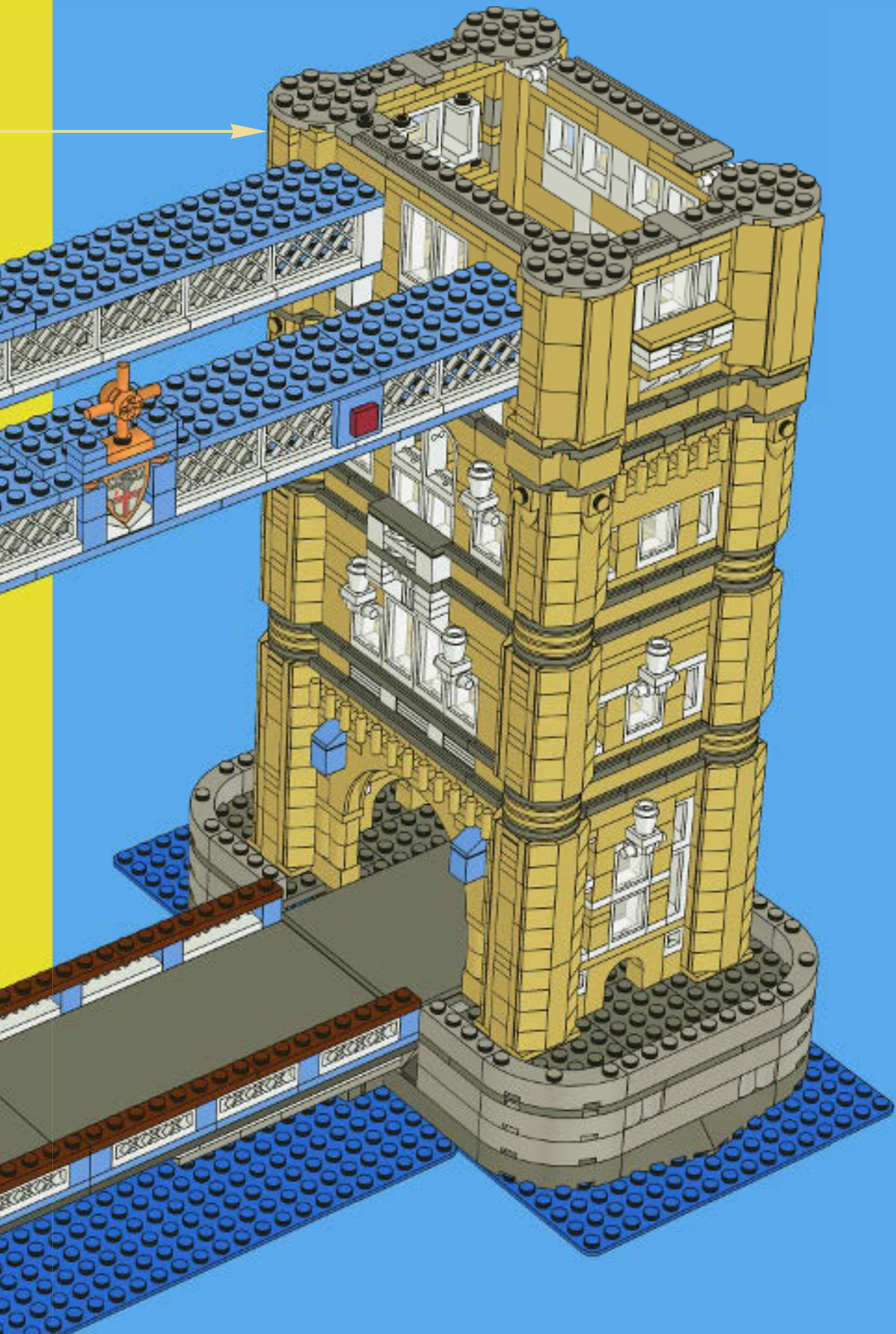



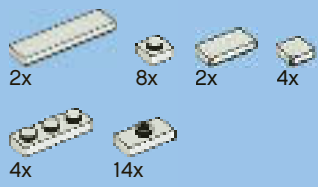

18











4x



2 lx



8x

# 19

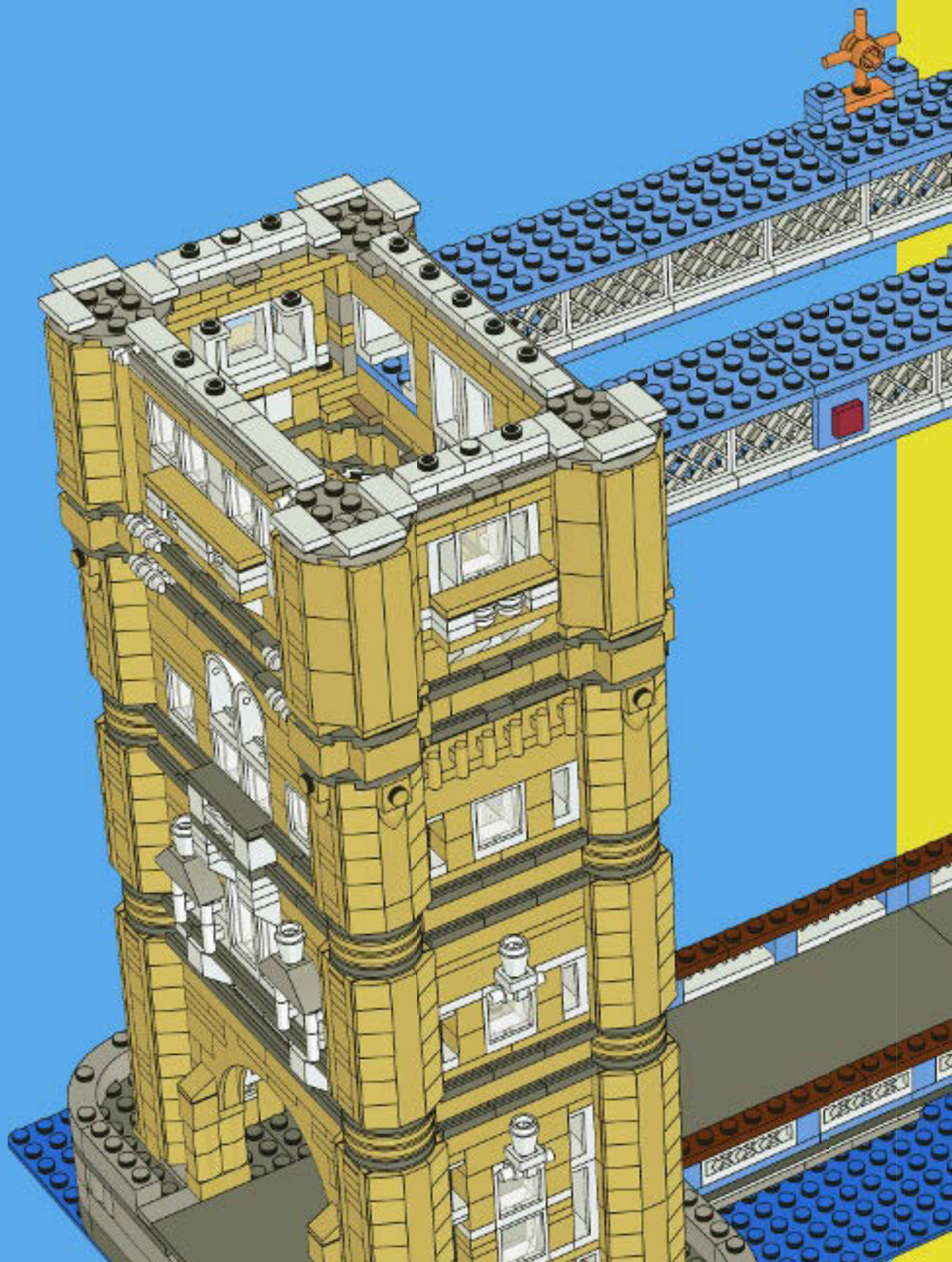



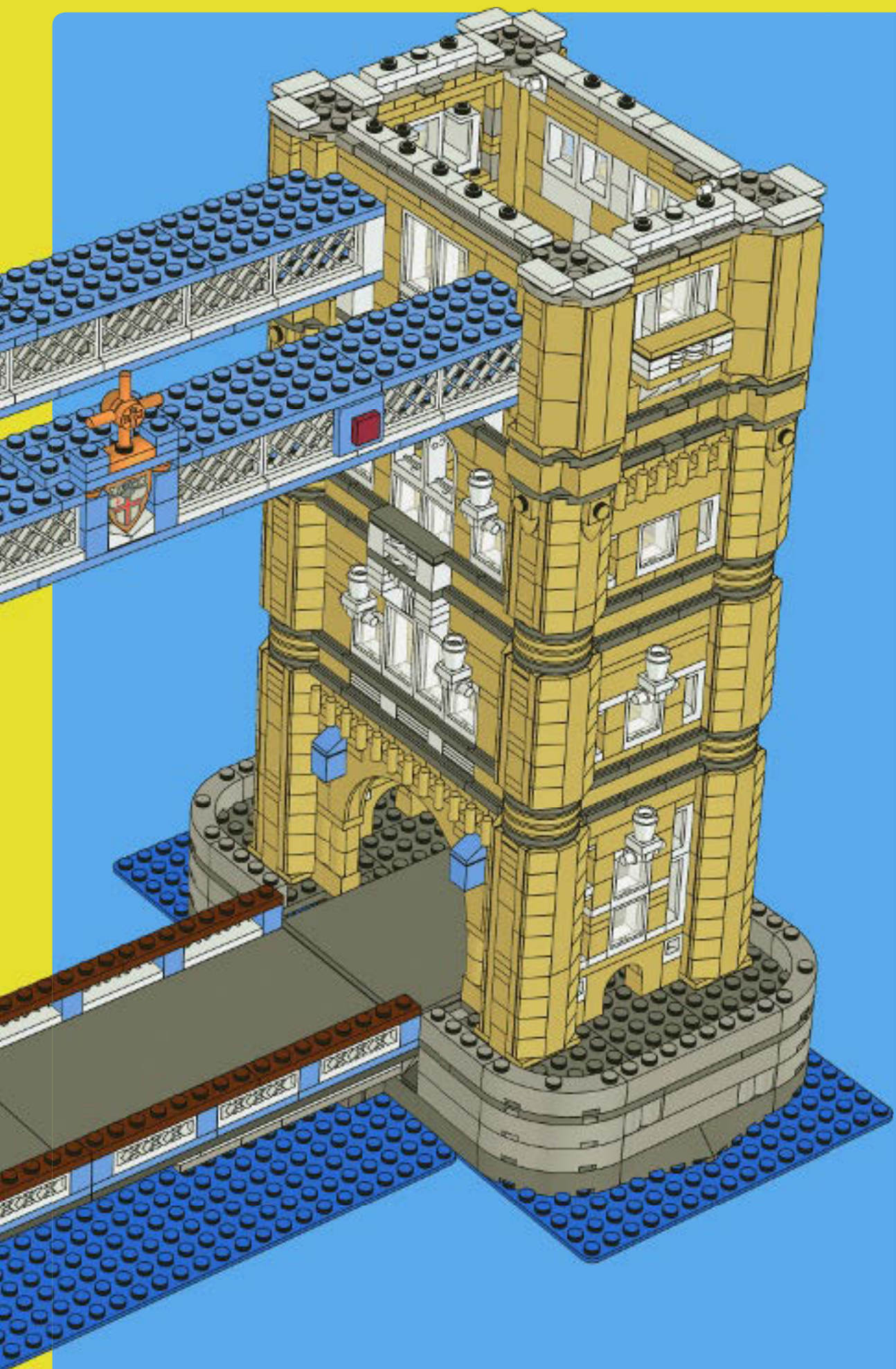





12x

20

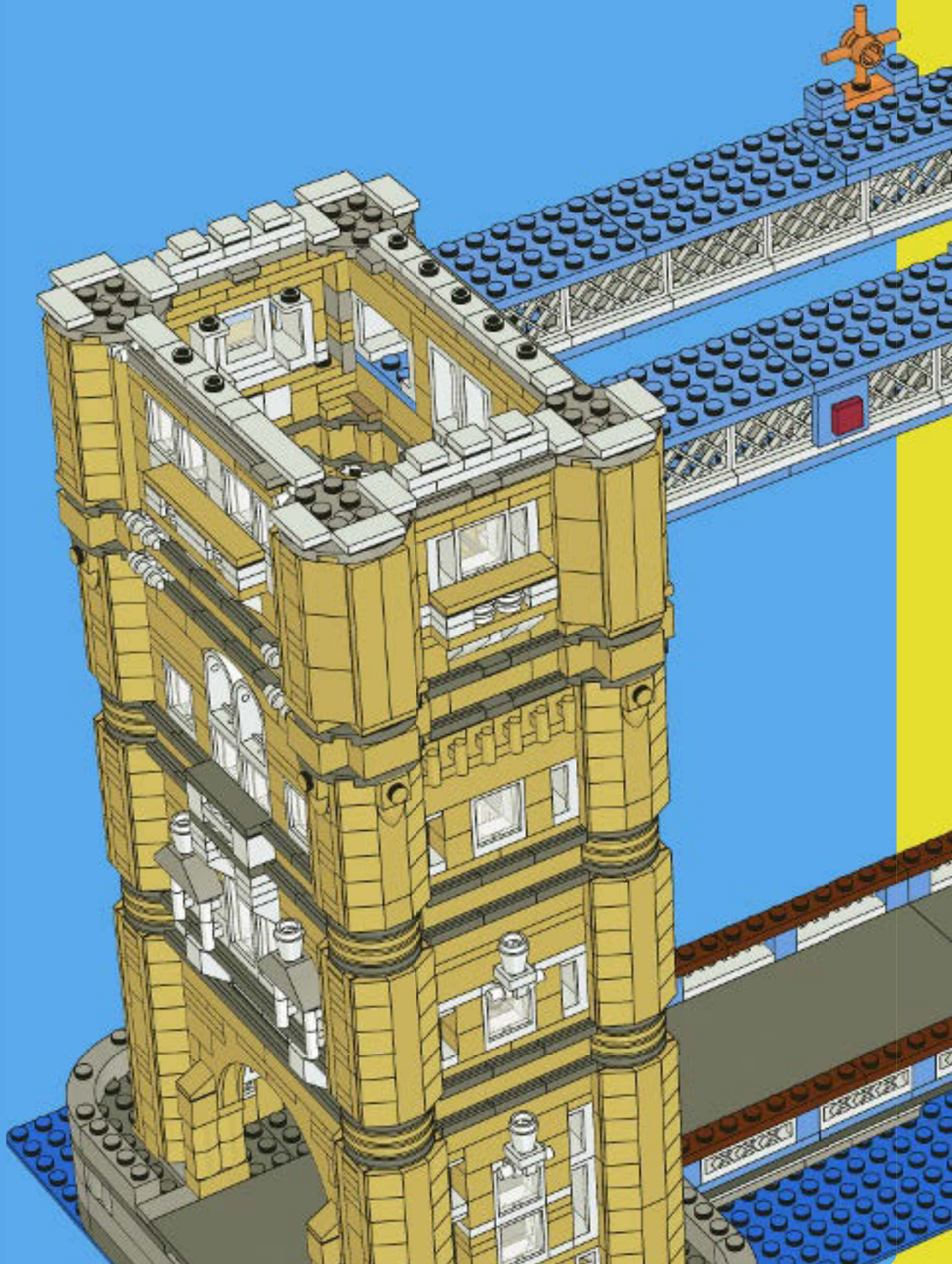



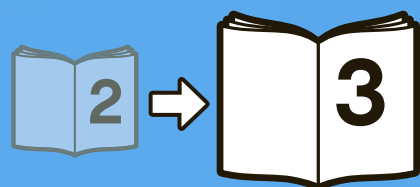
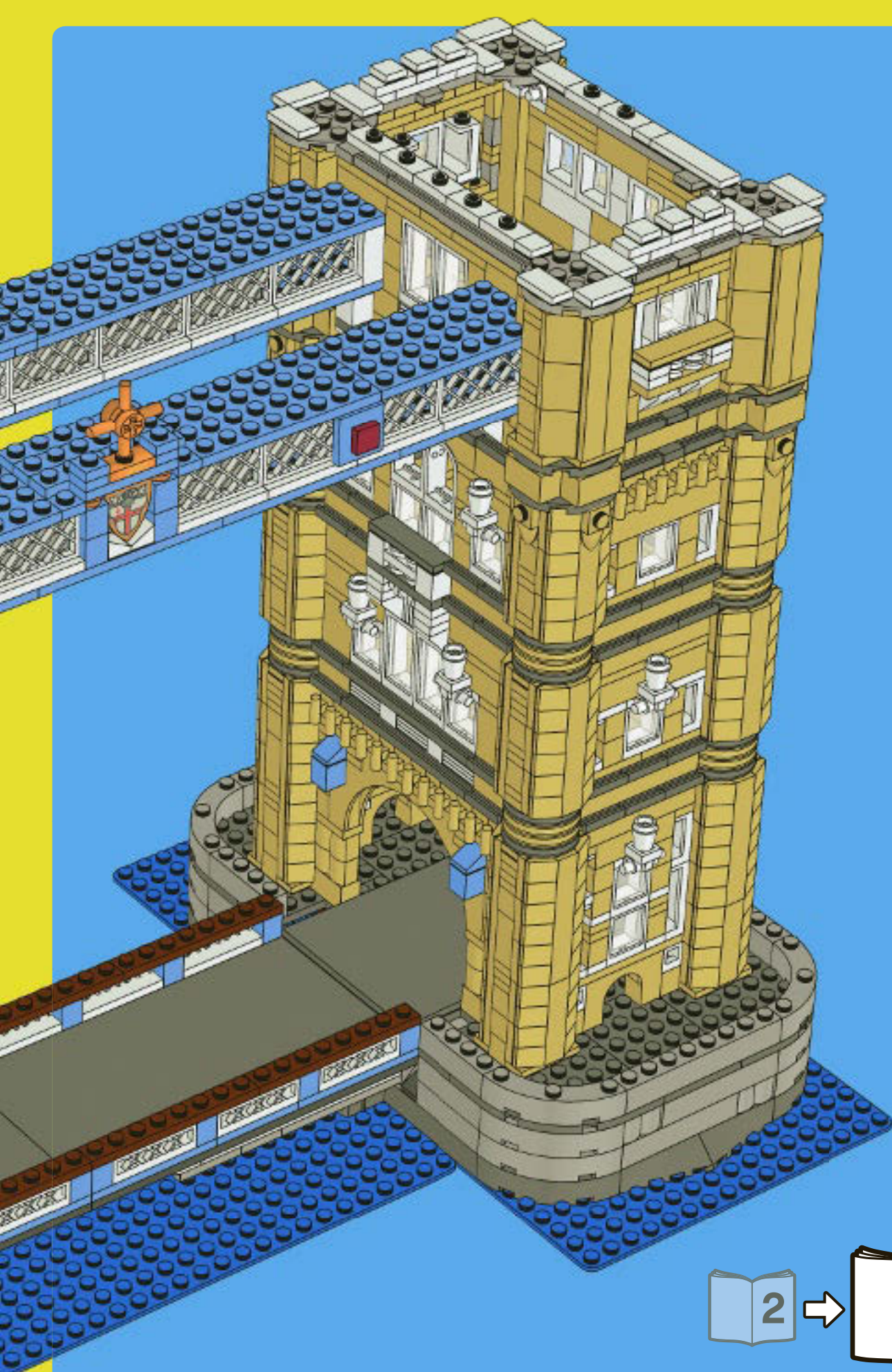





10189