

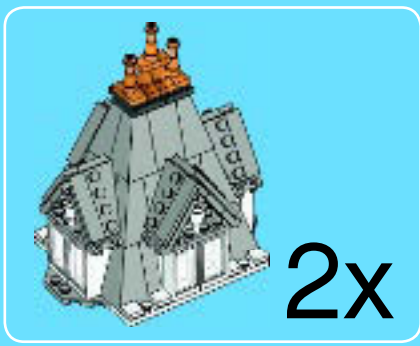

10214





1

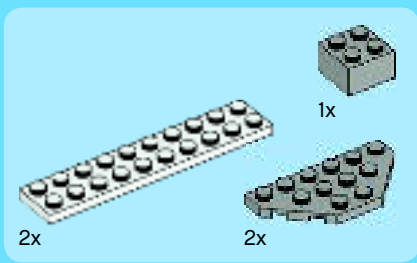
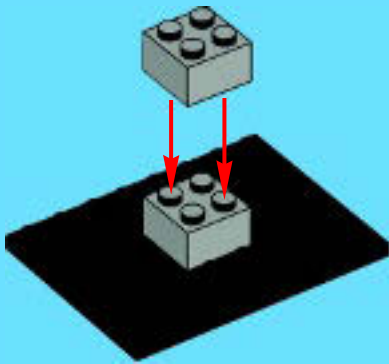

2

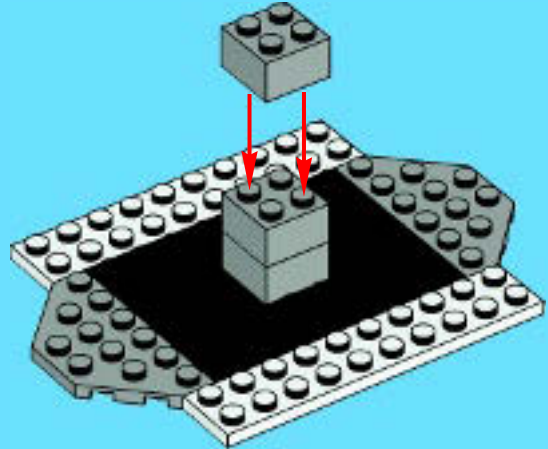

3

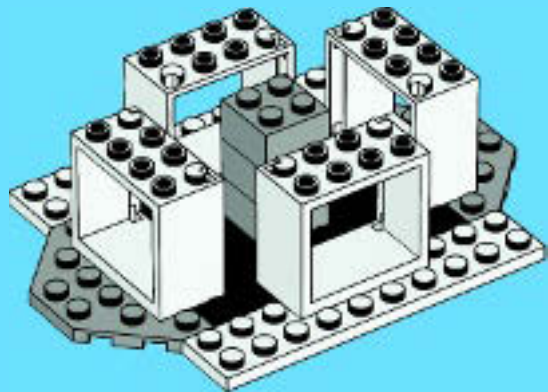



4x



4x

4

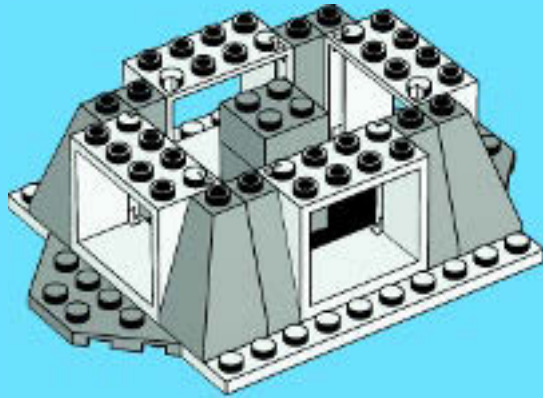

4x



1x

5

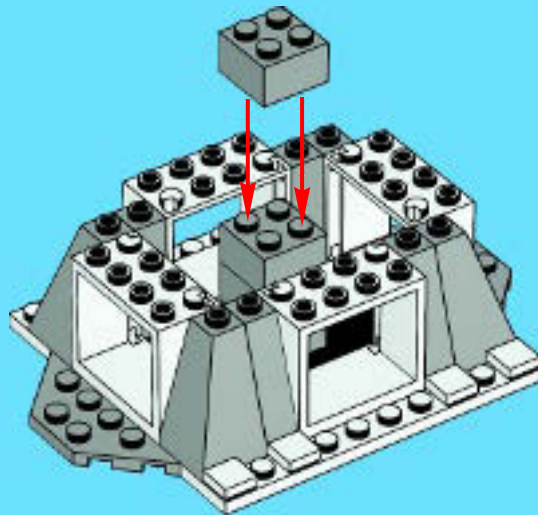



4x



1x

6

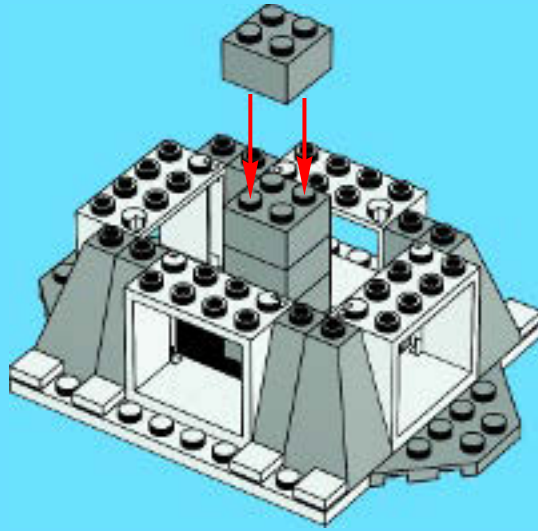

1x



8x



8x

7

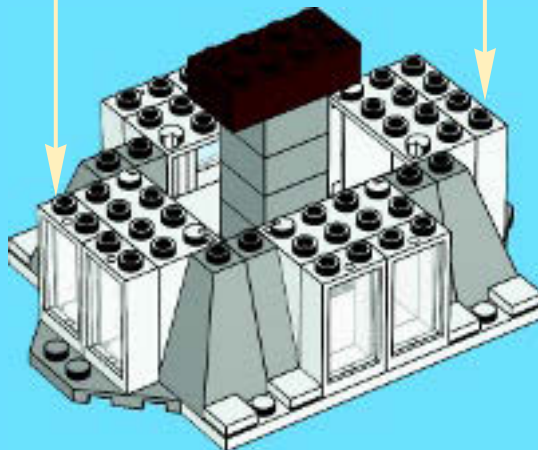
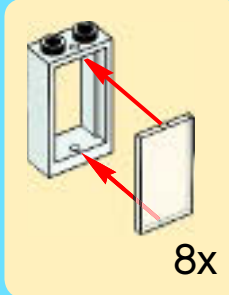



4x



6x

8

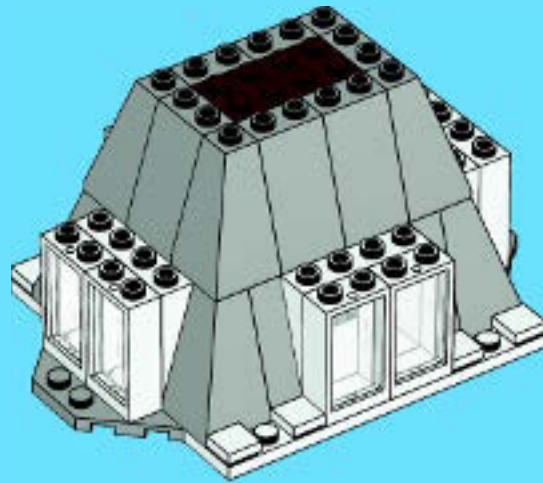

4x



4x



4x



4x

9

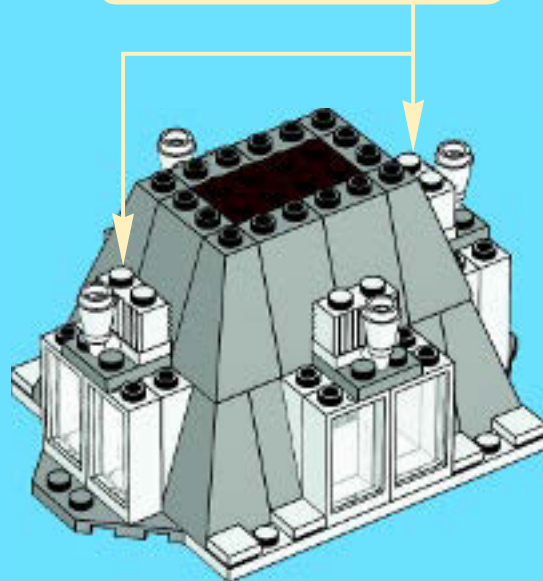
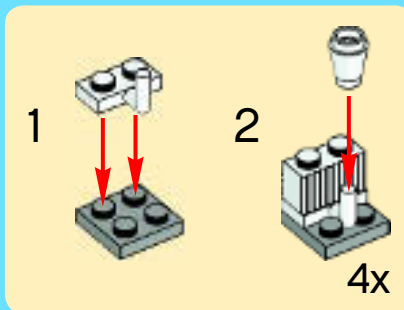

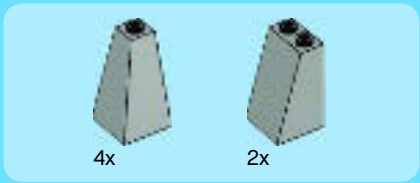

10

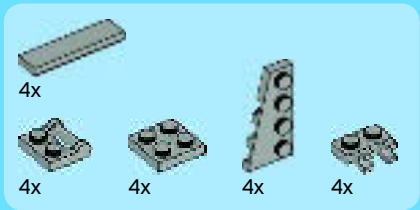
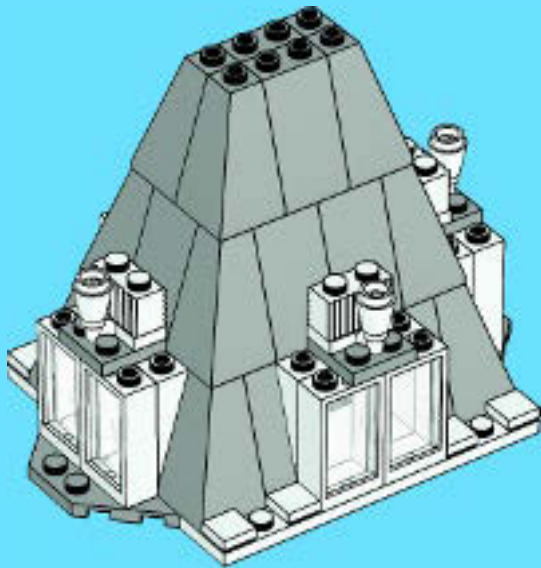

11

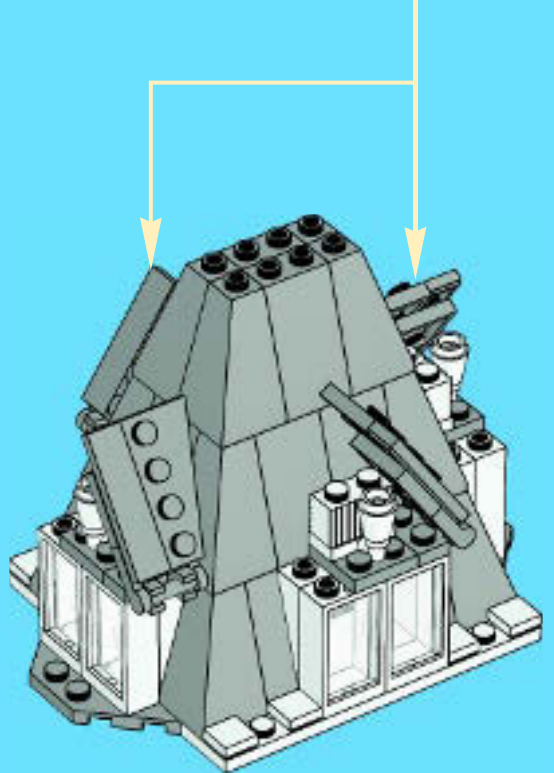
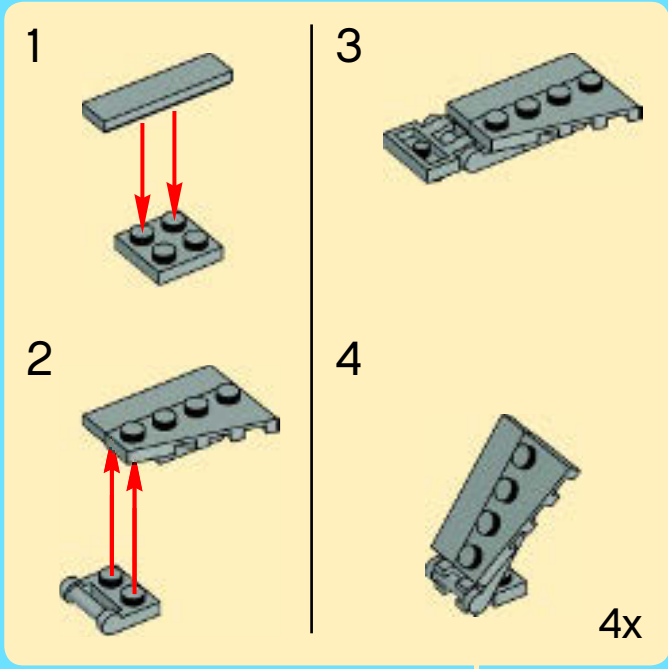

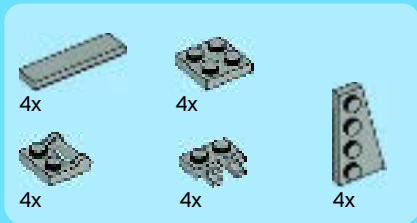

12

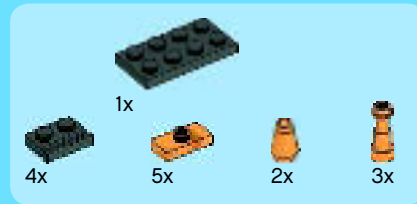
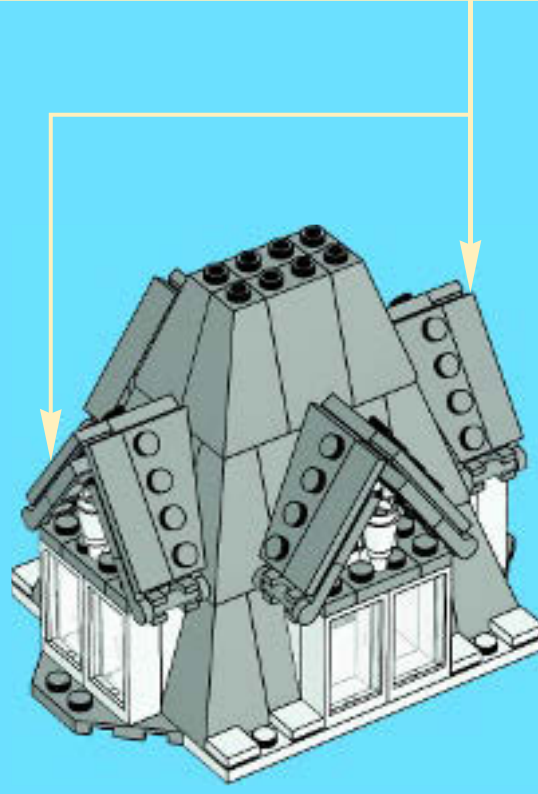
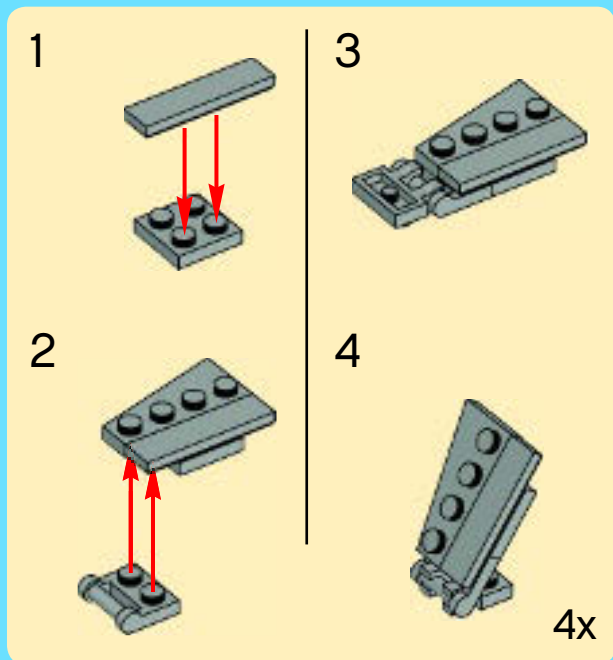

13

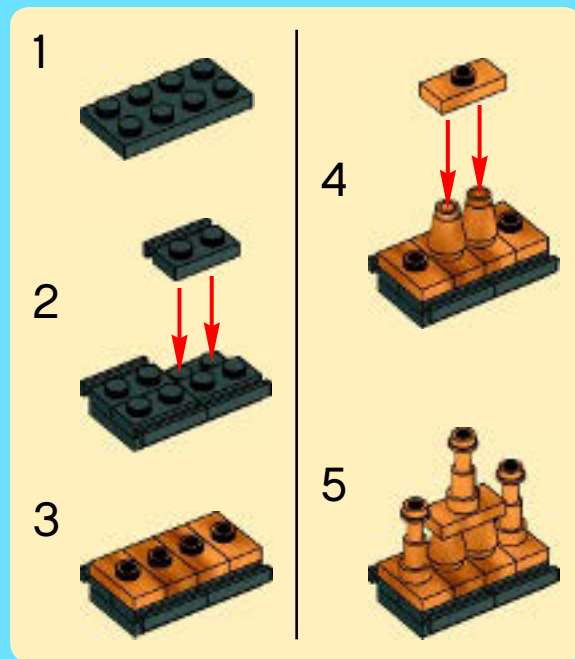

2x
7

14

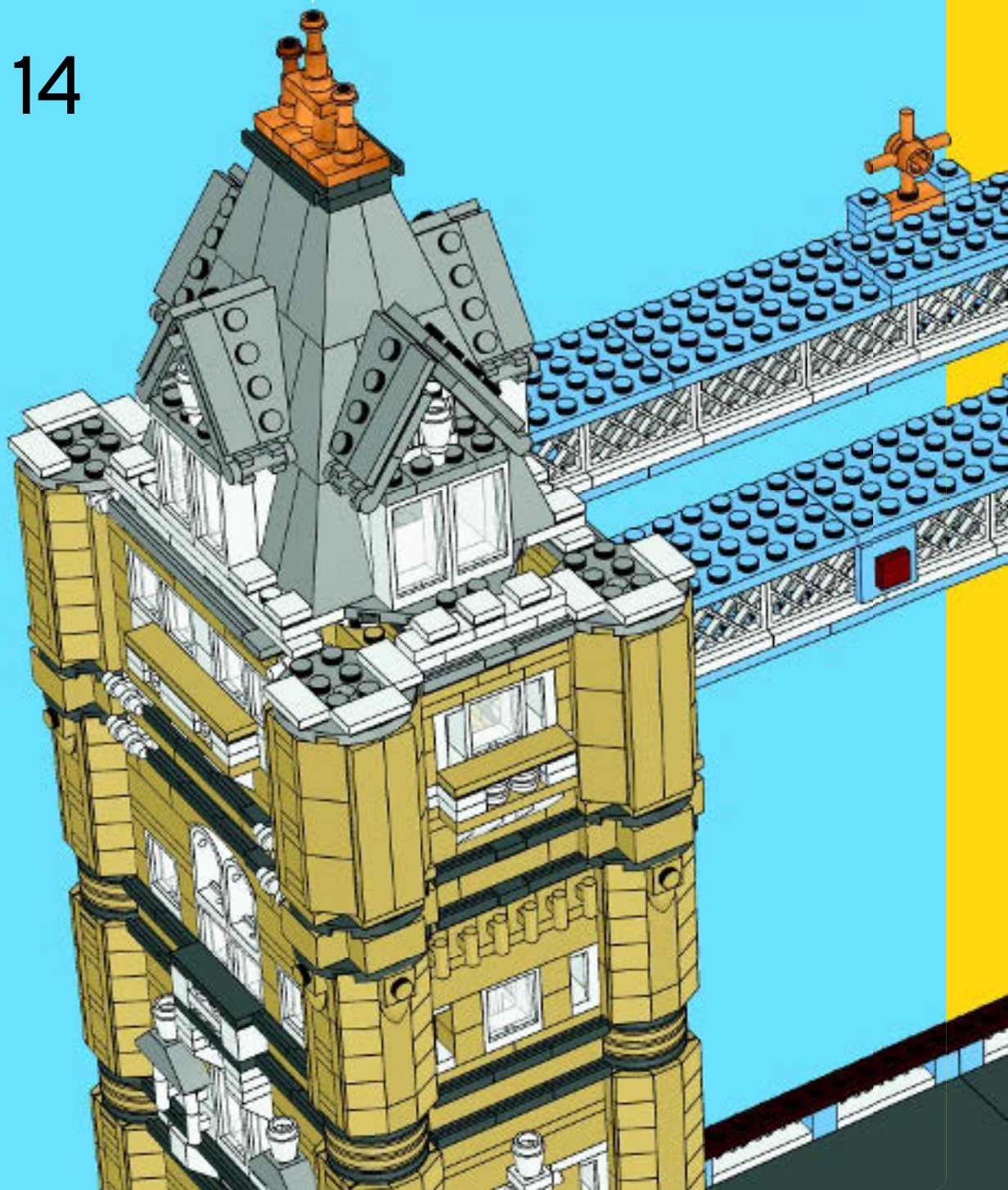

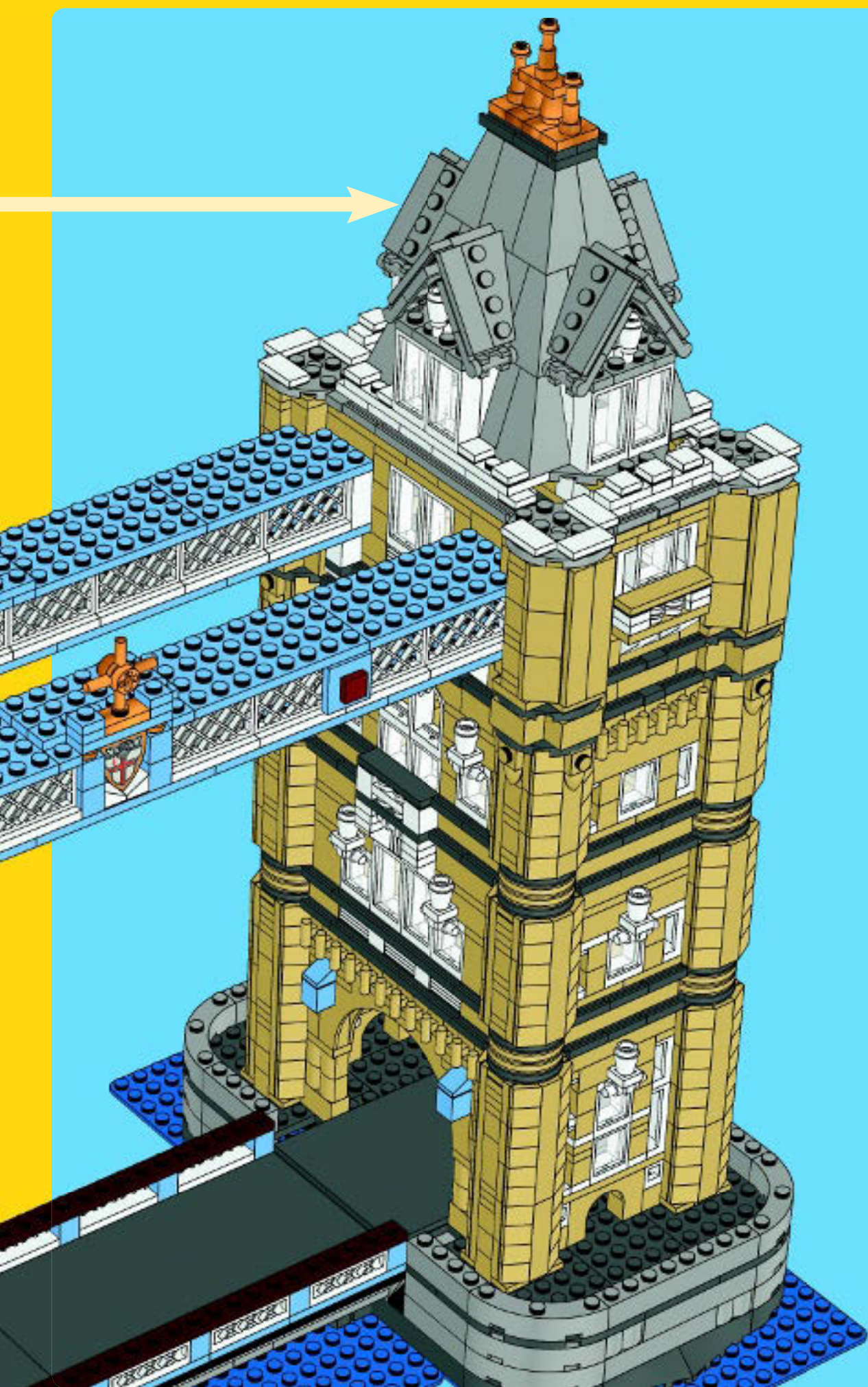

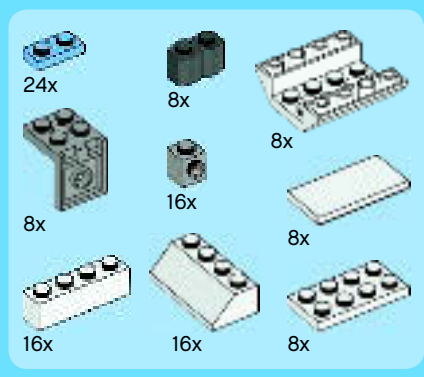

15

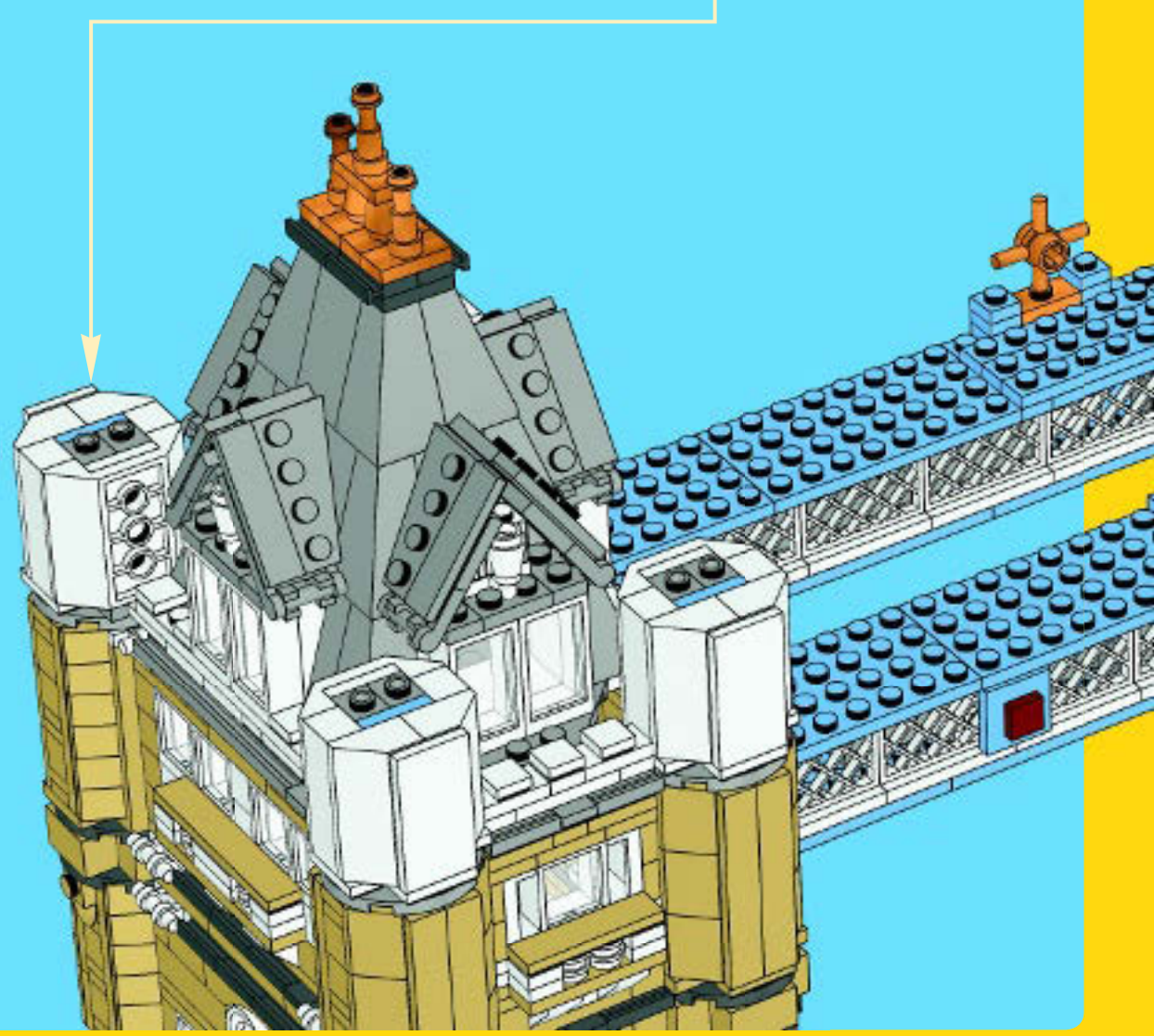
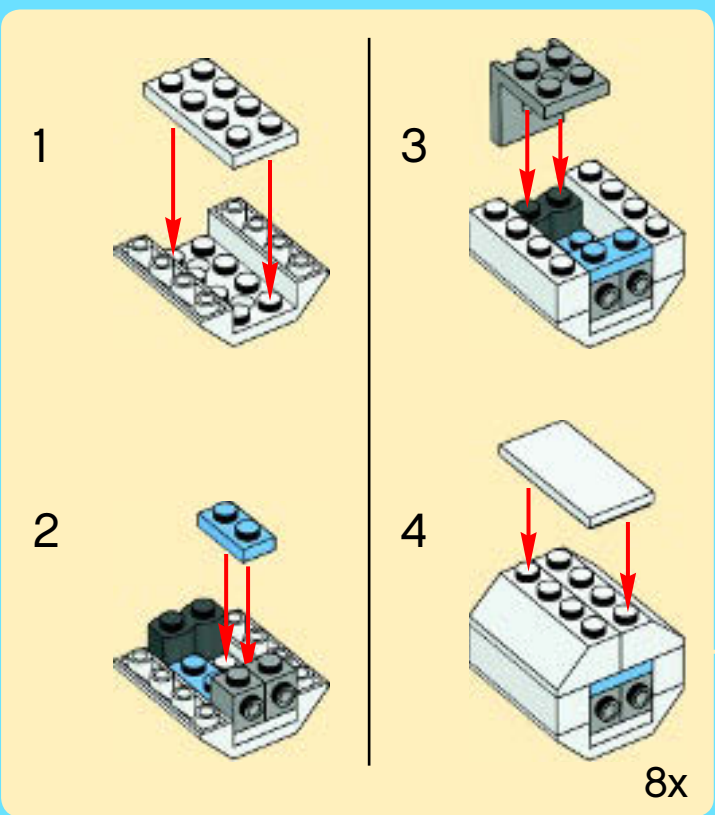

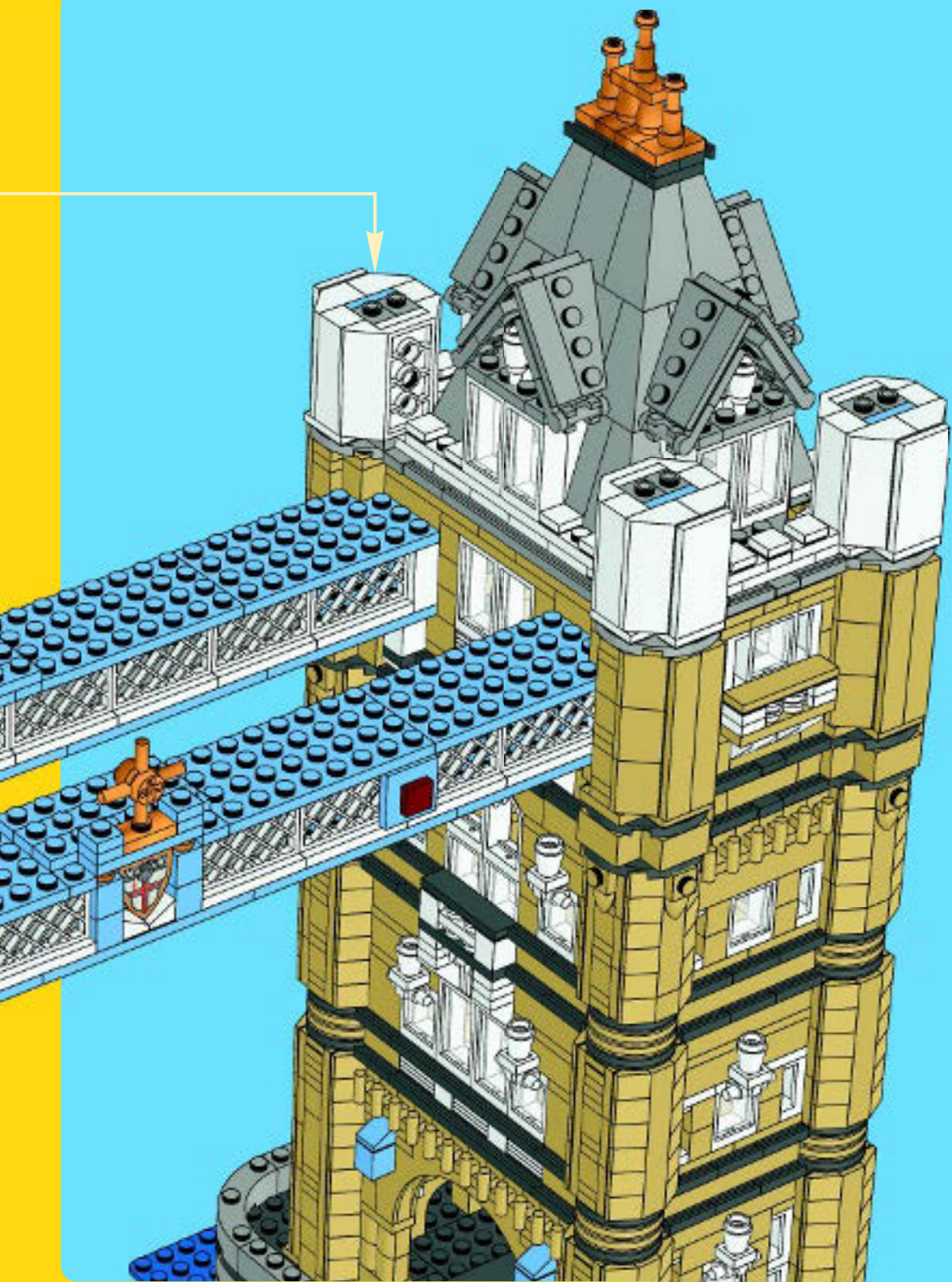



16

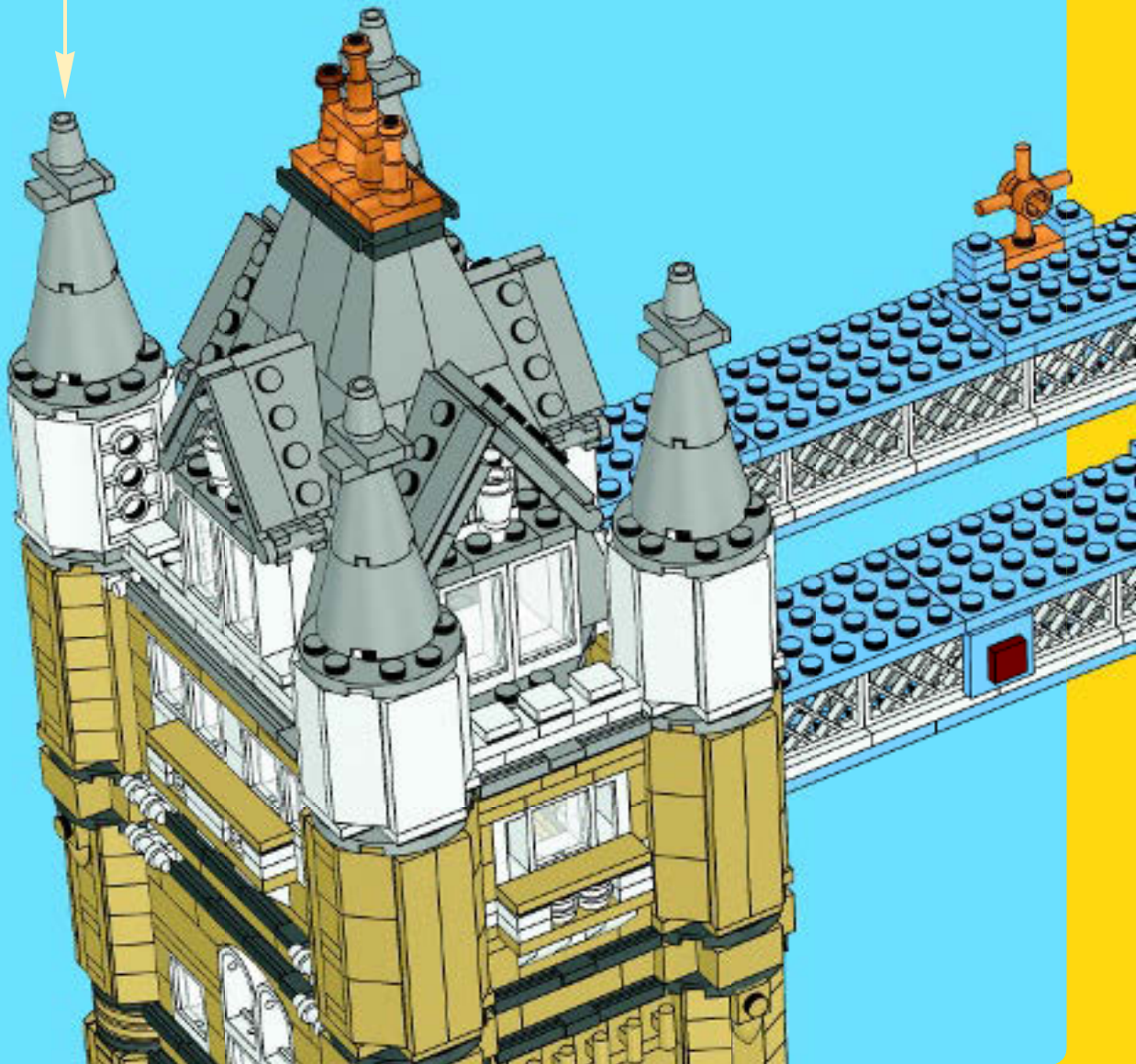
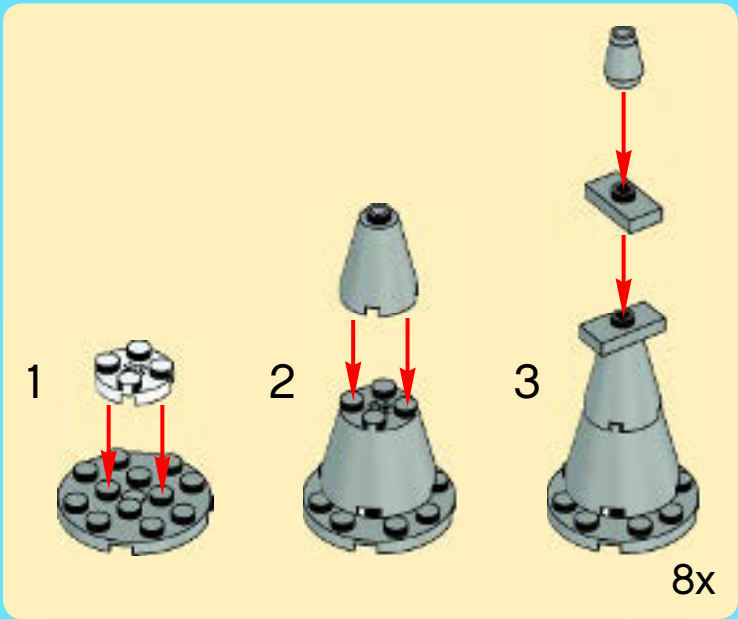

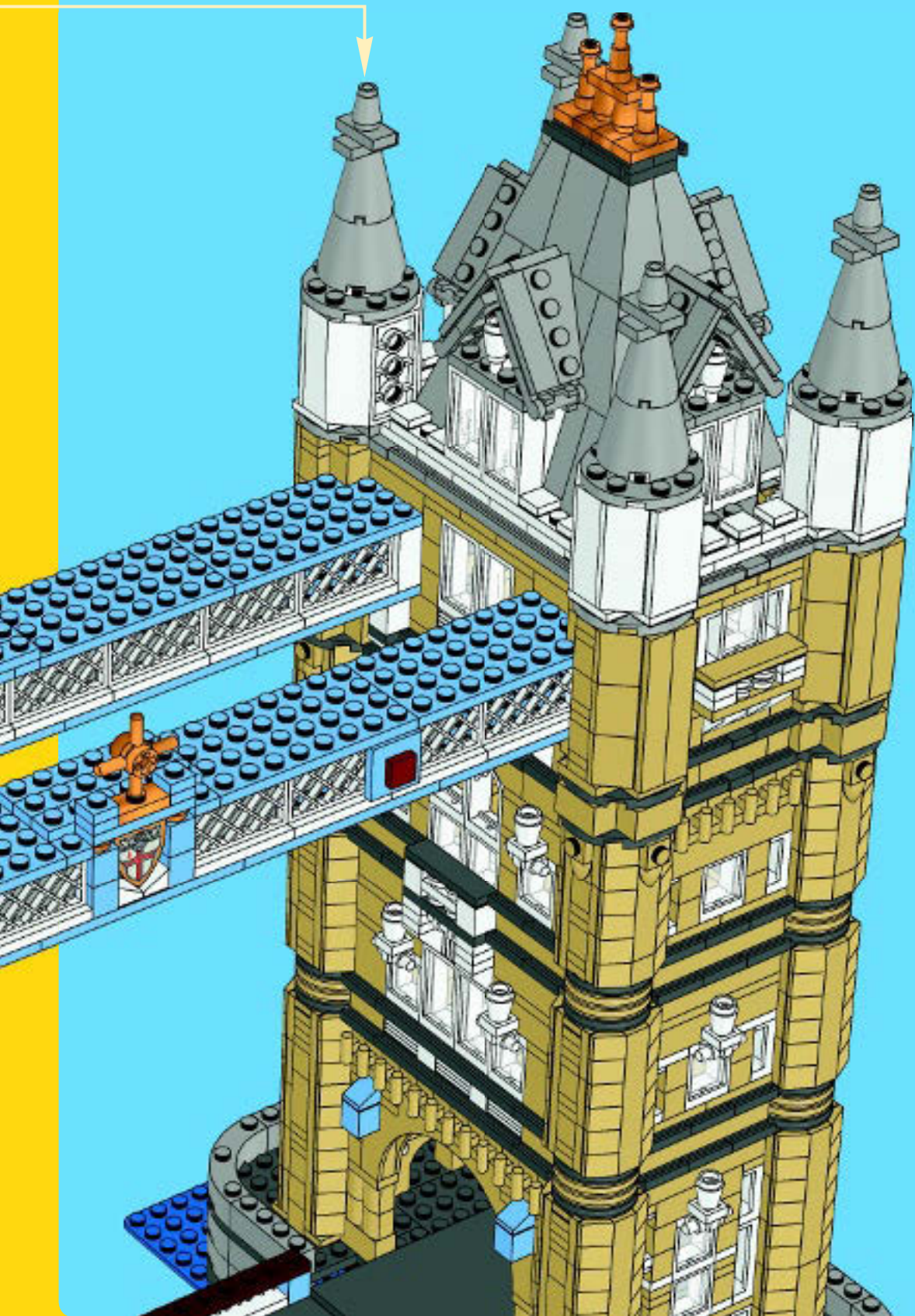

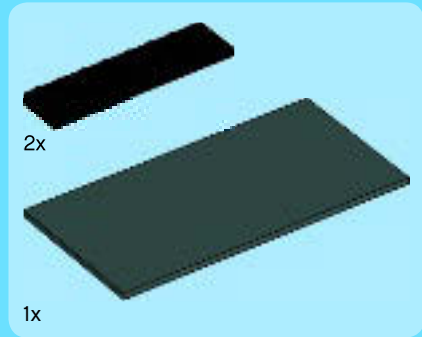
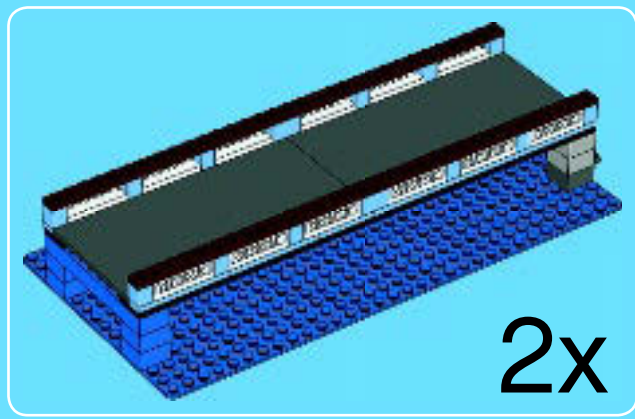

1

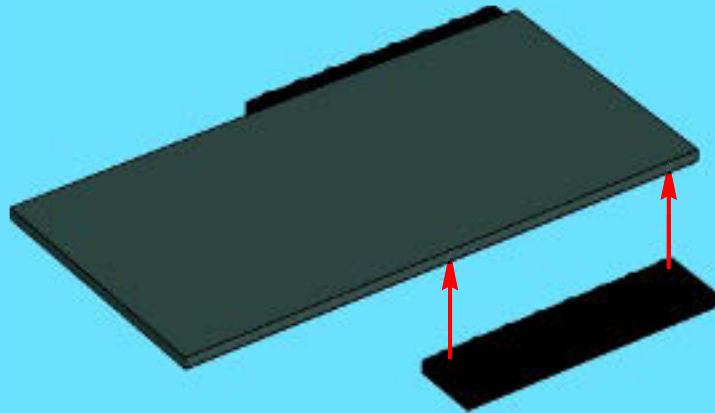



2x

2

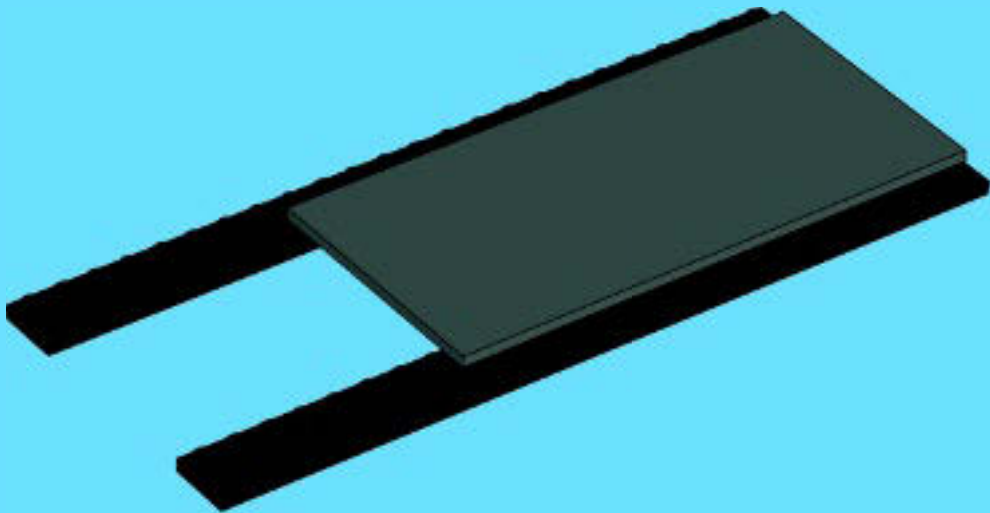

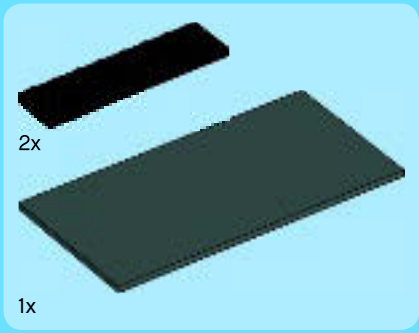

3

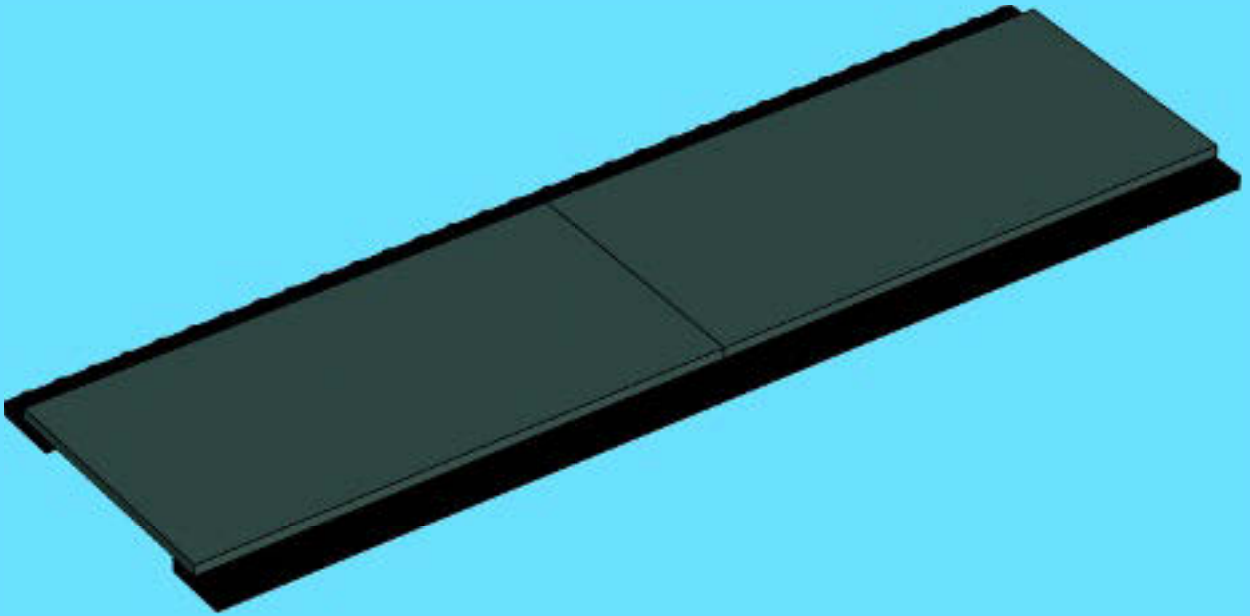



4x



8x

4

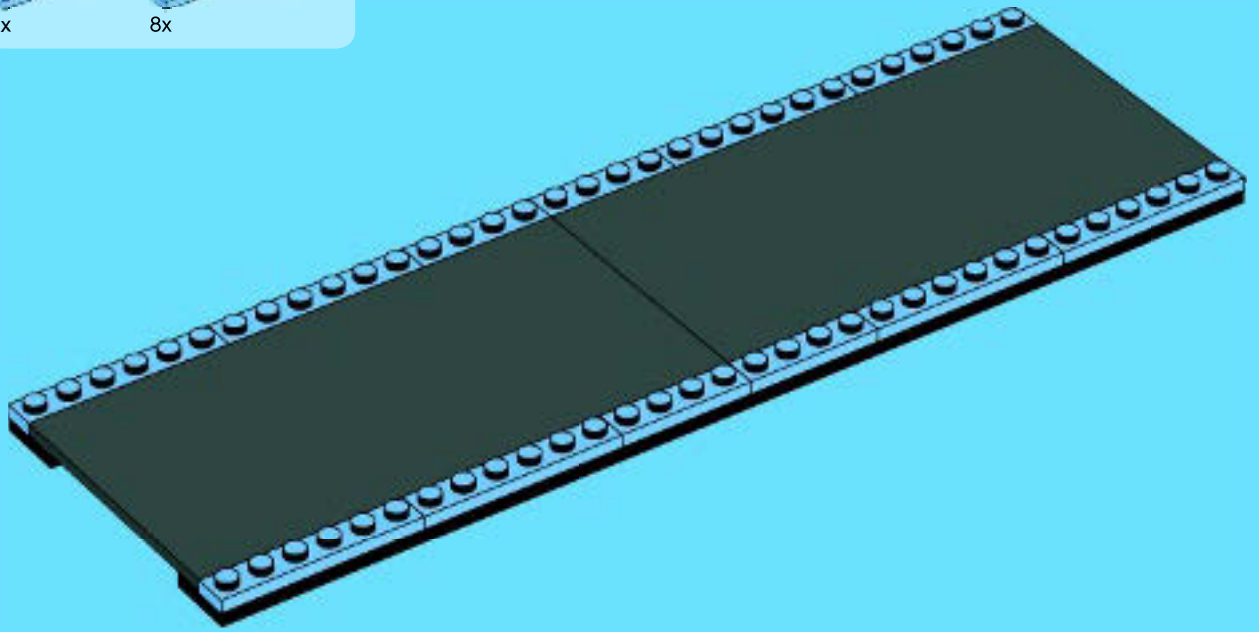

12x



2x



12x

5

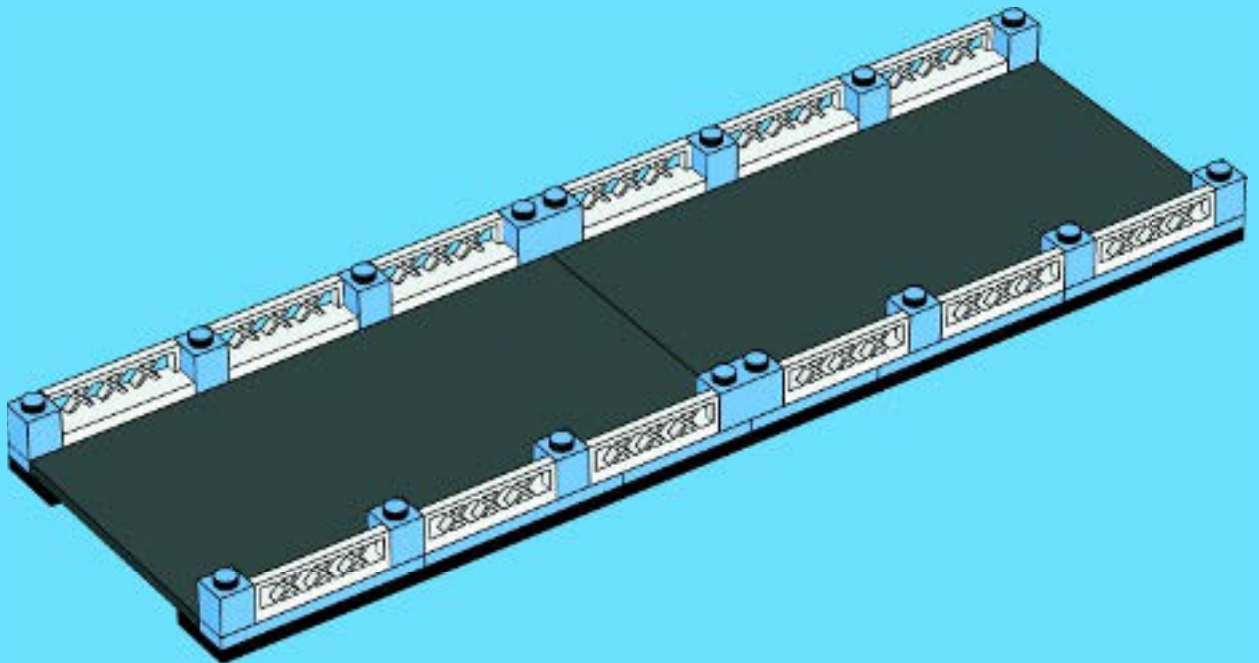



8x

6

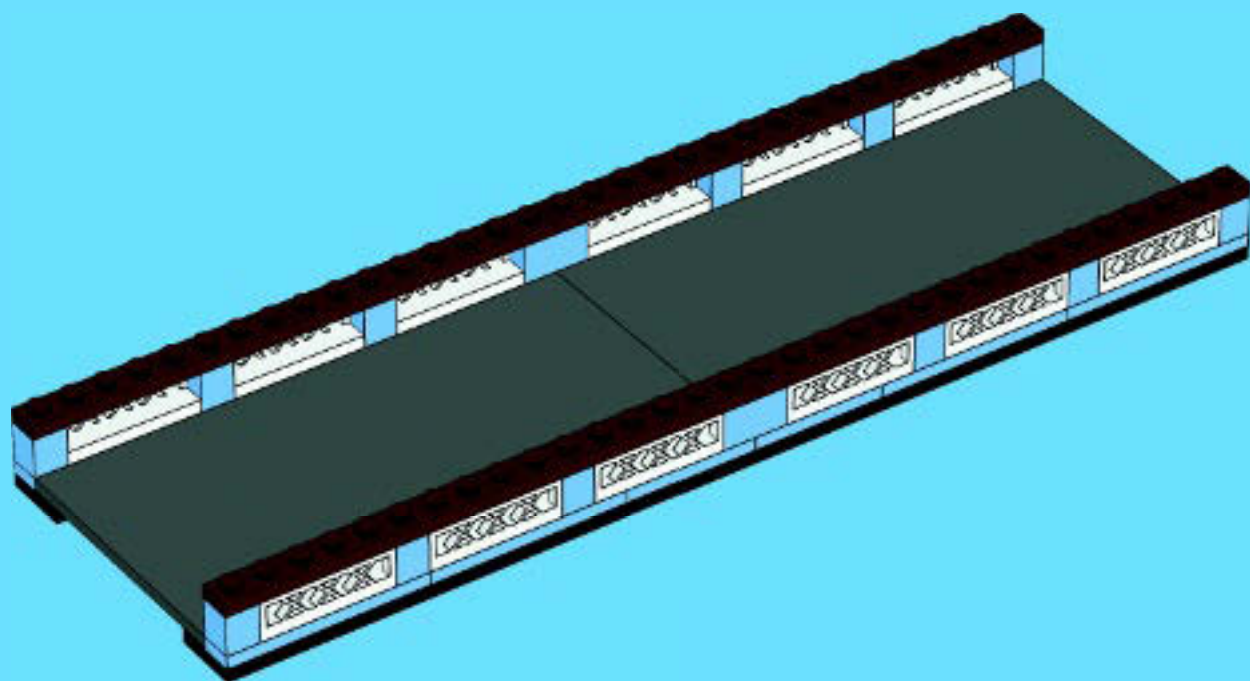

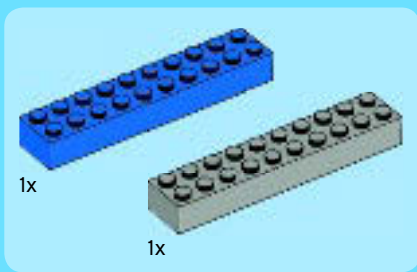

7

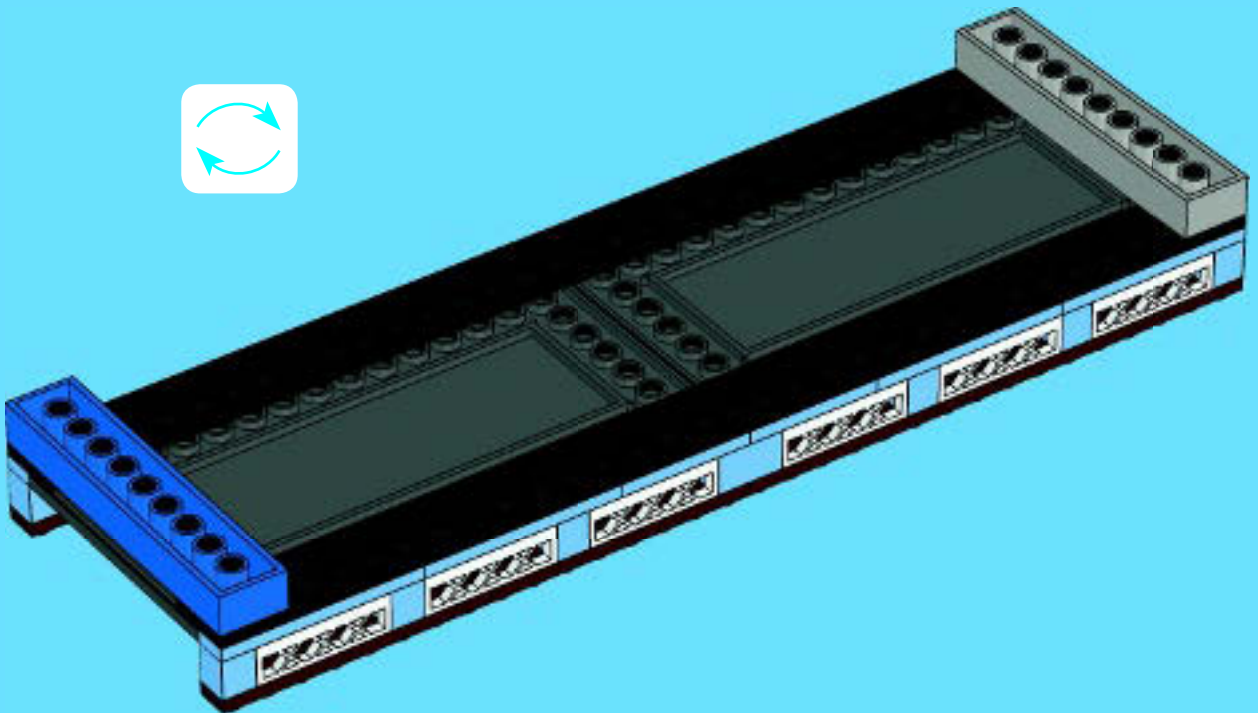



4x



2x



2x

8

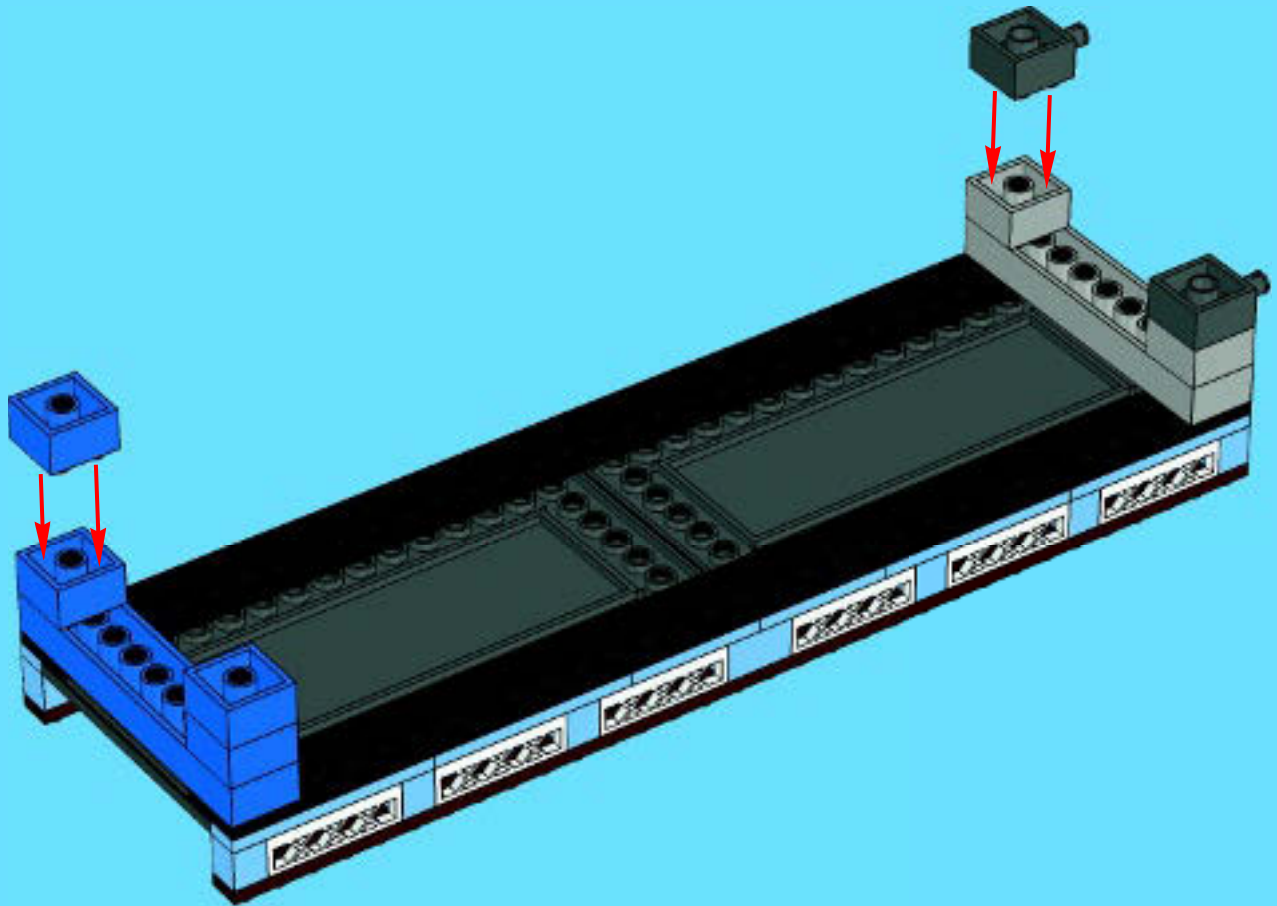

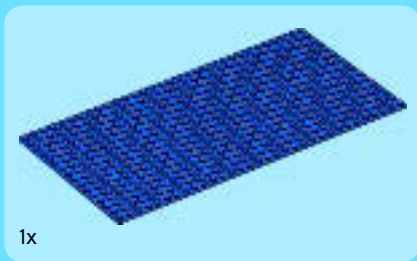

1x

9

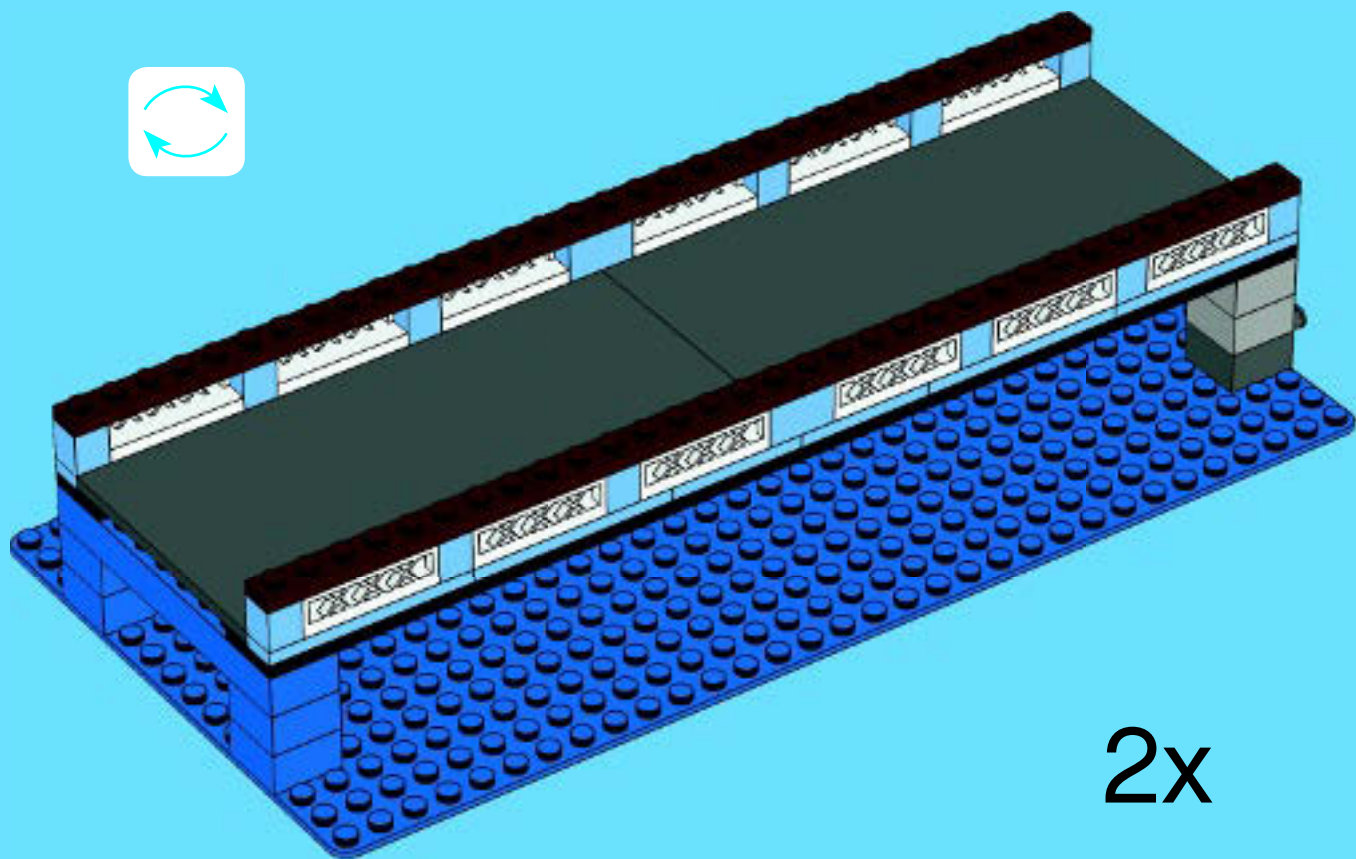

2x

10

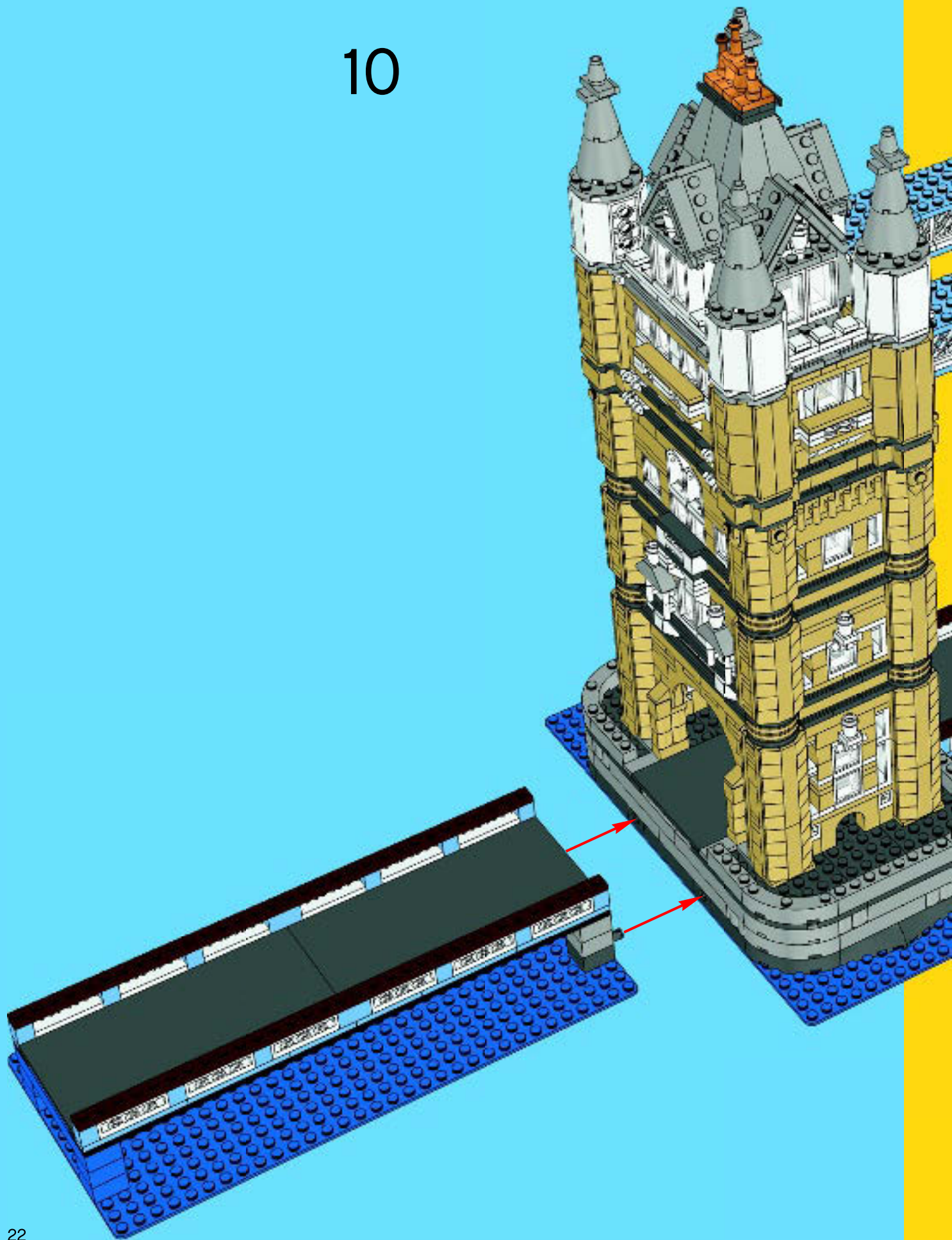

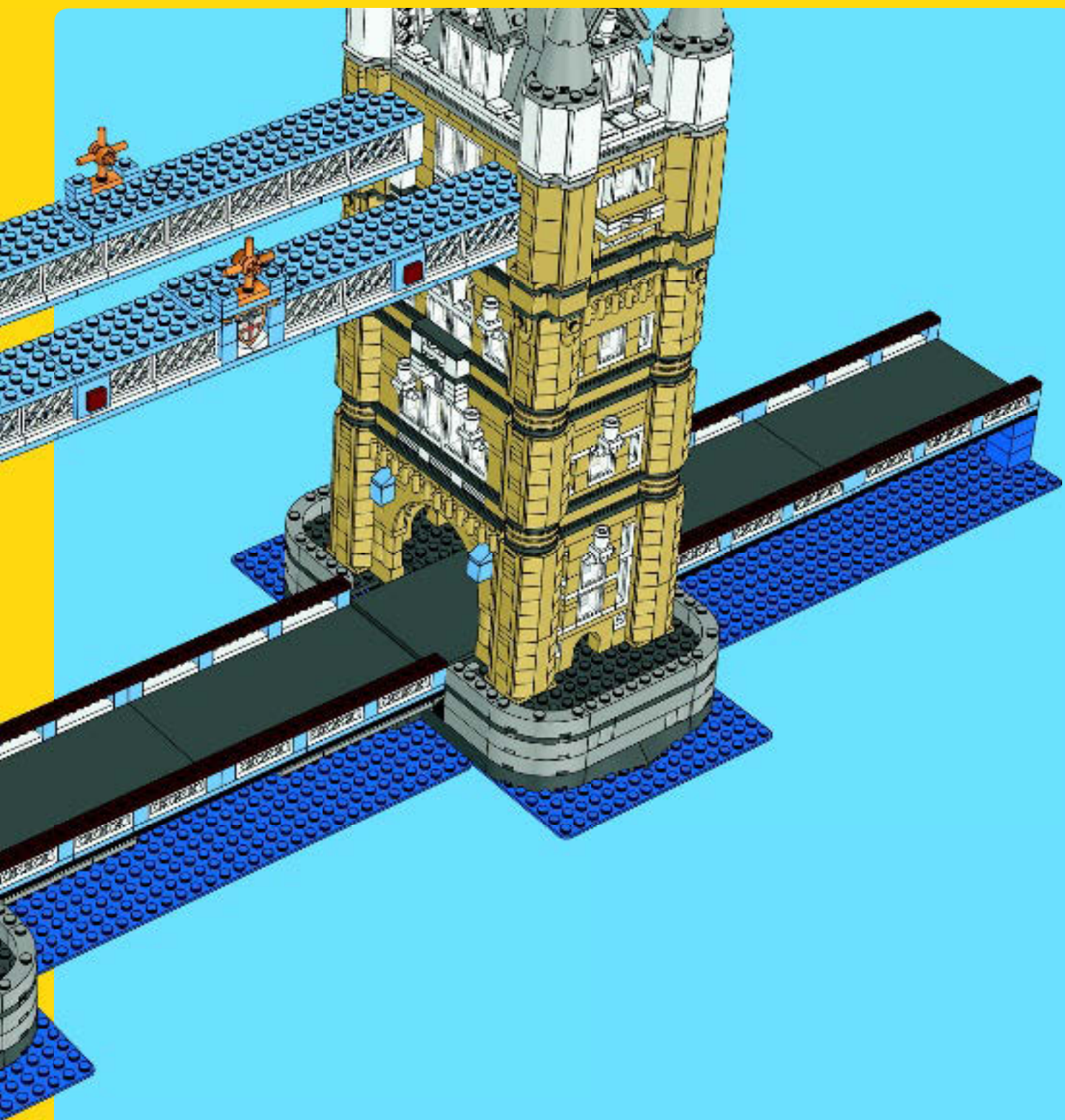



1

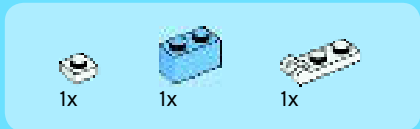
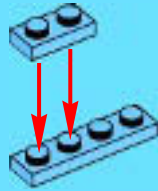

2

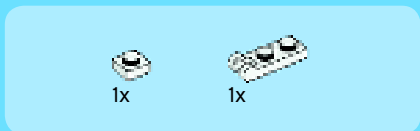
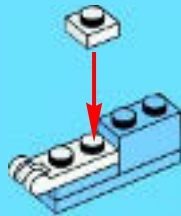

3

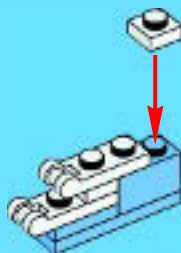



1x



2x

4

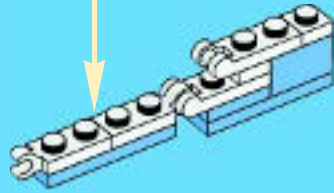
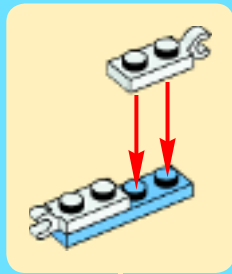

5x



5x



5x



5x

5

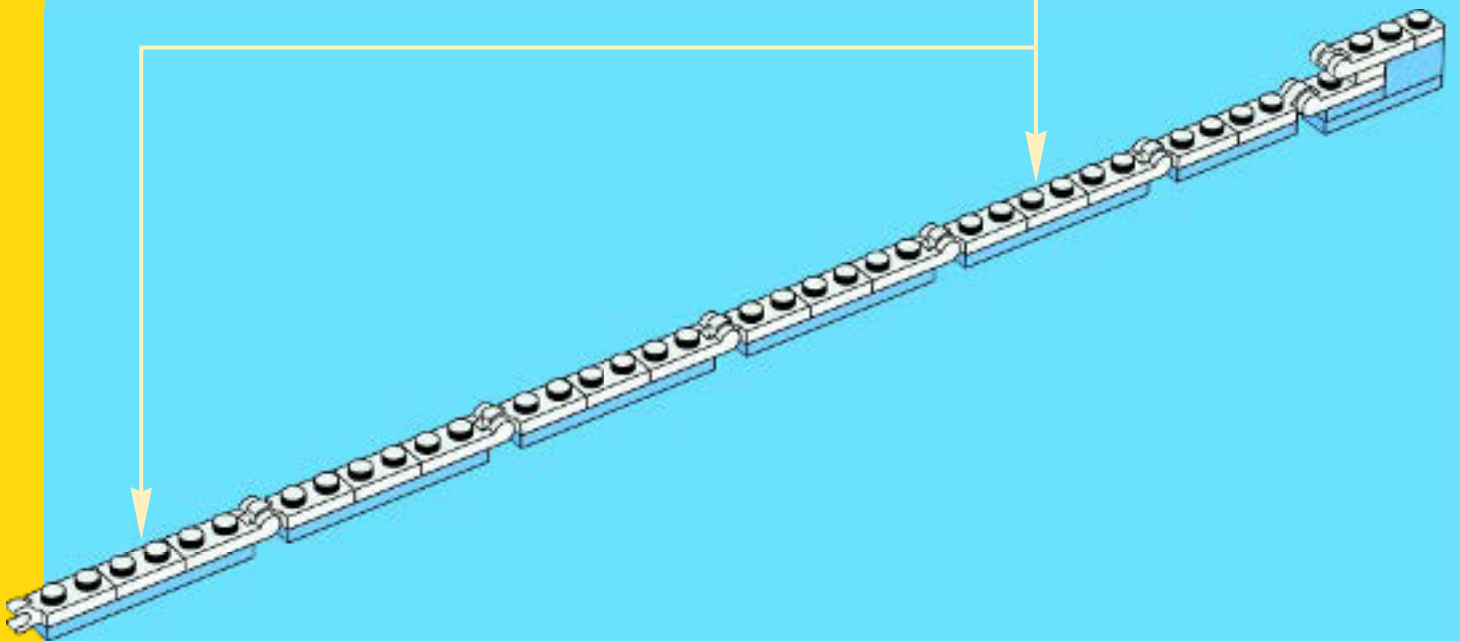
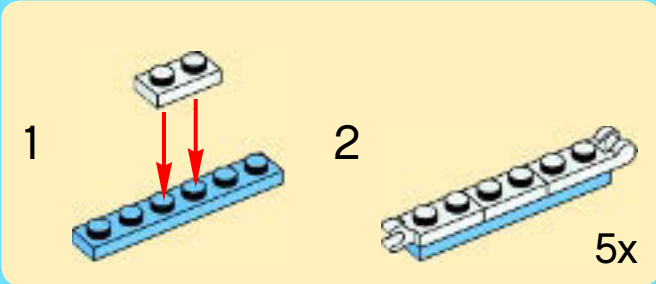



1x



2x

6

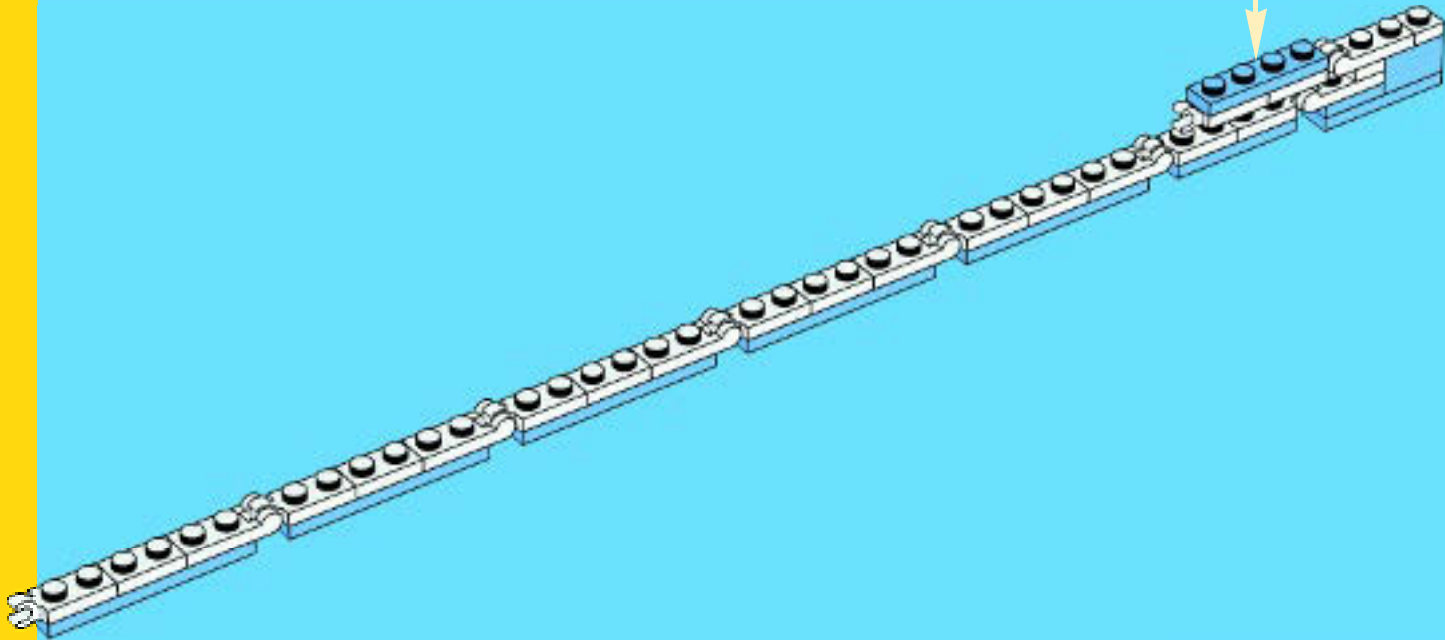
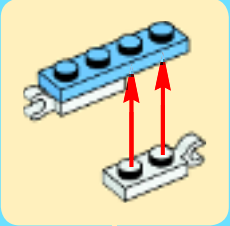



7

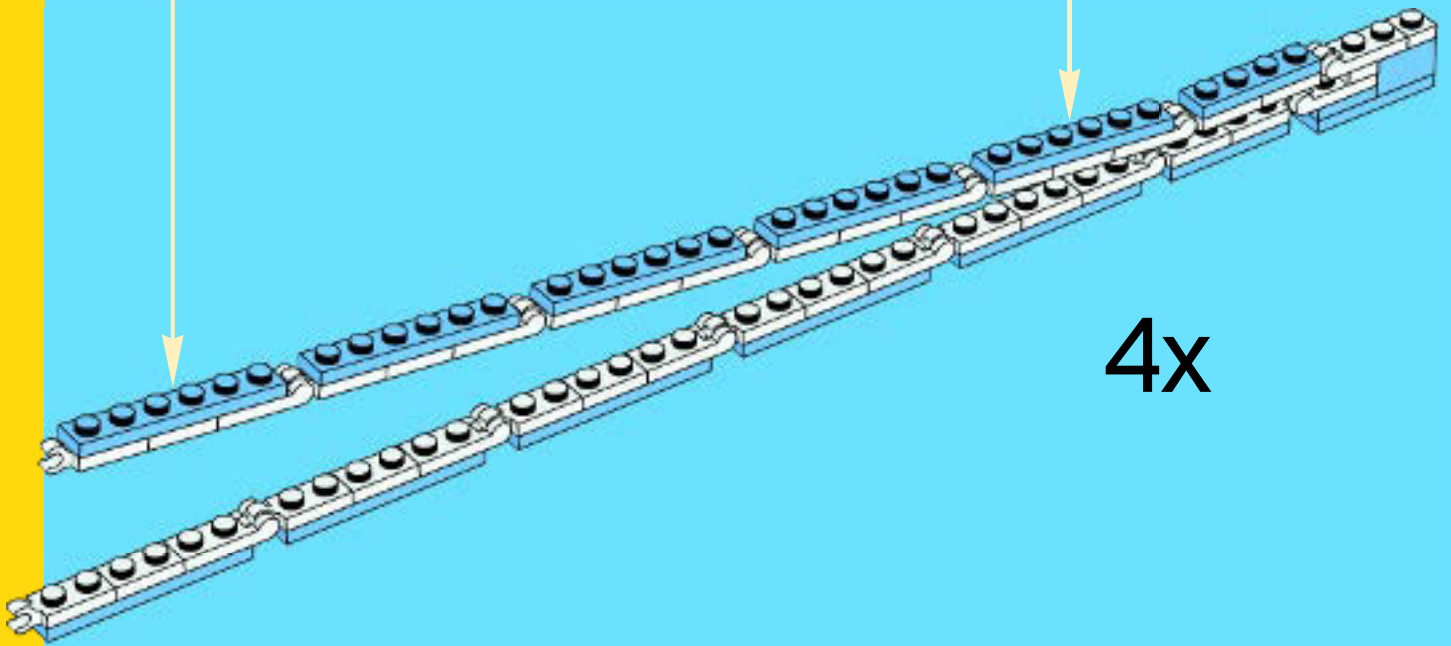
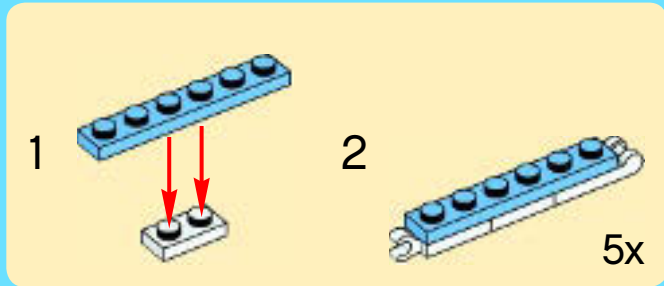

8

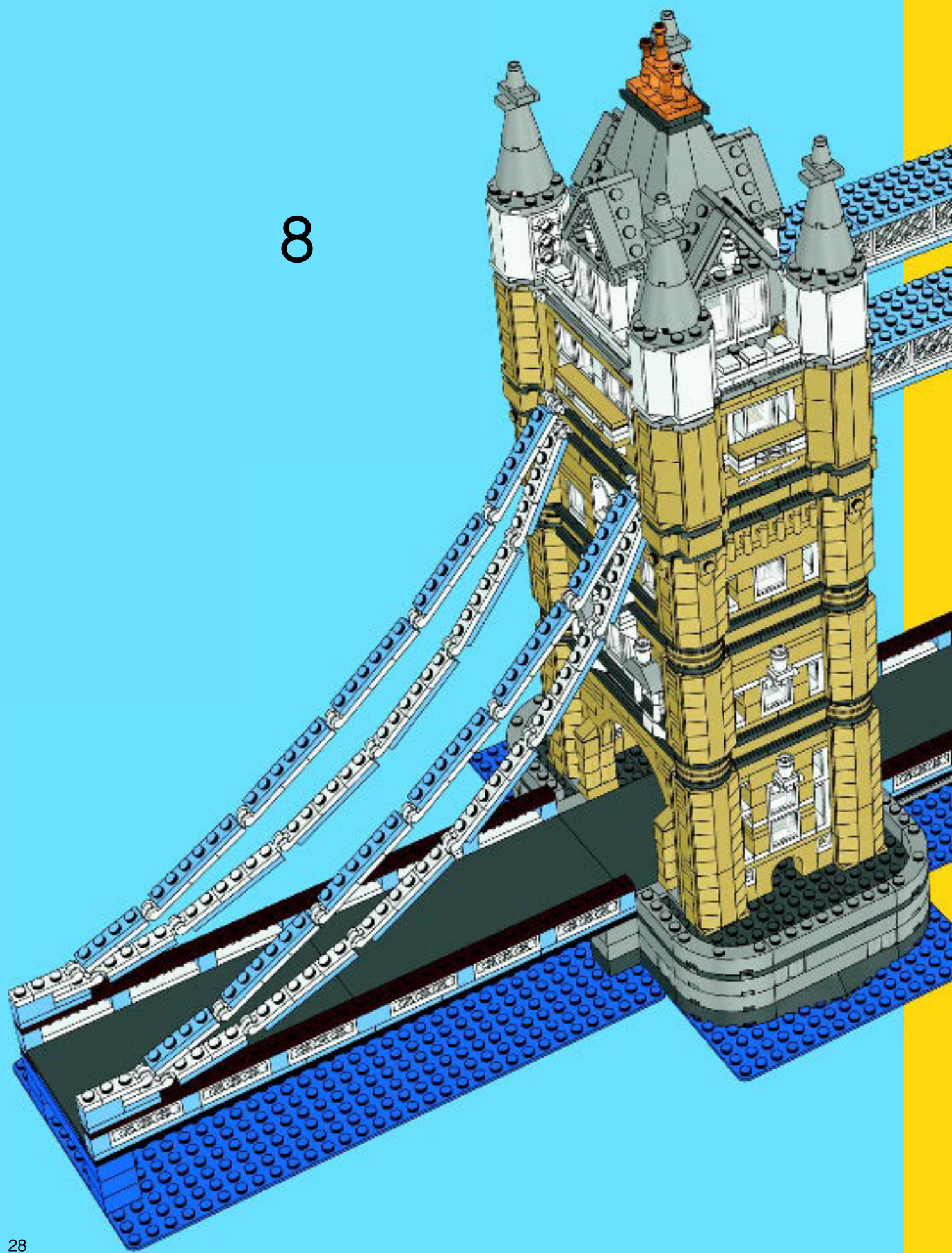

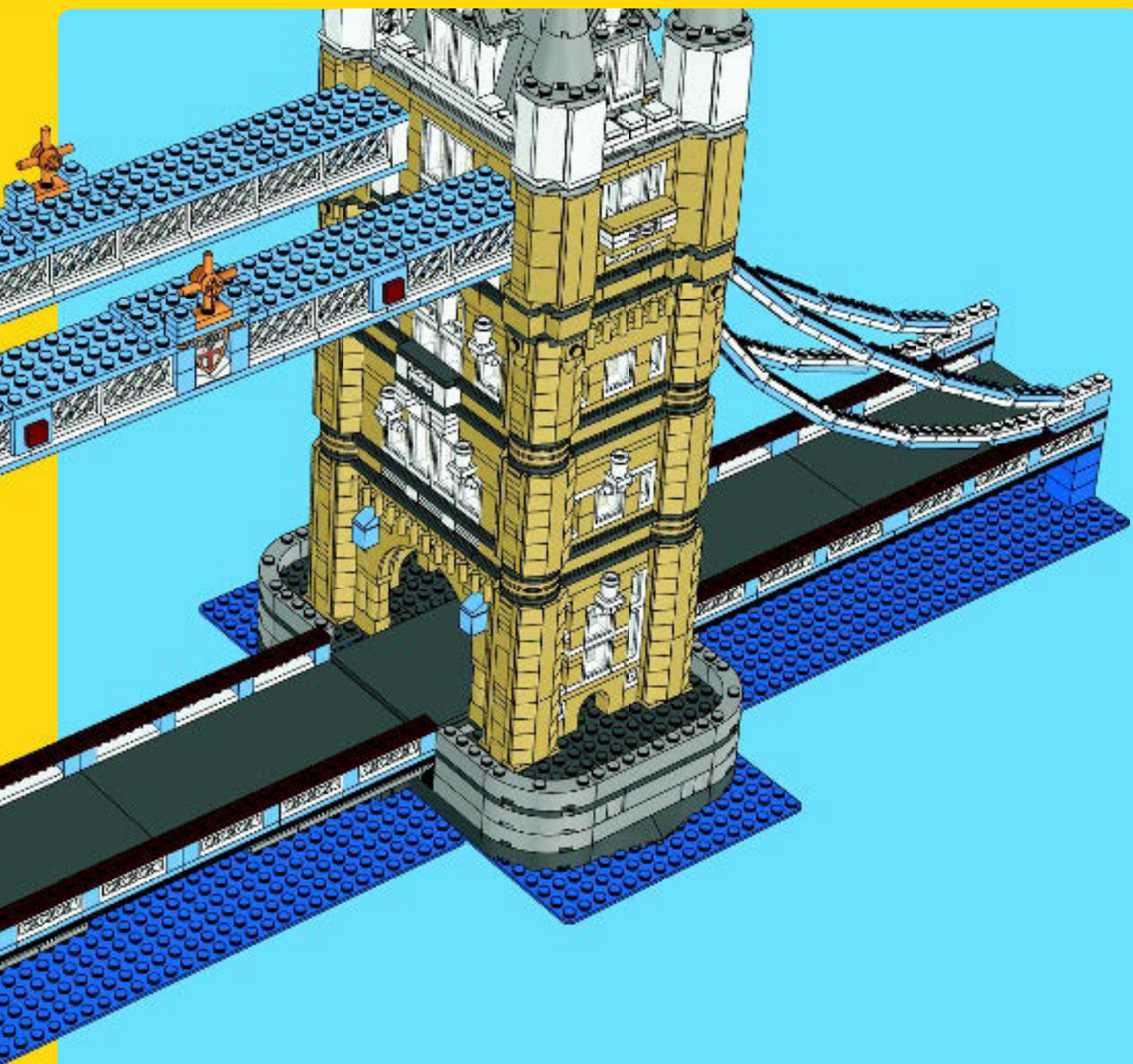



4x



4x



4x

9

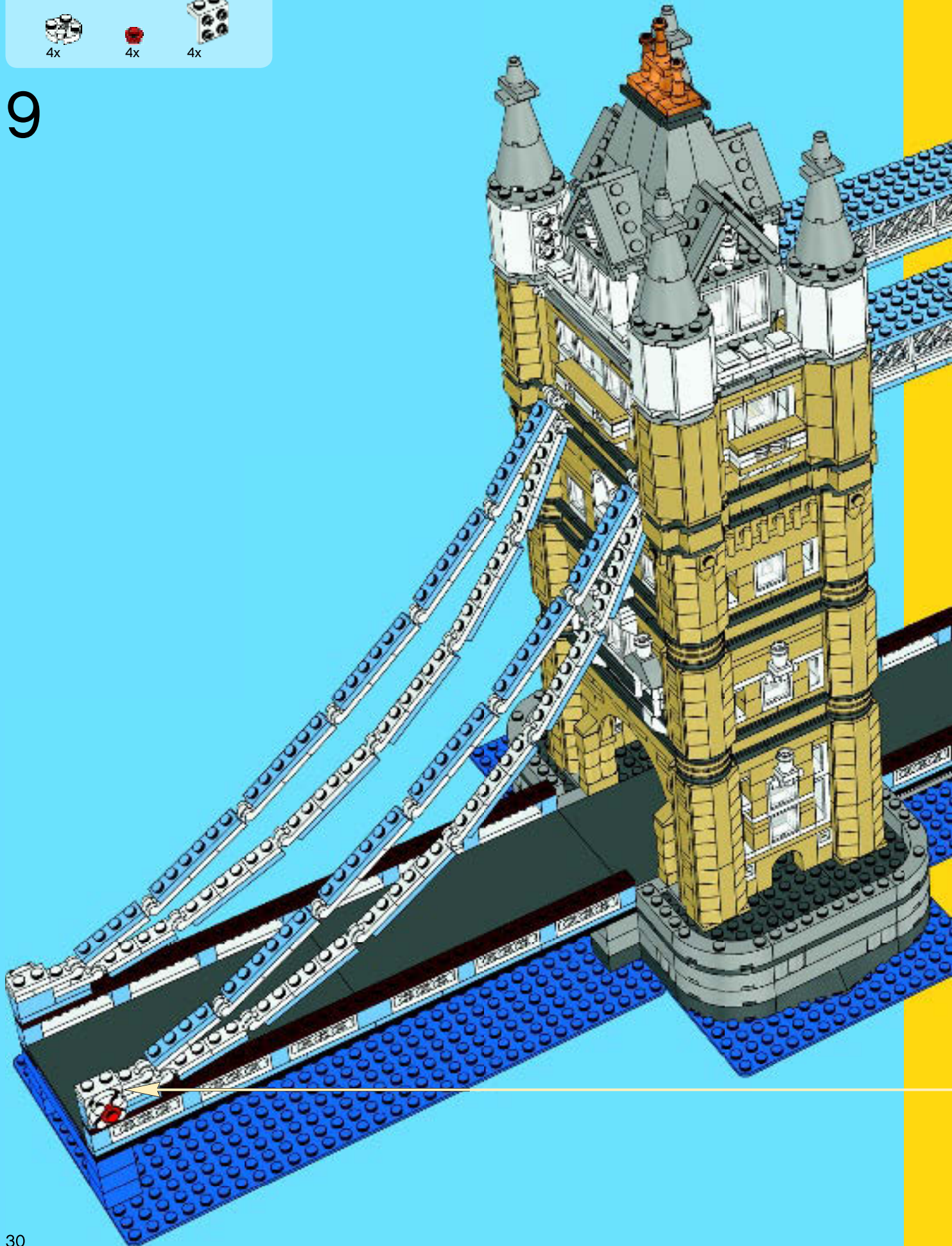

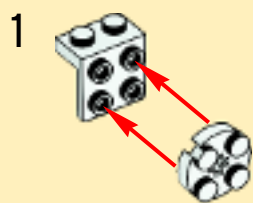
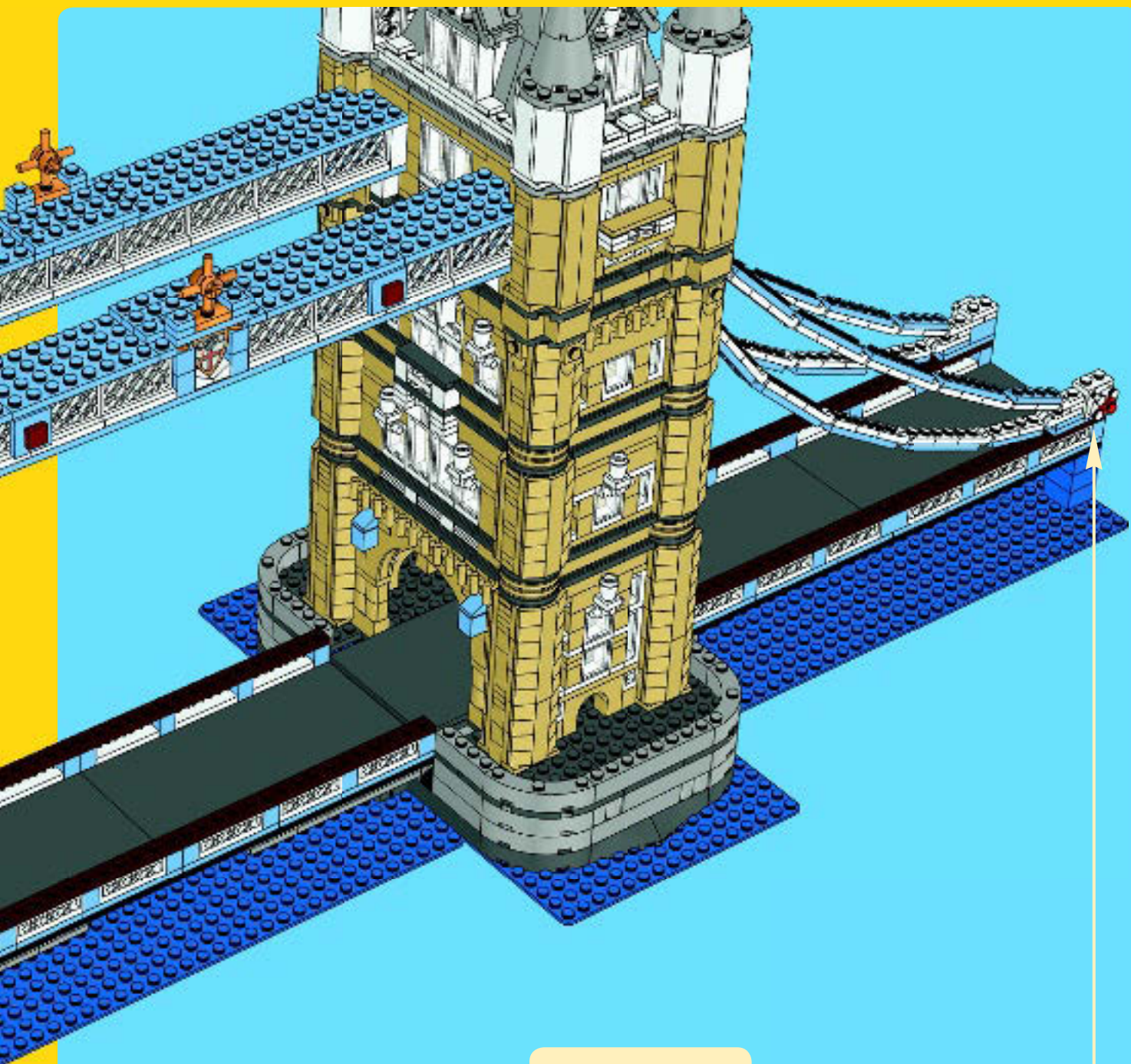



2x



1x

1

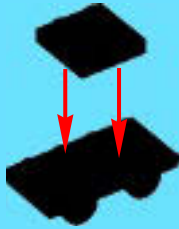

4x



2x

2

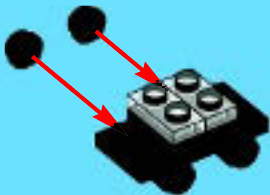

2x



4x

3



1x



1x

4

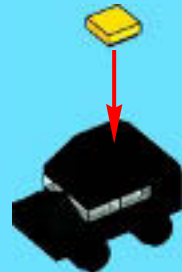



1x



2x

1

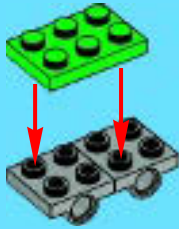

1x



4x

2

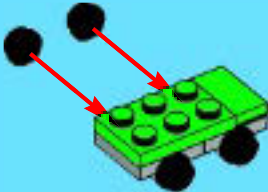

1x



2x

3



1x



2x

4





1

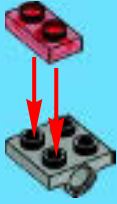

2



4x

3

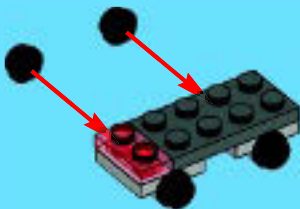

1x



1x

4

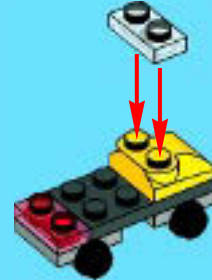

2x



2x



2x

5

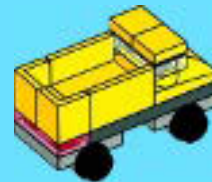

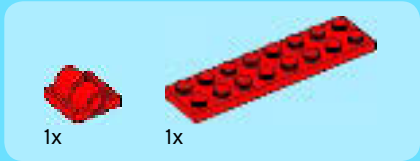

1

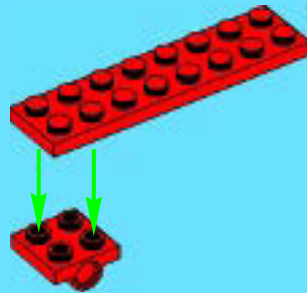

2

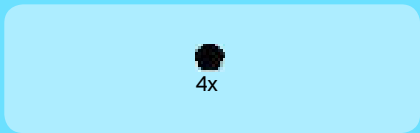
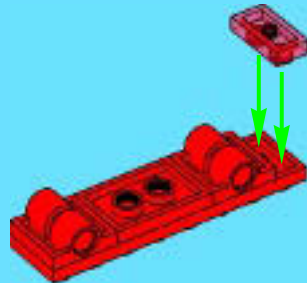

3

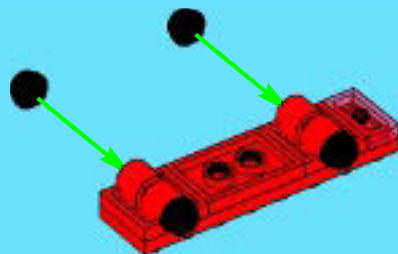



2x



1x



2x

4

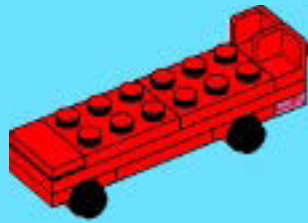

12x



1x

5

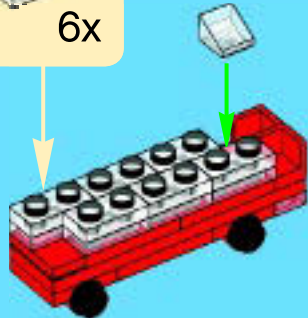
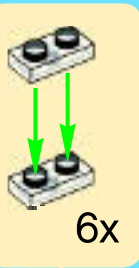

2x



1x

6

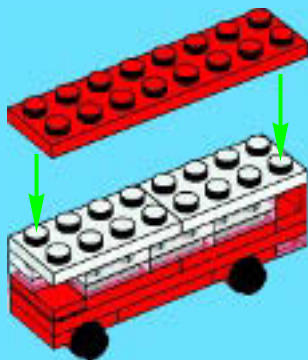



14x

7

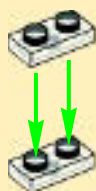

7x

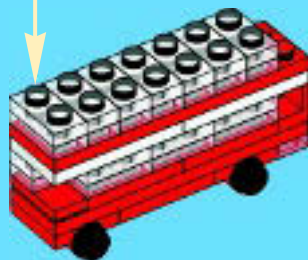

2x



2x

8

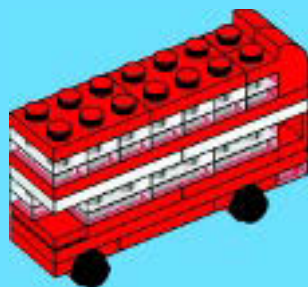

1x



2x

9

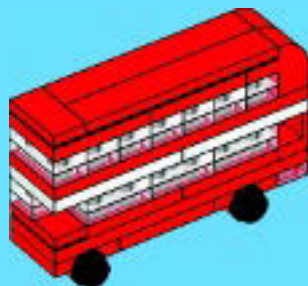

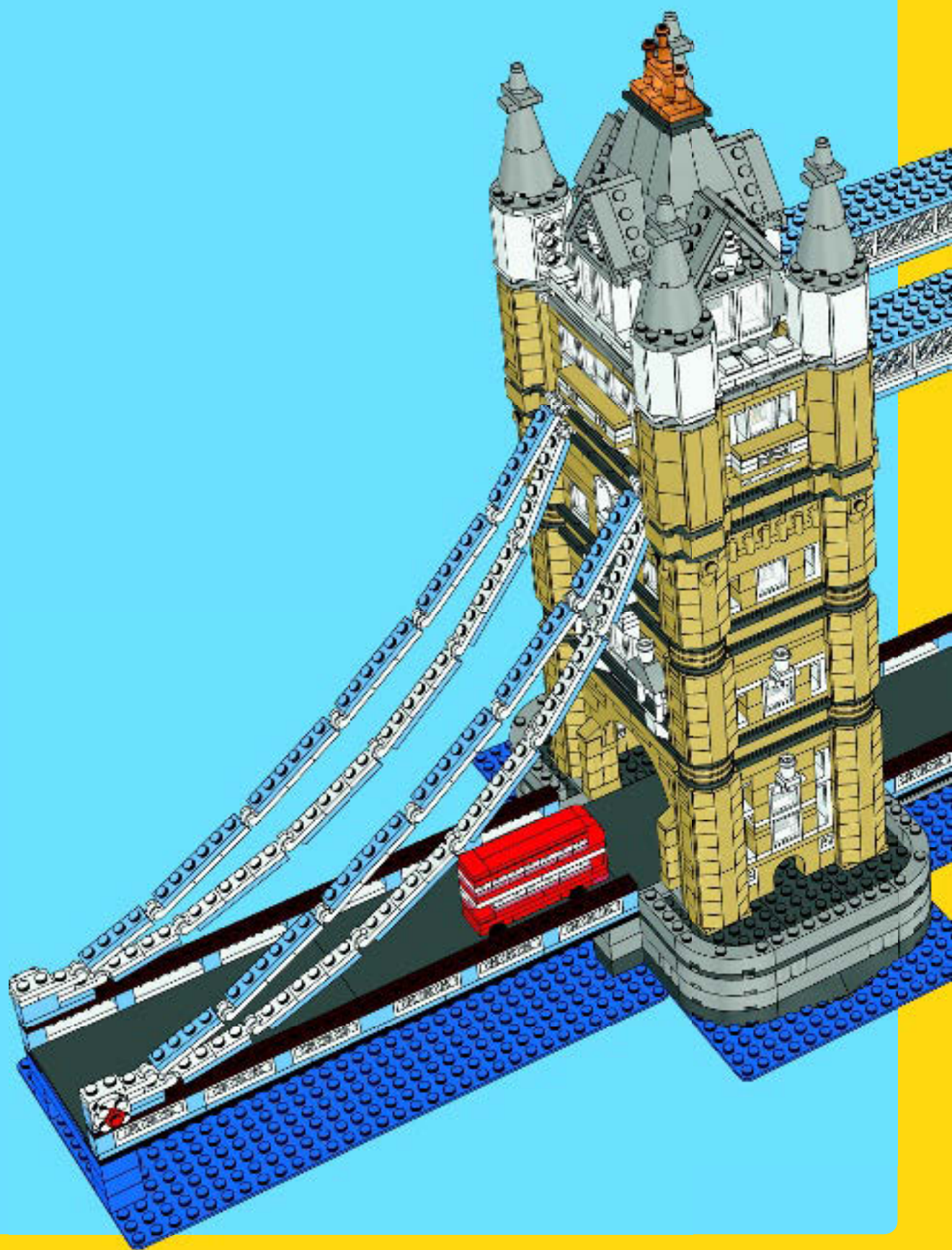



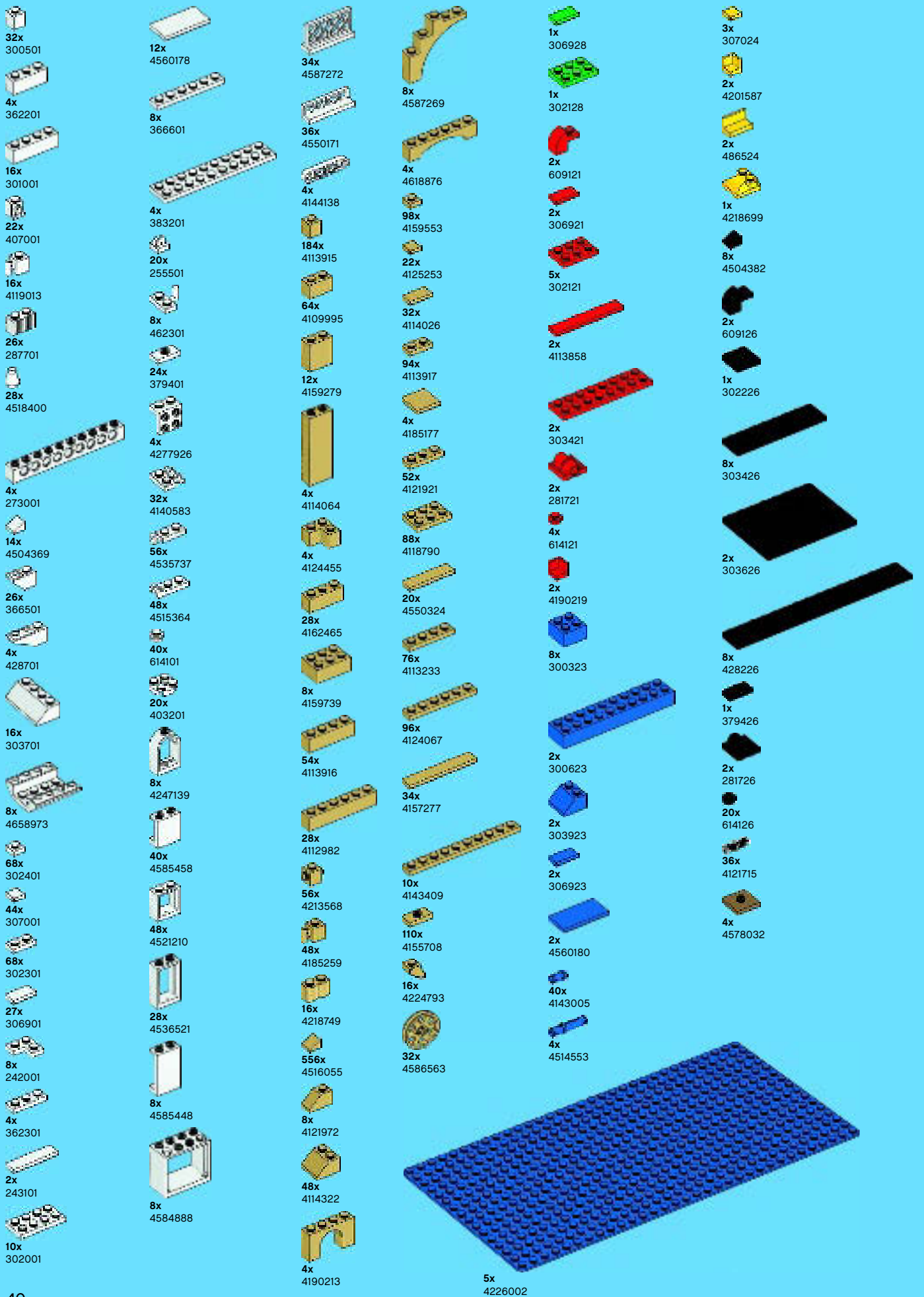

32x 300501
 4x 362201
 16x 301001
 22x 407001
 16x 4119013
 26x 287701
 28x 4518400
 4x 273001
 14x 4504369
 26x 366501
 4x 428701
 16x 303701
 8x 4658973
 68x 302401
 44x 307001
 68x 302301
 27x 306901
 8x 242001
 4x 362301
 2x 243101
 10x 302001

12x 4560178
 8x 366601
 4x 383201
 20x 255501
 8x 462301
 24x 379401
 4x 4277926
 32x 4140583
 56x 4535737
 48x 4515364
 40x 614101
 20x 403201
 8x 4247139
 40x 4585458
 48x 4521210
 28x 4536521
 8x 4585448
 8x 4584888

34x 4587272
 36x 4550171
 4x 4144138
 184x 4113915
 64x 4109995
 12x 4159279
 4x 4114064
 4x 4124455
 28x 4162465
 8x 4159739
 54x 4113916
 28x 4112982
 56x 4213568
 48x 4185259
 16x 4218749
 556x 4516055
 8x 4121972
 48x 4114322
 4x 4190213

8x 4587269
 4x 4618876
 98x 4159553
 22x 4125253
 32x 4114026
 94x 4113917
 4x 4185177
 52x 4121921
 88x 4118790
 20x 4550324
 76x 4113233
 96x 4124067
 34x 4157277
 10x 4143409
 110x 4155708
 16x 4224793
 32x 4586563

1x 306928
 1x 302128
 2x 609121
 2x 306921
 5x 302121
 2x 4113858
 2x 303421
 2x 281721
 4x 614121
 2x 4190219
 8x 300323
 2x 300623
 2x 303923
 2x 306923
 2x 4560180
 40x 4143005
 4x 4514553

3x 307024
 2x 4201587
 2x 486524
 1x 4218699
 8x 4504382
 2x 609126
 1x 302226
 8x 303426
 2x 303626
 8x 428226
 1x 379426
 2x 281726
 20x 614126
 36x 4121715
 4x 4578032

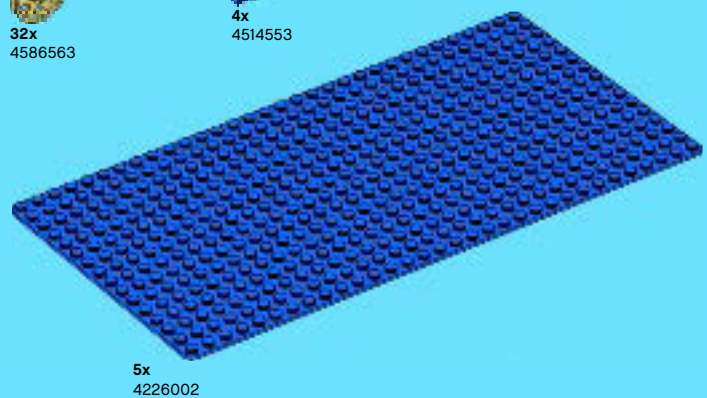

5x 4226002

3x 4244362
 30x 4167842
 48x 4552035
 28x 4536998
 2x 4201019
 40x 4179830
 20x 4179833
 4x 4565363
 8x 4179826
 28x 4179825
 32x 4179828
 70x 4179829
 18x 4587271
 6x 4581079
 4x 4550169
 26x 4211201
 24x 4216945

14x 4211387
 24x 4211394
 8x 4211385
 14x 4211393
 16x 4211392
 2x 4211390
 104x 4558953
 12x 4550325
 8x 4529241
 8x 4211471
 24x 4215472
 8x 4497653
 8x 4211494
 24x 4191414
 16x 4211684
 4x 4251563
 2x 4509914

14x 4211414
 24x 4211397
 4x 4211429
 16x 4211356
 20x 4211438
 2x 4211406
 8x 4251149
 18x 4211451
 16x 4556157
 10x 4211568
 16x 4244627
 4x 4211376
 8x 4211472
 4x 4211498
 8x 4211732
 8x 4211735
 16x 4515351
 4x 4211352
 2x 4582980

4x 4211103
 6x 4211100
 18x 4211095
 8x 4211046
 8x 4535931
 4x 4211111
 2x 4210917
 4x 4298583
 4x 4298580
 8x 4211052
 8x 4210635
 4x 4211043
 4x 4211001
 4x 4211053
 3x 4211065
 4x 4243831
 4x 4211002
 8x 4211115

8x 4211119
 8x 4210763
 140x 4543086
 10x 4210967
 16x 4528323
 8x 4500517
 32x 4587275
 8x 4596898
 4x 4529247
 12x 4523157
 4x 4523159
 6x 4538126
 2x 4587274



10197

10211

10185

1932

SHOP

FREE! GRATIS! GRATUIT!



club
MAGAZINE™

www.LEGOclub.com



00800 5346 5555*



1-866-534-6258 • 1-877-518-5346

US & Canada only

Canada seulement

* FreePhone. Mobile charges may apply. * Numéro sans Frais. Des Frais peuvent s'appliquer avec les téléphones cellulaires. * Gebührenfrei, Kosten für Anrufe aus Mobilfunknetzen können abweichen. * Gratis telefonnummer vanaf vaste lijn. * Des de este gratis număr, air de ringer Prin Posttelefon. * Des de gratis, air de ringer Prin en Post telefon.



**VISIT THE WORLD'S
BIGGEST LEGO® SHOP!**

www.LEGOshop.com



WIN!

Go to www.nielsen.com/LEGO to fill out a survey for a chance to win a cool LEGO® Product.

No purchase necessary.

Open to all residents where not prohibited.

 www.LEGO.com



www.nielsen.com/LEGO

GEWINNE!

Nimm an der Umfrage auf www.nielsen.com/LEGO teil und hab die Chance ein cooles LEGO® Produkt zu gewinnen!

Die Teilnahme am Gewinnspiel führt zu keinerlei Kaufverpflichtungen. Teilnahme in allen nicht ausgeschlossenen Ländern möglich.

WIN!

Ga naar www.nielsen.com/LEGO, vul een enquêteformulier in en maak kans op een cool LEGO® product.

Geen aankoopverplichting. Iedereen mag deelnemen, uitgezonderd ingezetenden van landen waar een enquêteverbod geldt.

GAGNE !

Visite www.nielsen.com/LEGO pour répondre à un questionnaire et avoir une chance de gagner un produit LEGO® très cool !

Aucune obligation d'achat. Ouvert à tous les résidents des pays autorisés.

当てよう!

www.nielsen.com/LEGOにアクセスして、アンケートにご記入ください。当選者にはレゴ®製品を差し上げます。

お買い上げの必要はありません。禁止されていない限り、すべての皆様にご利用いただけます。