

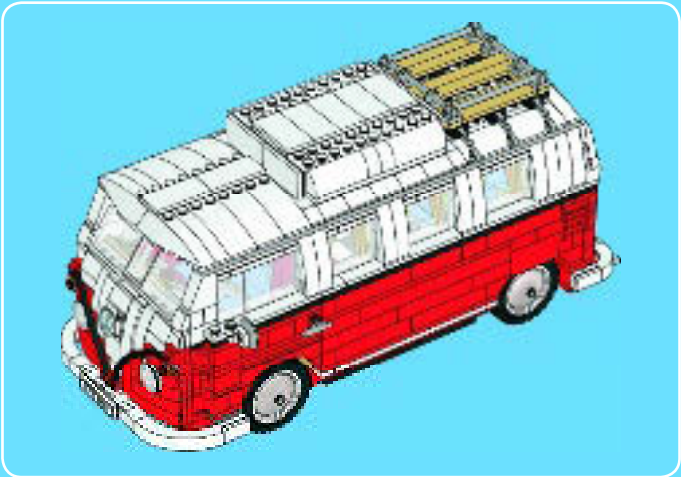

10220





1

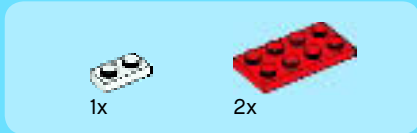
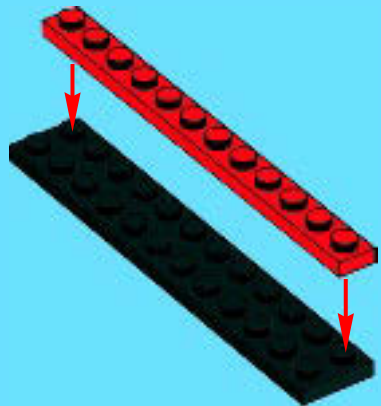

2

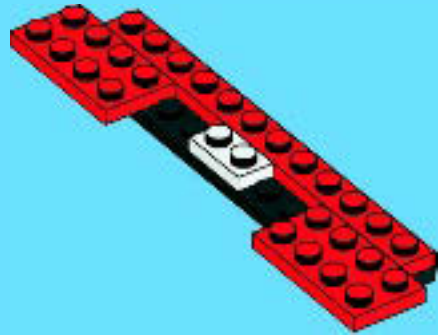

3

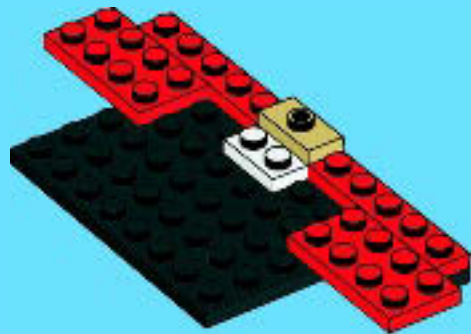



1x



2x



2x



1x

# 4

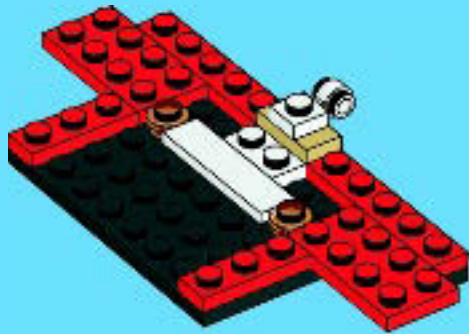

2x



1x



2x

# 5

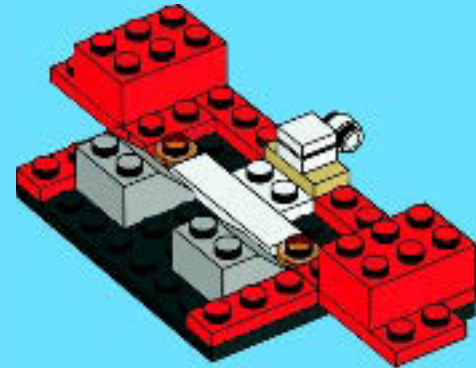

1x



4x

# 6

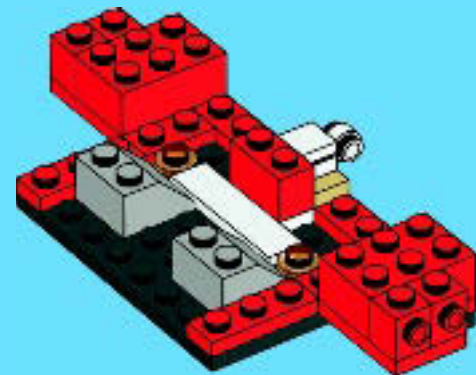

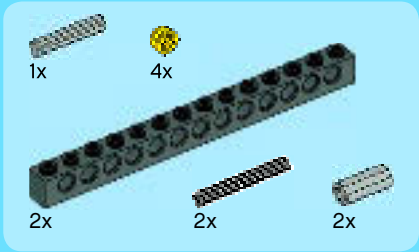

7

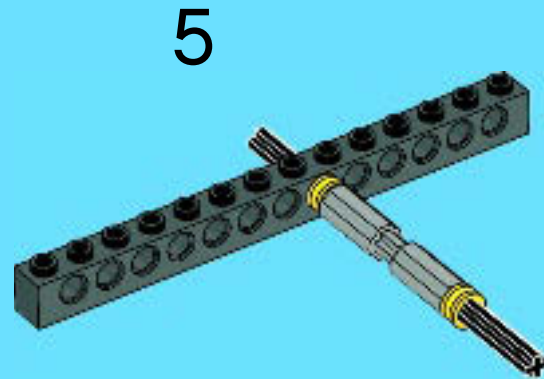
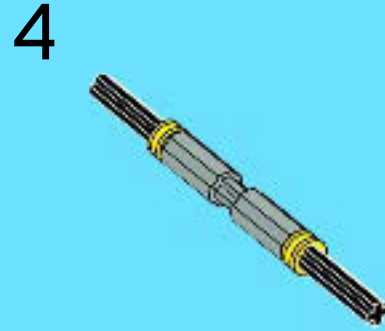
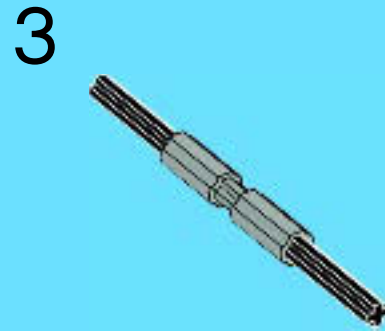
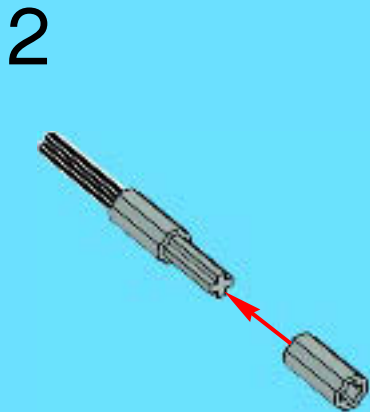
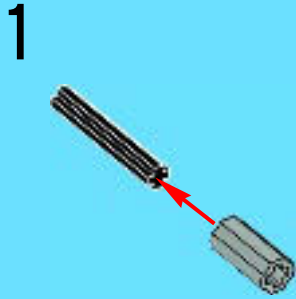

6

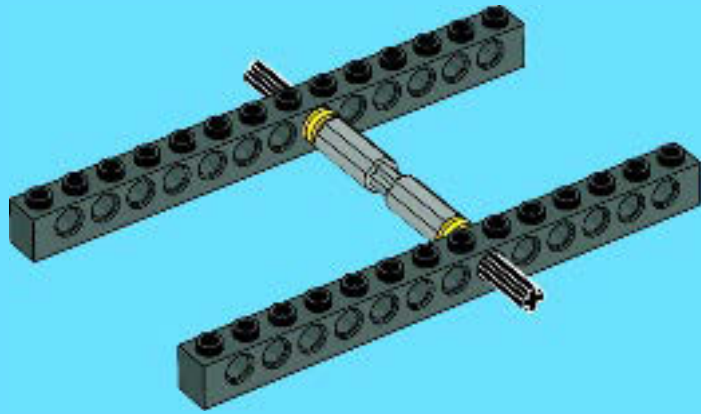

7

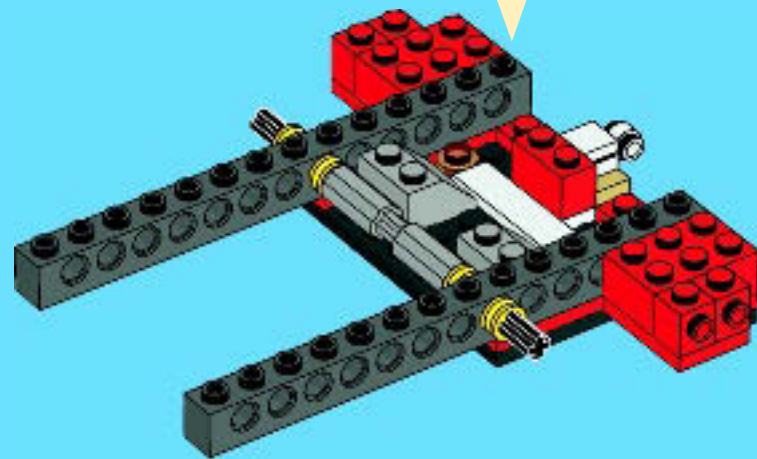
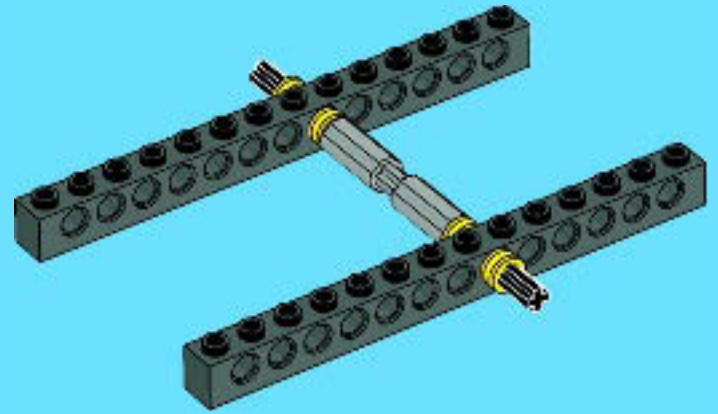



1x



2x

# 8

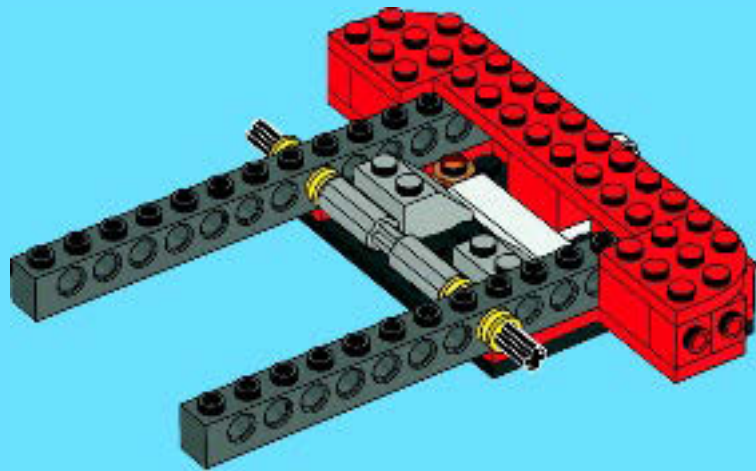

2x



2x



4x

# 9

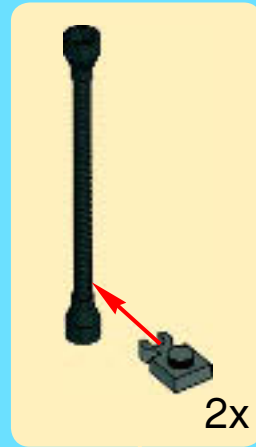

2x

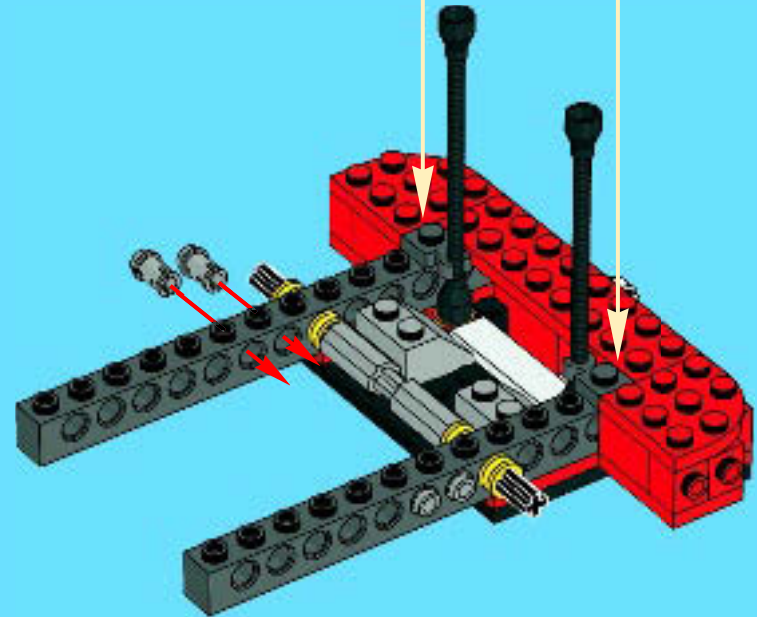



1x



2x

1



2x



2x

2

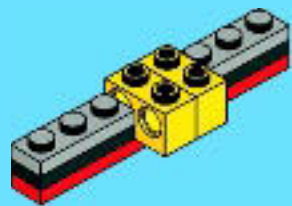

1x



2x



2x

3

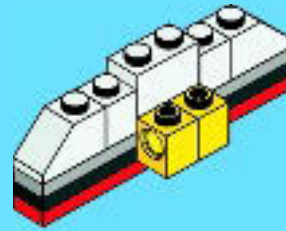

2x

4

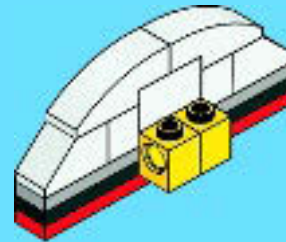



2x

5

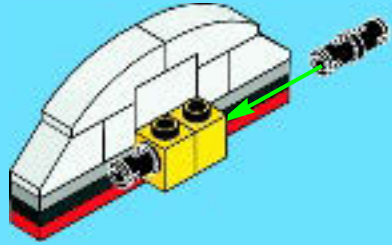

2x



2x

6

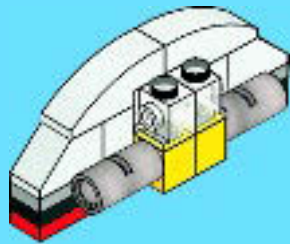

10

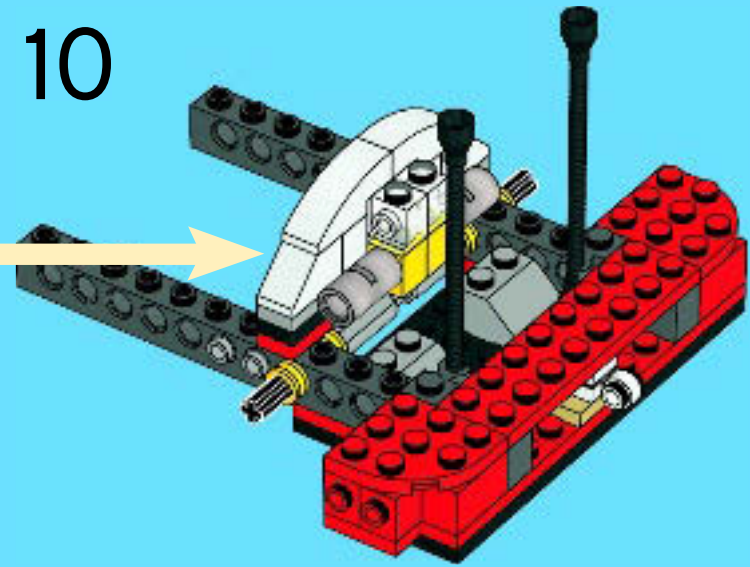

11

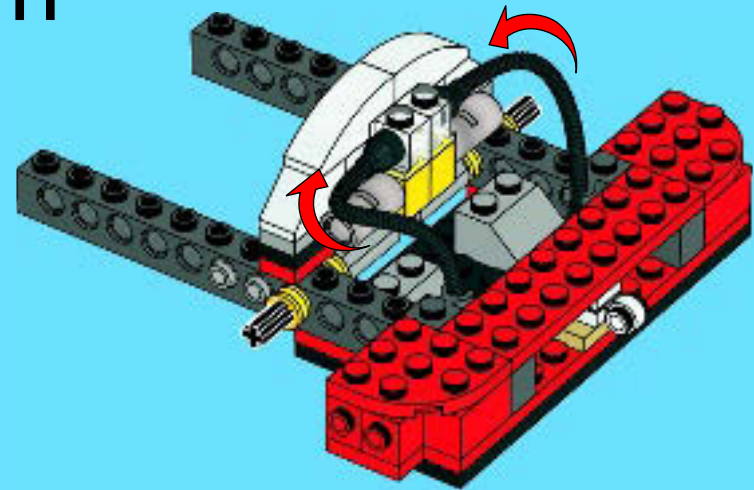





1

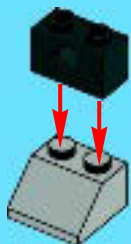

2

1



2



3



4

1



2

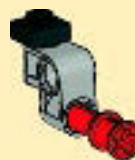

3

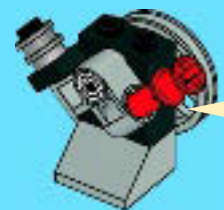



1x



1x

5

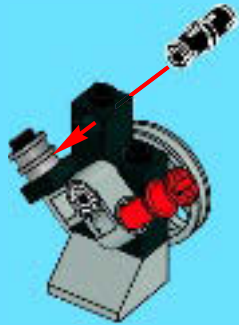

1x



2x

6



1x



1x

7

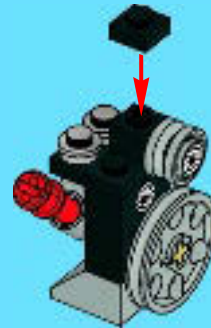

1x

8



12

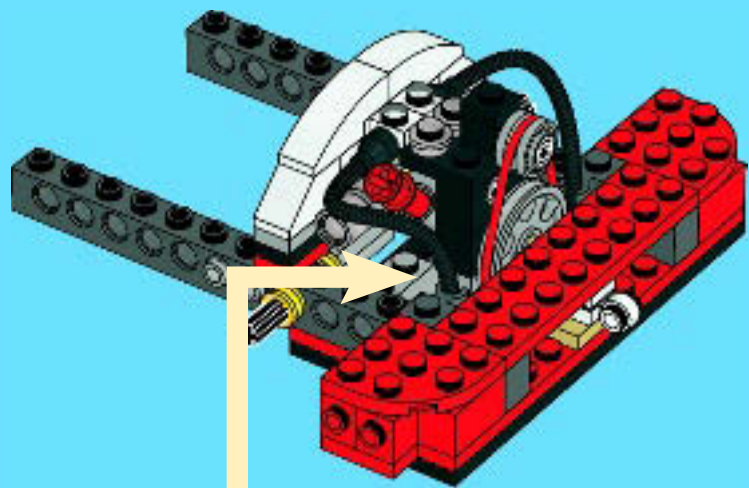

2x

13

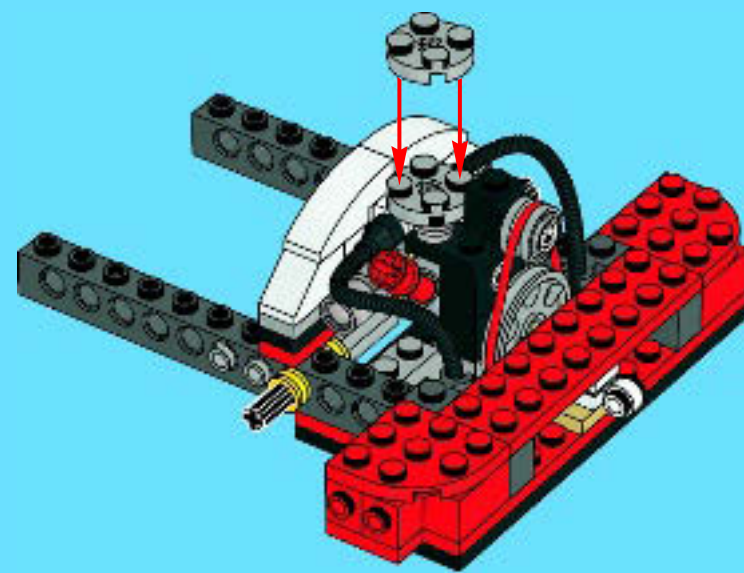

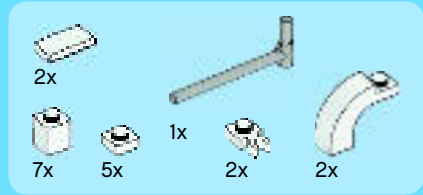

14

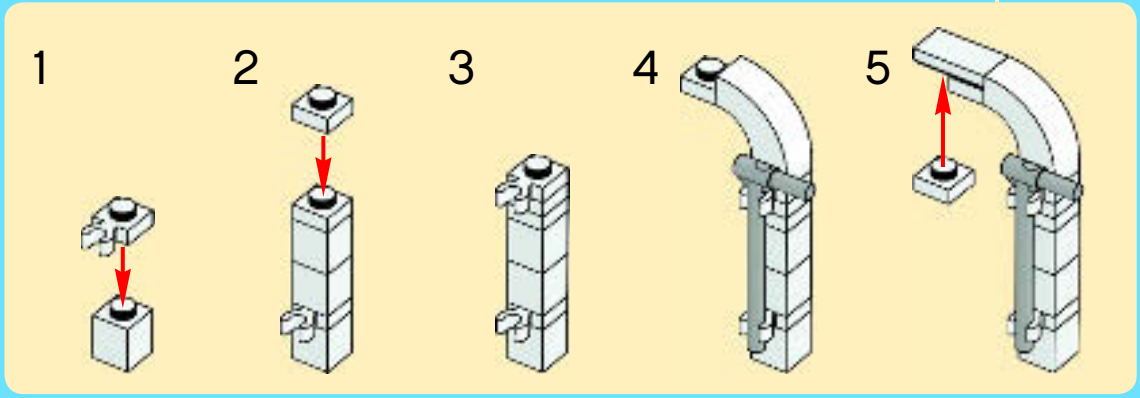
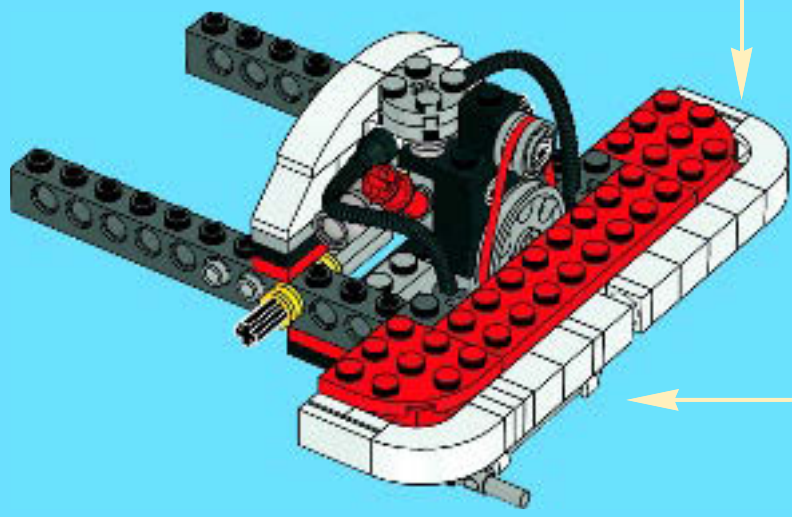
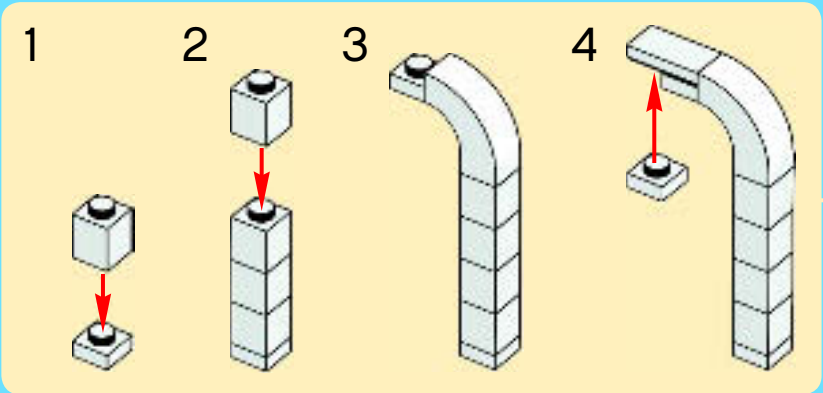

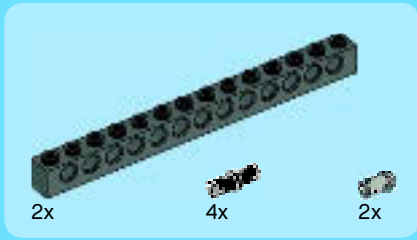

15

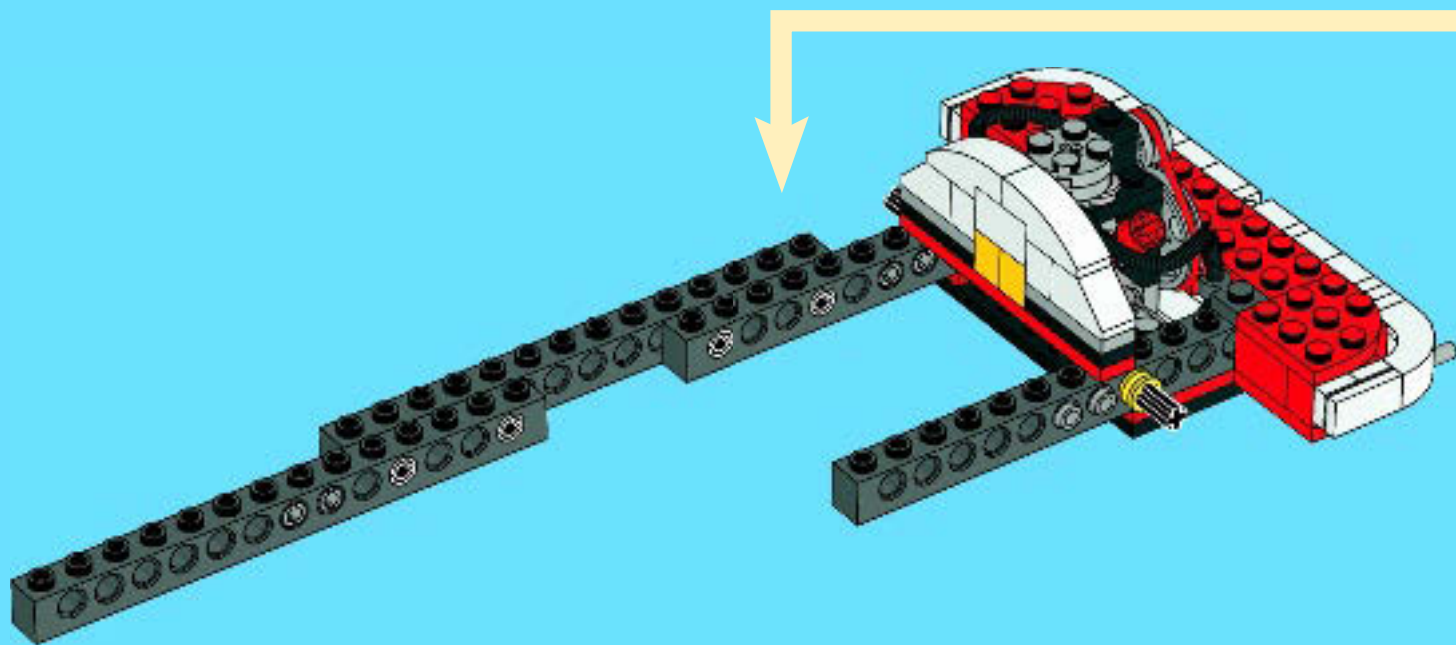
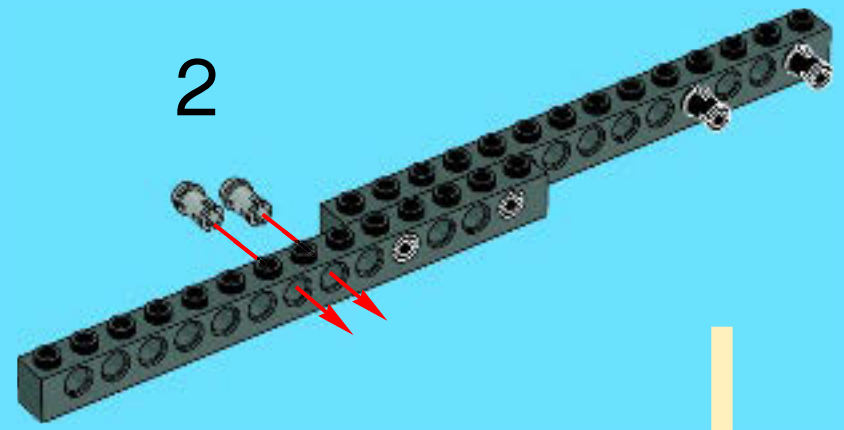
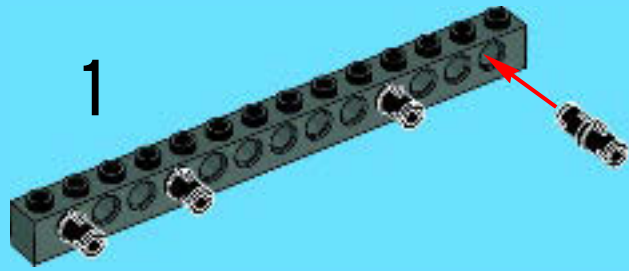



16

1

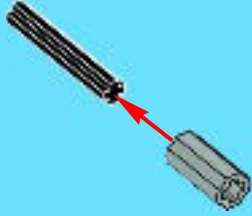

2

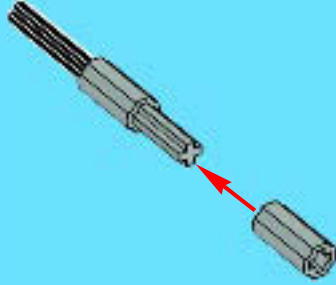

3

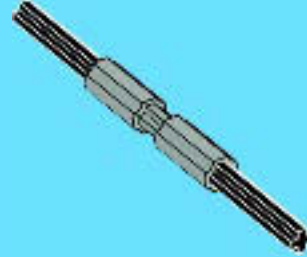

4

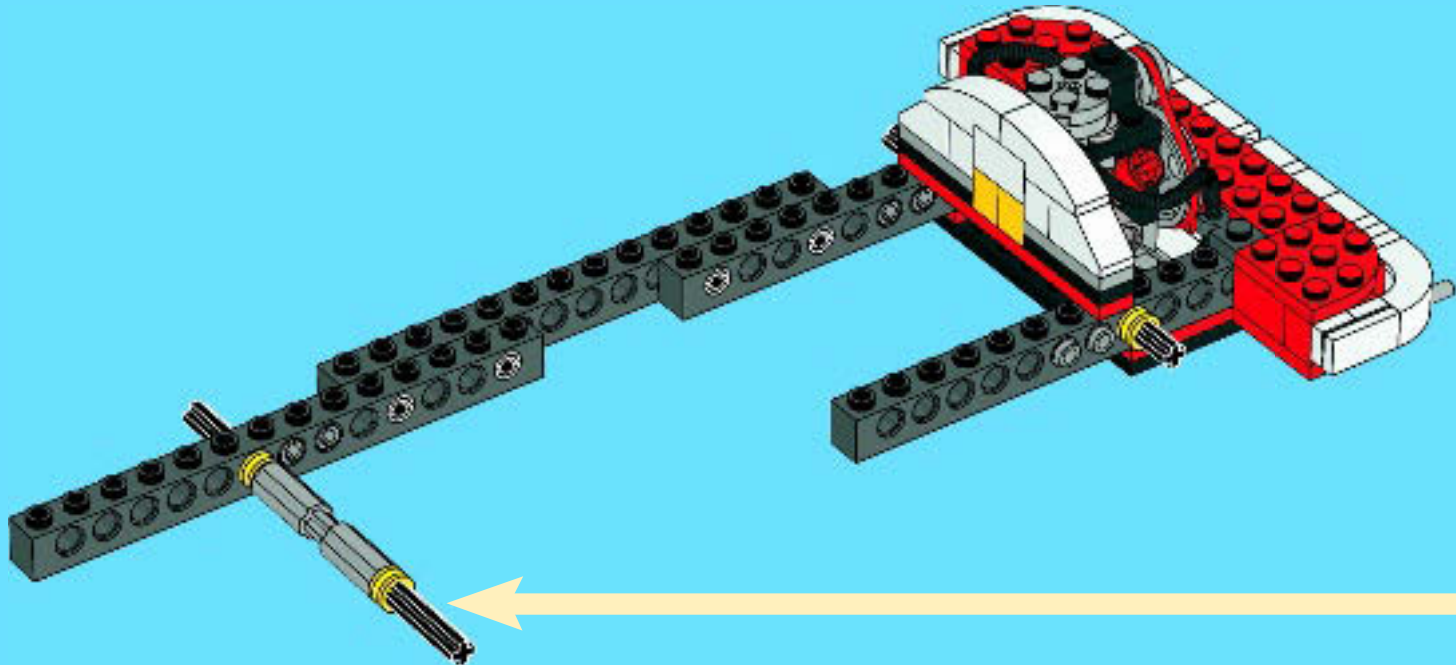
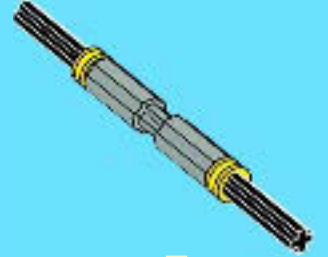

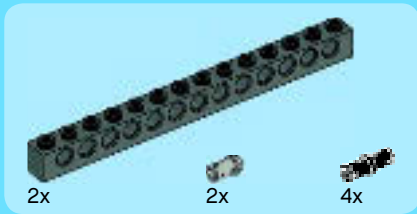

17

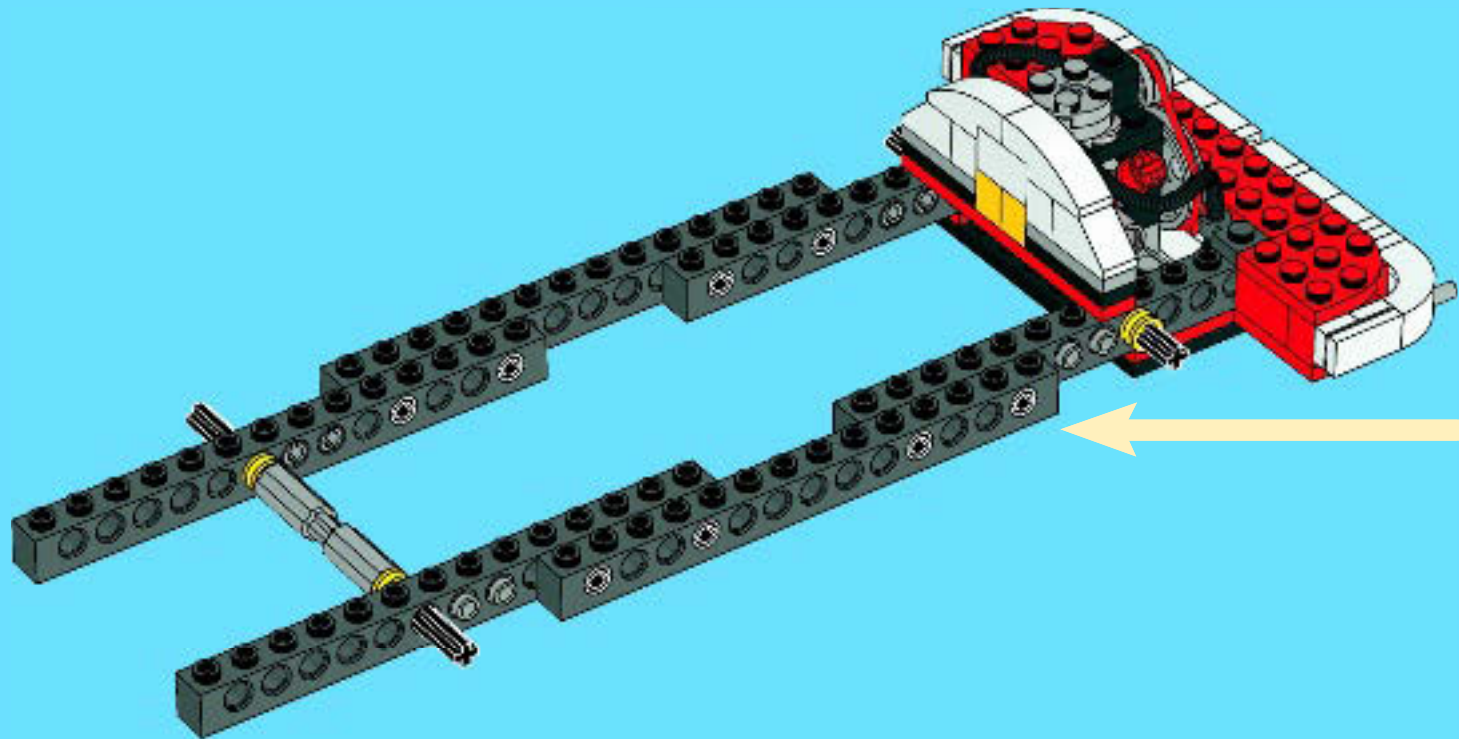
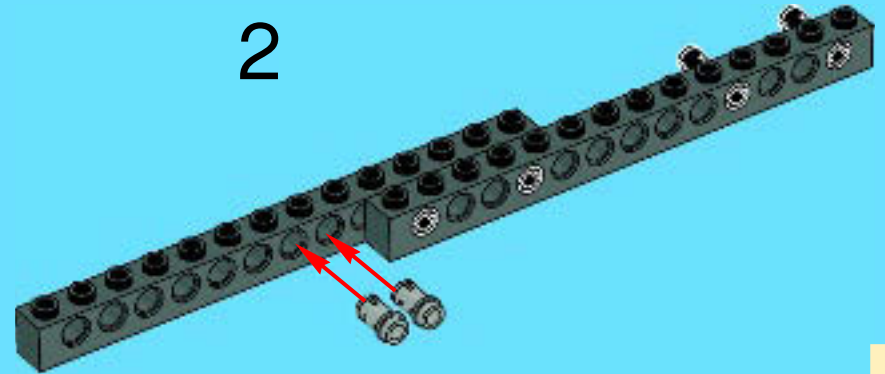



2x

# 18

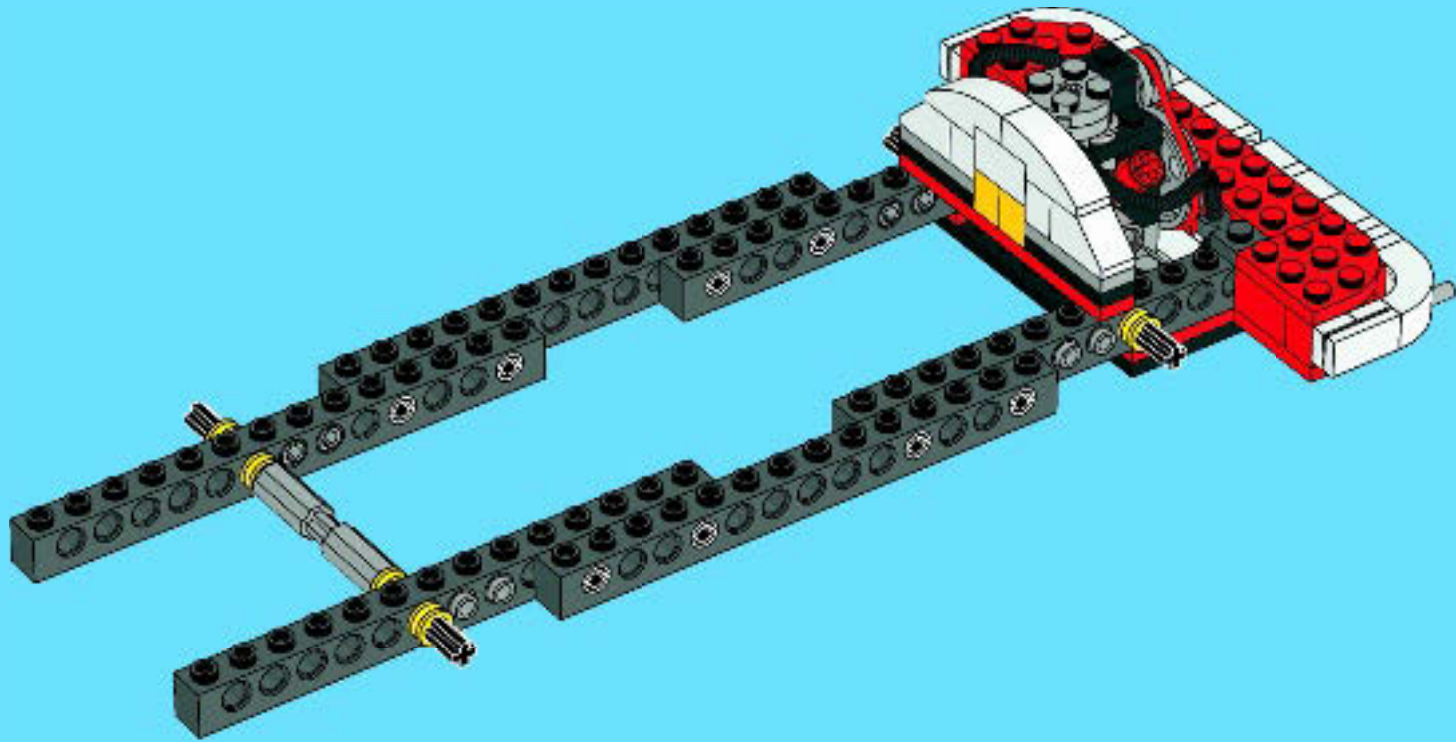



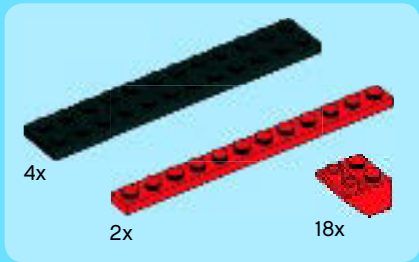

19

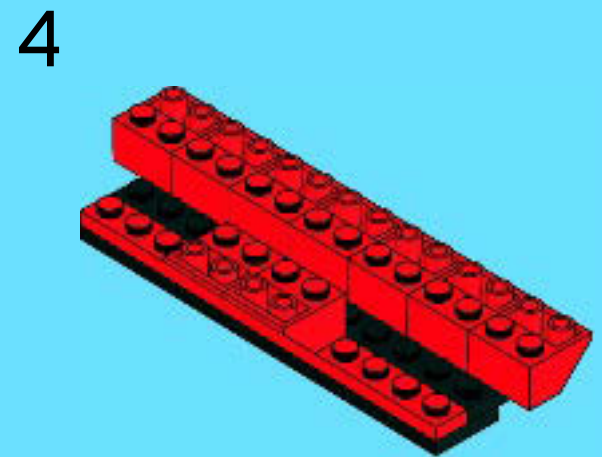
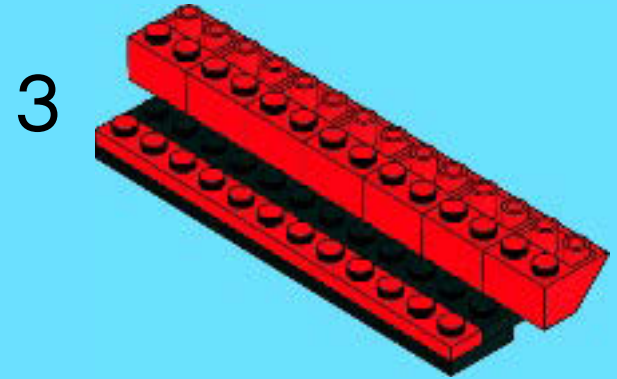
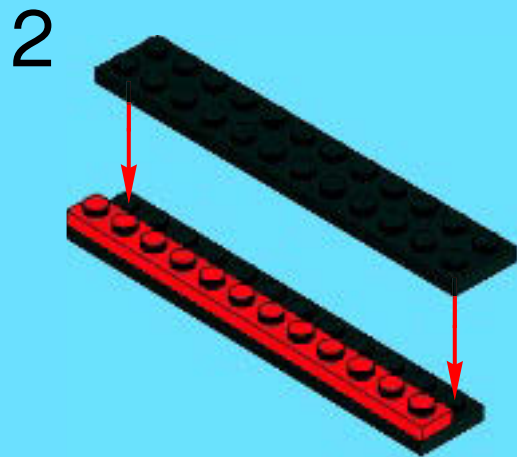
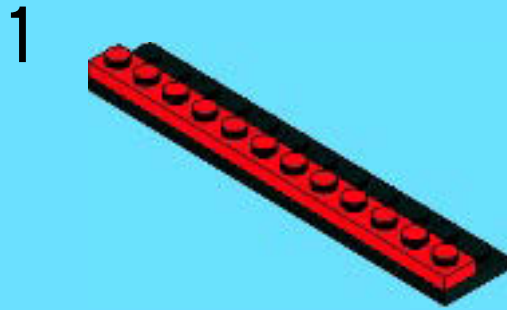

2x

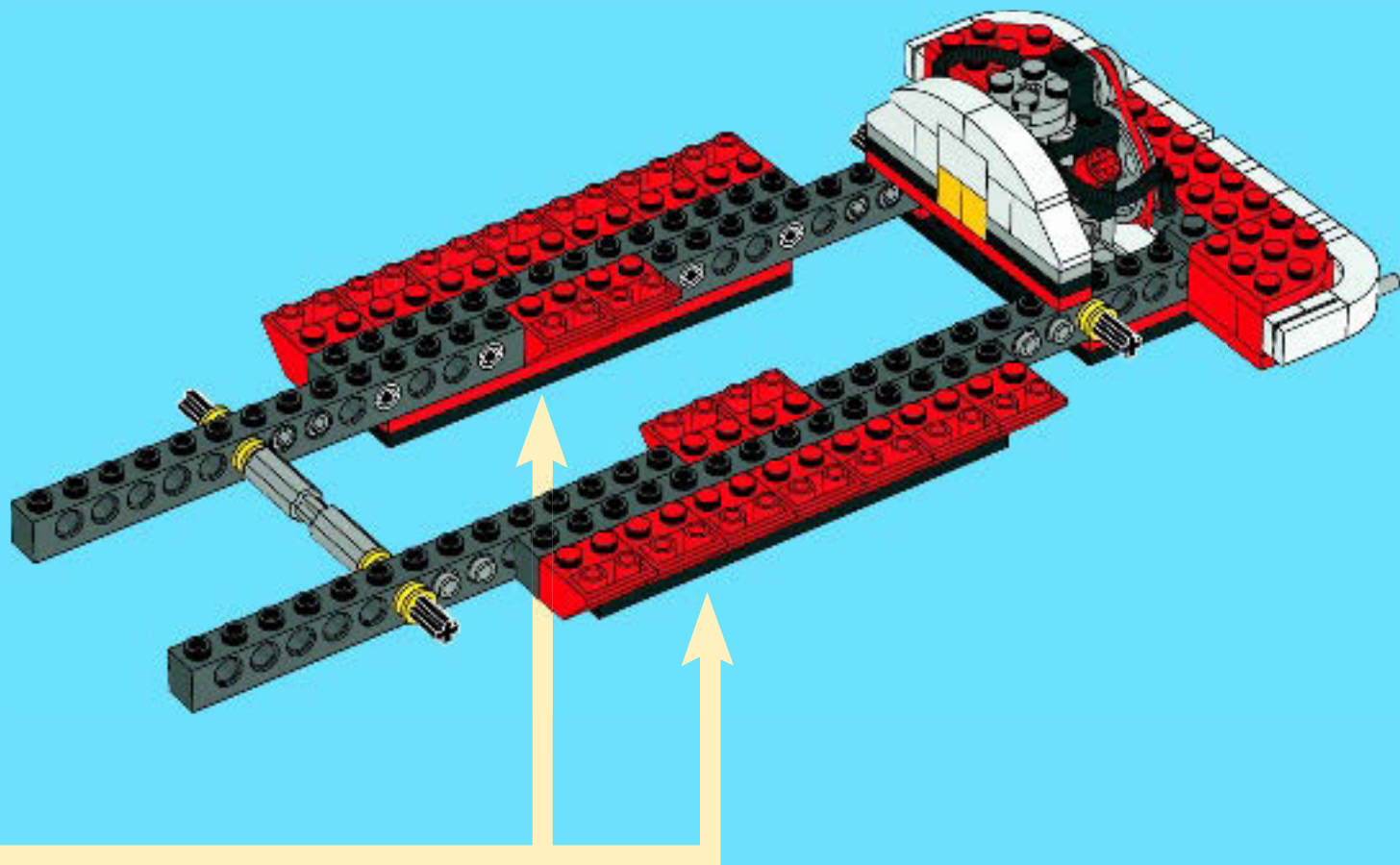



3x

20

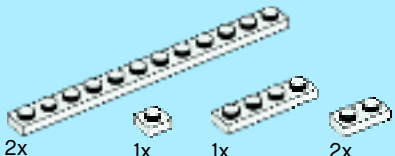
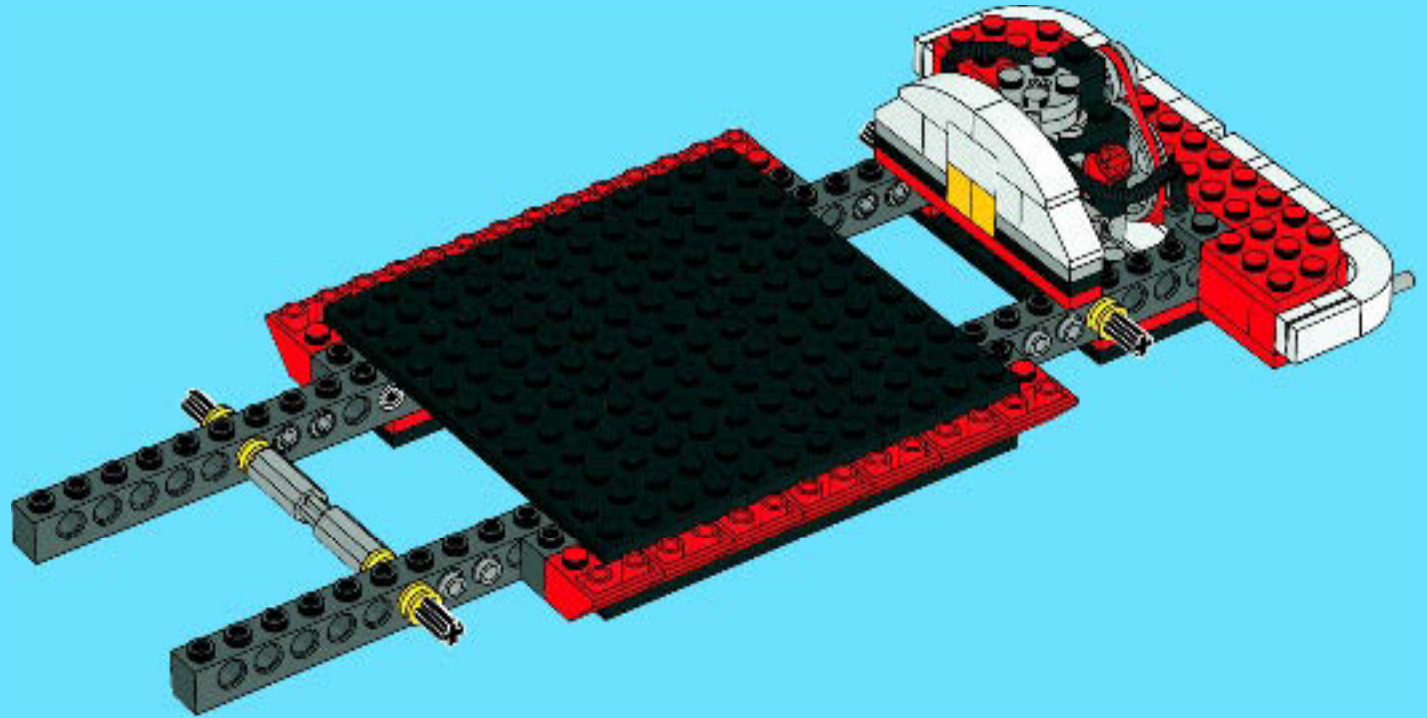

21

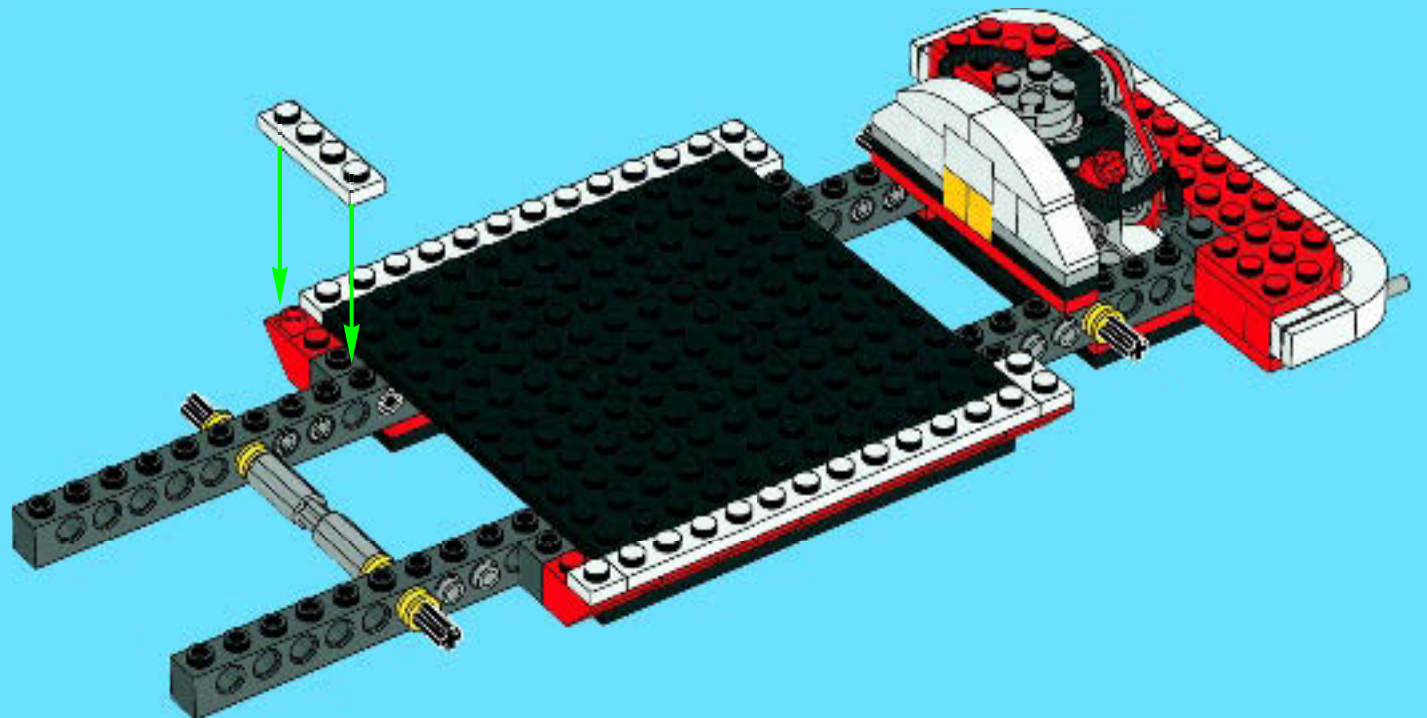

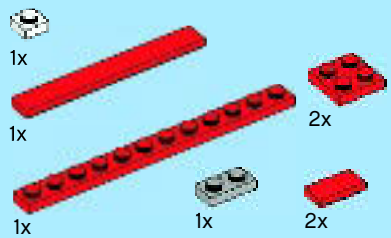

22

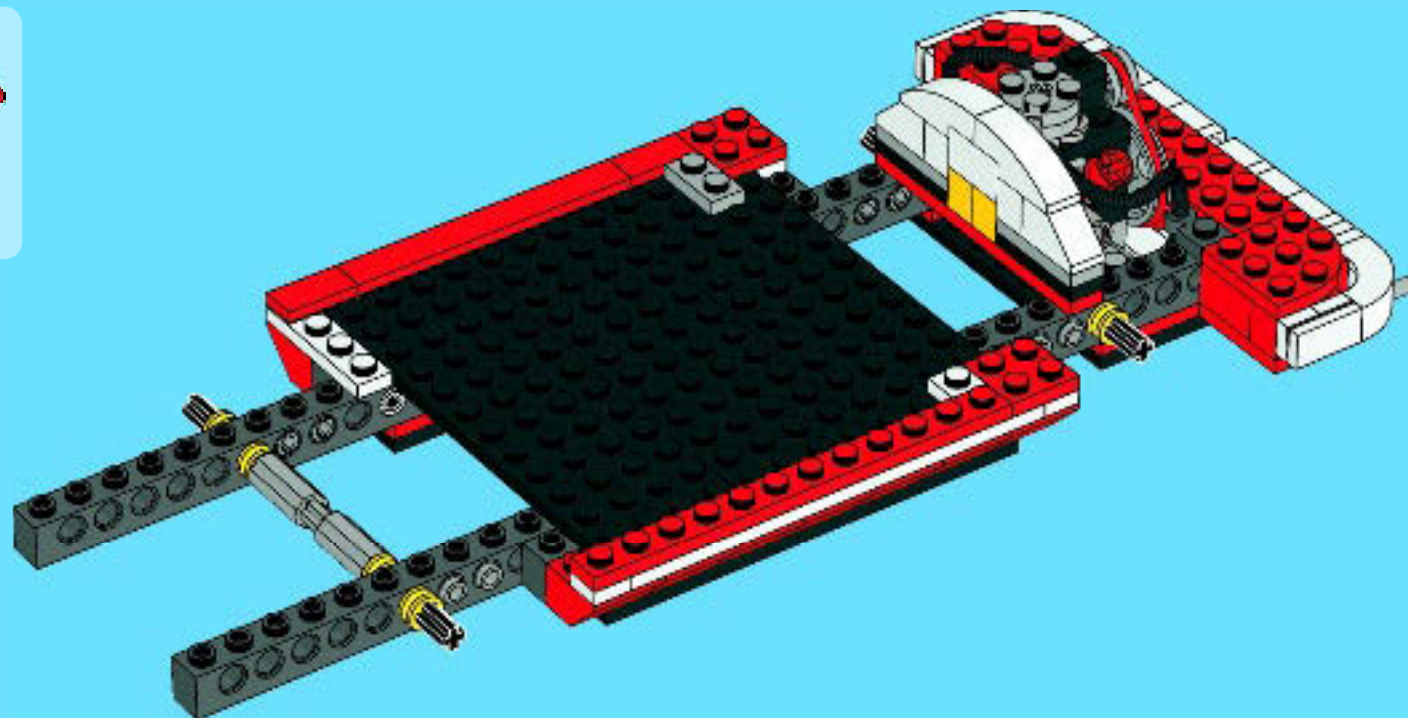

23

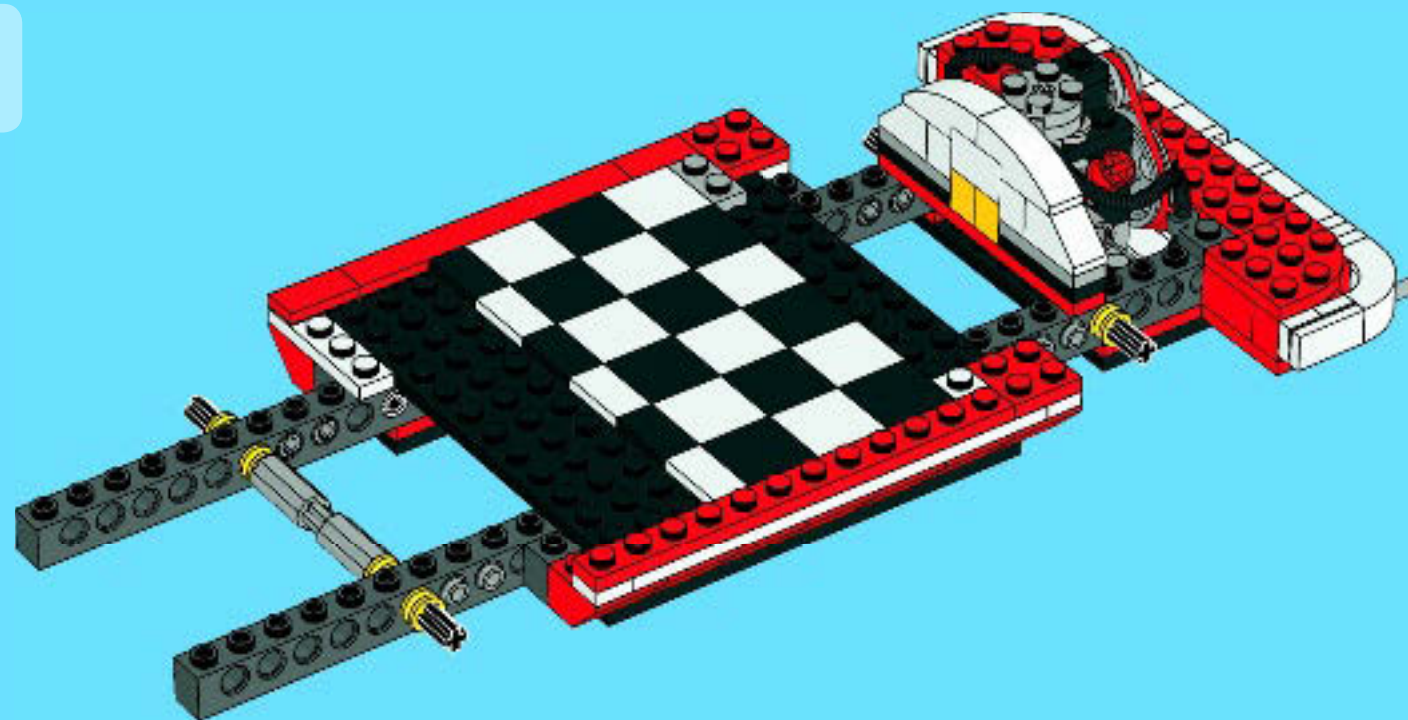

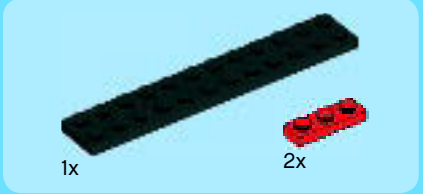
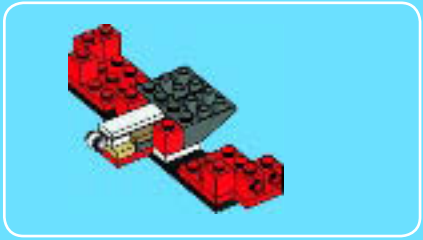

1



2

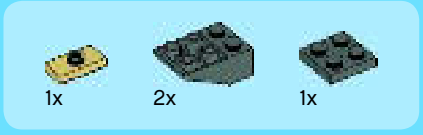
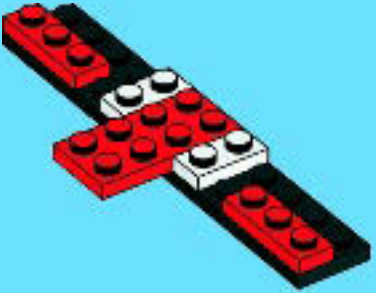

3

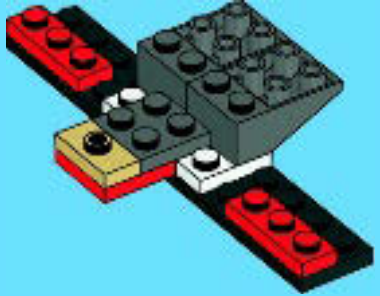

4

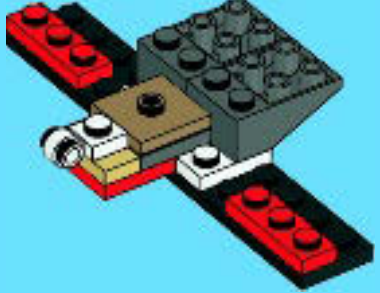



2x



4x

5

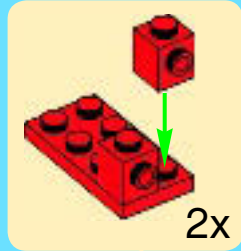

2x

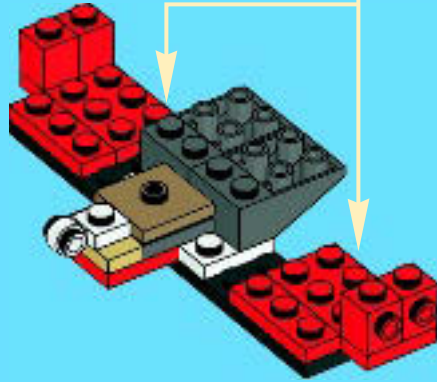

4x



1x

6

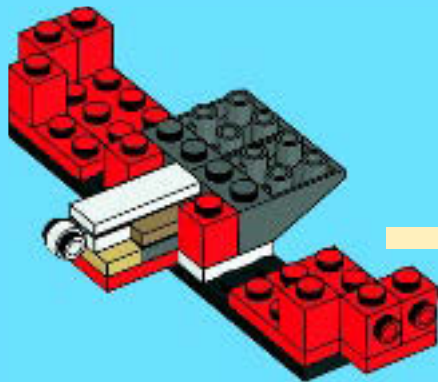

24

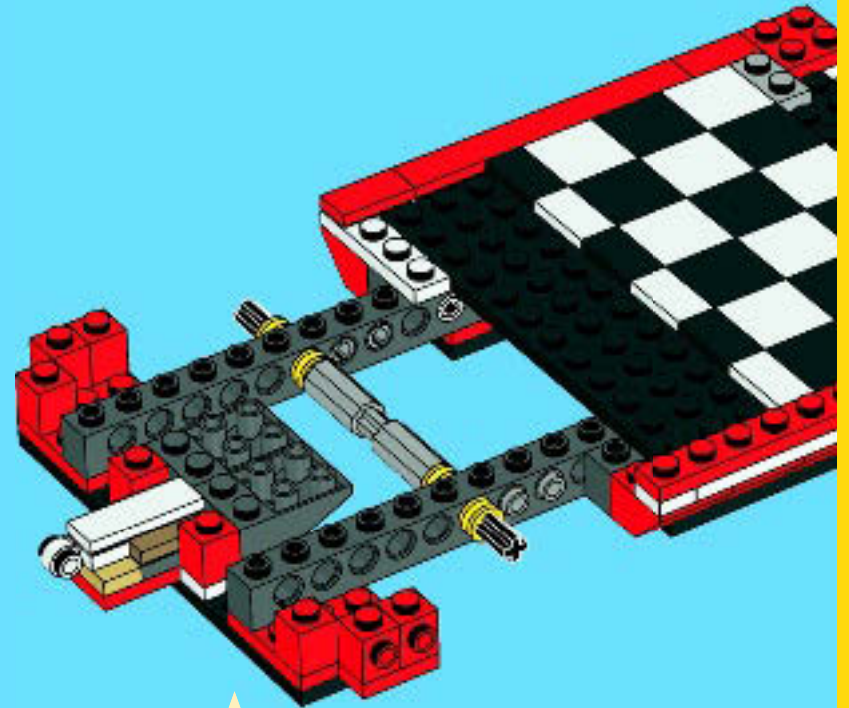

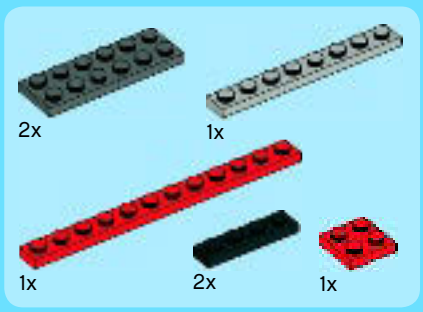

25

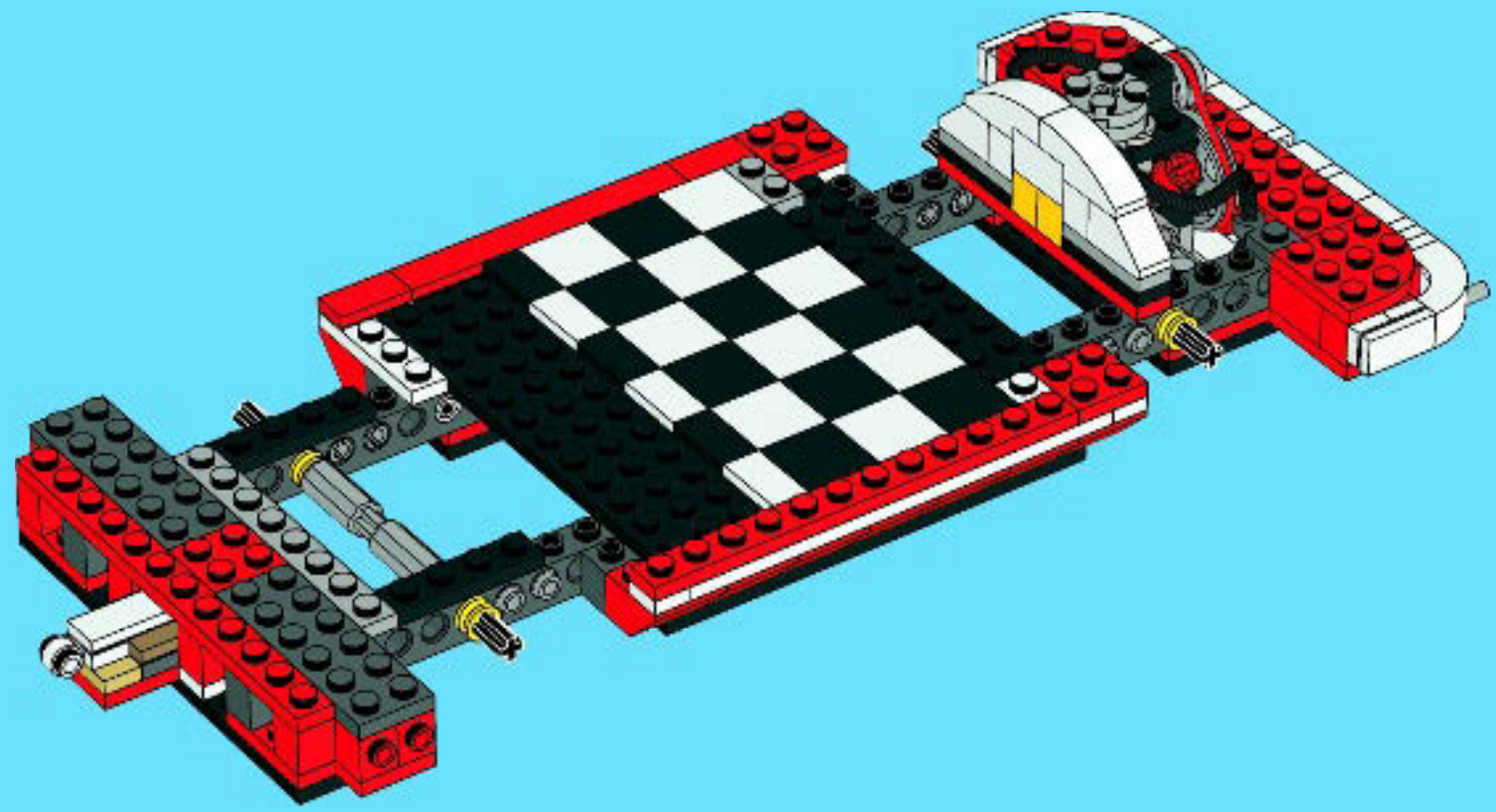

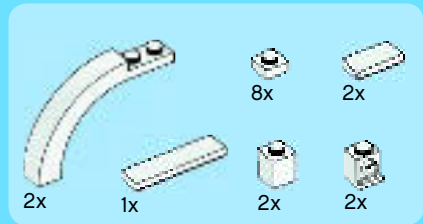

26

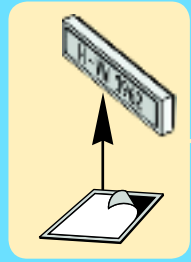
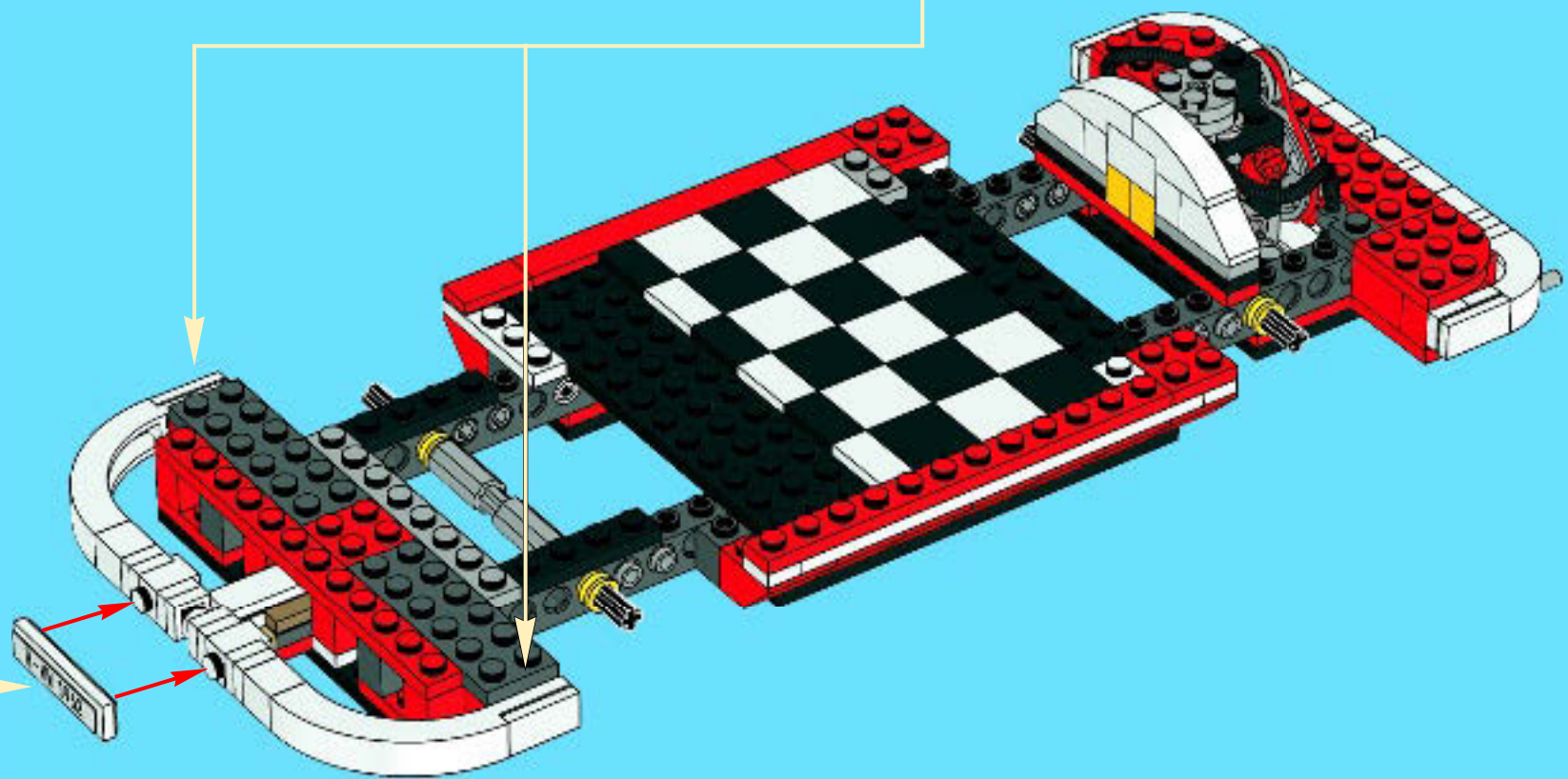
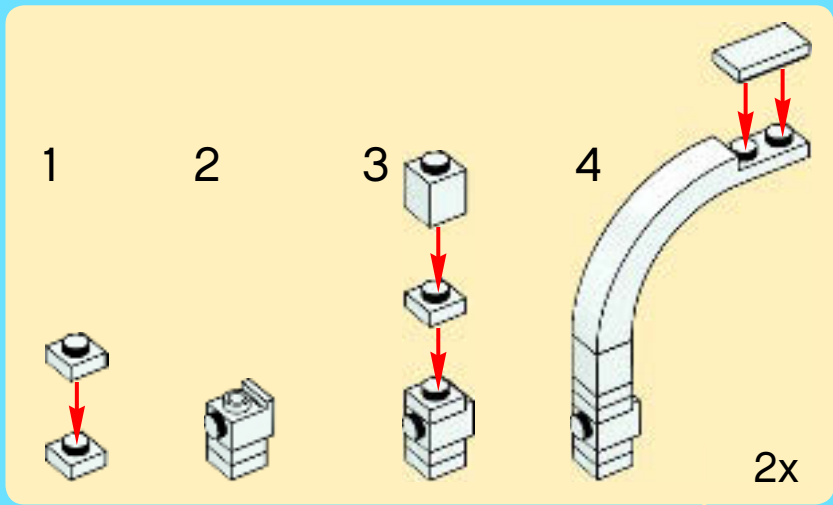



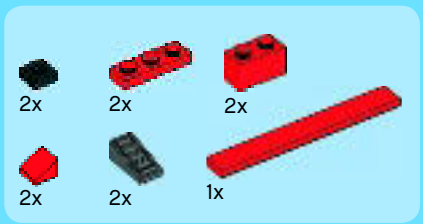

27

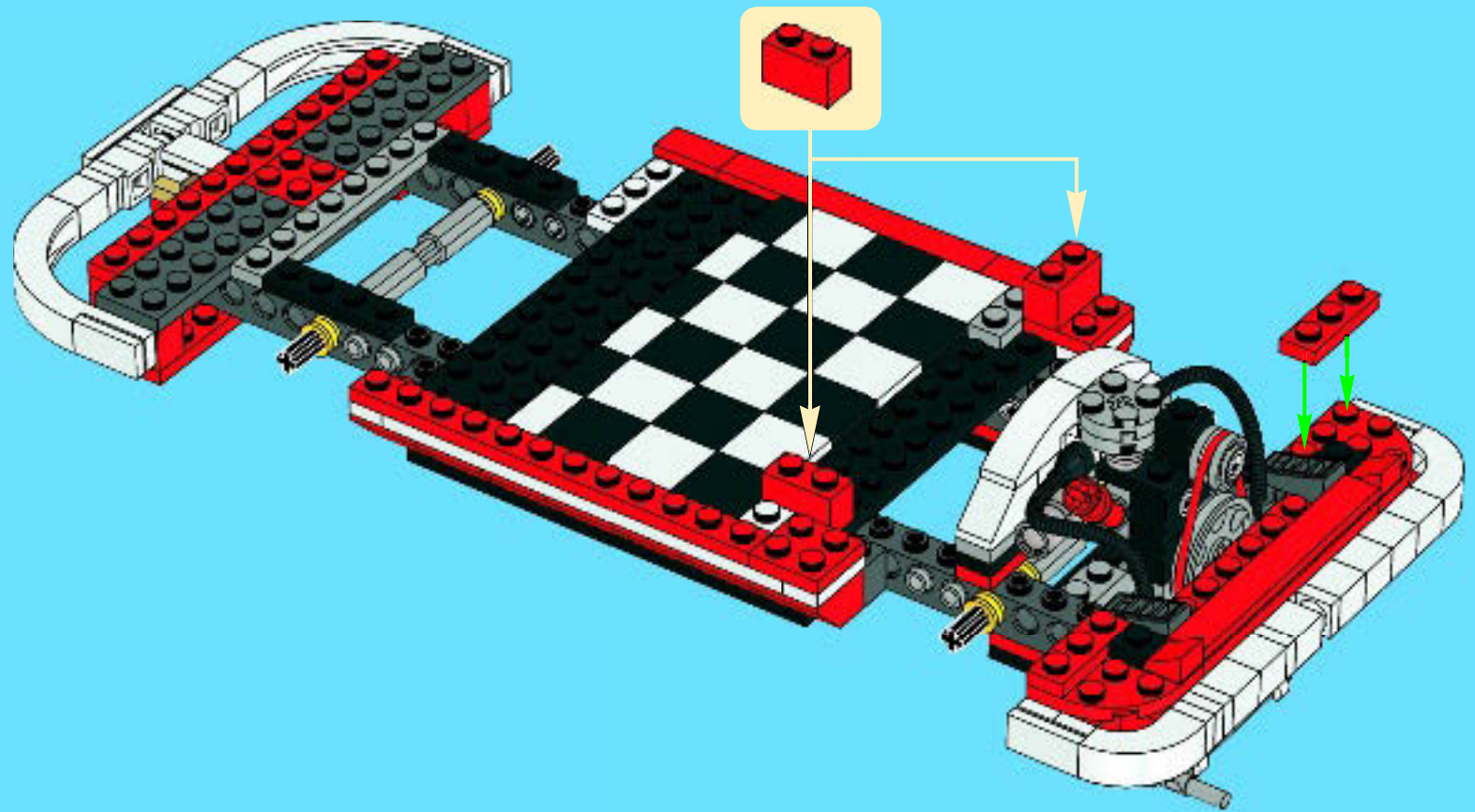

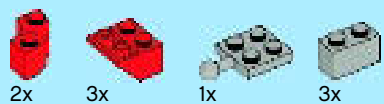

28

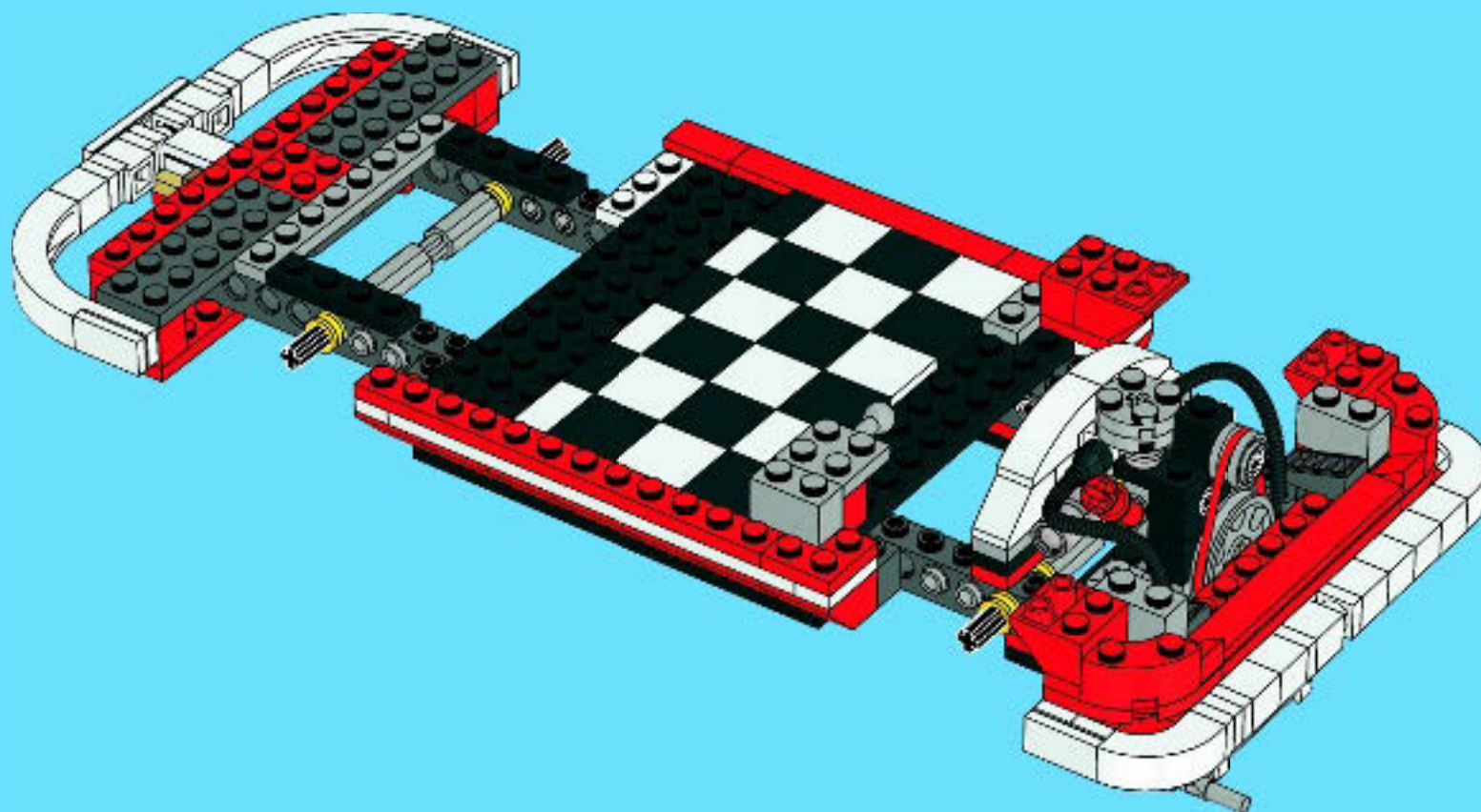

- 1x
- 2x
- 1x
- 1x
- 2x
- 2x

29

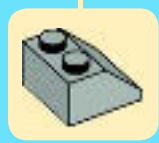
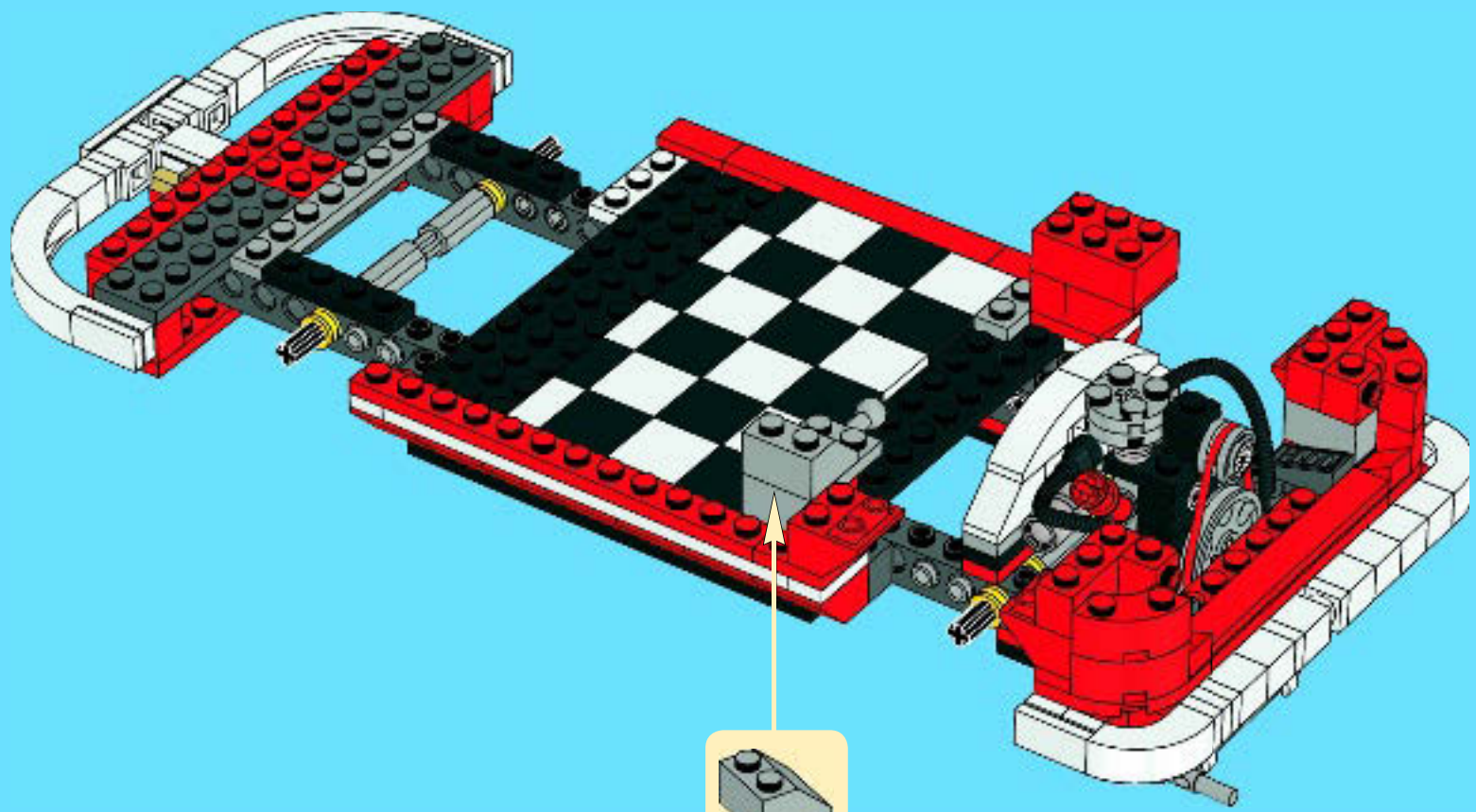



2x



2x



3x



2x

# 30

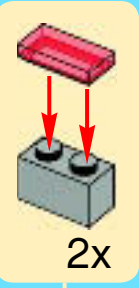
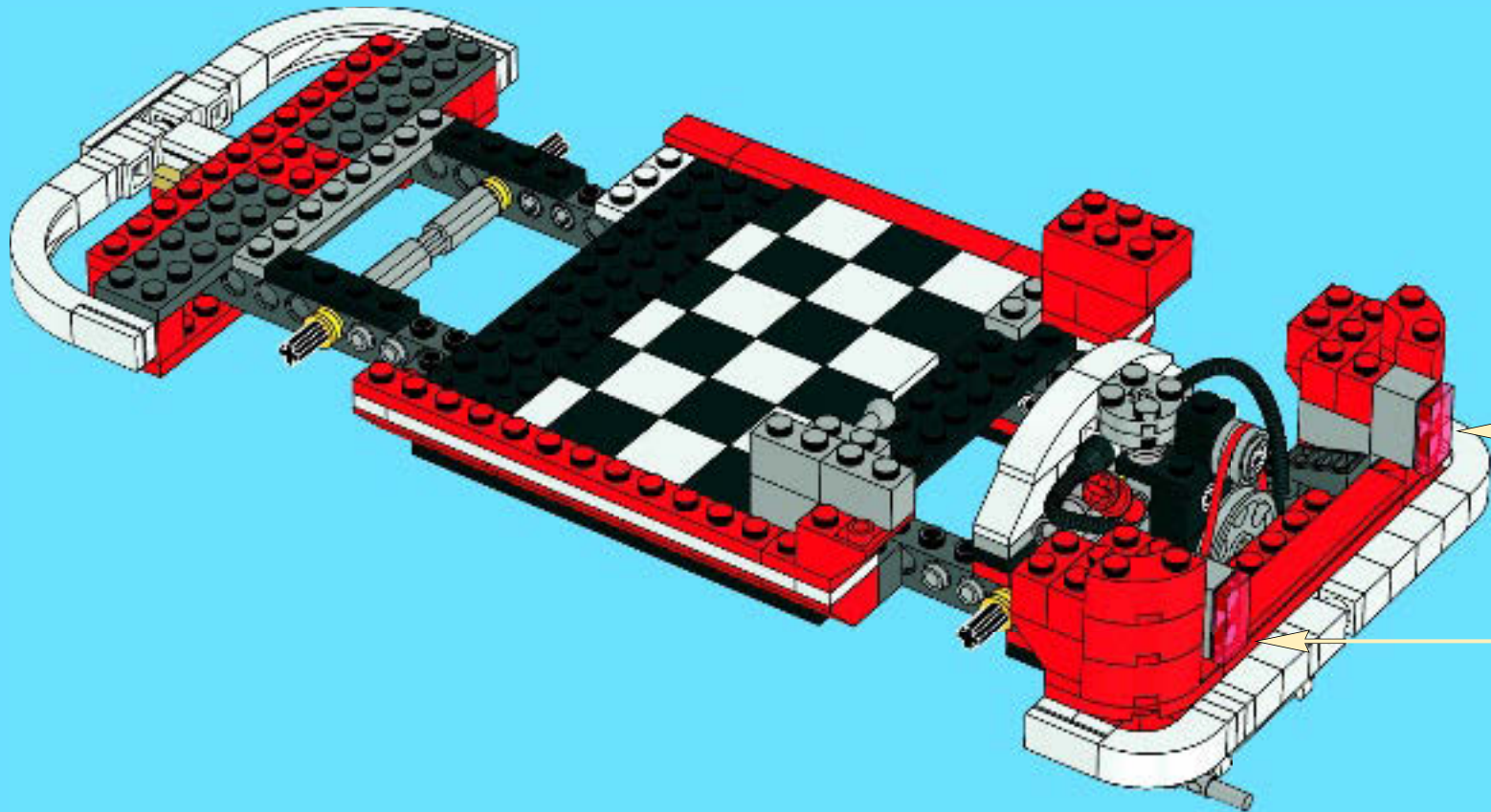

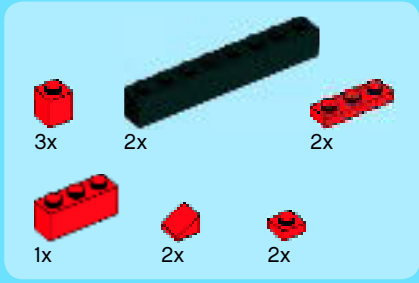

31

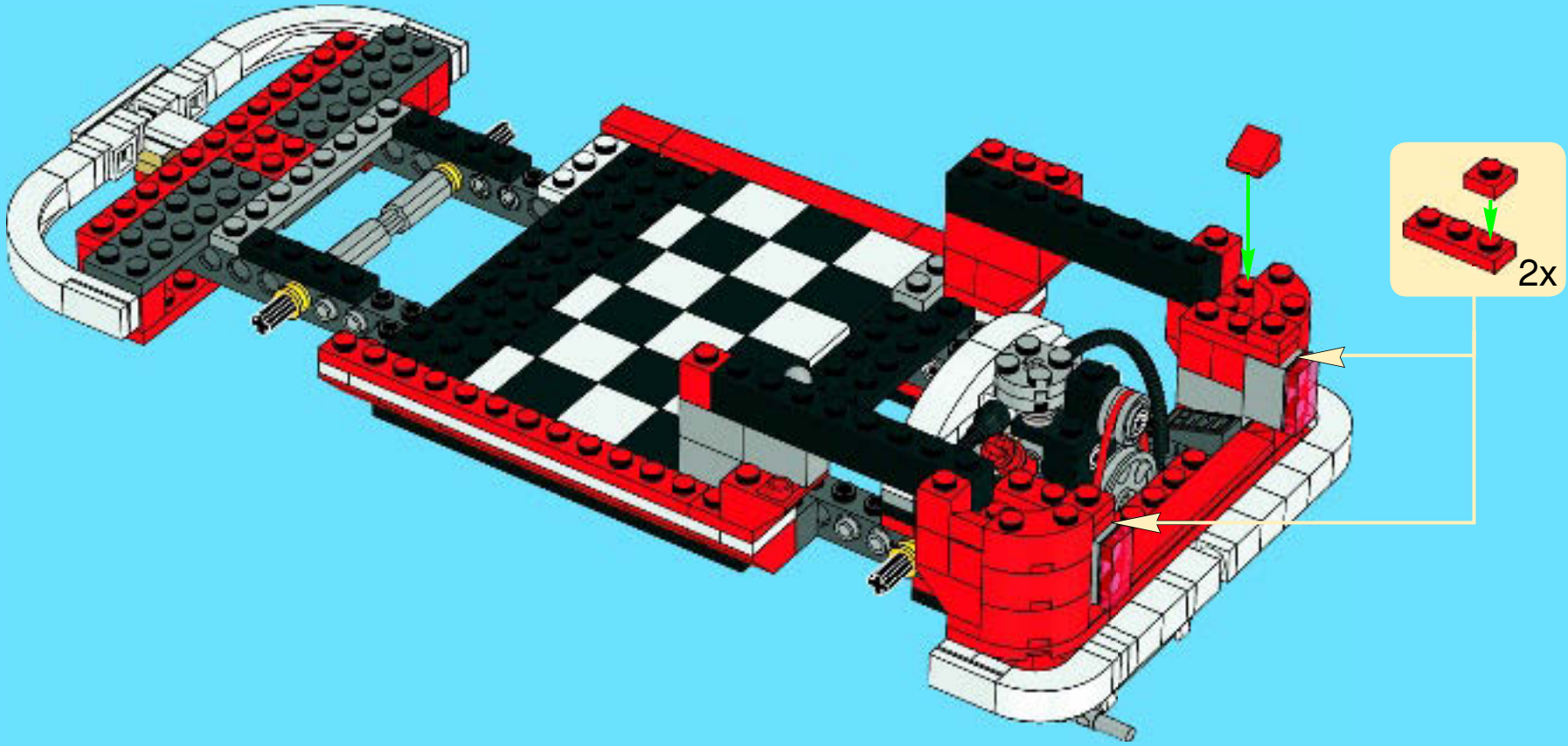

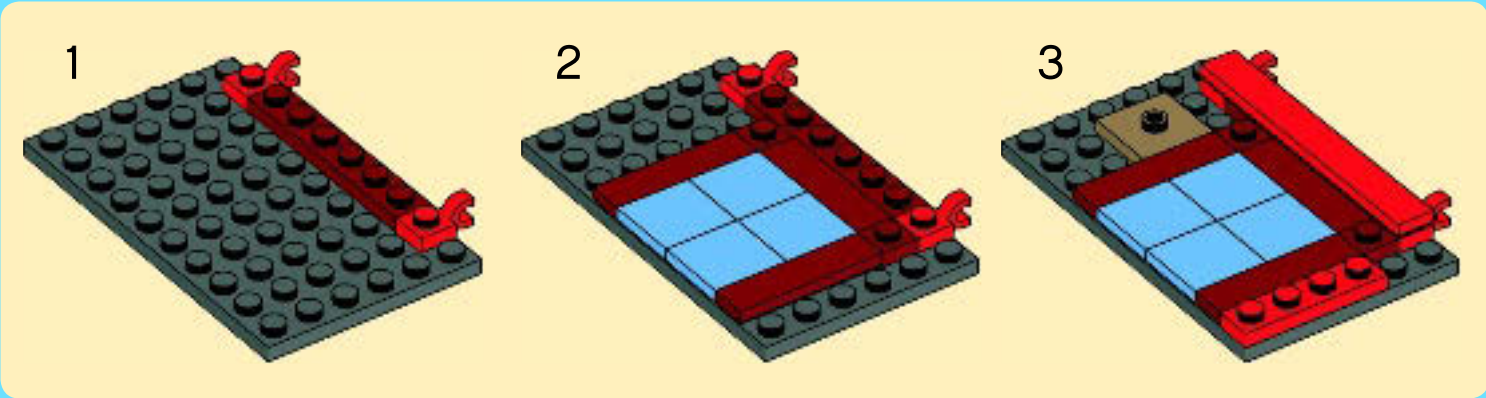
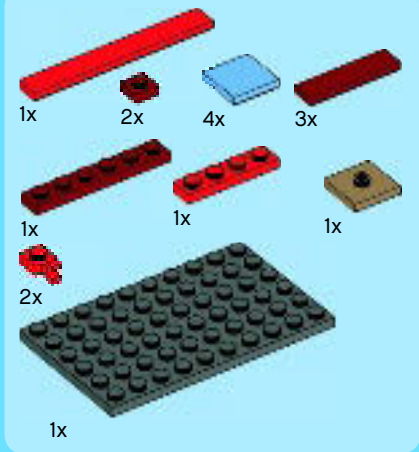

32

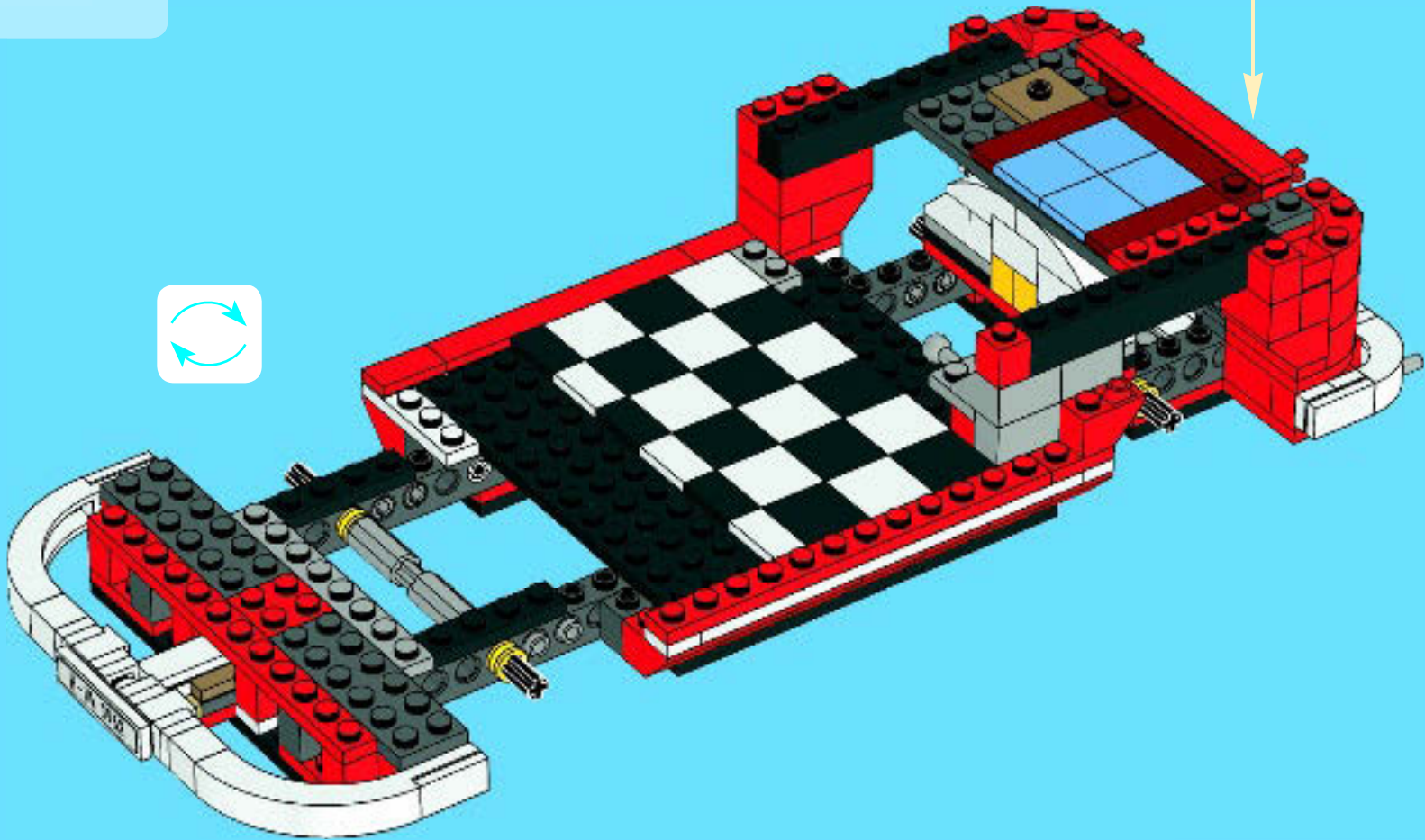

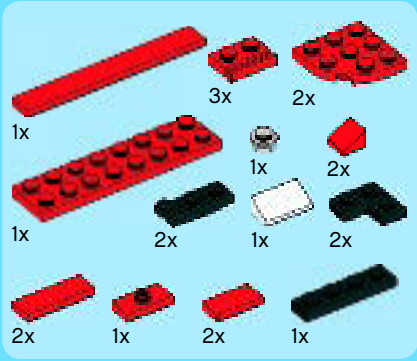

# 33

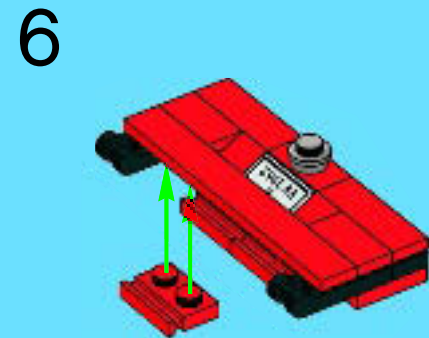
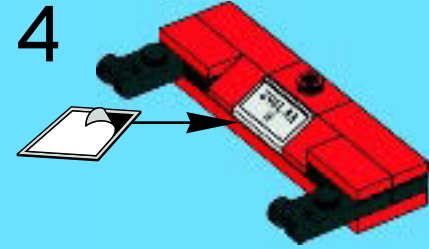
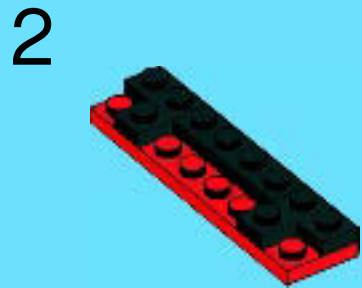

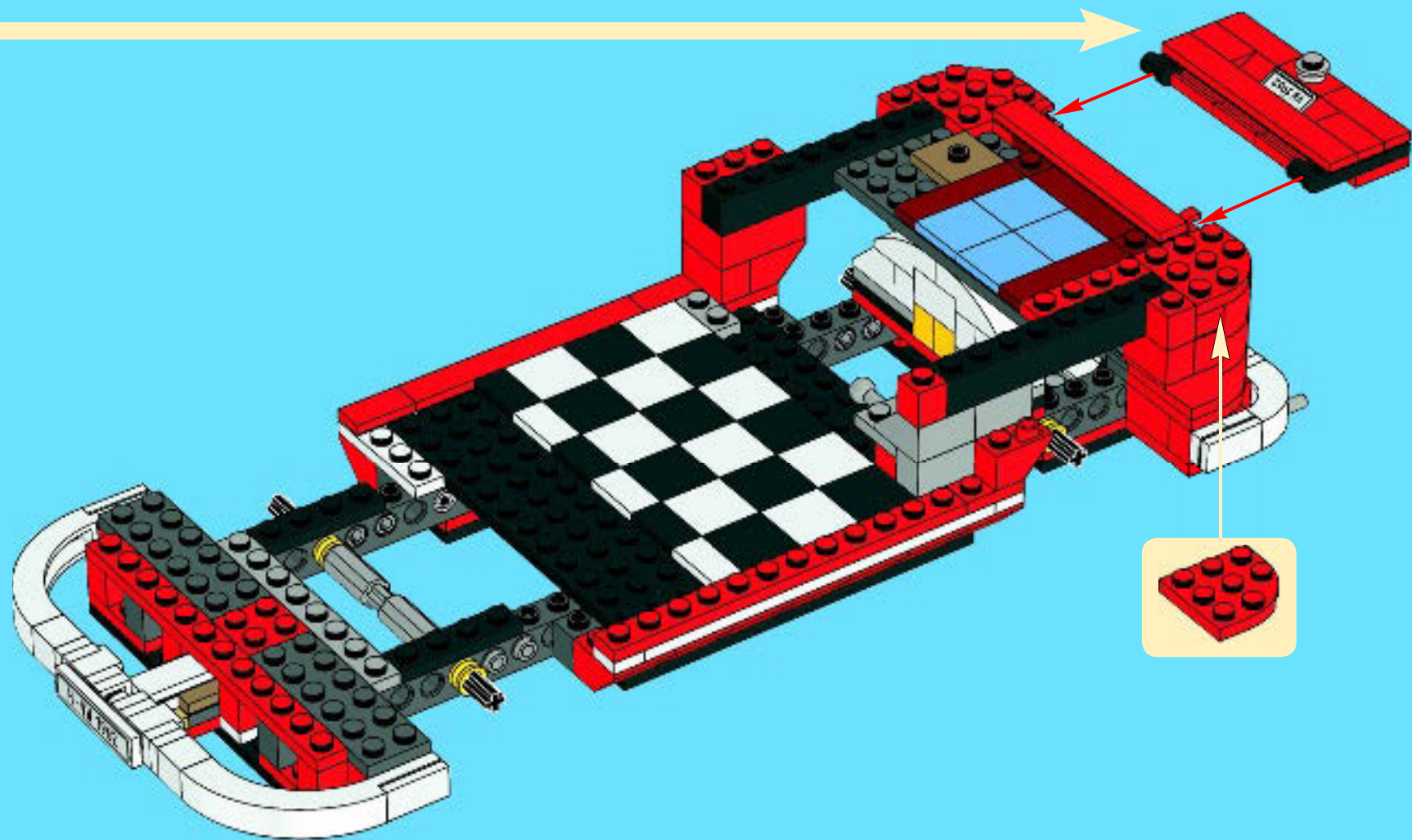



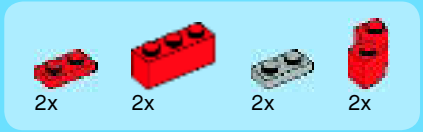

34

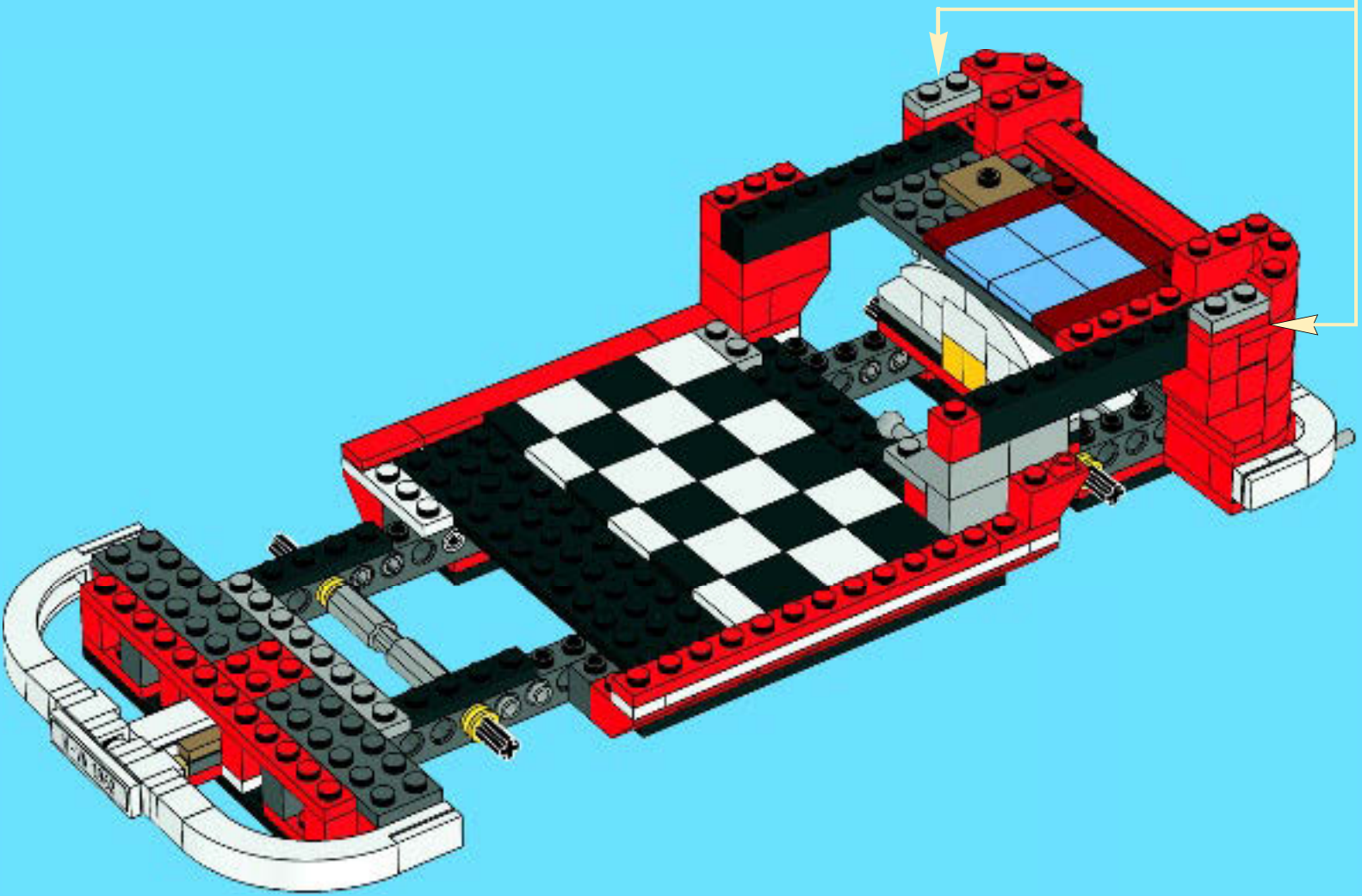
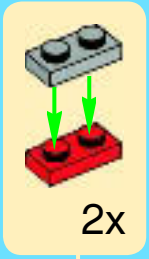

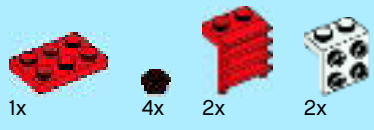

35

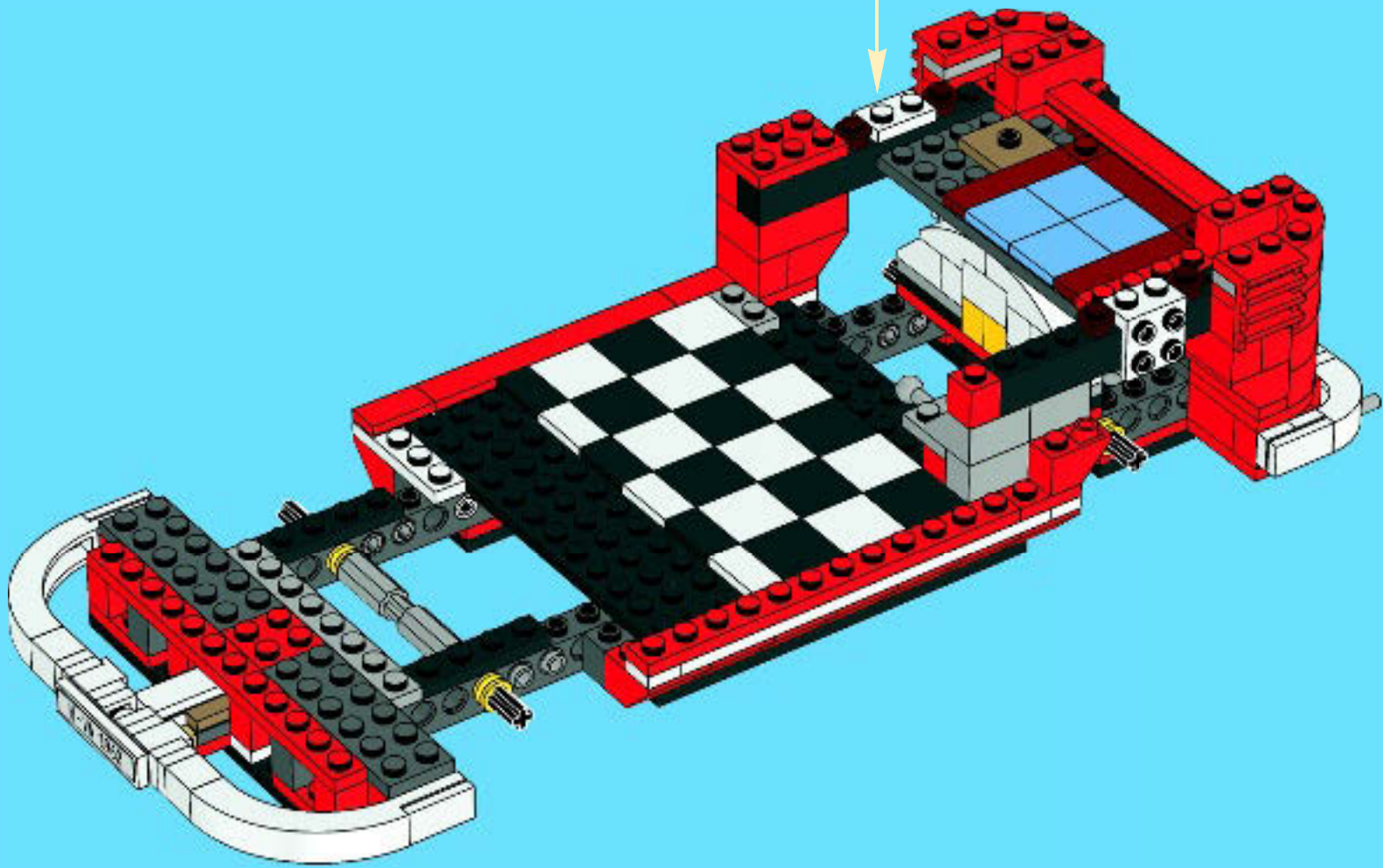

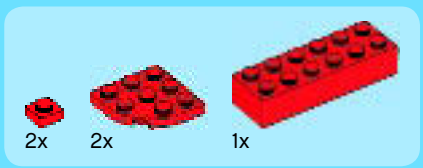

36

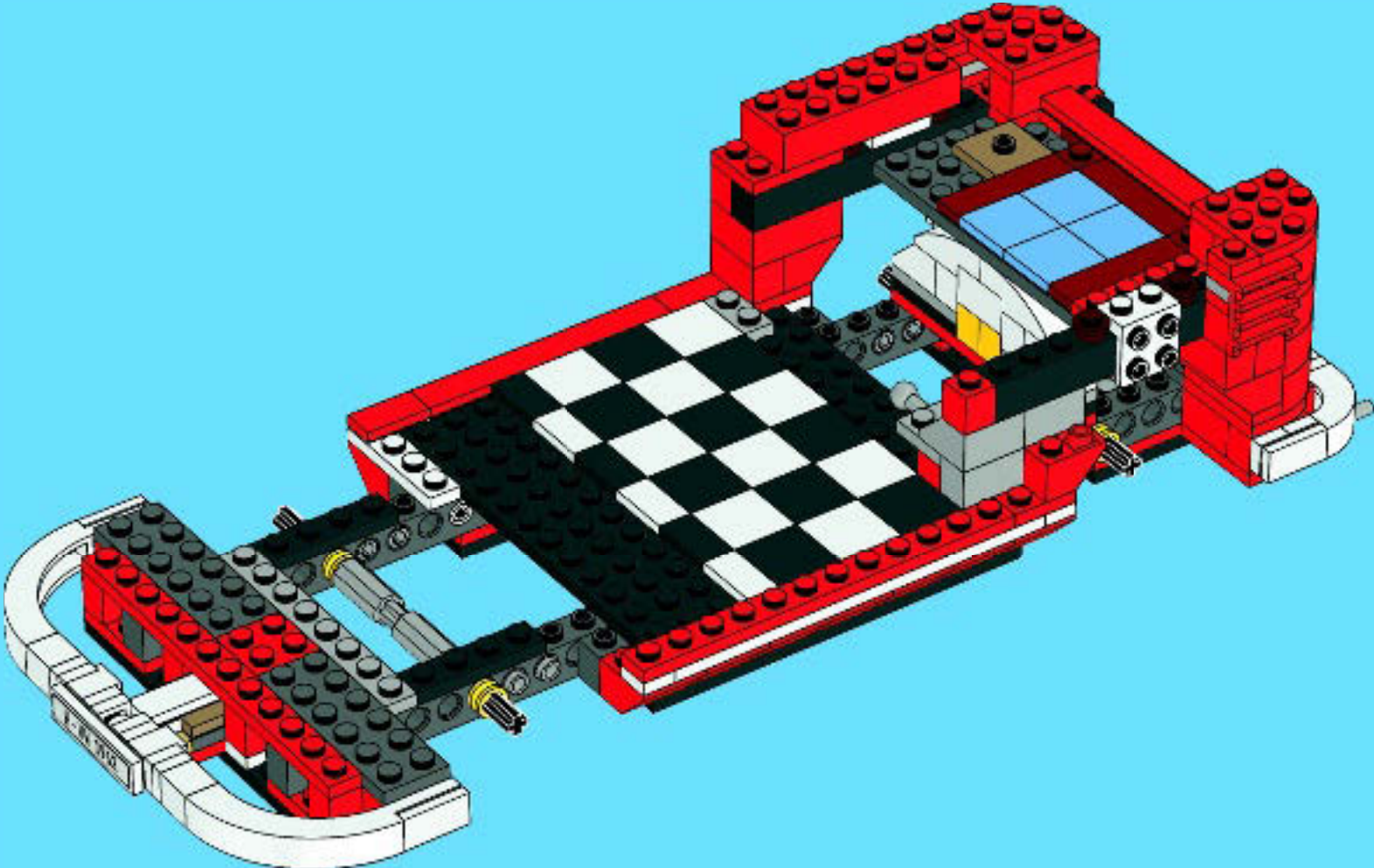

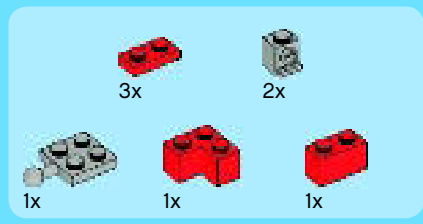

37

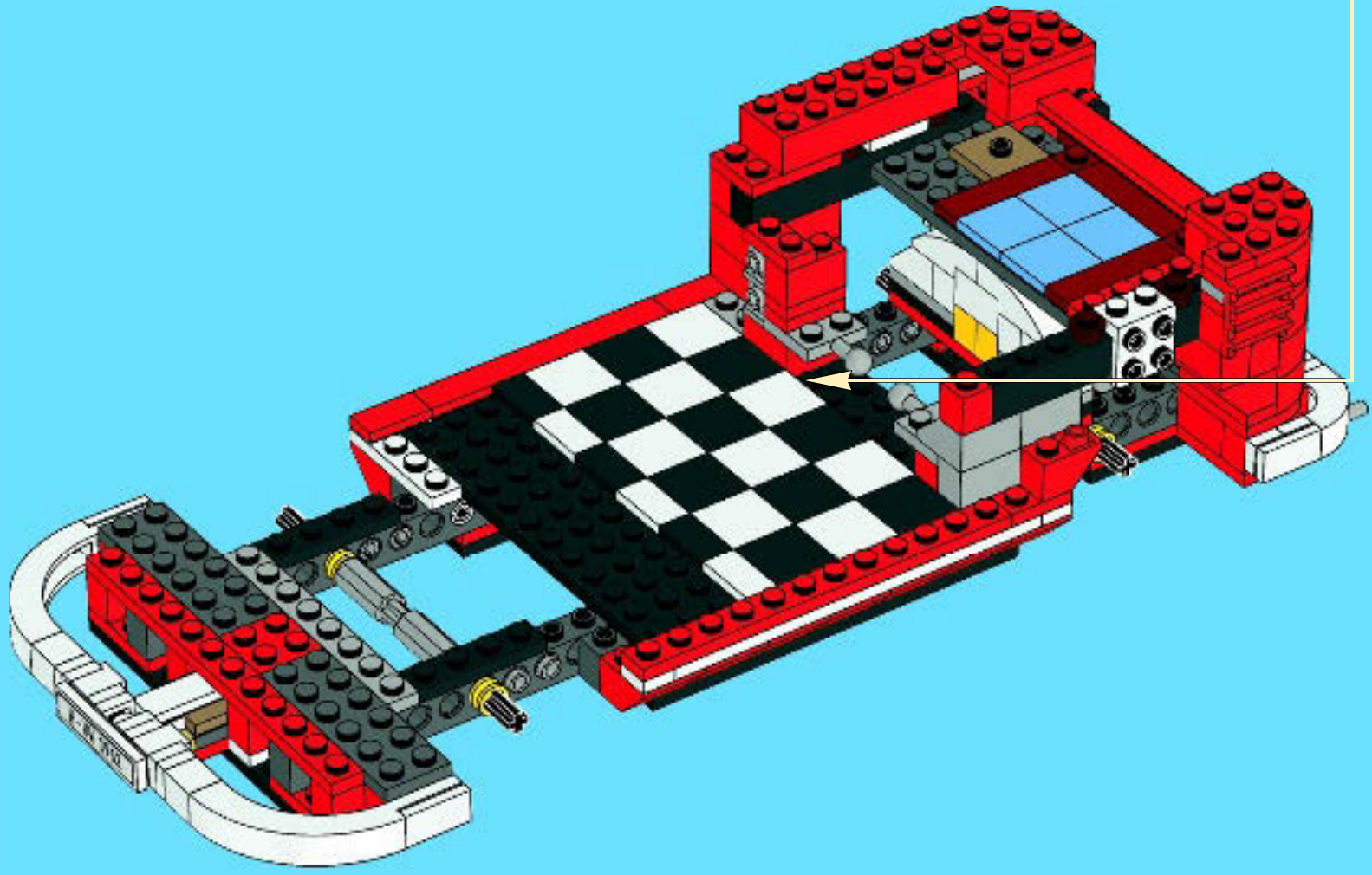
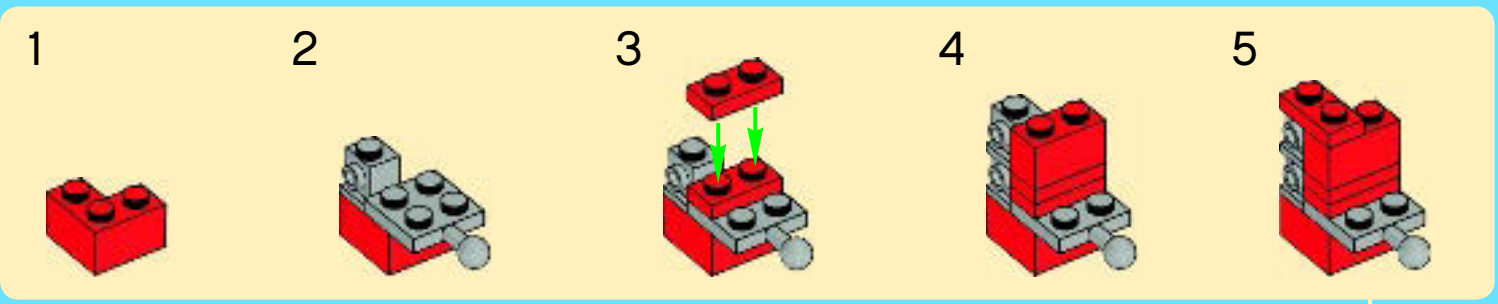

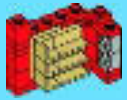

1

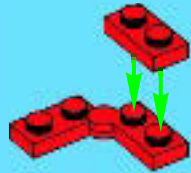

2

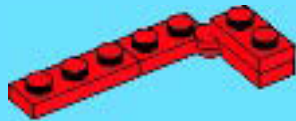

3

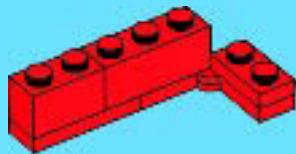

4

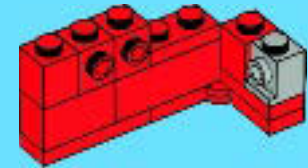

5

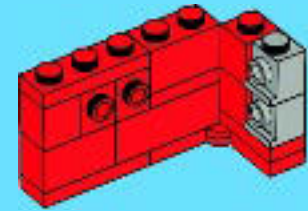

6

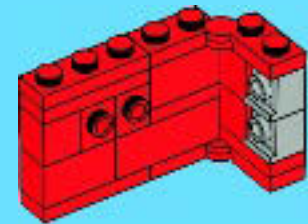



7

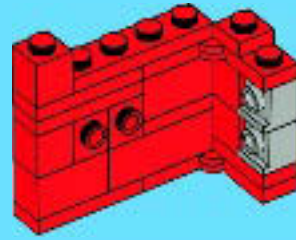

8

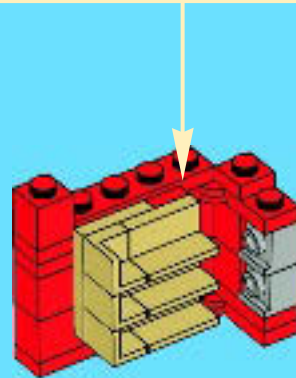
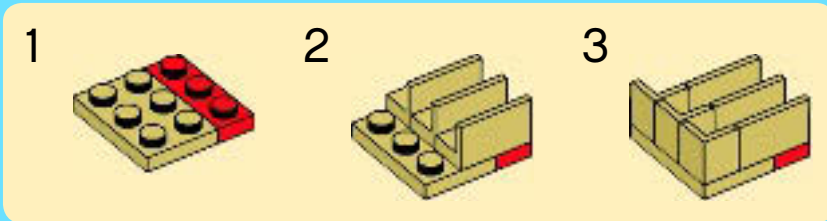

38

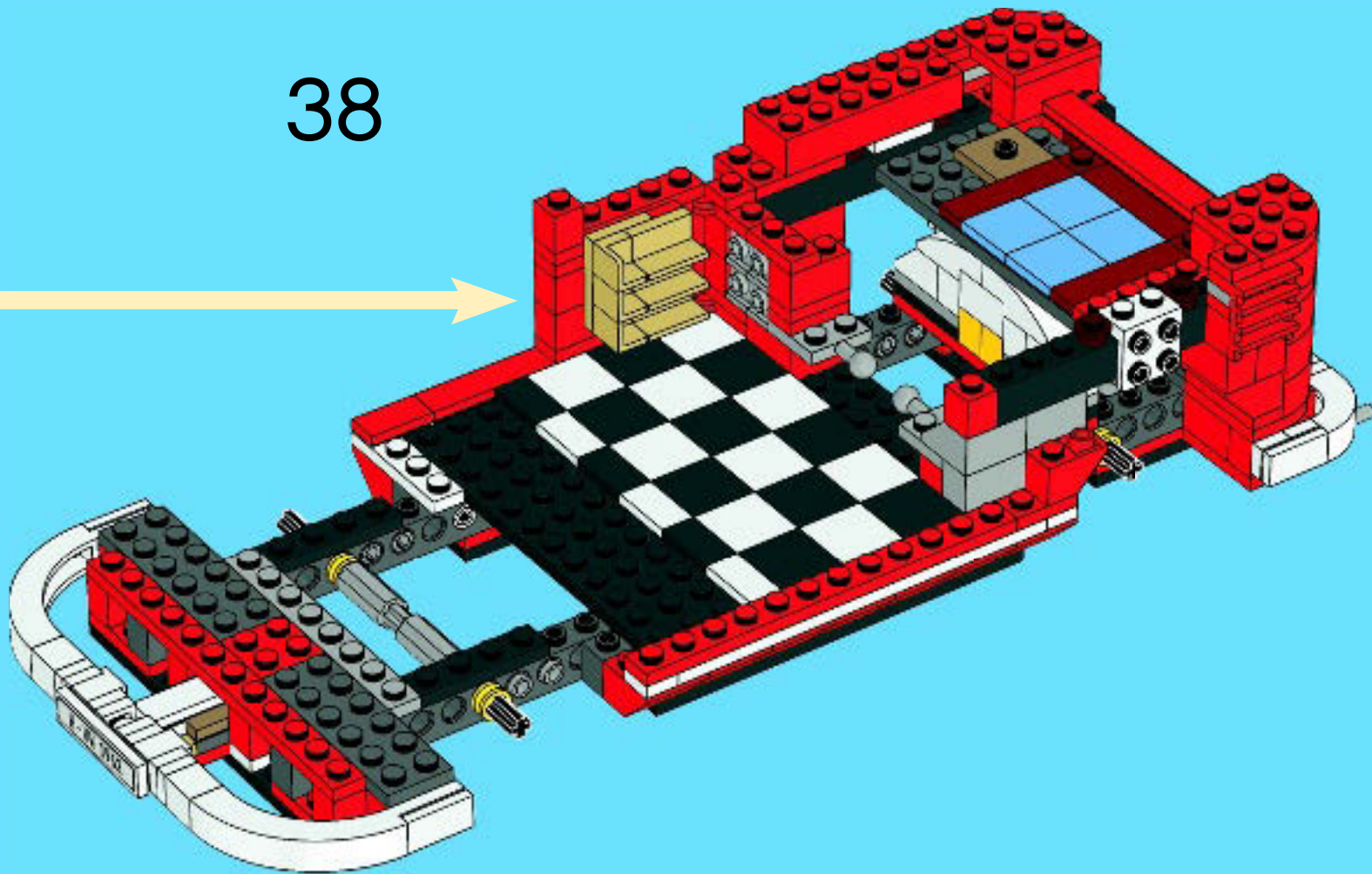



39

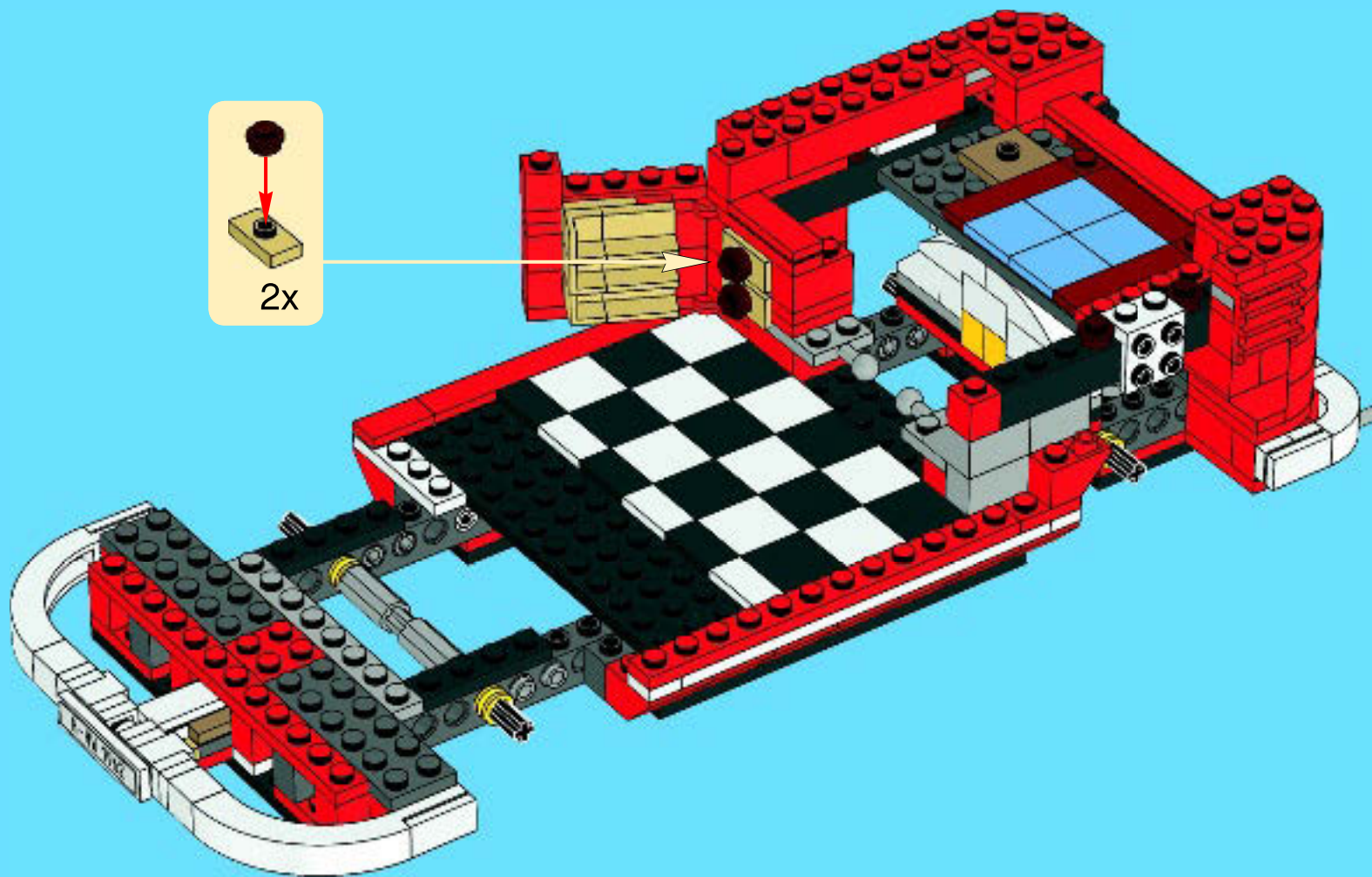
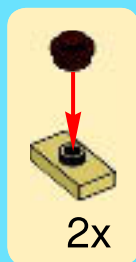





2x



1x



2x

40

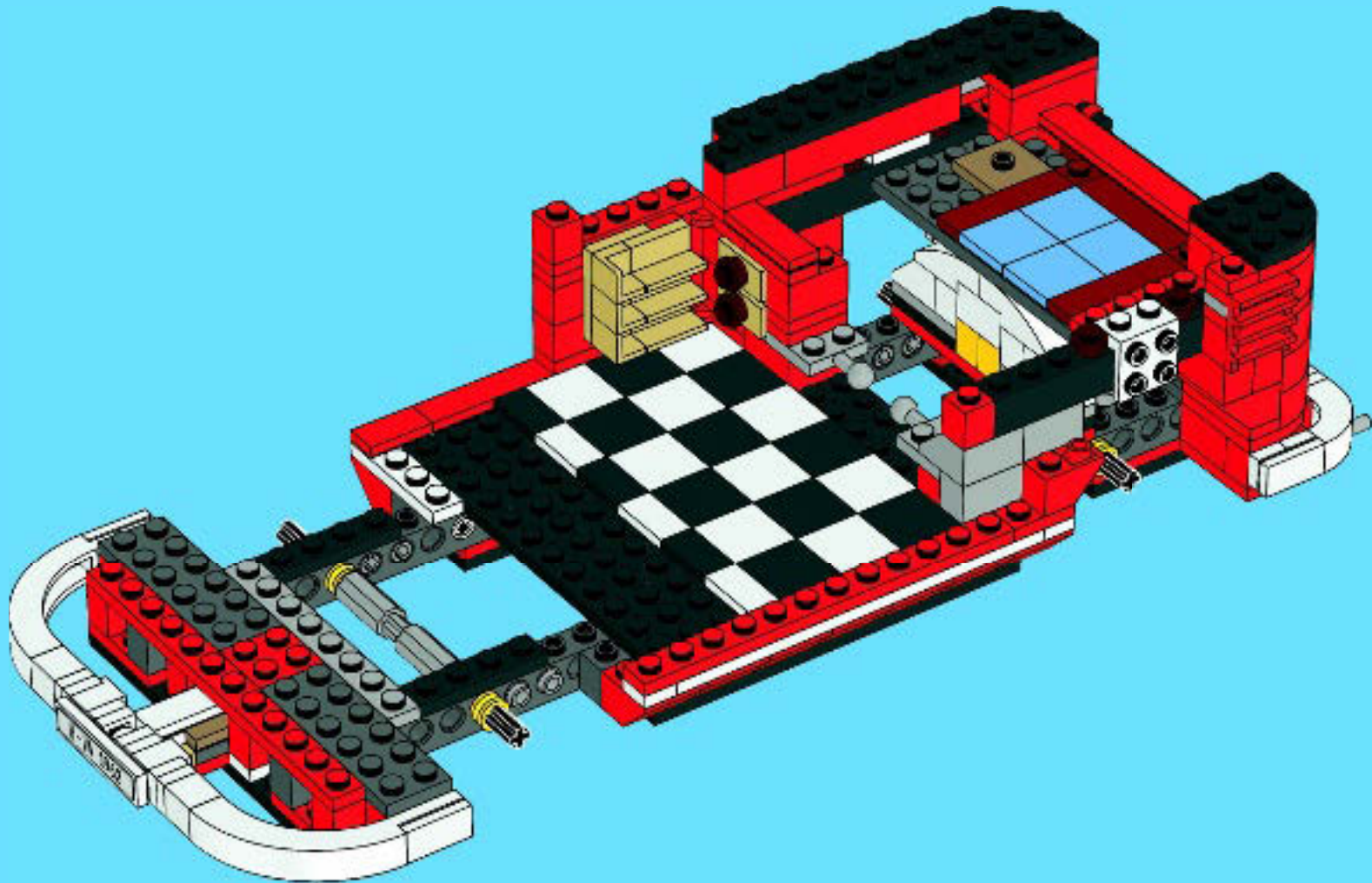

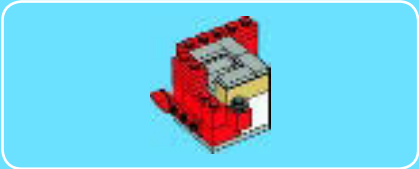

1

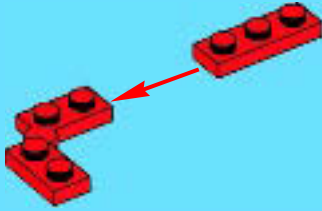

2

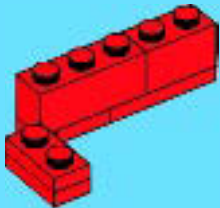

3

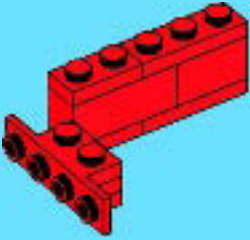

4

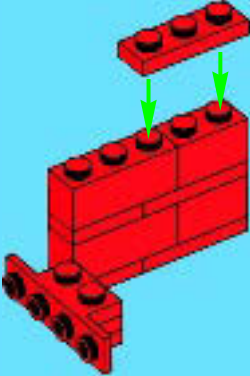



1x

5

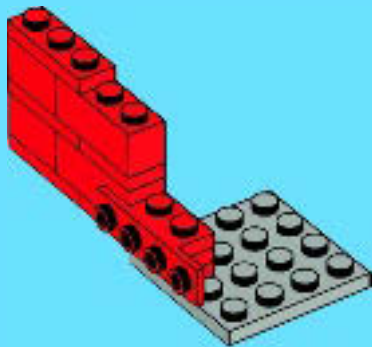

1x



1x



1x

6

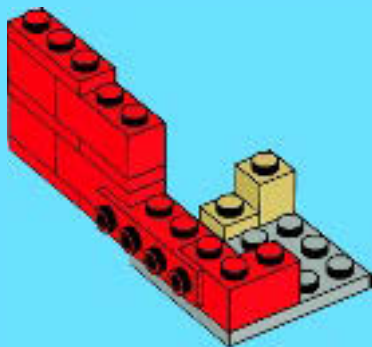

2x

7

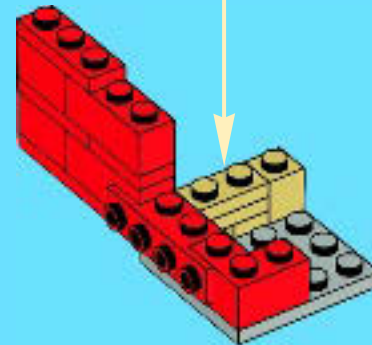
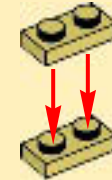

1x



1x



1x



1x



1x



1x

8

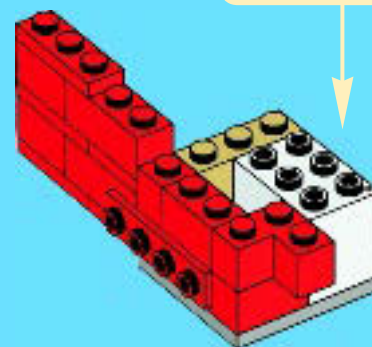
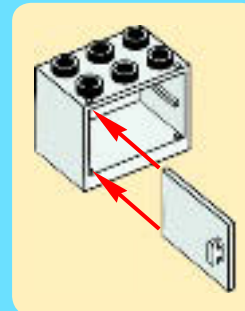



9

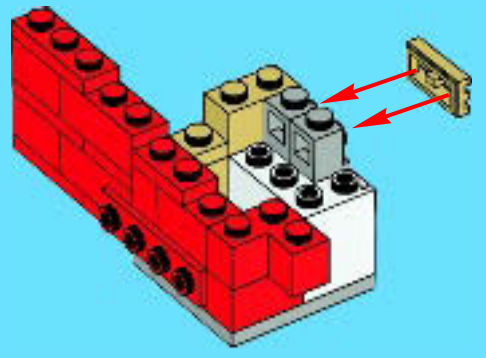

10

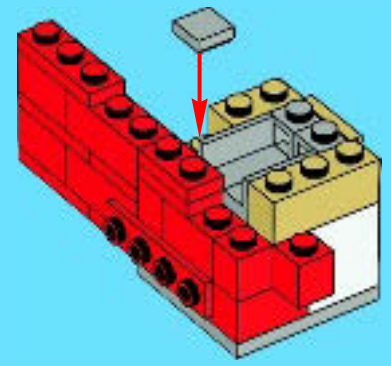

11

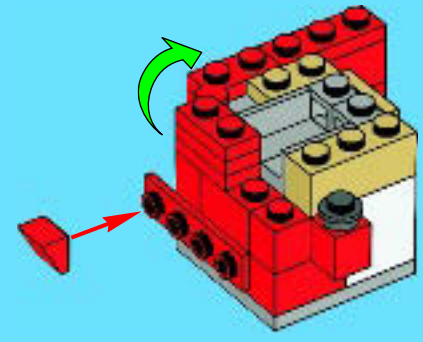

12

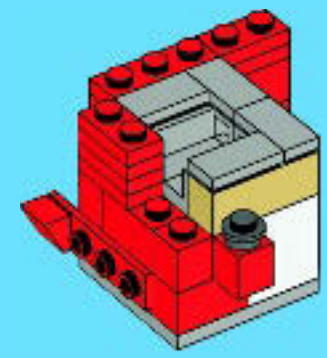

41

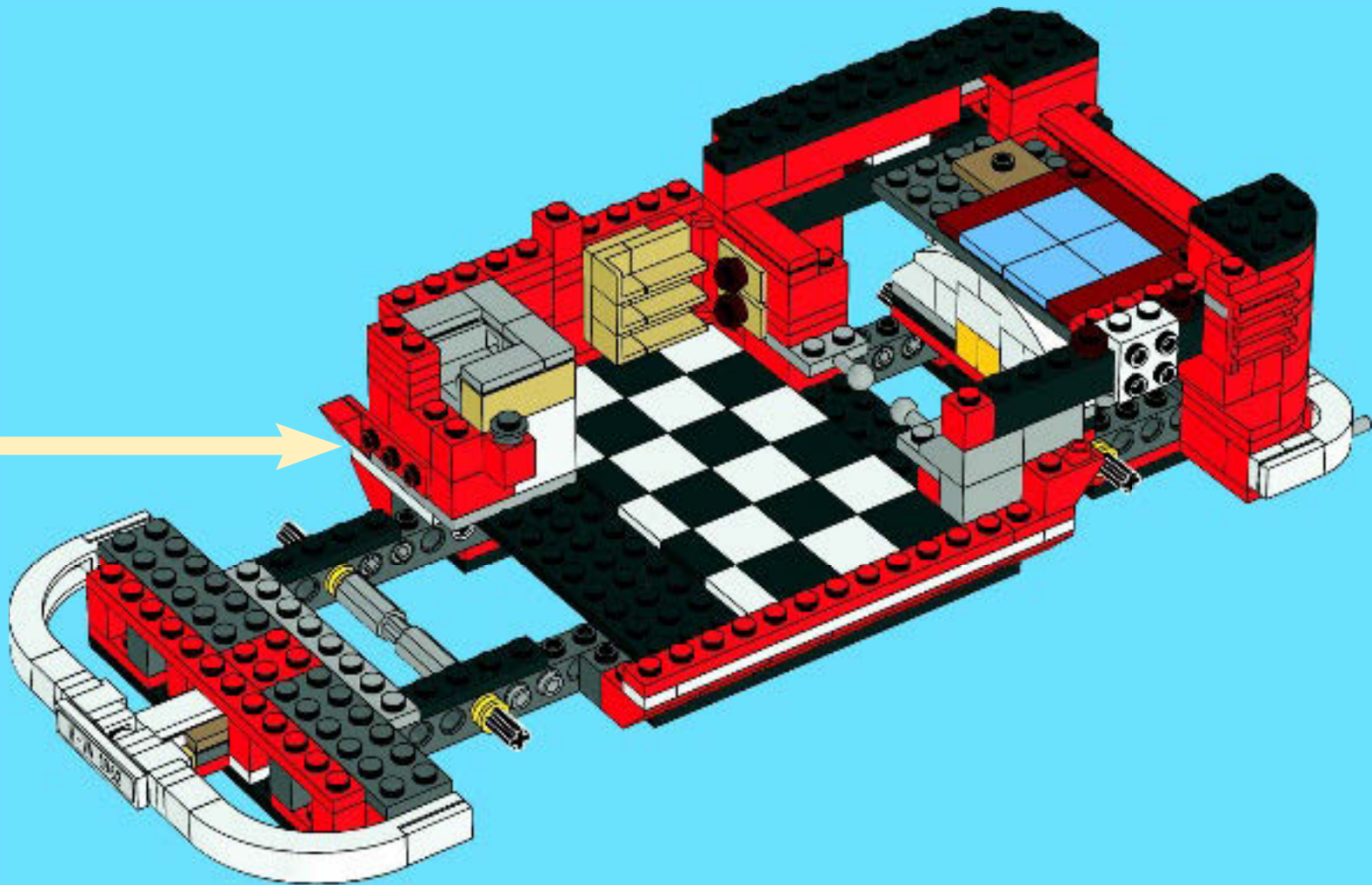



42

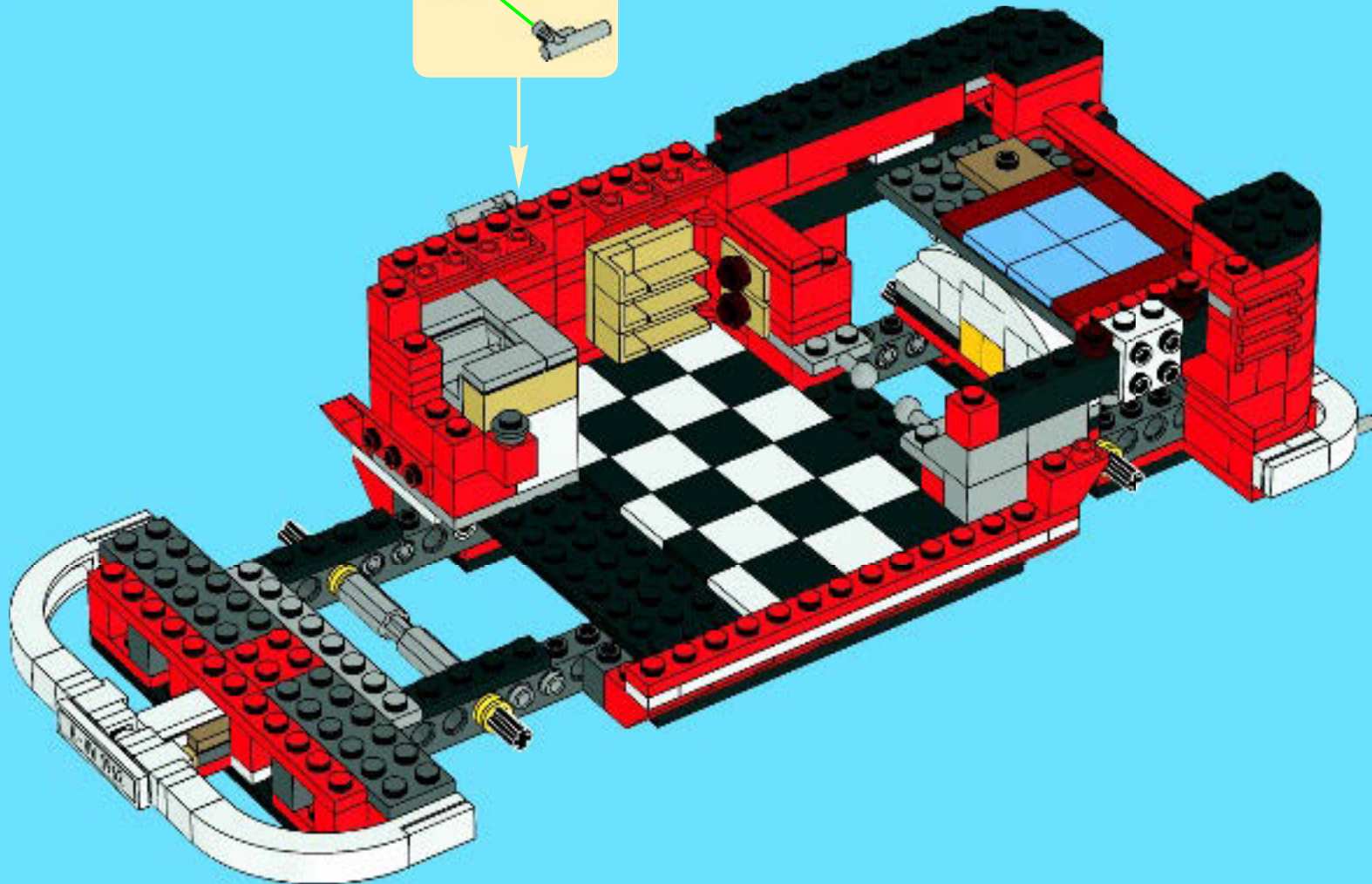
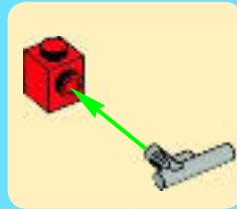



2x



1x



2x

# 43

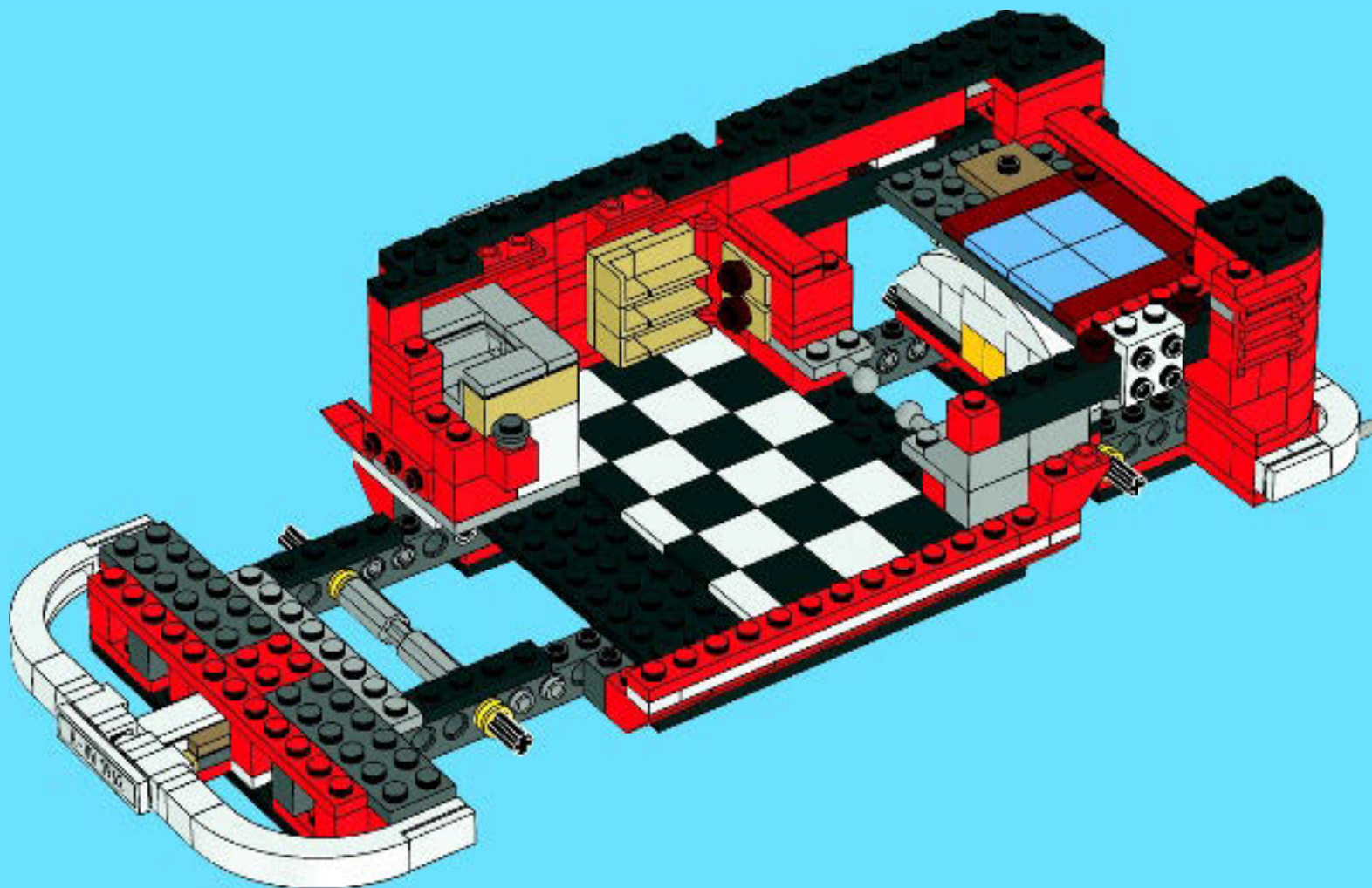

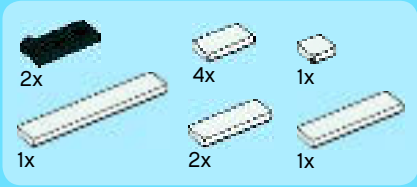

44

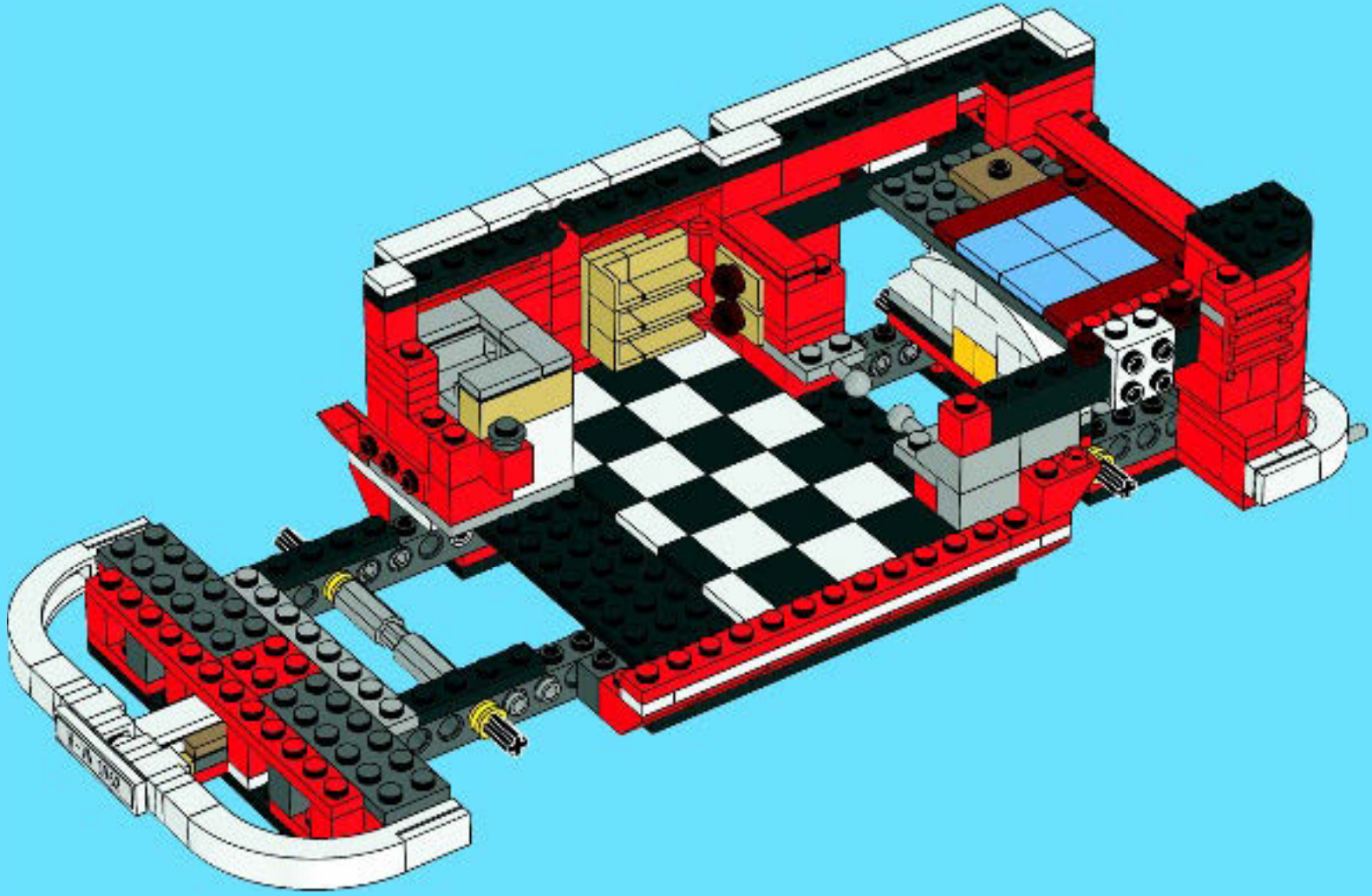





45

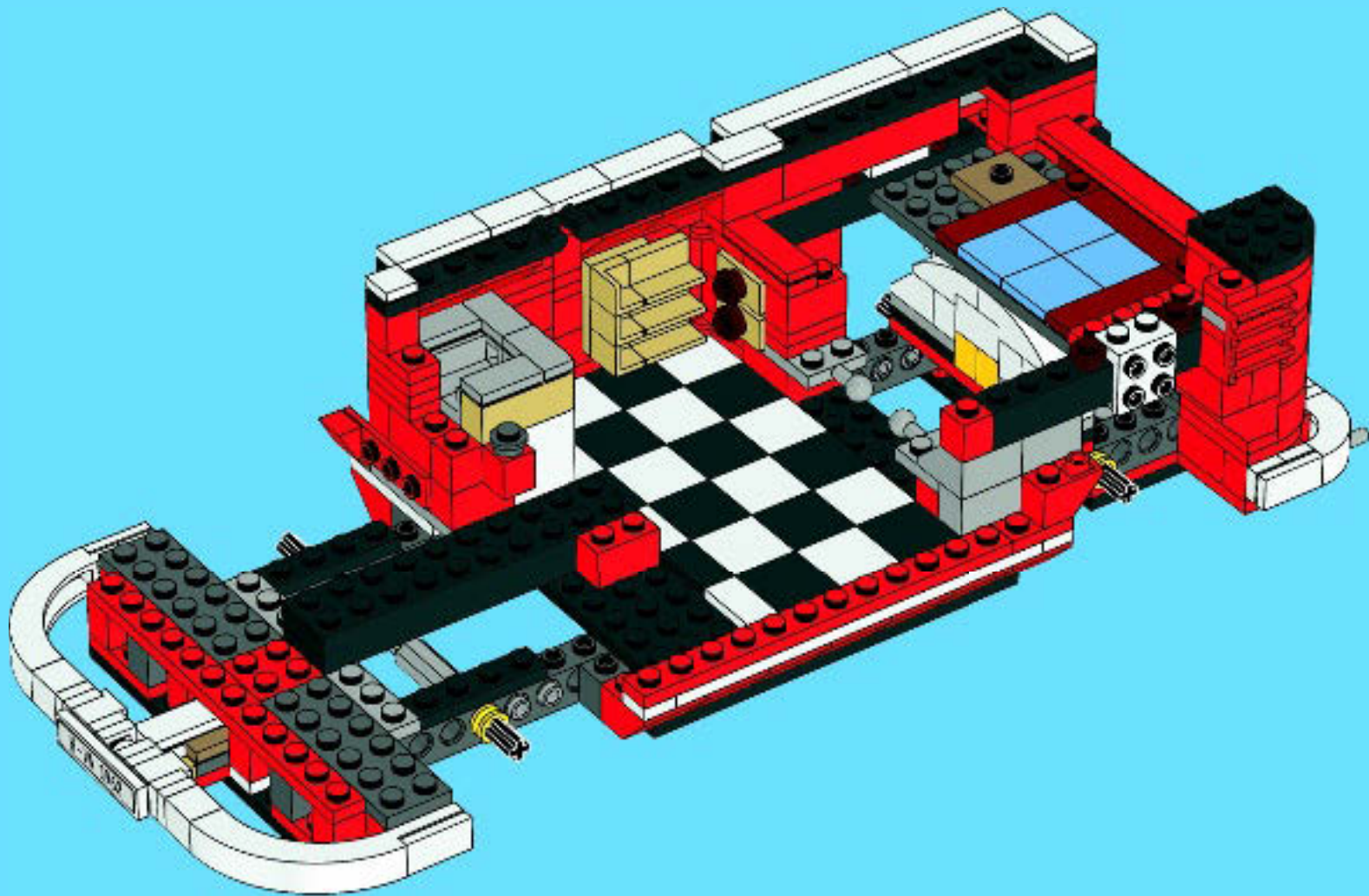



3x



1x

46

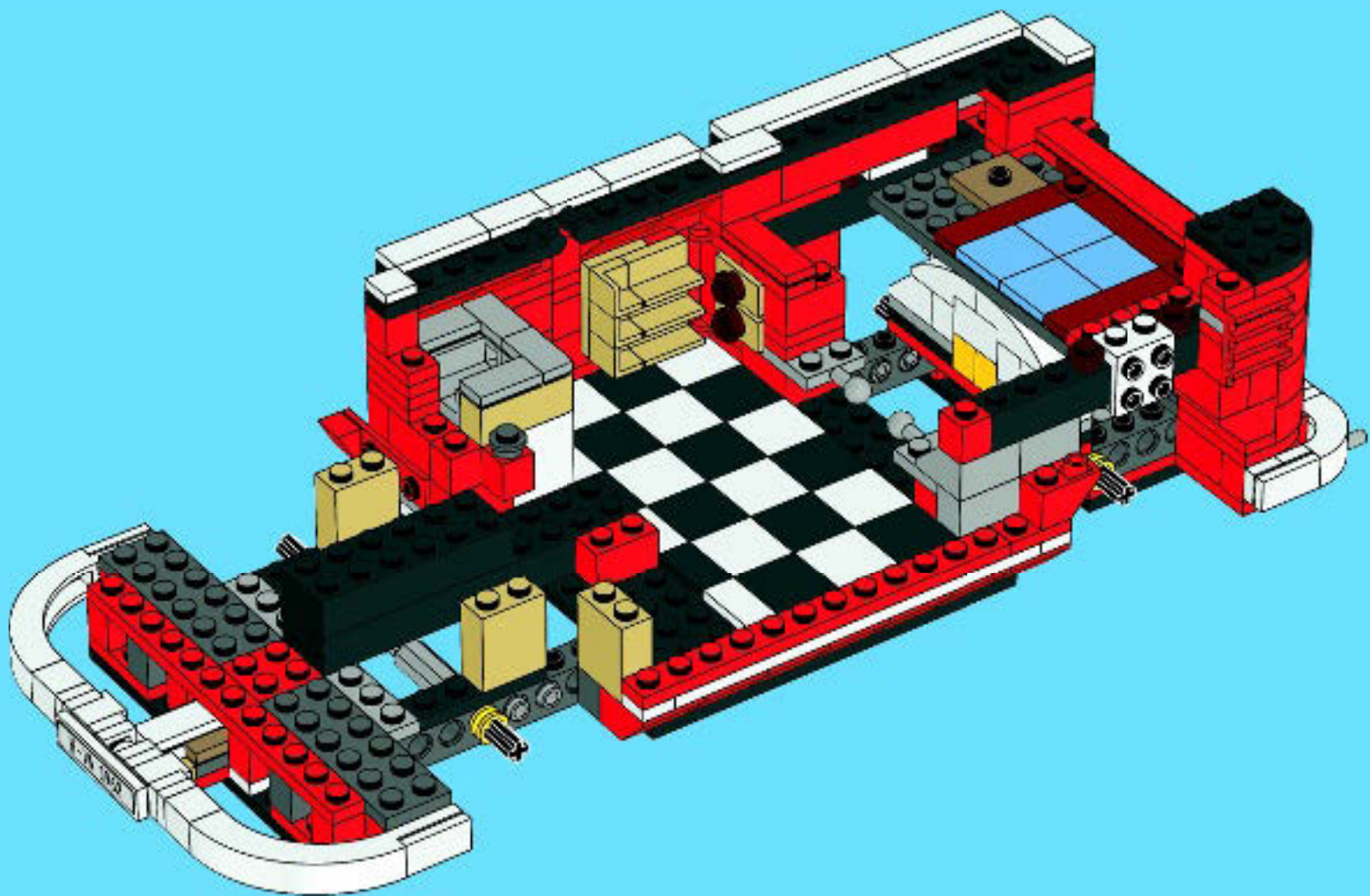



47

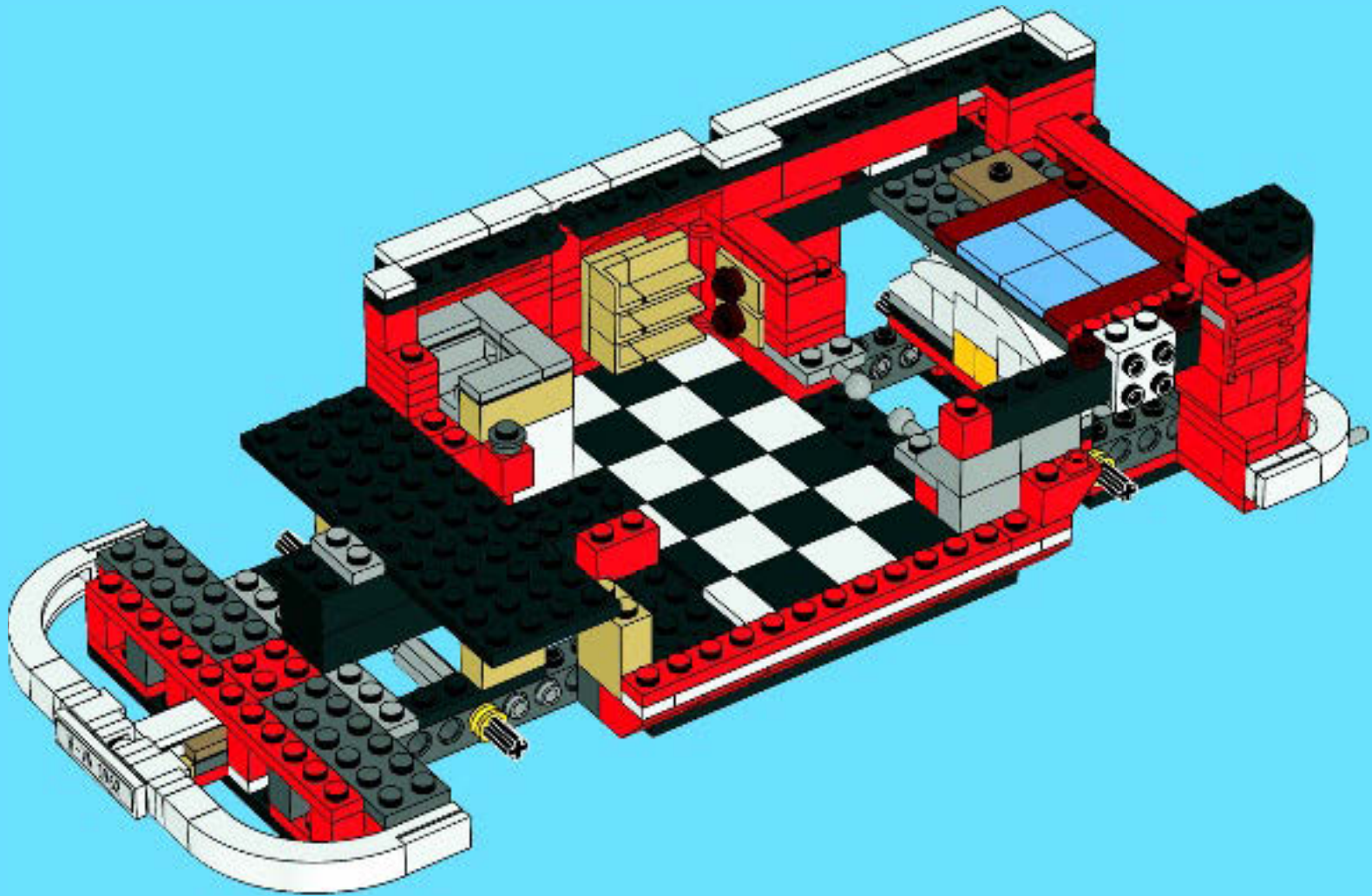



2x



2x



1x



4x

# 48

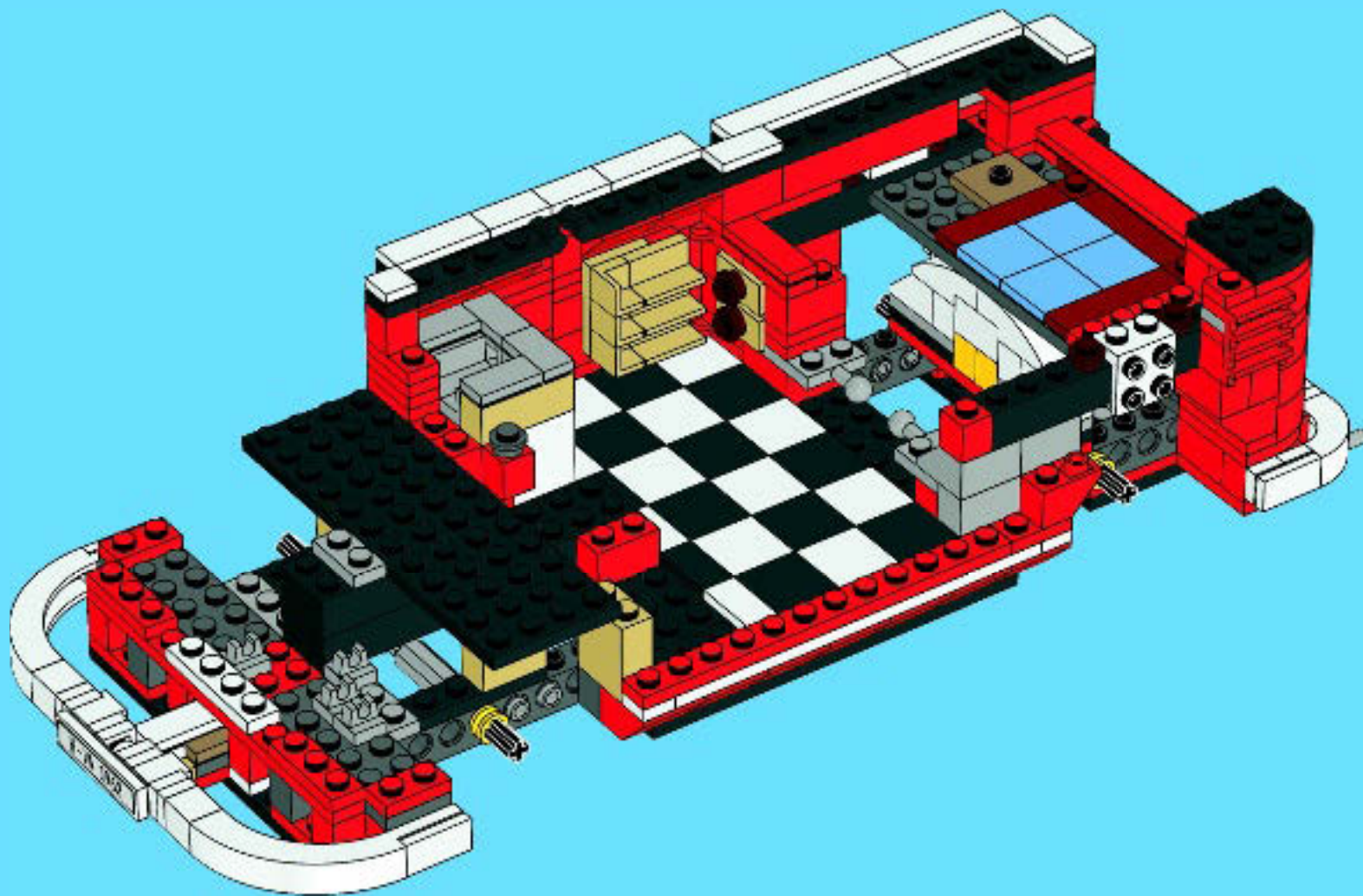

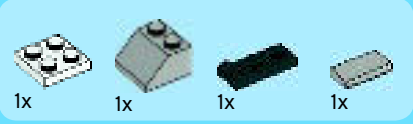

49

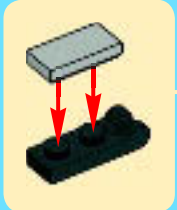
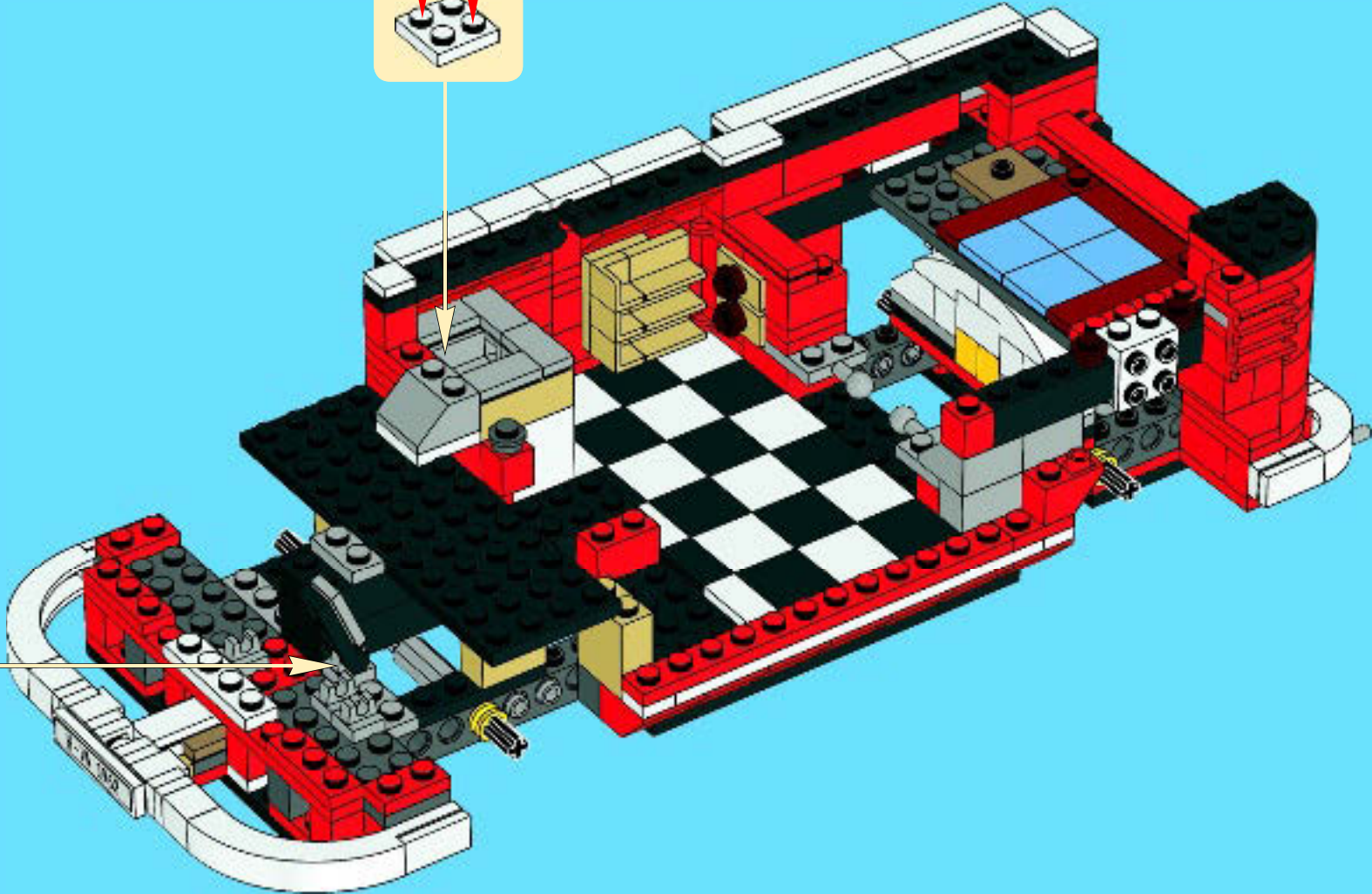
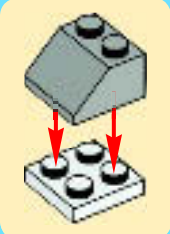



1x



2x

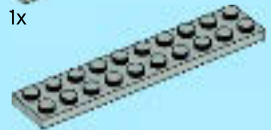

1x



2x

# 50

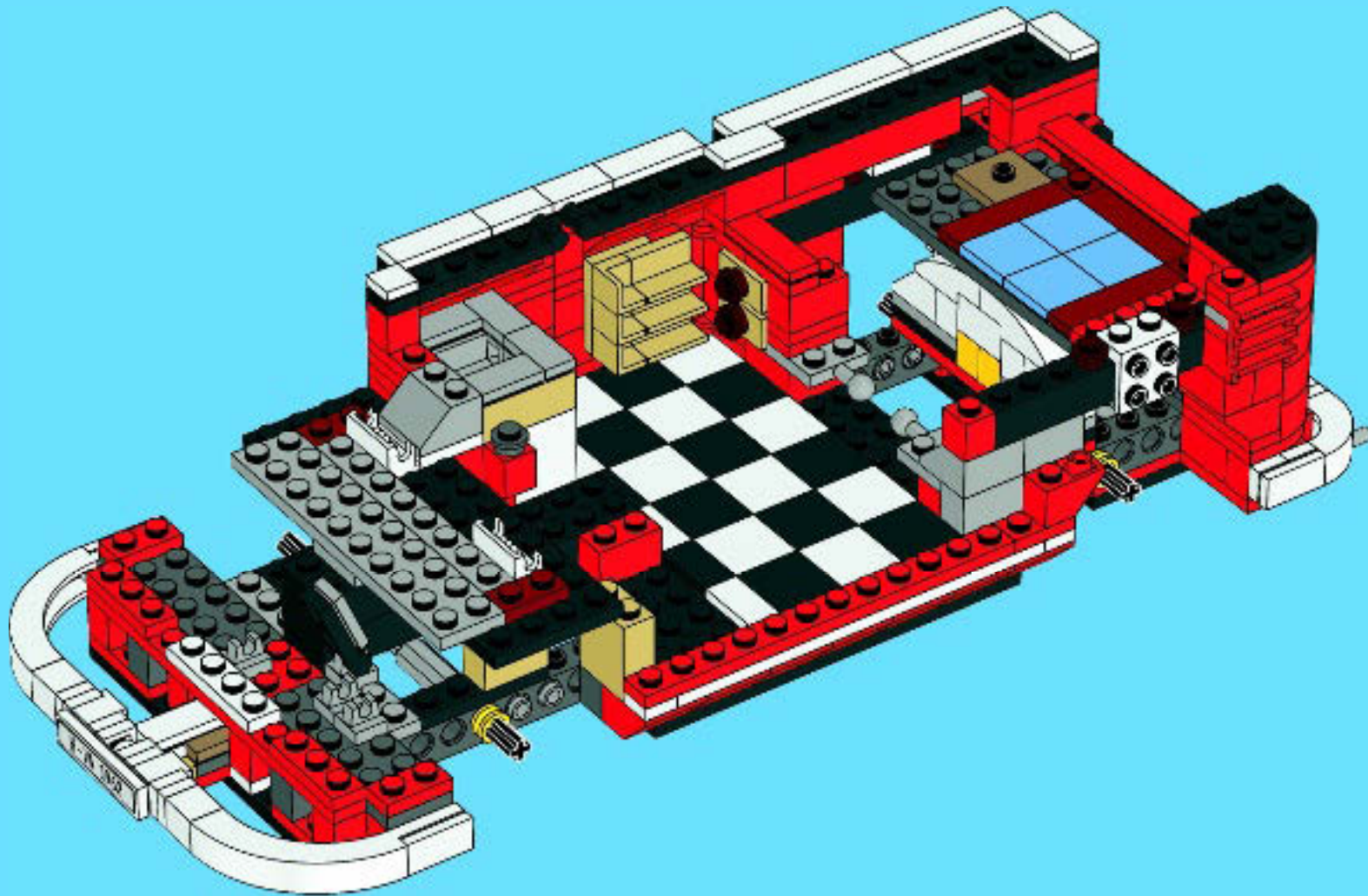

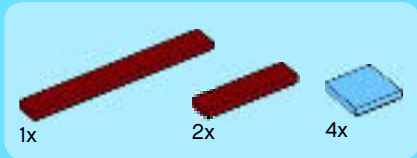

51

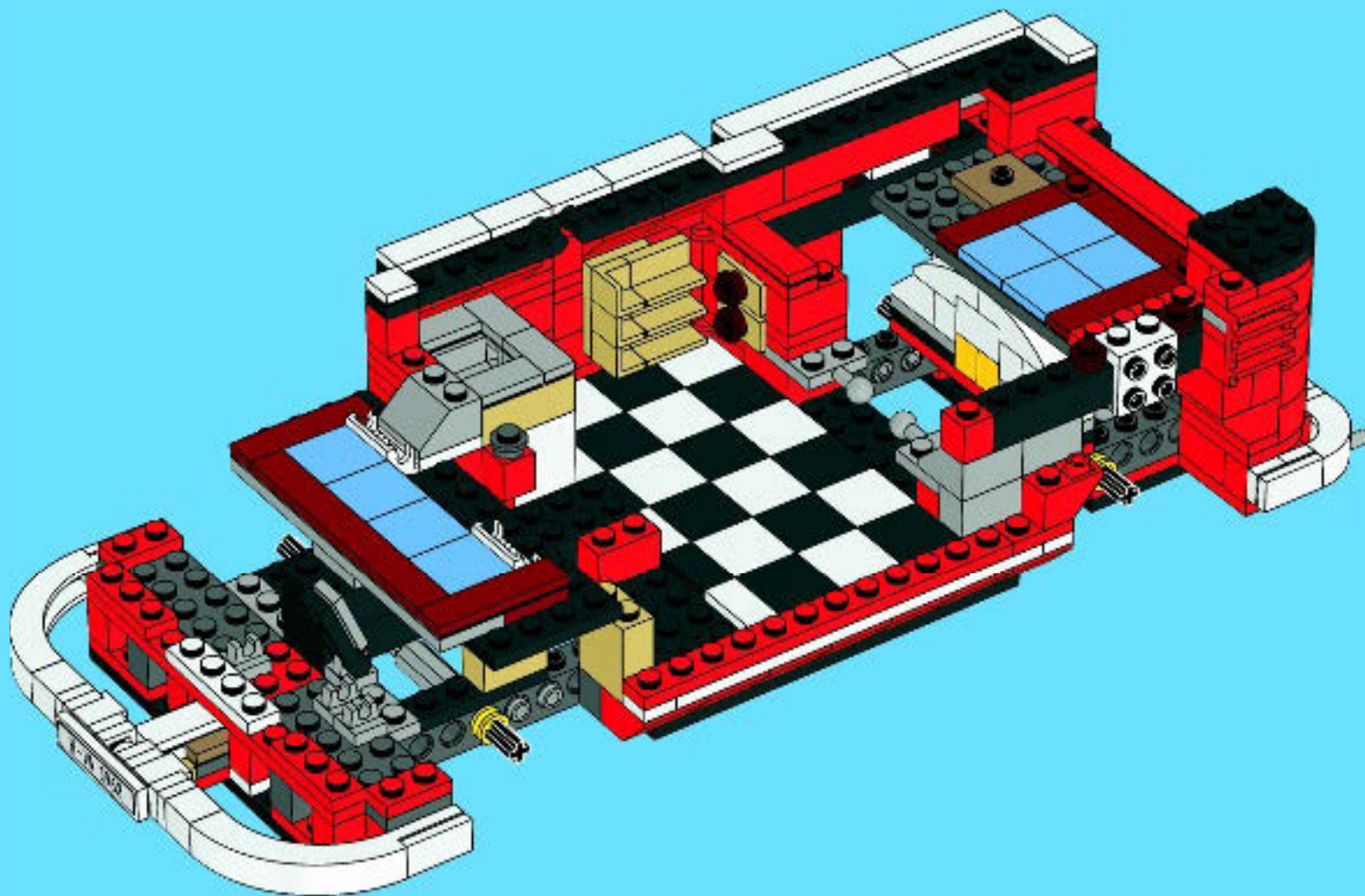



1x



1x



2x



1x

# 52

1

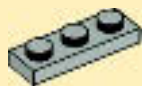

2

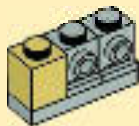

3

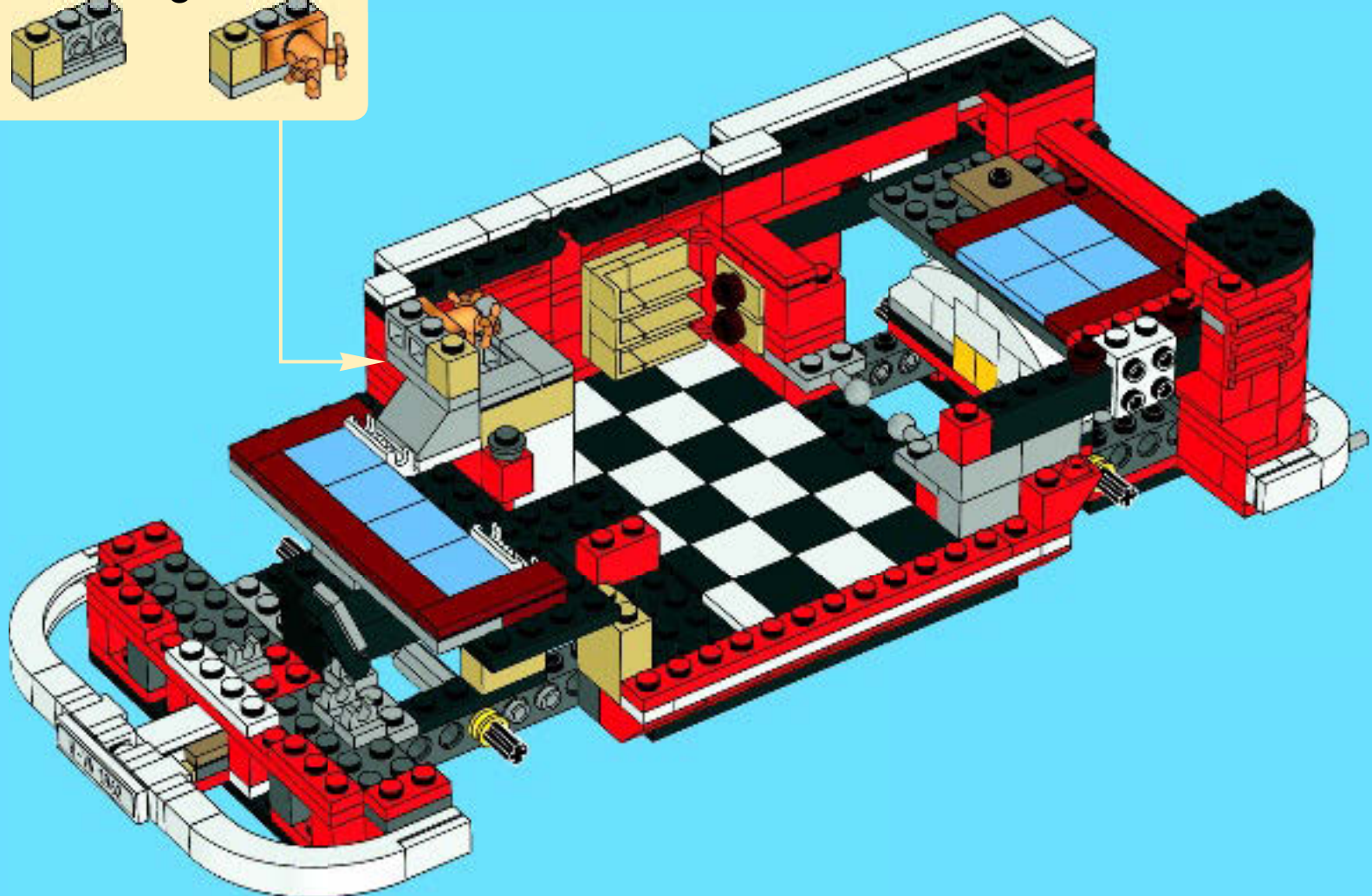





# 53

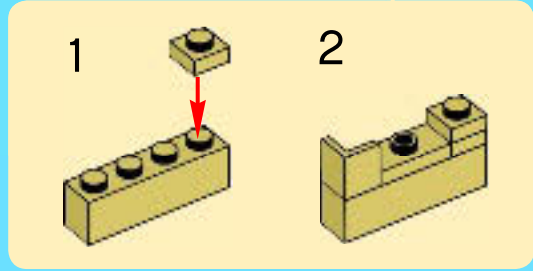
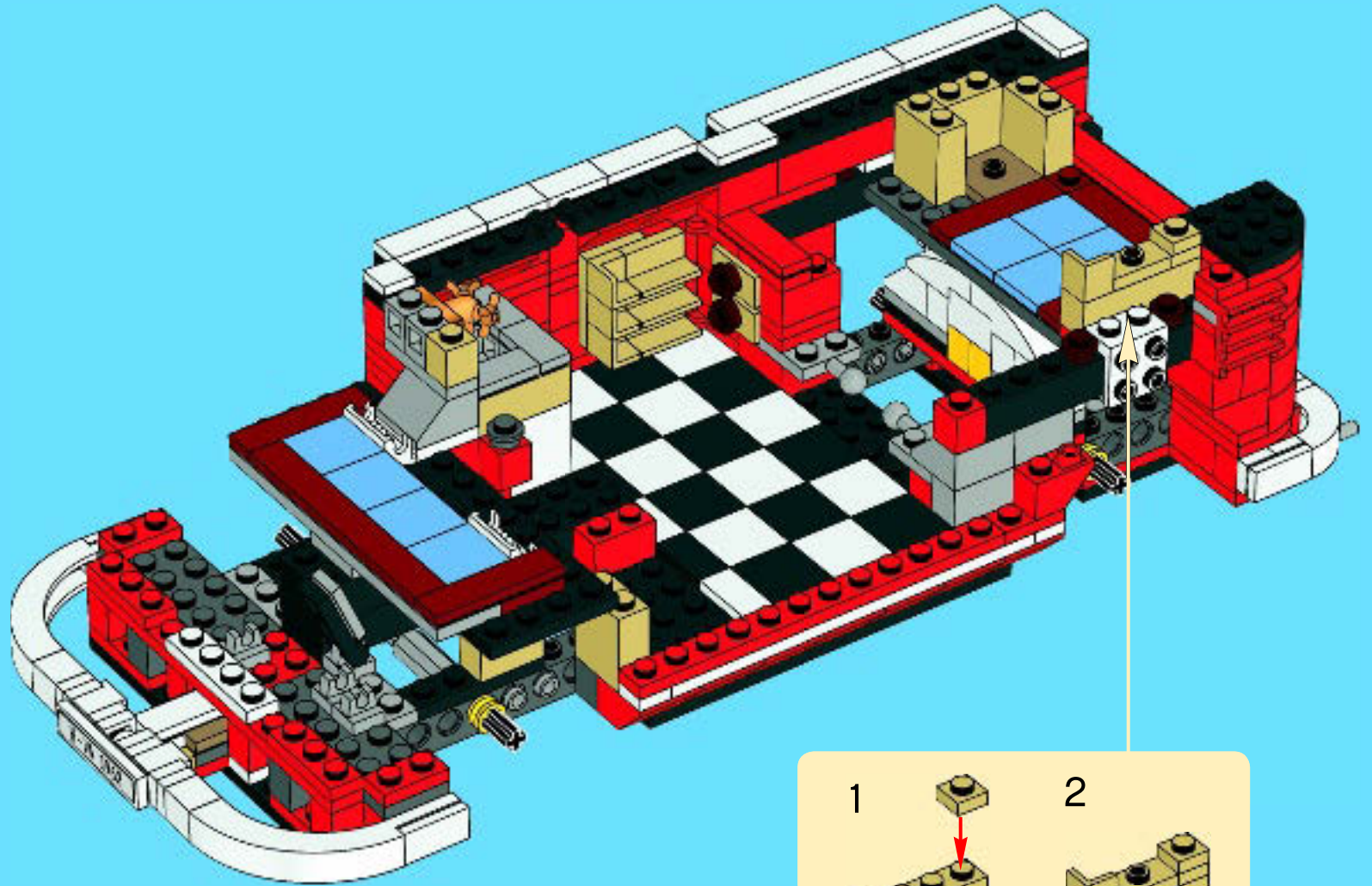

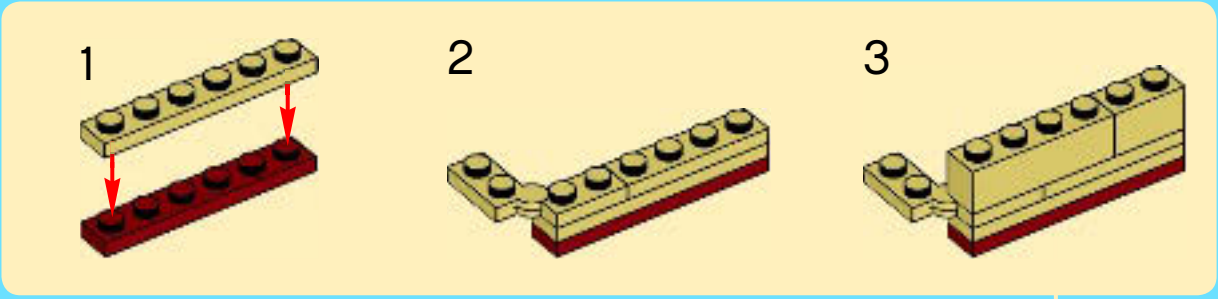
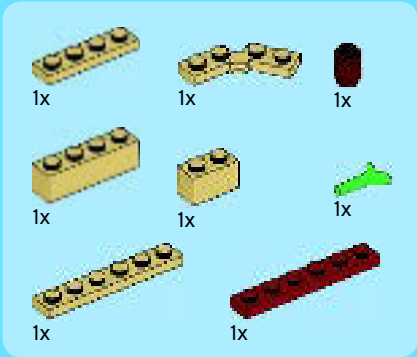

54

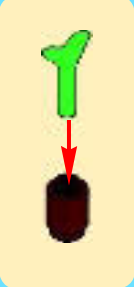
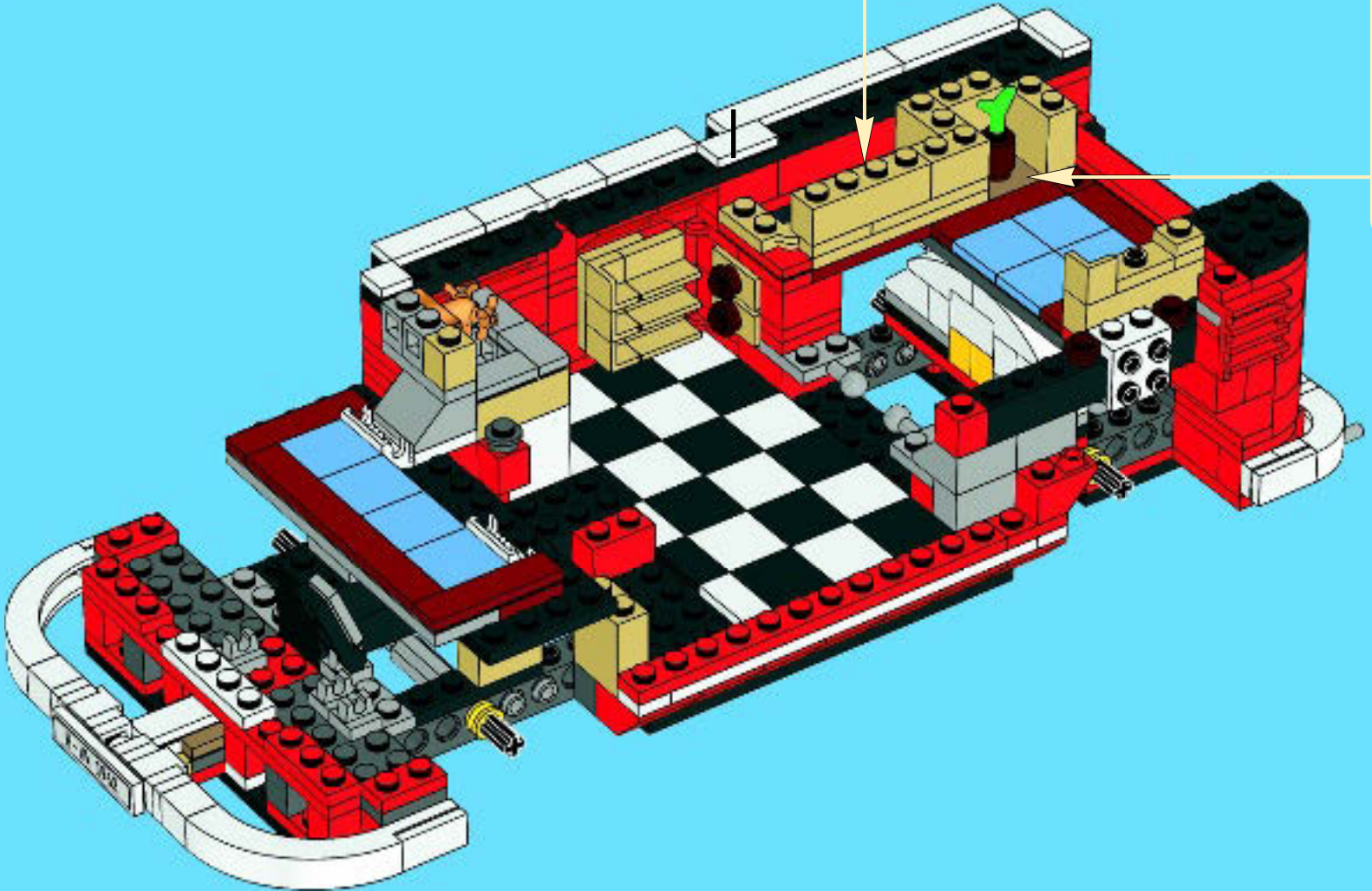

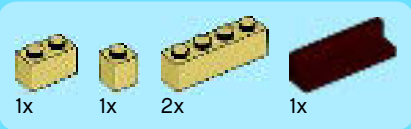

55

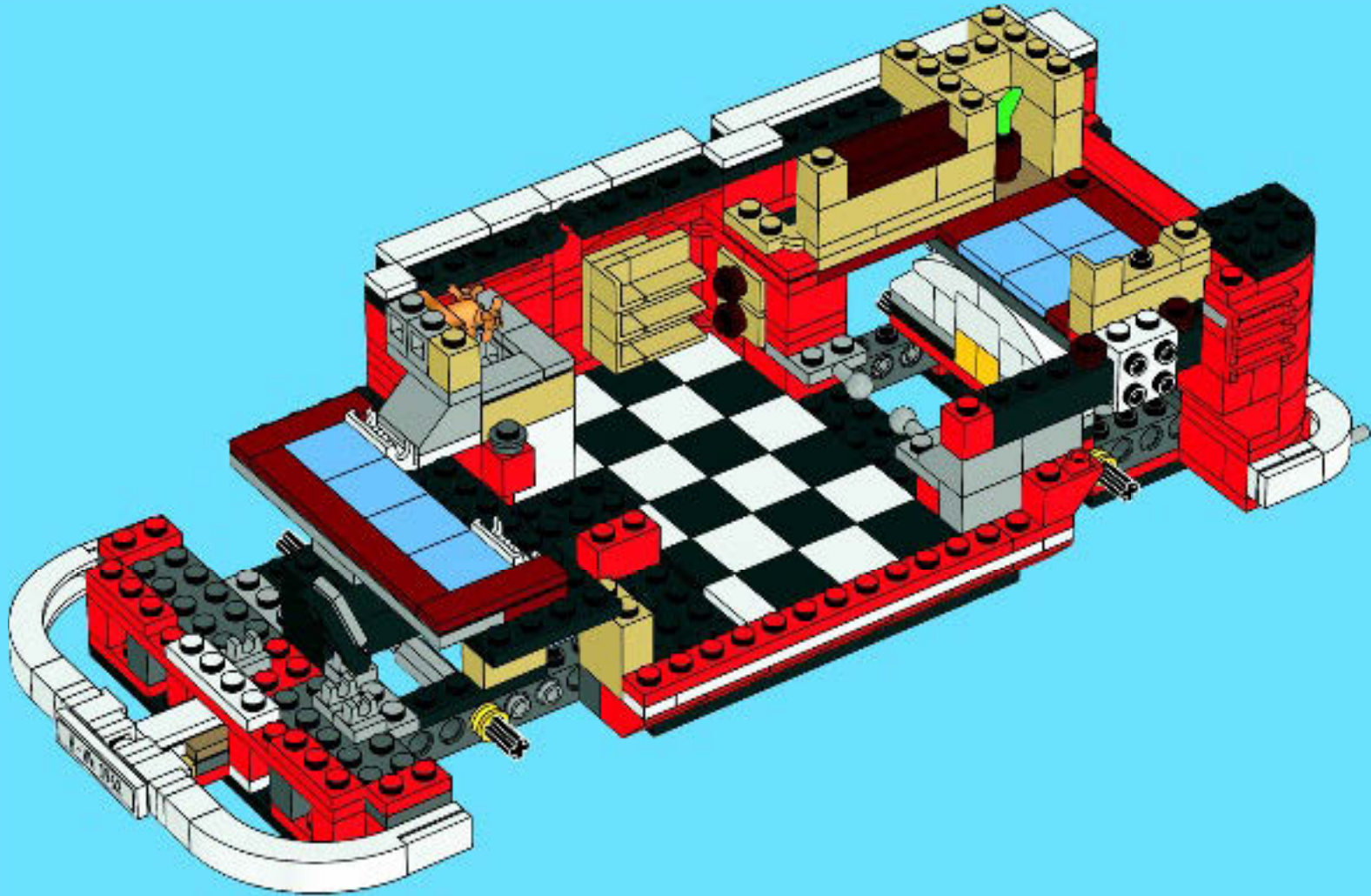



1x

1



1x



2x

2



2x



1x

3



2x



2x

4



2x



3x

5



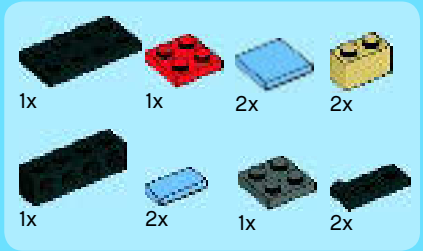

6

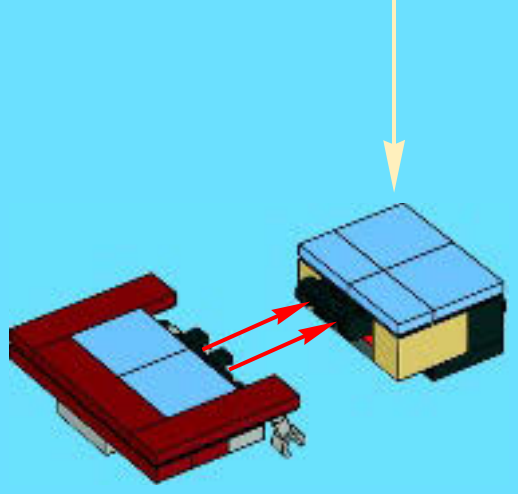
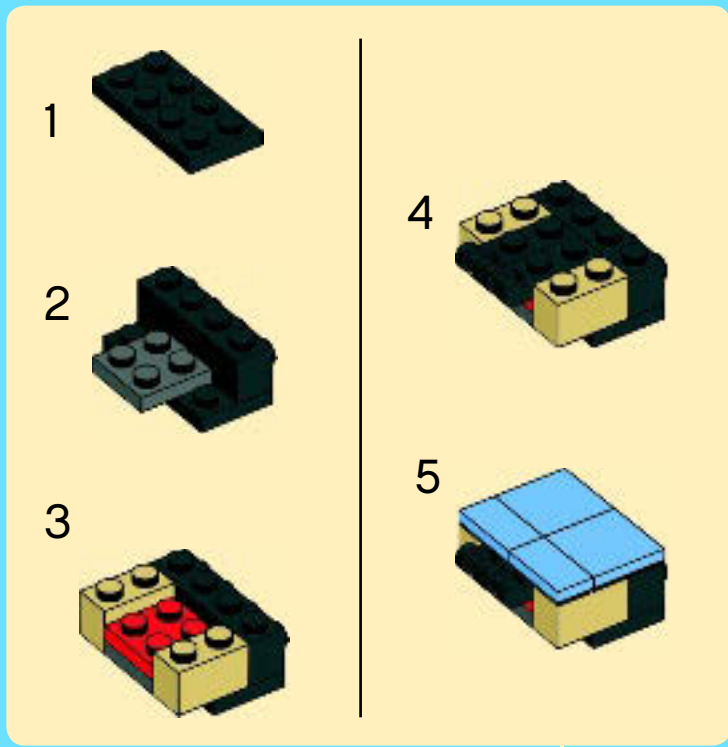

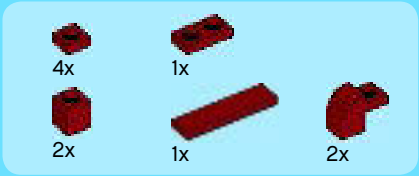

# 7

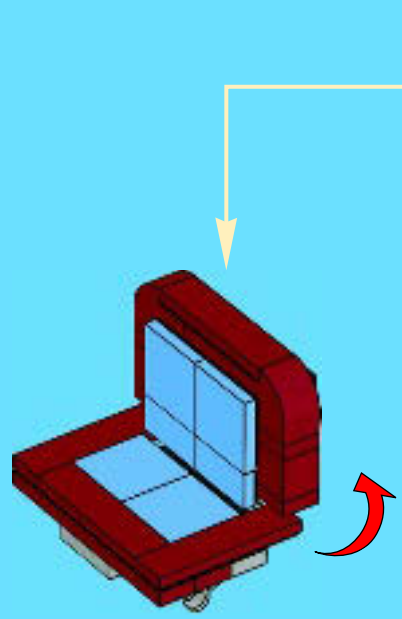
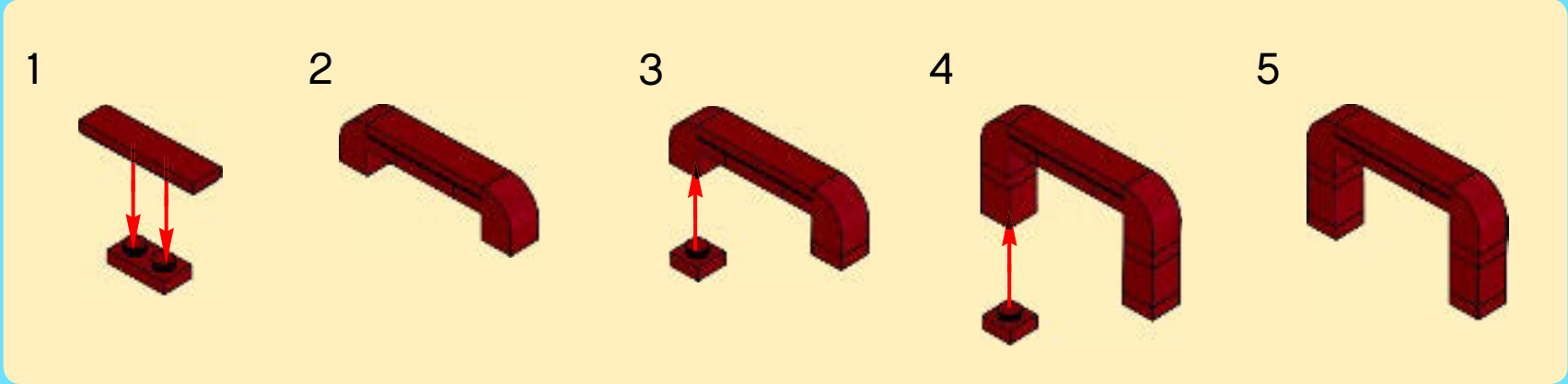

56

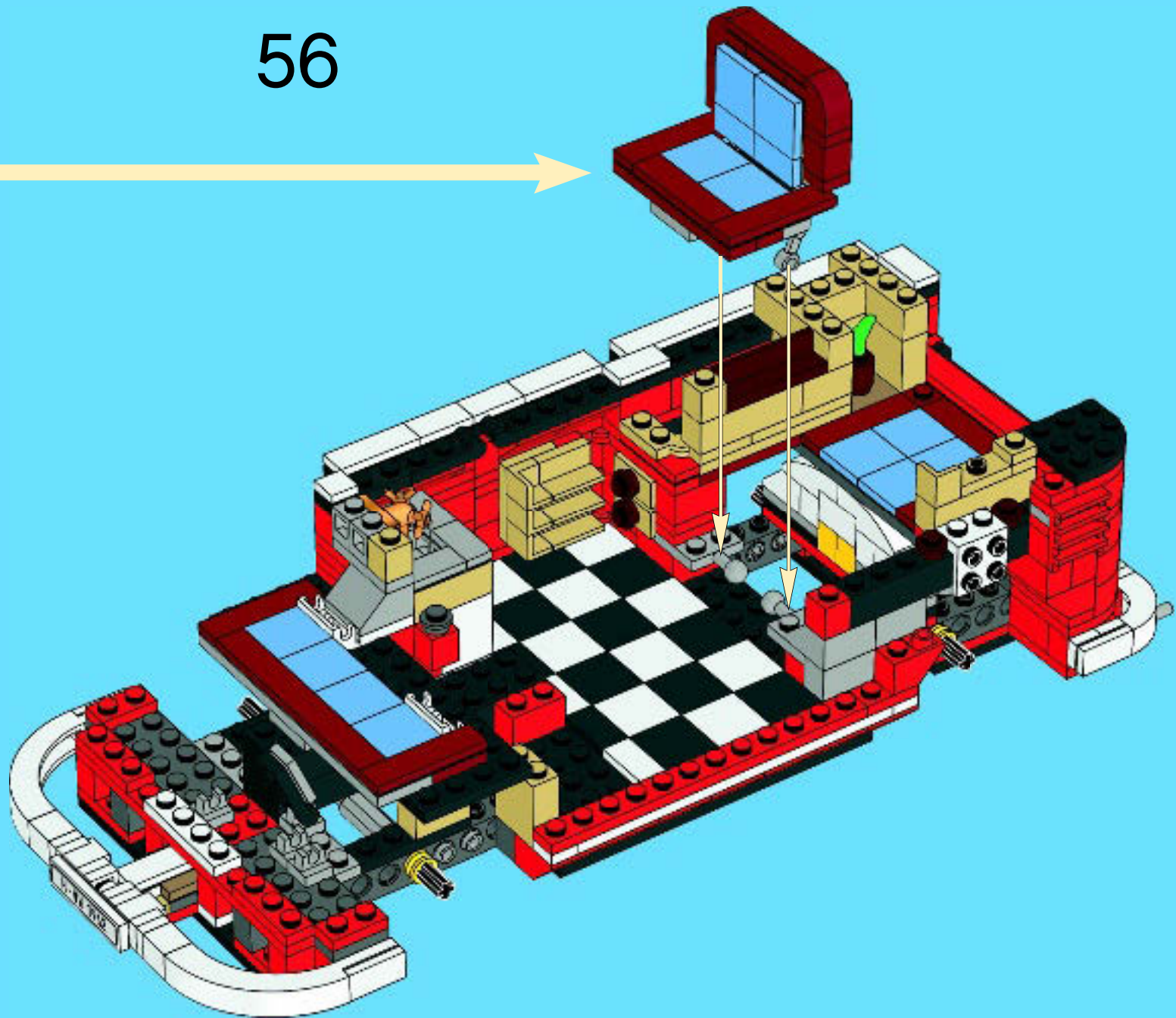



1x

1



1x



1x



1x

2



2x



1x

3



2x

4

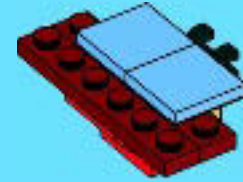

3x

5

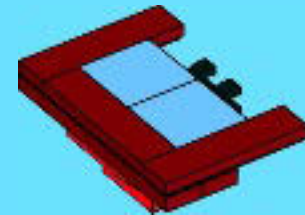





6

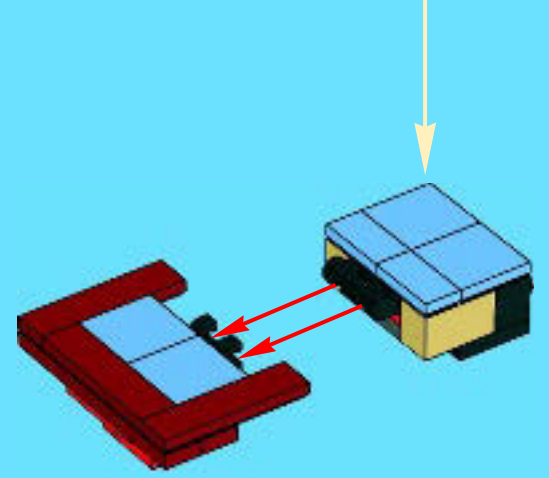
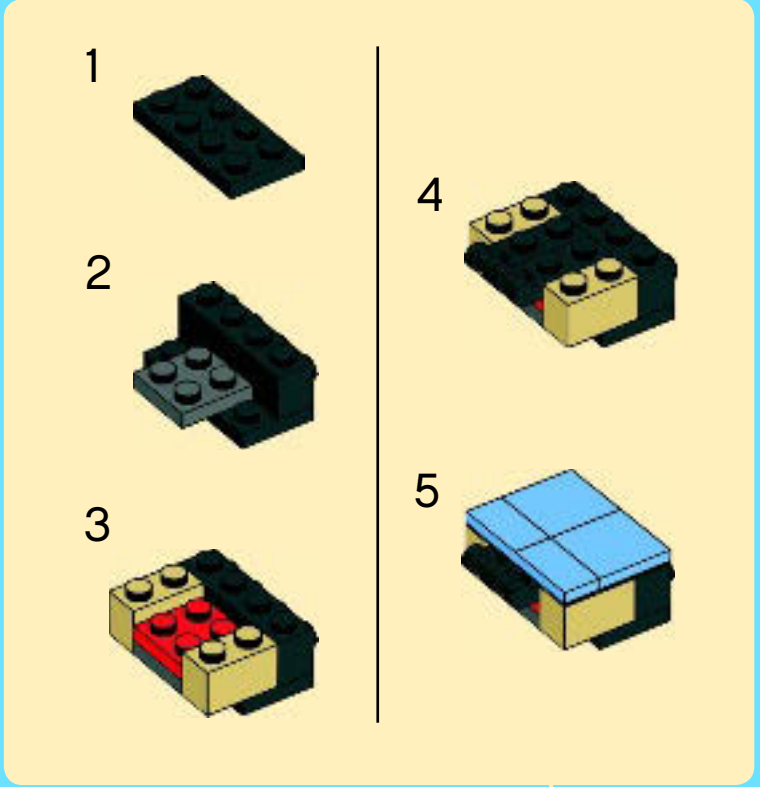

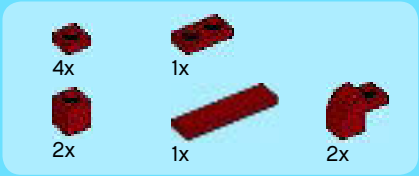

7

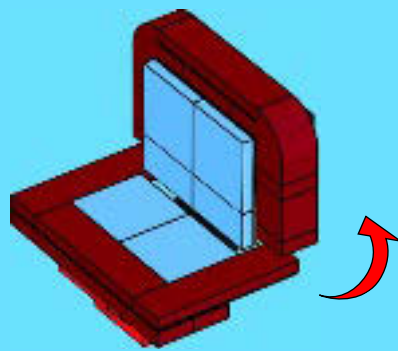
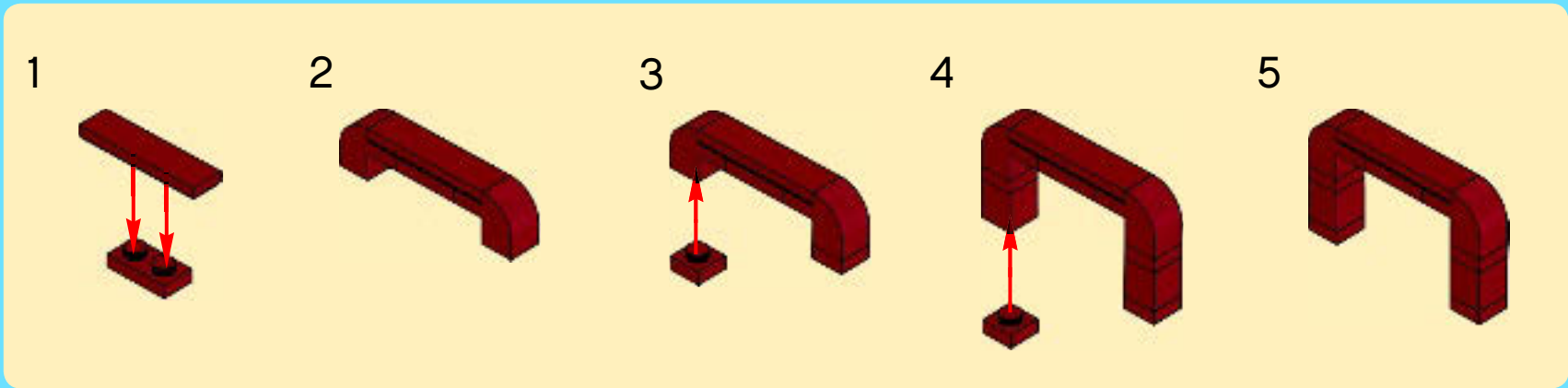

57

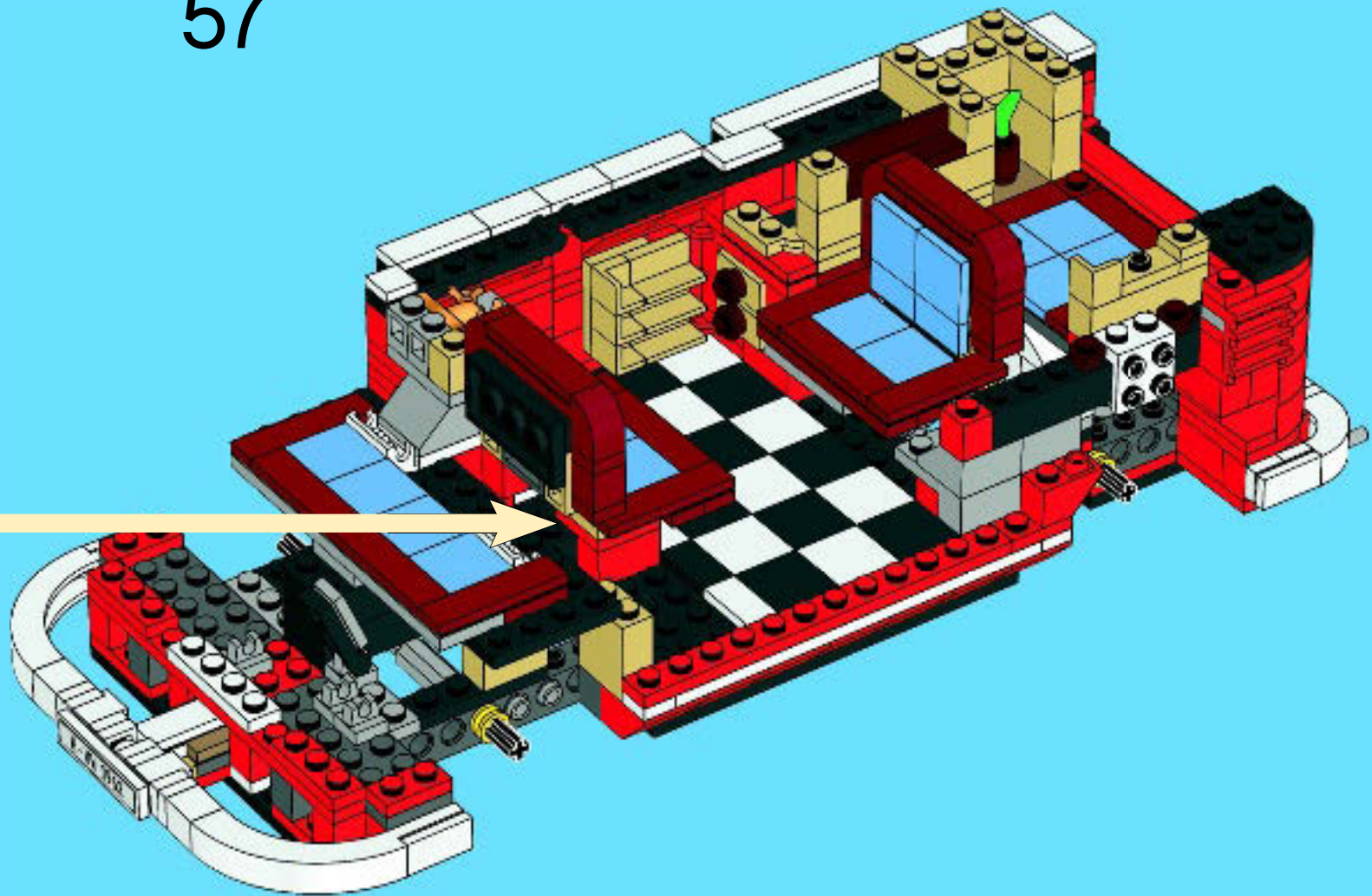



2x



1x



1x

# 58

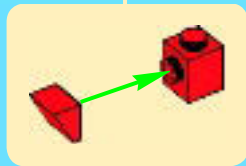
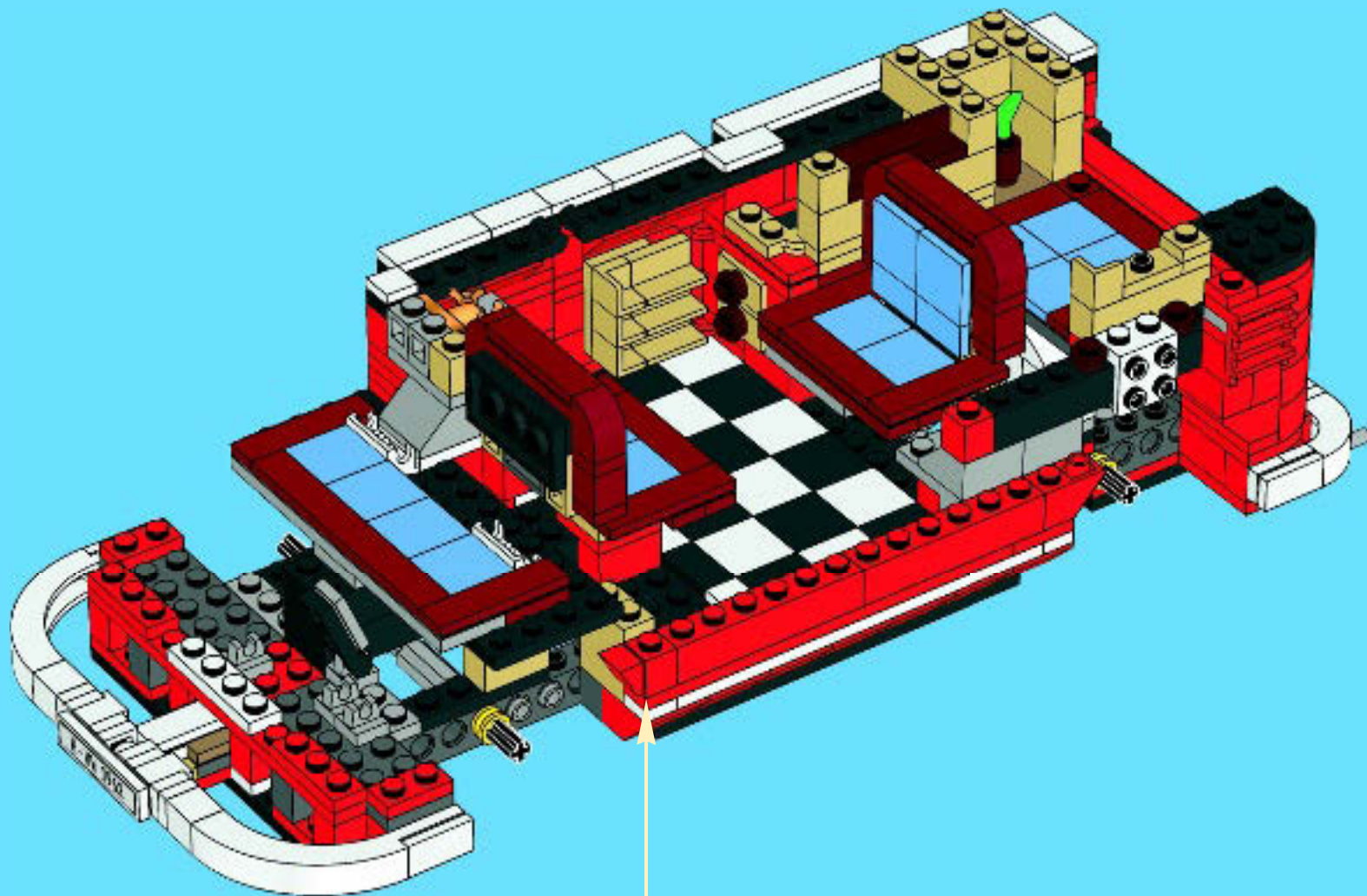



2x



1x



1x

# 59

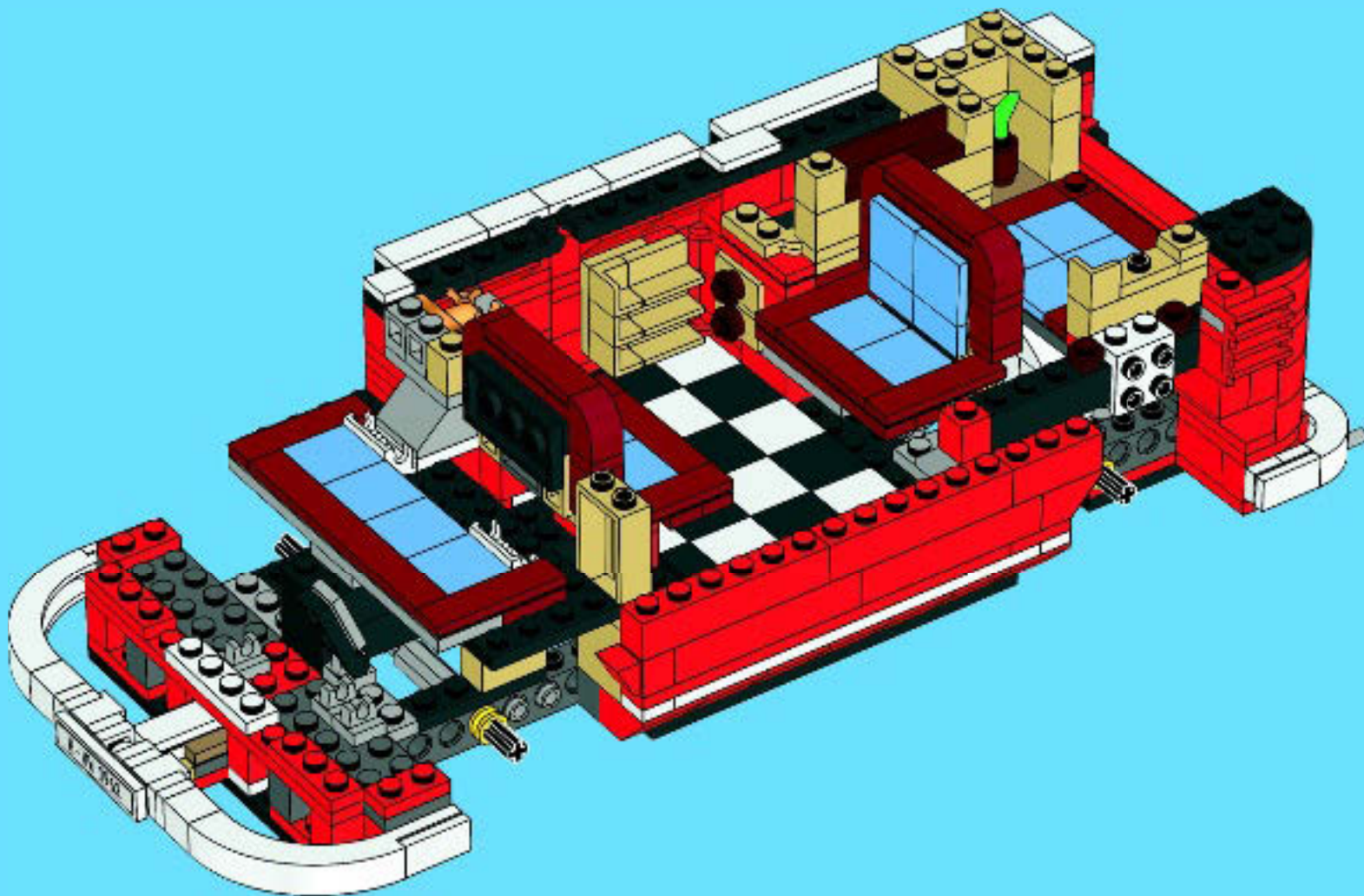



2x



1x

# 60

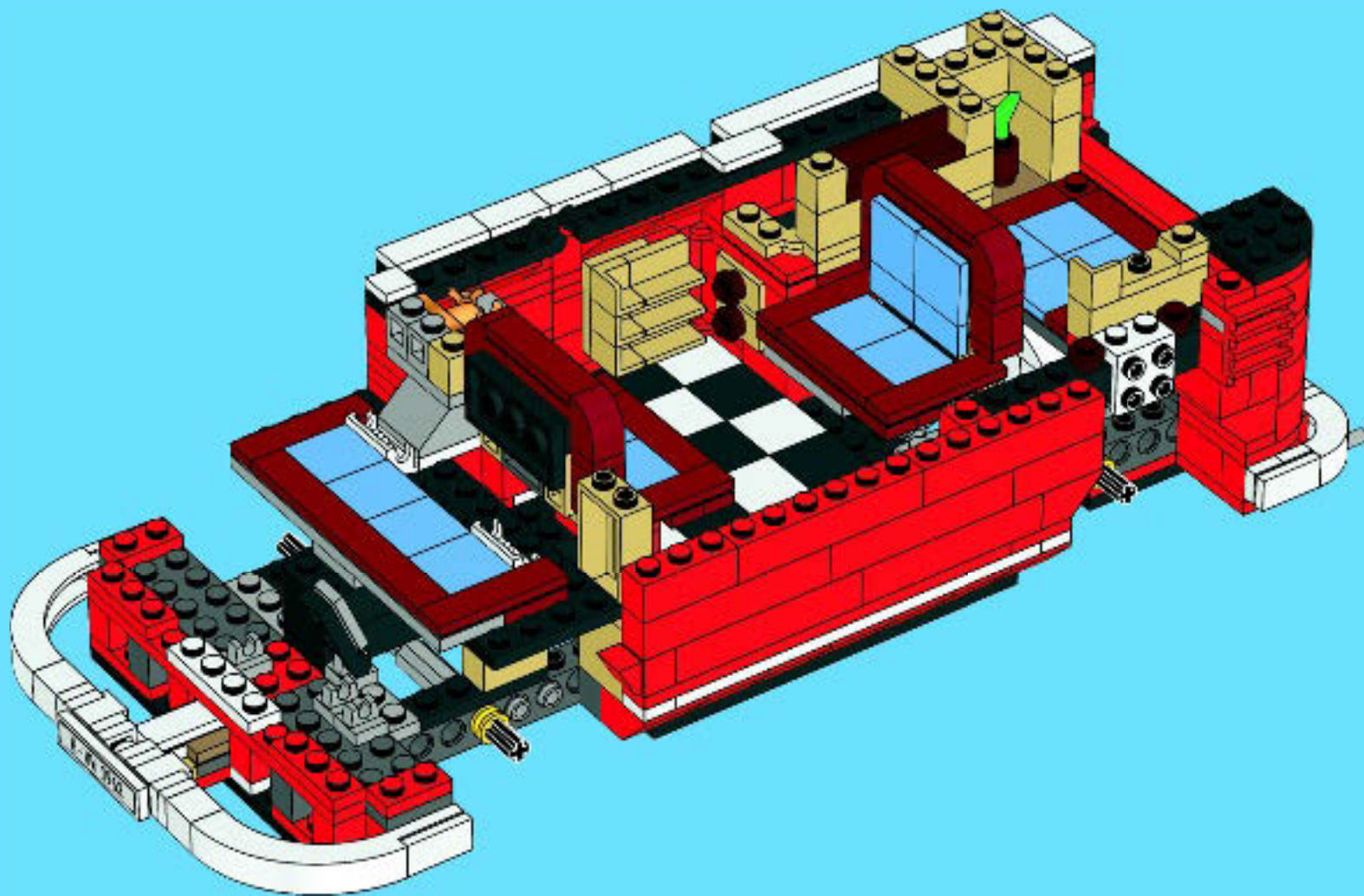

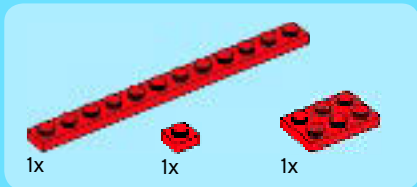

61

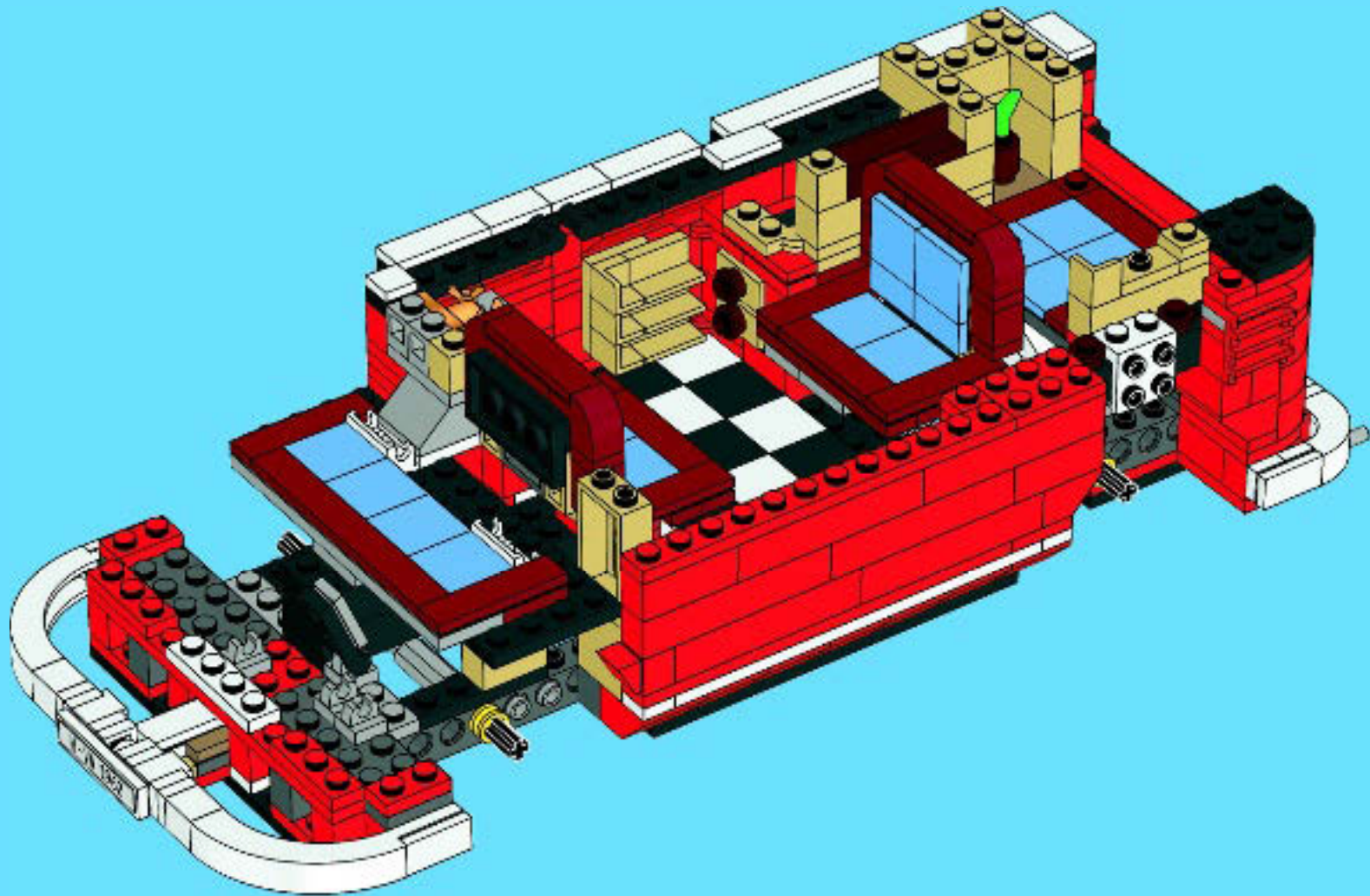



1x



1x



1x



2x



1x

# 62

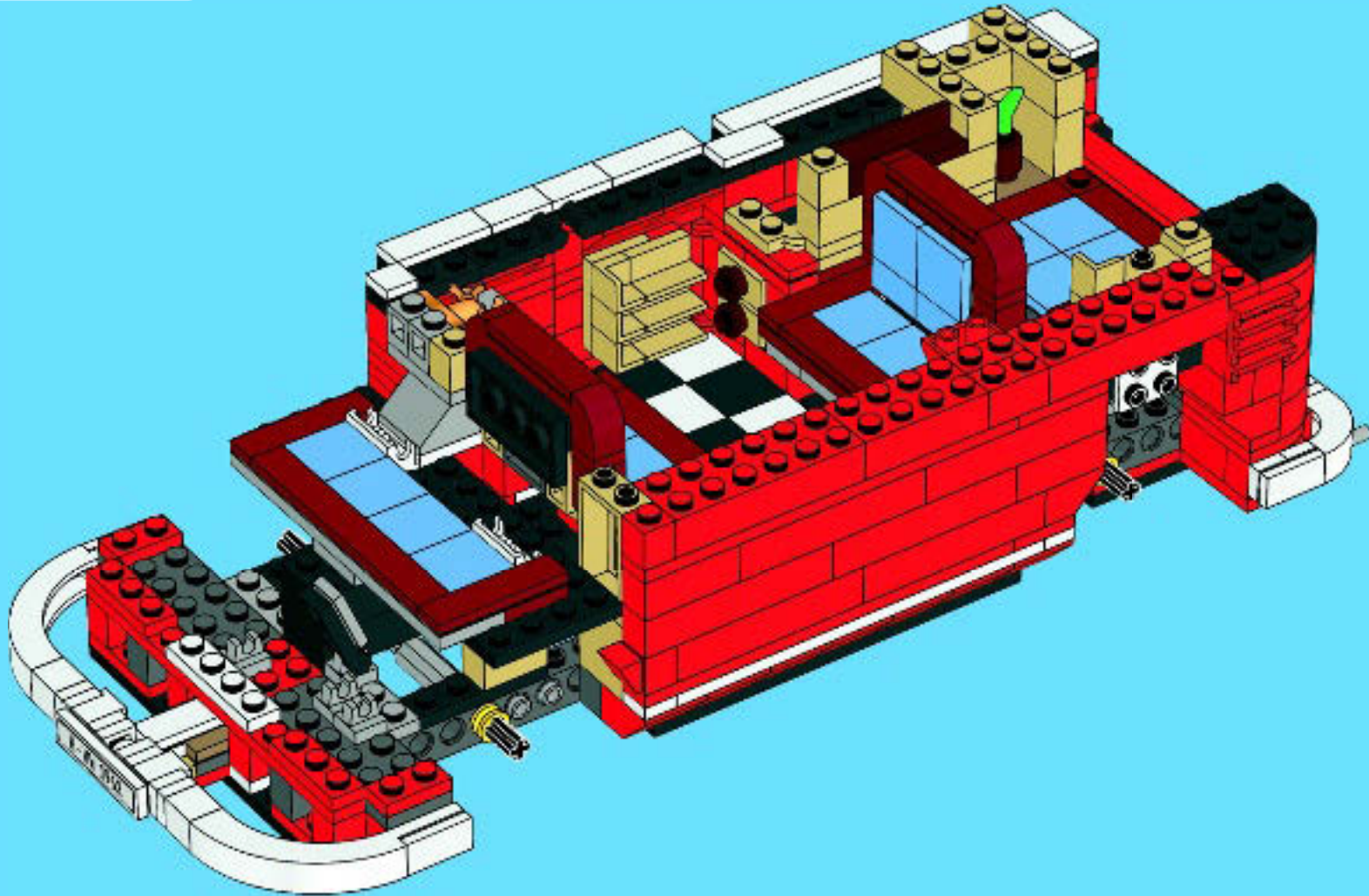





63

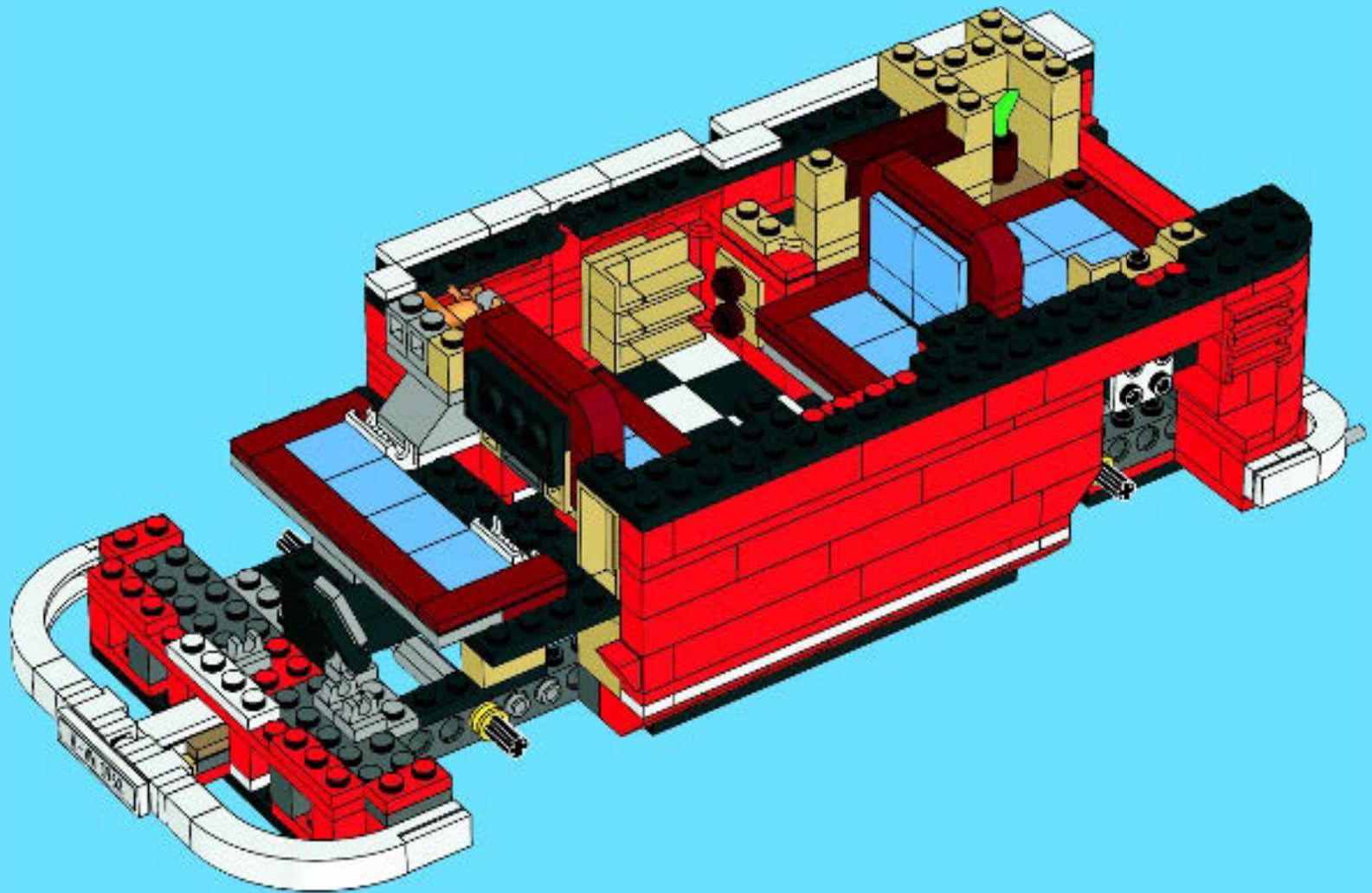

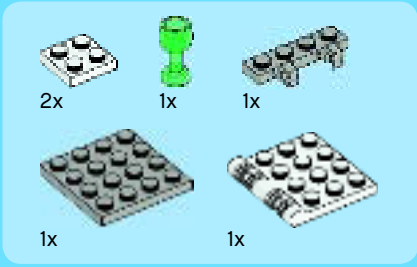

64

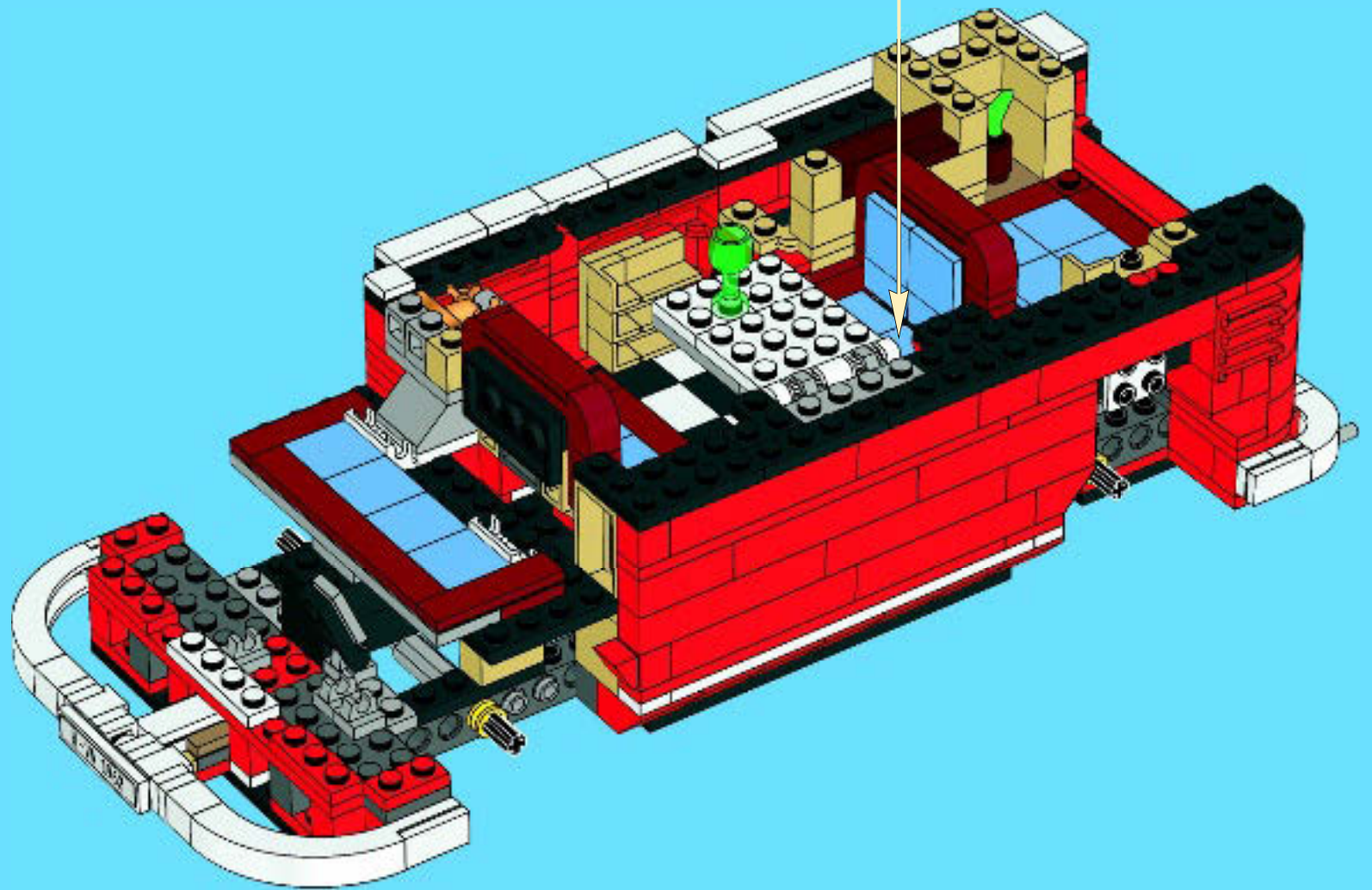

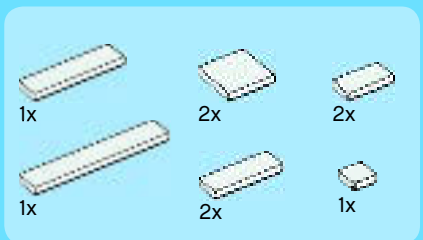

65

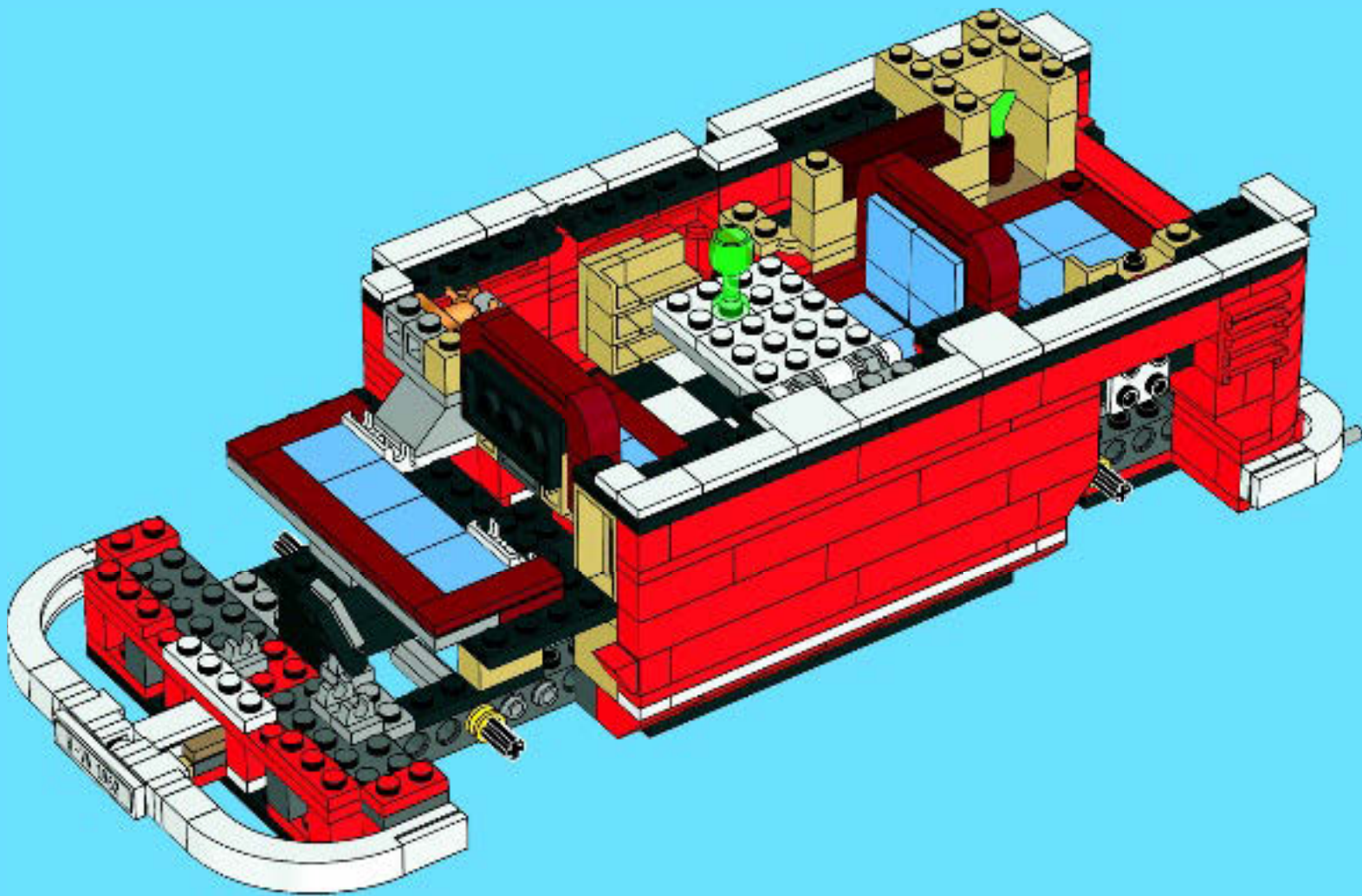



66

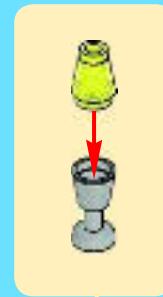
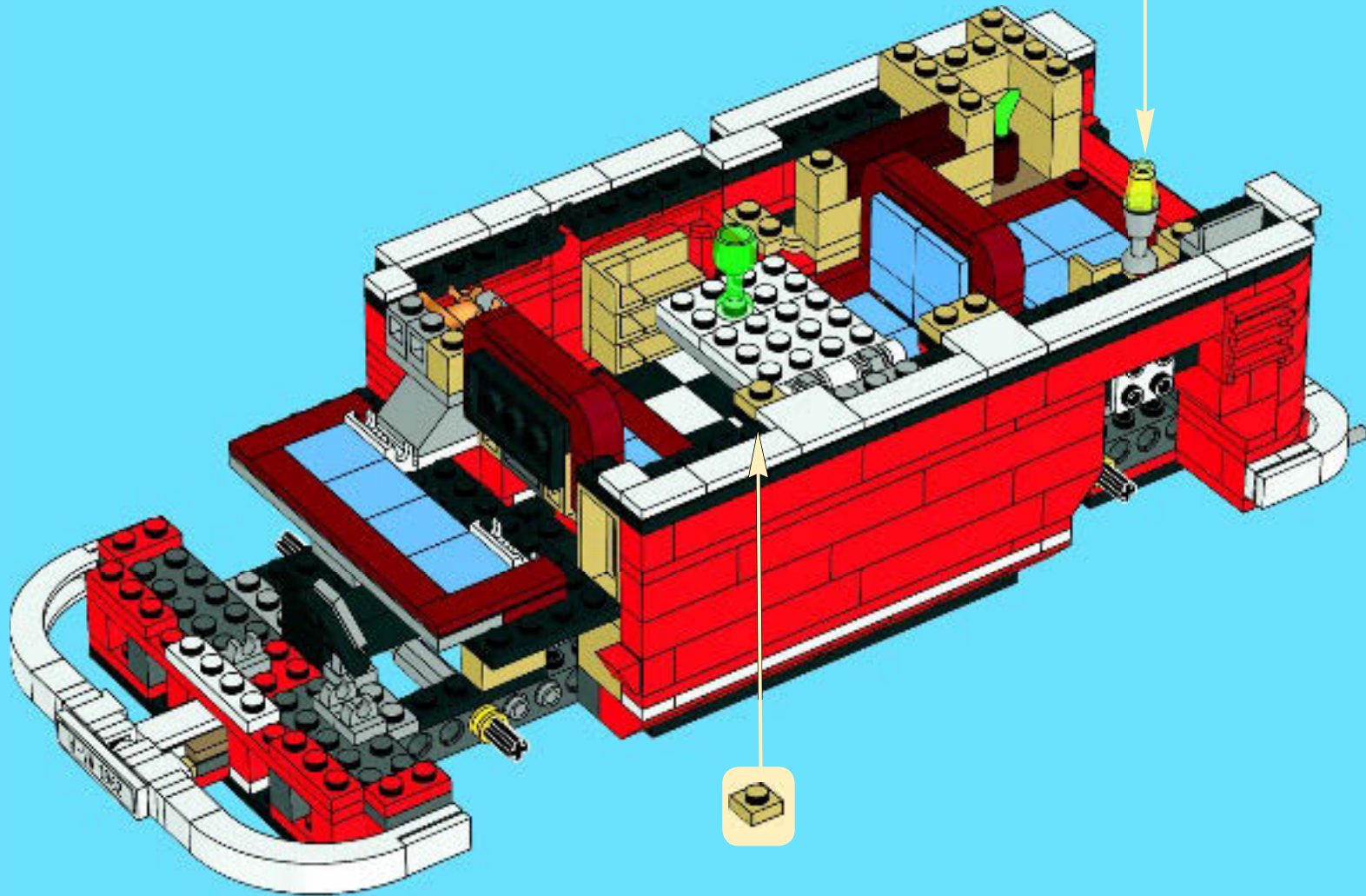

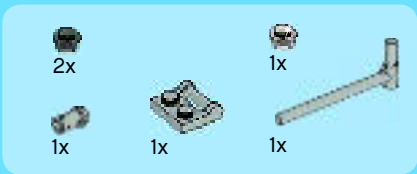

67

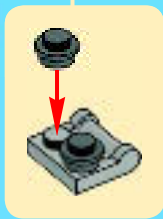
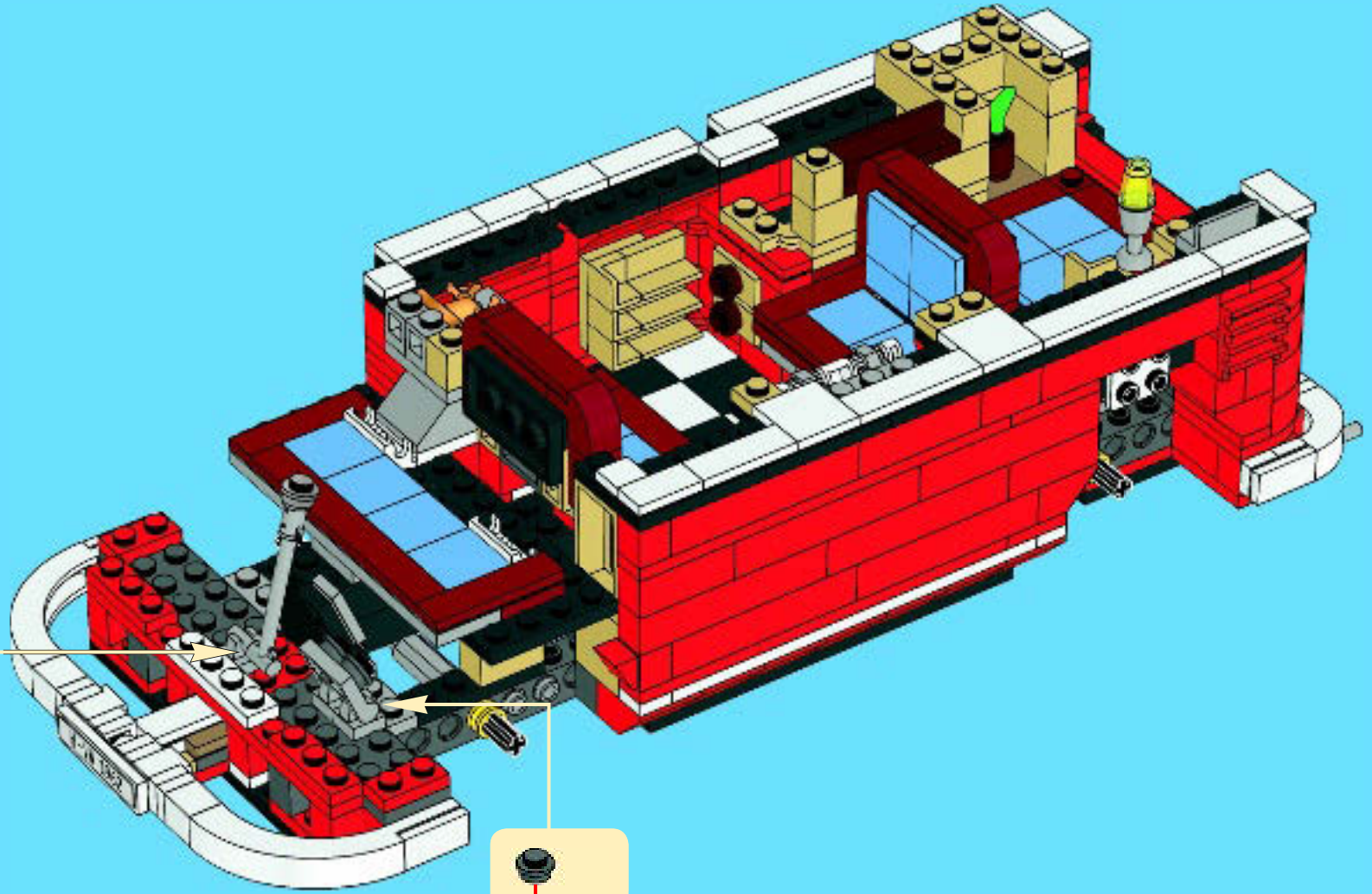
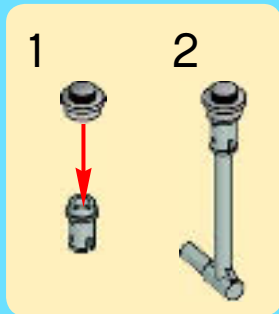



68

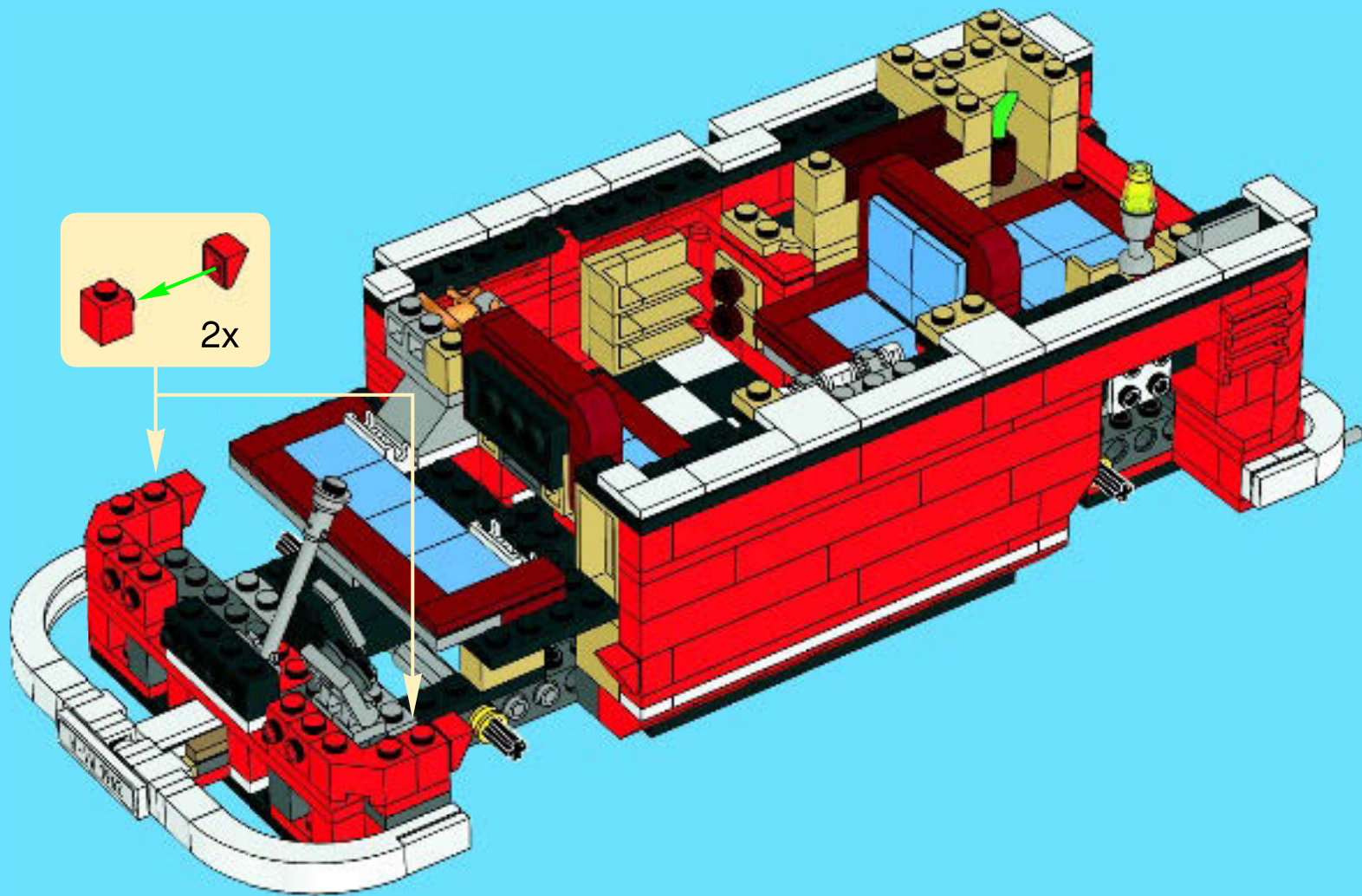



69

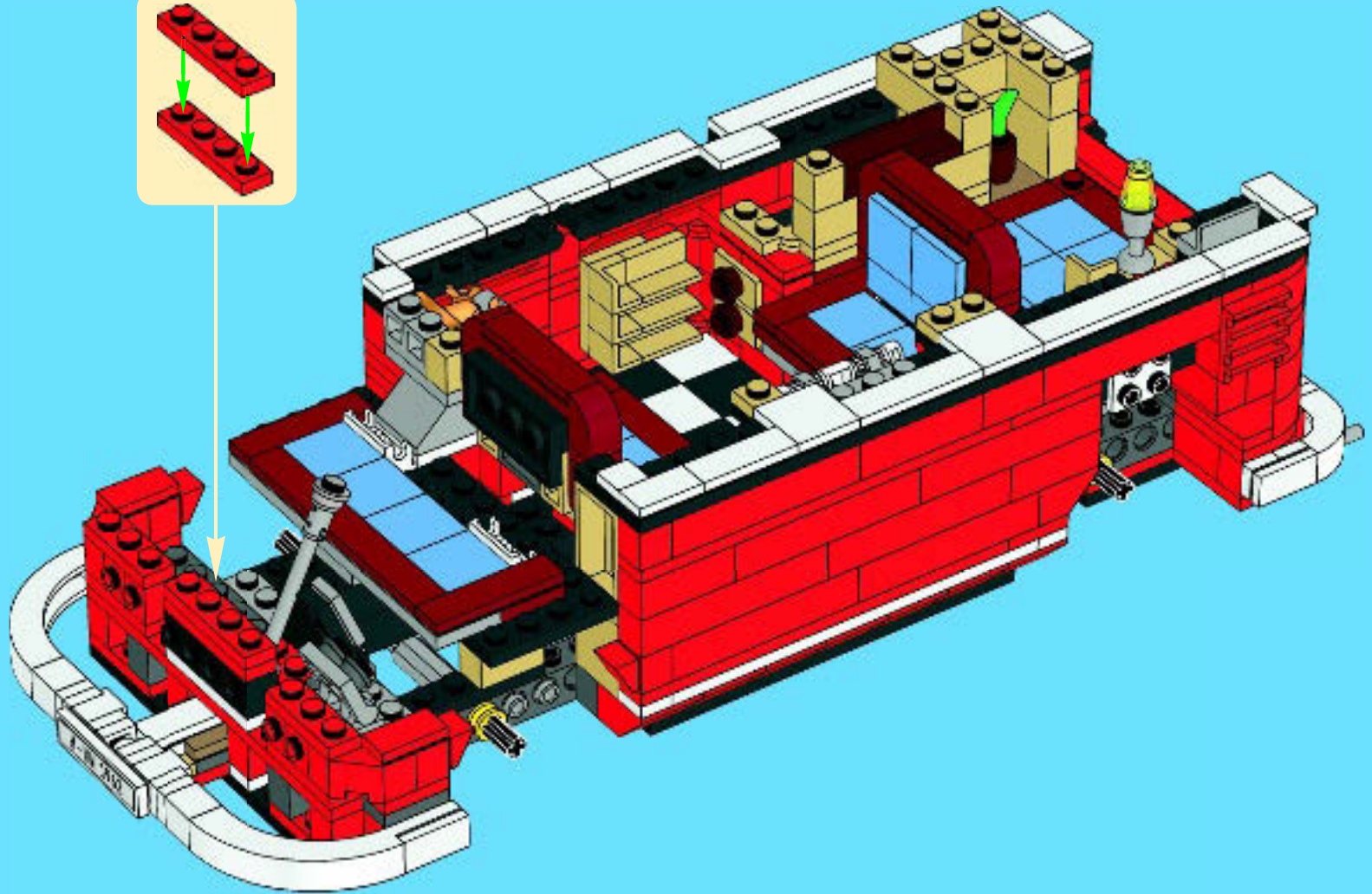
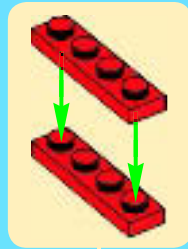

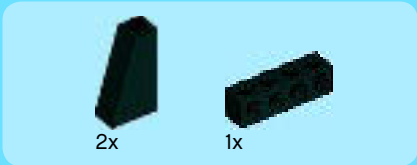

70

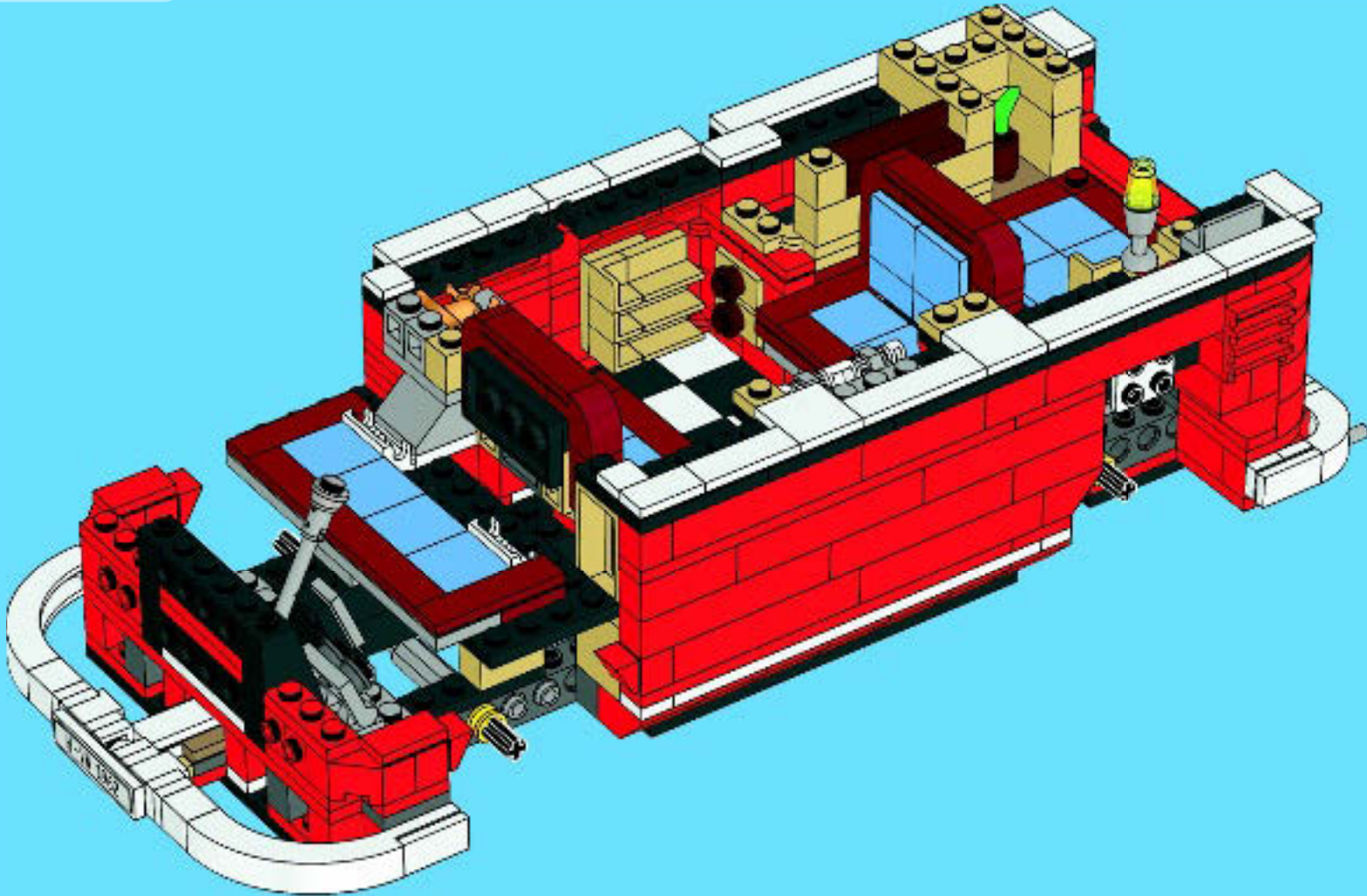



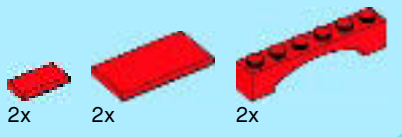

71

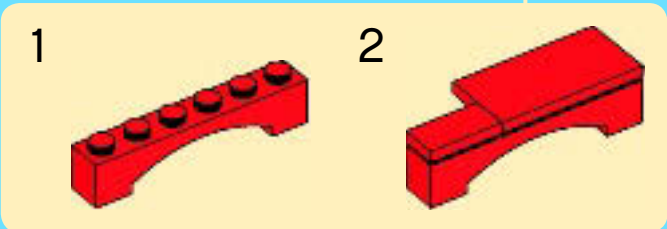
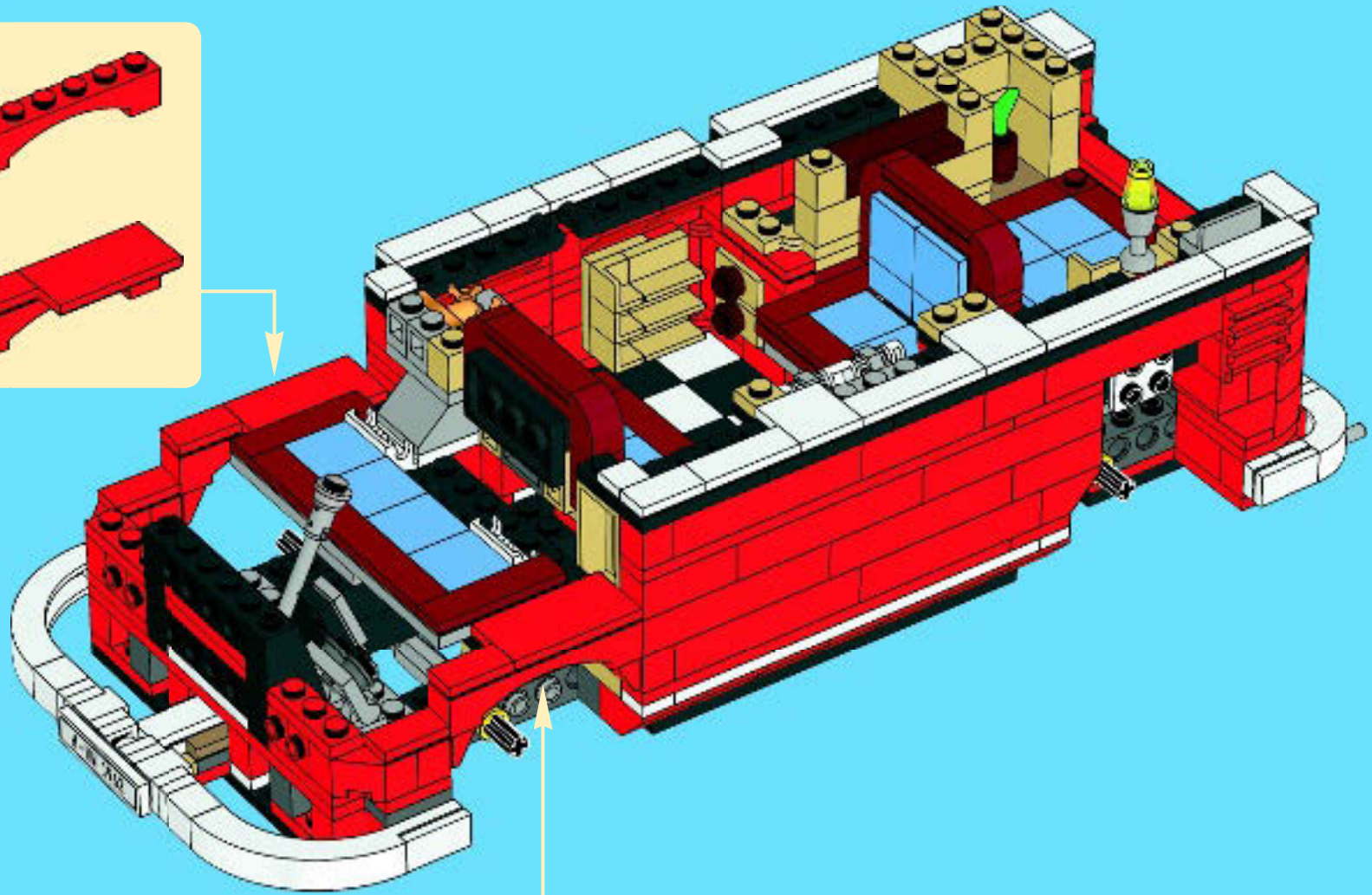
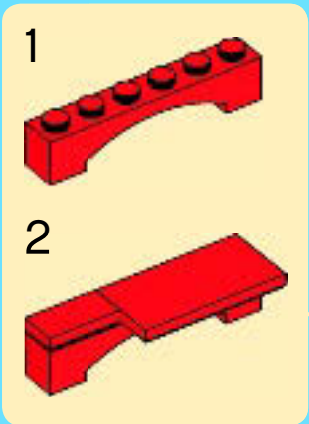



2x



2x



2x

# 72

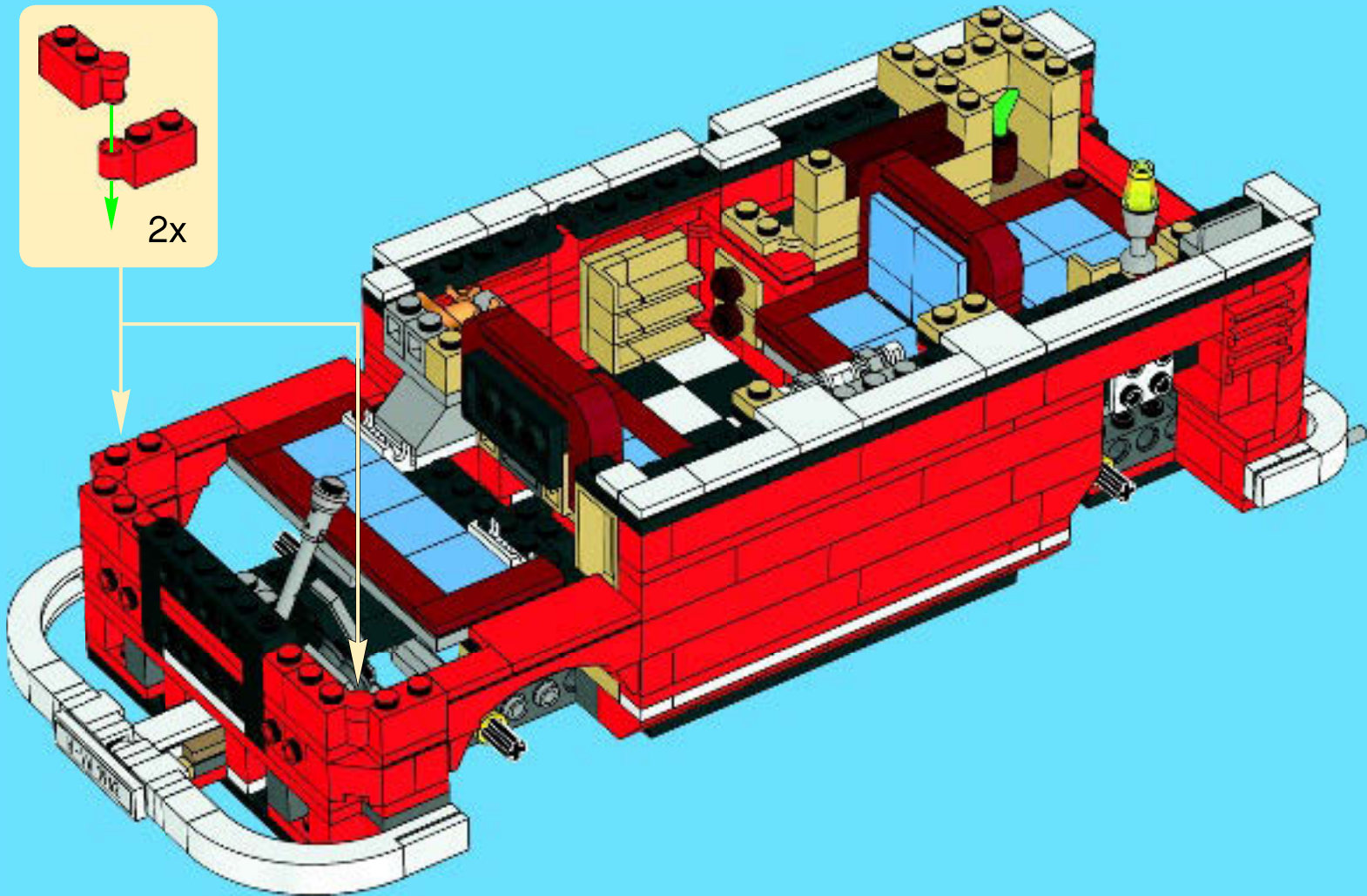
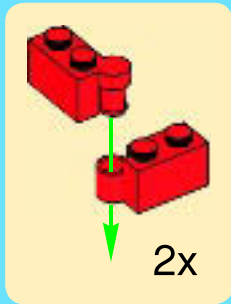



73

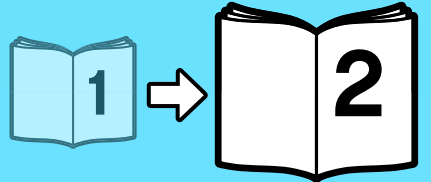
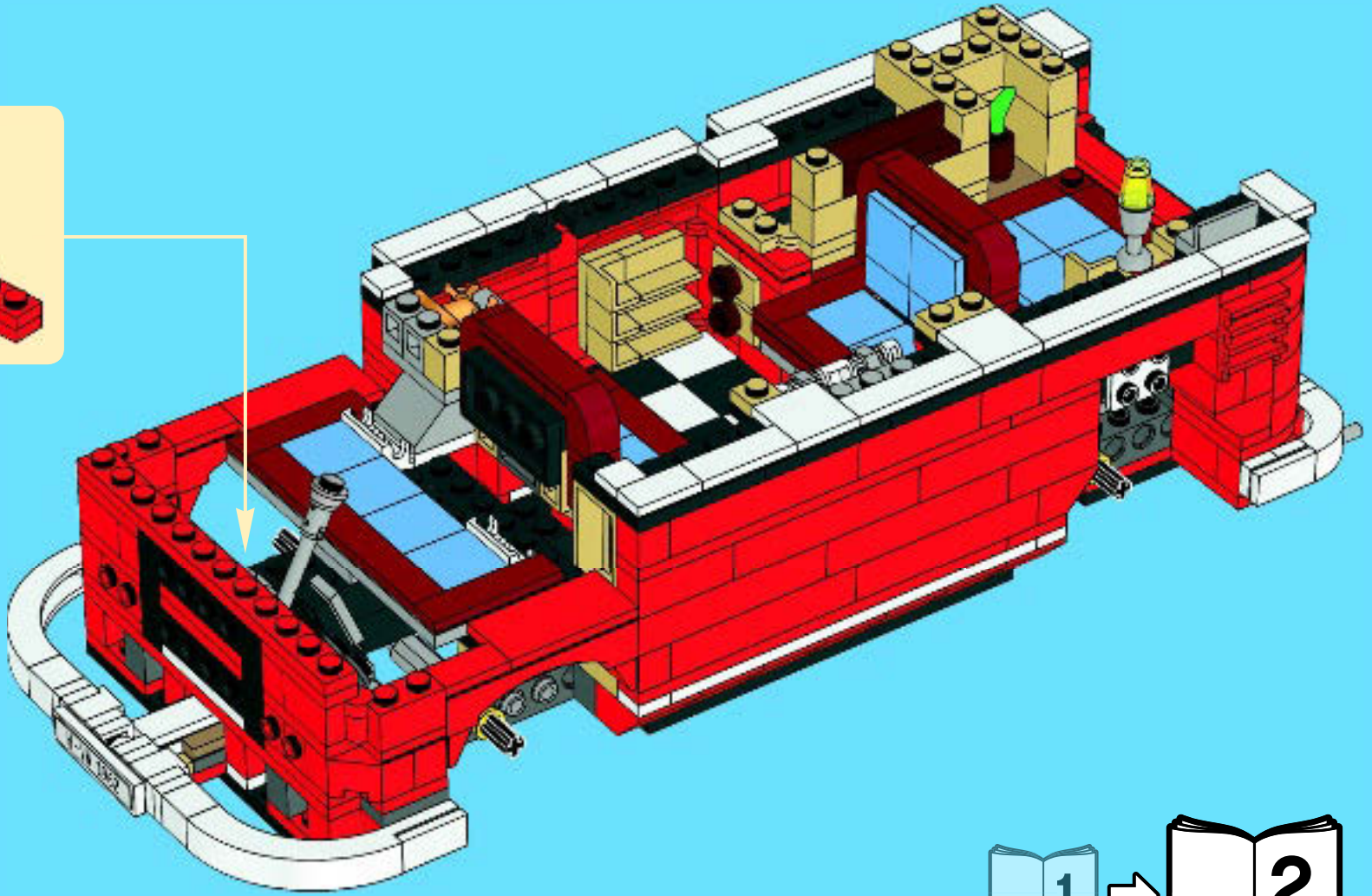
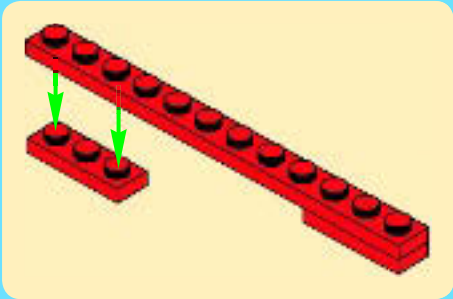



10197

10218

10211

