



10663



WARNING: CHOKING HAZARD.
Small parts. Not for children under 3 years.



LEGO.com/brickseparator

Page/Page/Page/

4-5



Page/Page/Page/

6-9



Page/Page/Page/

10-13



Page/Page/Page/

14-18



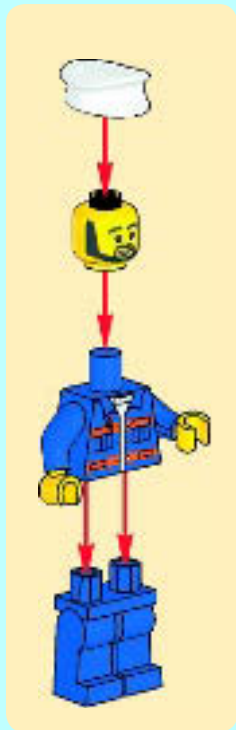



1

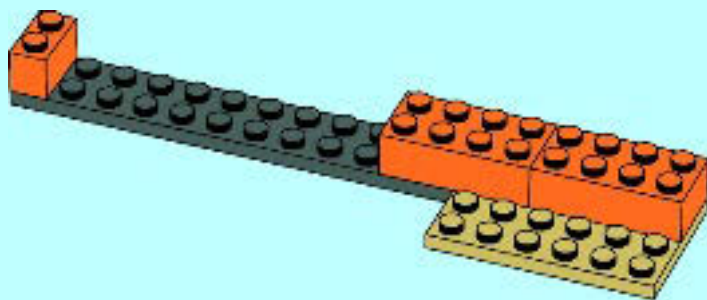

2

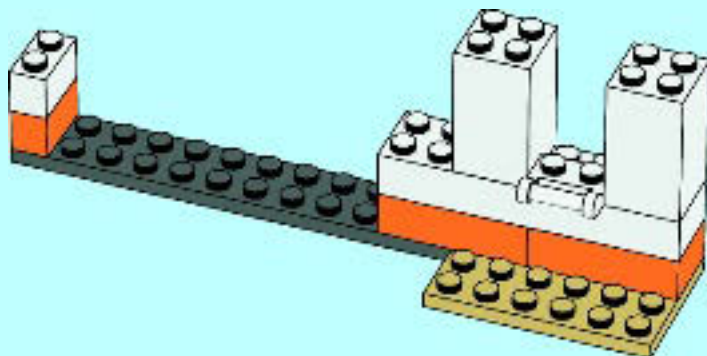

3

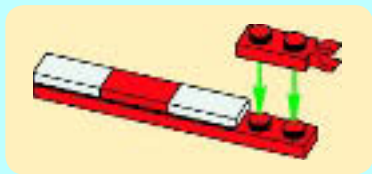
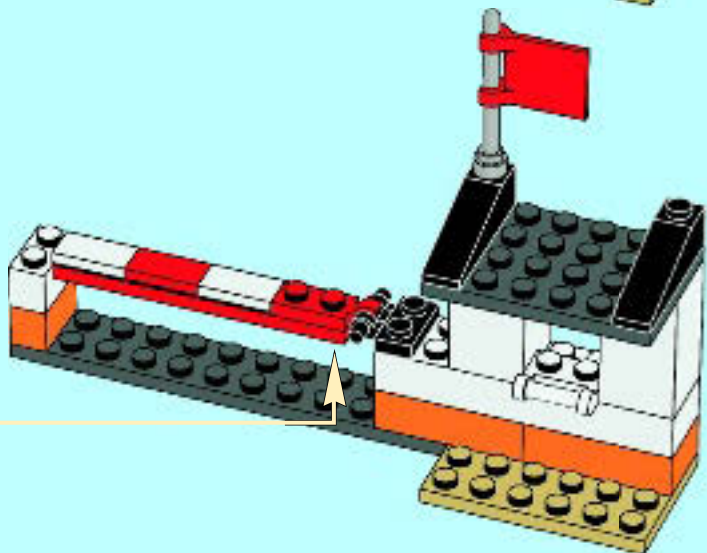





1

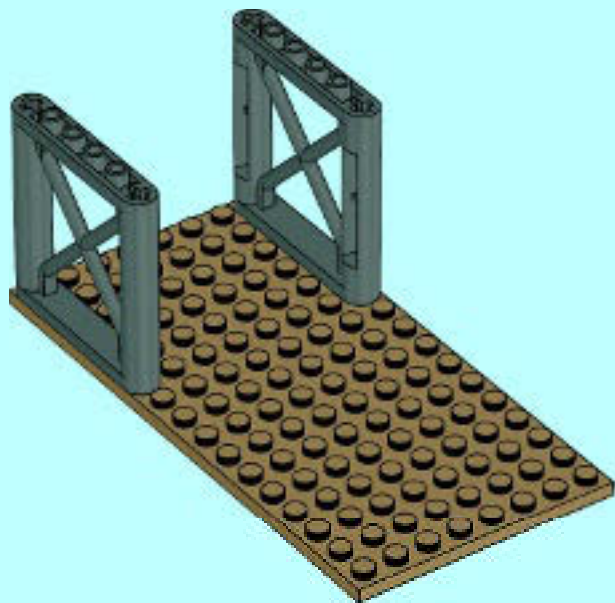

2

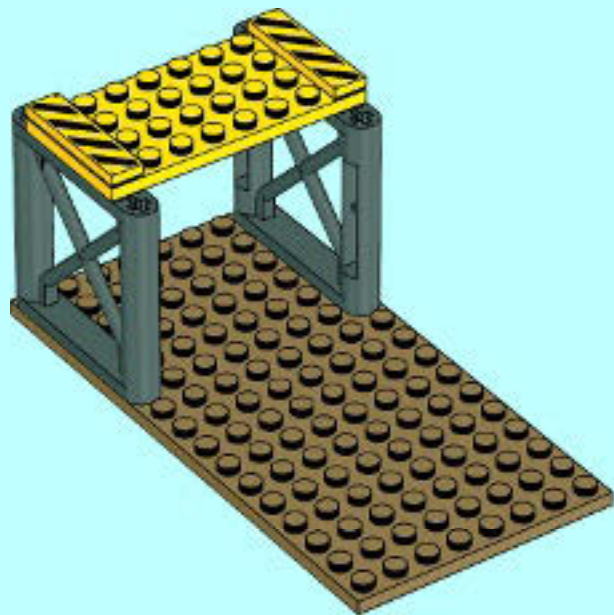

3

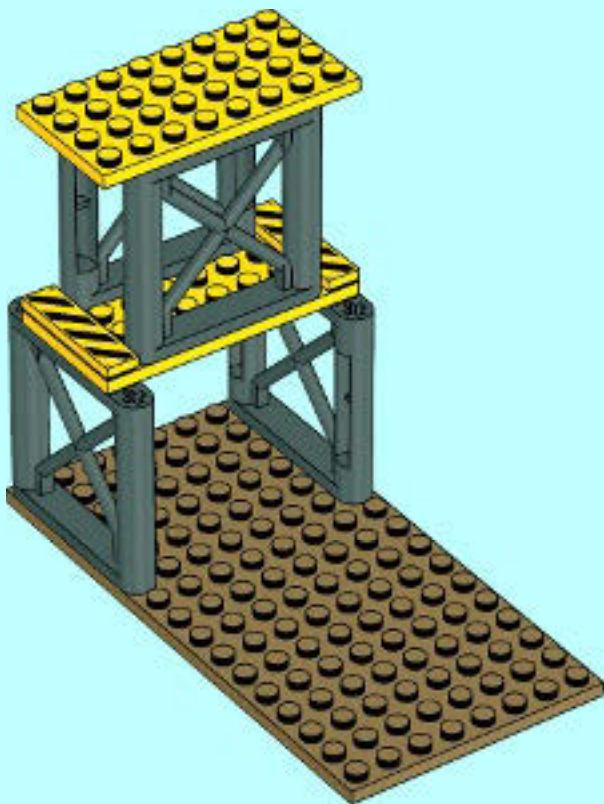

4



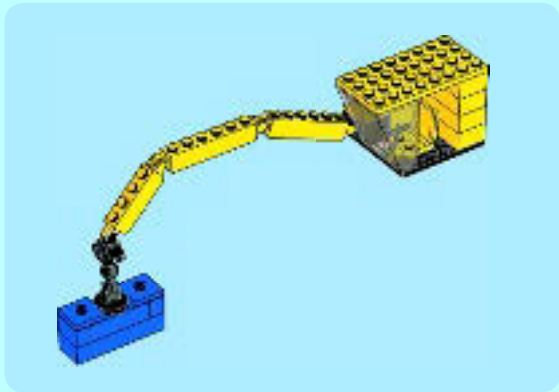

1

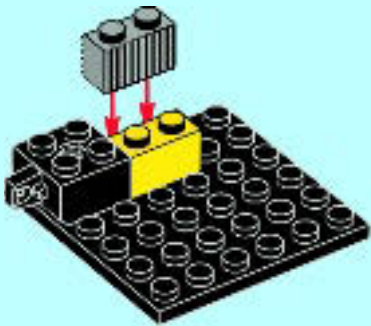

2

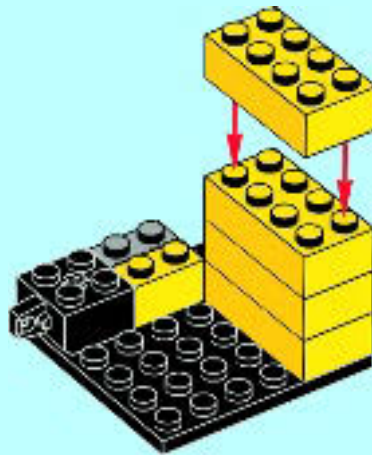

3

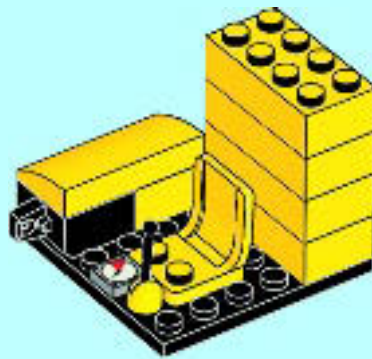

4

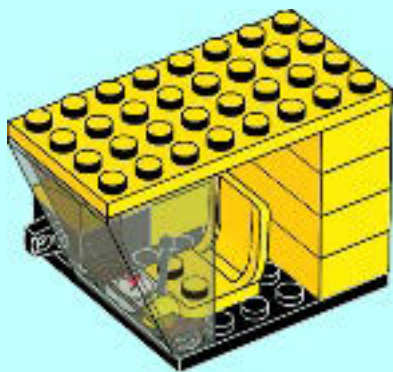

5

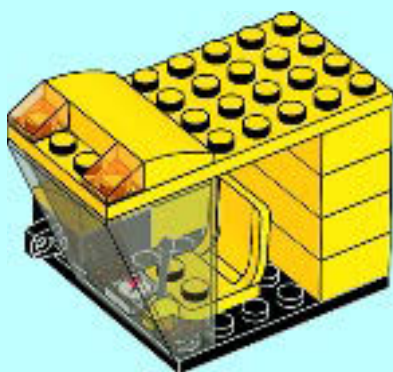

6

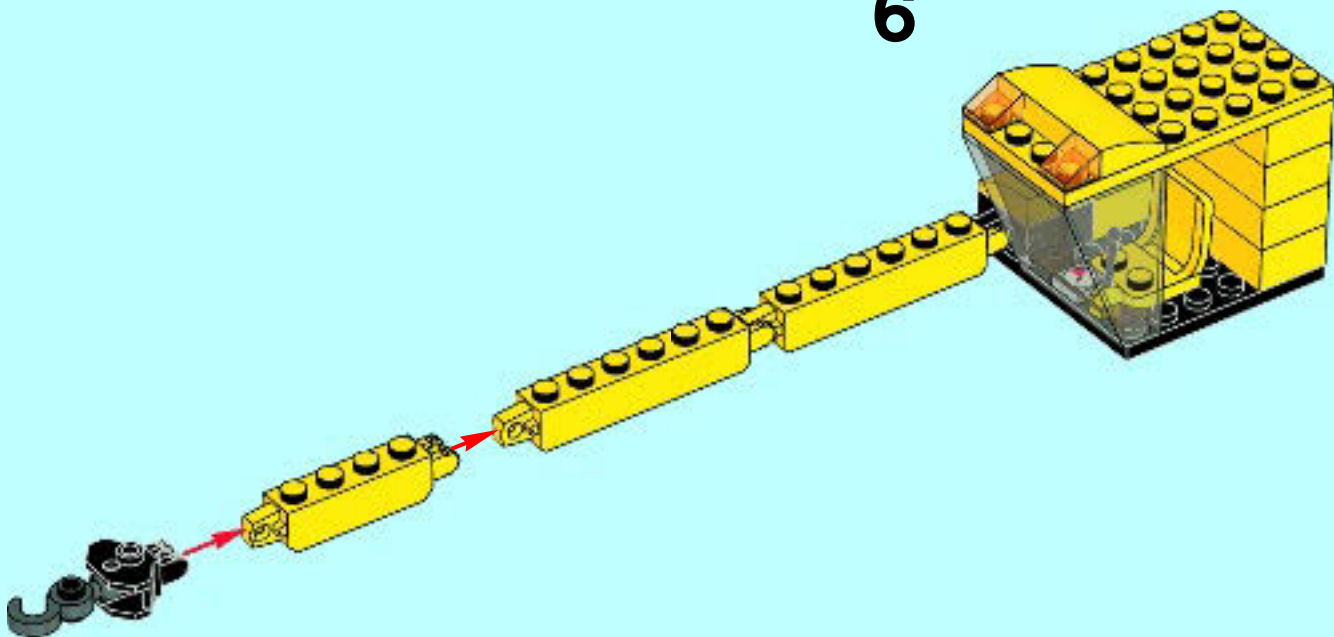

1

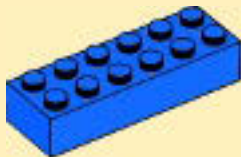

2

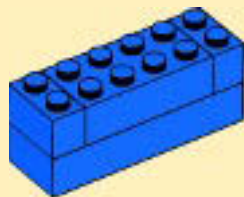

3

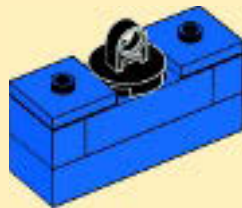

7

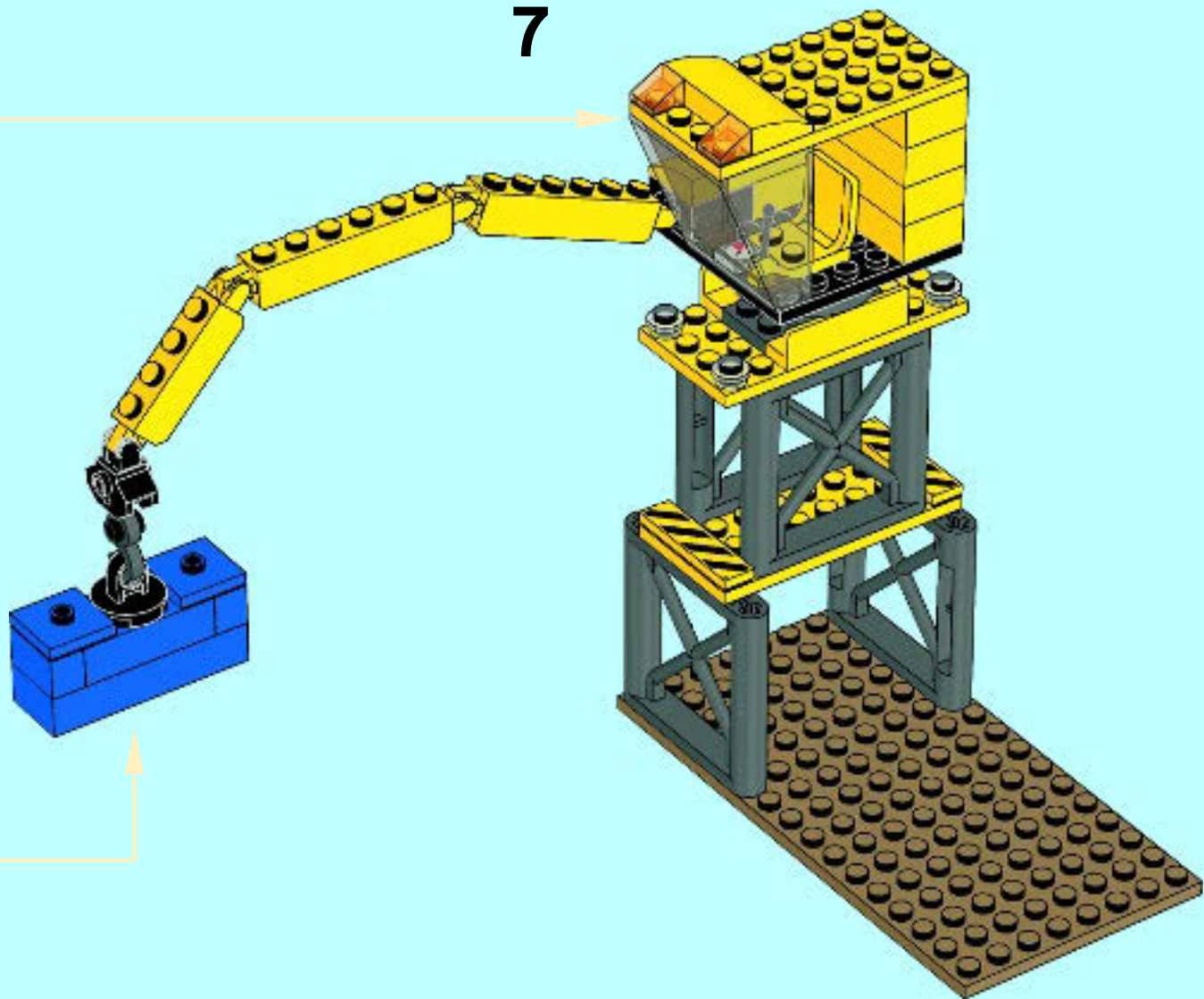



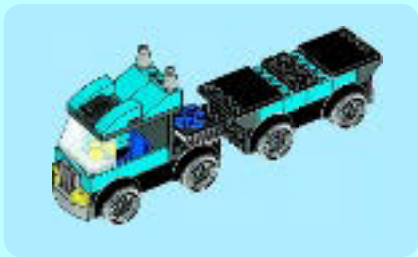

2

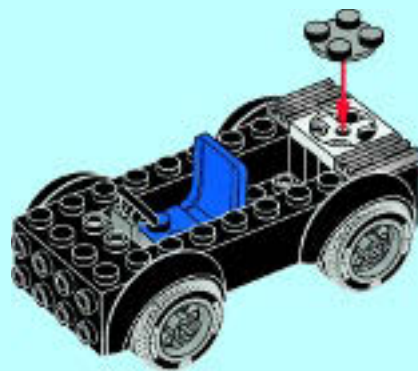

3

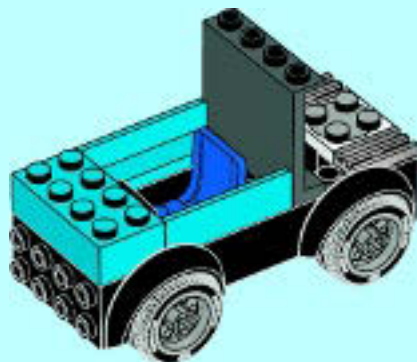

1

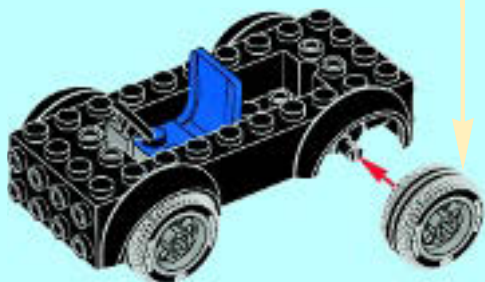

4x

4

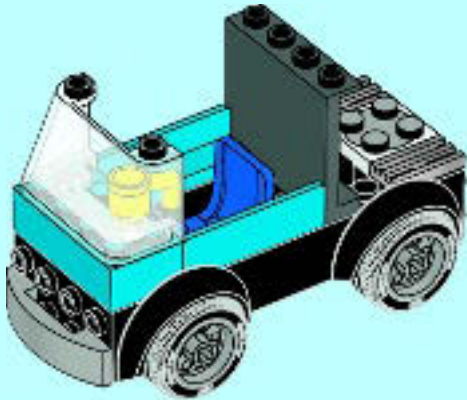

6

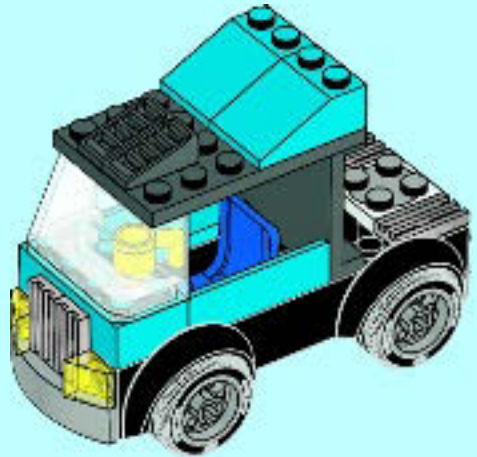

5

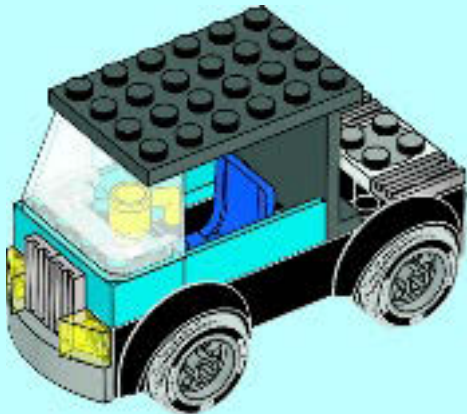

7

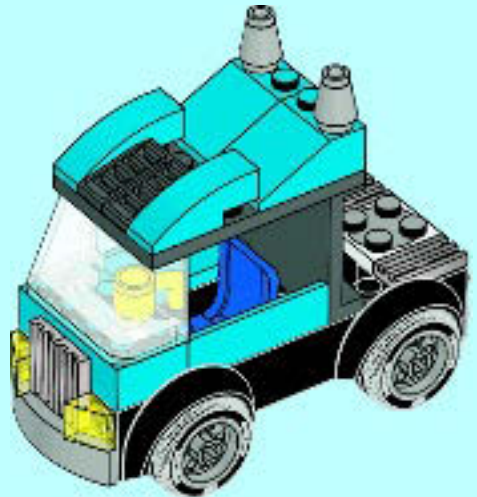



1



2

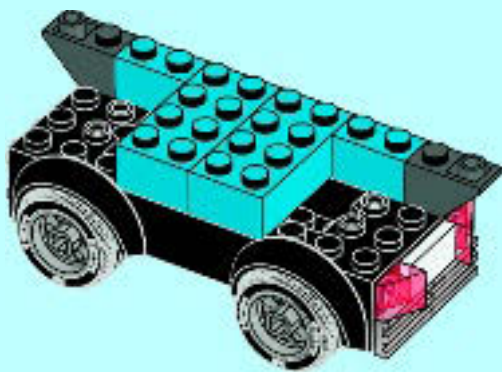

1



2



3

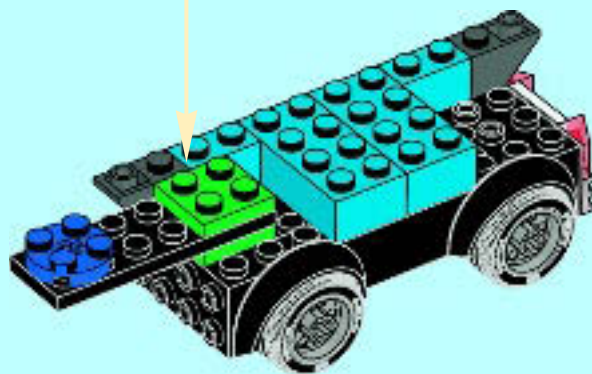

4

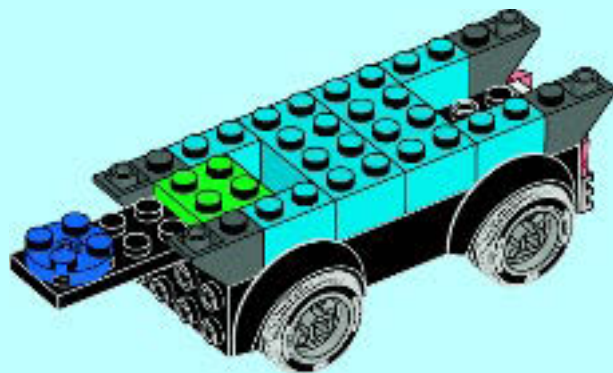

5

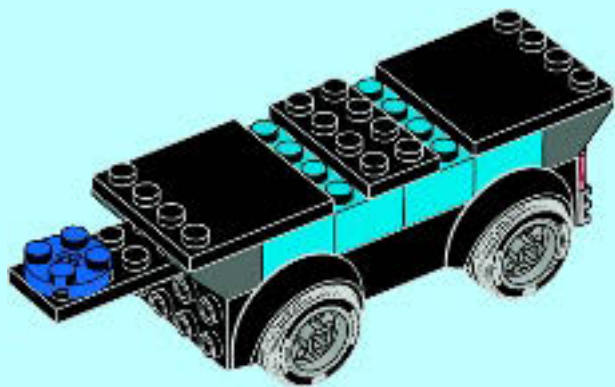

6

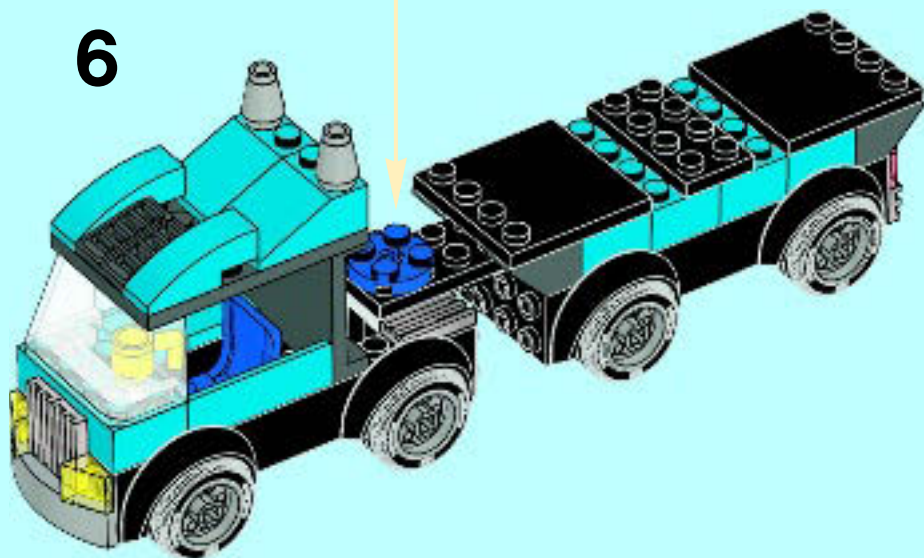





1

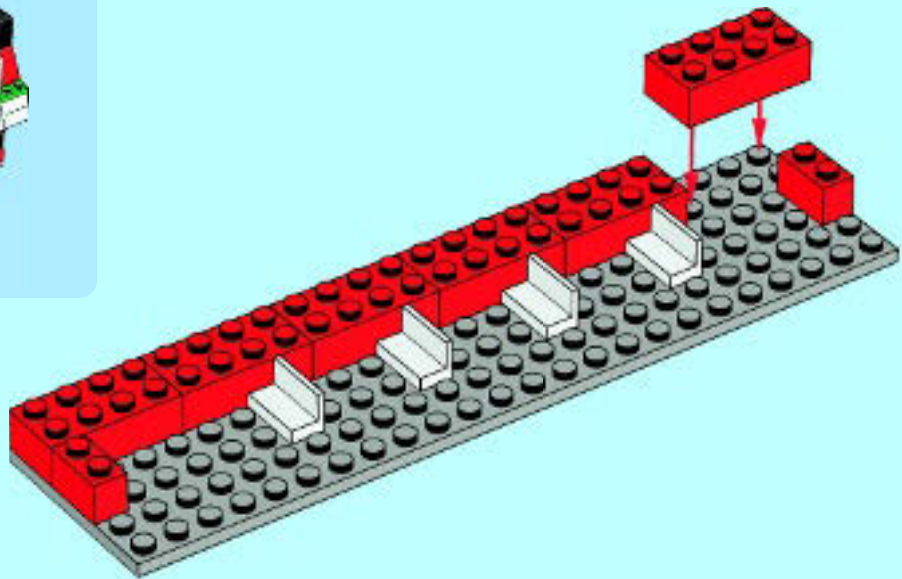

2

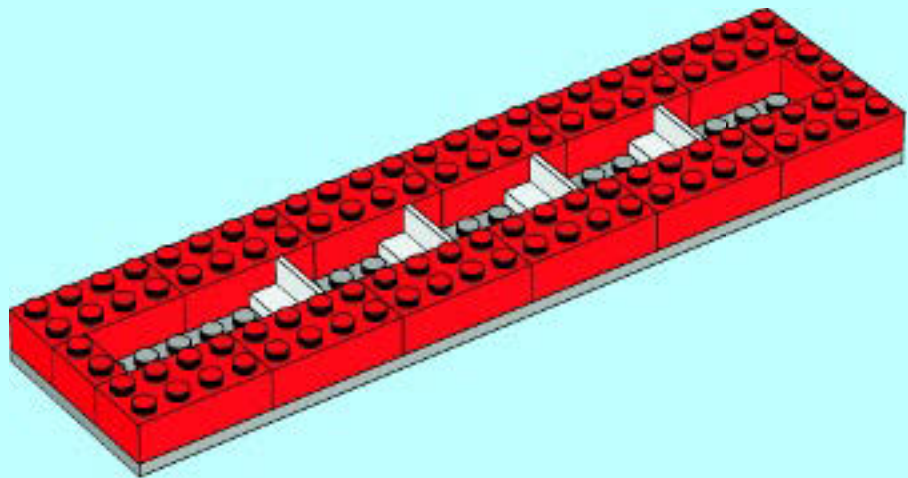

3

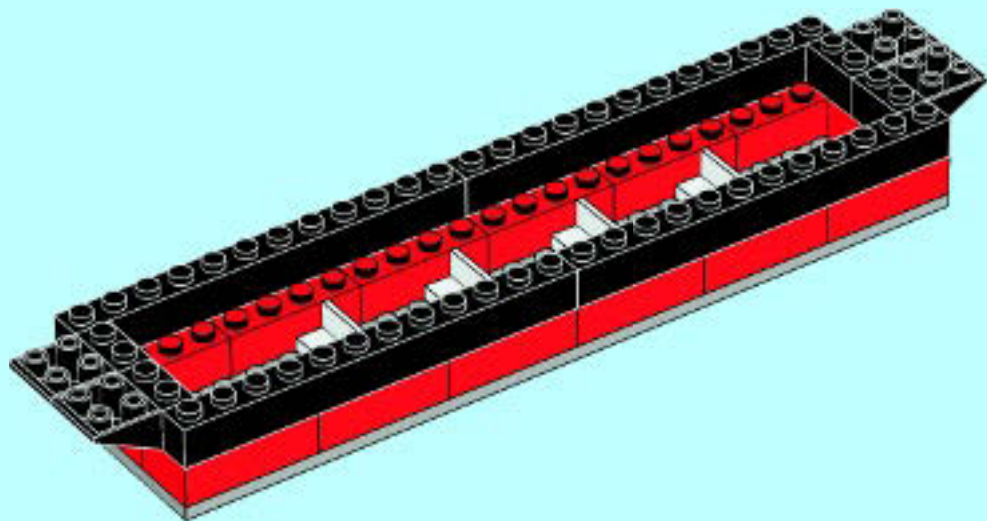

4

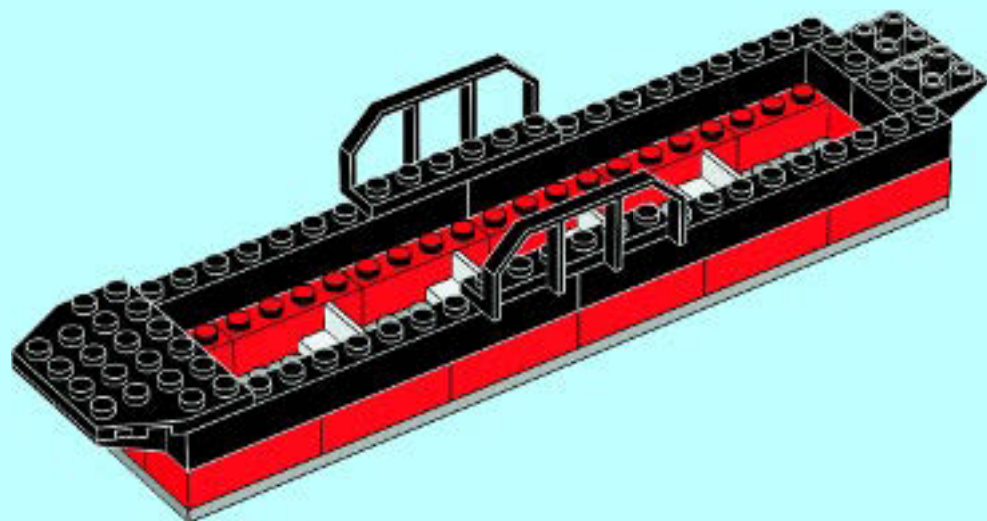



1

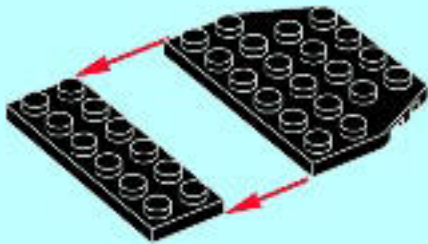

2

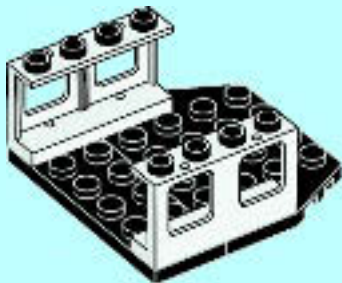

3

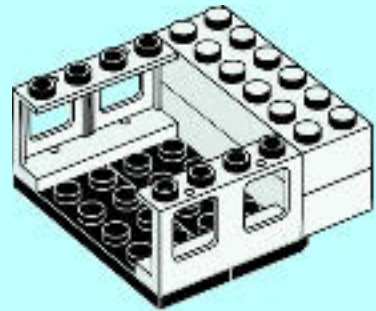

4

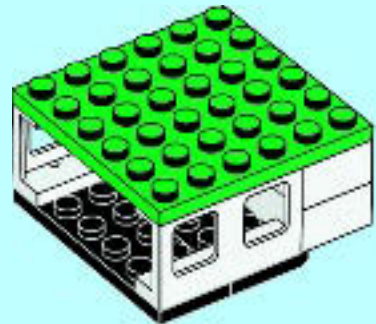

5

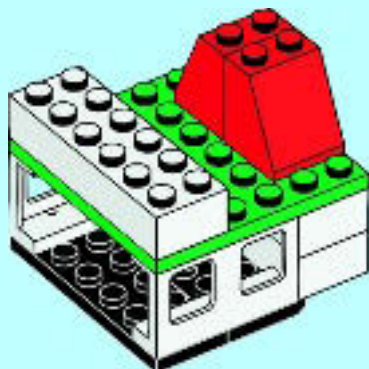

6

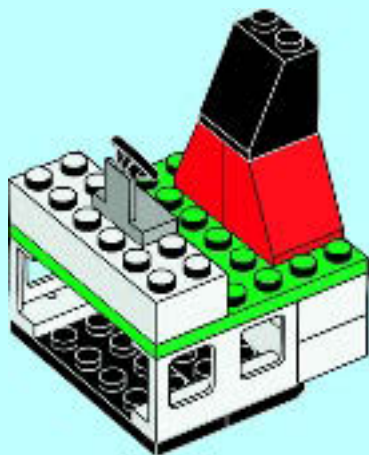

7

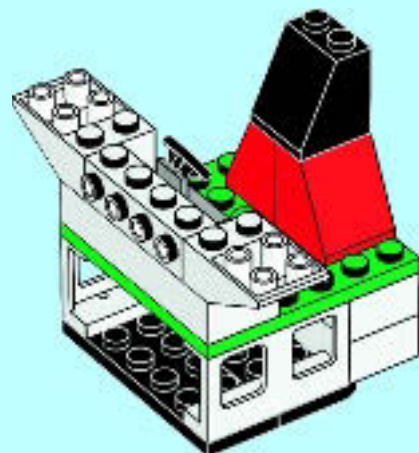

8

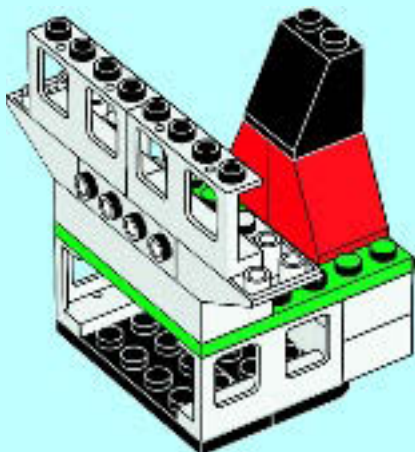

9

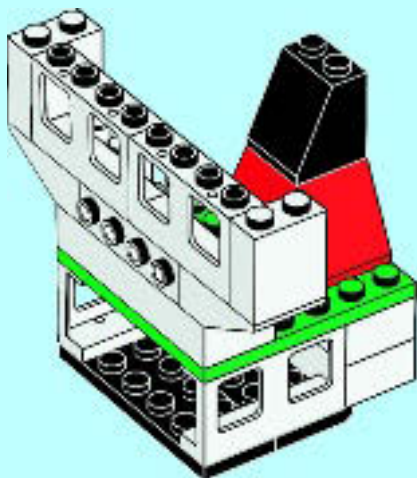

10

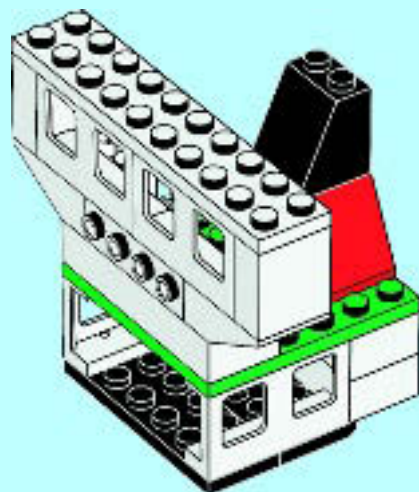

11

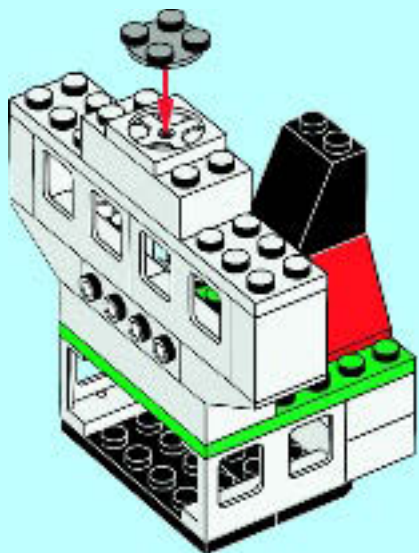

1



2



3

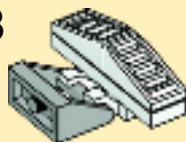

12

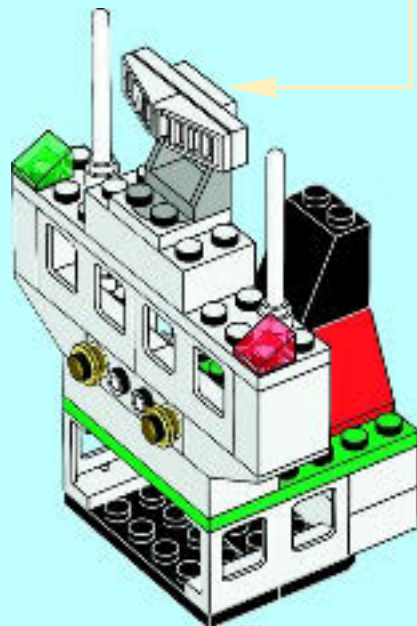

13

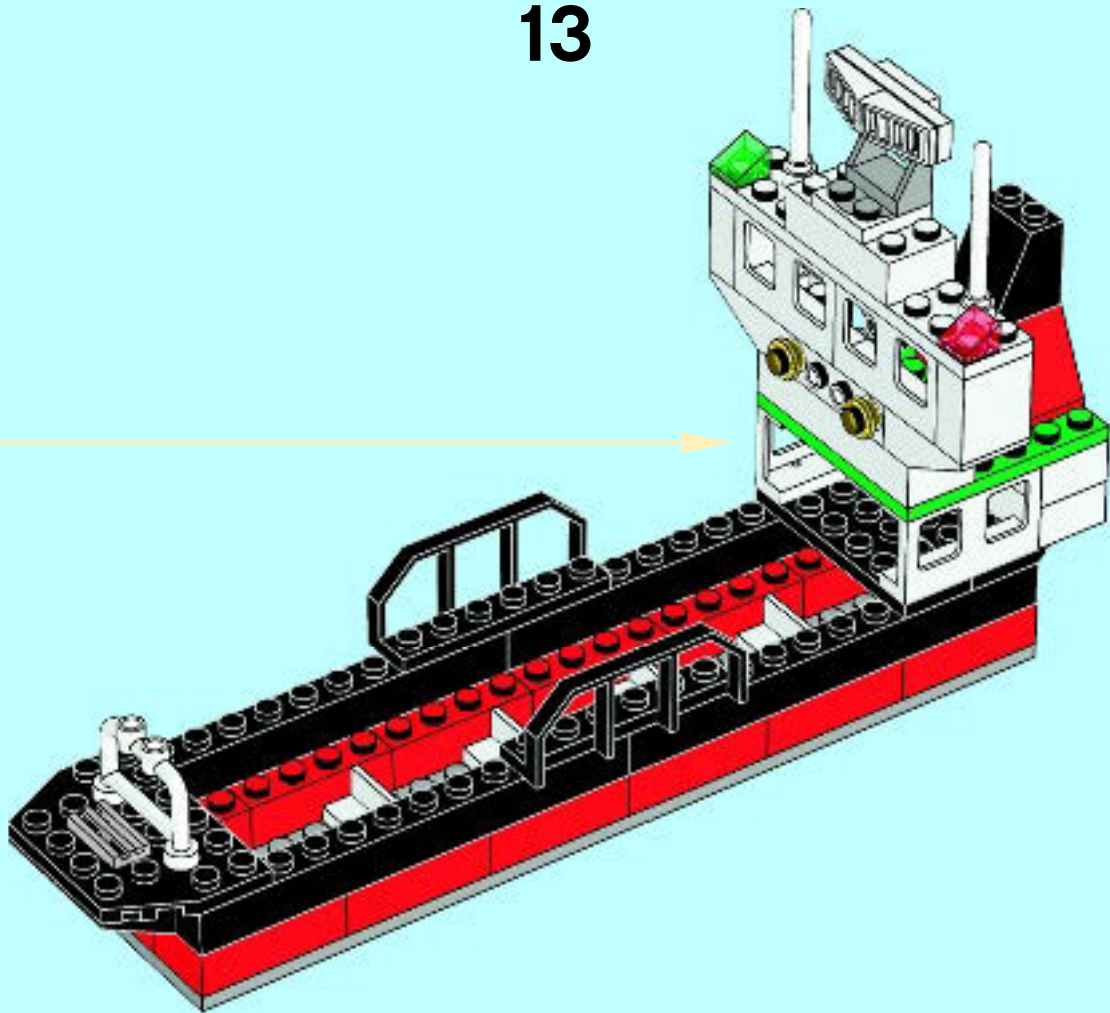

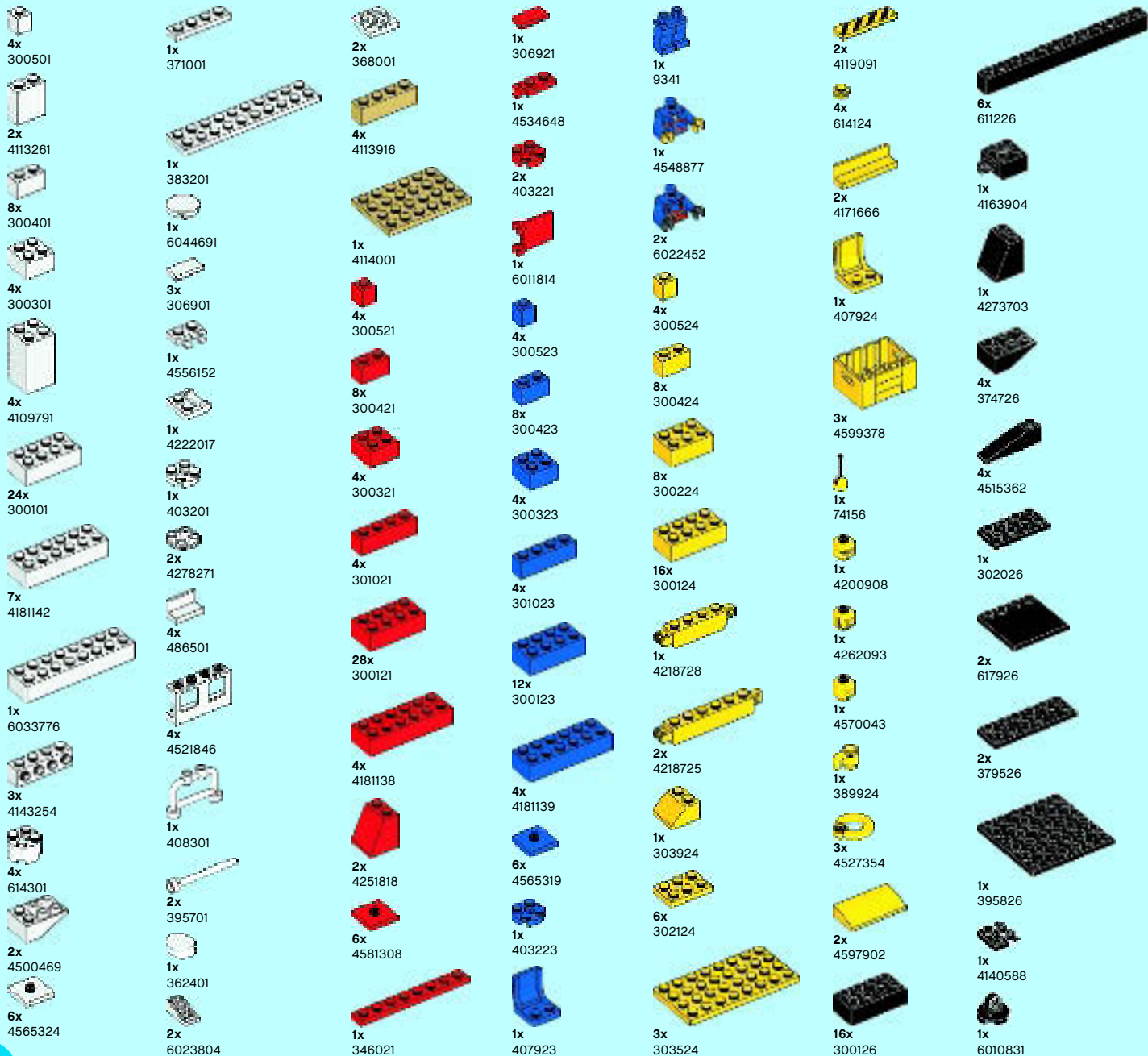



1x
4515350



1x
396026



2x
4129572



1x
459926



1x
408326



2x
658326



2x
4157108



2x
396226



1x
400626



8x
6029208



1x
4153044



1x
4539385



1x
4144567



2x
302228



2x
403228



1x
449528



6x
3005740



2x
382340



2x
4544720



4x
4244363



1x
4244366



2x
611644



4x
4260942



2x
3005744



1x
4244573



6x
4121739



4x
4118827



10x
4153827



2x
6022148



2x
4120158



1x
6012730



4x
4220634



8x
4164022



8x
4220631



4x
4234716



16x
4165967



1x
4187743

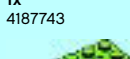

2x
4621548



2x
4244369



1x
6005772



4x
4211210



10x
4211201



16x
4211181



1x
4520612



4x
4211166



2x
4565214



1x
4211157



8x
4211387



4x
4211385



1x
4211383



2x
4641682



2x
4529241



3x
4622803



1x
4255629



12x
4565393



2x
6030711



2x
4211632



2x
4211357



2x
4211473



8x
6029209



2x
4226995



2x
4540203



4x
4211085



1x
4239373



1x
4558959



2x
4211090



4x
4211096



2x
4211115



2x
4222042



1x
6008715



1x
4211051



1x
4210698



1x
4212529



1x
4626001

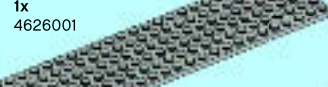

1x
4666357



1x
4624163



1x
4654448



2x
4540386



8x
4619636



4x
4611885



4x
6004943



10x
4655172



1x
4211067



4x
4542618



2x
6025012



2x
6004938



2x
6021566



2x
4640901



2x
6021547



Customer Service
Kundenservice
Service Consommateurs
Servicio Al Consumidor

LEGO.com/service or dial



1-800-422-5346



10660



10659



10655



5508



10657



10661



10656



5560



4625



6166



4626



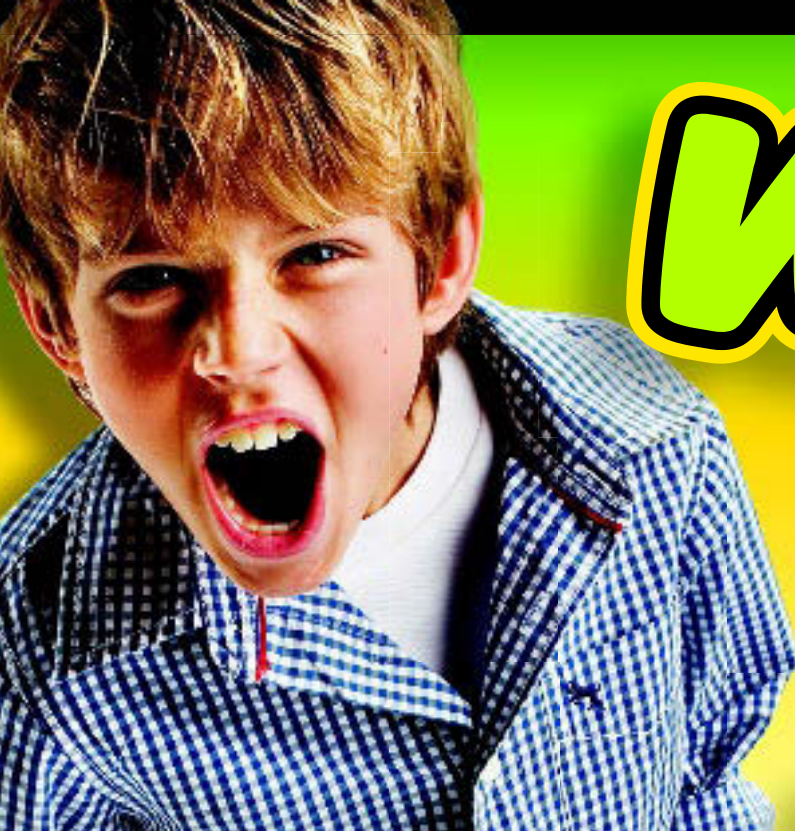

WIN!

Go to www.LEGOsurvey.com/product to fill out a survey for a chance to win a cool LEGO® Product.

No purchase necessary.

Open to all residents where not prohibited.



www.LEGOsurvey.com/product

GEWINNE! WIN!

Nimm an der Umfrage auf www.LEGOsurvey.com/product teil und hab die Chance ein cooles LEGO® Produkt zu gewinnen!

Die Teilnahme am Gewinnspiel führt zu keinerlei Kaufverpflichtungen. Teilnahme in allen nicht ausgeschlossenen Ländern möglich.

Ga naar www.LEGOsurvey.com/product, vul een enquêteformulier in en maak kans op een cool LEGO® product.

Geen aankoopverplichting. Iedereen mag deelnemen, uitgezonderd ingezetenden van landen waar een enquêteverbod geldt.

GAGNE! 当てよう!

Visite www.LEGOsurvey.com/product pour répondre à un questionnaire et avoir une chance de gagner un produit LEGO® très cool!

Aucune obligation d'achat. Ouvert à tous les résidents des pays autorisés.

www.LEGOsurvey.com/product にアクセスして、アンケートにご記入ください。当選者にはレゴ®製品を差し上げます。

お買い上げの必要はありません。

禁止されていない限り、すべての皆様にご利用いただけます。