



Architecture^o

Solomon R. Guggenheim Museum[®]
New York City, New York



Frank Lloyd Wright

Frank Lloyd Wright, 1867–1959, is recognized worldwide as one of the greatest architects of the 20th century. His work heralded a new thinking in architecture, using innovations in design and engineering made possible by newly developed technology and materials.

No other American architect's work endures, or remains as endearing, as that of Frank Lloyd Wright. His was a unique style rooted in nature, that he called "organic architecture", emphasizing the harmonious relationship between a building and its landscape. It changed how we came to view our buildings, towns, and the land around us.



Photo: OBMA. © F.L. Wright Fdn.

Frank Lloyd Wright

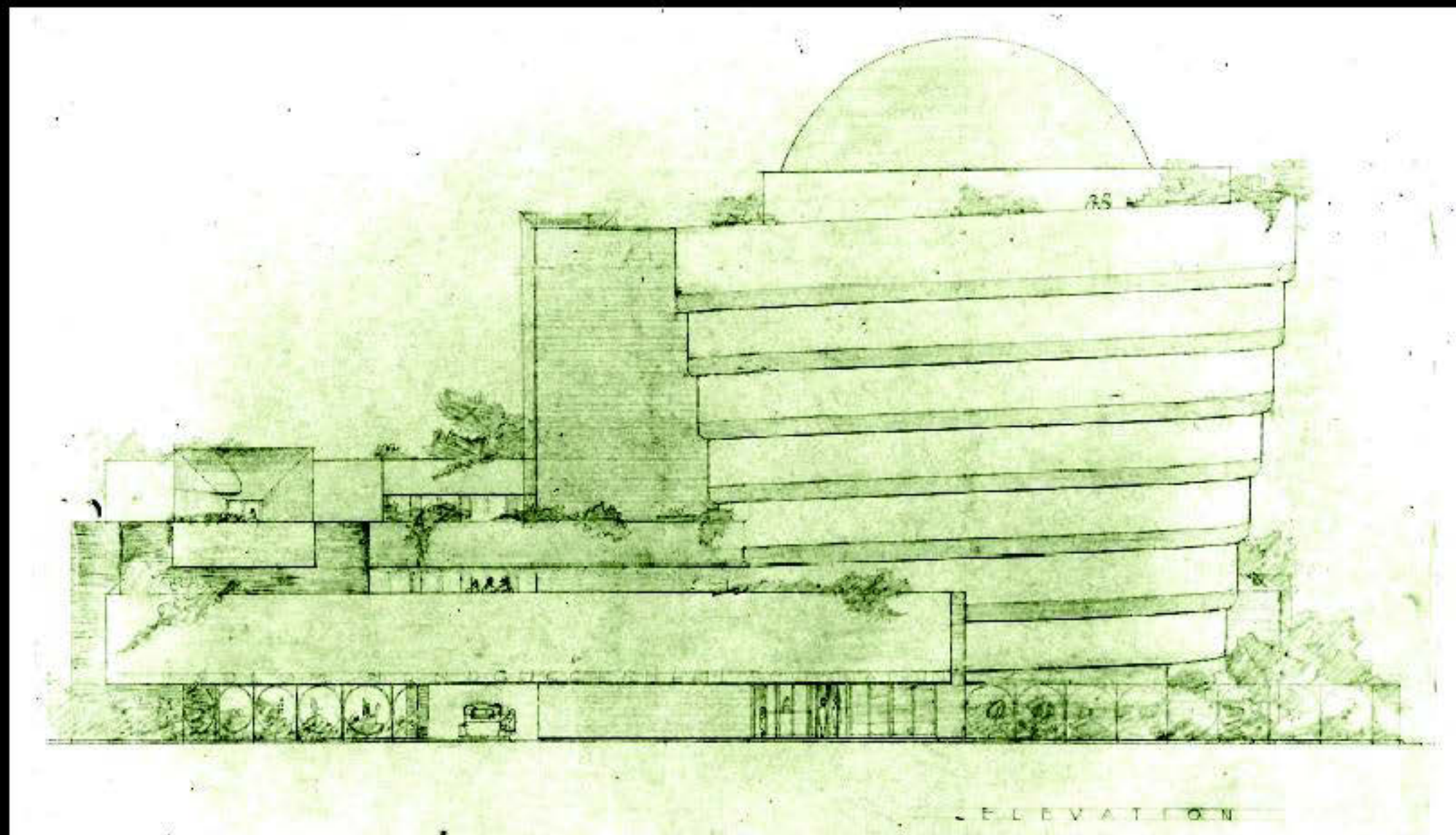

© F.L. Wright Fdn.

History of the Solomon R. Guggenheim Museum®

"The commission for the museum building first came to Wright in 1943 from Hilla Rebay. The Baroness von Rebay was the curator of the 'non-objective' painting collection she had encouraged Solomon R. Guggenheim to purchase. Solomon R. Guggenheim desired an architectural environment in which to present these new works that would be as revolutionary as the paintings in his collection themselves.^[3]"

"Guggenheim was always supportive of Wright, but his death in 1949, just six years after the project was begun, dealt a severe blow to the plans. It took thirteen years of patient struggle on the part of Wright to finally see his building start in construction, and even through the construction stages – from 1956 to his death in 1959, six months before the museum opened – the struggle waged on. During the sixteen years that this commission dragged on, it was to prove to be the most difficult and the most time-consuming of all Wright's work.^[4]"

"The building that stands in New York today is very different from those early studies of 1944. The general concept of the building – one continuous ramp – remains, but with the acquisition of more parcels of property on the site and with the change of the program of the museum itself, different architectural solutions were required along the way. Seven complete sets of working drawings were prepared and finally, on August 16, 1955, ground was broken and construction began.^[6]"

"When the corner at 88th Street was acquired in 1951, the spiral ramp was shifted back to the south. After this last shift was made, Wright, in response to the changing administrative requirements of the museum, suggested the construction of a tall building behind the museum for a historical gallery, staff offices, workrooms, and storage. Rising behind the museum would be an eleven-story structure. It was this 1951 design by Wright that served as precedent for the 1992 addition of a "backdrop" building behind the museum.^[6]"

Facts from the Project

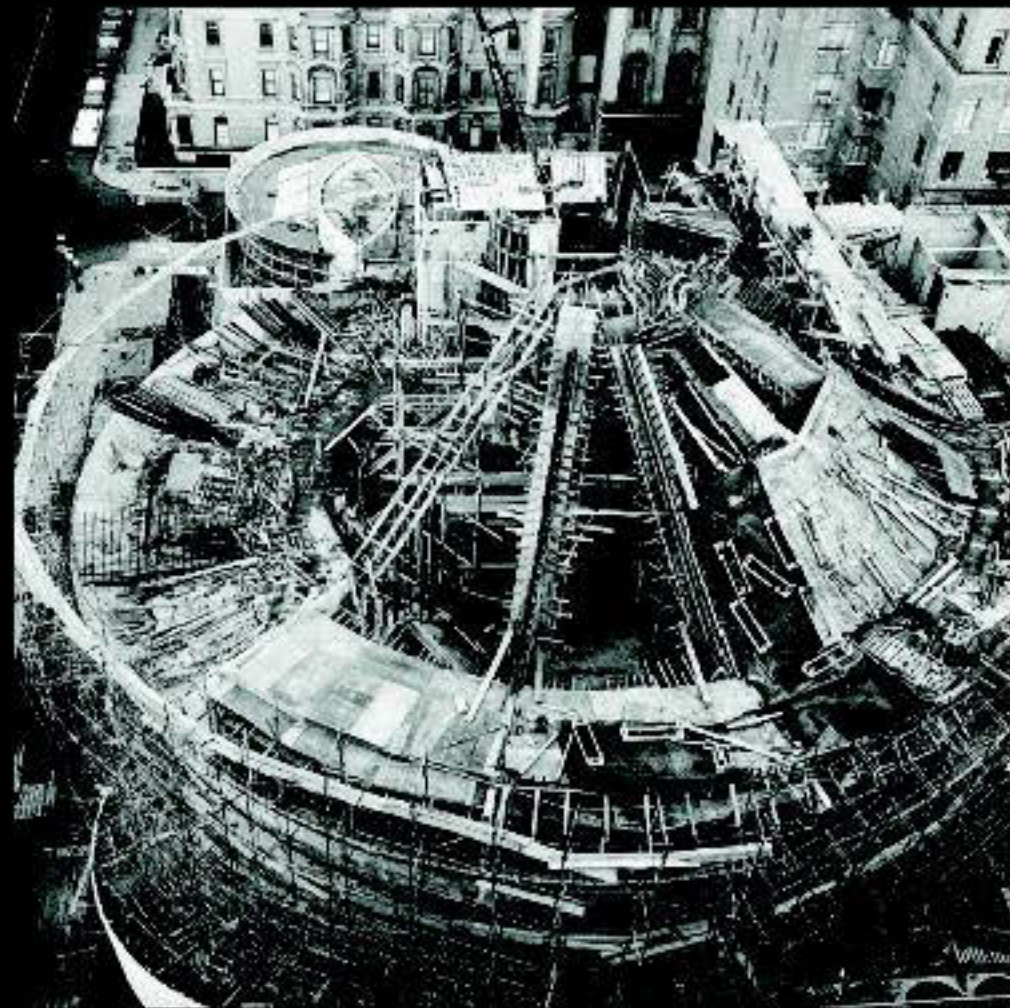

Construction of the main rotunda, ca. 1958. Photograph by William H. Short
© The Solomon R. Guggenheim Foundation, New York.

“The whole building, cast in concrete, is more like an egg shell – in form a great simplicity rather than like a crisscross structure. The light concrete flesh is rendered strong enough everywhere to do its work by embedded filaments of steel – either separate or in mesh. The structural calculations are thus those of the cantilever and continuity, rather than the post and beam. The net result of such construction is a greater repose, the atmosphere of the quiet unbroken wave: no meeting of the eye with abrupt changes of form.^[2]”

Architect:.....Frank Lloyd Wright
Classification:Art Museum
Year:1943-1959
Construction Type:Reinforced Poured Concrete
Height:92 feet
Square Feet:51,000 square feet of gallery space

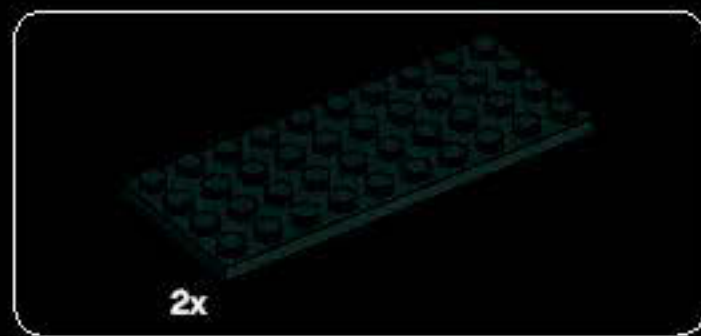

1

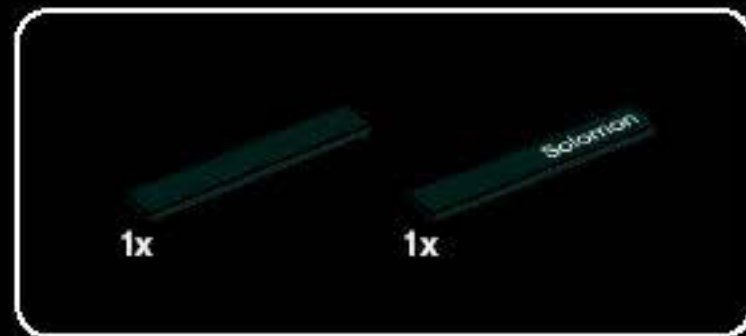

2



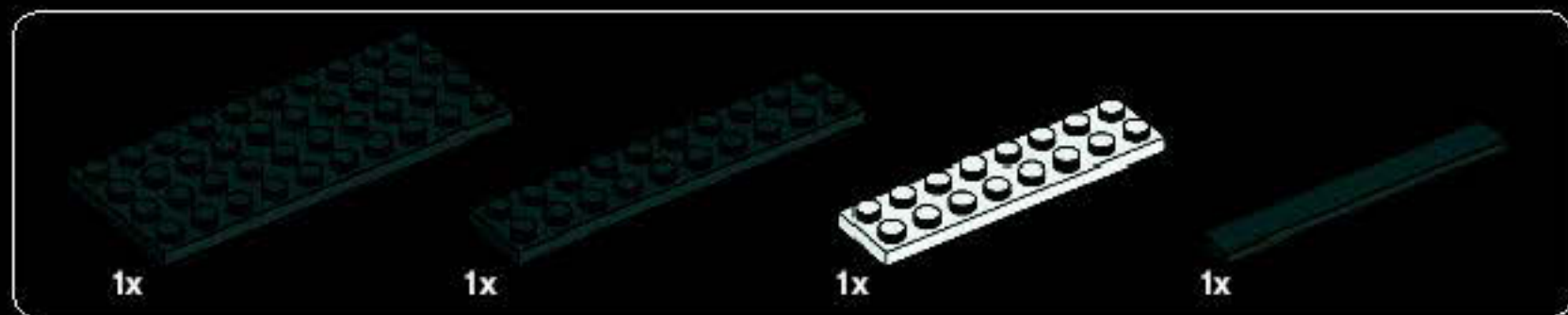

3



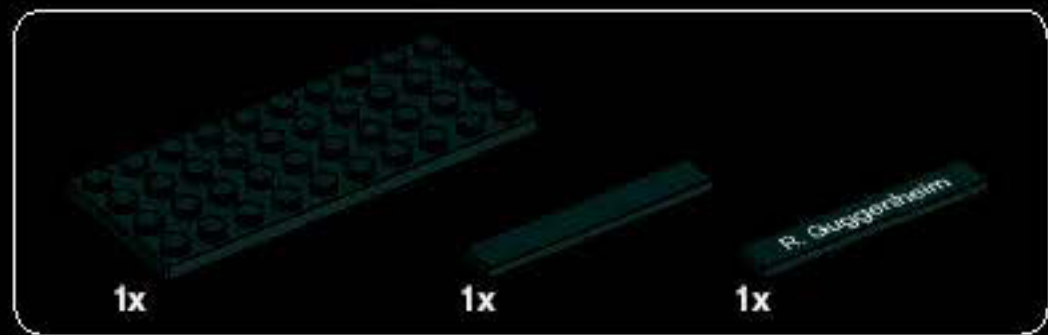

4

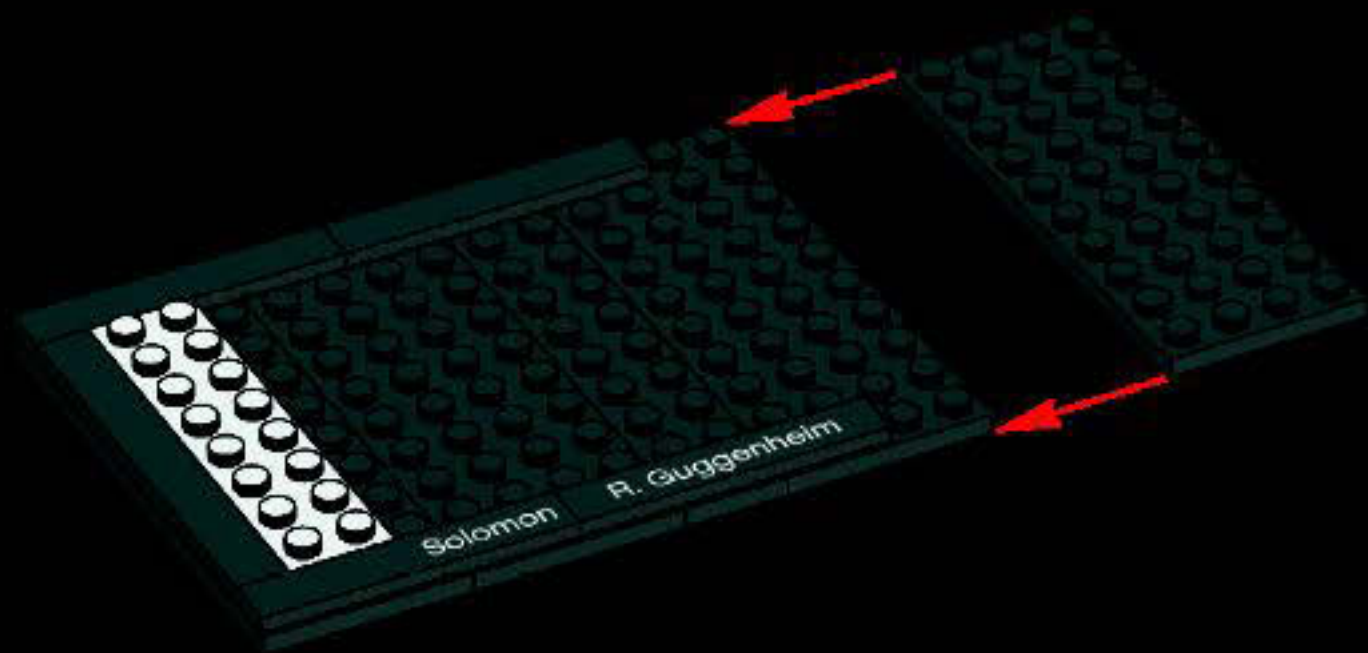

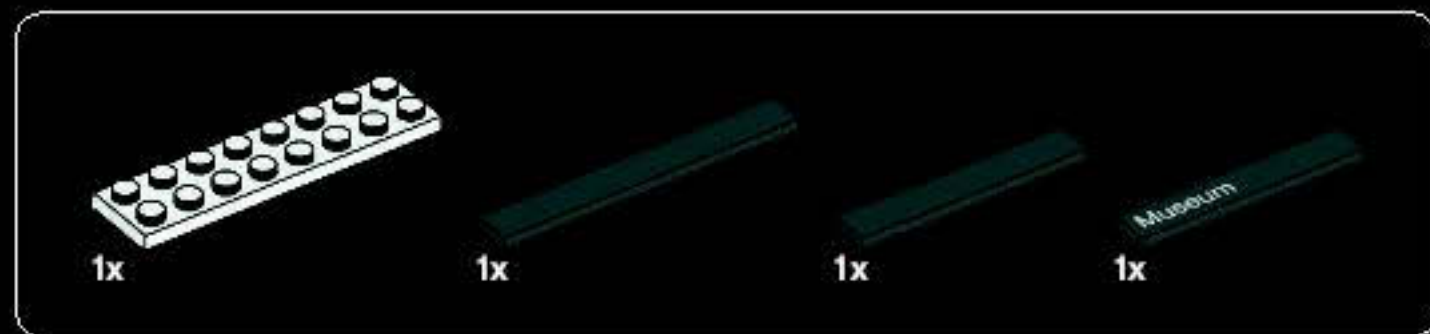

5

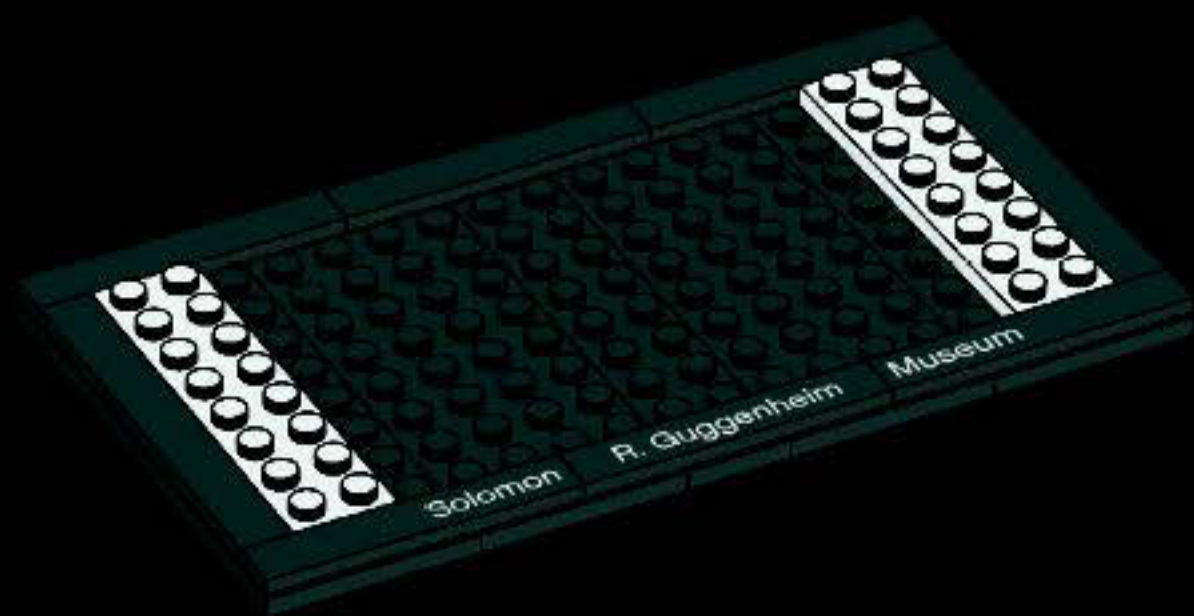

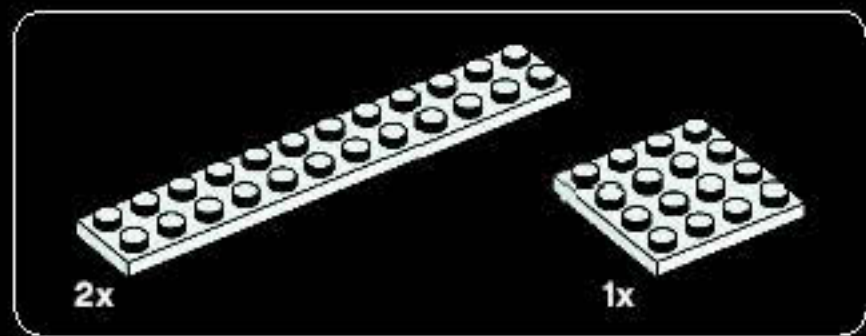

6

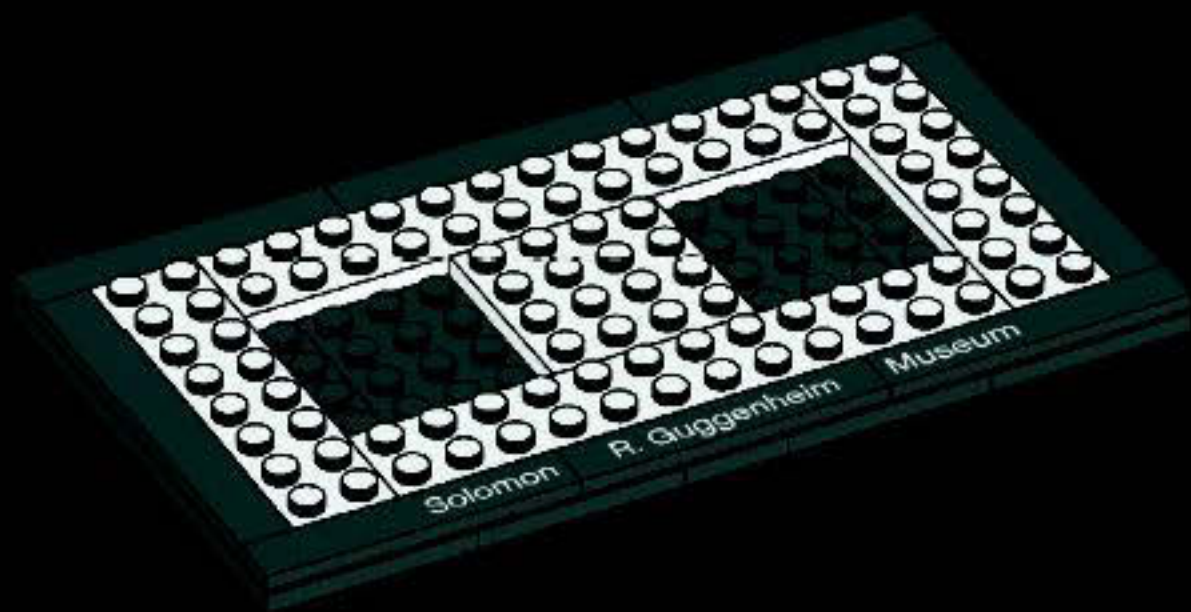

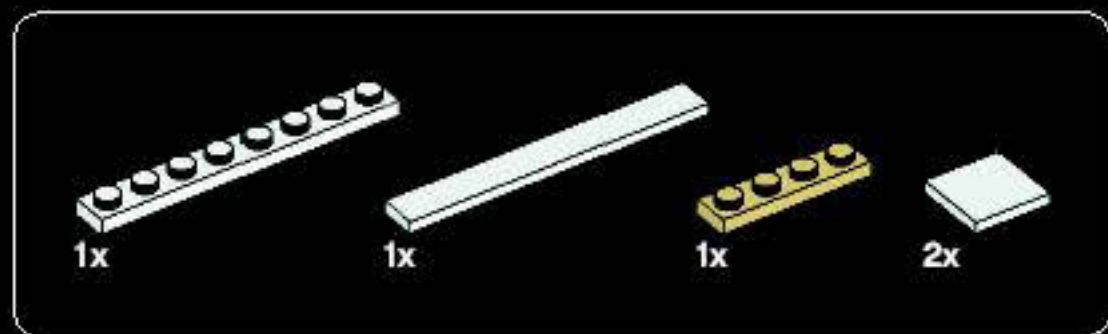

7

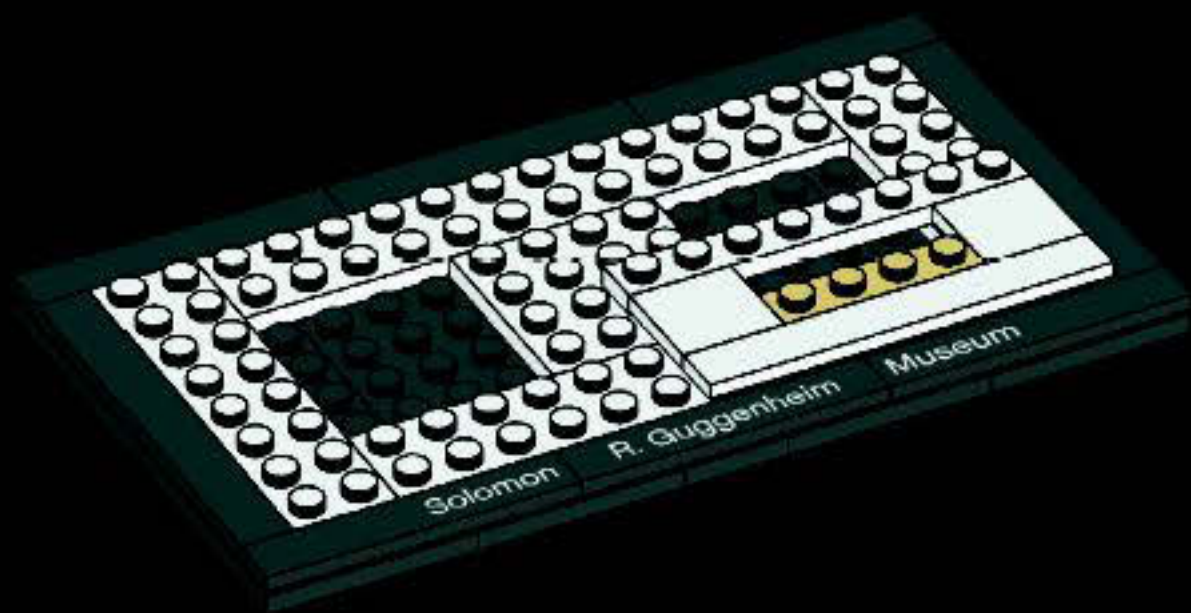

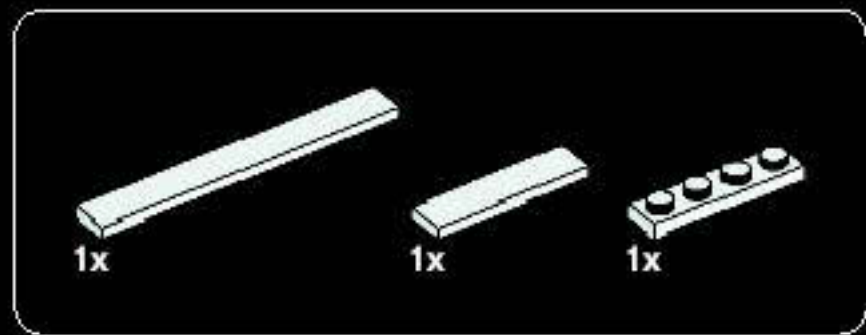

8

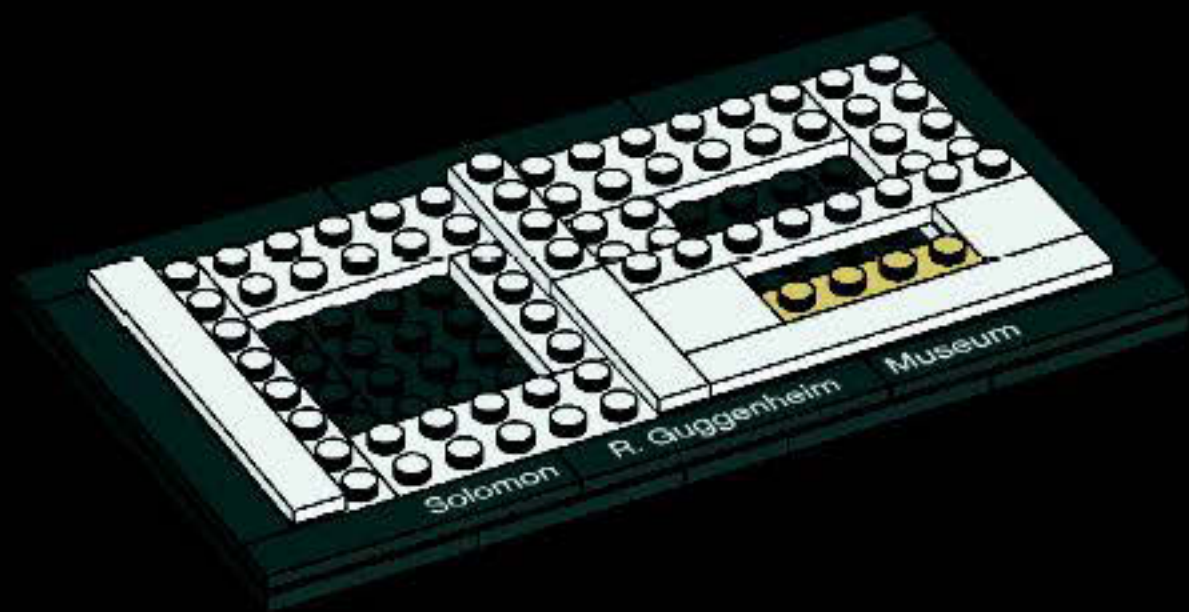

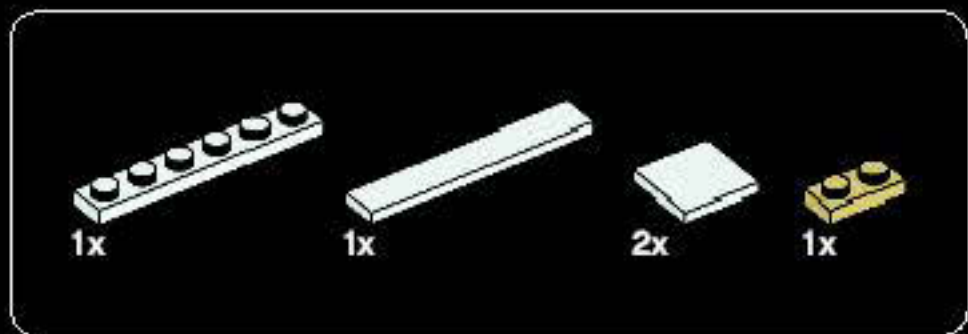

9

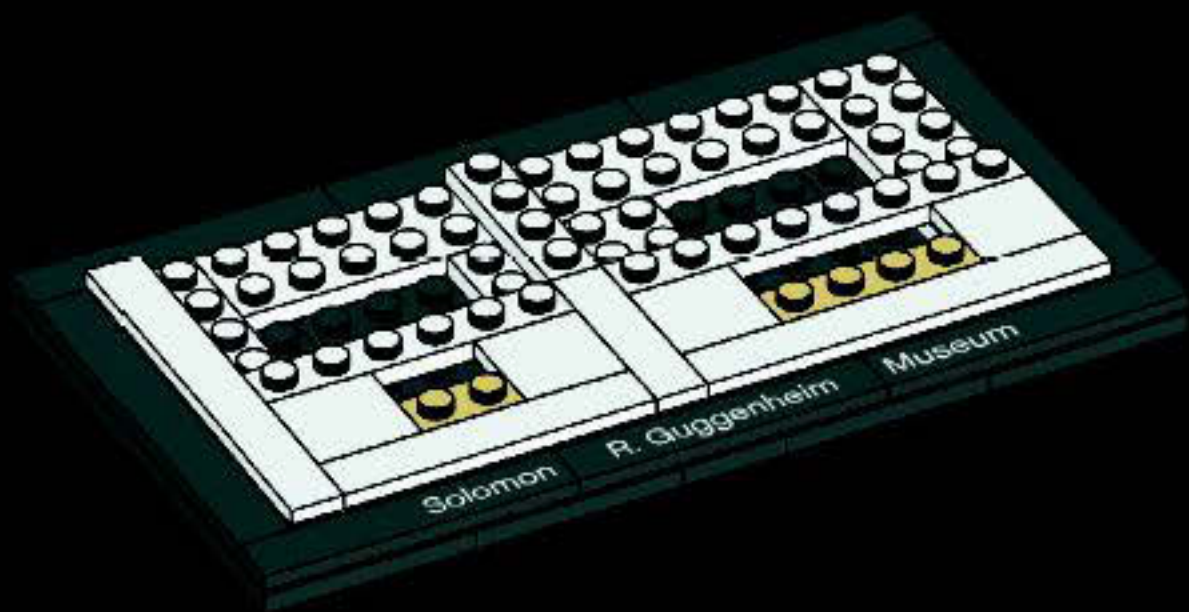

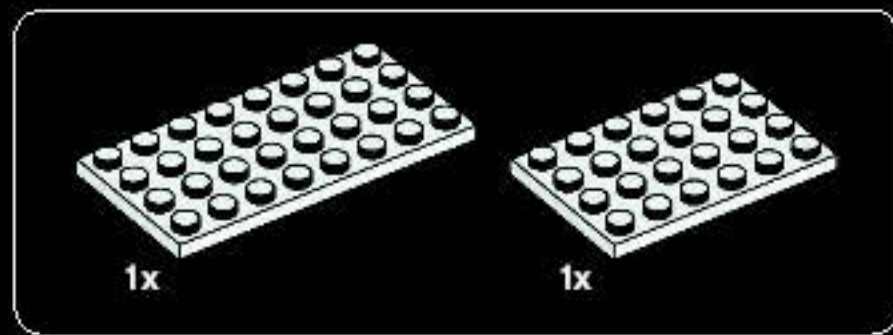

10

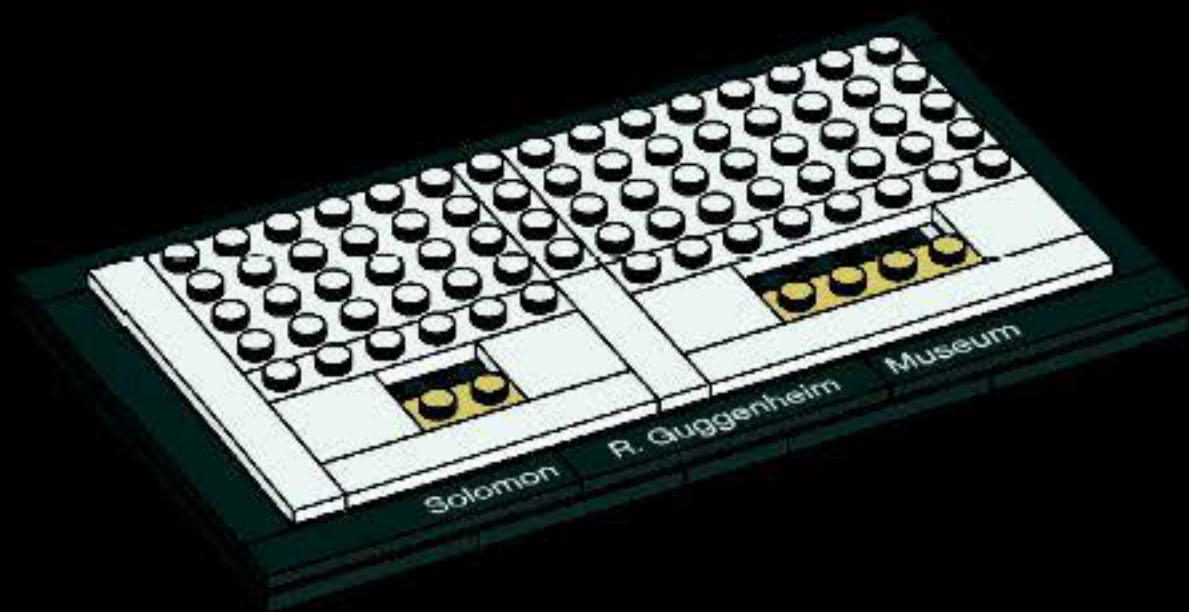

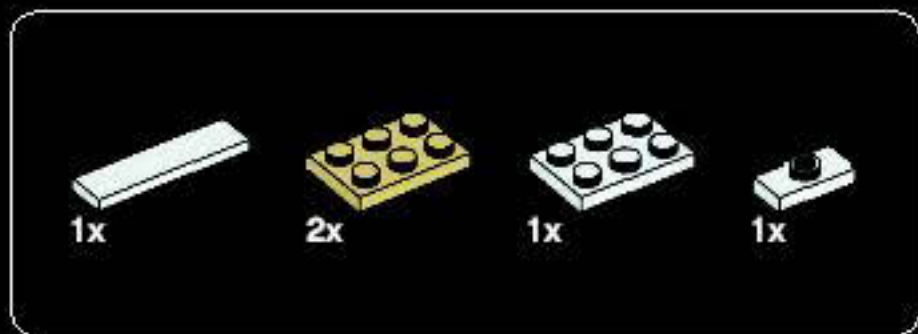

11

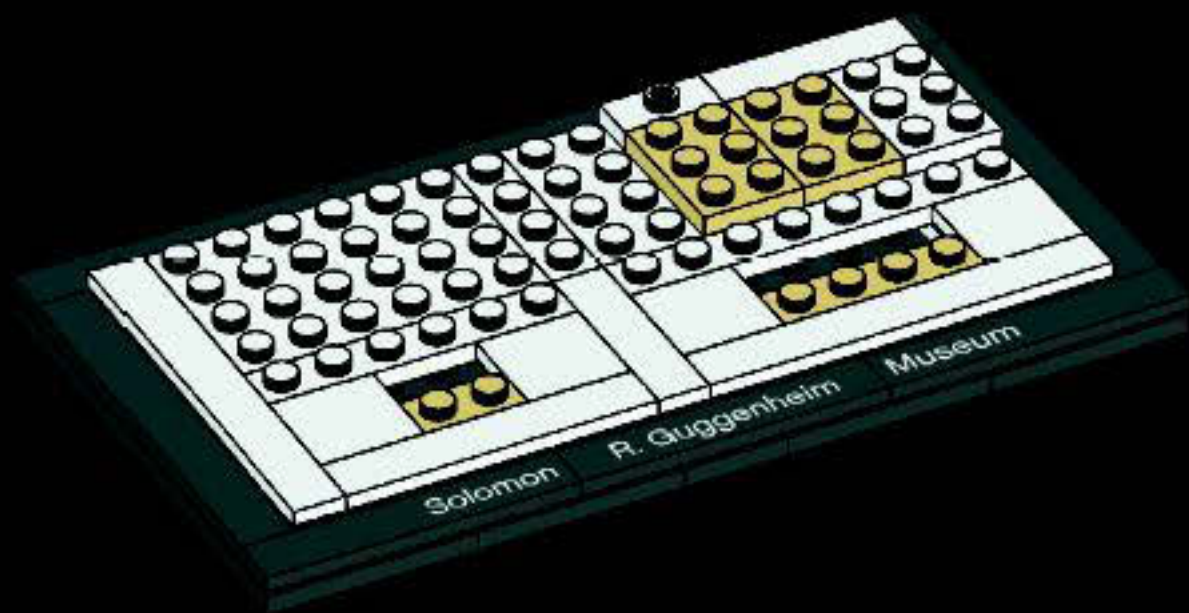

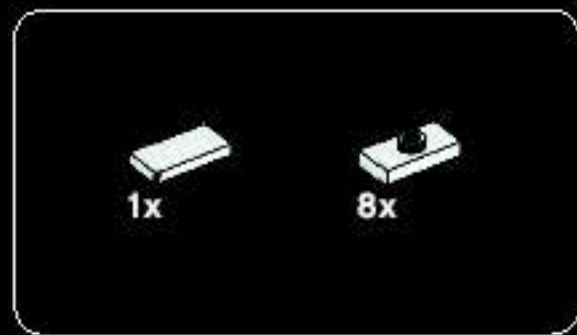

12

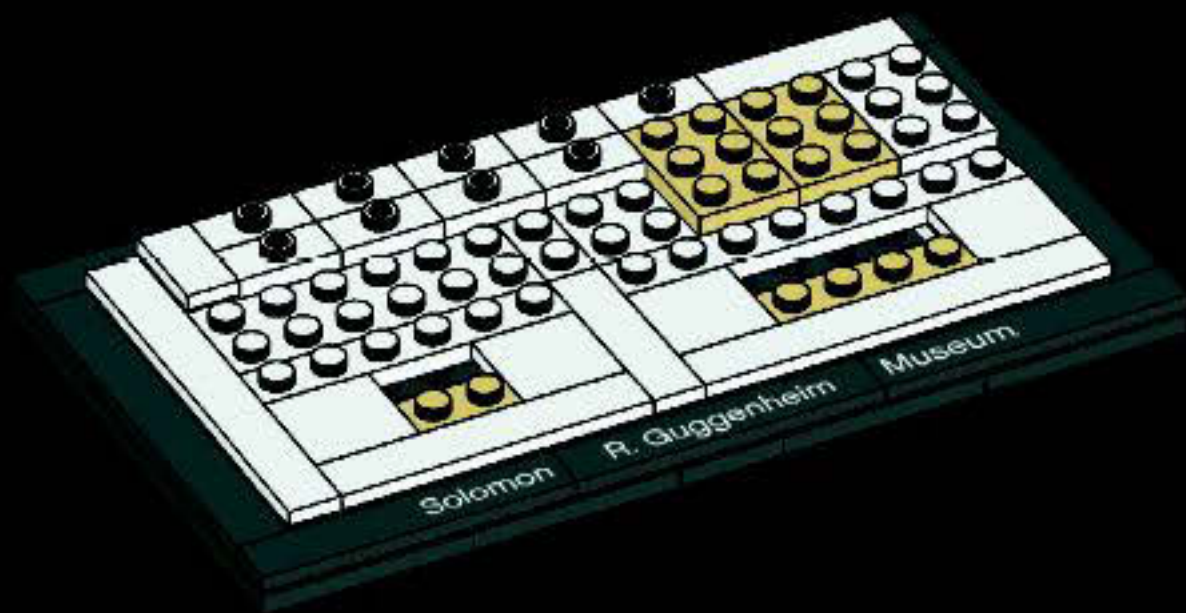

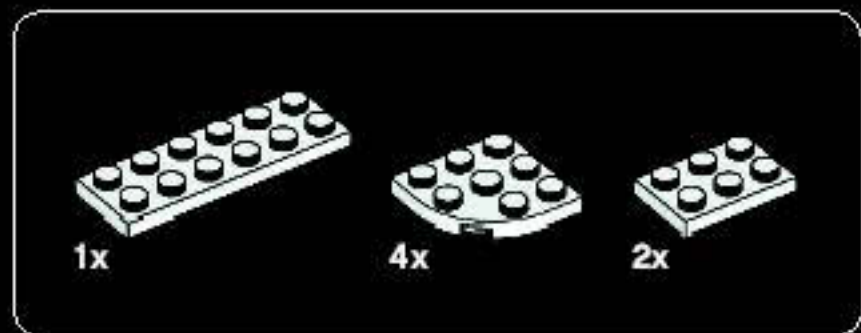

13

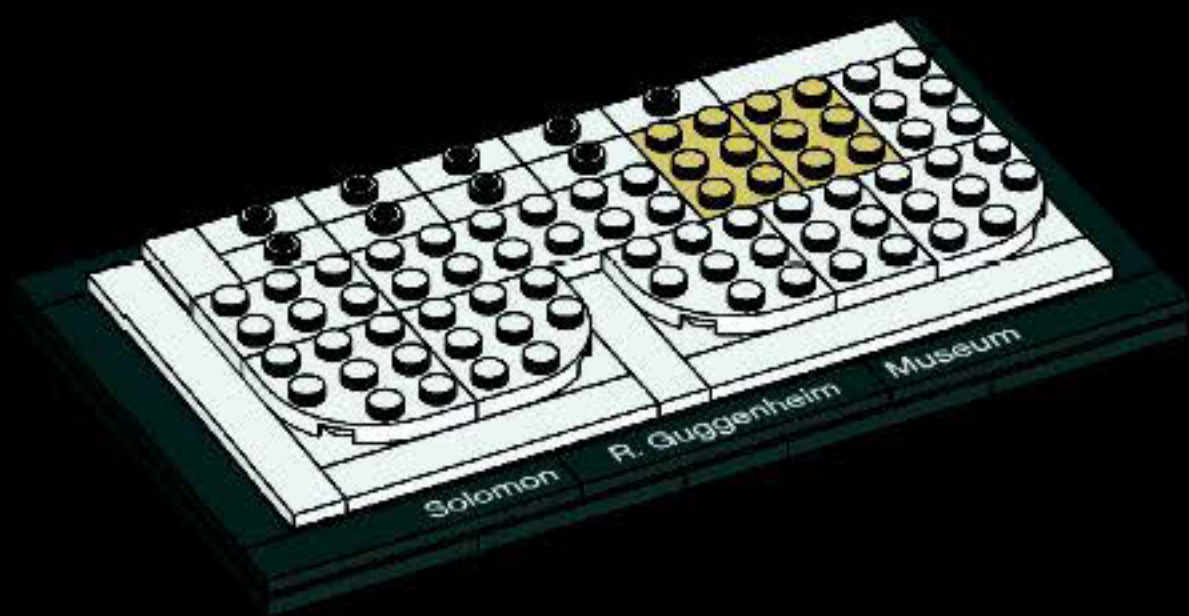

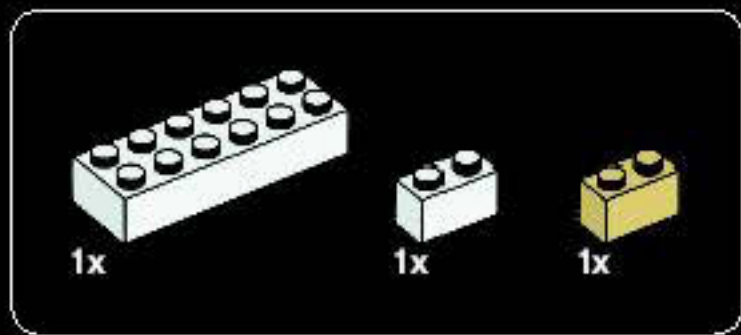

14

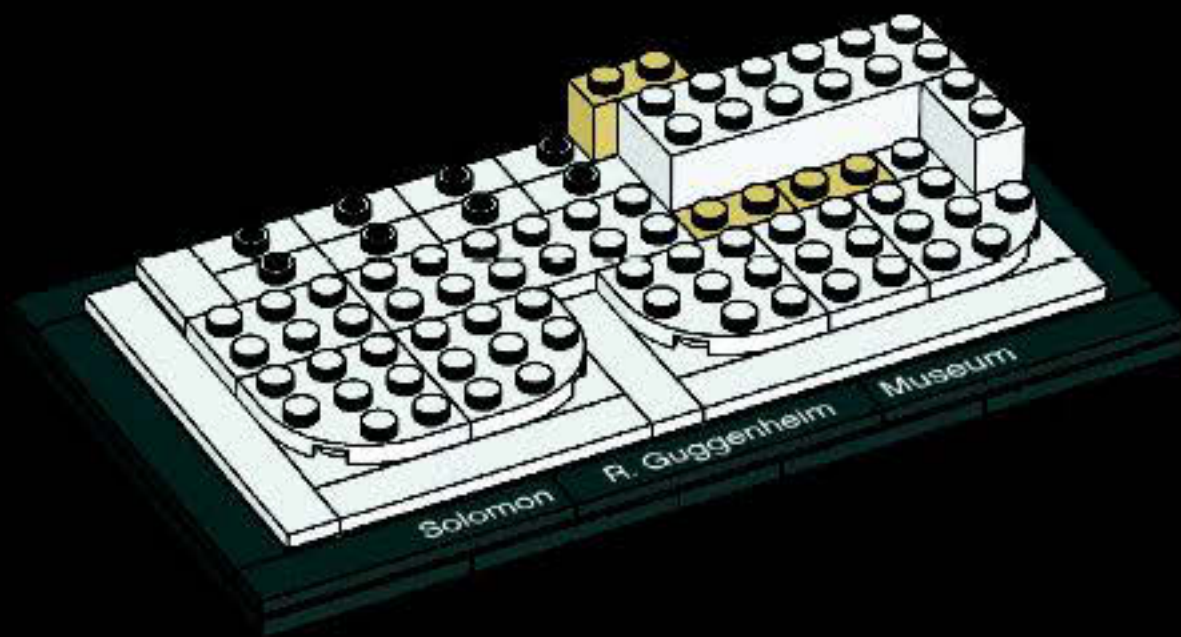

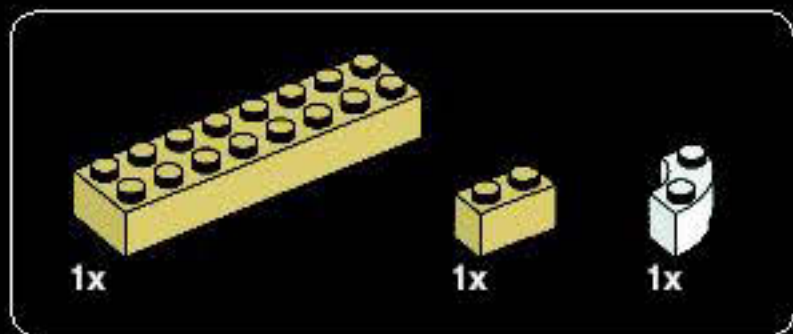

15

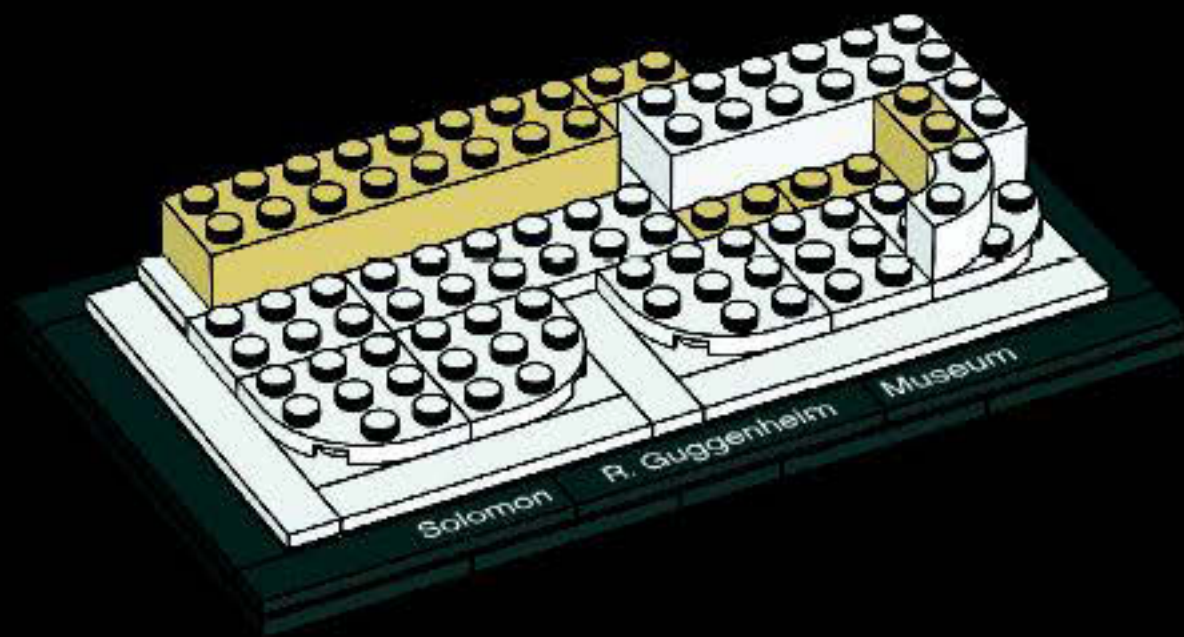

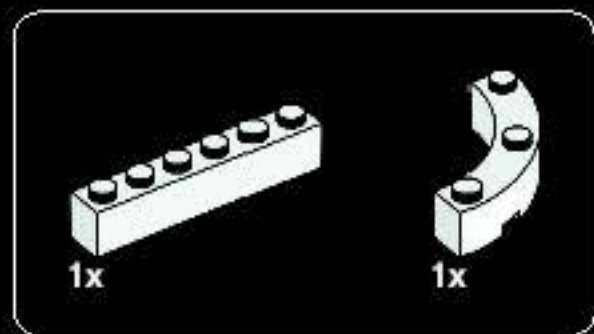

16

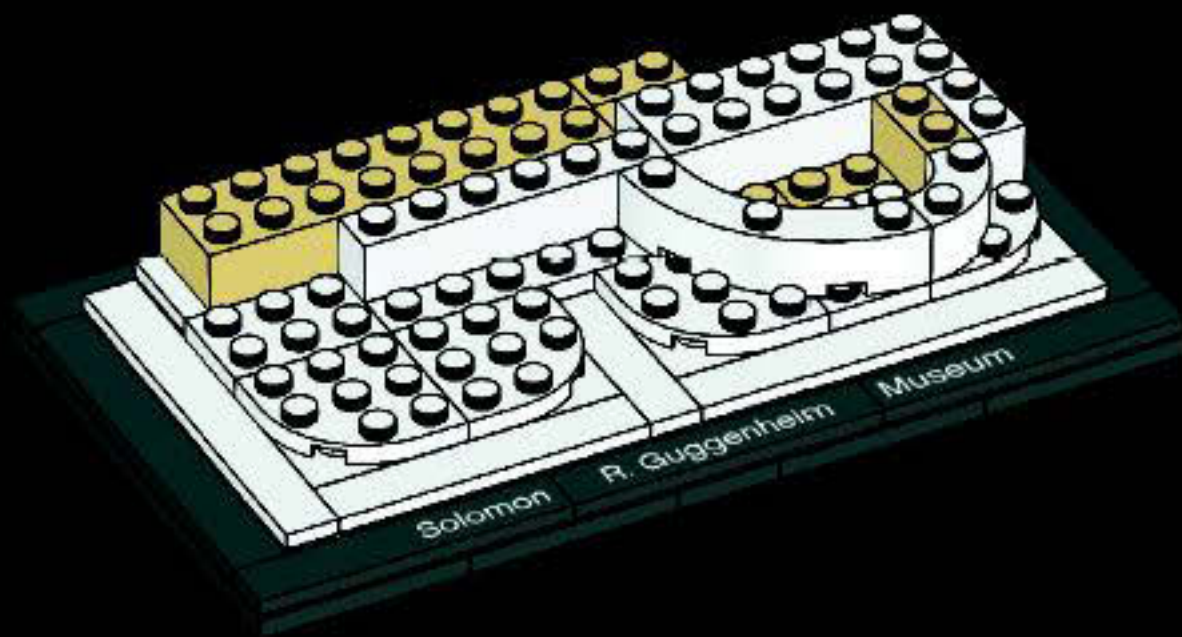

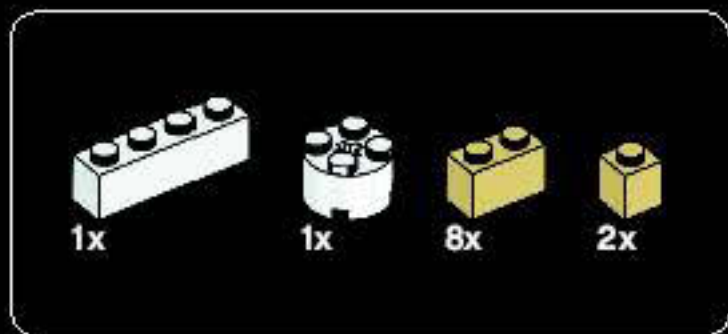

17

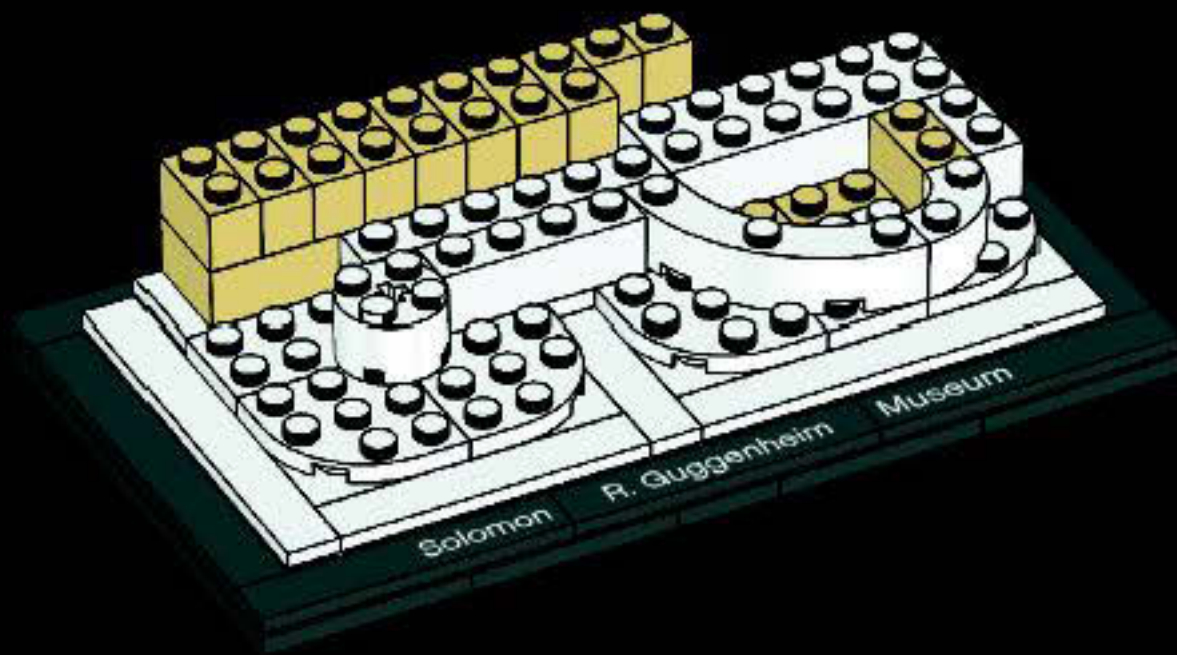

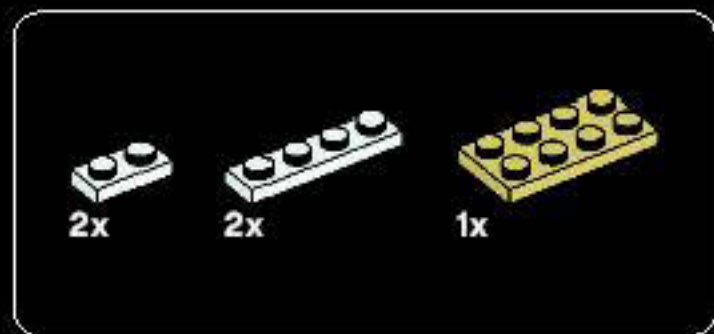

18

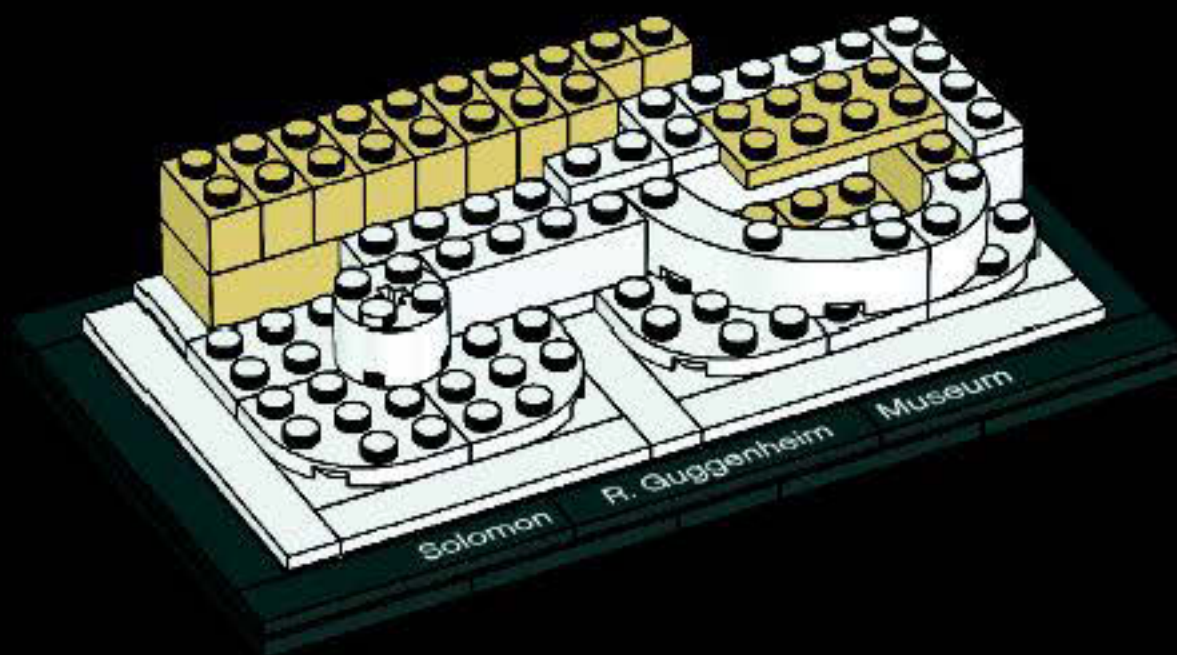

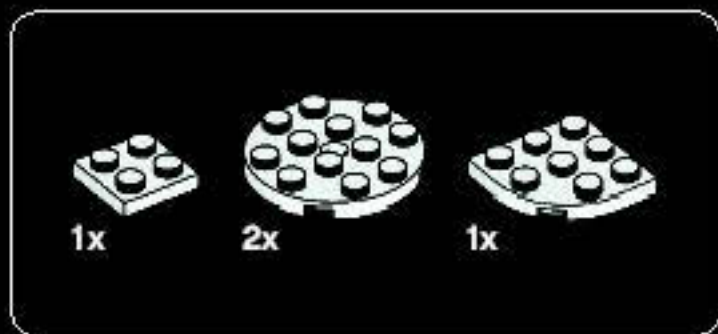

19

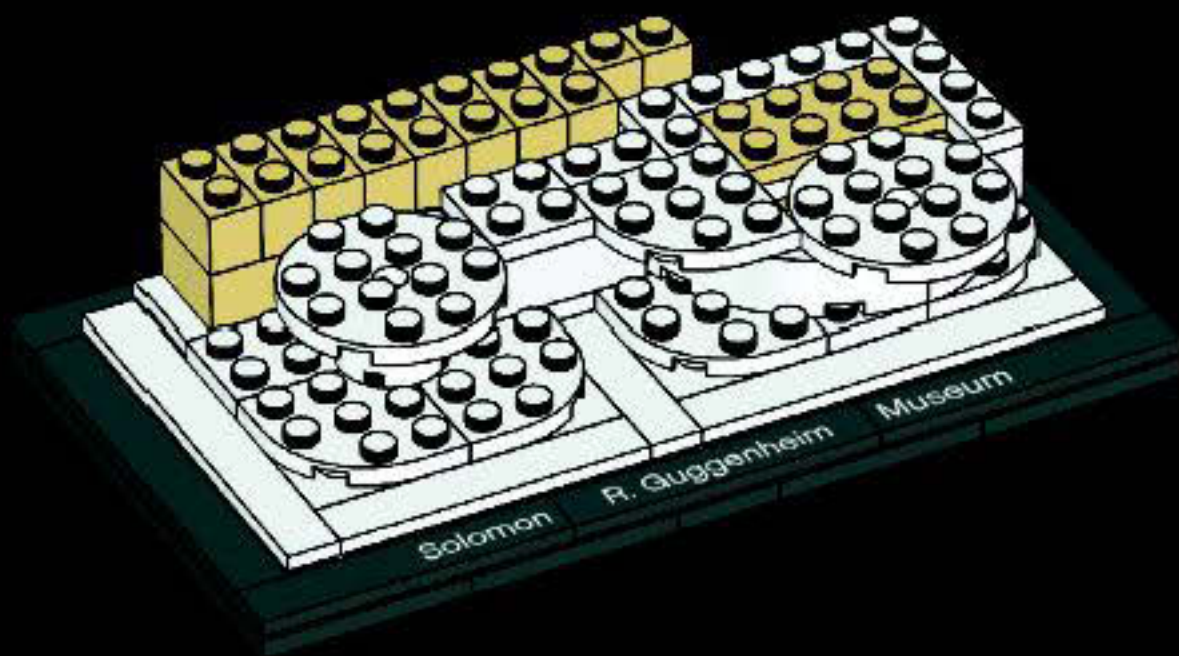

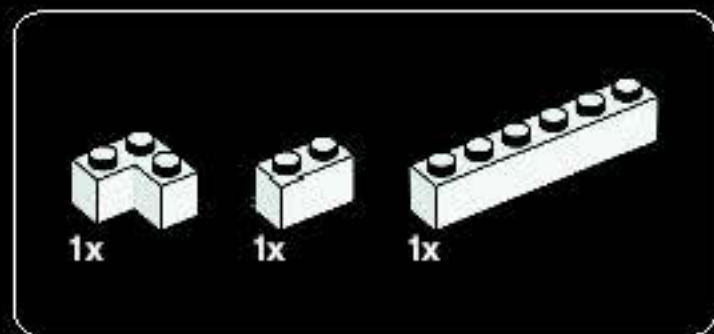

20

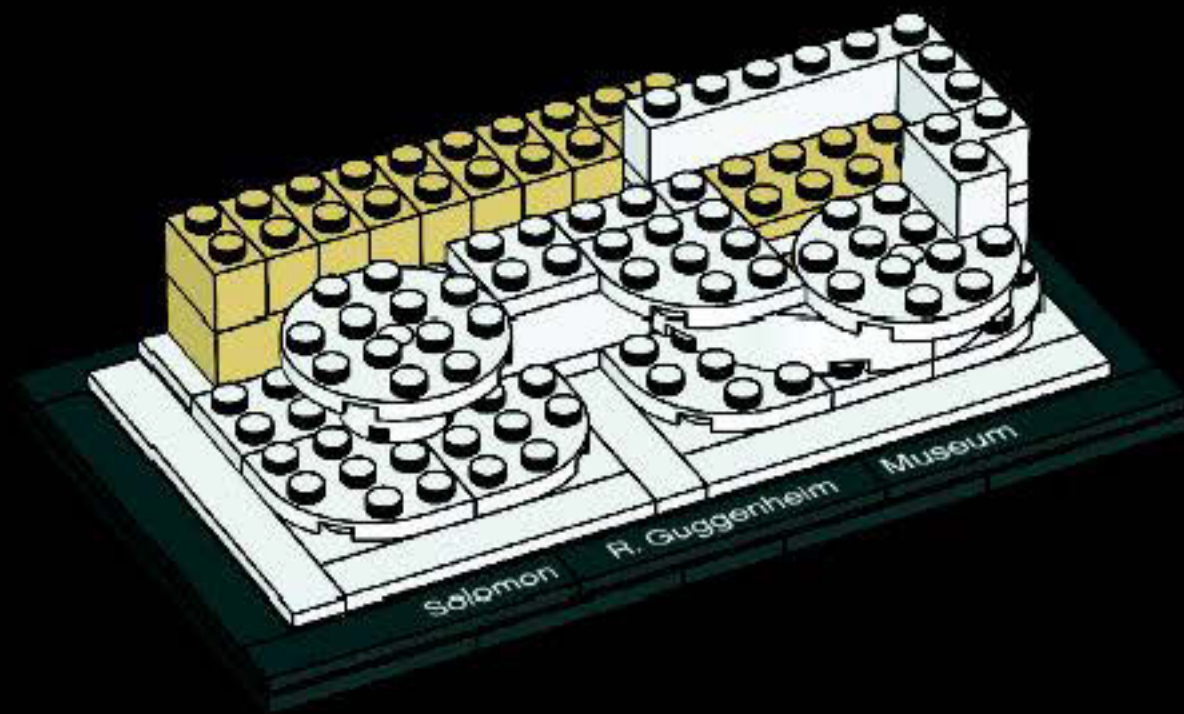

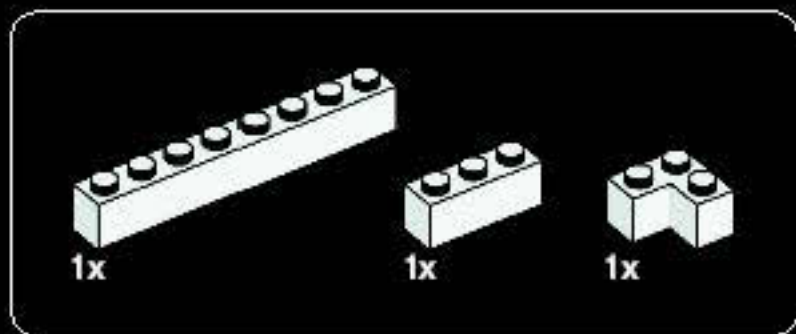

21

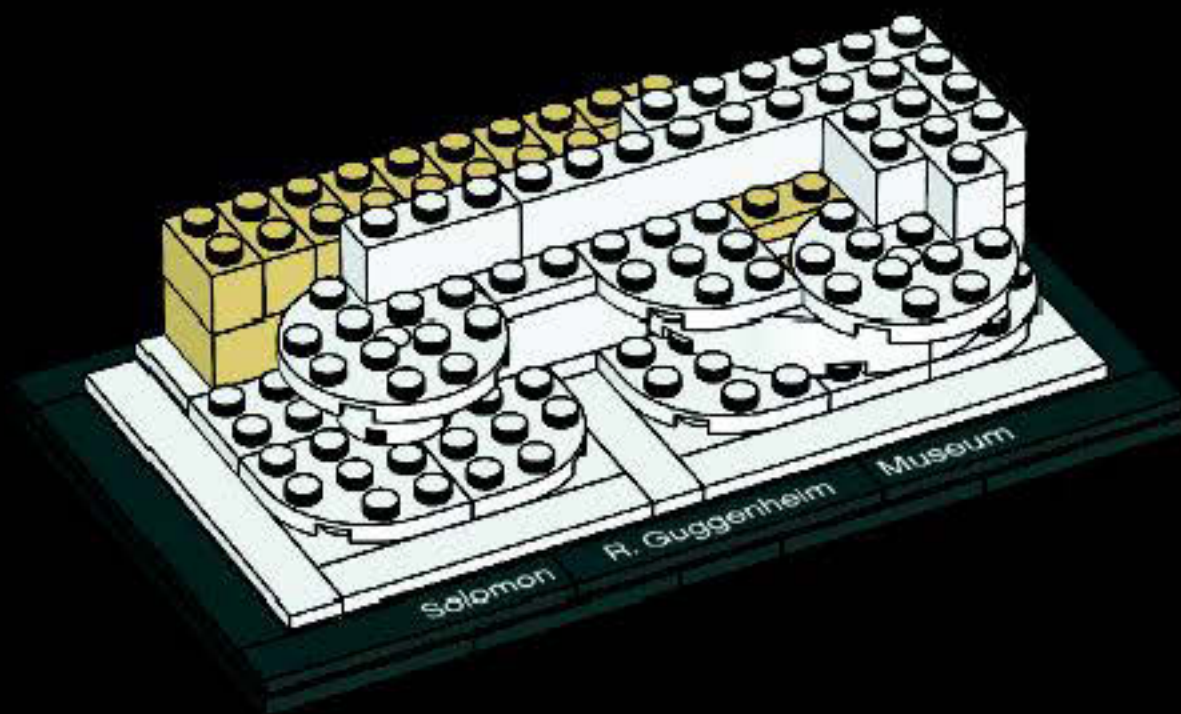

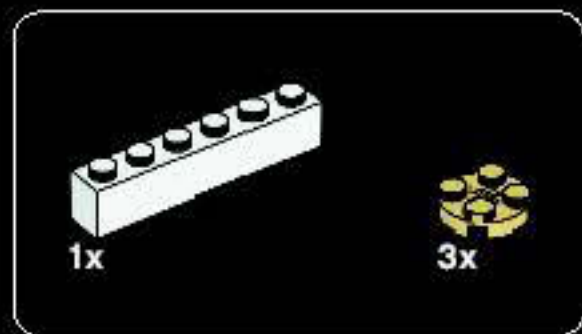

22

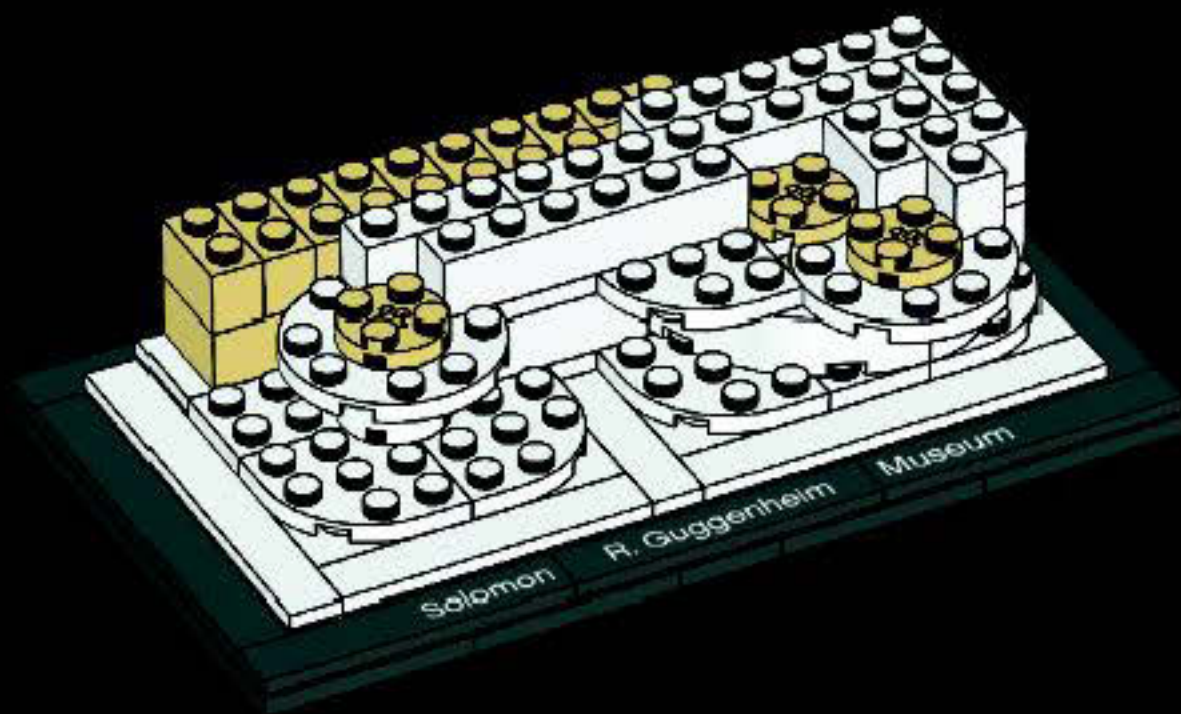

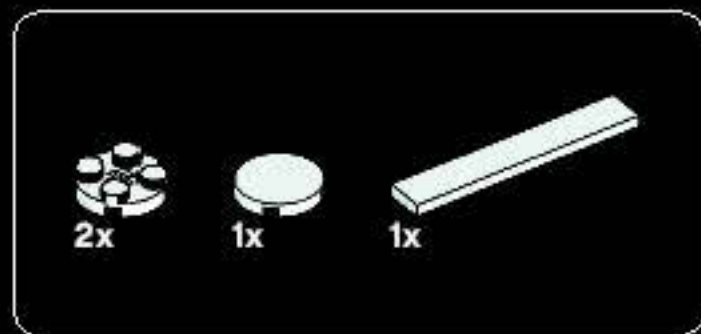

23

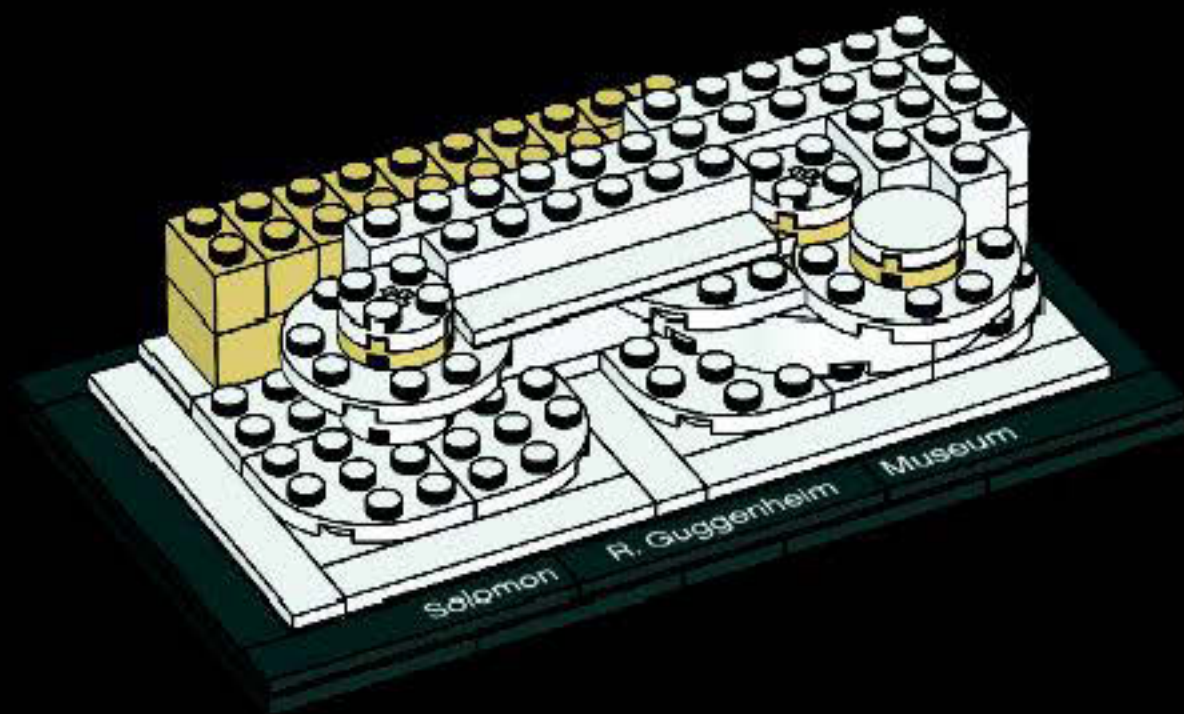

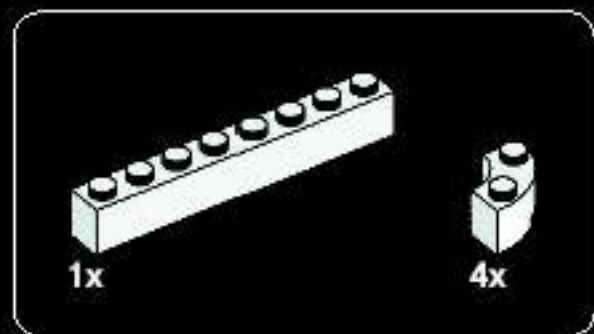

24

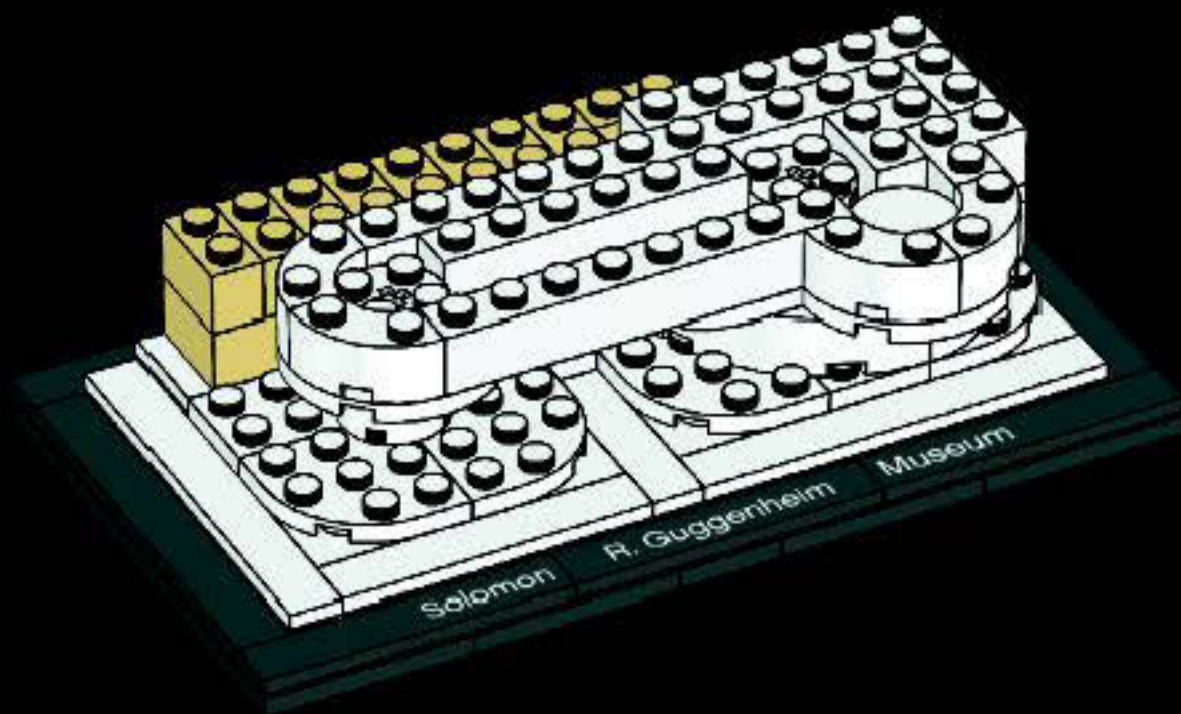

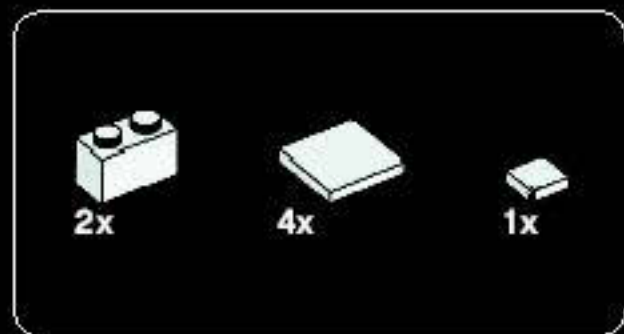

25

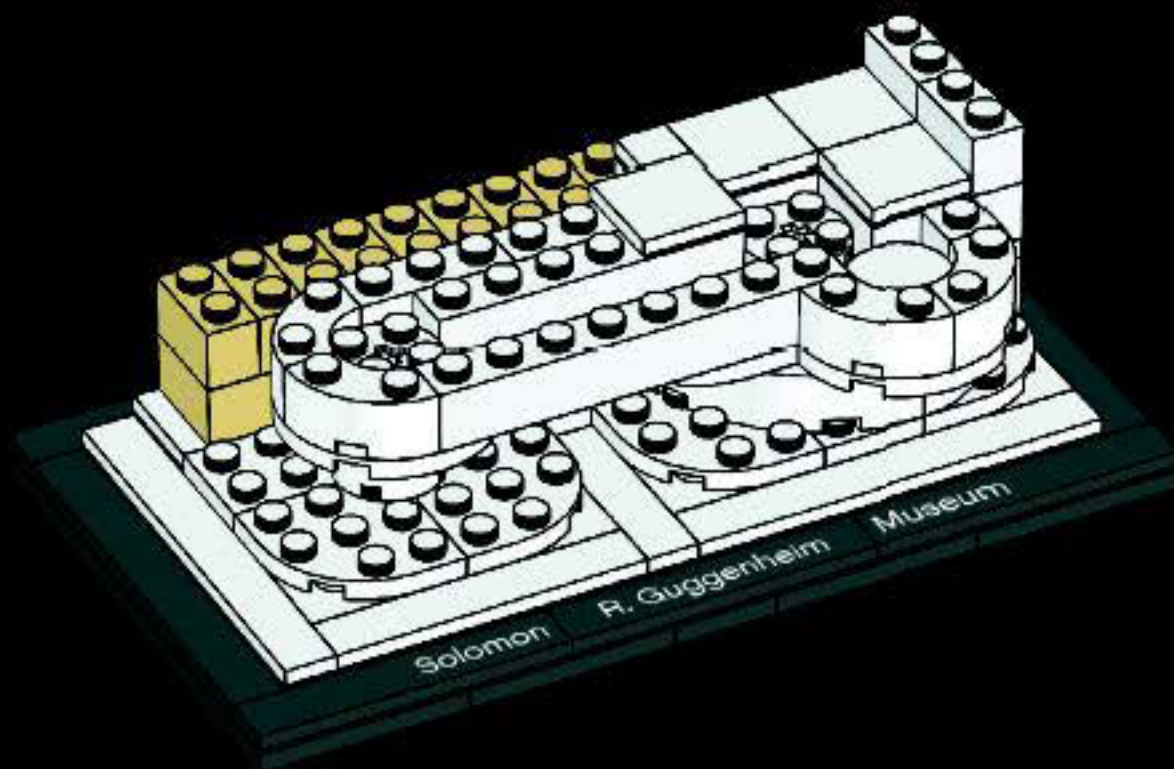

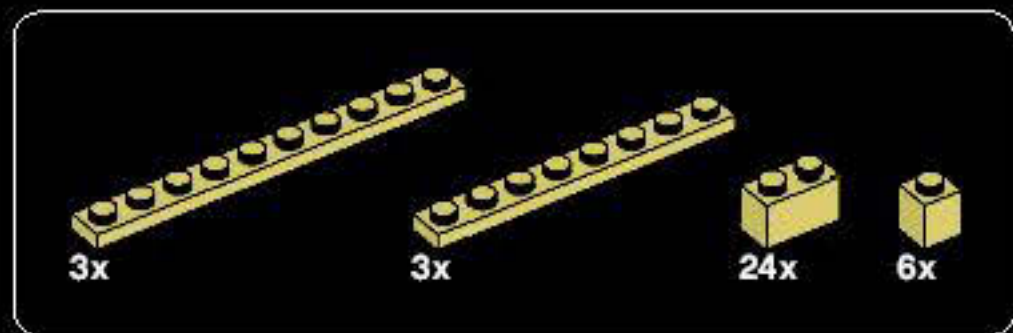

26

1



2

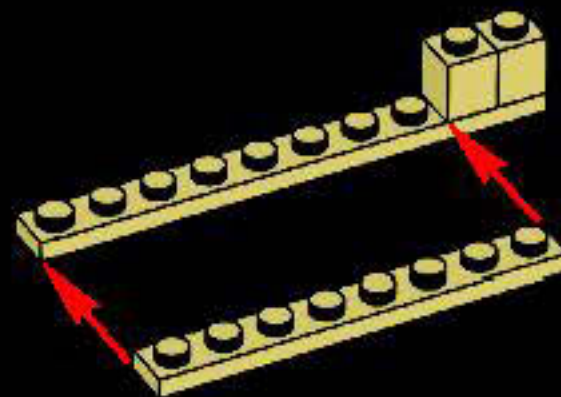

3

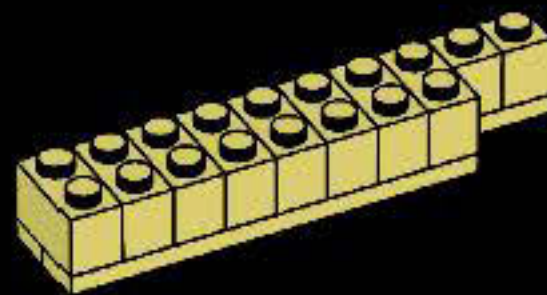

3x

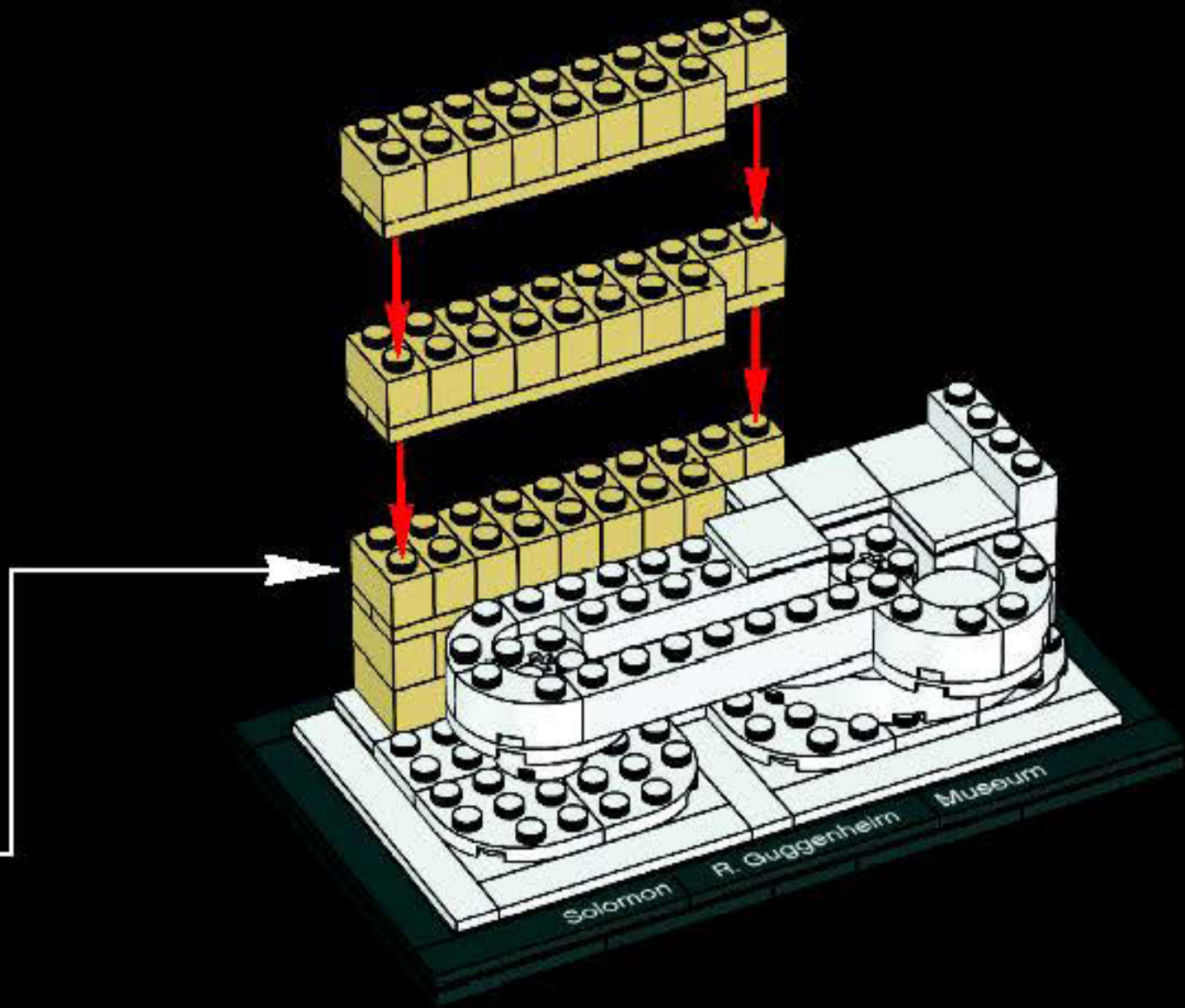

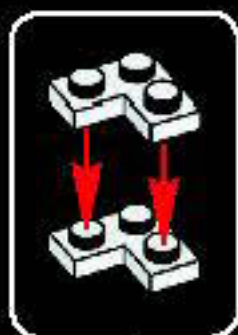
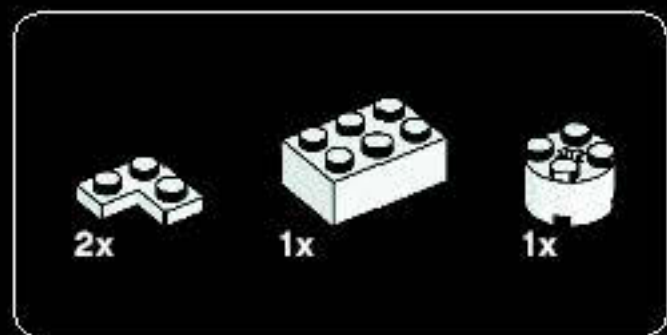

27

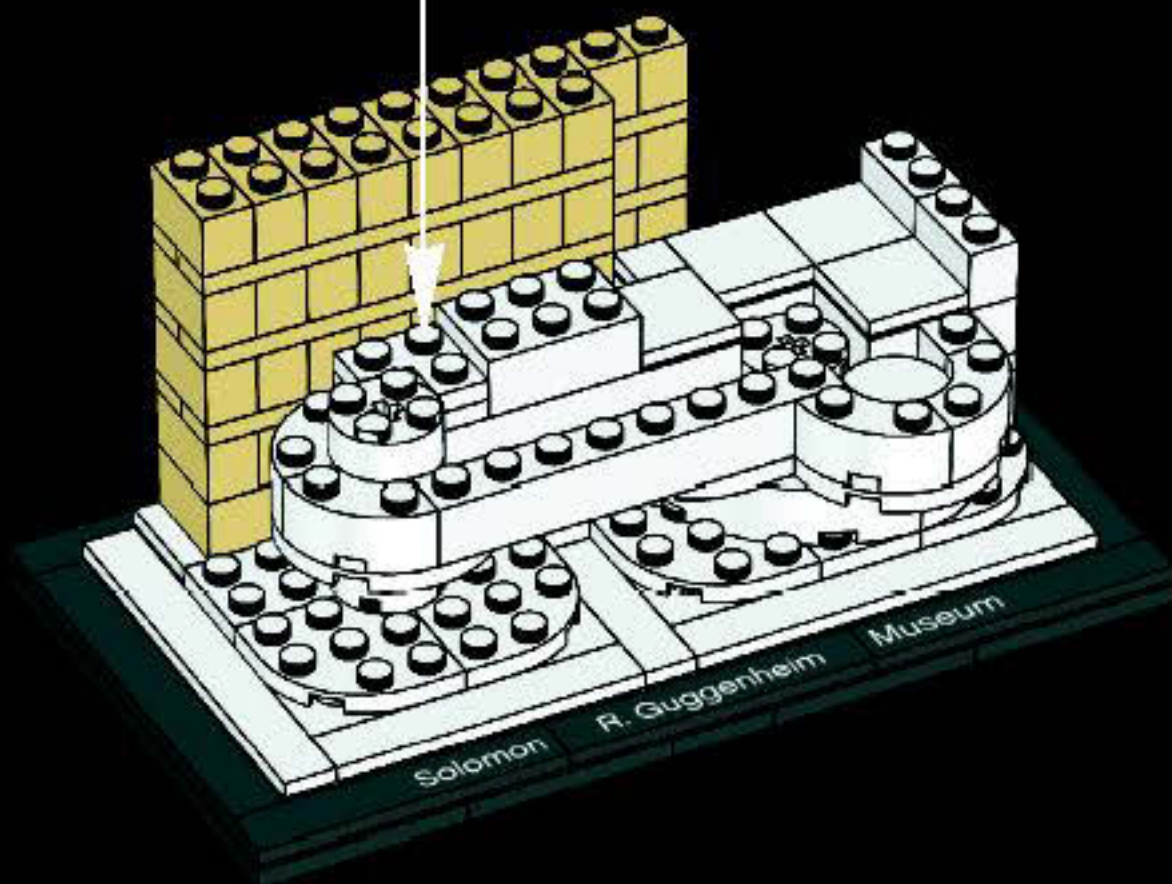

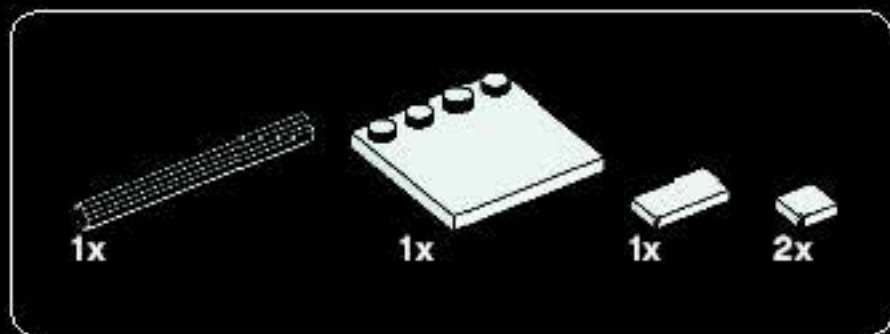

28

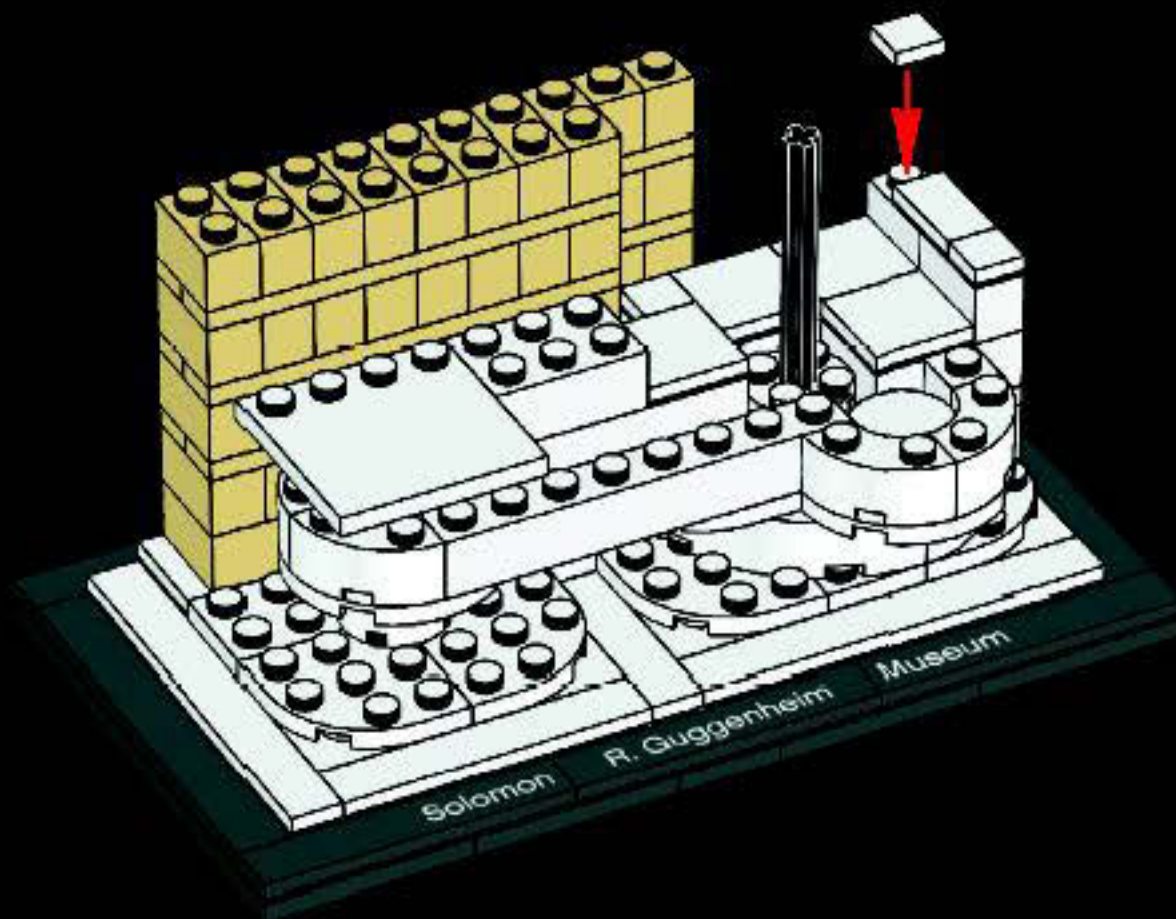

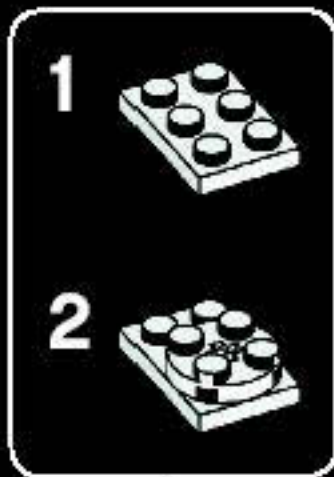
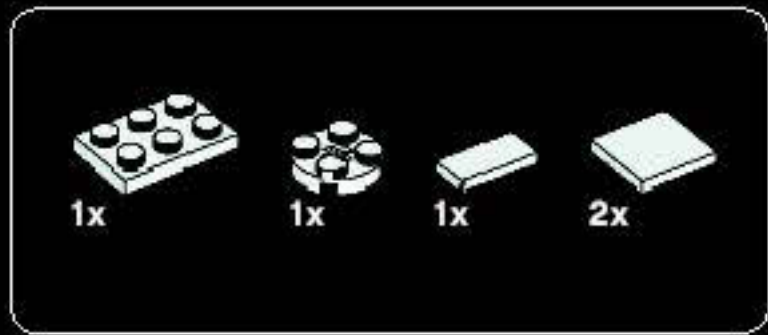

29

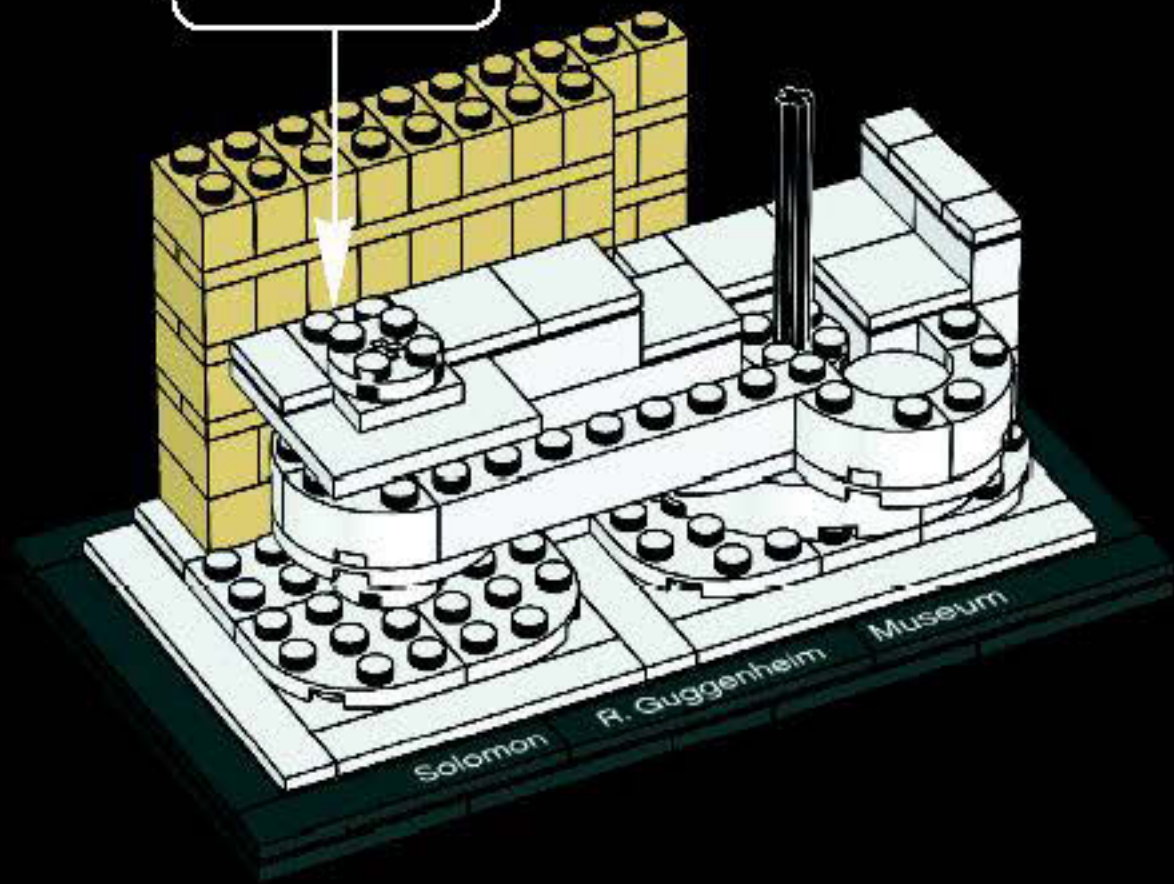

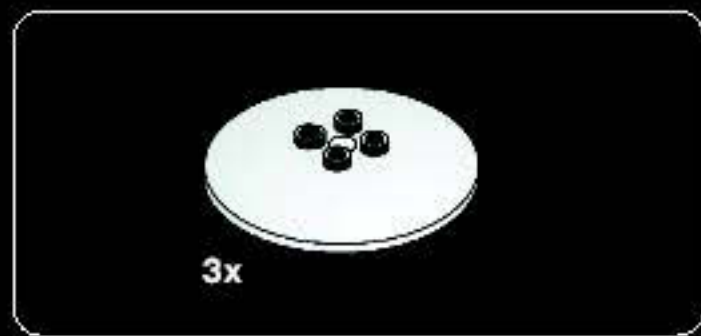

1

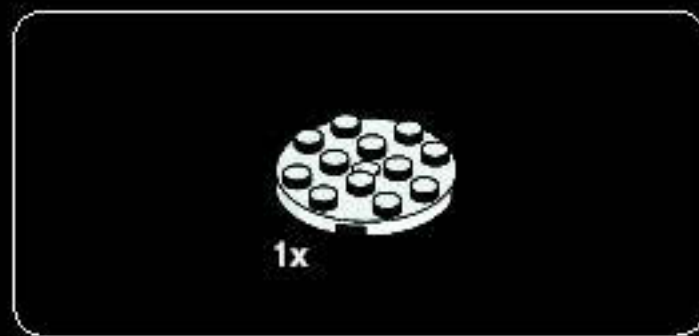

2



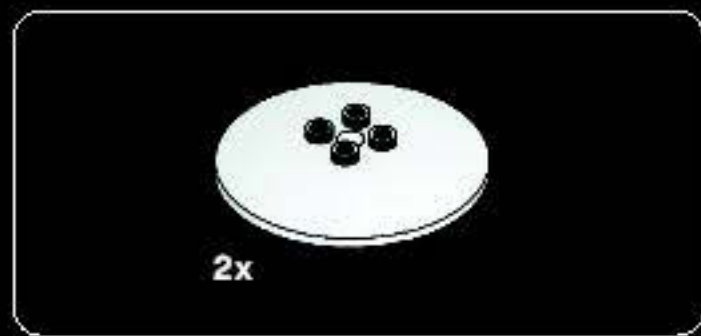

3

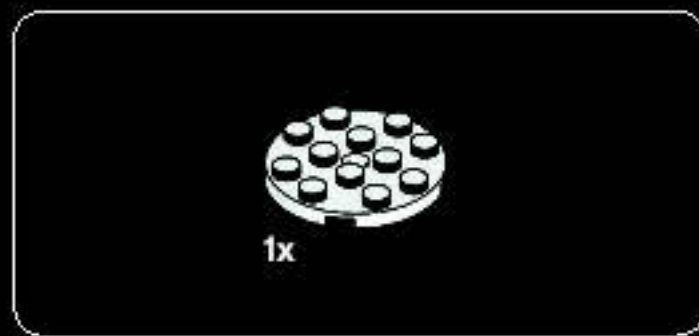
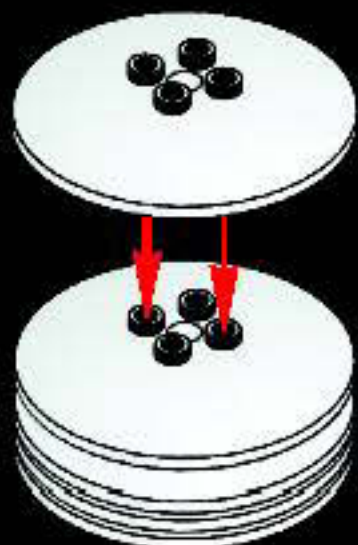

4

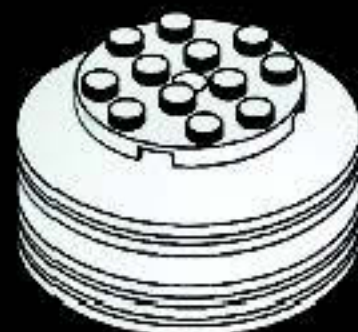

30

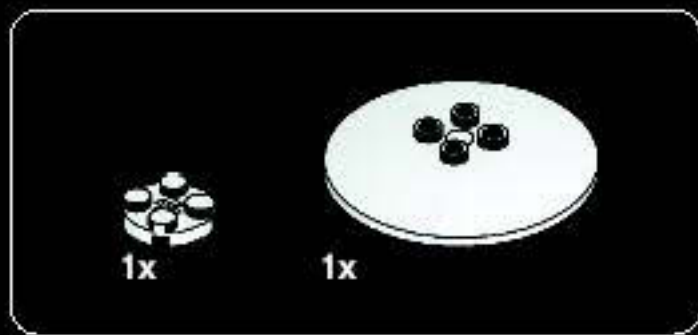

5

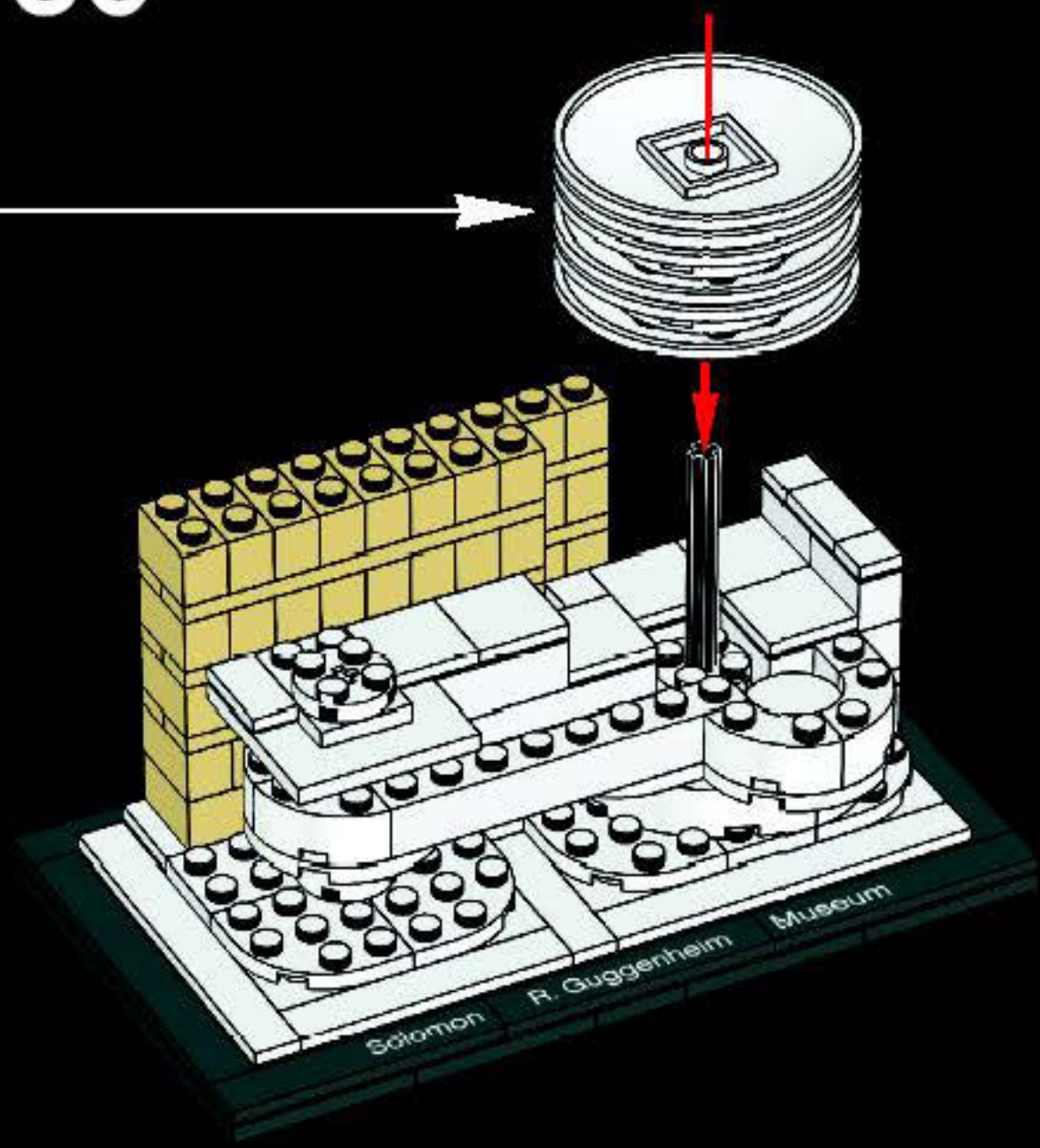

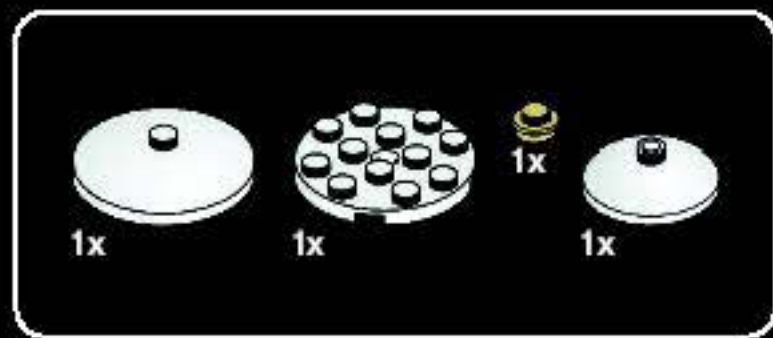

31

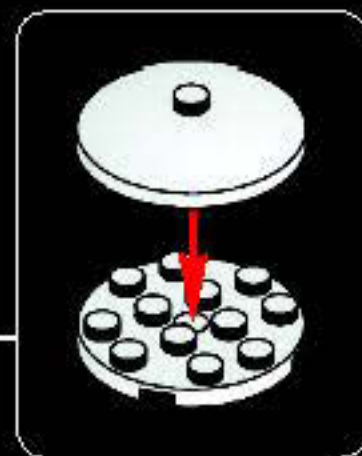
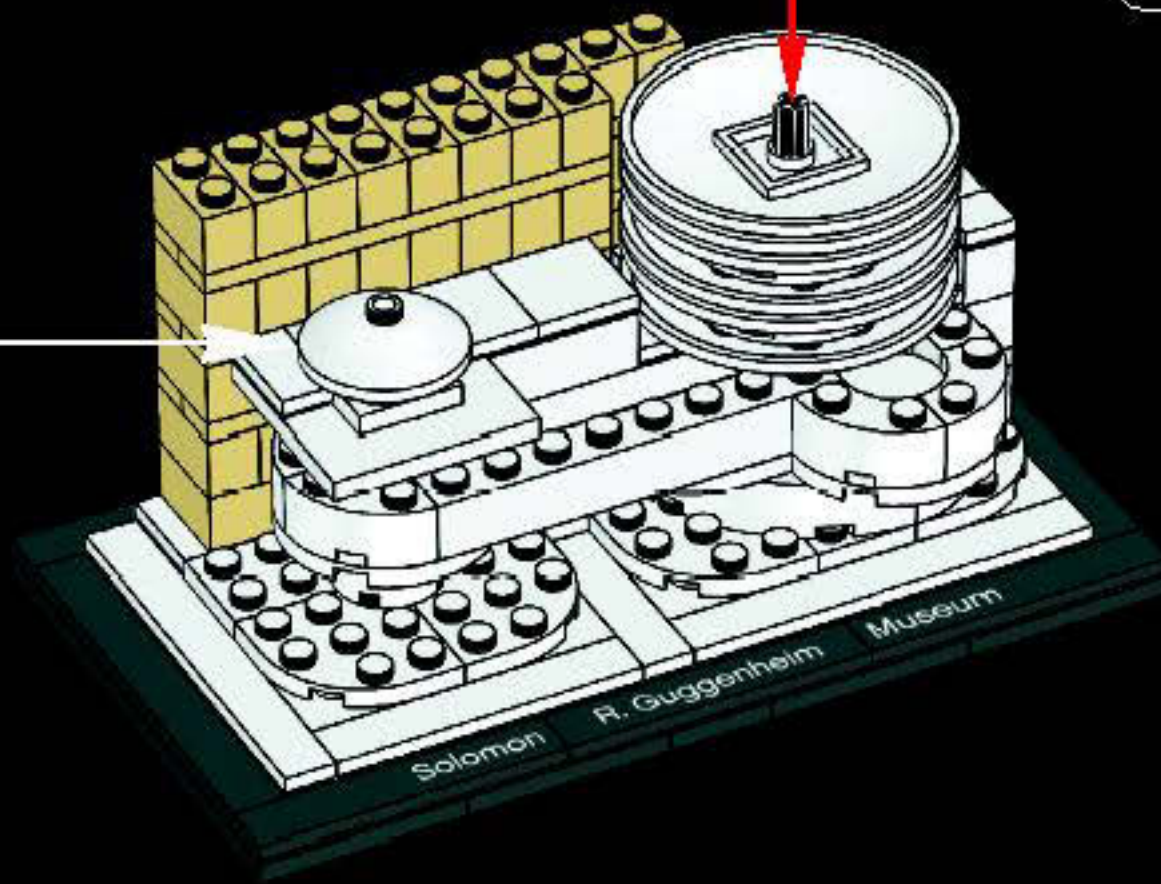

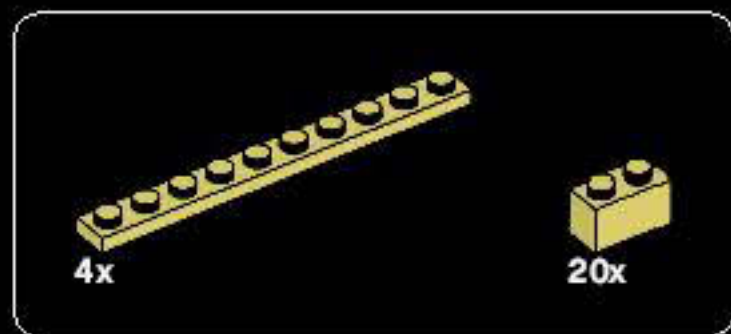

32

1

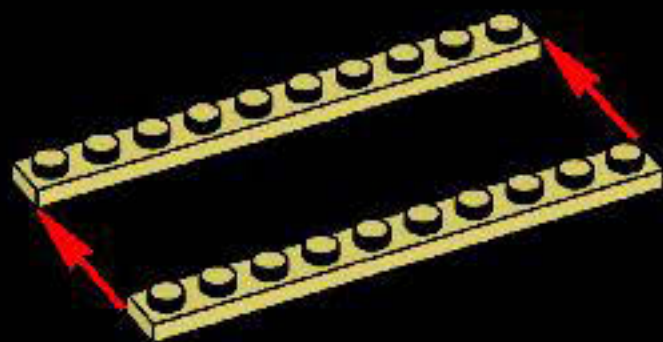

2

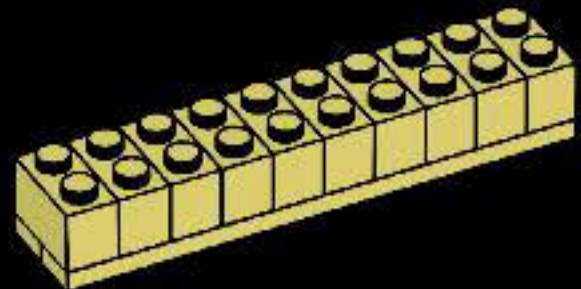

2x

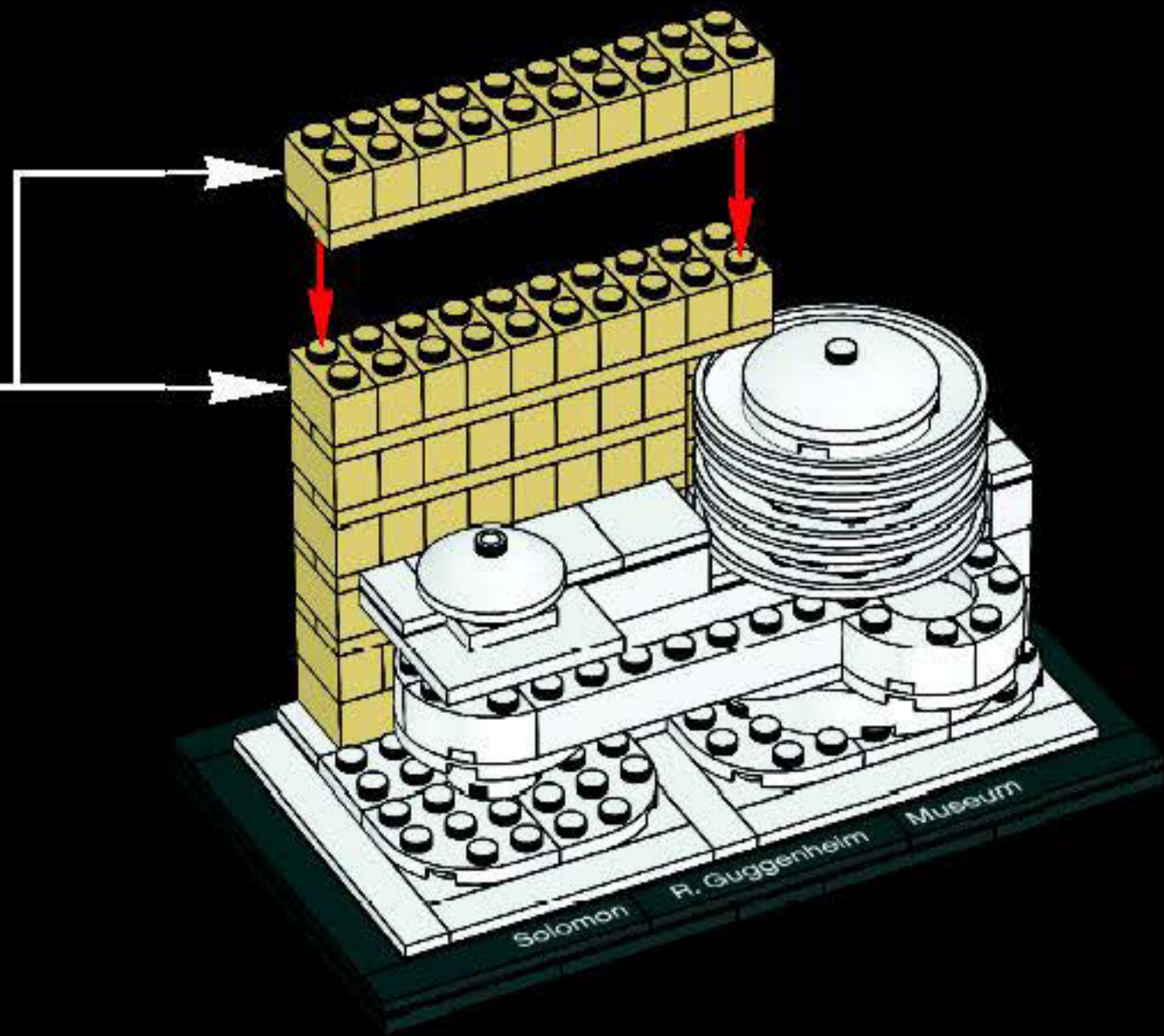

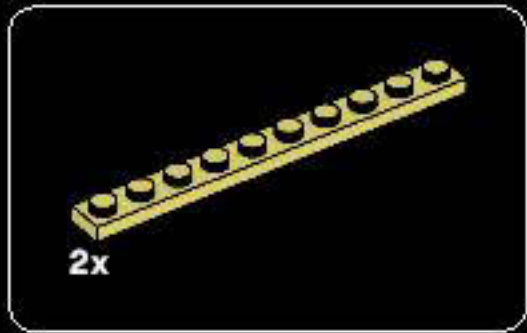

33

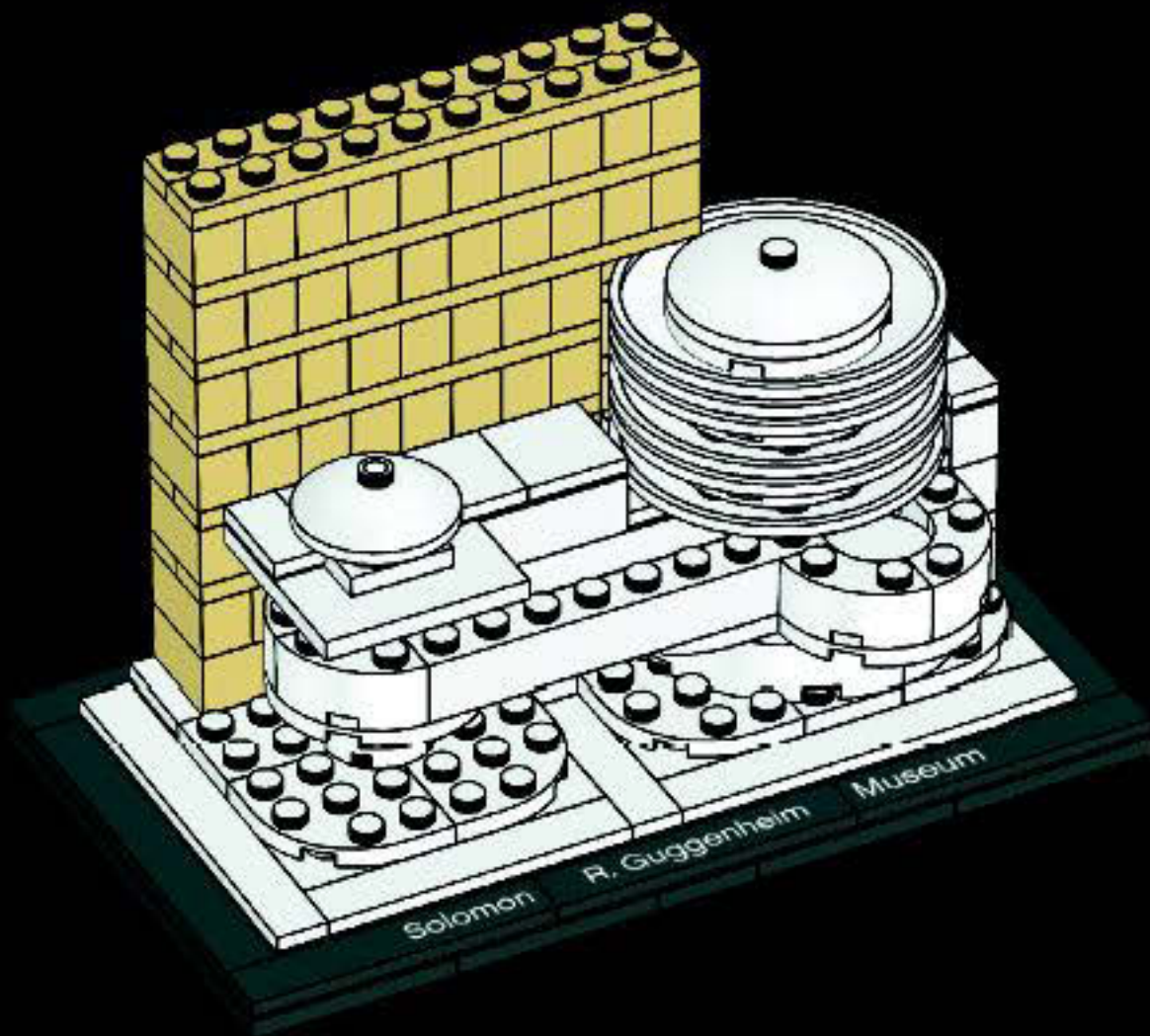

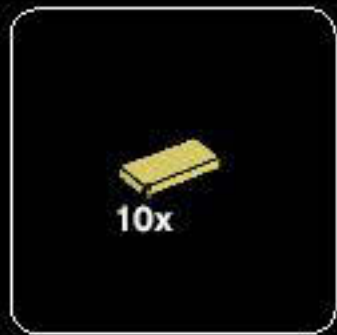

34

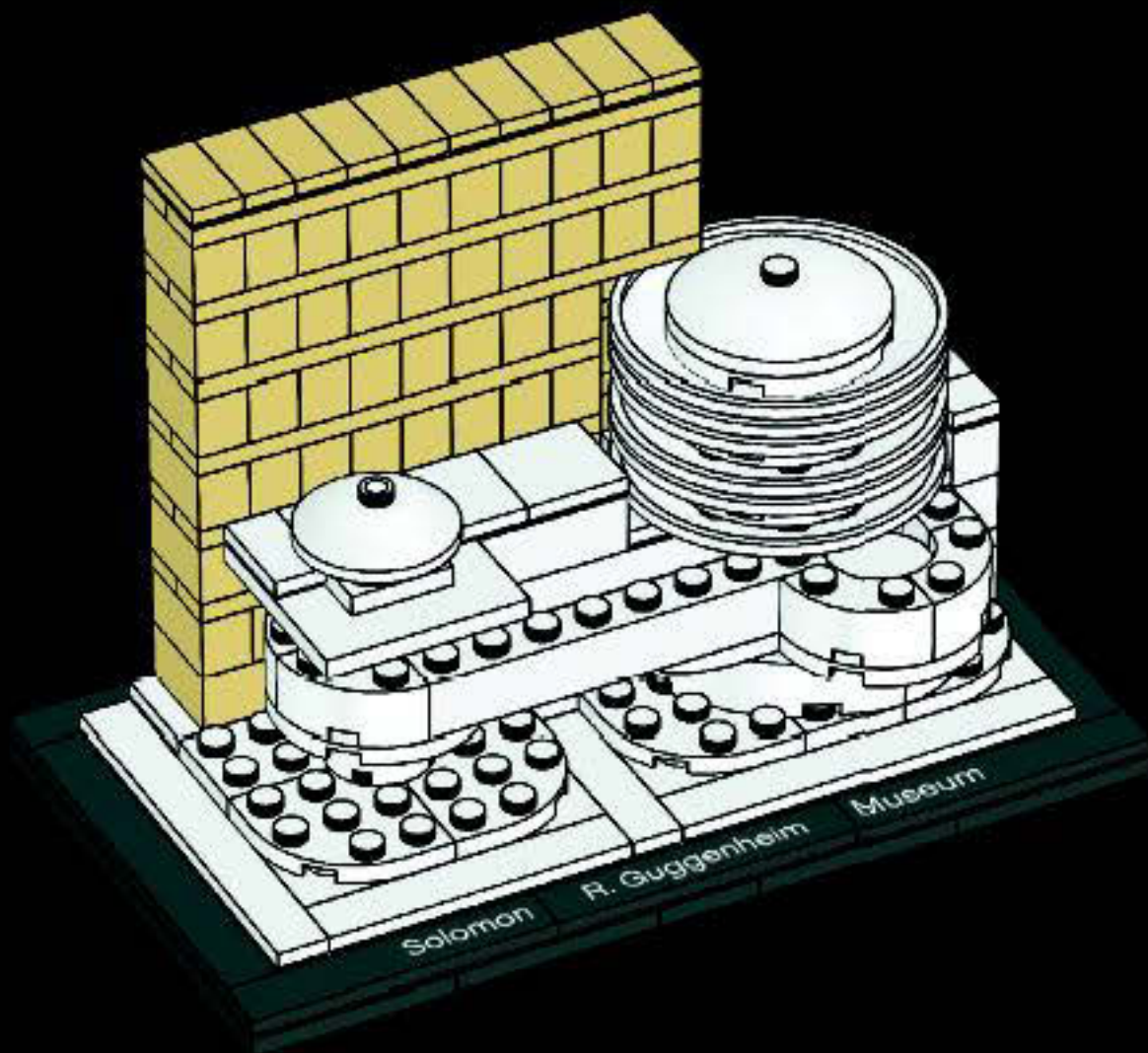

The Architect's Thoughts about the Building

"A museum should be one extended well-proportioned floor space from bottom to top – going around and up and down, throughout. The eye encounters no abrupt change but is gently led as if at the edge of the shore watching an unbreaking wave. No stops anywhere and such screened divisions of the space gloriously lit within from above as would deal appropriately with every group of paintings or individual painting as you want them classified."¹



Interior view of the Solomon R. Guggenheim Museum, New York. Photograph by Robert E. Mates © The Solomon R. Guggenheim Foundation, New York.



© F.L. Wright Fdn.



© Louis Reens

A Word from the Artist

As an Architectural Artist, my desire is to capture the essence of a particular landmark into its pure sculptural form, especially at this small scale. I first and foremost do not view my models as literal replicas, but rather my own artistic interpretations, harnessing the essence of these landmarks through the use of LEGO® bricks as a medium. The LEGO brick is not initially thought of as a material typically used in creating art or used as an artist's medium. I quickly discovered the LEGO brick was lending itself as naturally to my applications as paint to a painter or metal to a blacksmith. As I explore how to capture these buildings with the basic shapes of the bricks, I find the possibilities and challenges they offer almost magical.

This model embraces three creative techniques. The first of these is using the natural joints between a series of bricks as a subtle way of indicating geometric details. The second is the playful ways the curved bricks interact with each other really capture the forms essence that gives this museum its distinctive architectural style.

Last, the iconic upside down truncated spiral gallery was recreated by clever use of illusion. Here I employed a visual technique making the "cone" seem top heavy by using three disks, then two and then finally one. Since the discs share the same size diameter, making them seem heavy aloft was the necessary trick to fool your eyes into creating the tapering effect through your subconscious imagination. This effect is very subtle, but nonetheless there and effective.



– Adam Reed Tucker

LEGO® Architecture: Bringing two worlds together

The LEGO® Group and Adam Reed Tucker are excited to bring you LEGO Architecture, a new line of LEGO building sets that celebrates world-renowned architects, who continue to inspire the builders of tomorrow. Whether young and eager to learn or simply young at heart and intrigued by these modern day marvels, we hope the Architecture series inspires builders of all ages by celebrating the past, present and future of architecture through the LEGO brick. Through incredible products and exciting events, the Architecture series promotes awareness of the fascinating worlds of architecture, engineering and construction.

The launch of the LEGO Architecture series begins with a celebration of Frank Lloyd Wright, and one of the most famous buildings in the world, the Solomon R. Guggenheim Museum in New York City.

We hope to inspire future architects around the world with the LEGO brick as a medium. Enjoy this experience!

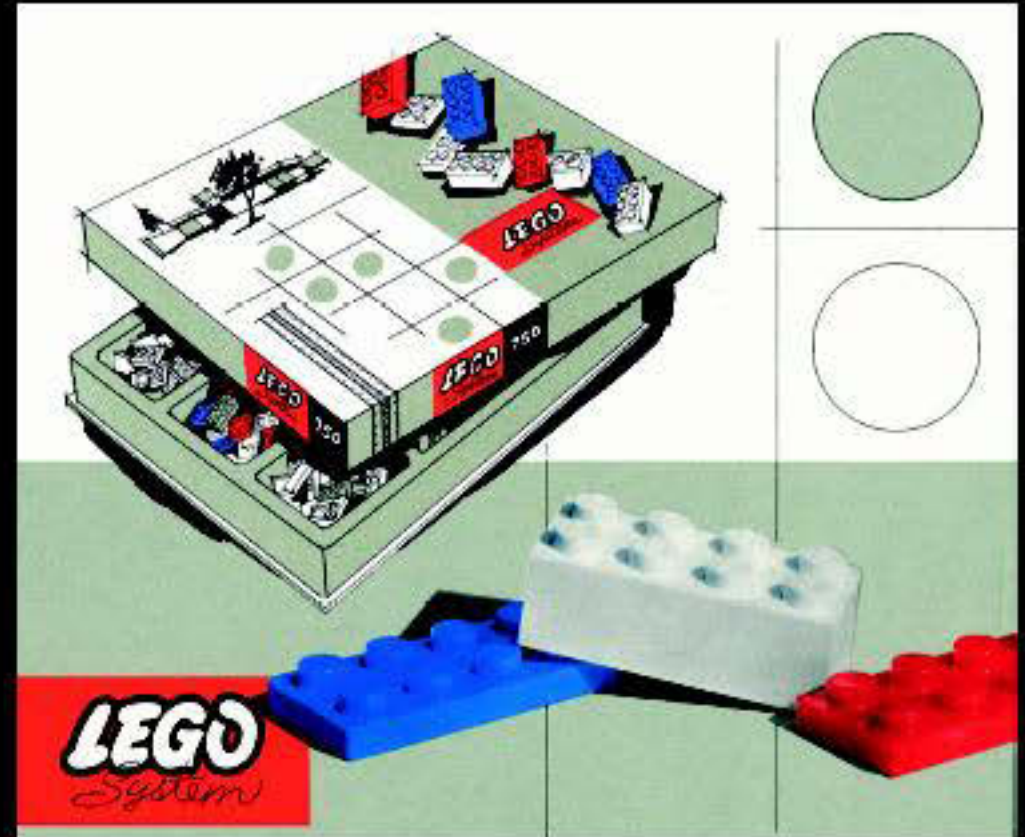

Visit www.LEGO.com/architecture or www.Brickstructures.com for more information



8x
4113915



54x
4109995



1x
4141533



1x
4113917



1x
4113233



2x
4118790



1x
4114309



10x
4114026



1x
4161734



3x
4140562



3x
4114324



9x
4143409



1x
370626



1x
4561429



1x
4561430



1x
4561431



2x
416226



3x
663626



4x
303026



1x
383226



4x
302101



1x
302201



2x
302301



2x
242001



1x
4243812



1x
303201



3x
303501



1x
379501



2x
303401



2x
244501



1x
415001



10x
306801



3x
307001



3x
306901



2x
243101



2x
663601



2x
416201



9x
379401



1x
346001



1x
366601



3x
371001



4x
300401



1x
362201



1x
301001



3x
300901



2x
300801



1x
300201



1x
4181142



2x
235701



2x
614301



5x
4501579



1x
4215470



4x
403201



5x
4515347



5x
4550745



1x
4179580



1x
3986001



6x
4514791



1x
617901

References

Page 3:

- [1] *Frank Lloyd Wright in "letter to Countess von Rebay, Guggenheim's collection curator", 1944*
- [2] *Bruce Brooks Pfeiffer in "Frank Lloyd Wright Masterworks", pg. 2*

Pages 4-5:

- [3] *Bruce Brooks Pfeiffer in "Frank Lloyd Wright Masterworks", pg. 207*
- [4] *Bruce Brooks Pfeiffer in "Frank Lloyd Wright Masterworks", pg. 209*
- [5] *Bruce Brooks Pfeiffer in "Frank Lloyd Wright Masterworks", pg. 209*
- [6] *Bruce Brooks Pfeiffer in "The Solomon R. Guggenheim Museum", pg. 29*

The publicity rights to the name and likeness of Frank Lloyd Wright belong to the Frank Lloyd Wright Foundation, Taliesin West, Scottsdale, Arizona. Frank Lloyd Wright, the Frank Lloyd Wright signature, the Frank Lloyd Wright Collection logo, and the authorized product logo (rectangular logo box) are registered trademarks of the Frank Lloyd Wright Foundation. The drawings and designs of Frank Lloyd Wright are © copyright the Frank Lloyd Wright Foundation.

The Solomon R. Guggenheim Museum name is a trademark of The Solomon R. Guggenheim Foundation. Used by permission.

For further information please visit:
www.franklloydwright.org

Customer Service

Kundenservice

Service Consommateurs

Servicio Al Consumidor

www.lego.com/service or dial



00800 5346 5555 :

1-800-422-5346 :



Architecture^{lp}

This product is authorized
by the Frank Lloyd Wright
Foundation, Taliesin West,
Scottsdale, Arizona.

