









MINECRAFT

21102

Micro World - The Forest
Micro-Monde - La forêt
Micromundo: El Bosque





-  Booklet available in English on
-  Heft in deutscher Sprache erhältlich auf
-  Livret disponible en français sur
-  Folleto disponible en español en
-  Folheto disponível em português em
-  A füzet magyarul ezen a honlapon olvasható: LEGO.cuusoo.com

MINECRAFT



 MOJANG

 Minecraft is a sandbox construction game, inspired by Infiniminer, Dwarf Fortress and Dungeon Keeper, created by Markus Persson, the founder of Mojang AB. The game involves players creating and destroying various types of blocks in a three dimensional environment. The player takes an avatar that can destroy or create blocks, forming fantastic structures, creations and artwork across the various multiplayer servers in multiple game modes.

 Minecraft est un jeu de construction « bac à sable » inspiré d'Infiniminer, Dwarf Fortress et Dungeon Keeper, créé par Markus Persson, le fondateur de Mojang AB. Dans ce jeu, les joueurs créent et détruisent divers types de blocs dans un environnement en trois dimensions. Le joueur incarne un avatar qui peut détruire ou créer des blocs, formant ainsi des structures, des créations et des images fantastiques au travers de divers serveurs multi-joueurs et dans des modes de jeu multiples.

www.minecraft.net



CUUSOO

About LEGO® CUUSOO

LEGO® Minecraft Micro World earned the opportunity to become a LEGO product through LEGO® CUUSOO, an online idea collection system where LEGO fans can submit their own ideas for the chance to become a LEGO product. Ideas that are supported by 10,000 votes have a chance of being produced. LEGO fans whose ideas are chosen earn 1% of the total net sales of the product.

À propos de LEGO® CUUSOO

LEGO® Minecraft Micro World est devenu un produit LEGO grâce à LEGO® CUUSOO, un système de collecte d'idées en ligne où les fans LEGO peuvent envoyer leurs propres idées pour qu'elles deviennent, peut-être, un produit LEGO. Les idées qui reçoivent 10 000 votes ont une chance d'être produites. Les fans LEGO dont les idées sont choisies gagnent 1 % de la totalité des ventes nettes du produit.



Model by
Modèle conçu par
Michael Thomas



Model by
Modèle conçu par
Chris Malloy

Thanks to Our Fans

This product was developed in collaboration with four LEGO fans; Chris Malloy, Michael Thomas, Kyle Tingey, and Bjarne Panduro Tveskov. Kyle and Michael submitted LEGO Minecraft as an idea to LEGO CUUSOO, and all four built their own concepts as our designers created the model that became the set you have in your hands.

Merci à nos fans

Ce produit a été développé en collaboration avec quatre fans LEGO : Chris Malloy, Michael Thomas, Kyle Tingey, et Bjarne Panduro Tveskov. Kyle et Michael ont envoyé LEGO Minecraft comme idée à LEGO CUUSOO, et tous les quatre ont construit leurs propres concepts à partir duquel nos designers ont créé le modèle qui est devenu l'ensemble que tu as entre les mains.

You can submit your own ideas
Tu peux envoyer tes propres idées

LEGO.cuusoo.com

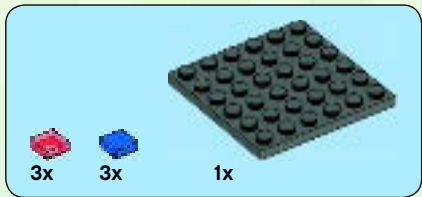

1

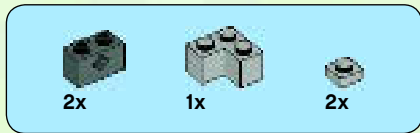
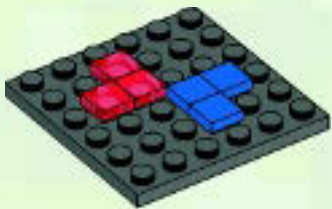

2

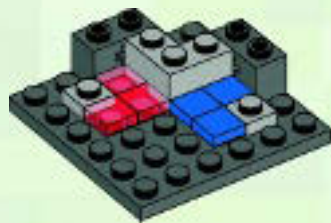

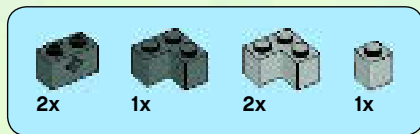

3

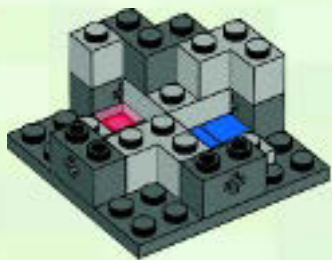

4

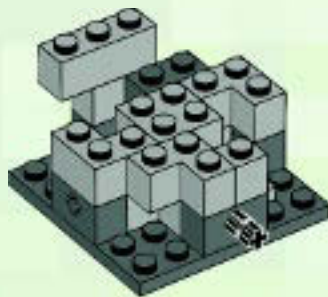



1x



1x



1x

5

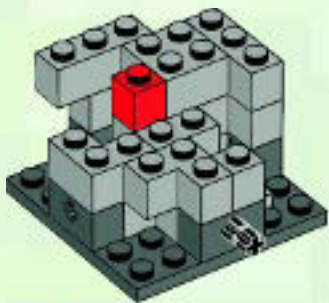

1x



1x



2x



1x

6

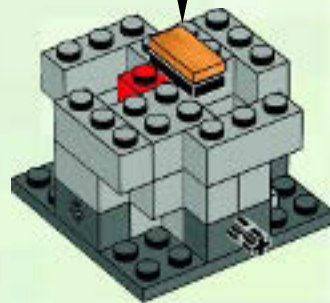
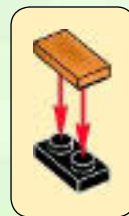

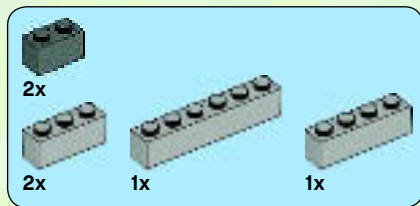

7

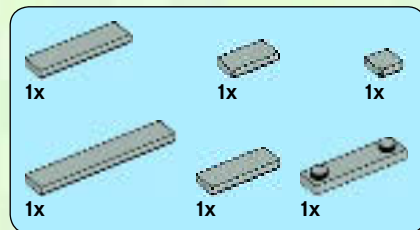
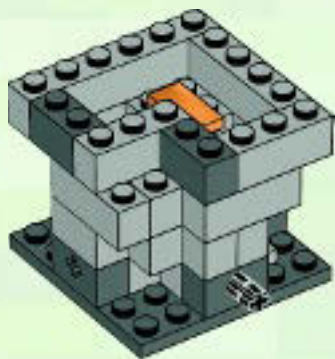

8

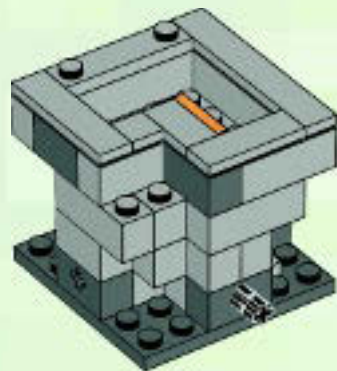

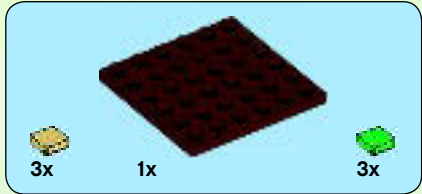

1

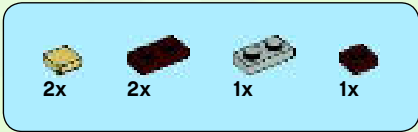

2

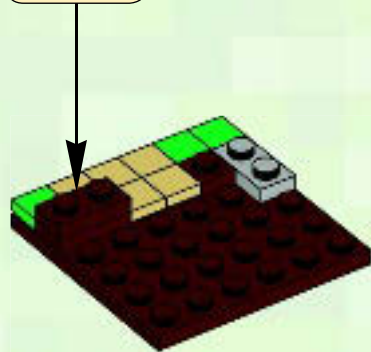
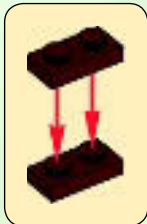



3

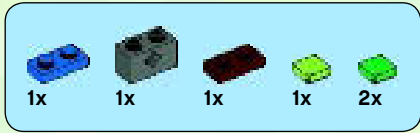
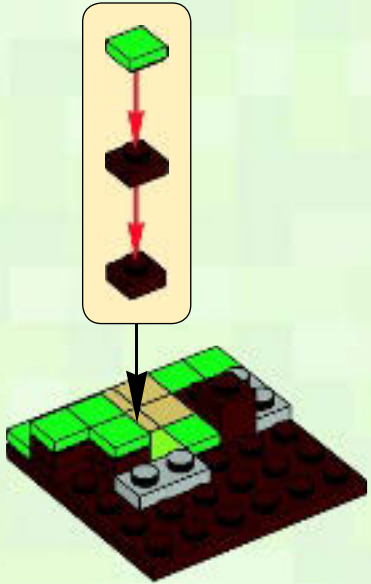

4

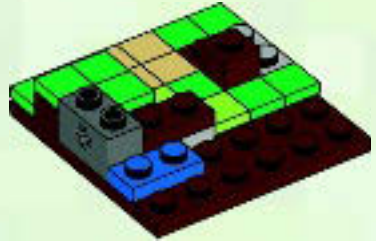



5

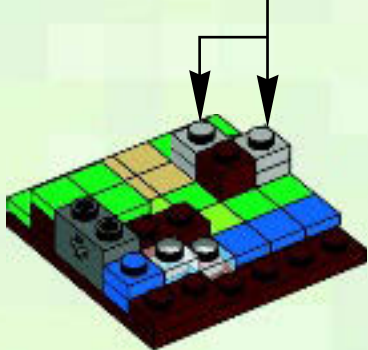
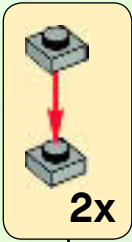

6

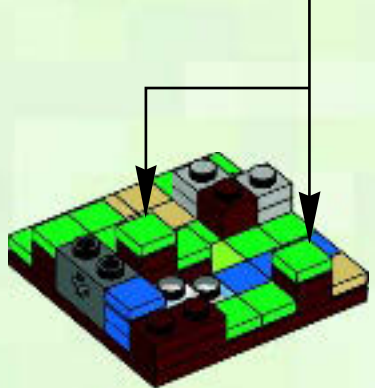
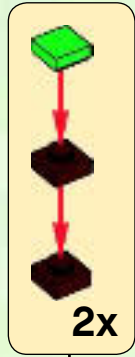



1x



3x



2x

7

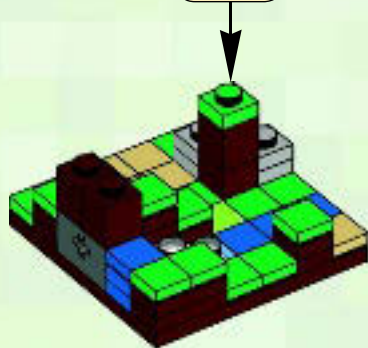
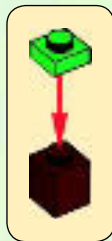

2x

8

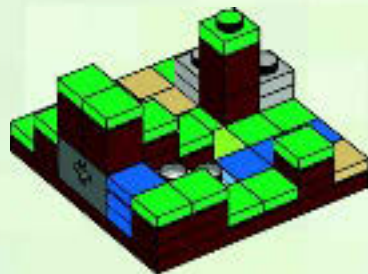



9

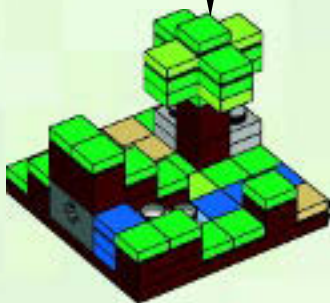
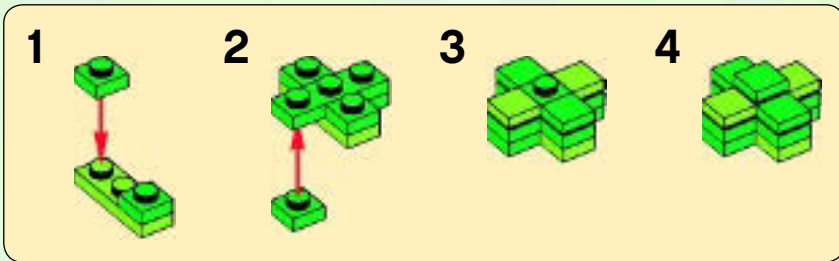

10

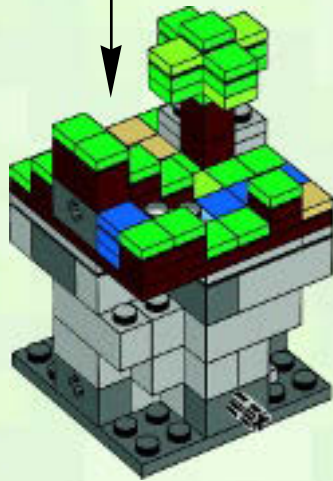



1

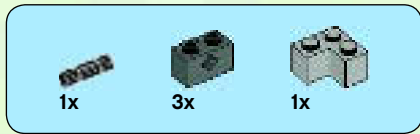
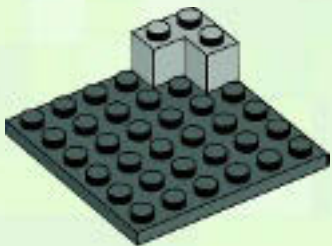

2

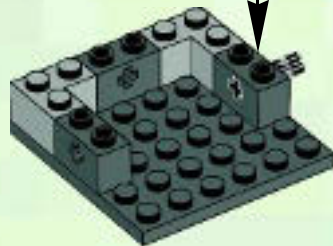
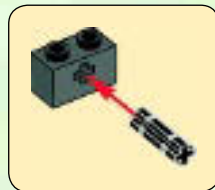



3

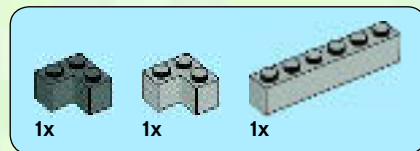

4

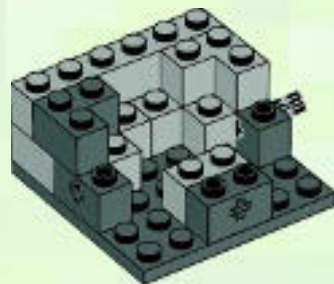

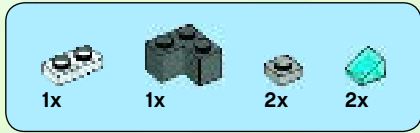

5

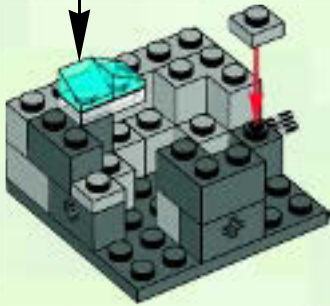
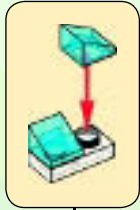

6

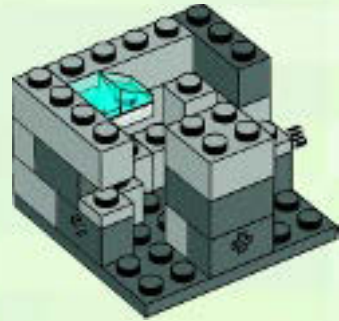

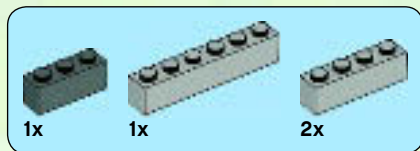

7

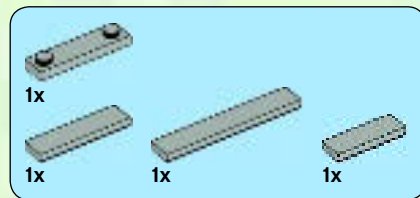
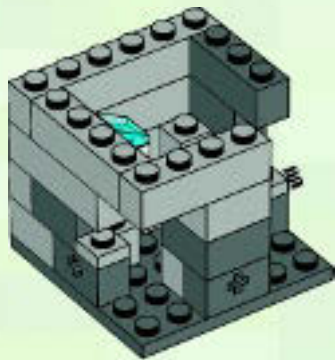

8

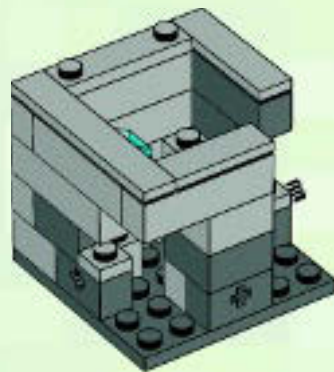

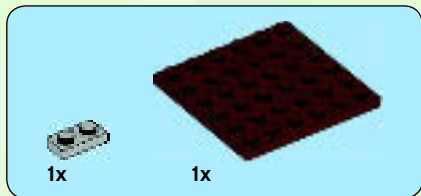
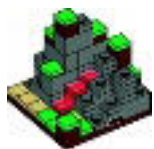

1

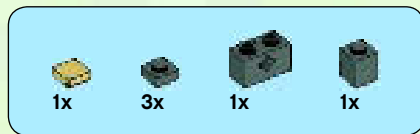

2

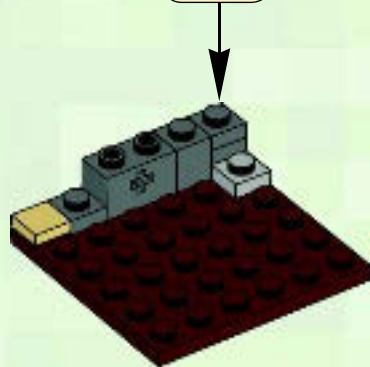
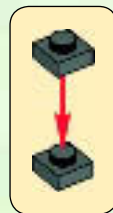

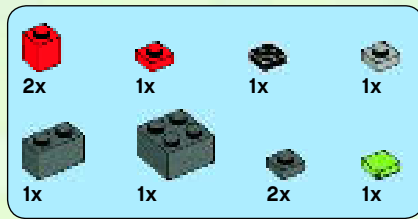

3

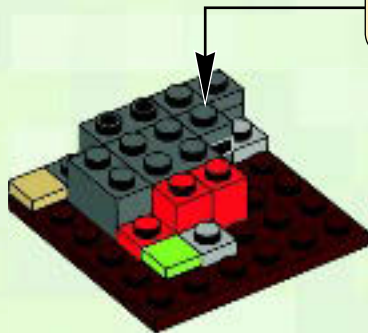

4



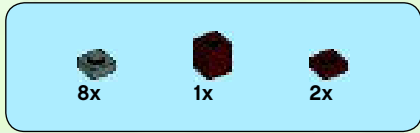

5

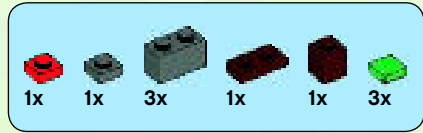
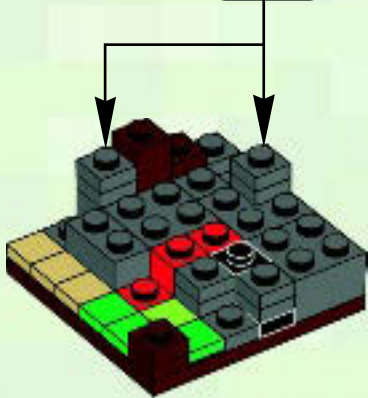
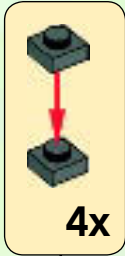

6

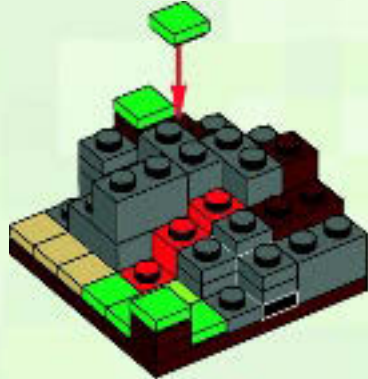



7

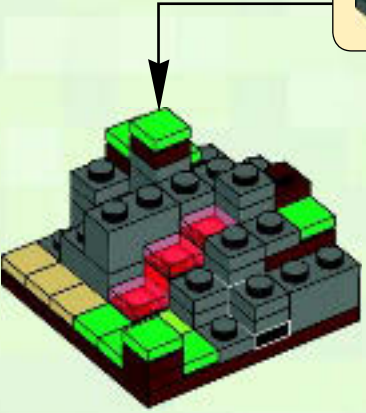

8

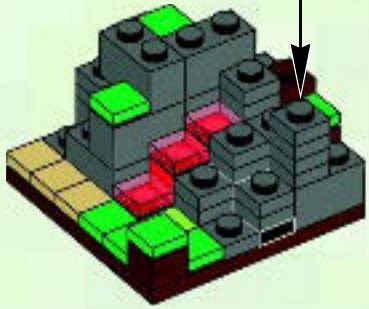
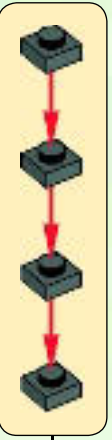

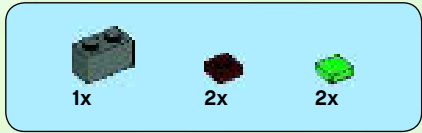

9

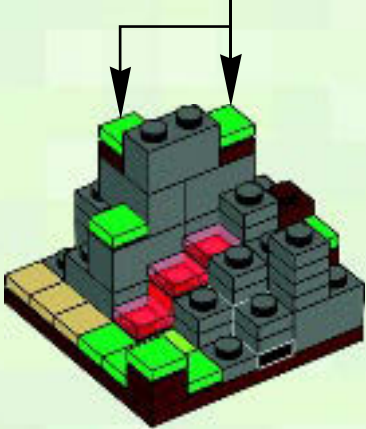
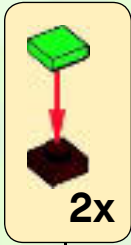

10

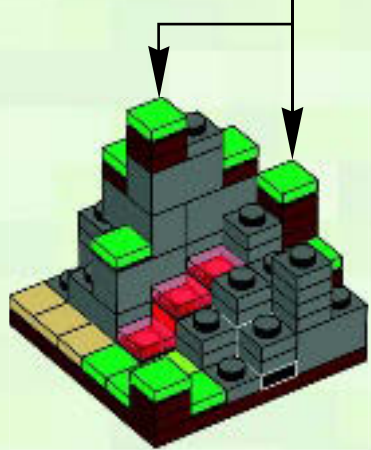
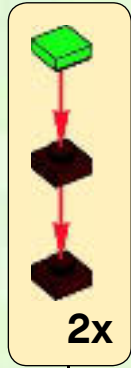

11

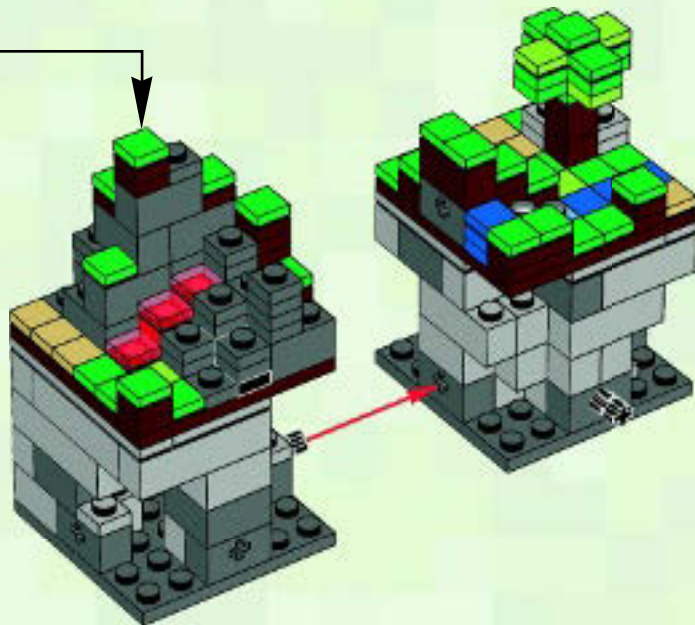

LEGO and the LEGO logo are trademarks of the/son des marques de commerce de/
son marcas registradas de LEGO Group. ©2012 The LEGO Group.

© 2012 Notch Developments AB, MINECRAFT is a trademark of/est une marque déposée de/es una marca comercial de
Notch Developments AB, MOJANG is a trademark of/est une marque déposée de/es una marca comercial de Mojang AB.



WIN!

Go to LEGO.com/productfeedback to fill out a survey for a chance to win a cool LEGO® Product.

No purchase necessary.
Open to all residents where not prohibited.



LEGO.com/productfeedback

GEWINNE!

Nimm an der Umfrage auf LEGO.com/productfeedback teil und hab die Chance ein cooles LEGO® Produkt zu gewinnen!

Die Teilnahme am Gewinnspiel führt zu keinerlei Kaufverpflichtungen. Teilnahme in allen nicht ausgeschlossenen Ländern möglich.

 LEGO.com

6088383

WIN!

Ga naar LEGO.com/productfeedback, vul een enquêteformulier in en maak kans op een cool LEGO® product.

Geen aankoopverplichting.
Iedereen mag deelnemen, uitgezonderd ingezetenden van landen waar een enquêteverbod geldt.

GAGNE!

Visite LEGO.com/productfeedback pour répondre à un questionnaire et avoir une chance de gagner un produit LEGO® très cool!

Aucune obligation d'achat.
Ouvert à tous les résidents des pays autorisés.

当てよう!

LEGO.com/productfeedback にアクセスして、アンケートにご記入ください。当選者にはレゴ®製品を差し上げます。

お買い上げの必要はありません。
禁止されていない限り、すべての皆様にご利用いただけます。