



Инструкция ЛЕГО (Lego) 31042-3

# CREATOR

31042



[LEGO.com/creator](http://LEGO.com/creator)

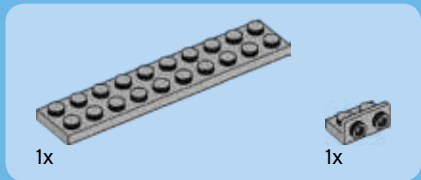
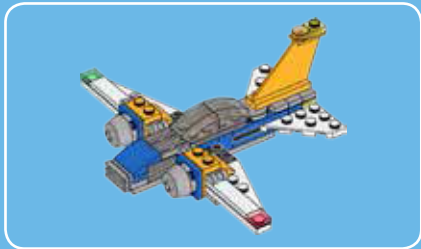

1

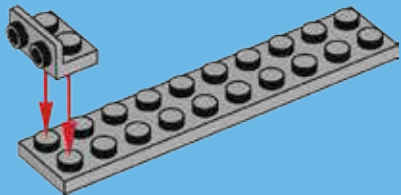

2



2

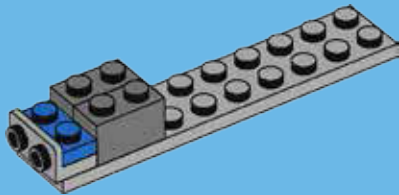



1x



1x

3

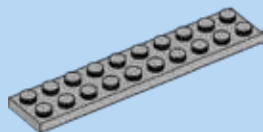
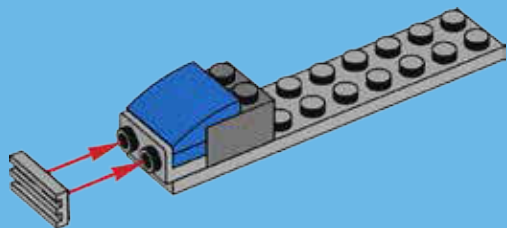

1x

4

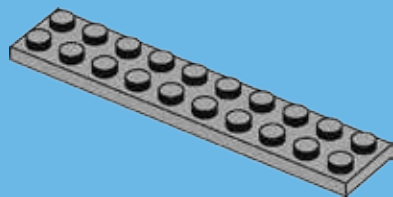



2x



1x

5

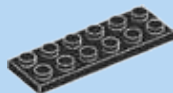
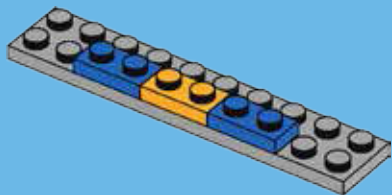

1x

6

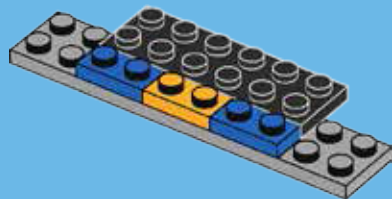



1x



1x

7

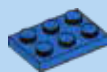
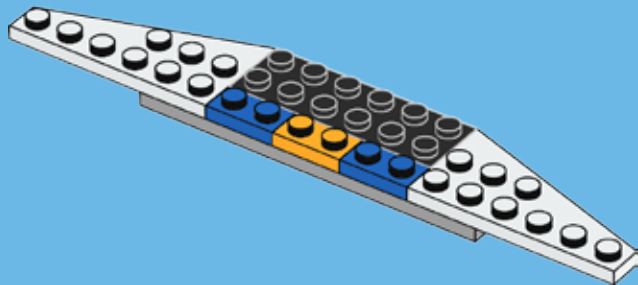

1x



2x

8

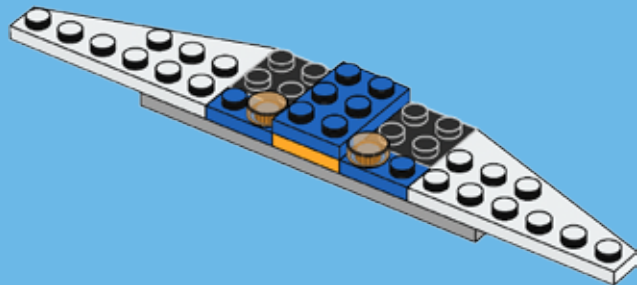



2x



2x

9

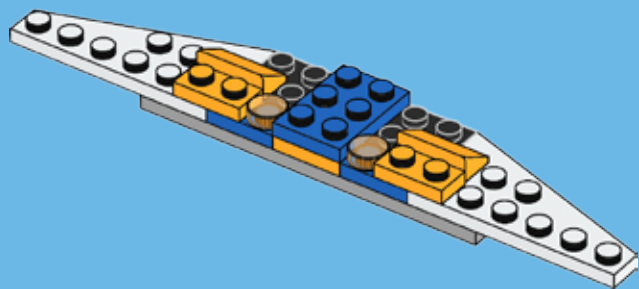

2x



1x



1x

10

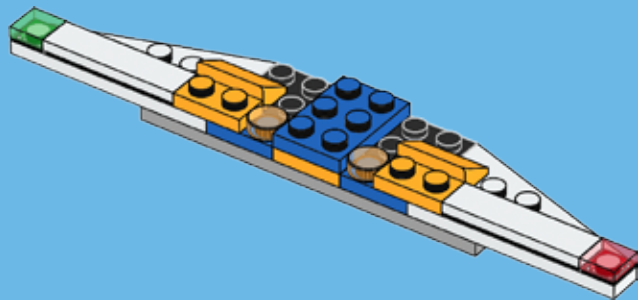



2x

11

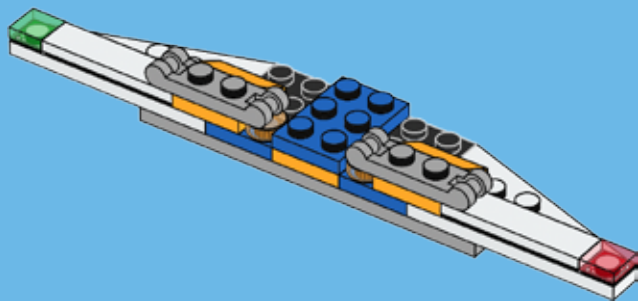

2x

12

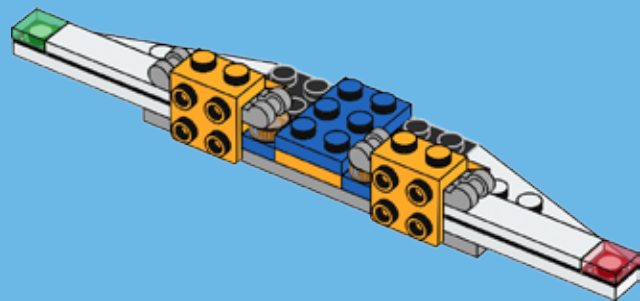



2x



2x



2x

# 13

1

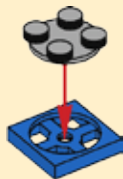

2



2x

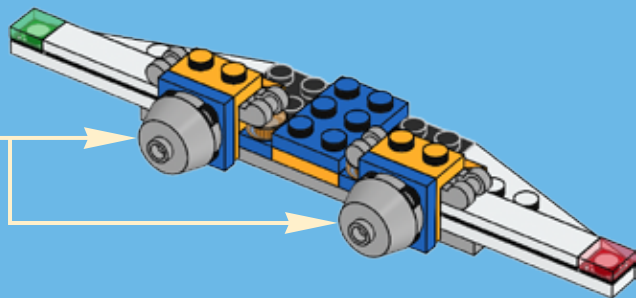



14

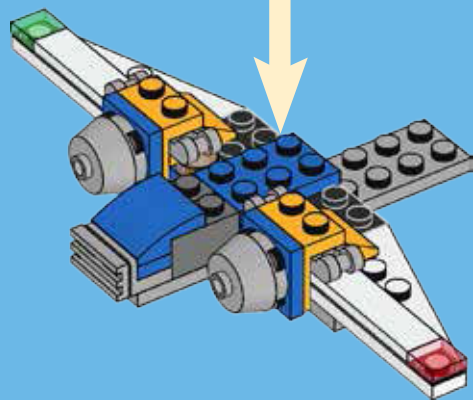

1x

15

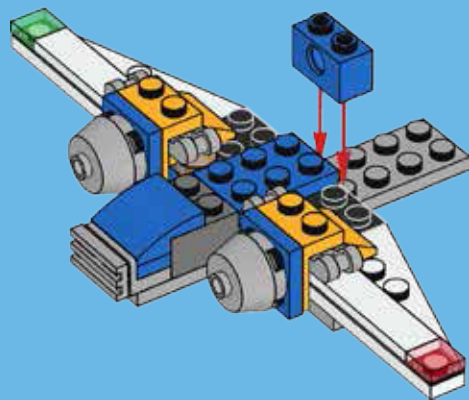



1x



1x

# 16

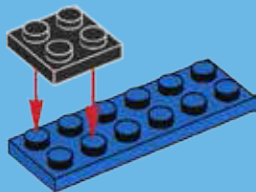

2x

# 17

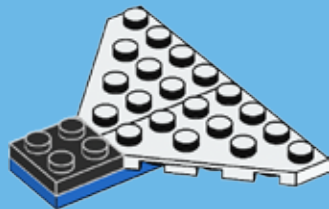



2x

18

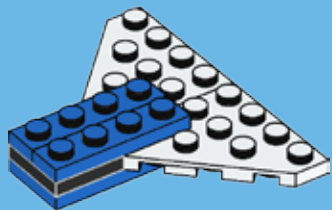

1x



2x

19

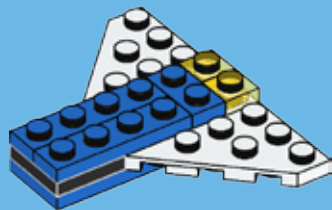



1x



3x

20

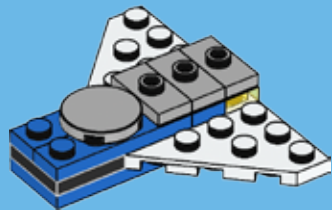

1x

21

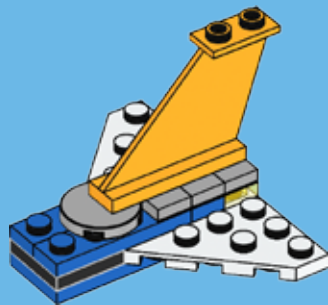



1x



1x

22

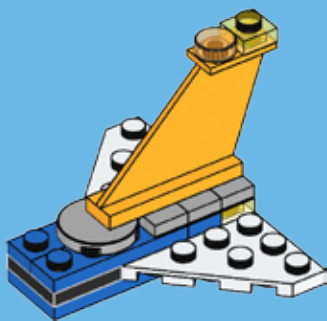

23

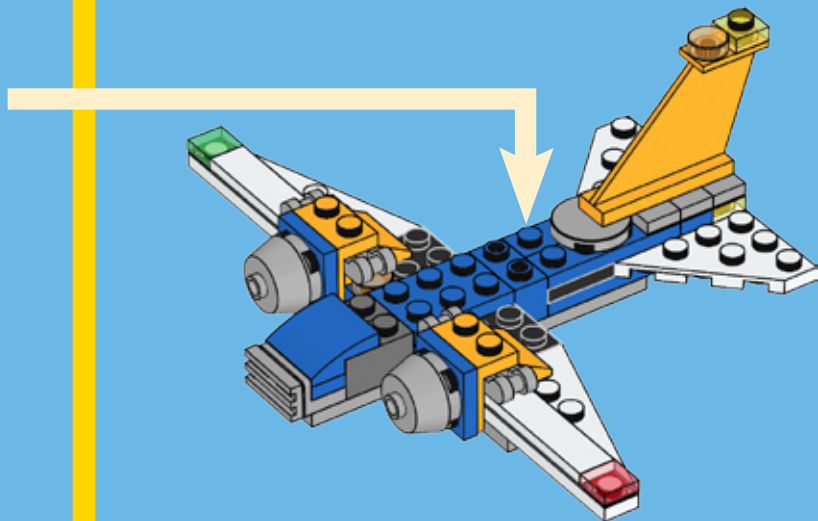



1x



2x

# 24

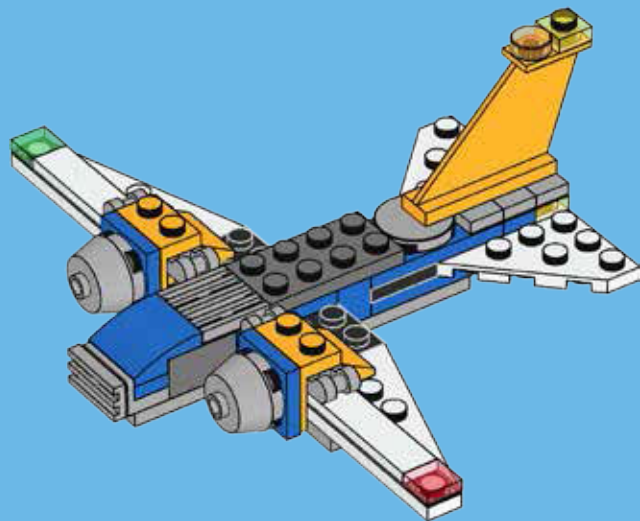



2x

25

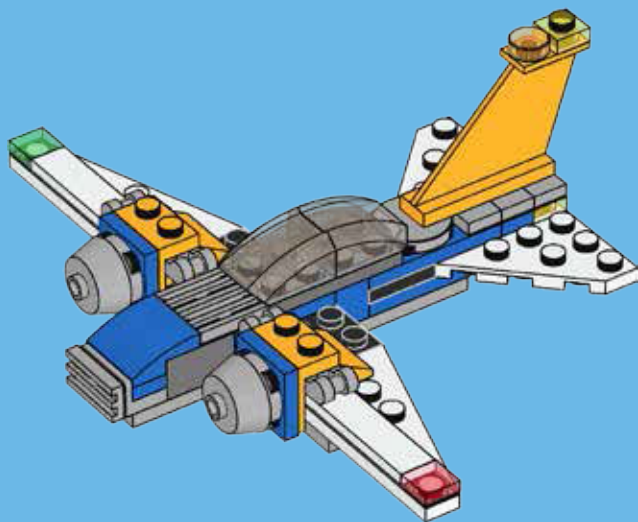



# CREATOR



[LEGO.com/creator](http://LEGO.com/creator)



Apple, the Apple logo, iPad, iPhone and iPod touch are trademarks of Apple Inc., registered in the U.S. and other countries. App Store is a service mark of Apple Inc.

Apple, le logo Apple, iPad, iPhone et iPod touch sont des marques de commerce d'Apple Inc., déposées aux États-Unis et dans d'autres pays. App Store est une marque de service d'Apple Inc.

Apple, el logotipo de Apple, iPad, iPhone e iPod touch son marcas comerciales de Apple Inc registradas en EE. UU. y otros países. App Store es una marca de servicio de Apple Inc.

Google Play is a trademark of Google Inc. Google Play est une marque de commerce de Google Inc. Google Play es una marca comercial de Google Inc.

LEGO and the LEGO logo are trademarks of the/sont des marques de commerce du/son marcas registradas de LEGO Group. ©2016 The LEGO Group.

6145954 / 6145955