



Friends



3186



Andrea



Mia



Stephanie



Friends



Olivia



Emma

1

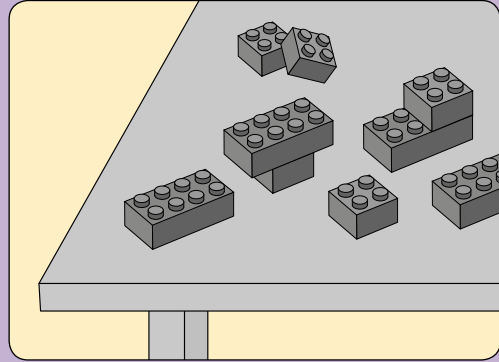
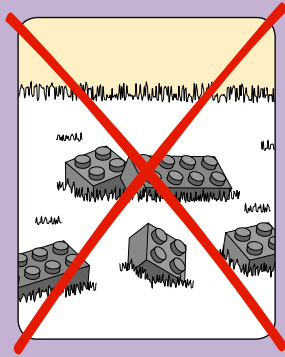

2

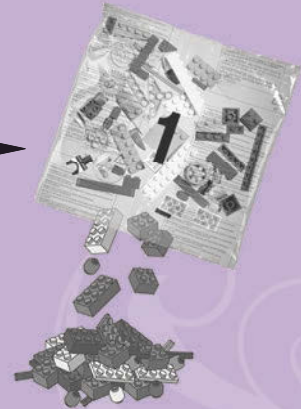

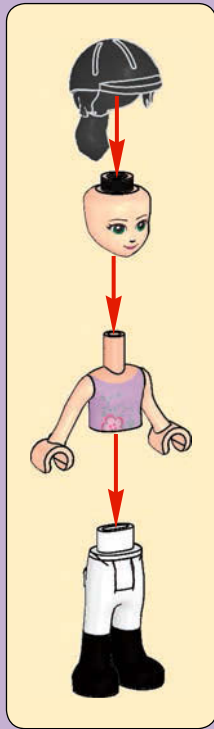
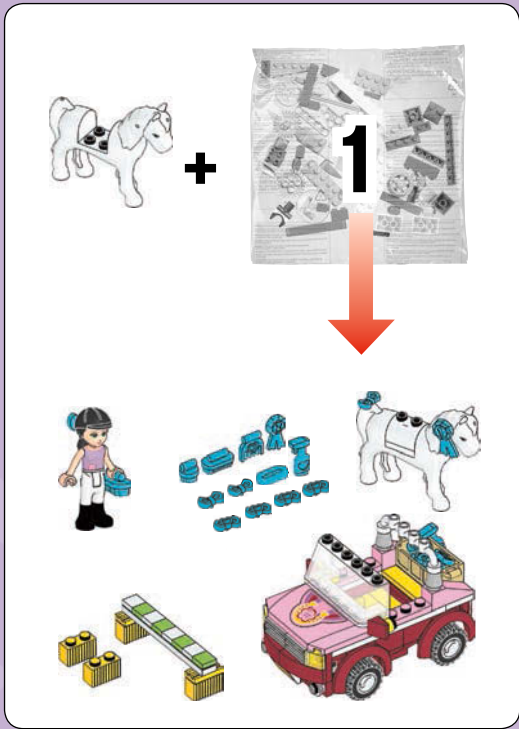



1x



1x

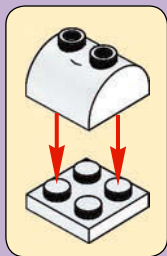

1

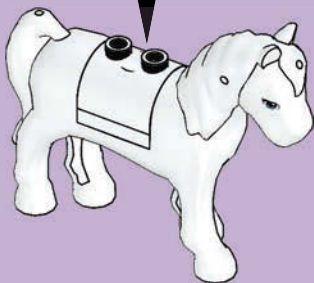

2

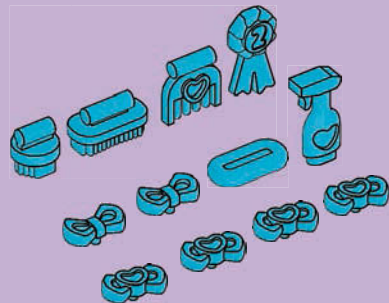

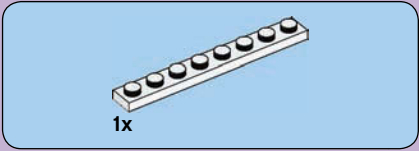
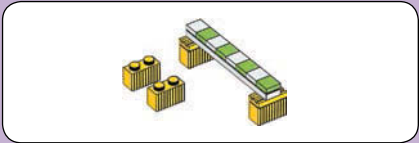

1x

1

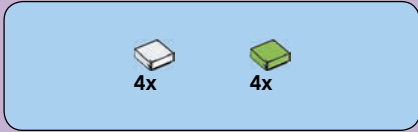

4x

4x

2

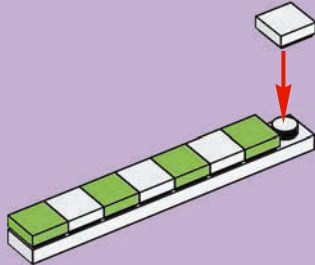



2x



2x

3

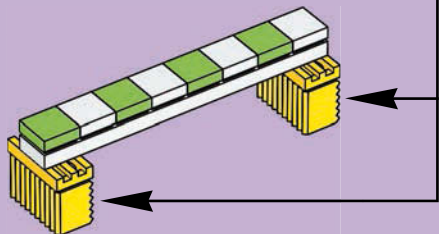
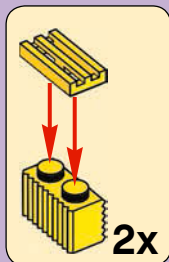

2x

4

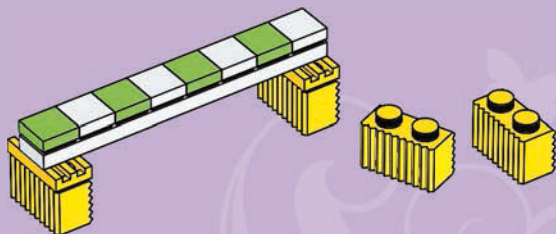

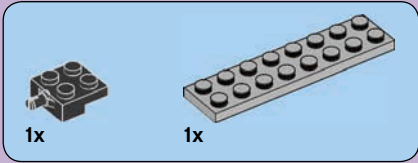
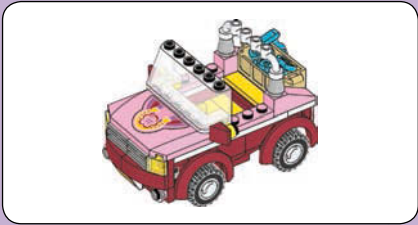

1

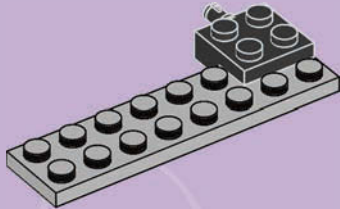

2

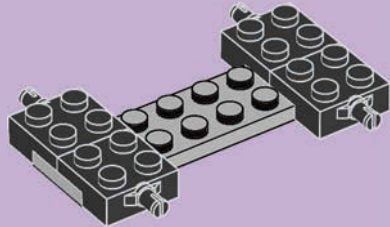



2x

3

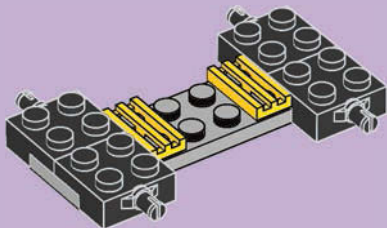

1x



1x

4

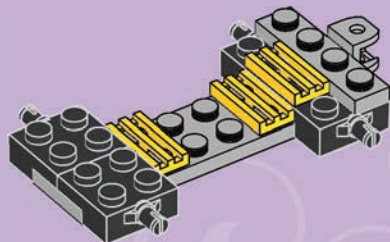

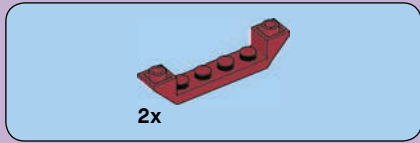

5

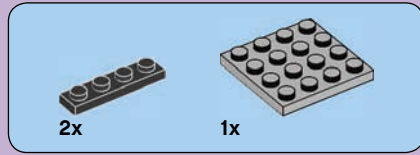
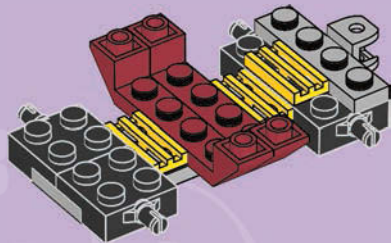

6

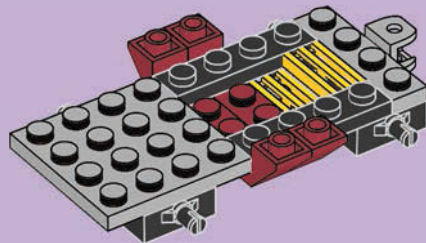



7

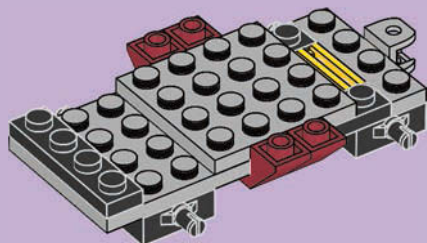

8

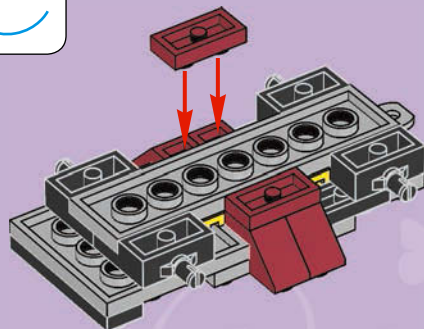
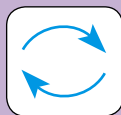

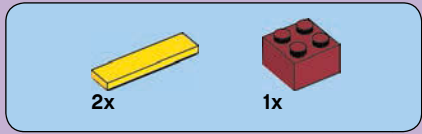

9

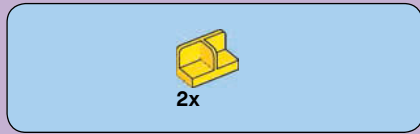
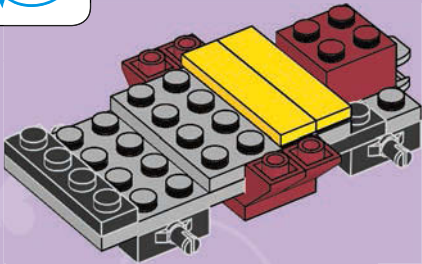

10

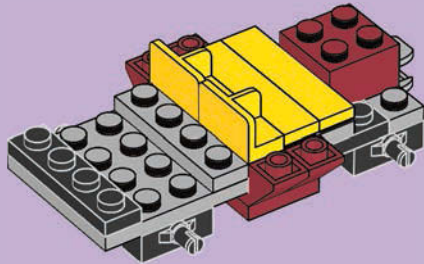

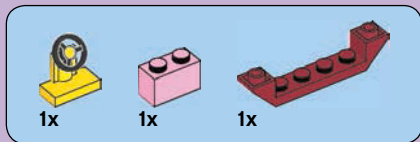

11

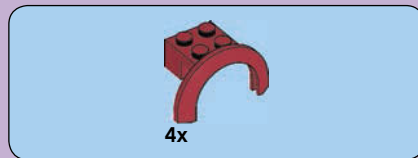
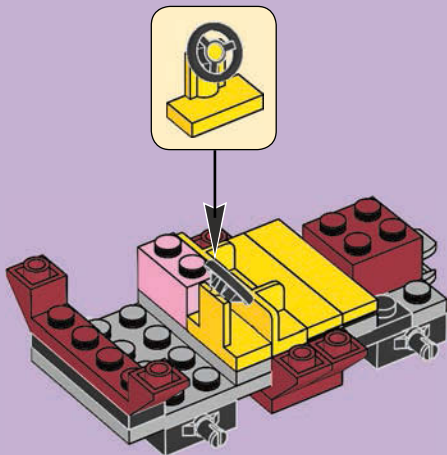

12

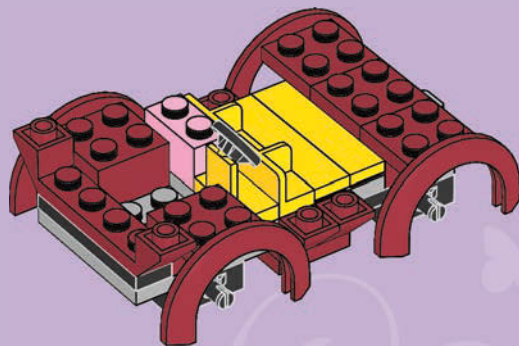

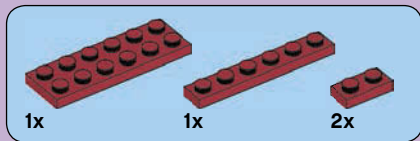

13

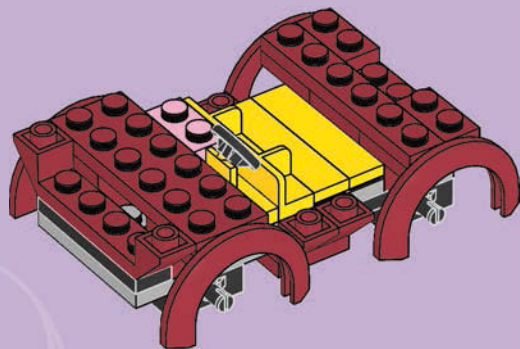



4x

14

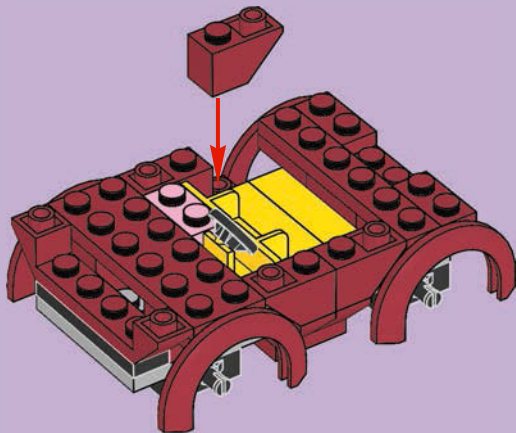



15

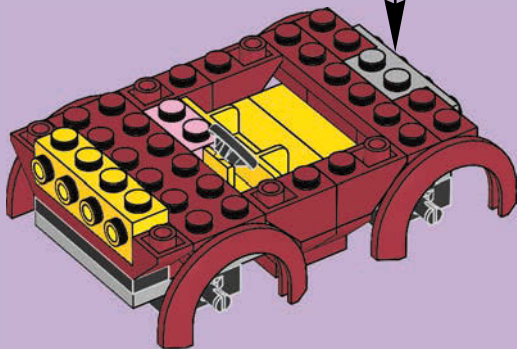
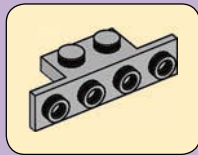



1x



1x

1

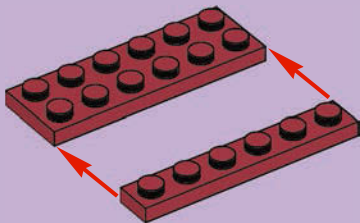

2x



1x



1x

2

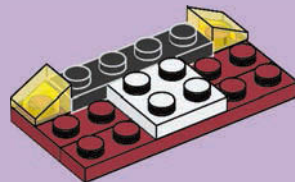



2x



2x

3

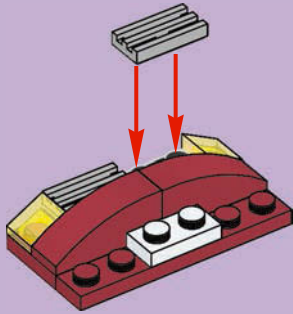

2x



2x



1x

4

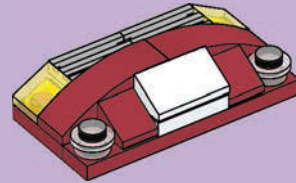

5

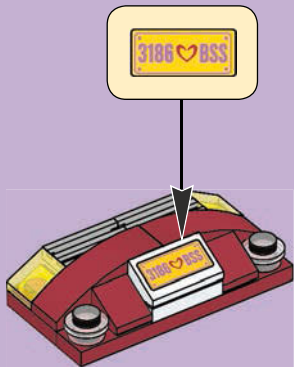

16

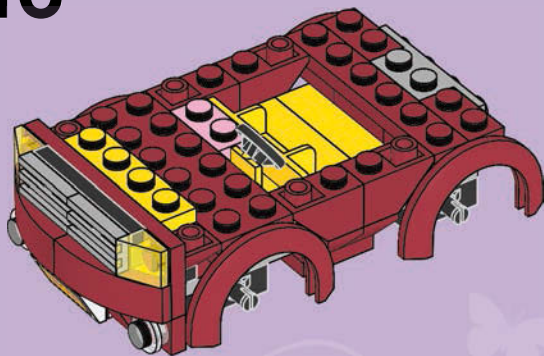

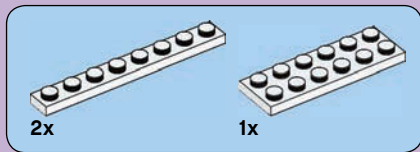

17

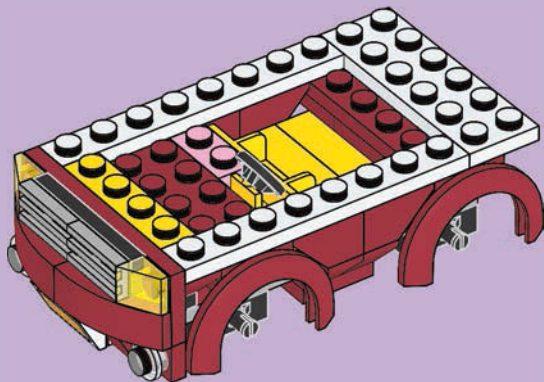



1x



1x

18

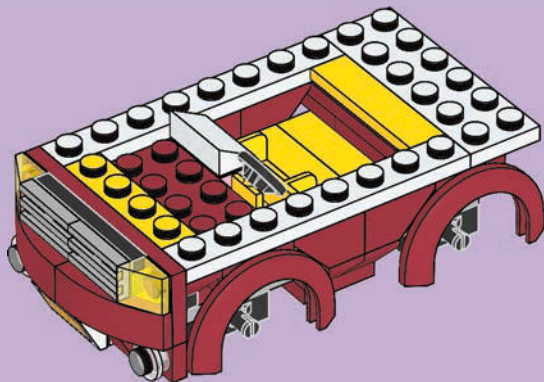

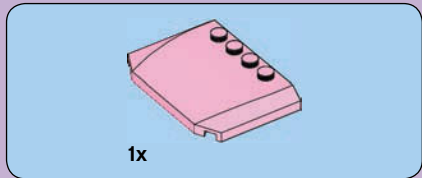

19

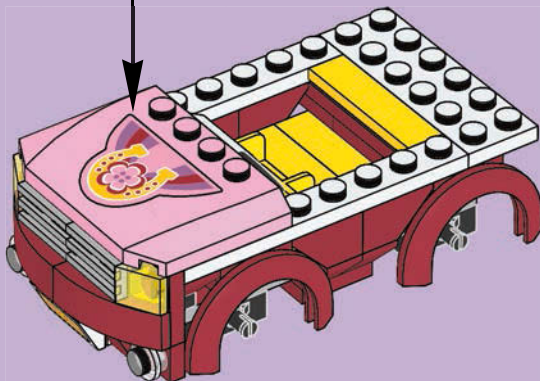



2x



2x

20

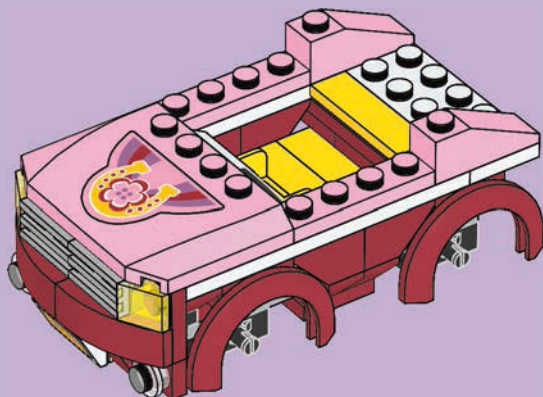

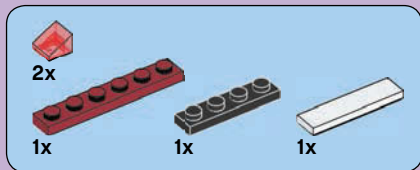

21

1

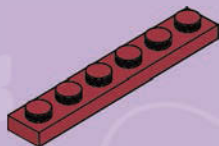

2

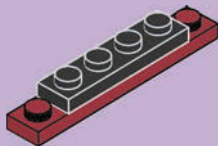

3

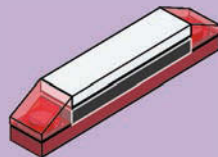

4

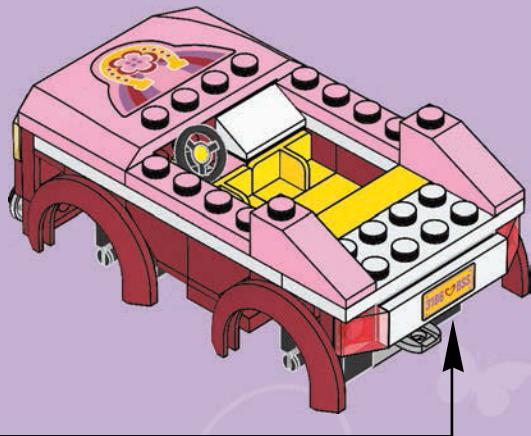
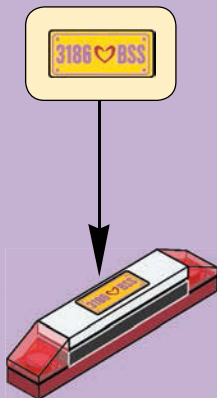



2x



2x

22

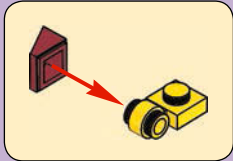
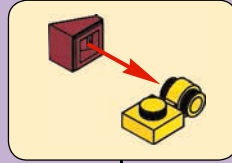



2x



1x

23



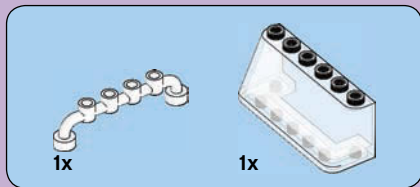

24

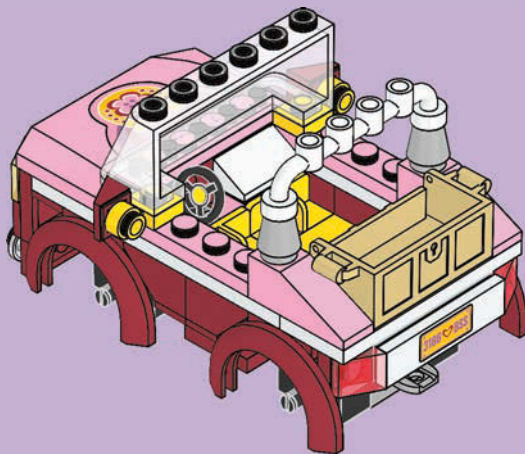



4x



4x

25

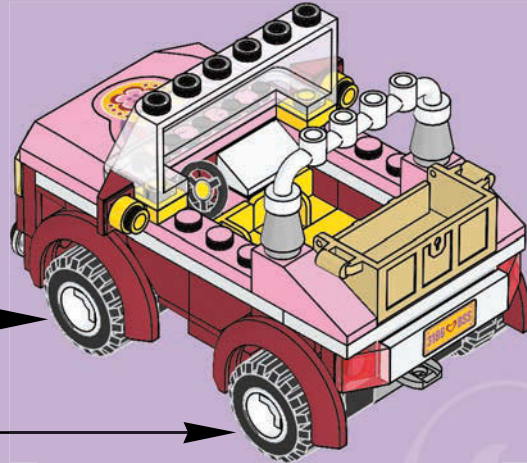
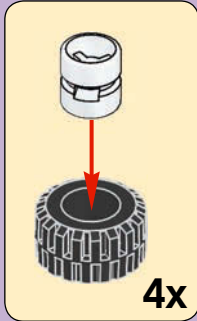

26

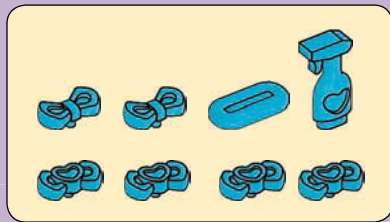
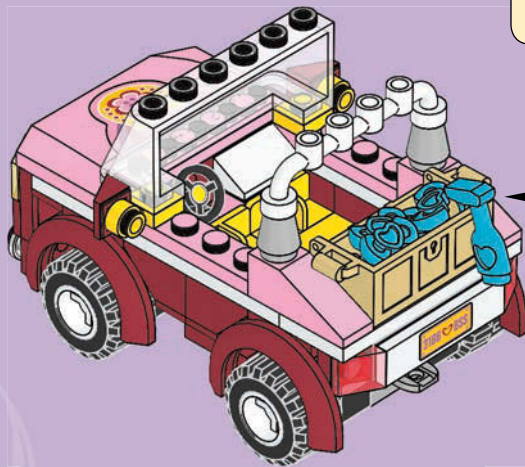

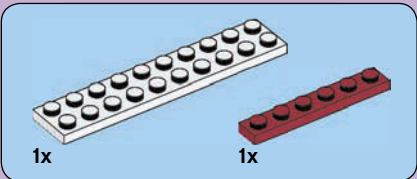
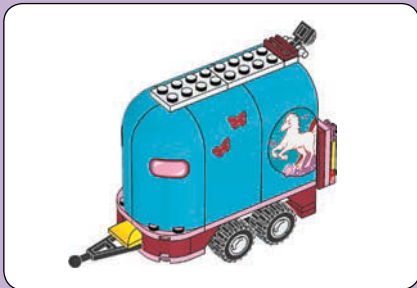
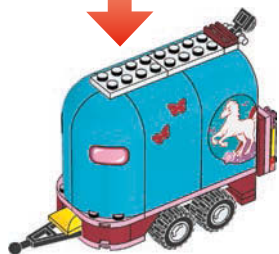

1

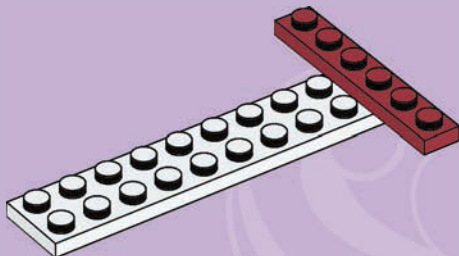



1x

2

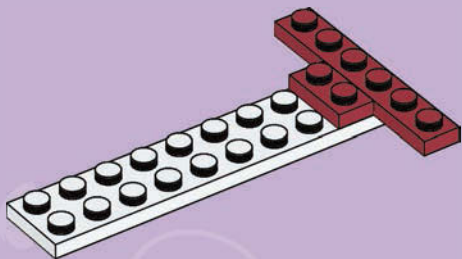

2x

3

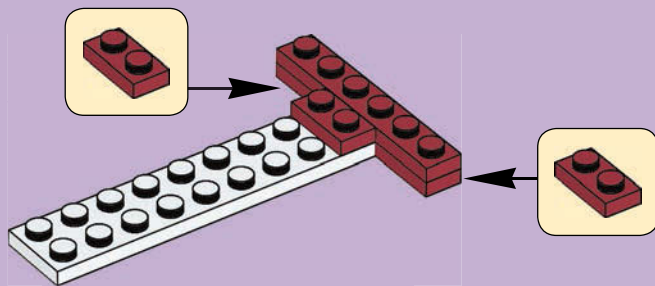



2x

4

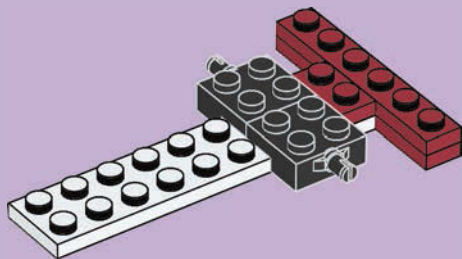

2x



2x

5

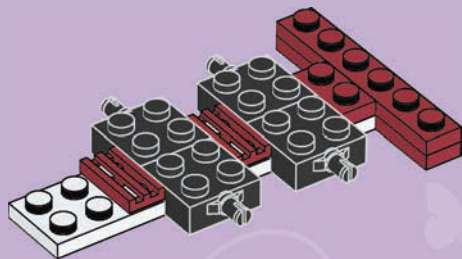



2x

6

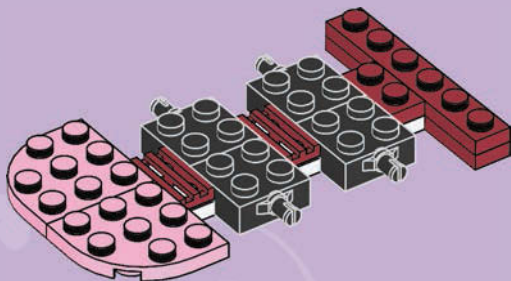

2x



2x

7





8

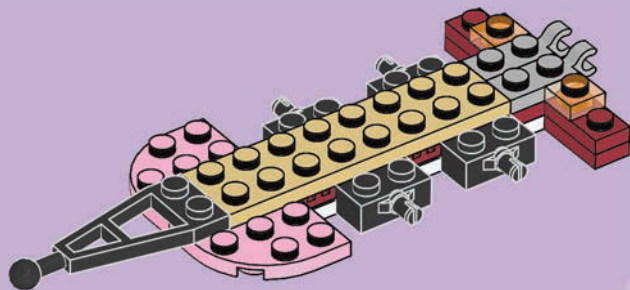

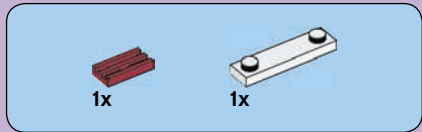

9

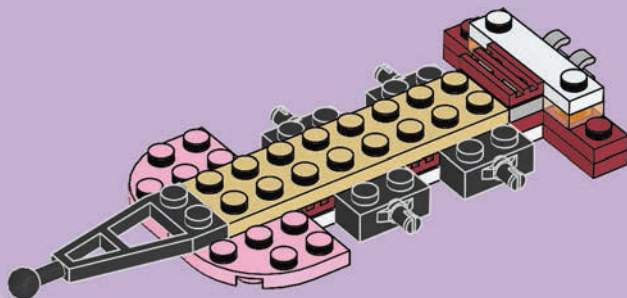

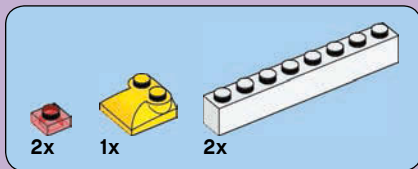

10

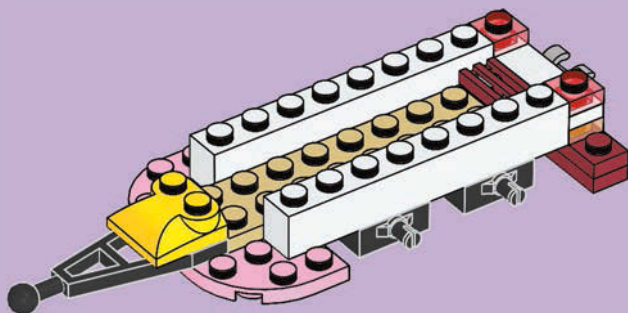



4x



2x

11

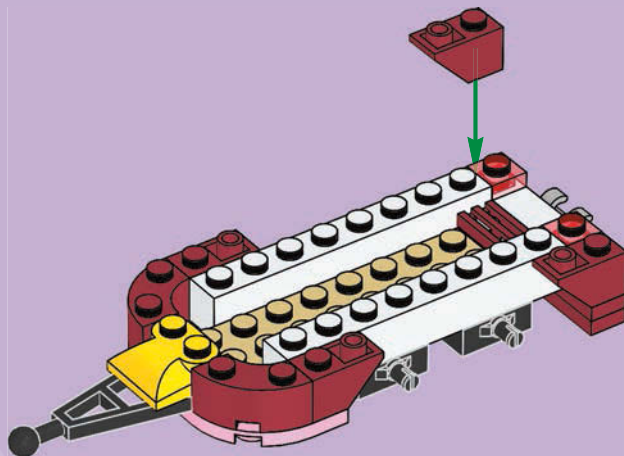

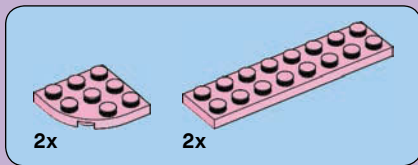

12

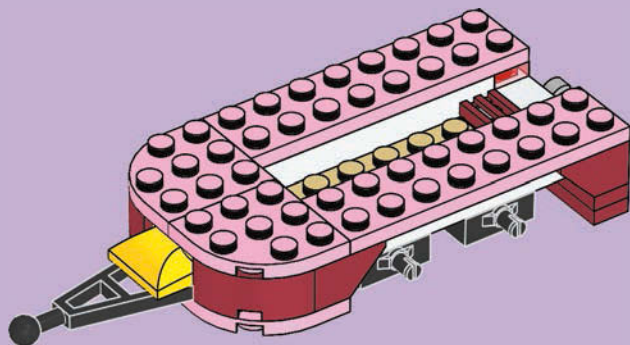

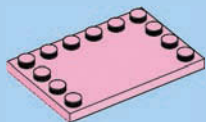

1x

1

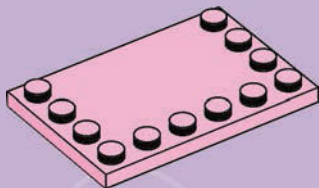

4x



2x

2

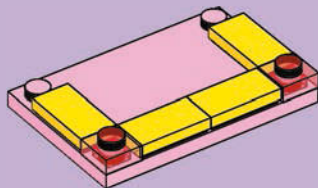



2x

3

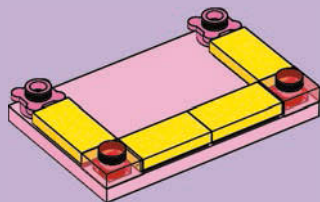

2x

4

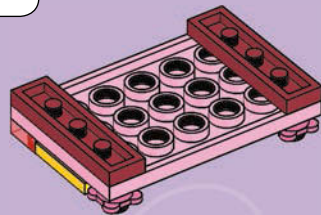
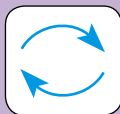

5

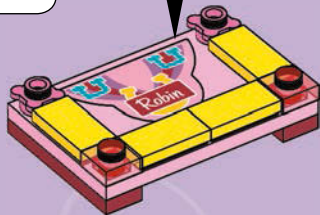
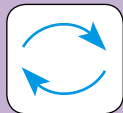

6

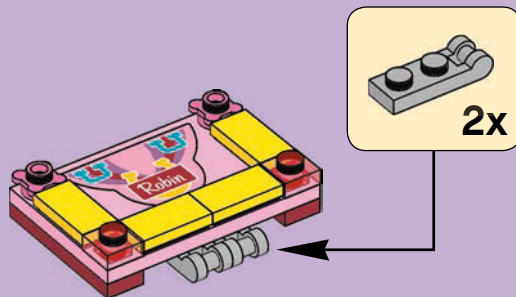

13

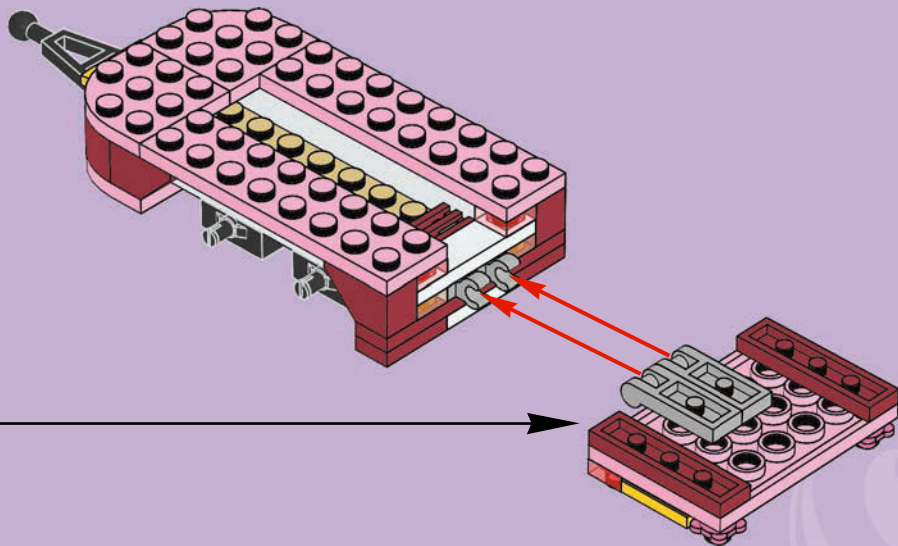

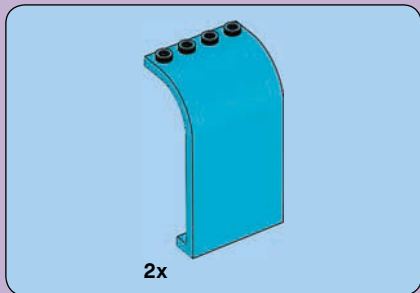

14

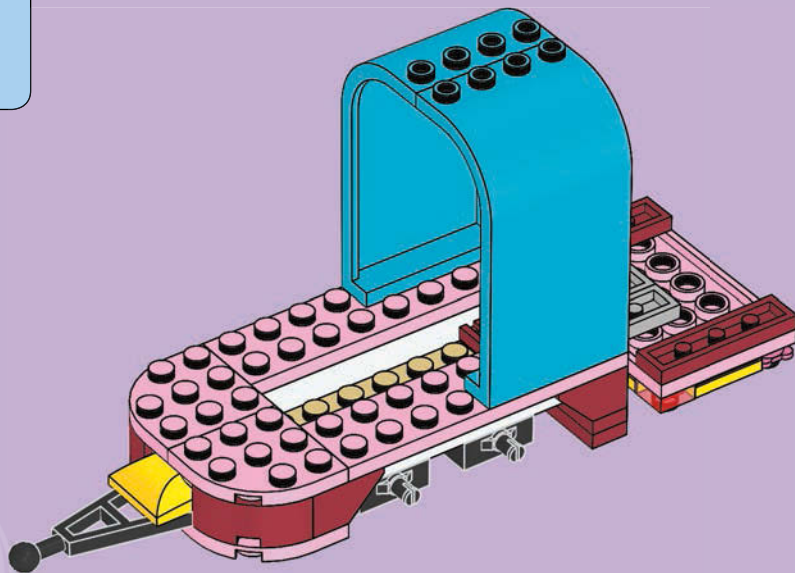

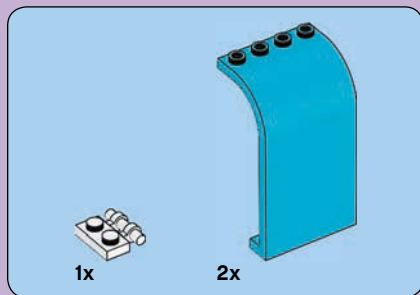

15

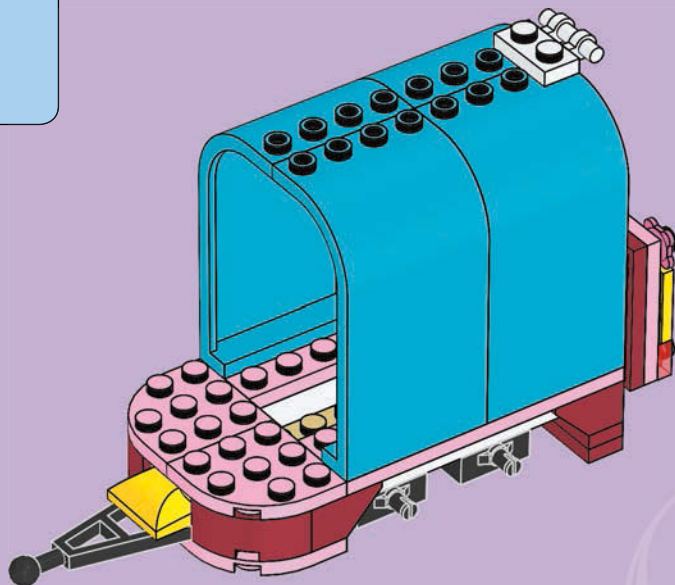

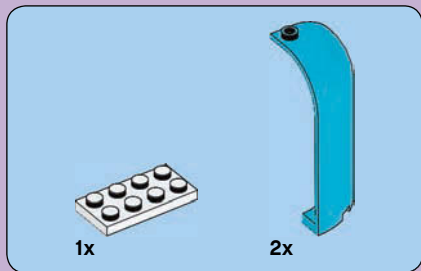

16

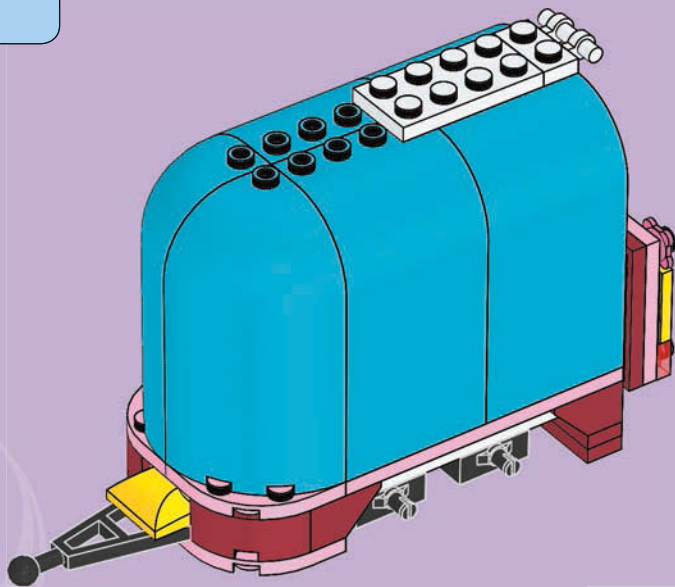

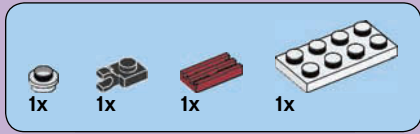

17

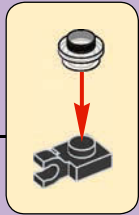
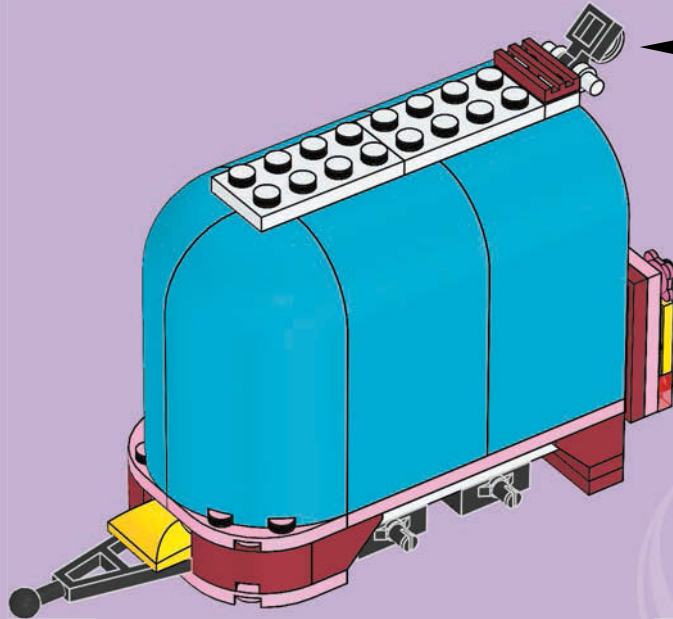

18

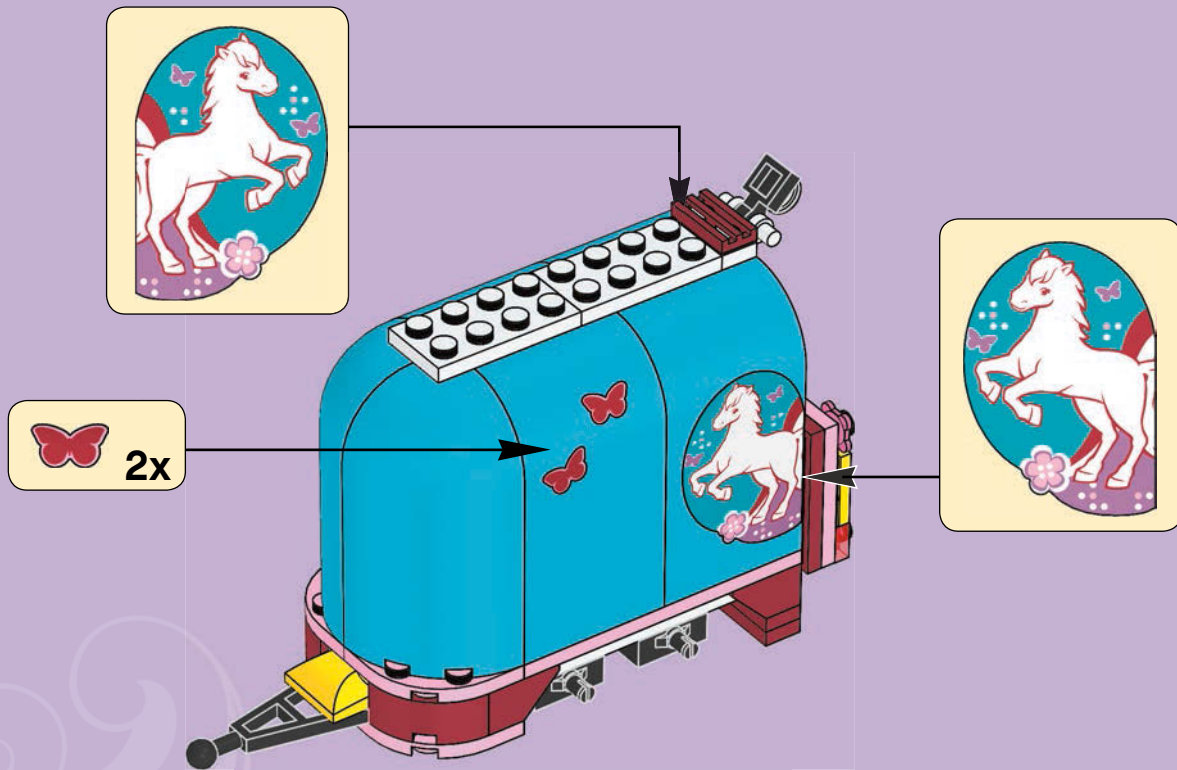

19

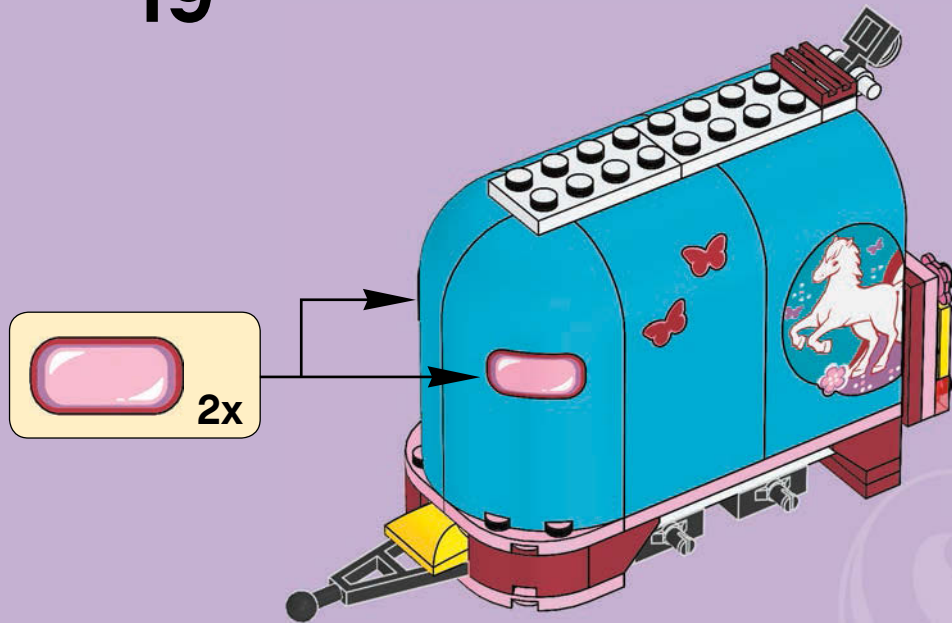



4x



4x

20

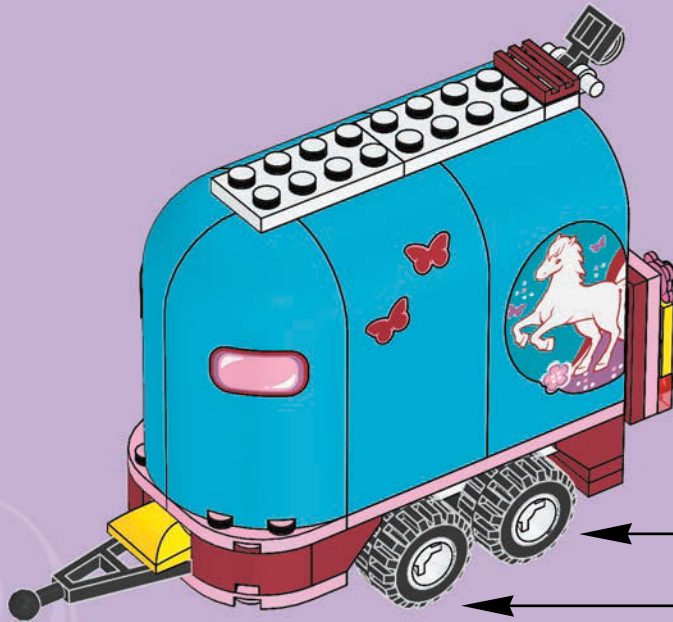

4x

21

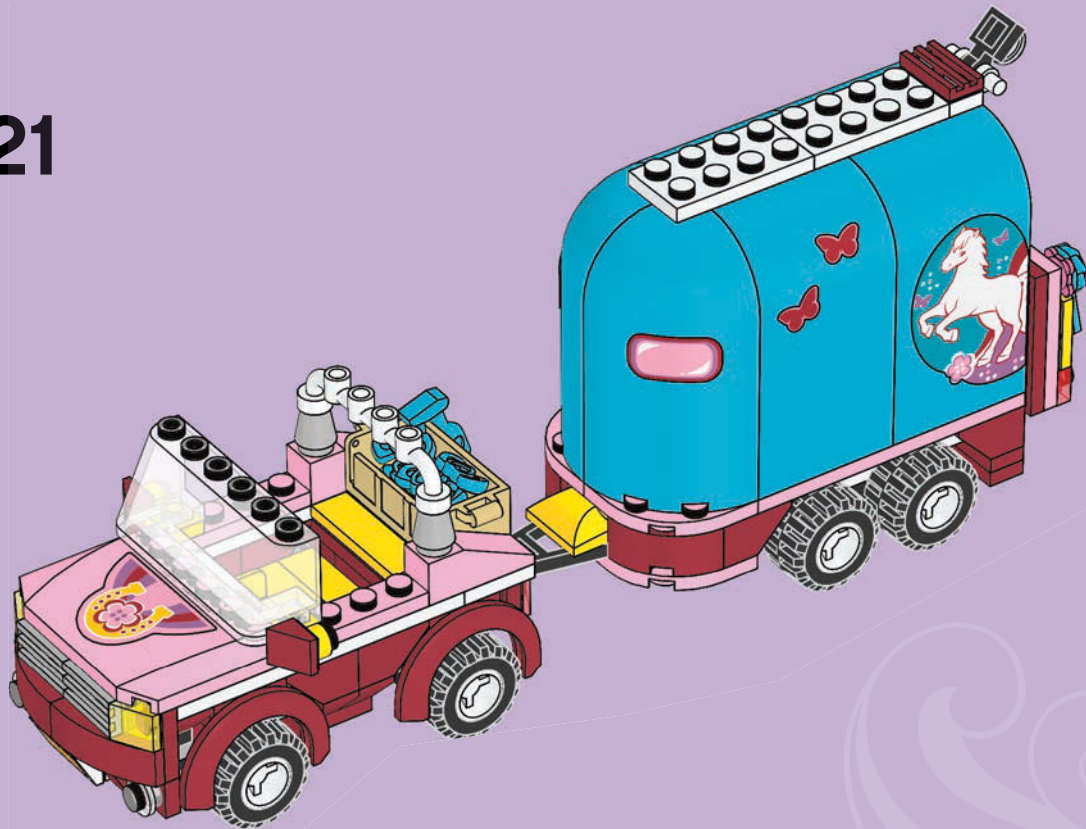

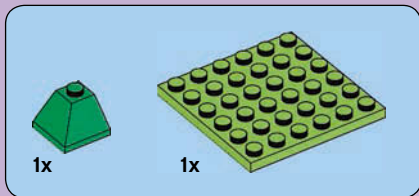

1

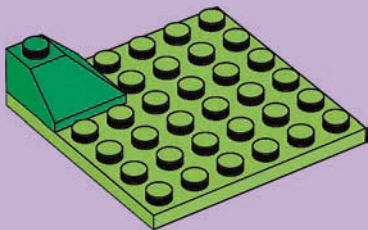

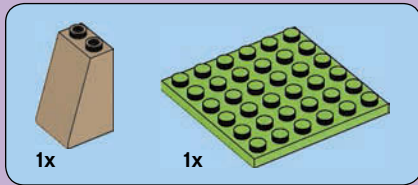

2

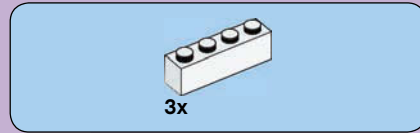
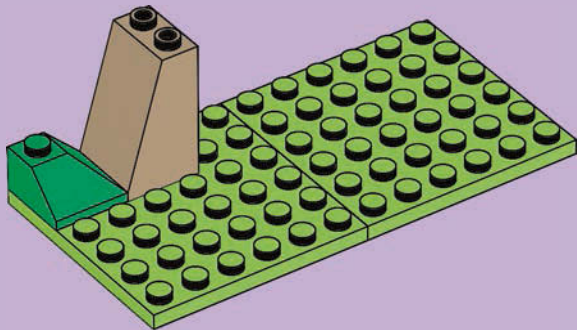

3

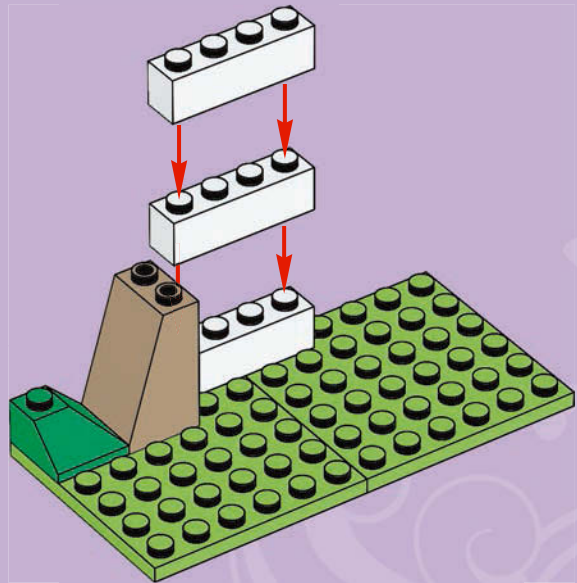



1x

4



2x



1x

5

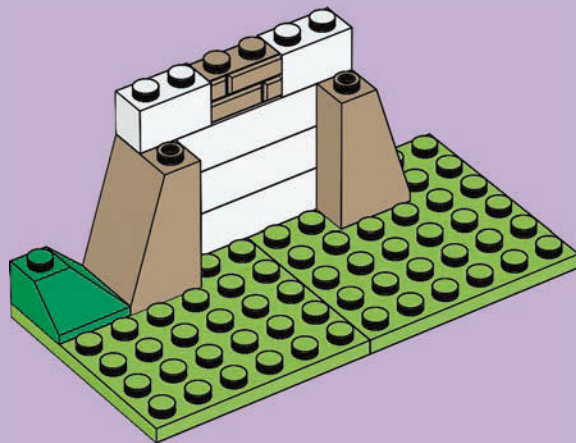

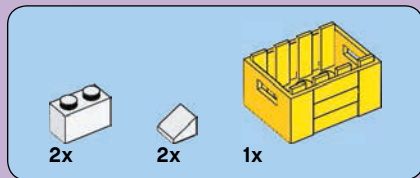

6

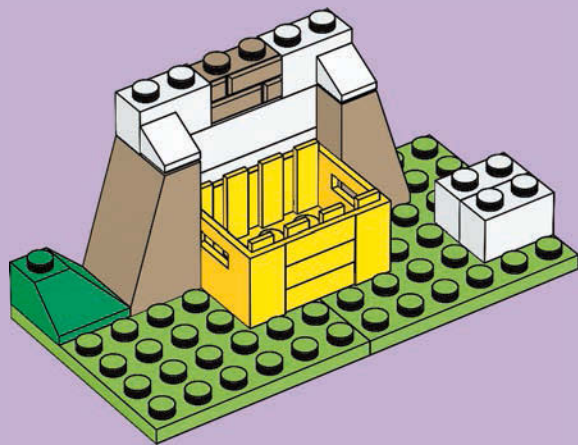

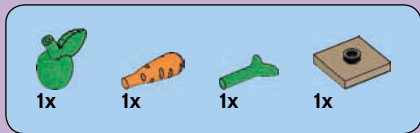

7

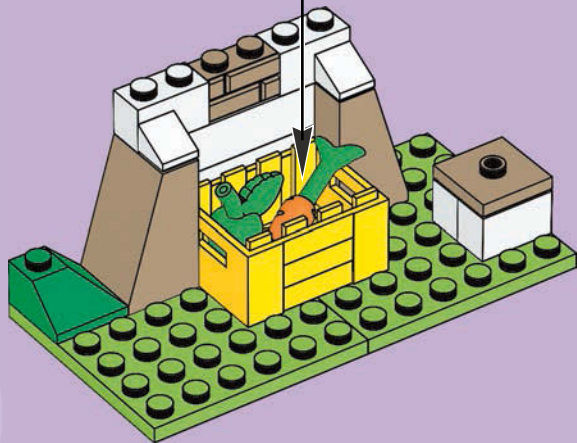
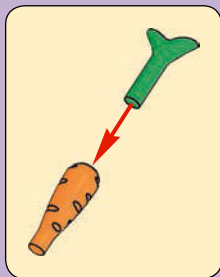



1x



2x



1x

8

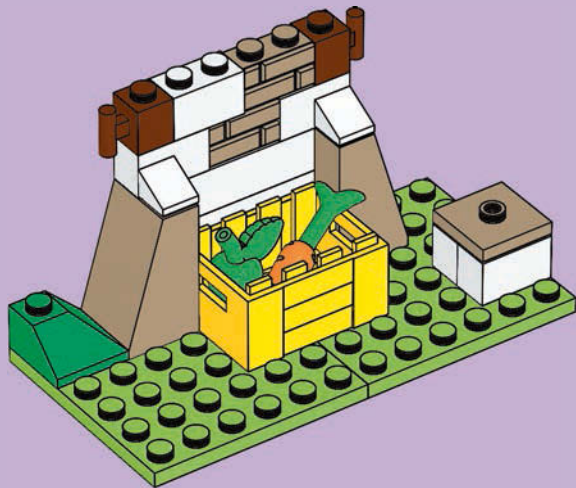



1x



1x

9

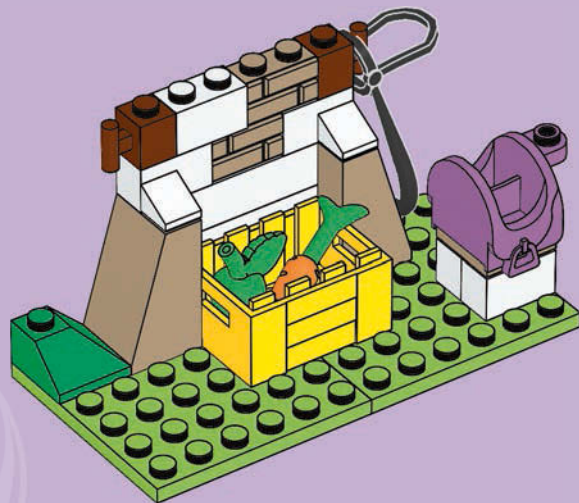



1x



1x

10

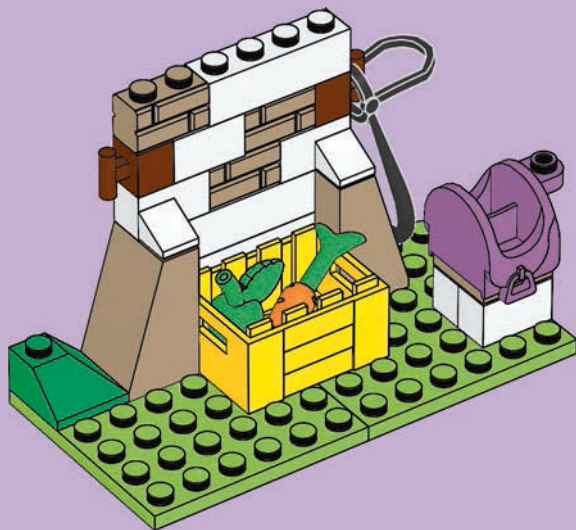

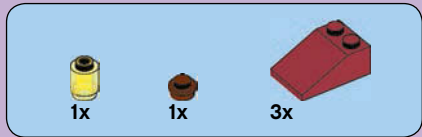

11

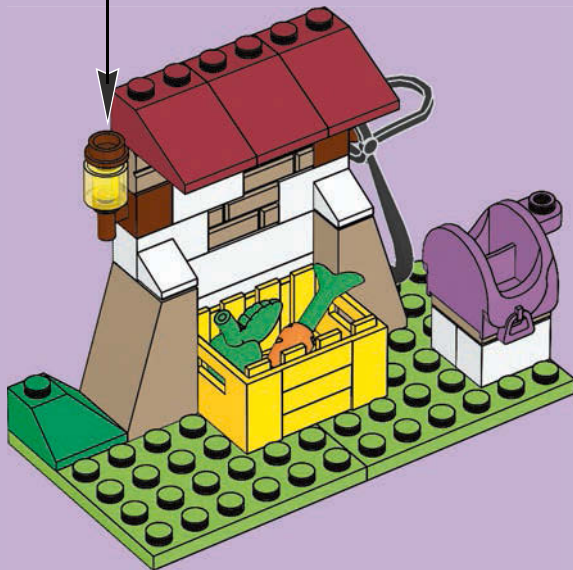

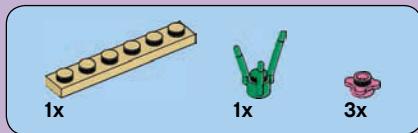

12

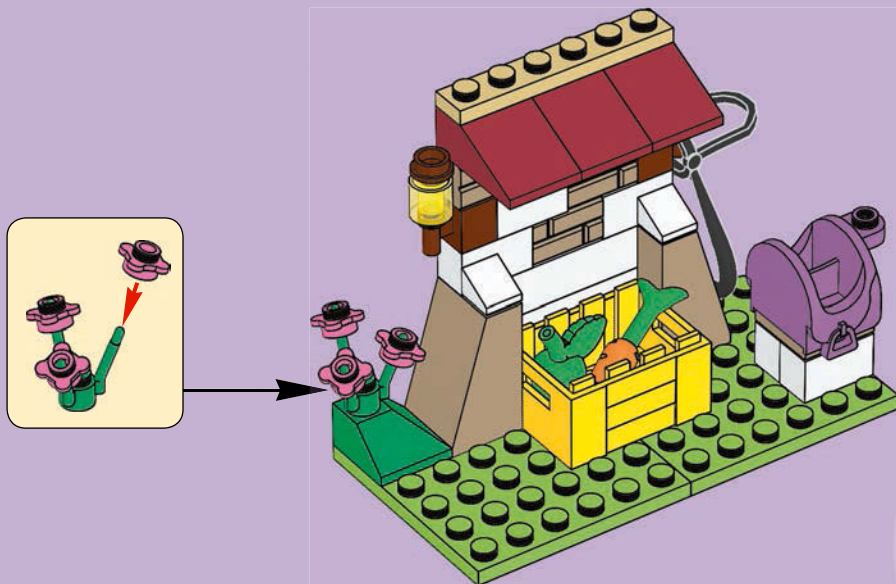

1

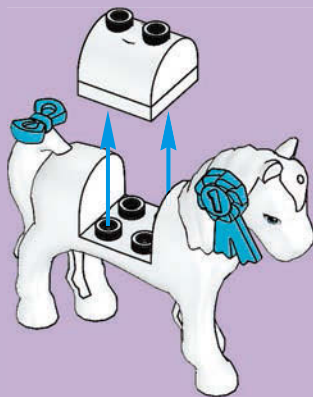

2



3

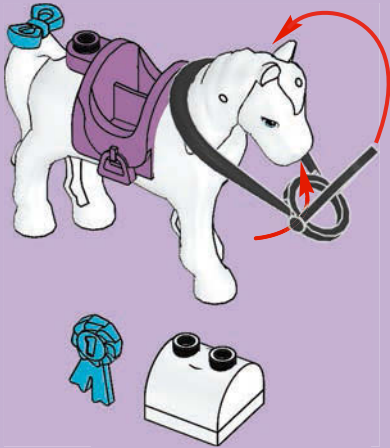

4



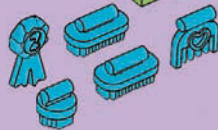
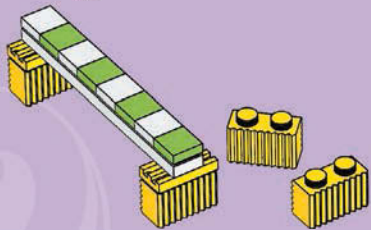
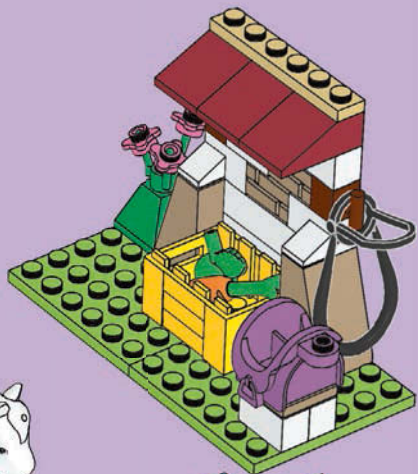
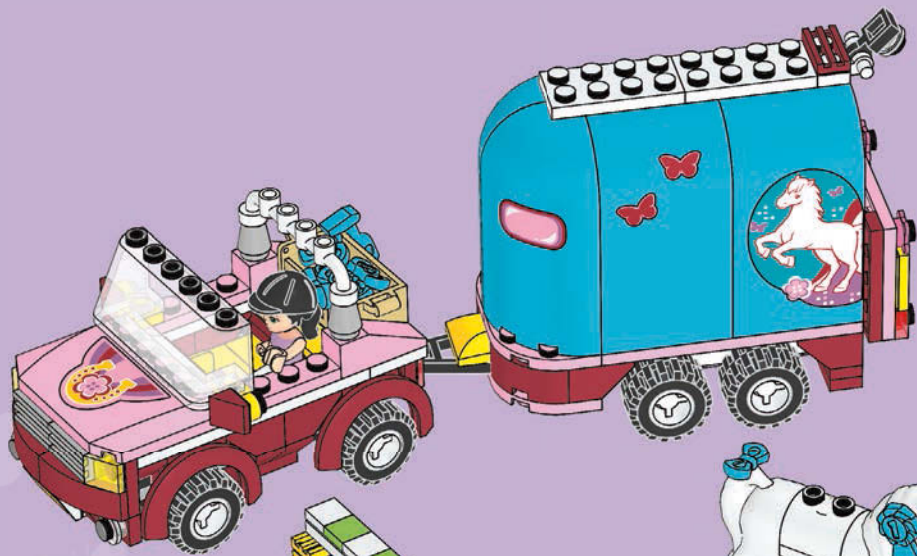



5x
300401



4x
301001

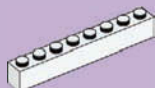

2x
300801



2x
4504369



2x
4547489



2x
302201



1x
4597131



2x
302001



1x
379501



3x
346001



1x
383201



4x
307001



1x
4140583



1x
243101



1x
4288961



1x
4623219



8x
4170457



1x
4622821



1x
4624989



4x
287724



1x
4164073



2x
4632569



5x
241224



4x
306924



3x
243124



2x
4621603



1x
4599378



1x
9553



1x
4218699



1x
4517925



1x
4274405



1x
6014568



1x
4599734



8x
4568644



8x
448826



5x
371026



3x
3005740



1x
4502193



2x
4244363



4x
3000841



1x
4119478



1x
4514396



1x
374128



3x
4646577



1x
4578032



2x
6000852



4x
4537251

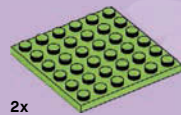

2x
4525858



1x
3006844



2x
4260942



1x
4539104



2x
4625551



4x
4531415



8x
4590811



3x
4569379



4x
4541506



3x
4618657



2x
4541546



7x
4539097



2x
4539061



4x
4539062



2x
4618986



4x
4621617



2x
4542673



5x
4216479



2x
4225823



1x
4216581



2x
4529241



2x
4243797



1x
4211406



2x
4211350



2x
4535738



2x
4515369



1x
6014615



1x
4667166



1x
4517993



2x
4621620



2x
6002148



1x
4625545

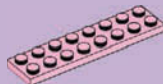

2x
4625550



4x
4620318



1x
4618656



1x
6011444



1x
4612388



1x
4119479



1x
4107050



1x
4124067

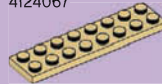

1x
4113988



1x
4618652



1x
6002630



2x
4625546



4x
4625548

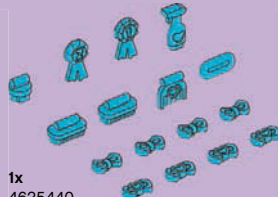

1x
4625440



Customer Service

Kundenservice

Service Consommateurs

Servicio Al Consumidor

www.lego.com/service or dial



00800 5346 5555 :

1-800-422-5346 :



Heartlake City



LEGO Friends



3934



3187



3183



3936



3935



3942



3186



3063



3065



3061



3184



3932



3937



3938



3939



3933



3183



3189



3315

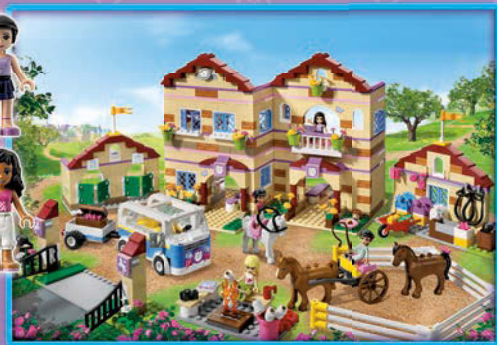

3185

LEGO

Friends



LEGOFriends.com



1



www.LEGOclub.com/Nina

2



3



www.LEGOclub.com/Nina



club™

FREE*! GRATIS! GRATUIT!



*Paid subscription in Australia and New Zealand.
*Abonnement payant en Australie et Nouvelle-Zélande.



Win!

Go to www.LEGOsurvey.com/product to fill out a survey for a chance to win a cool LEGO® Product.
No purchase necessary.
Open to all residents where not prohibited.



www.LEGOsurvey.com/product

Gewinne! Win!

Nimm an der Umfrage auf www.LEGOsurvey.com/product teil und hab die Chance ein cooles LEGO® Produkt zu gewinnen!

Die Teilnahme am Gewinnspiel führt zu keinerlei Kaufverpflichtungen. Teilnahme in allen nicht ausgeschlossenen Ländern möglich.

LEGO and the LEGO logo are trademarks of the/son des marques de commerce de/son marcas registradas de LEGO Group. ©2012 The LEGO Group.

Ga naar www.LEGOsurvey.com/product, vul een enquêteformulier in en maak kans op een cool LEGO® product.

Geen aankoopverplichting. Iedereen mag deelnemen, uitgezonderd ingezetenden van landen waar een enquêteverbod geldt.

Gagne! 当てよう!

Visite www.LEGOsurvey.com/product pour répondre à un questionnaire et avoir une chance de gagner un produit LEGO® très cool!

Aucune obligation d'achat. Ouvert à tous les résidents des pays autorisés.

www.LEGOsurvey.com/product にアクセスして、アンケートにご記入ください。当選者にはレゴ製品を差し上げます。

お買い上げの必要はありません。

禁止されていない限り、すべての皆様にご利用いただけます。

6014461 / 6014462



www.LEGO.com