



Friends



41037



1



2



3



4



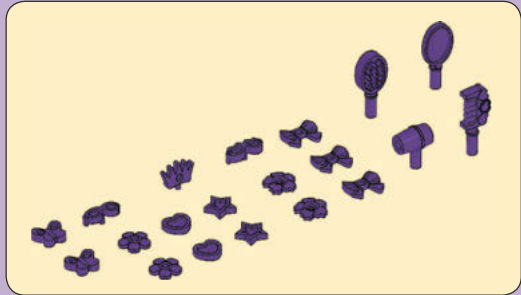
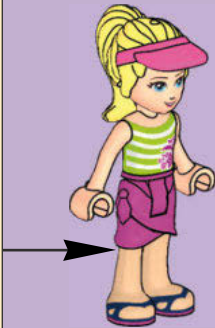
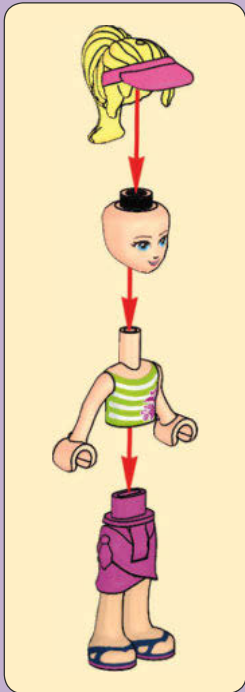
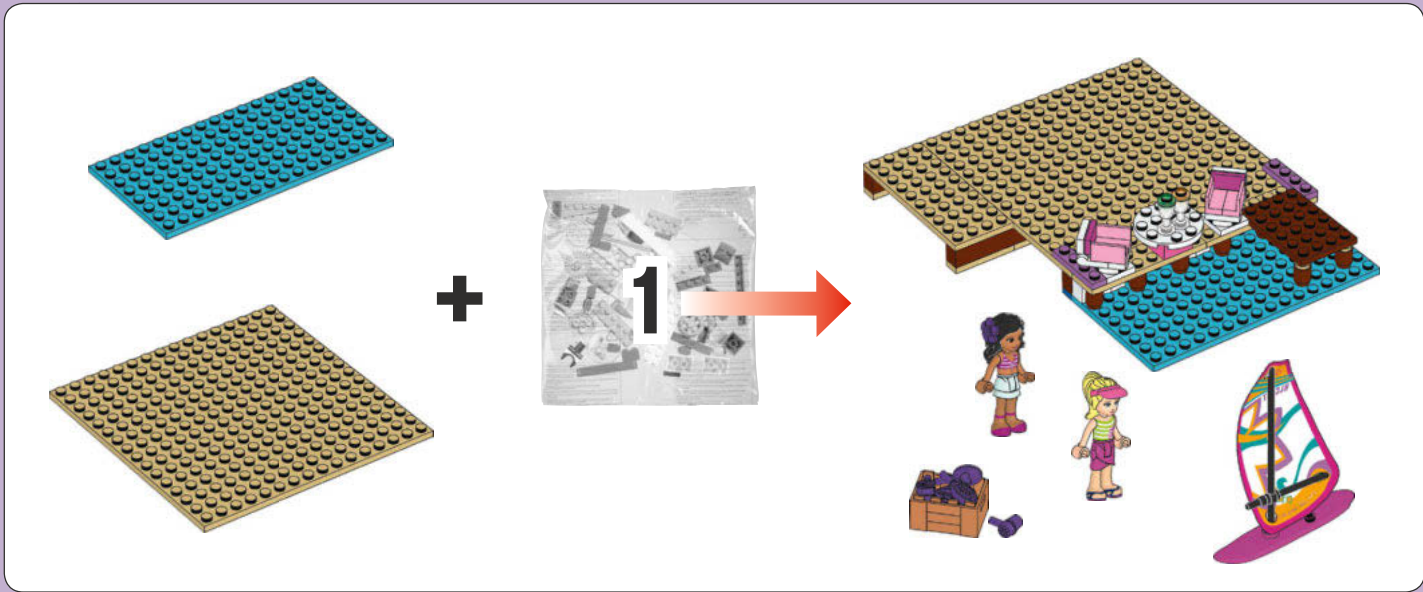

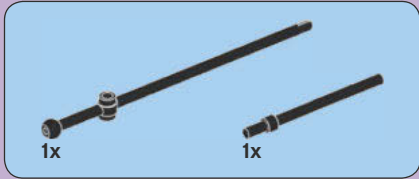

1

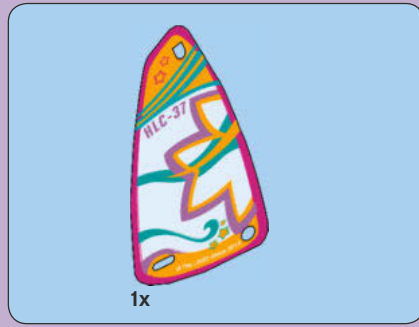
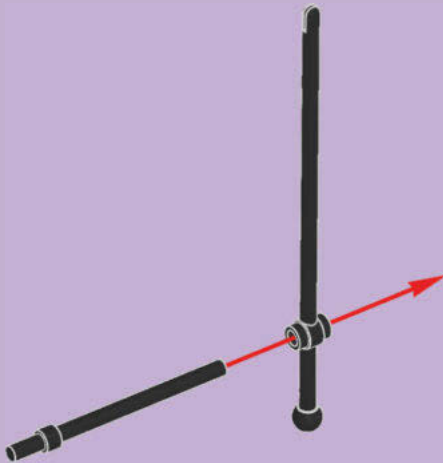

2



3



4



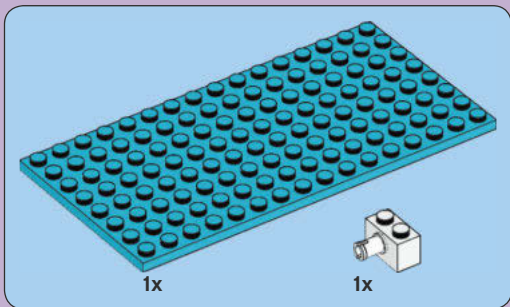
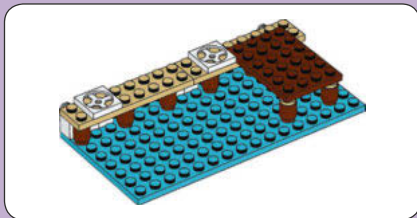
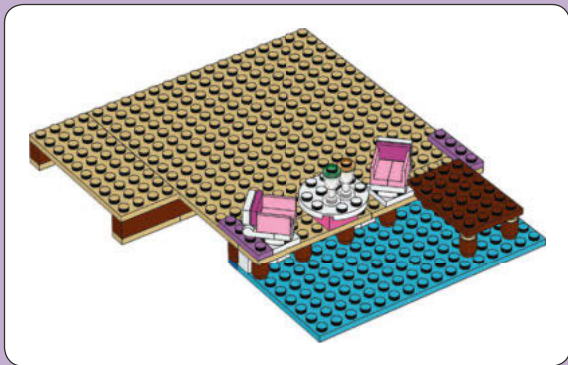

1

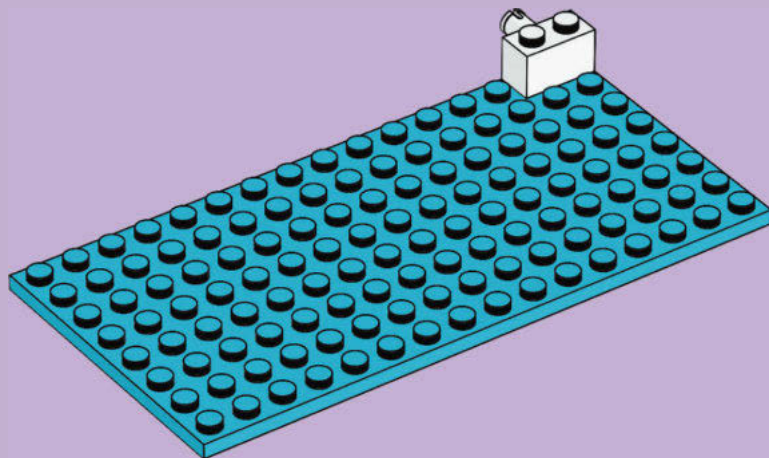

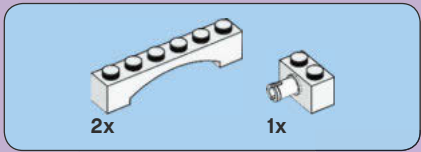

2

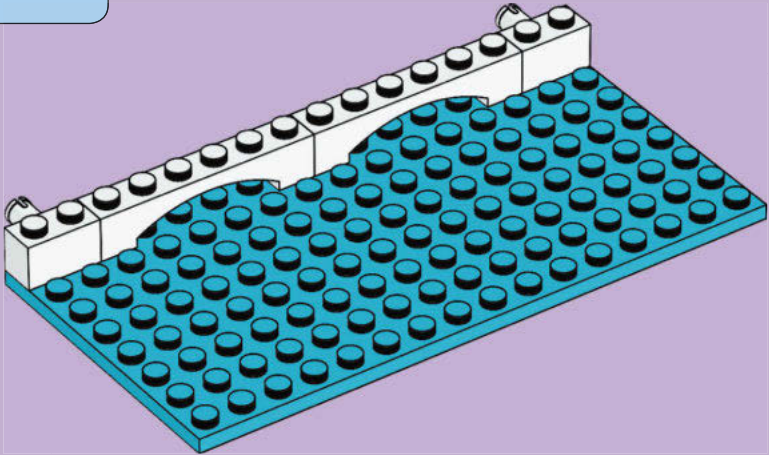

3

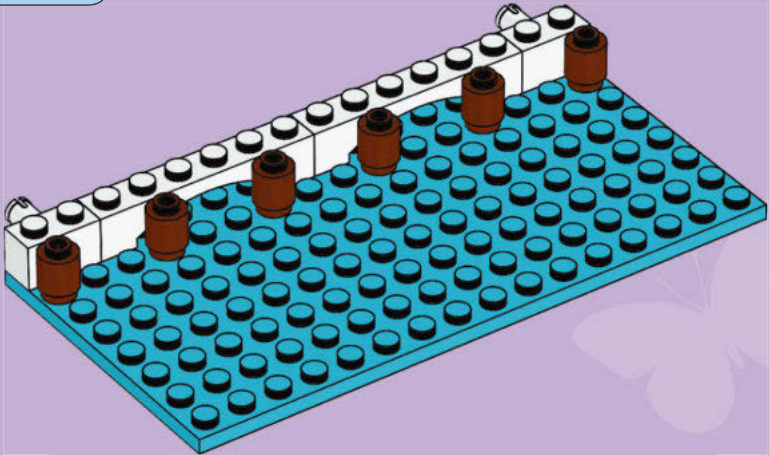

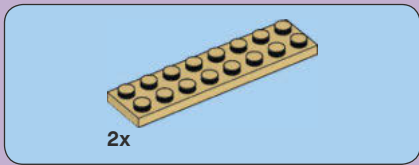

4

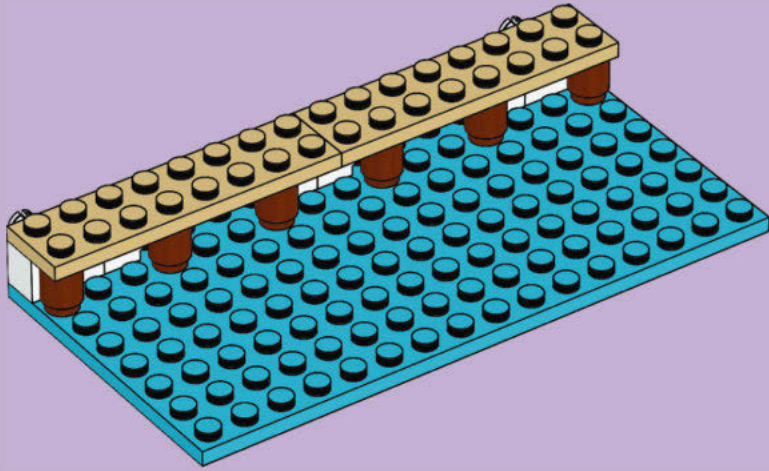

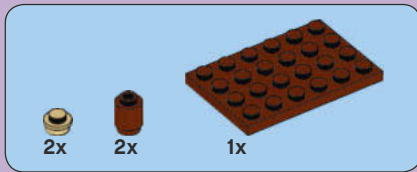

5

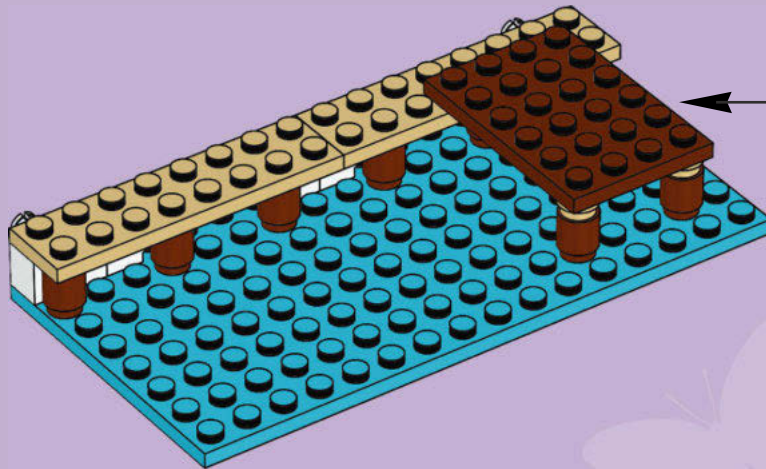
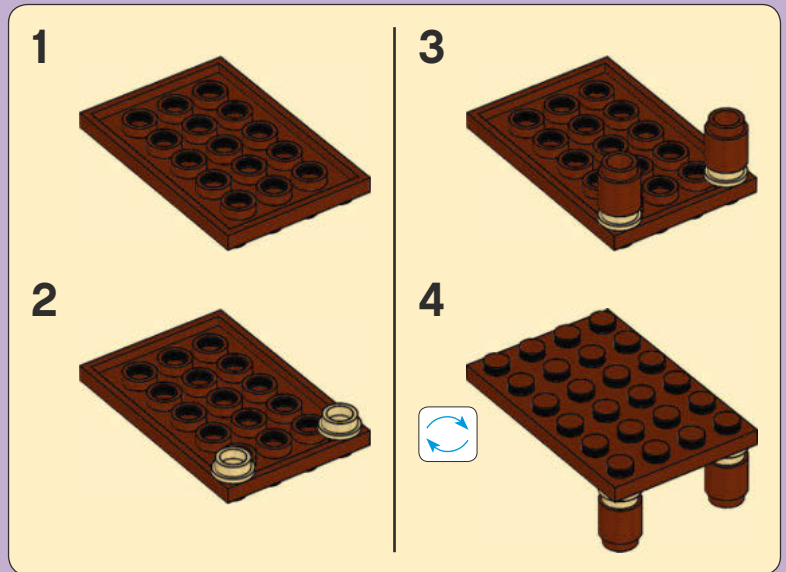

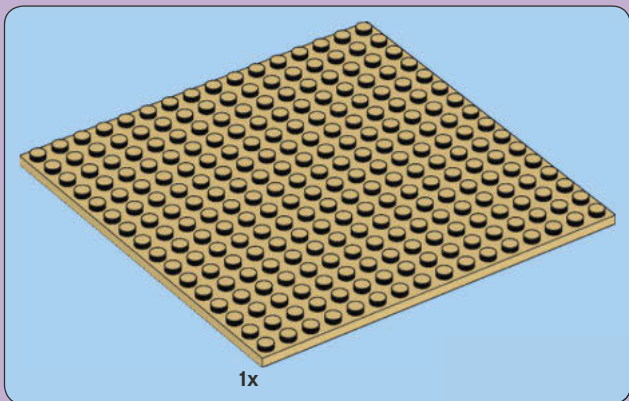
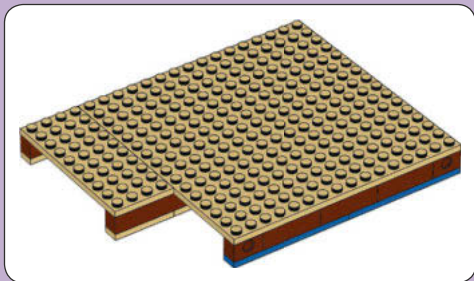

6

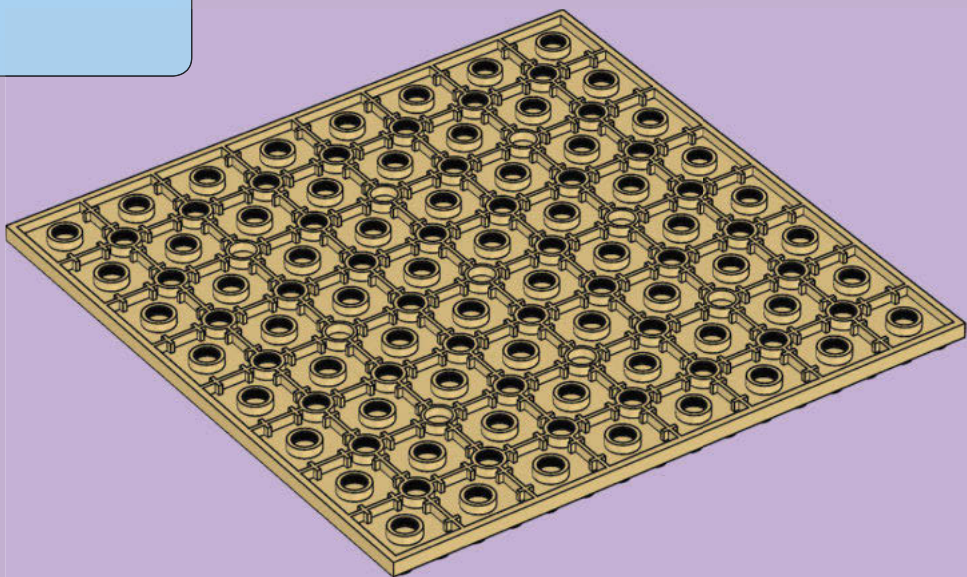

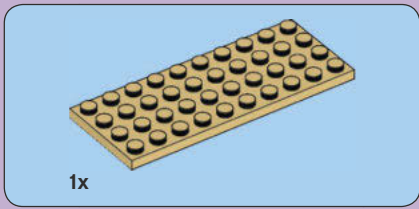

7

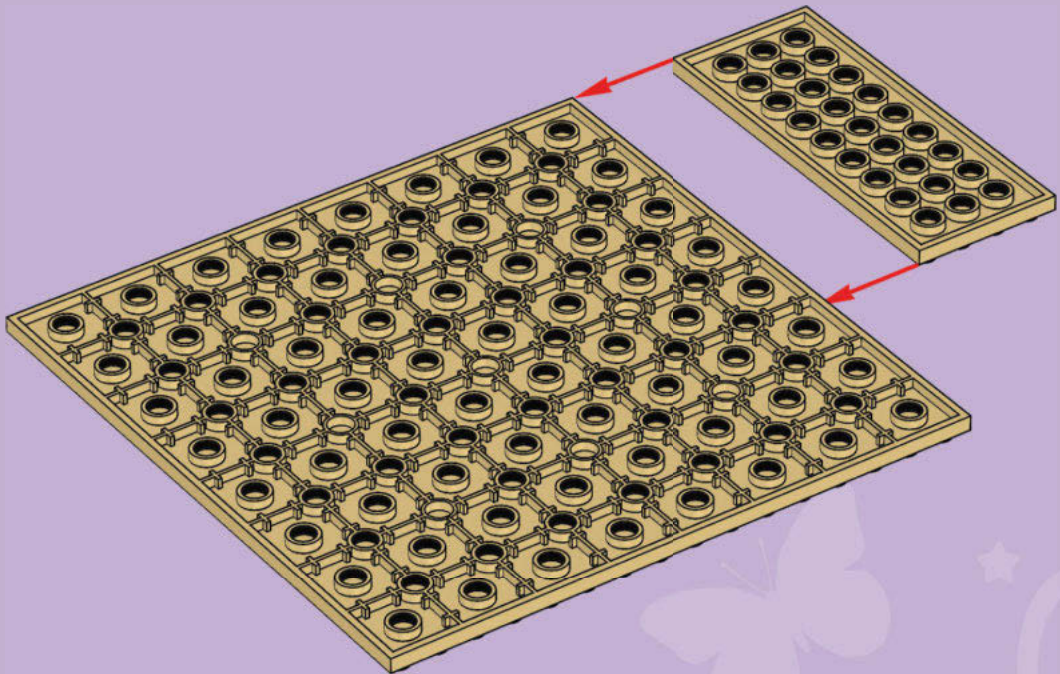



2x

8

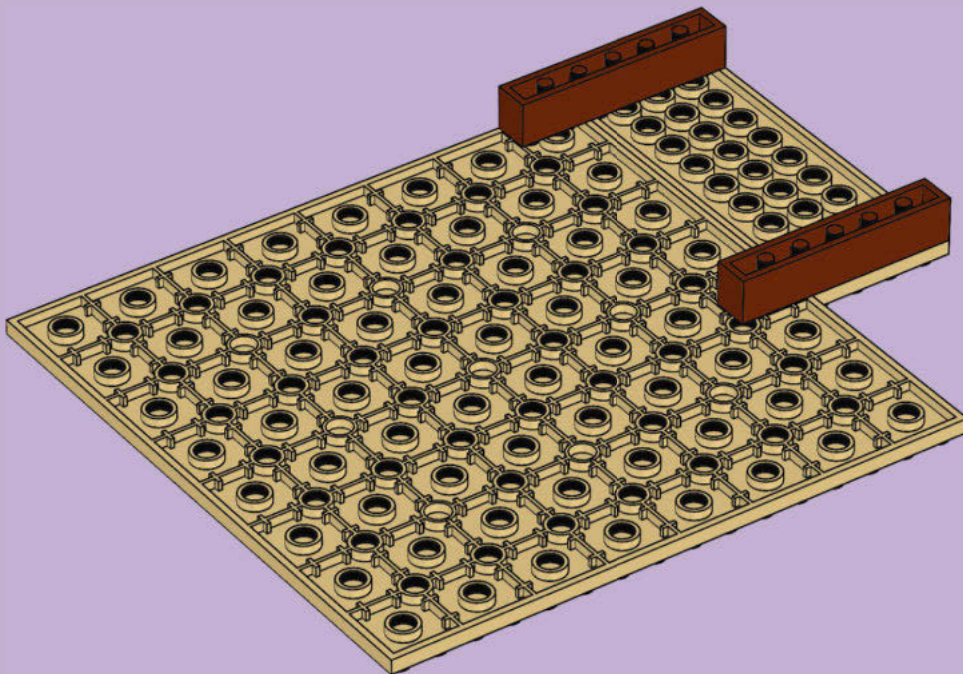

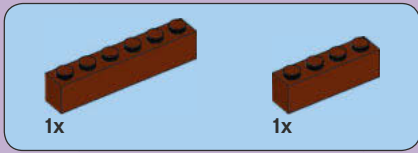

9

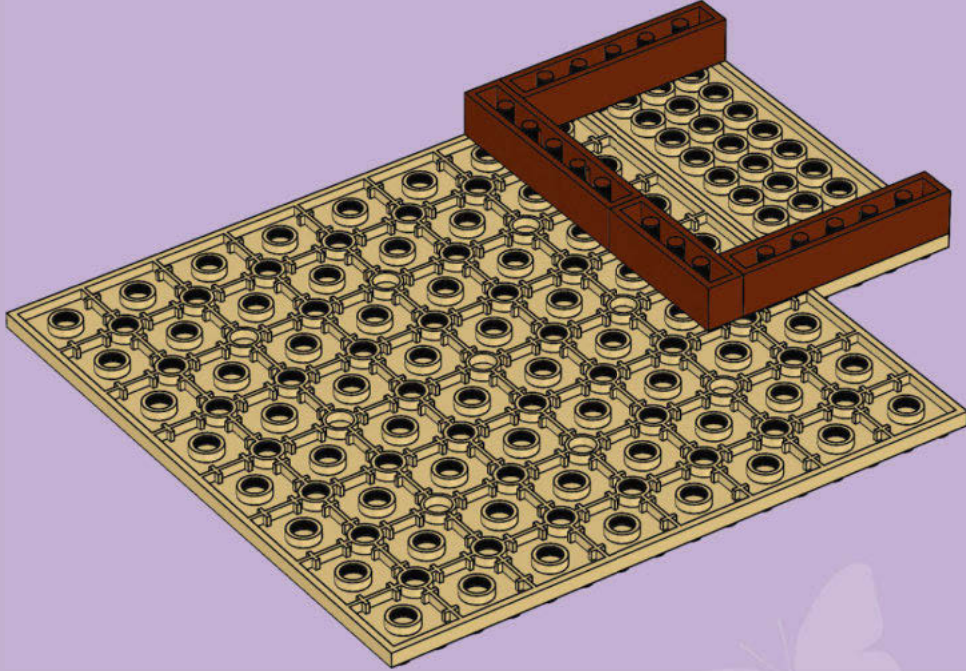

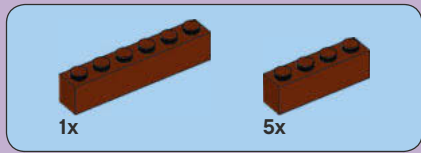

10

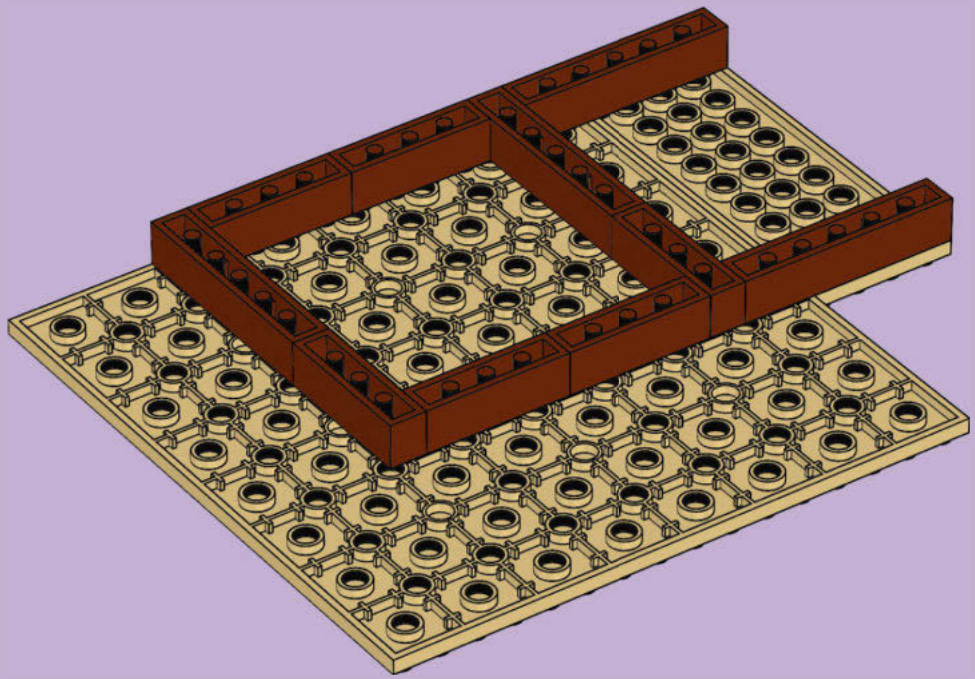



2x

11

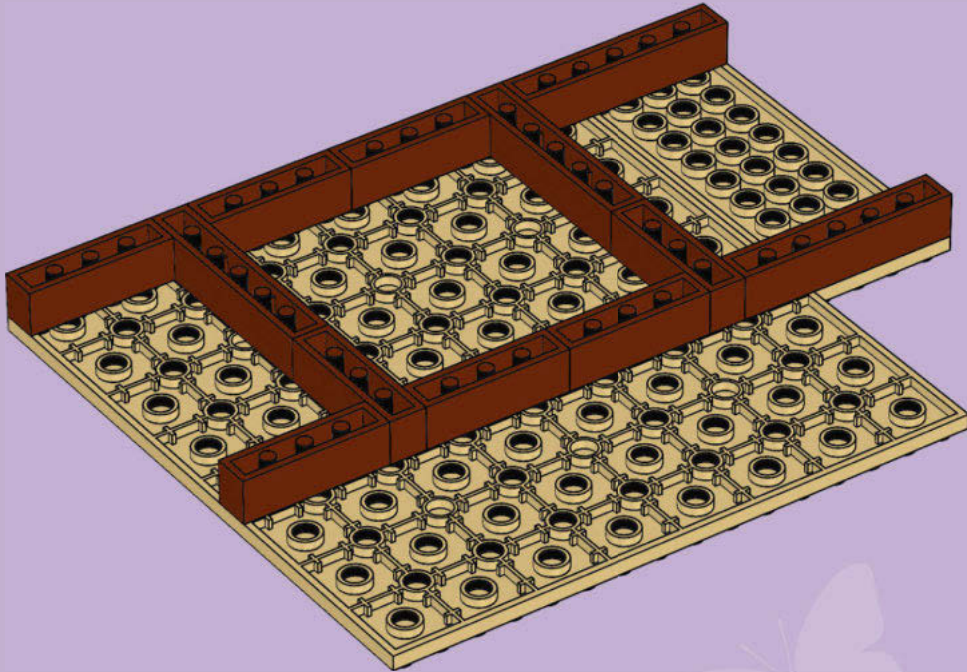

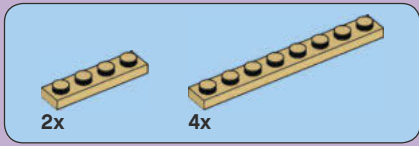

12

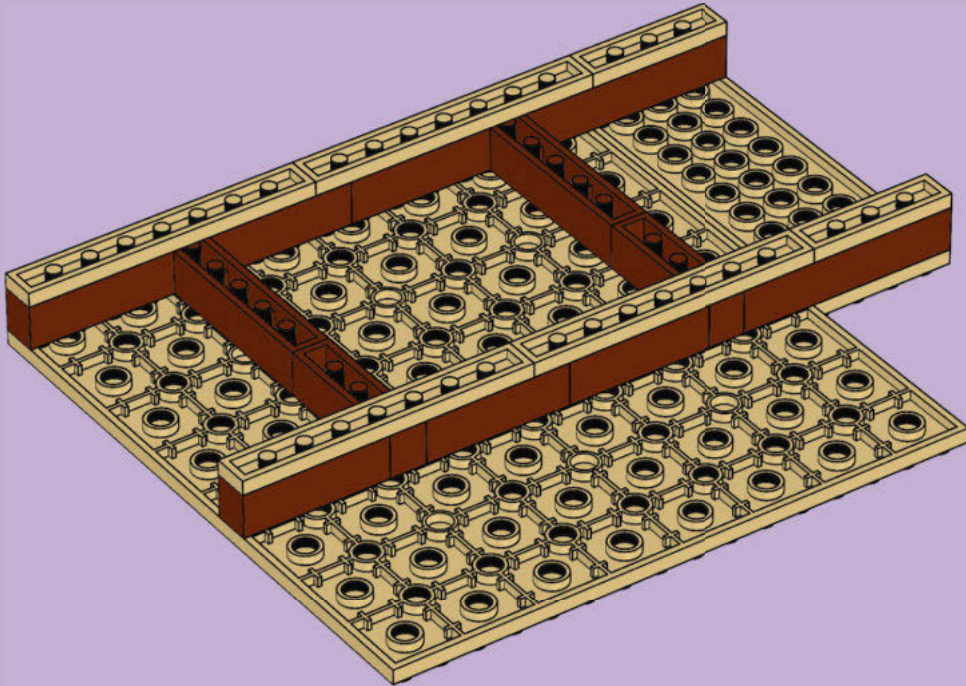

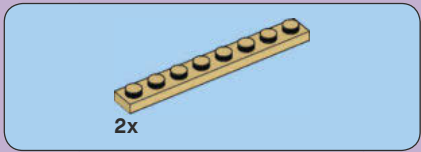

13



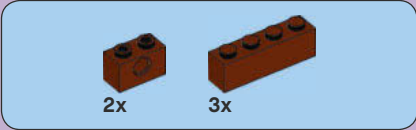

14

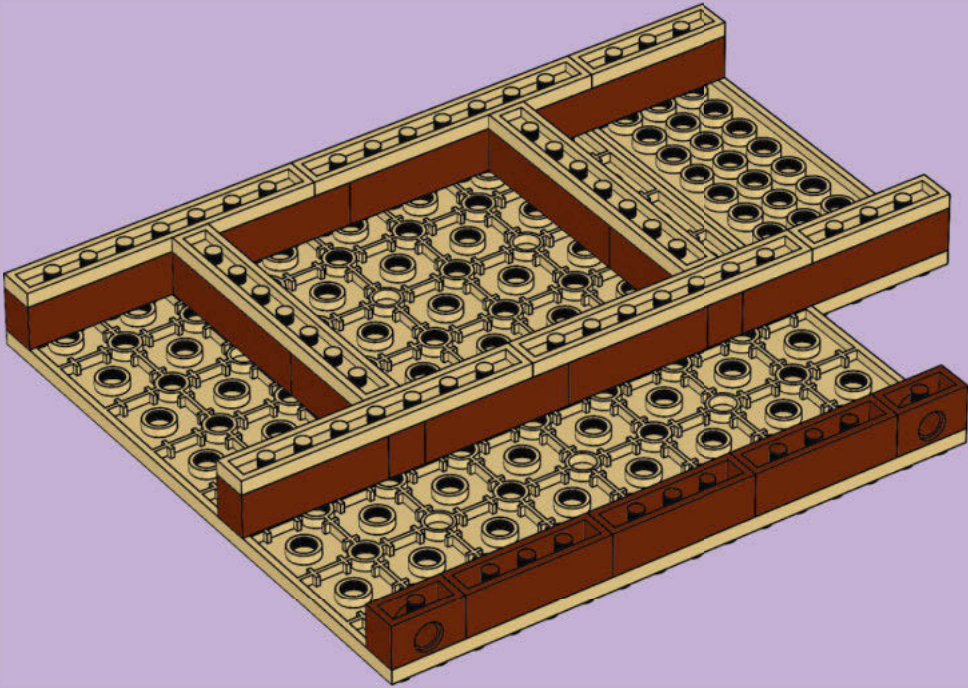

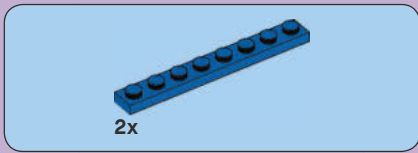

15

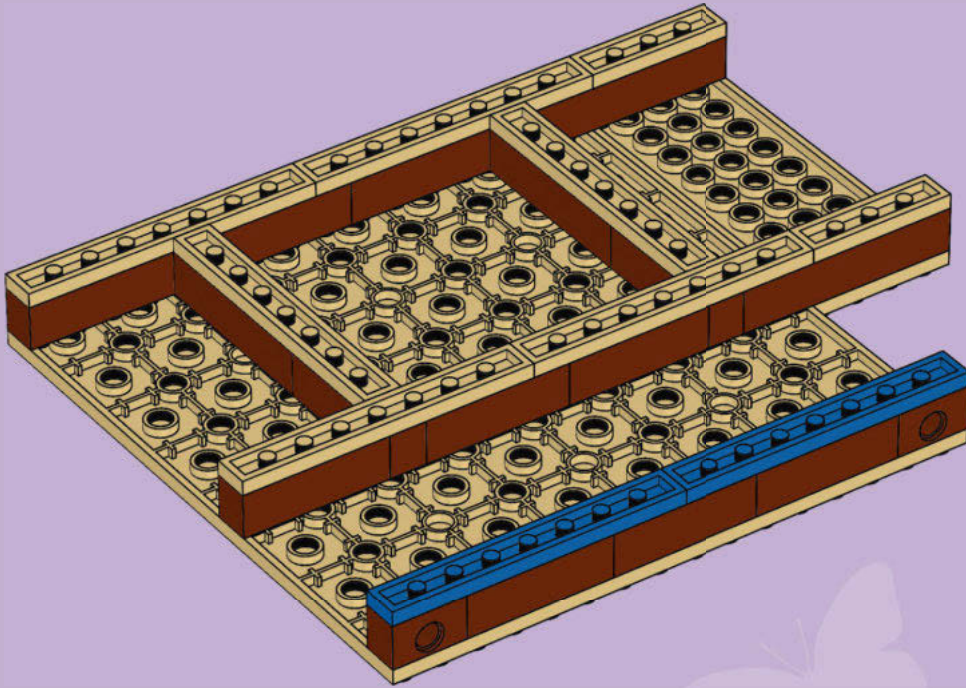

16

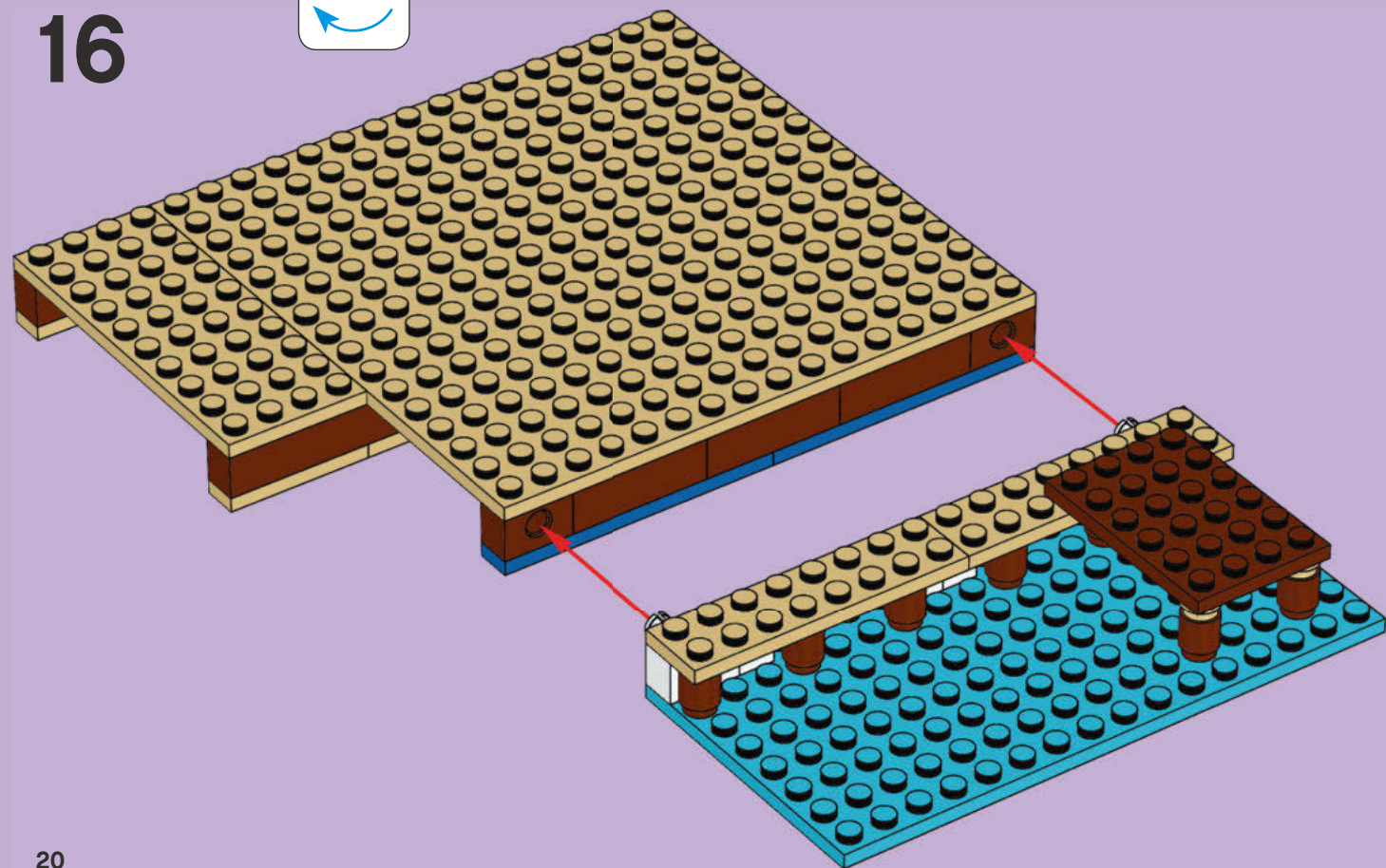
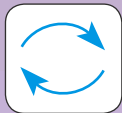



2x



2x

17

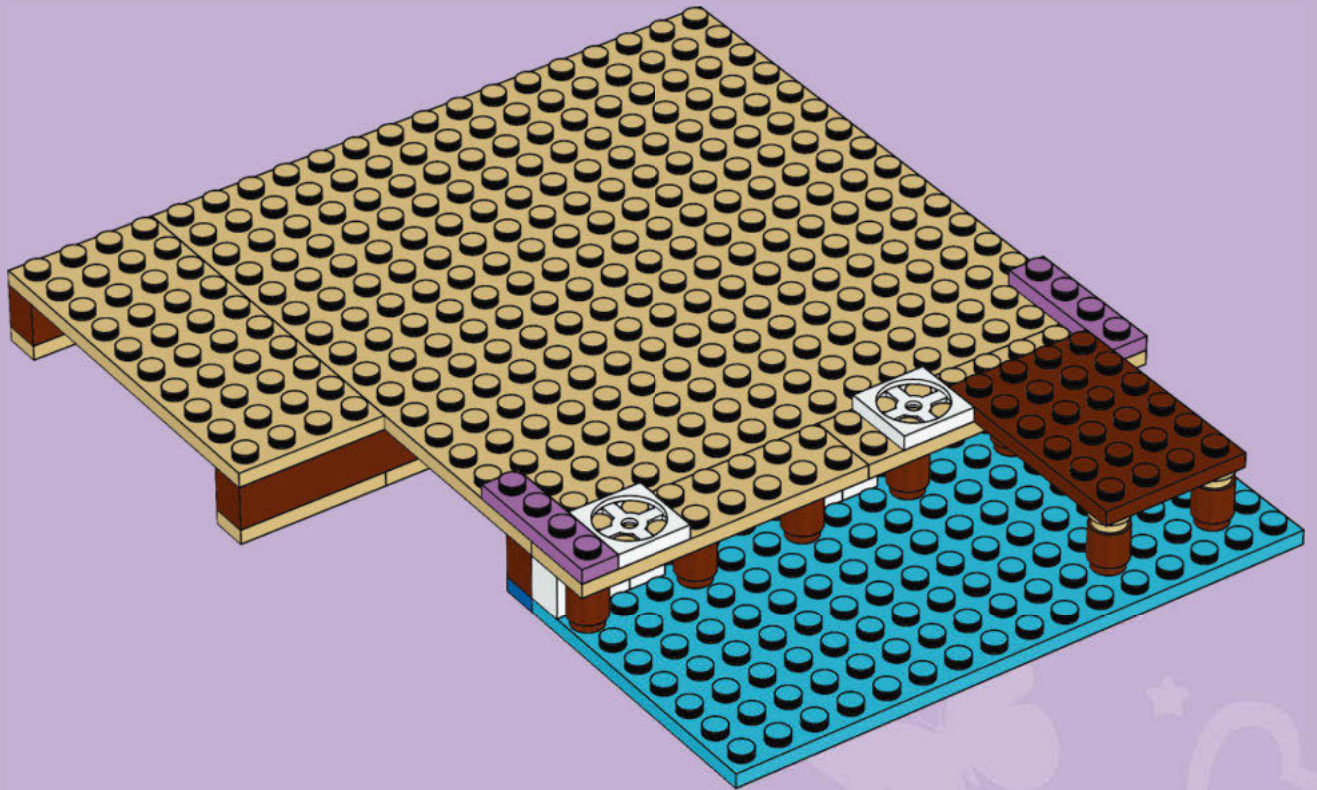

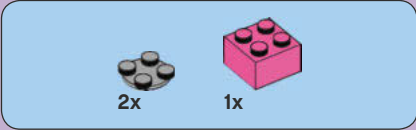

18

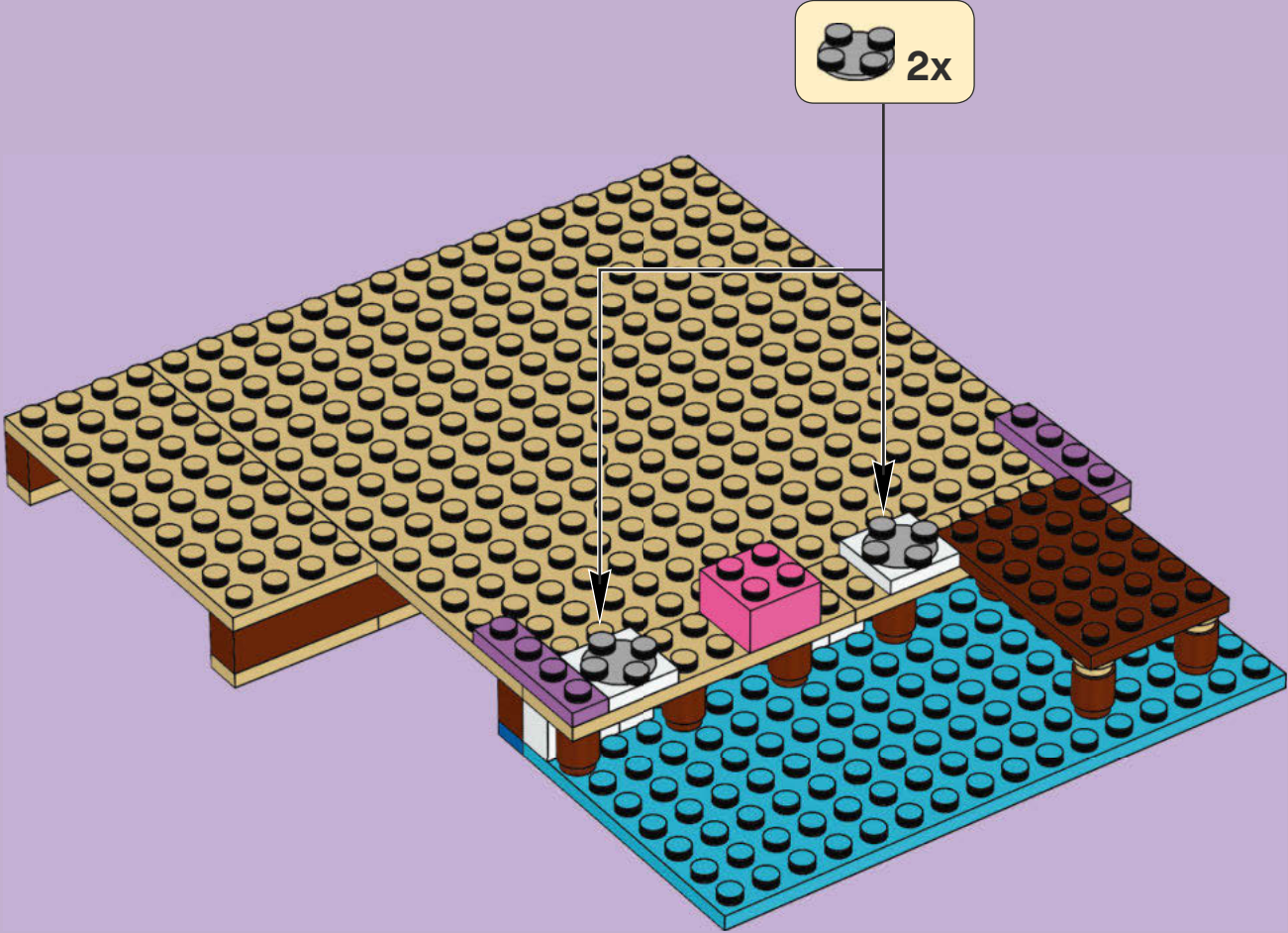



1x

19

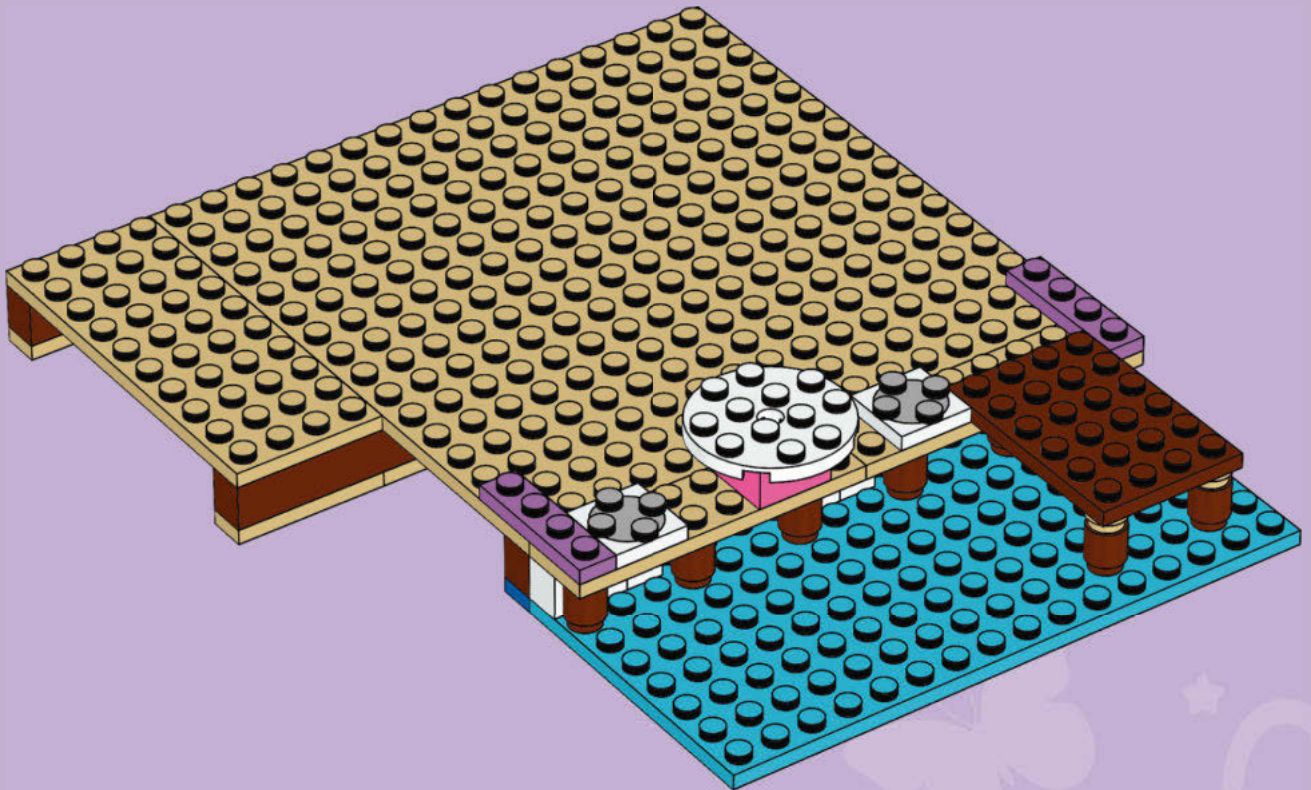

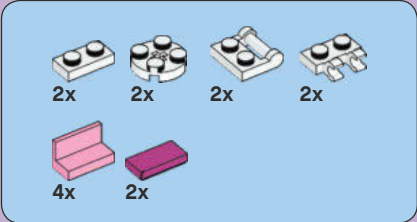

20

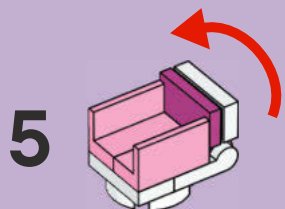
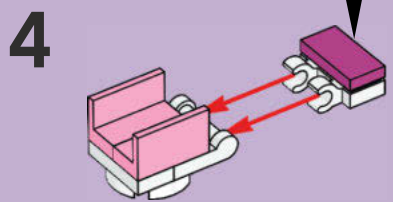
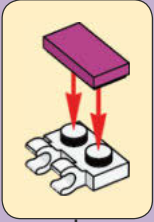
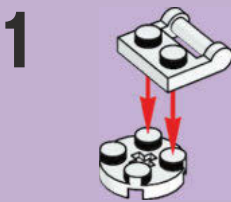

2x

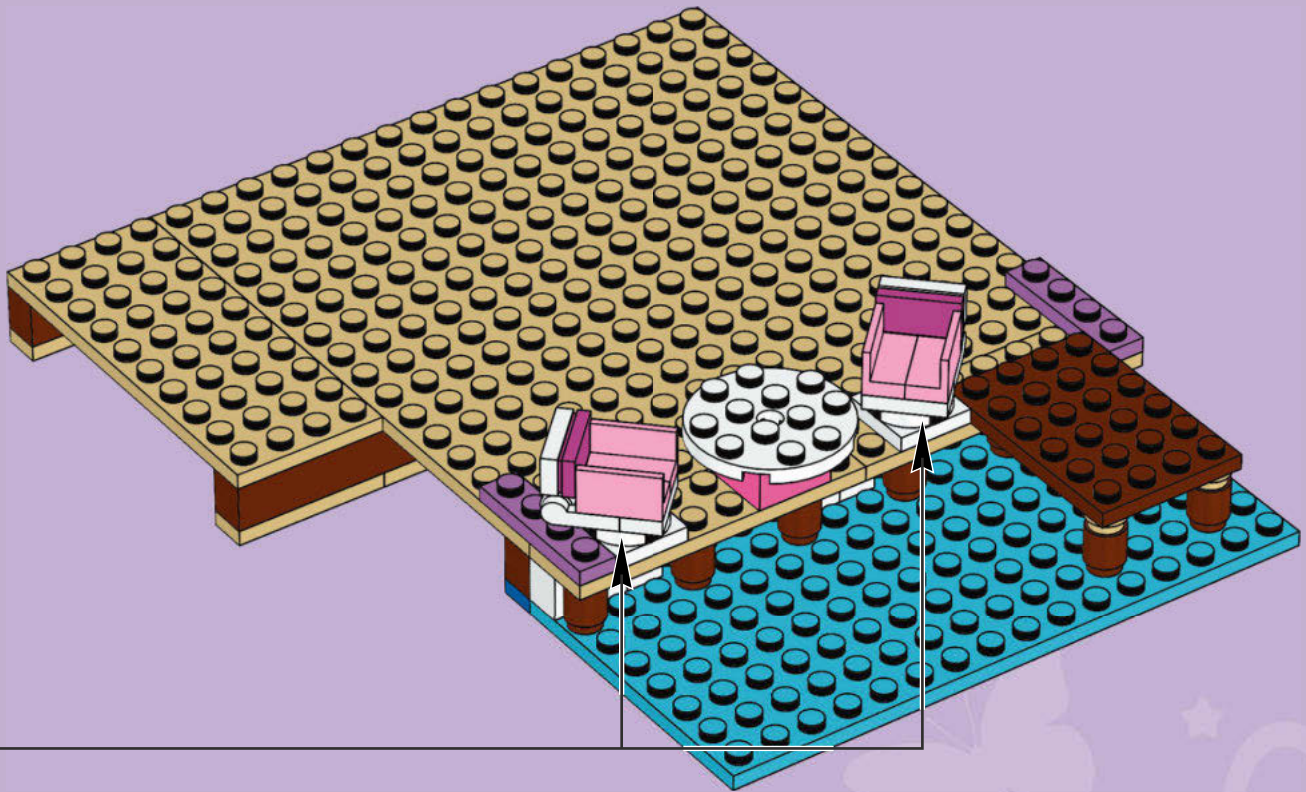



21

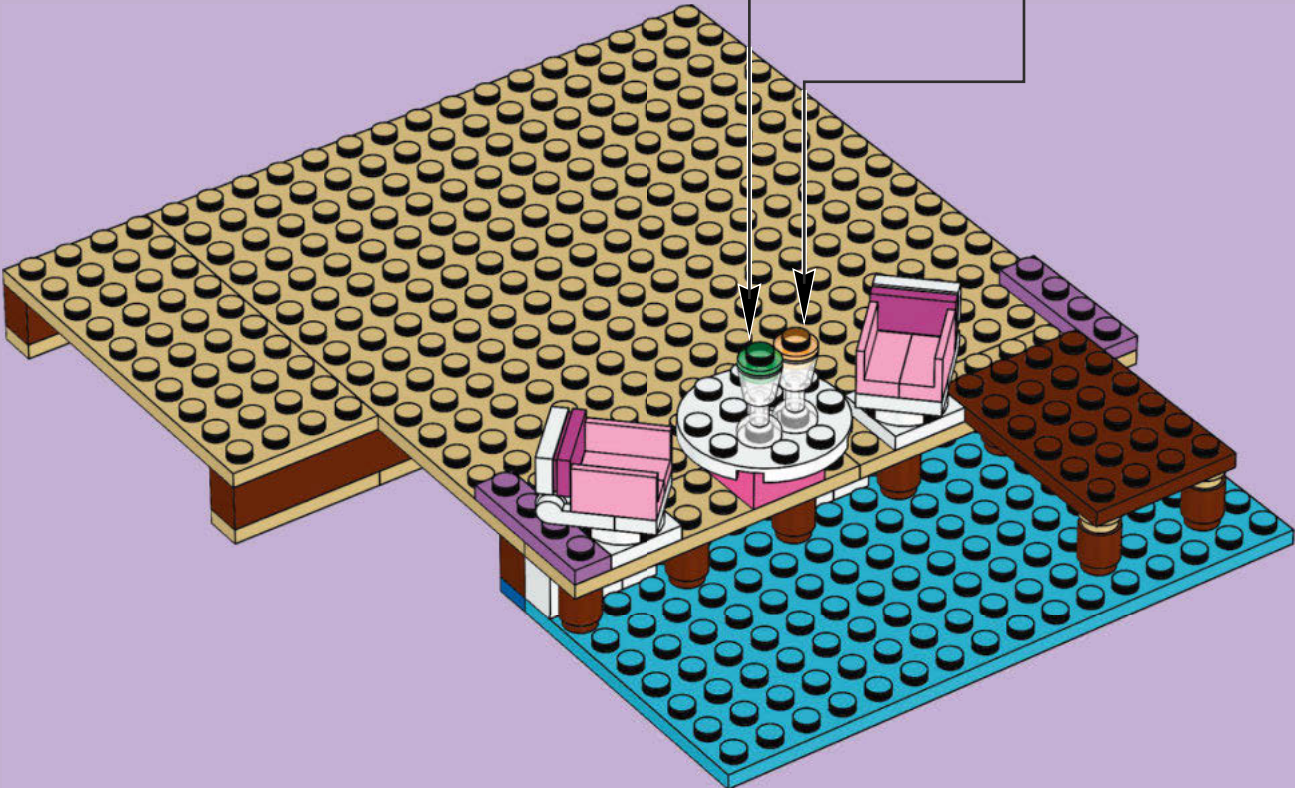



2



3x

22



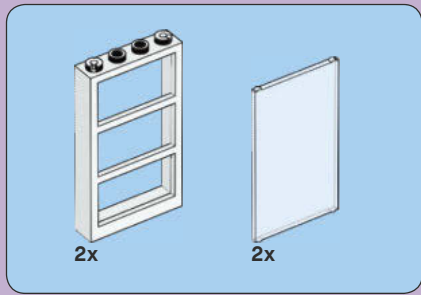

23

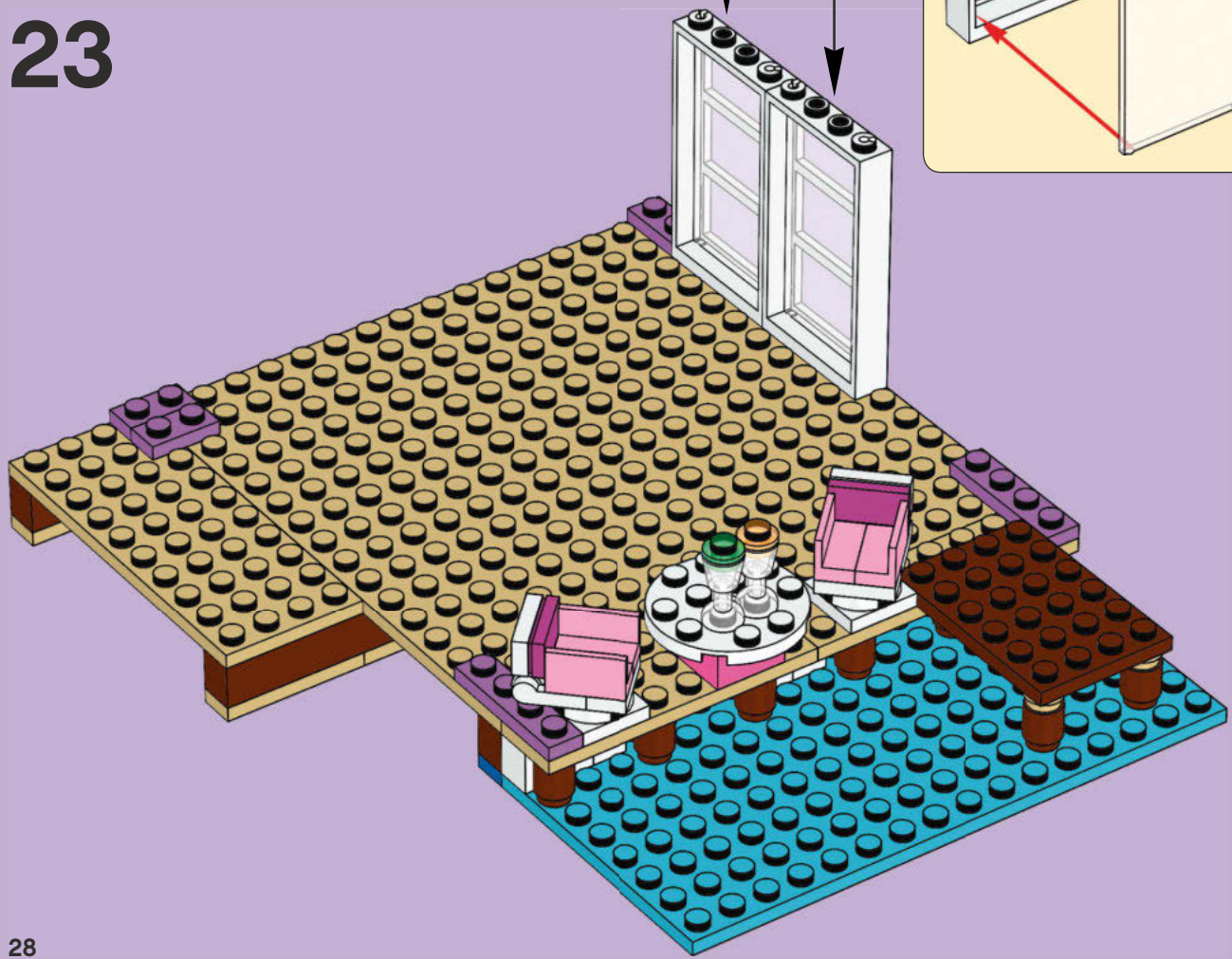
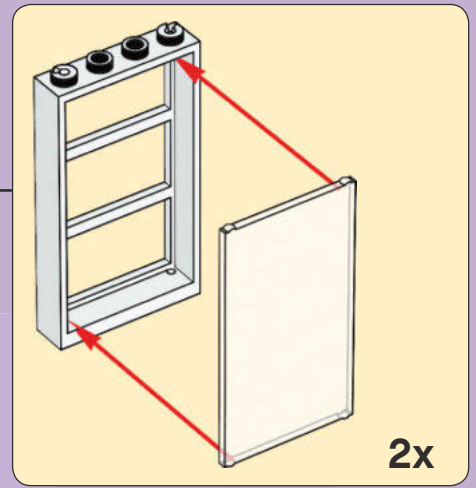

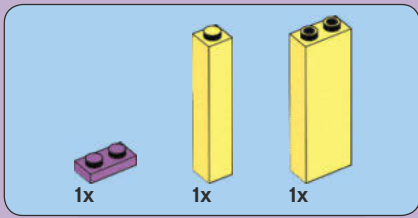

24

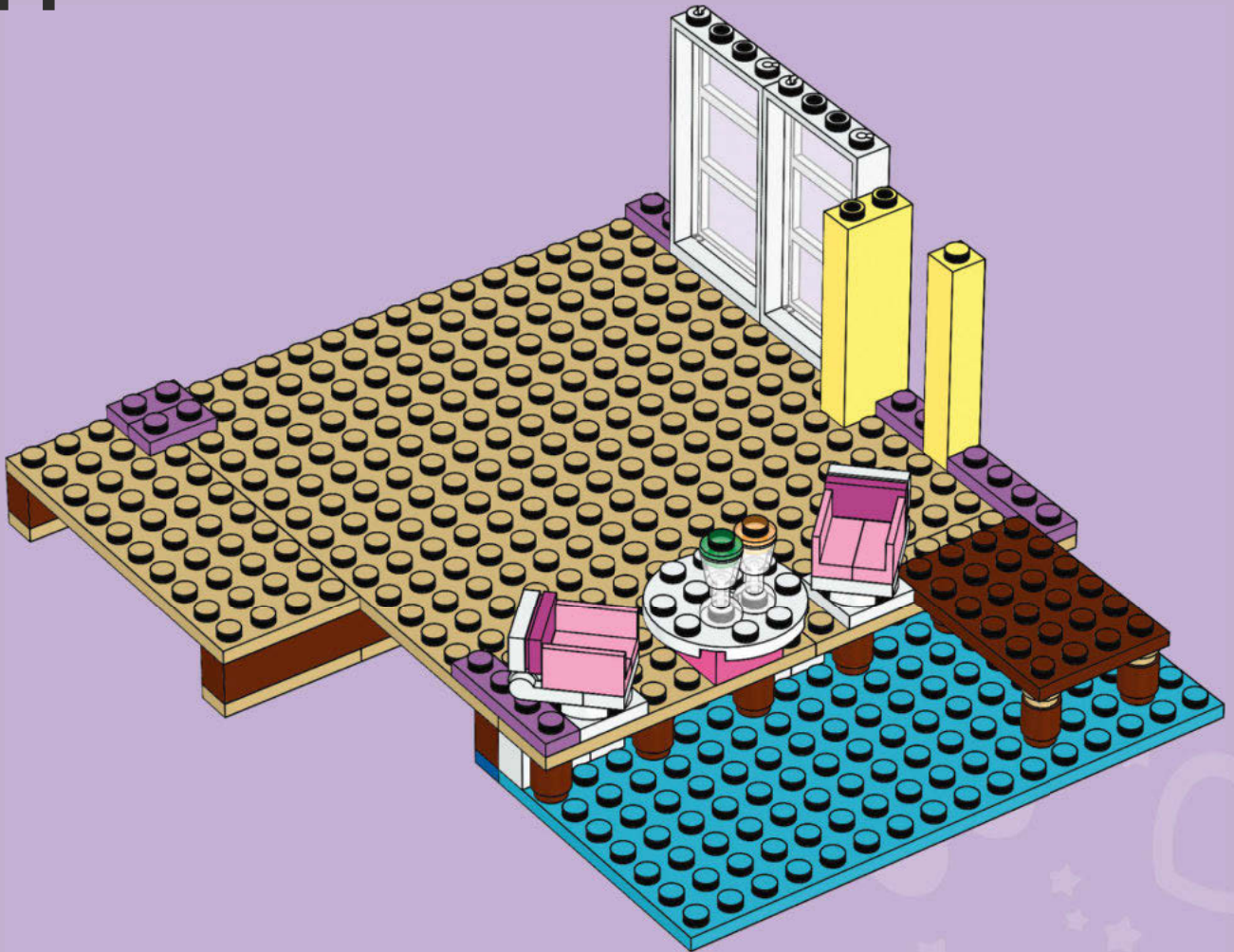

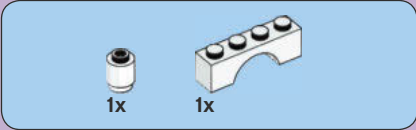

25

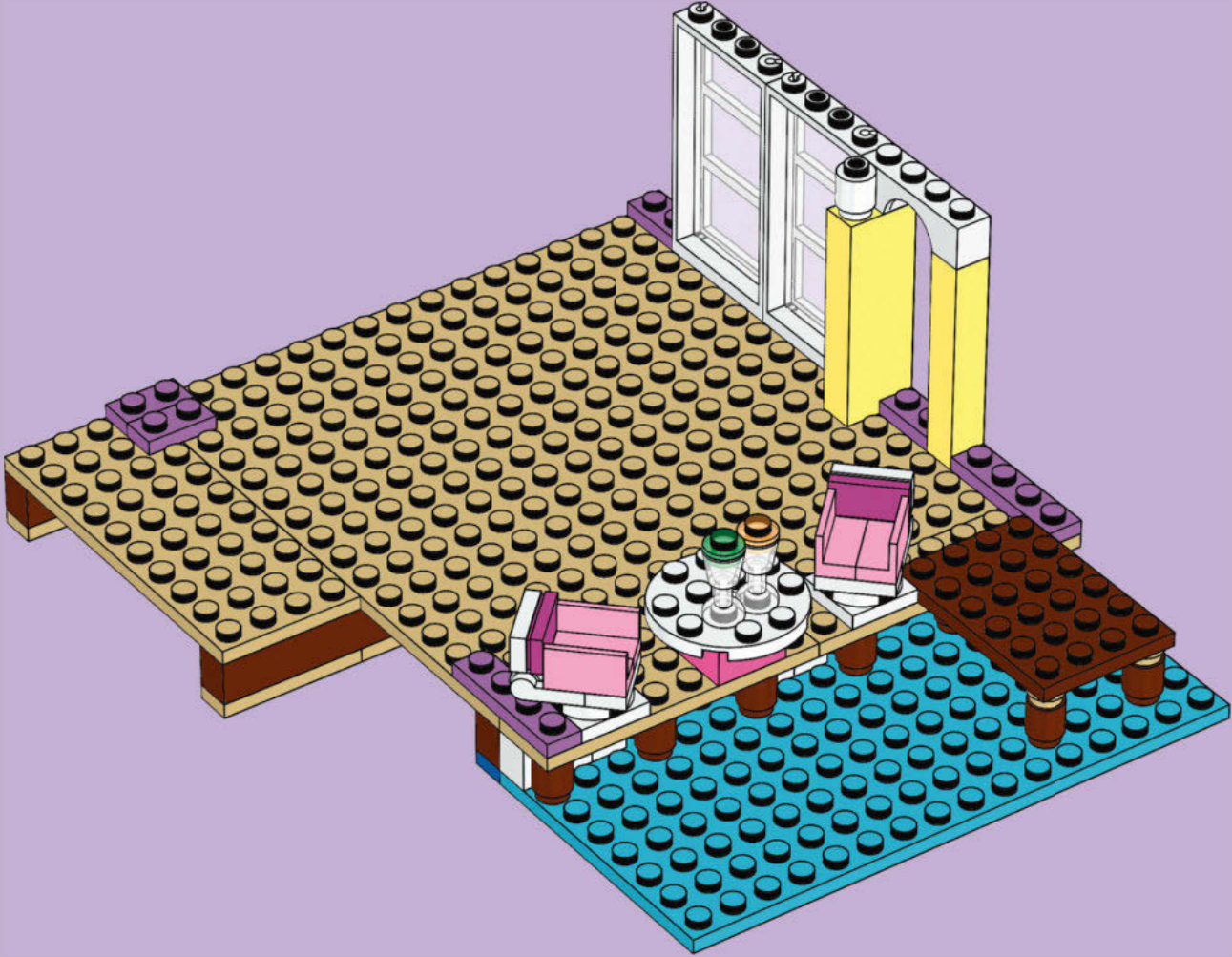

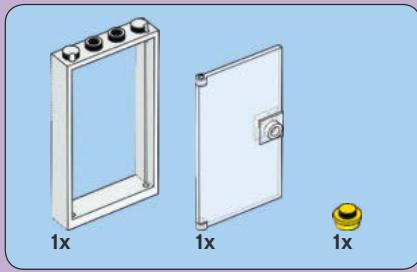

26

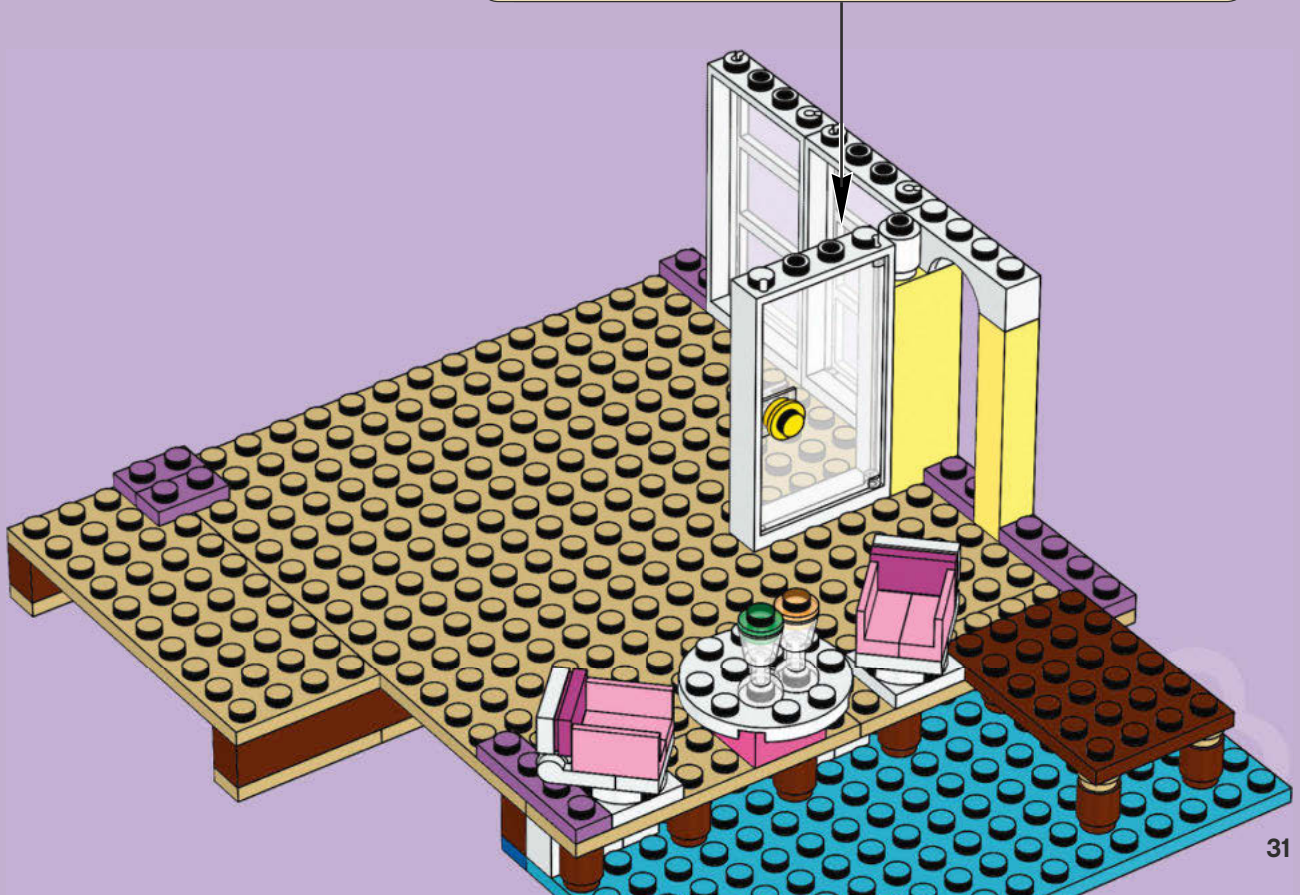
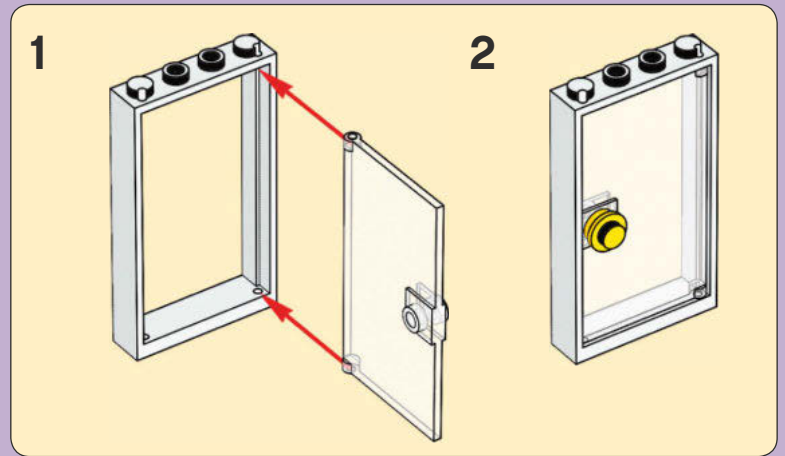

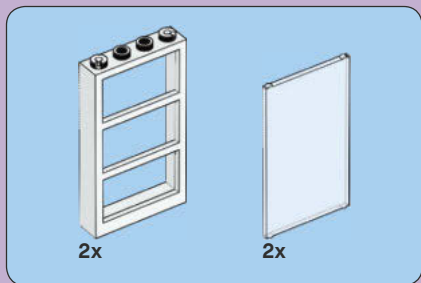

27

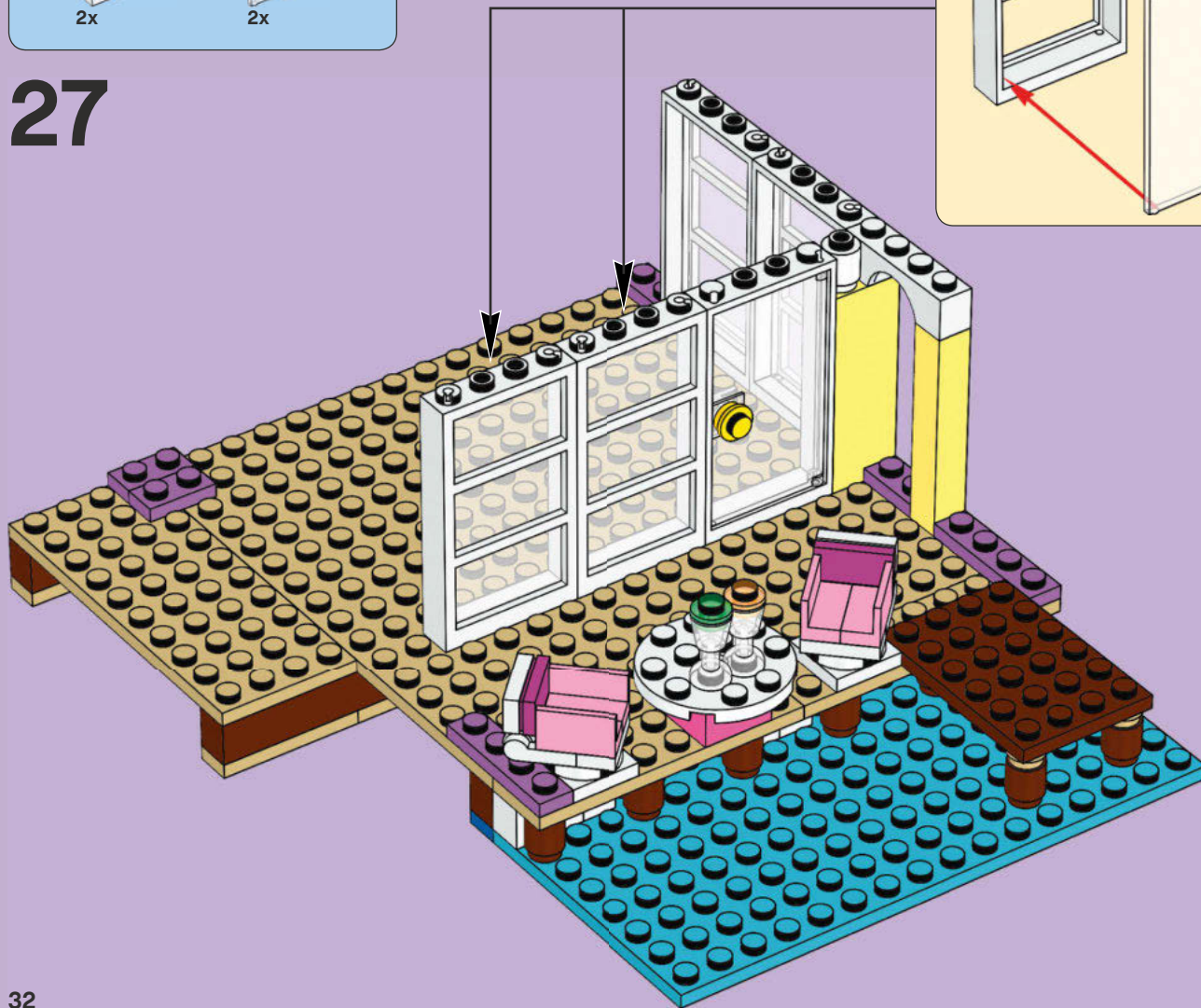
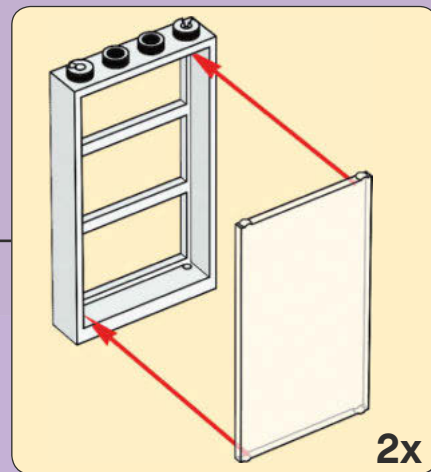

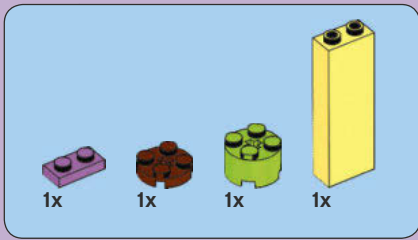

28

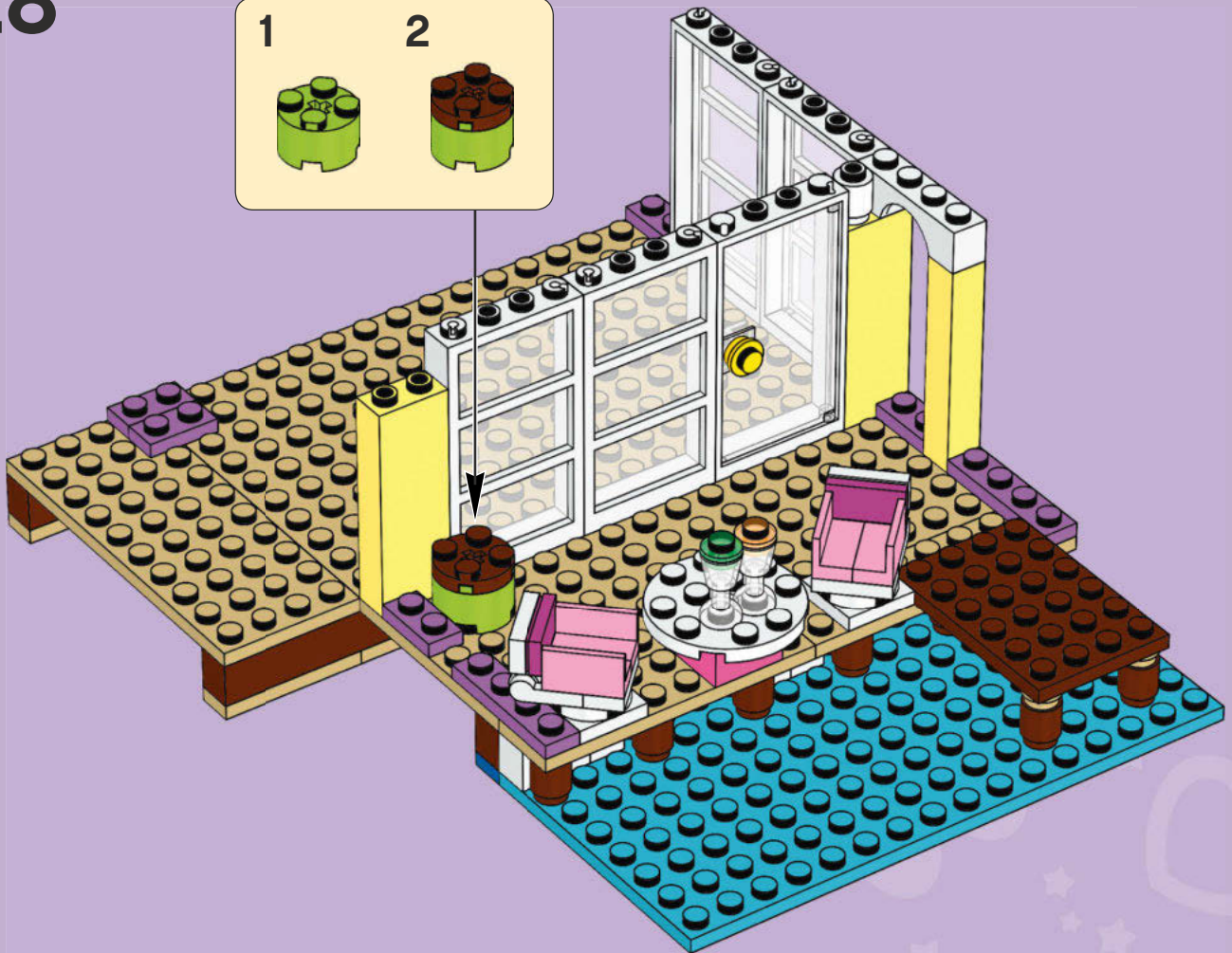
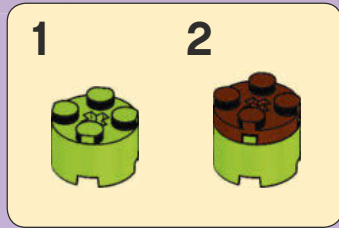

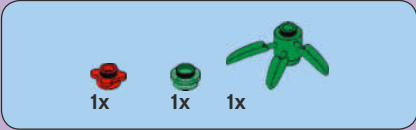

29

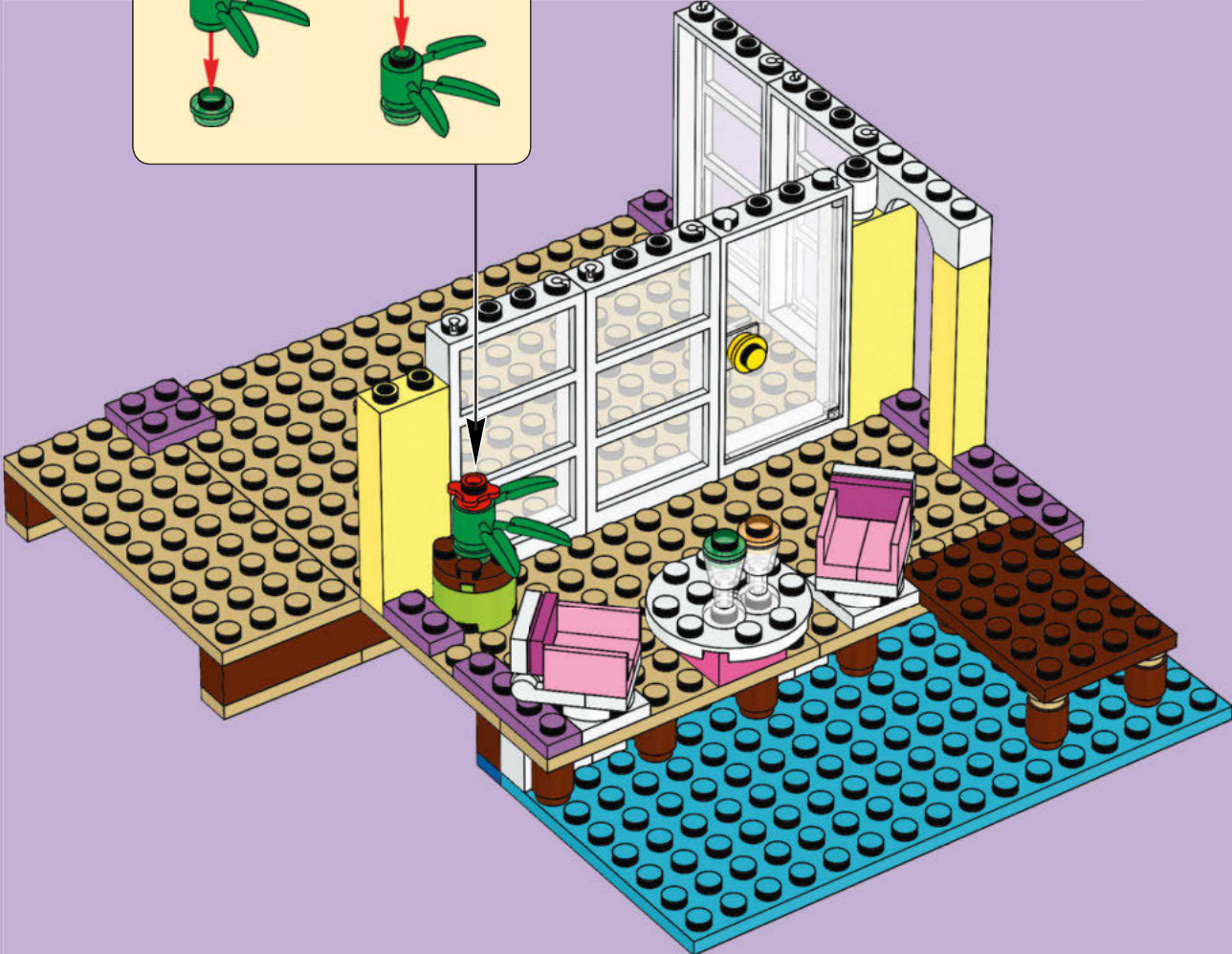
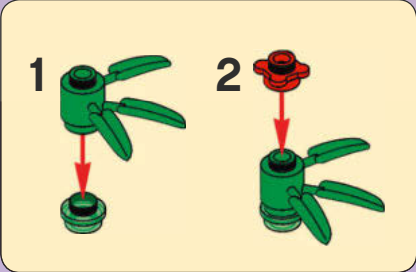

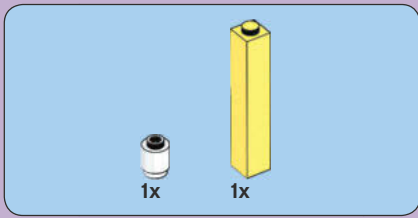

30

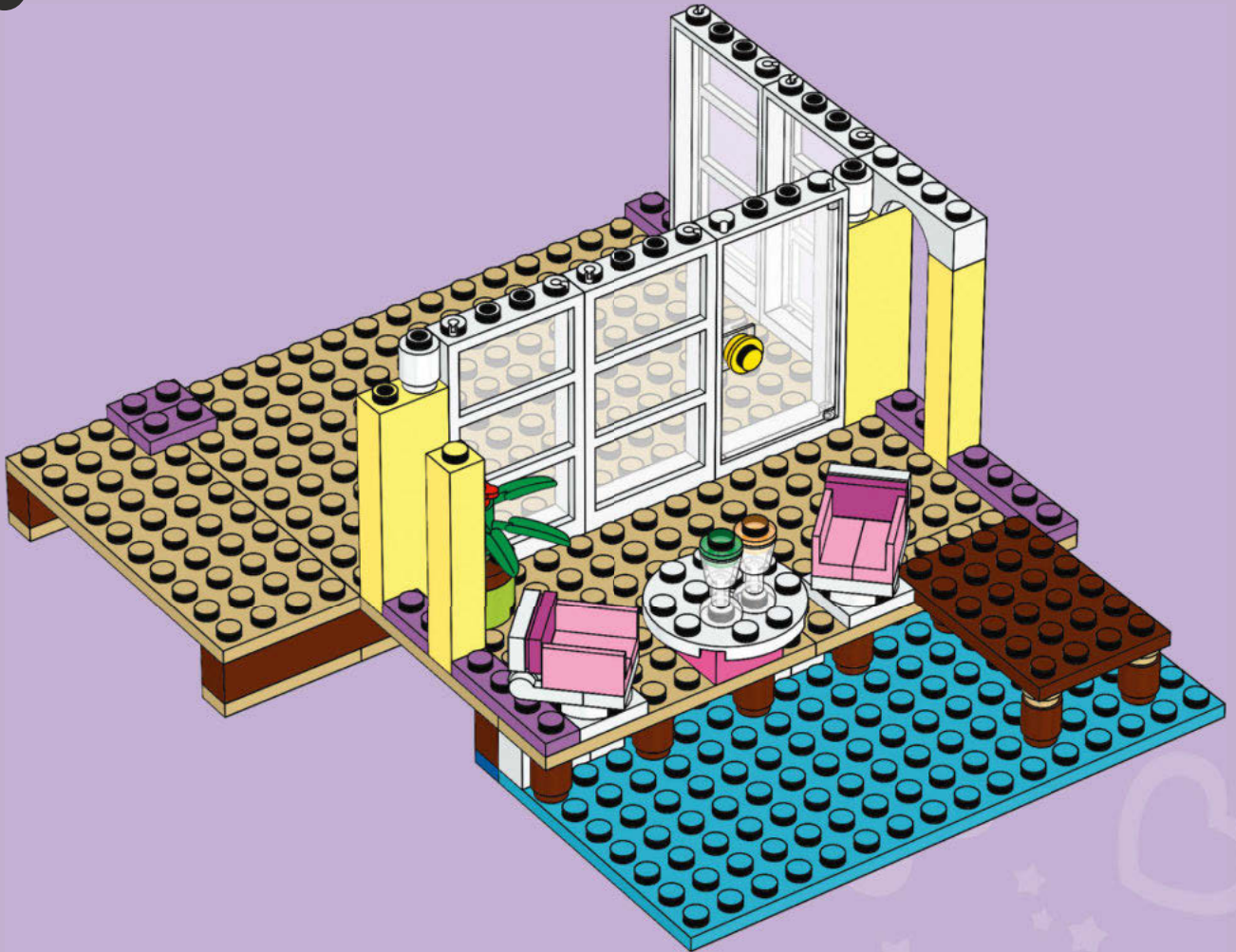

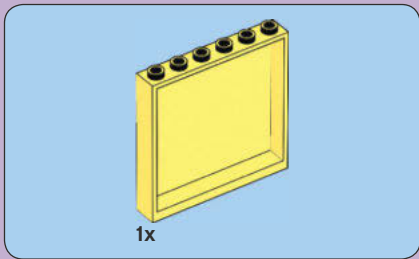

31

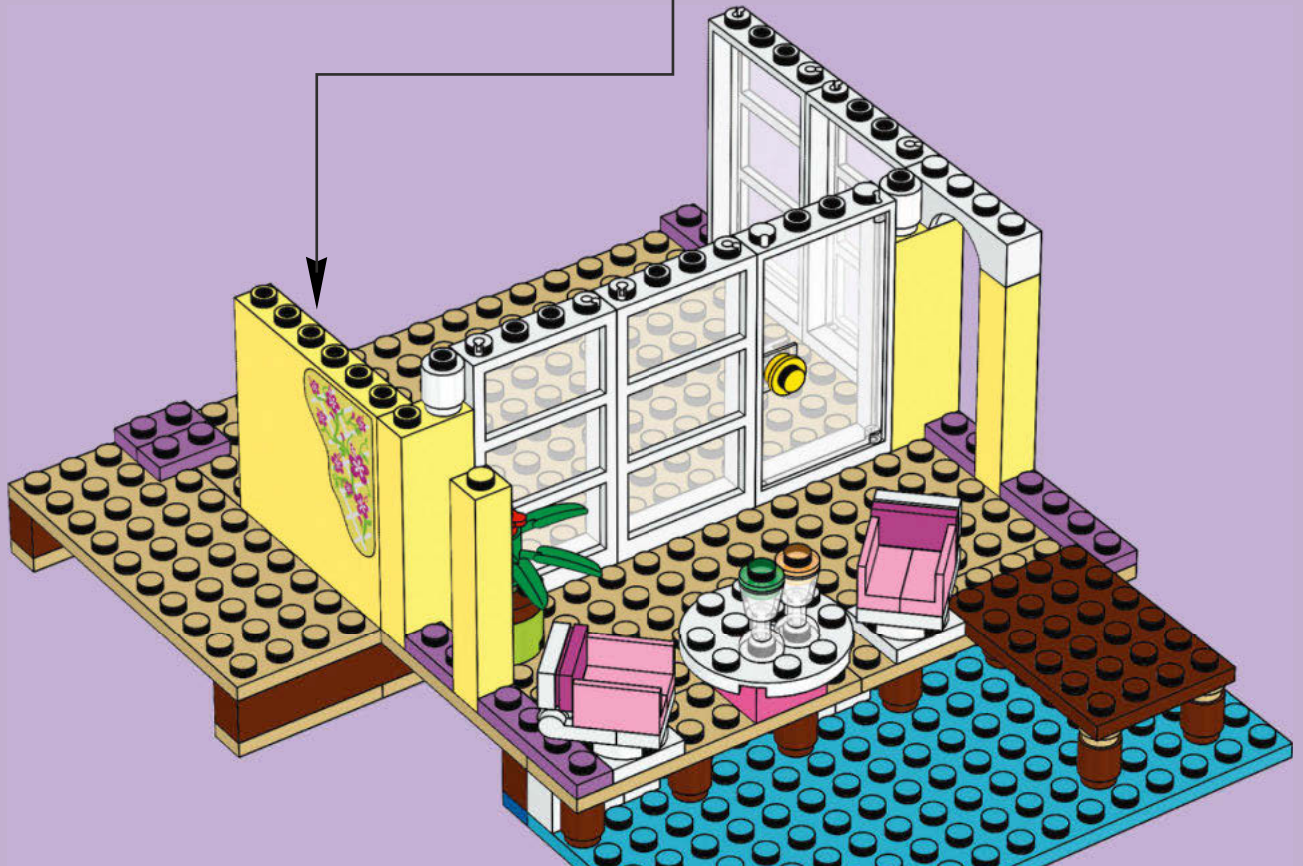
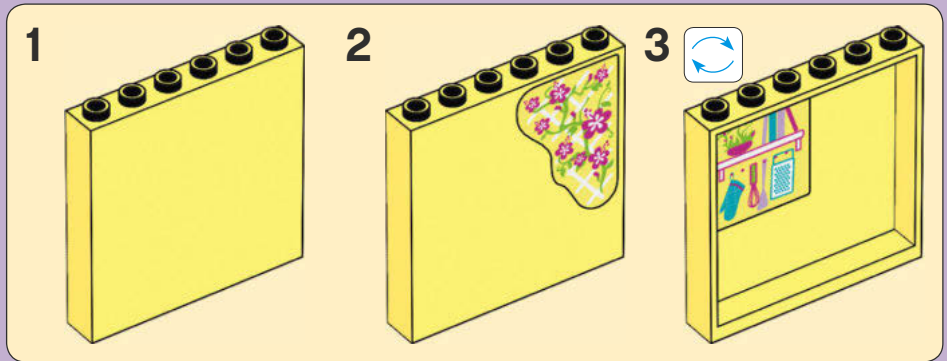

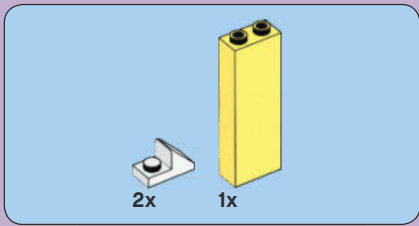

32

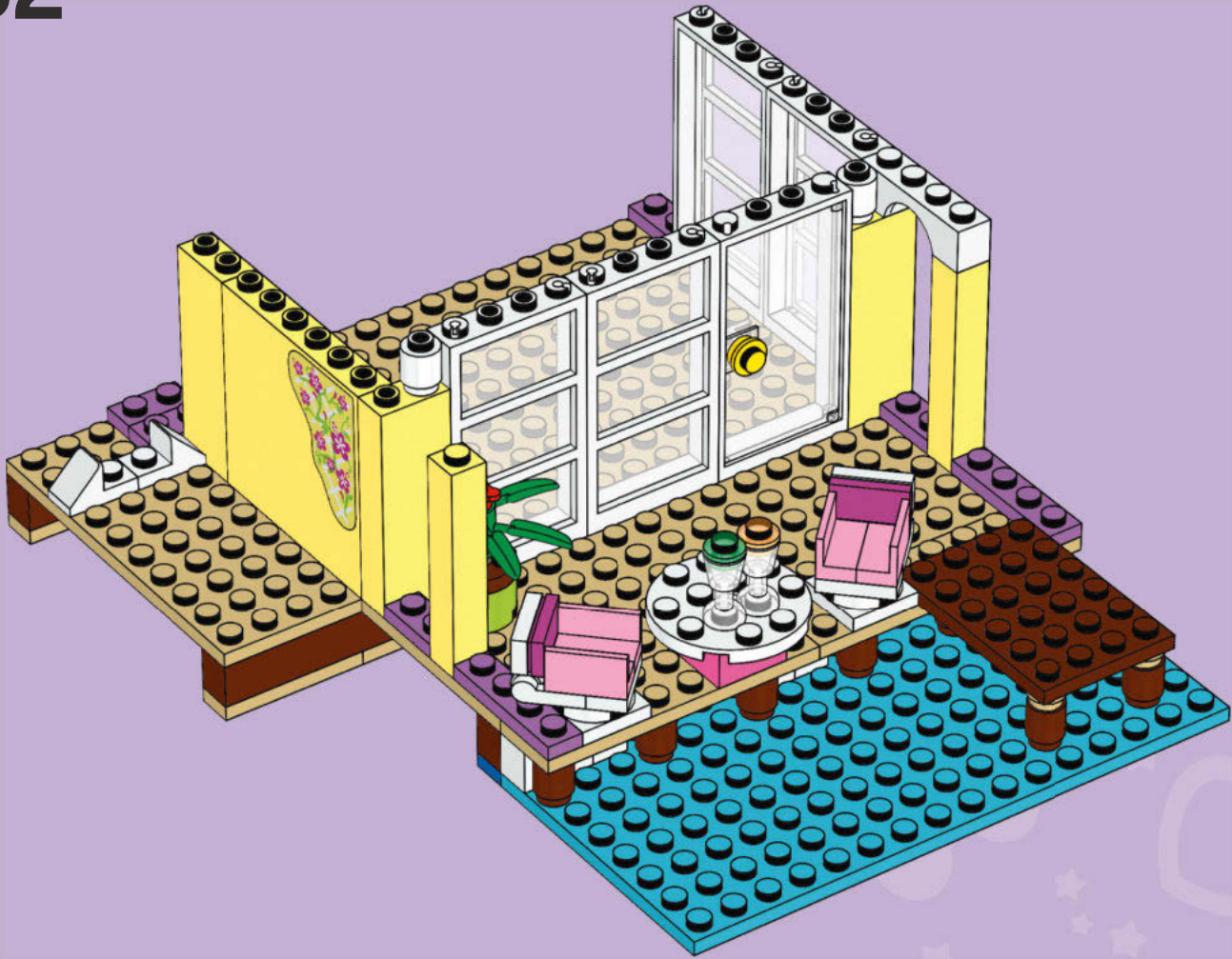

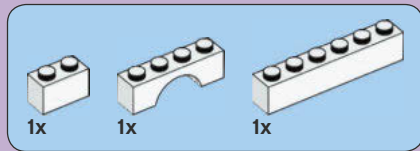

33

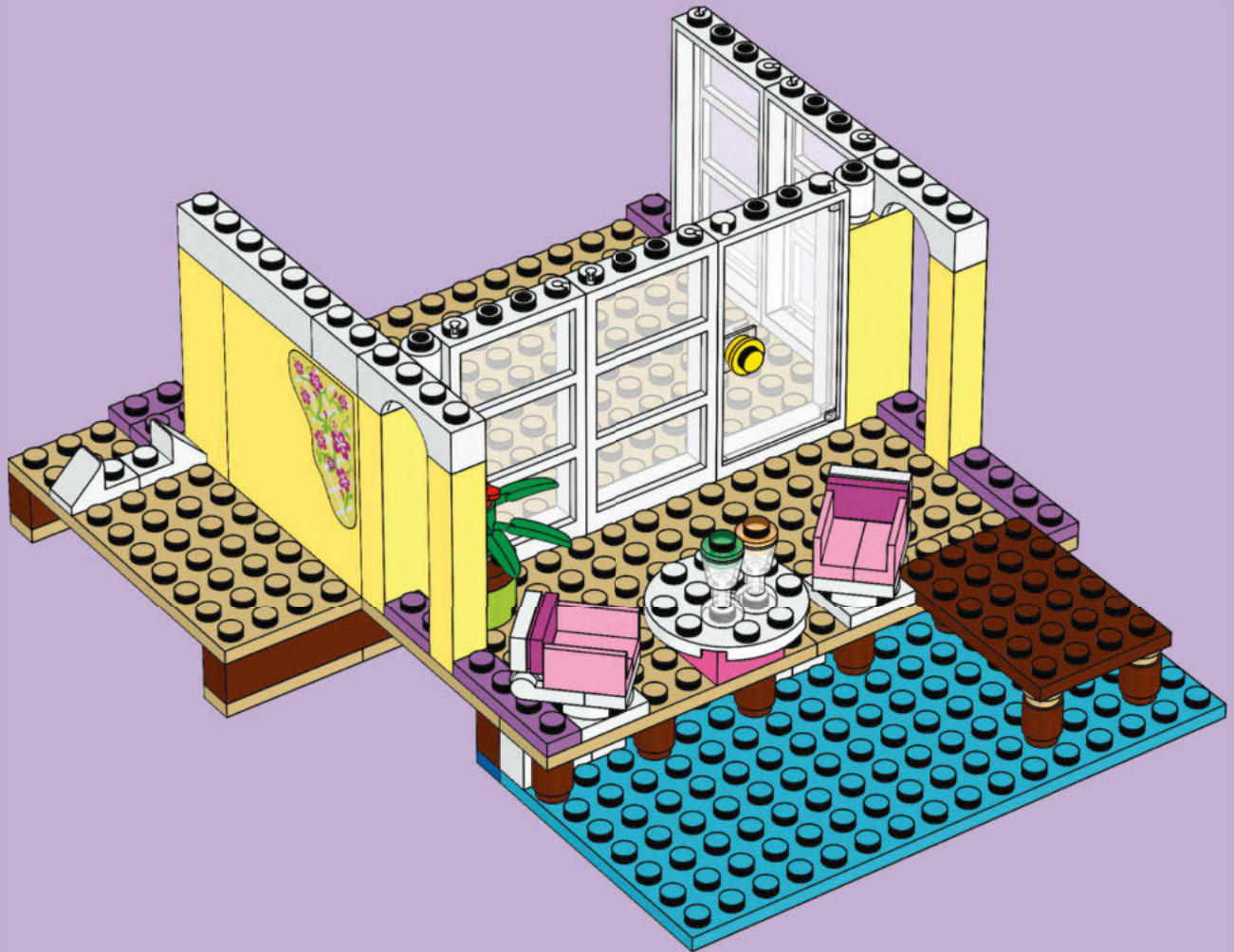

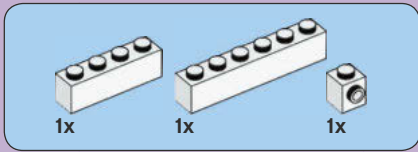

34

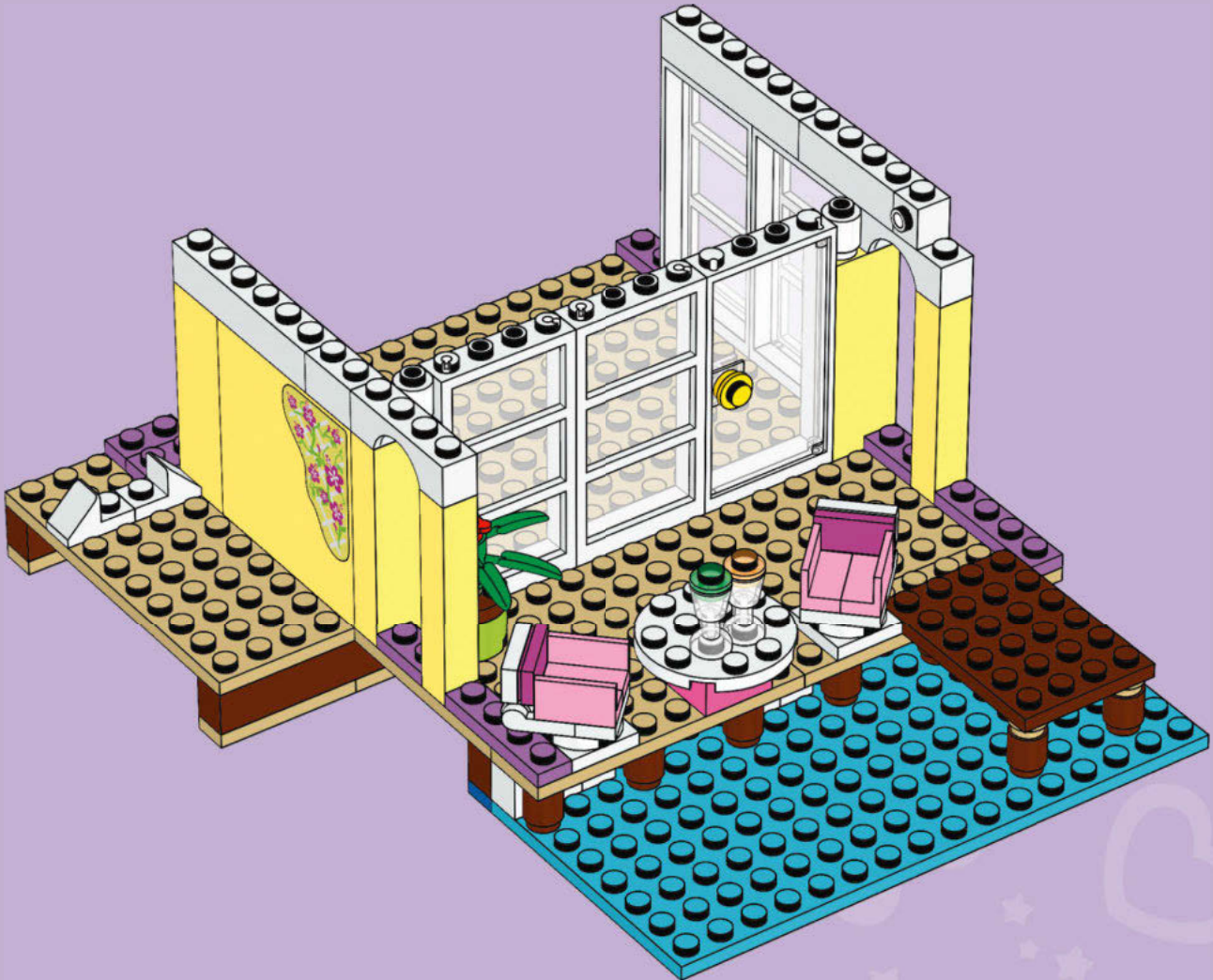

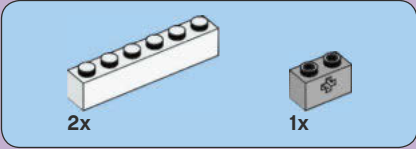

35

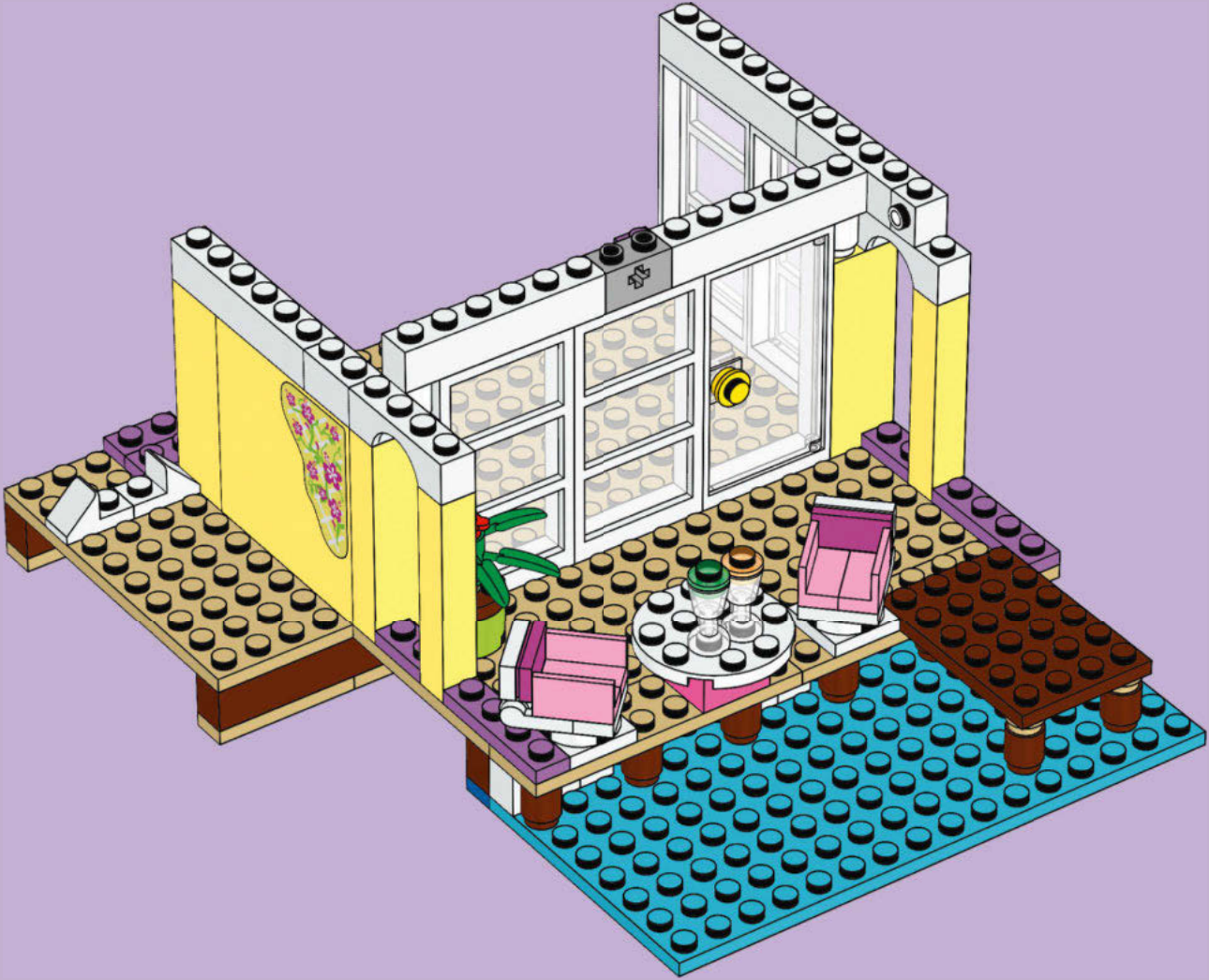

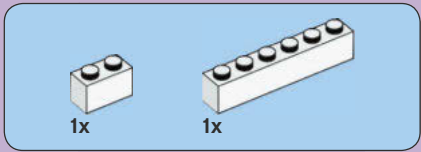

36

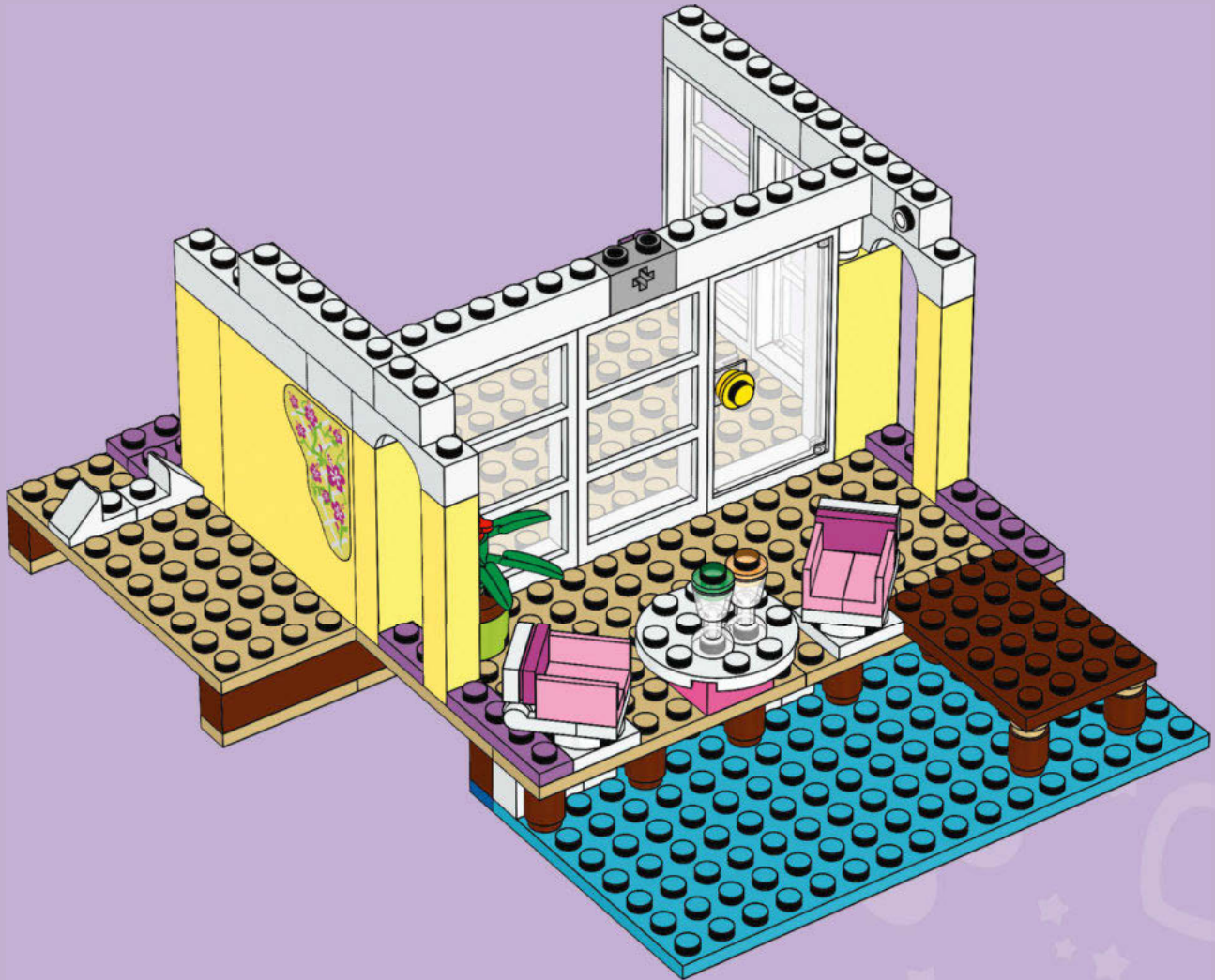

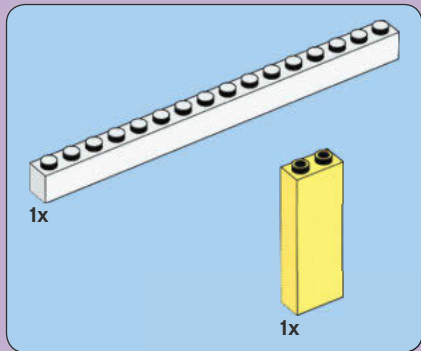

37

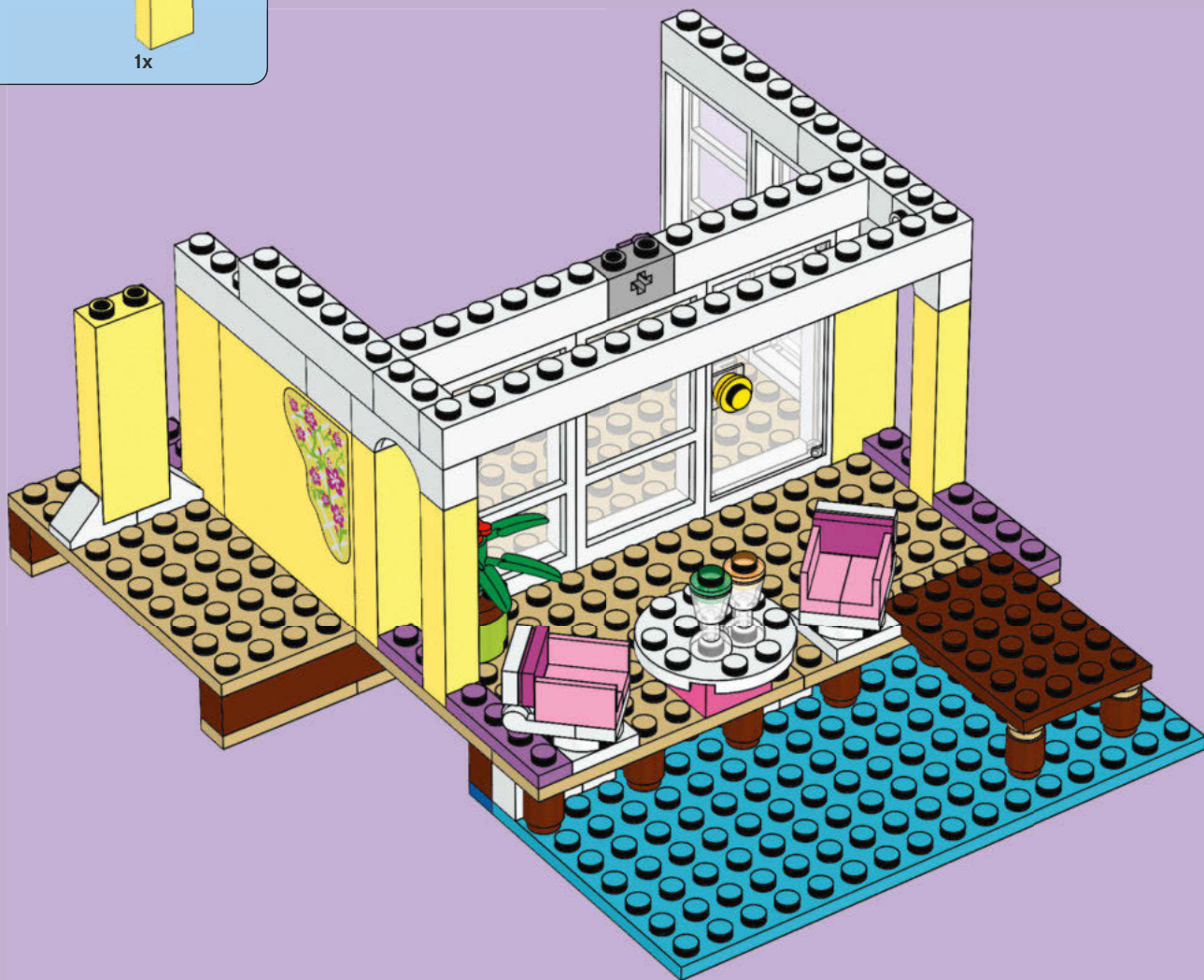

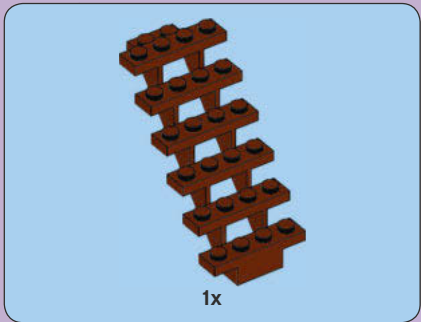

38





1x



1x

39





40



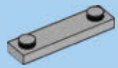

2x



6x

41

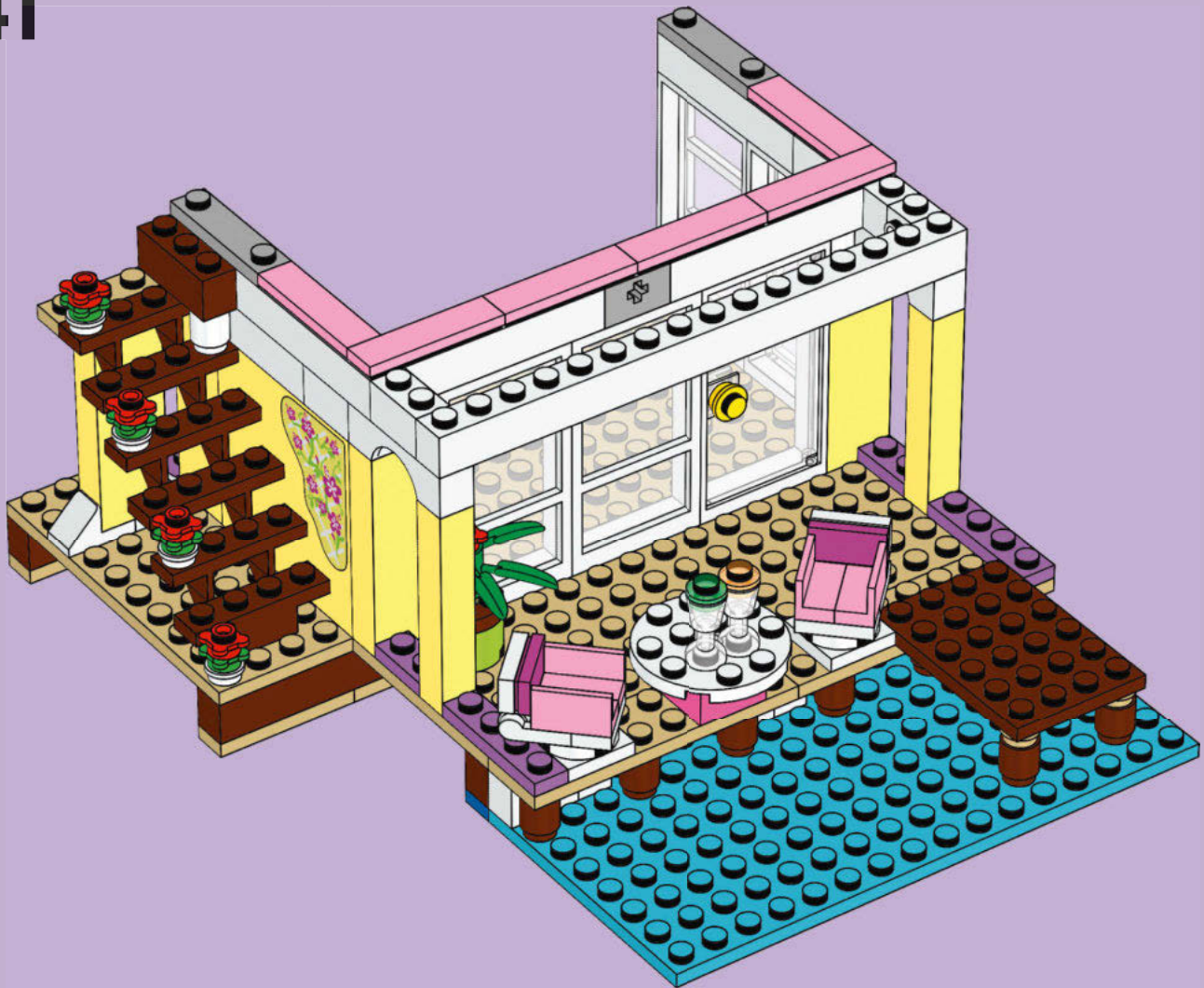



1x



5x

42





2x



4x

43

1



2



3



2x



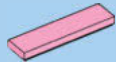

1x

44

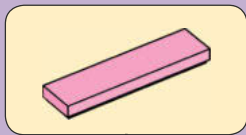
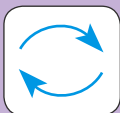

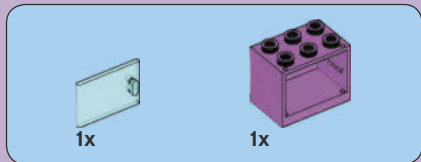

45

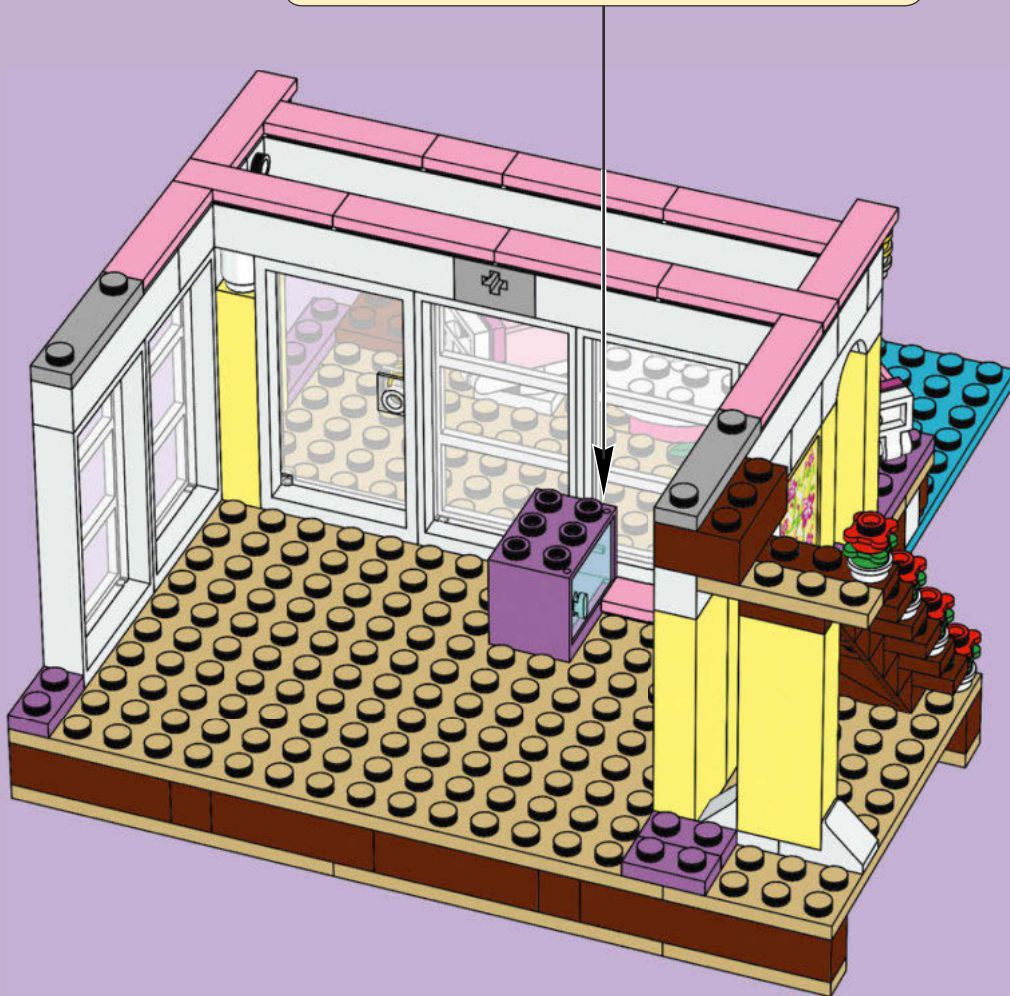
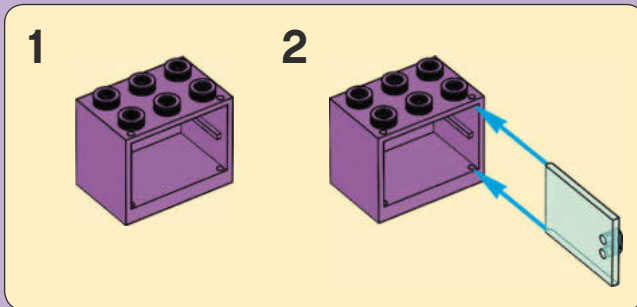



2x



1x

46

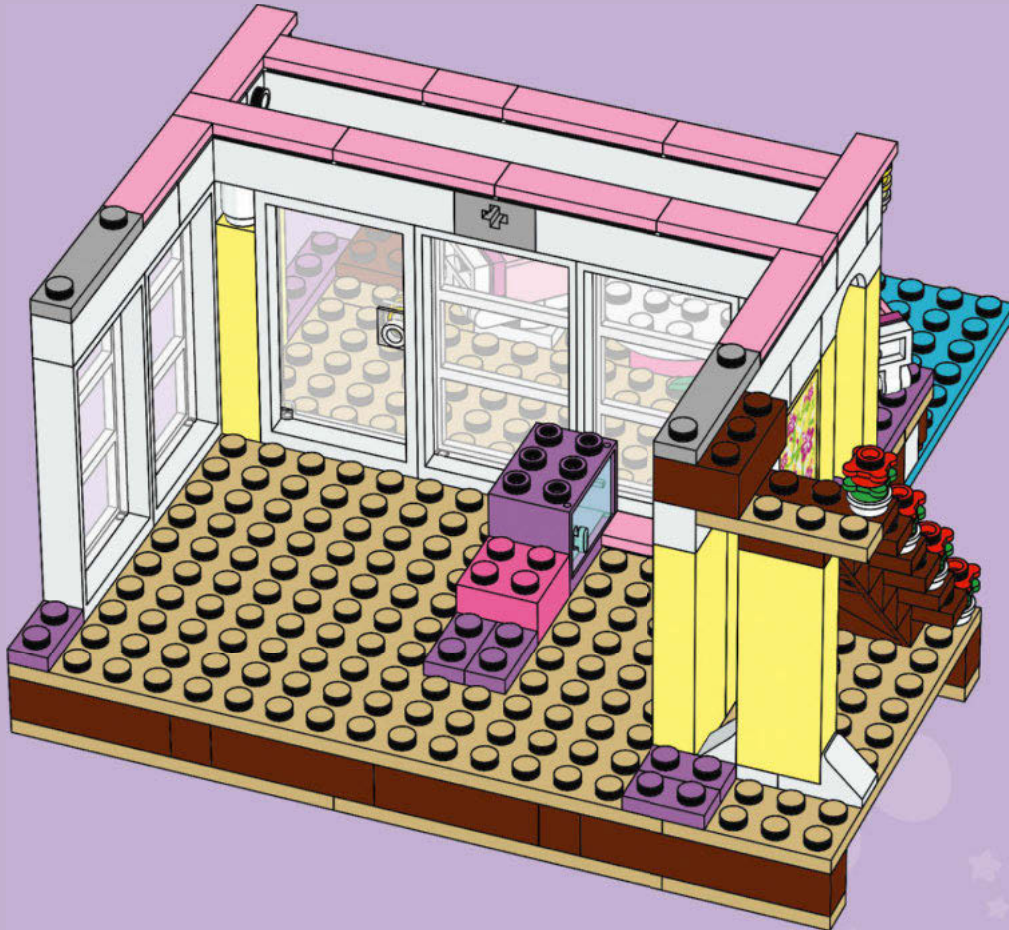



1x



2x

47

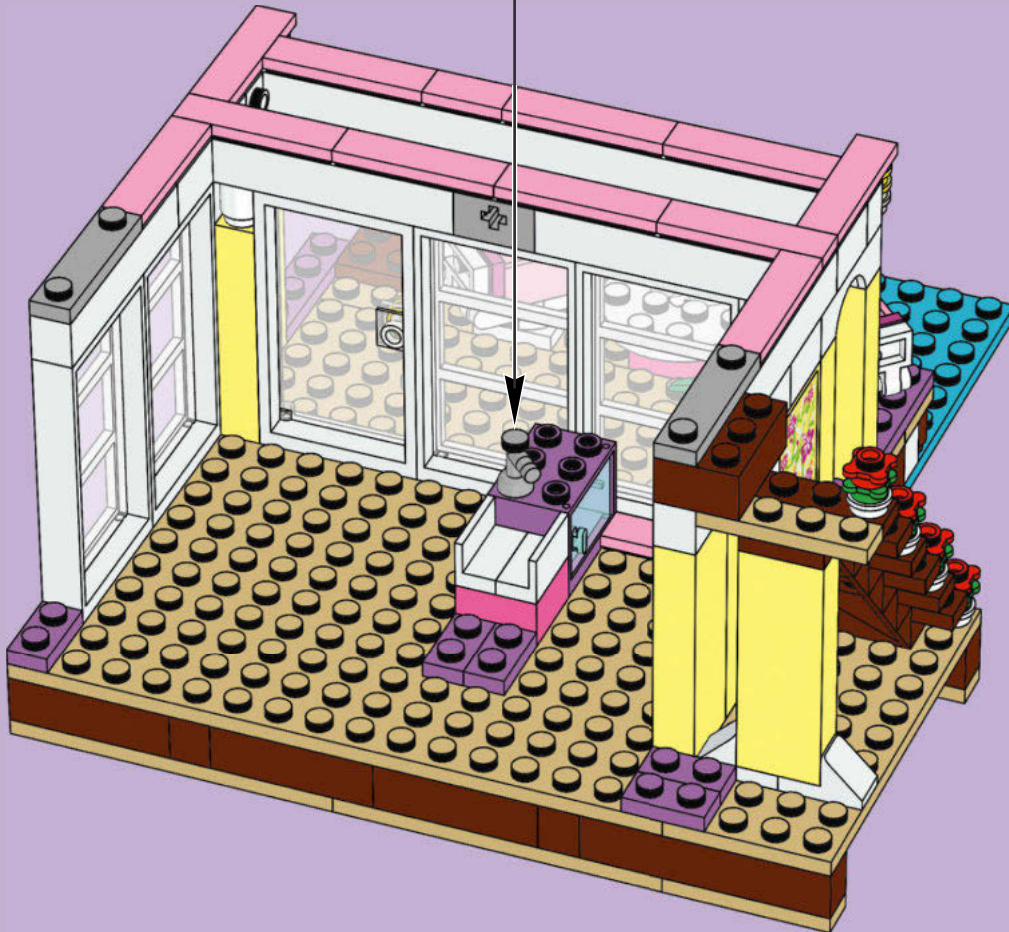



1x



1x

1



2

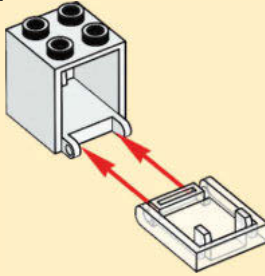

48

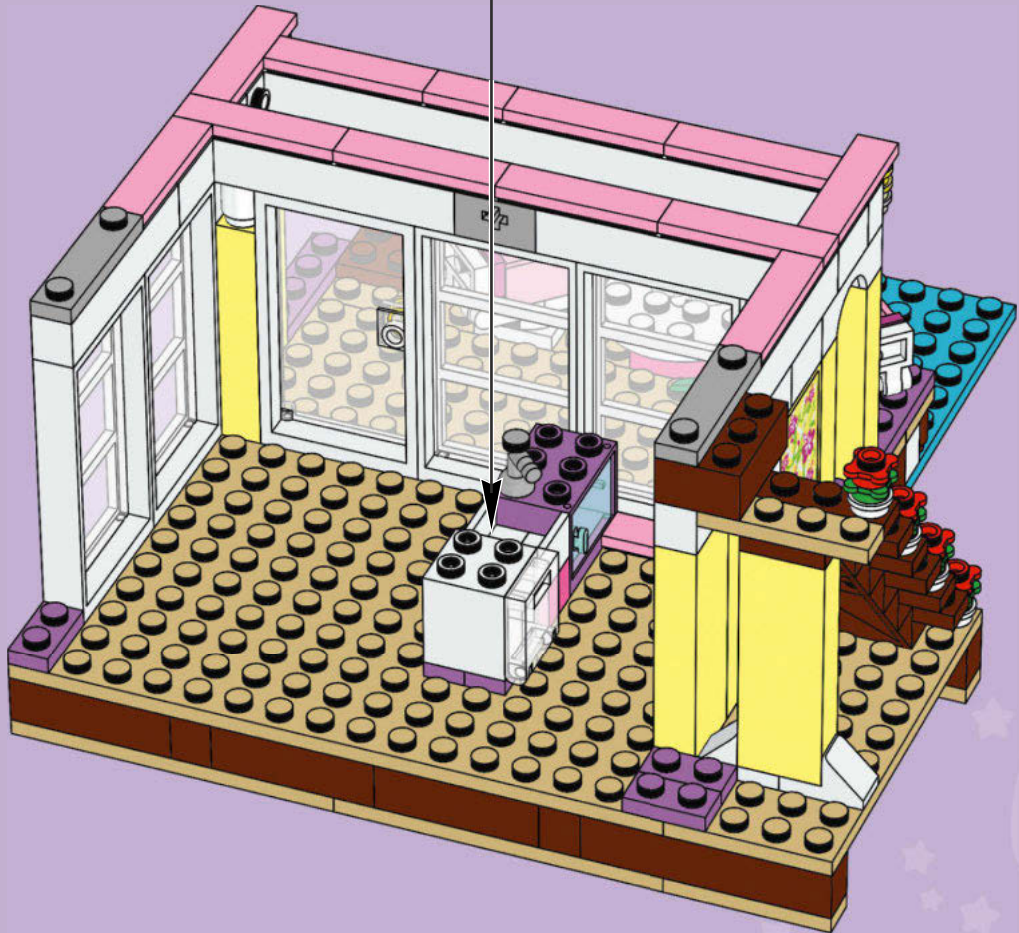



2x



1x

49

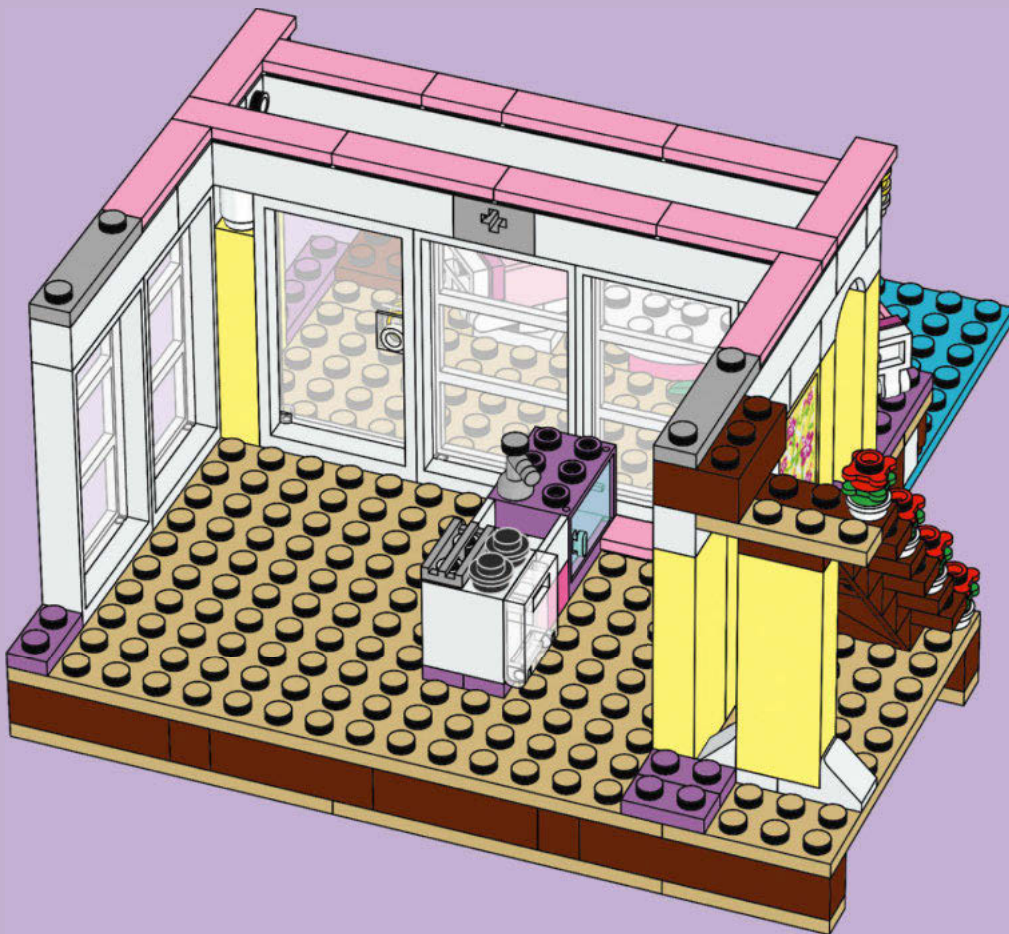



50

