



Friends



41058



LEGO.com/friends

 **WARNING: CHOKING HAZARD.**
Toy contains small parts and a small ball.
Not for children under 3 years.

1



2



3



4

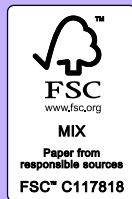

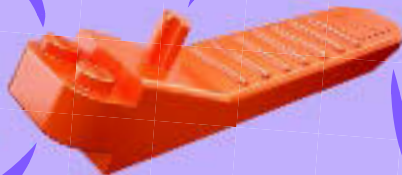
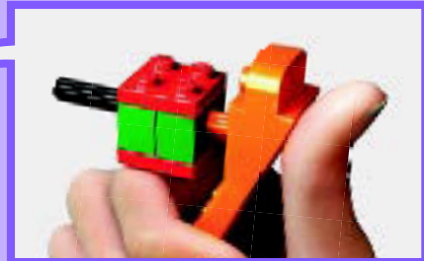

LEGO.com/brickseparator



AVERTISSEMENT : RISQUE D'ÉTOUFFEMENT.
Le jouet contient des petites pièces ainsi qu'une petite boule.
Il ne convient pas aux enfants de moins de 3 ans.



ADVERTENCIA: PELIGRO DE ASFIXIA.
Juguete que contiene partes pequeñas y una pelota pequeña.
No recomendado para niños menores de 3 años.





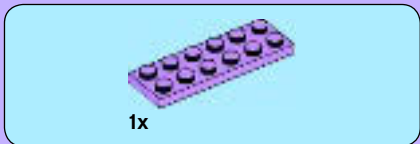

1x

1

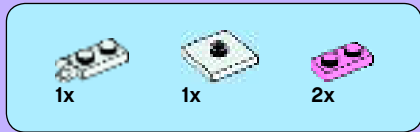
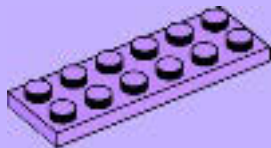

1x

1x

2x

2

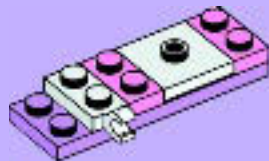



2x

3

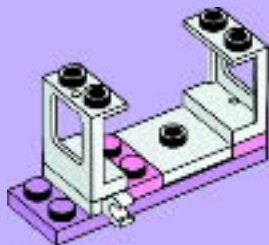

1x



1x

4

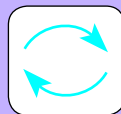



2x



2x

5

1

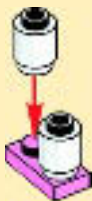

2

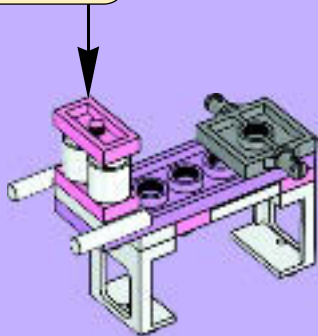

8



2x

6

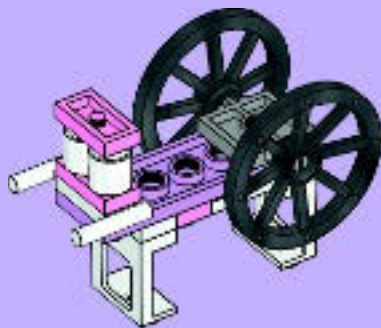



1x



1x



1x

7

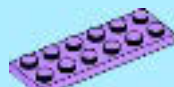
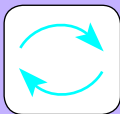

1x

1





2

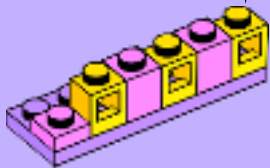

3

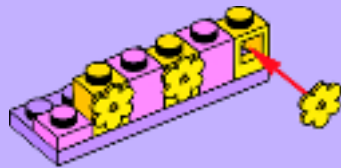



1x



1x



1x



1x

4

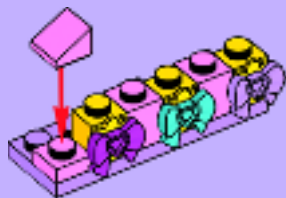

8

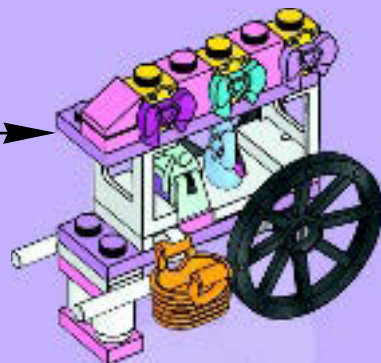

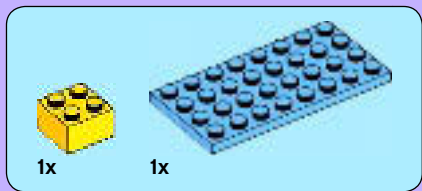

1



2

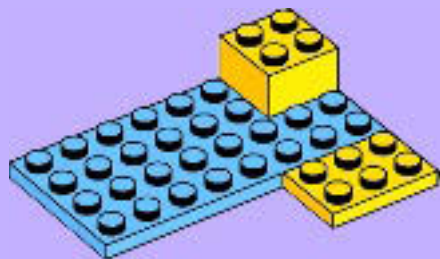

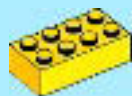

2x

3

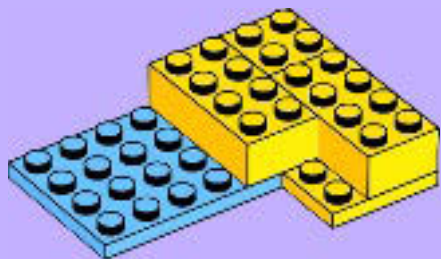

1x

4

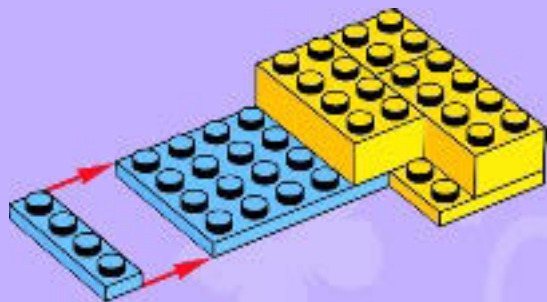

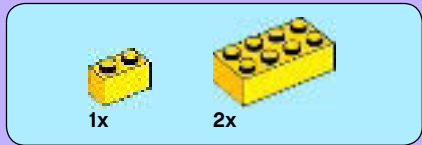

5

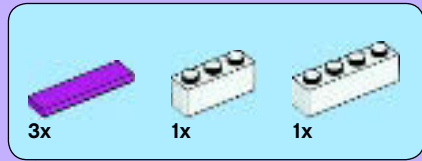
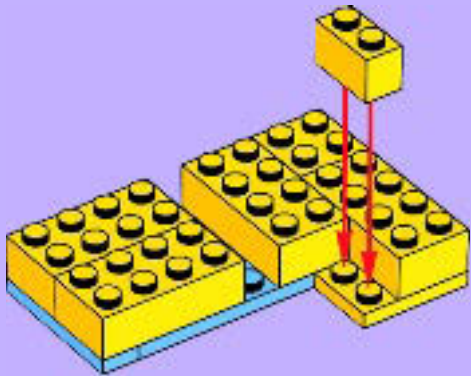

6

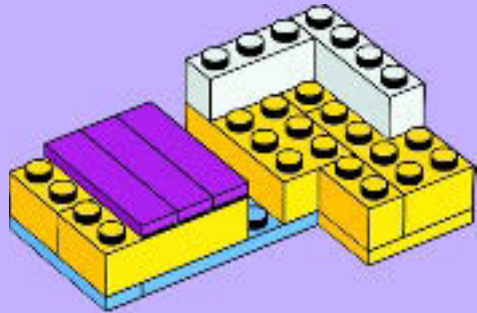

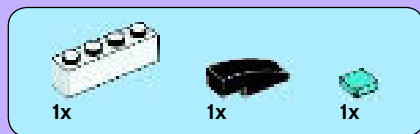

7

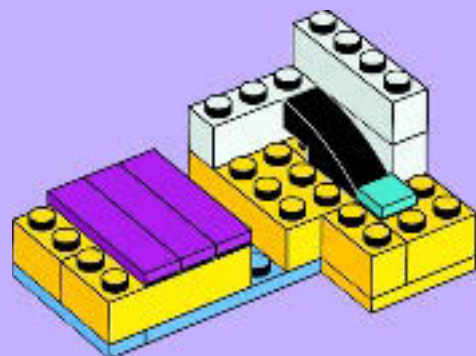

8

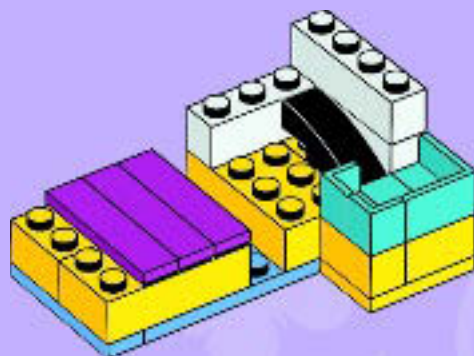



1x



1x

9

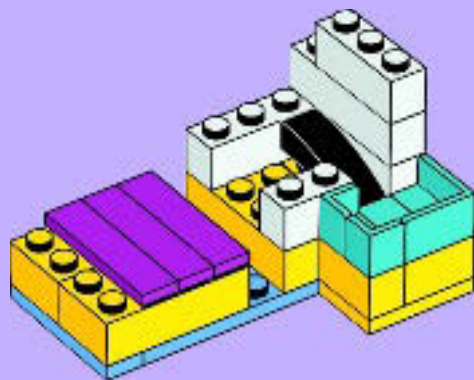



10

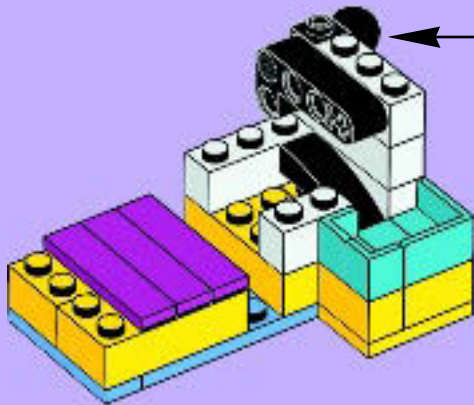
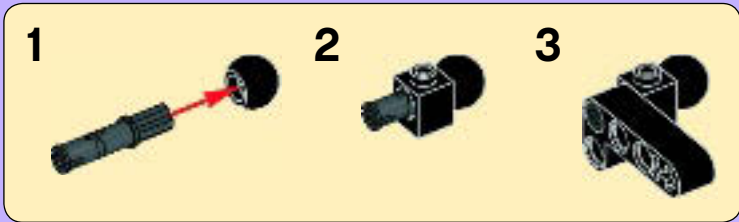



11

1



2

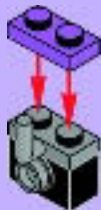

3

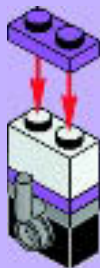

4



5





1x



1x

12

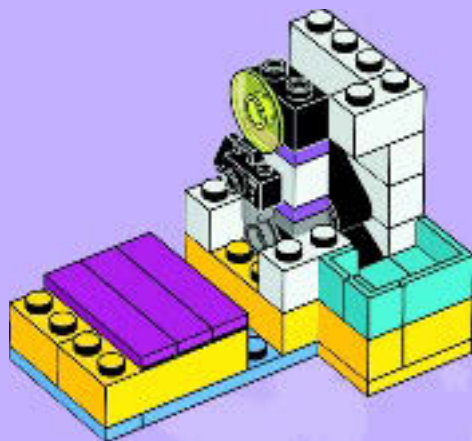
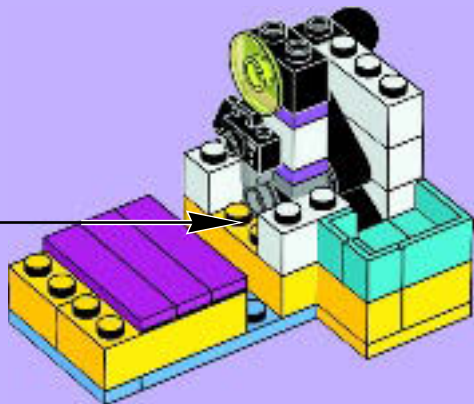



13

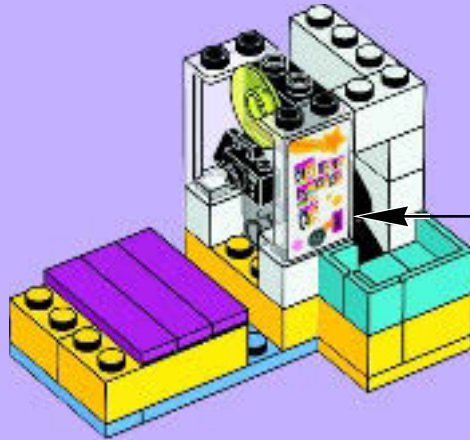

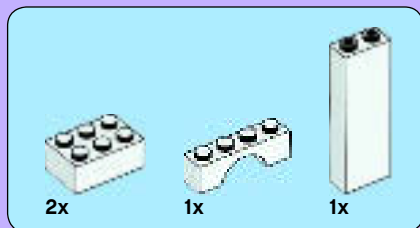

14

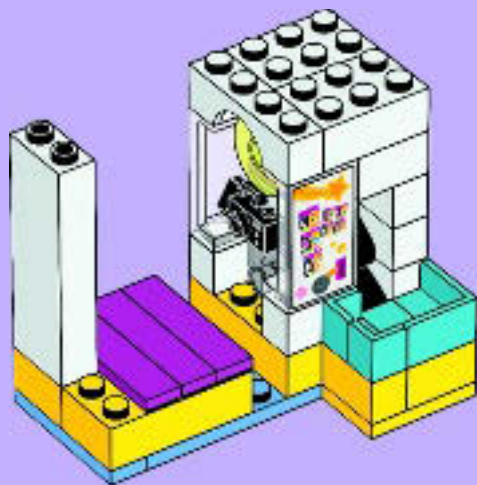

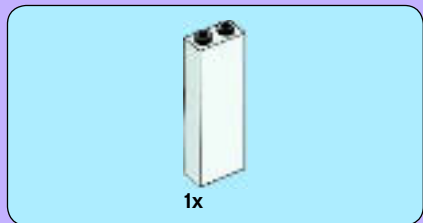

15

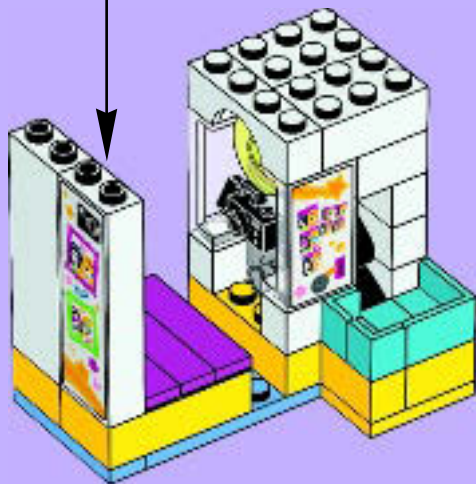



16

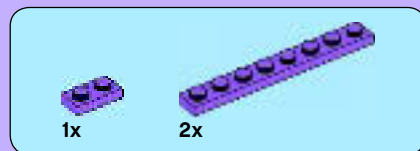

17





1x

18

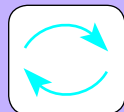
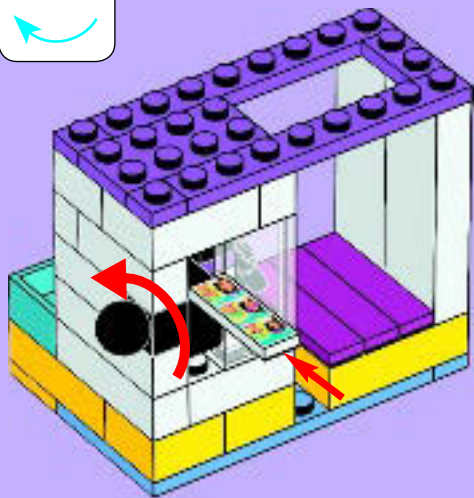
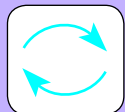

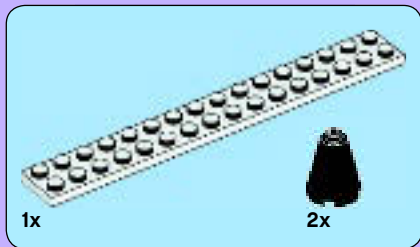

1

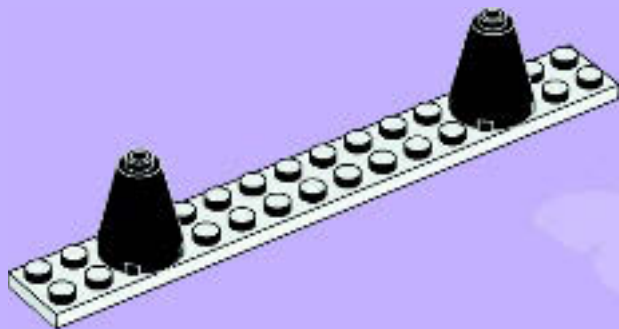



2

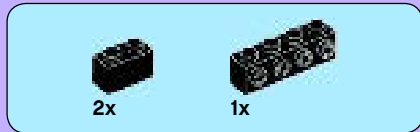
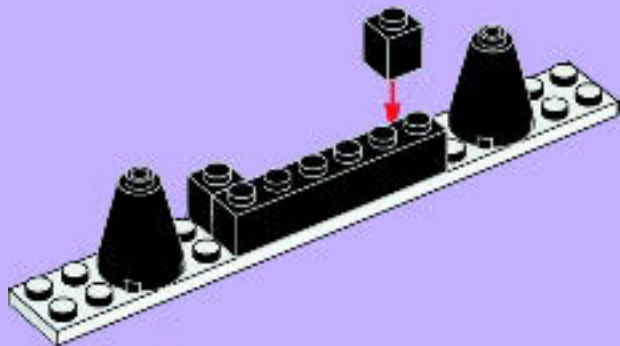

3

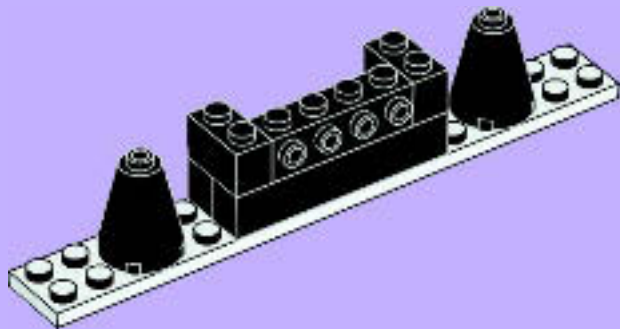

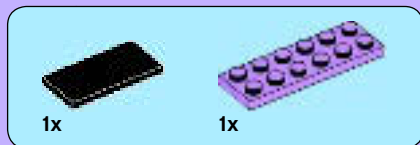

4

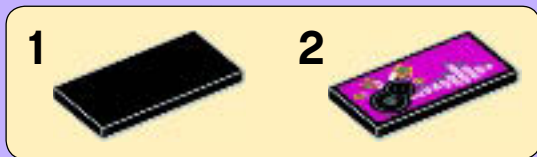

5





6

1



2



3



4



2x

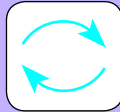



1x

7

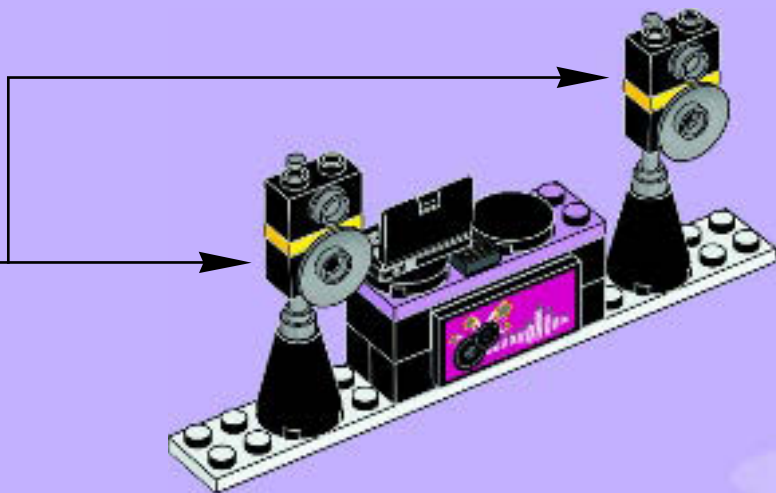

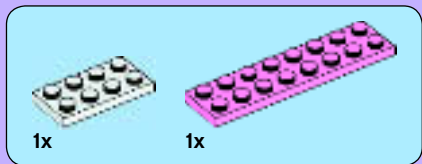

1

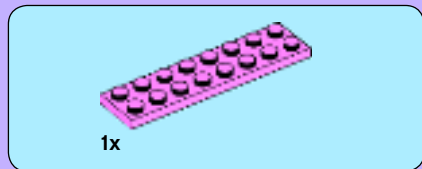
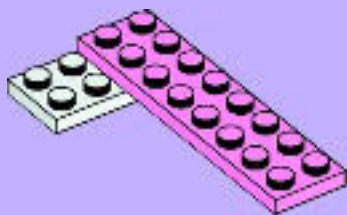

2



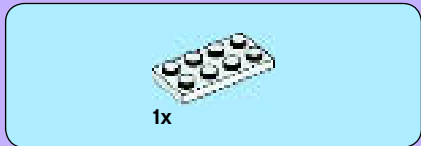

3

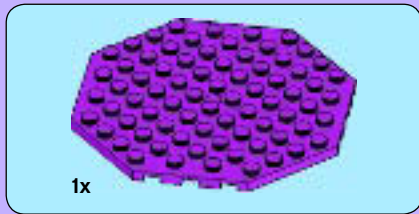
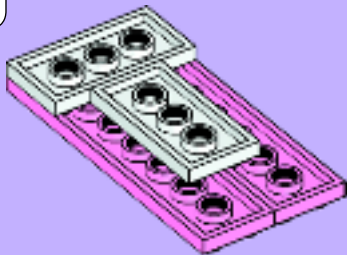

4

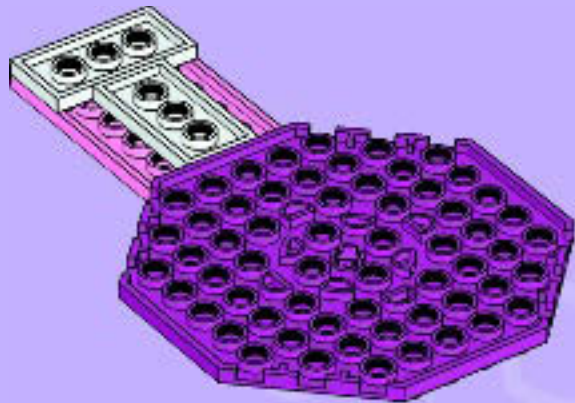

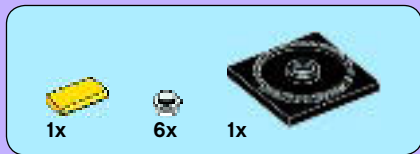

5

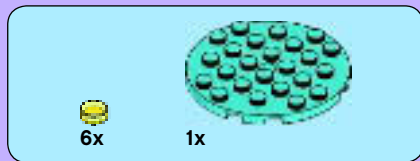
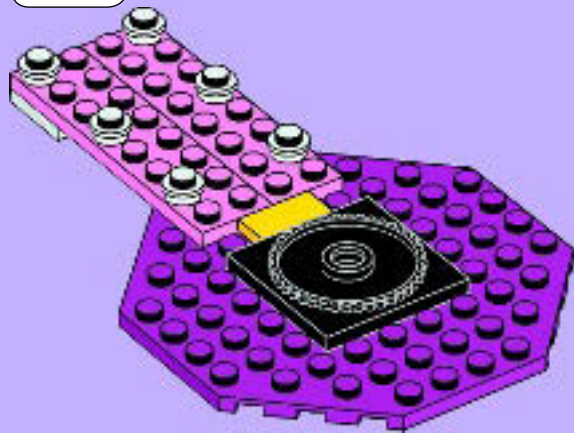
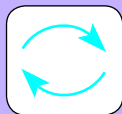

6

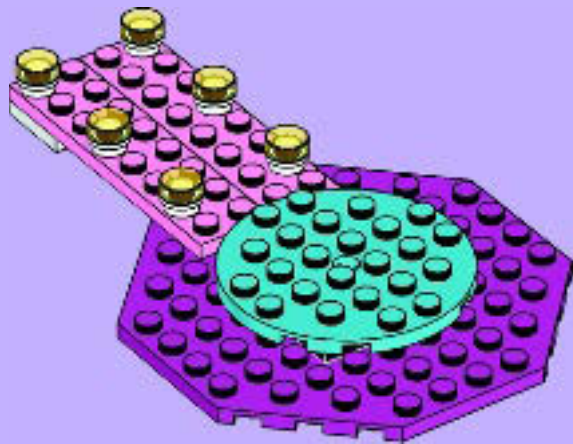

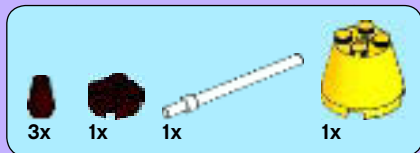

1

1



2



3





2

1



2



3



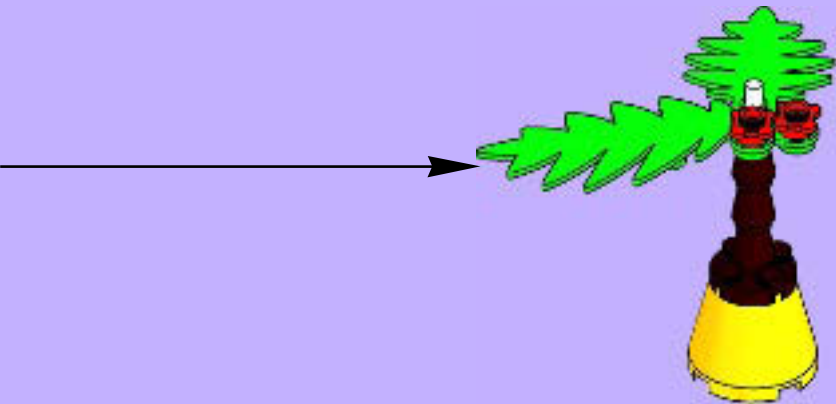

2x





1x



1x

1

1

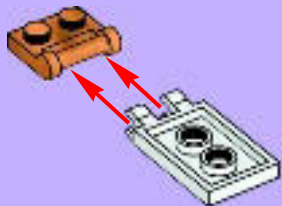

2



1x



1x

2

1



2



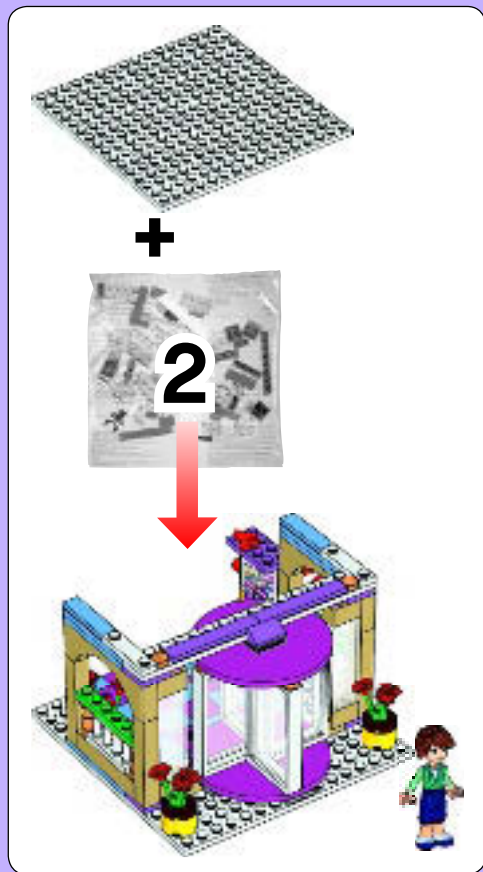



1x

1

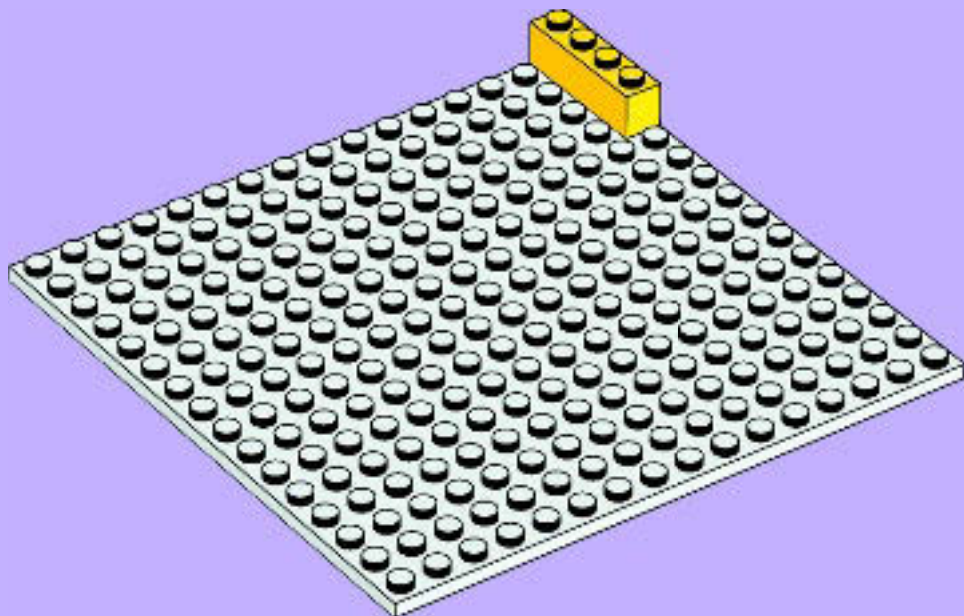



2

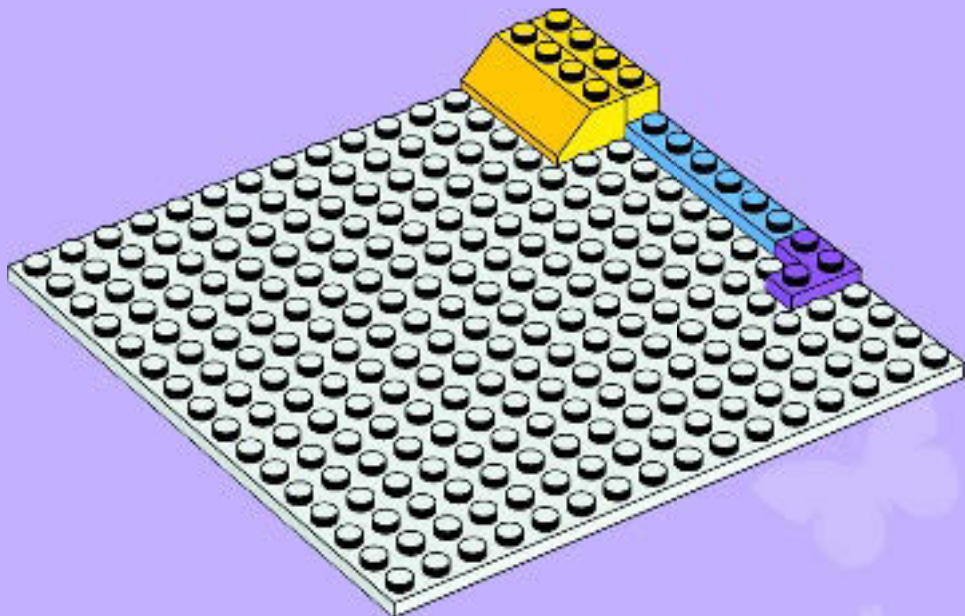



3x



2x



1x

3

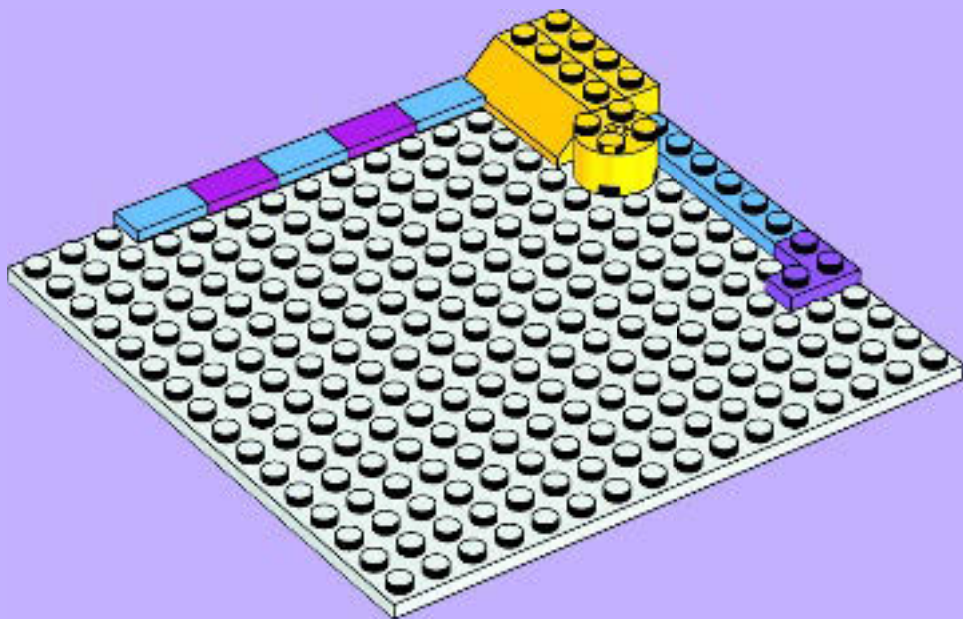



10x



10x

4

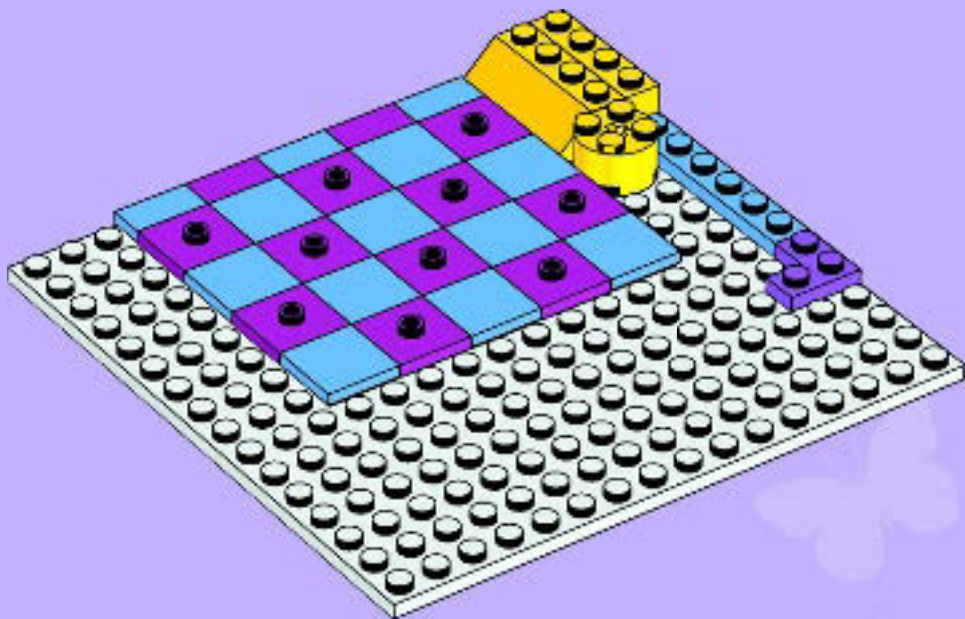



3x



1x



1x

5

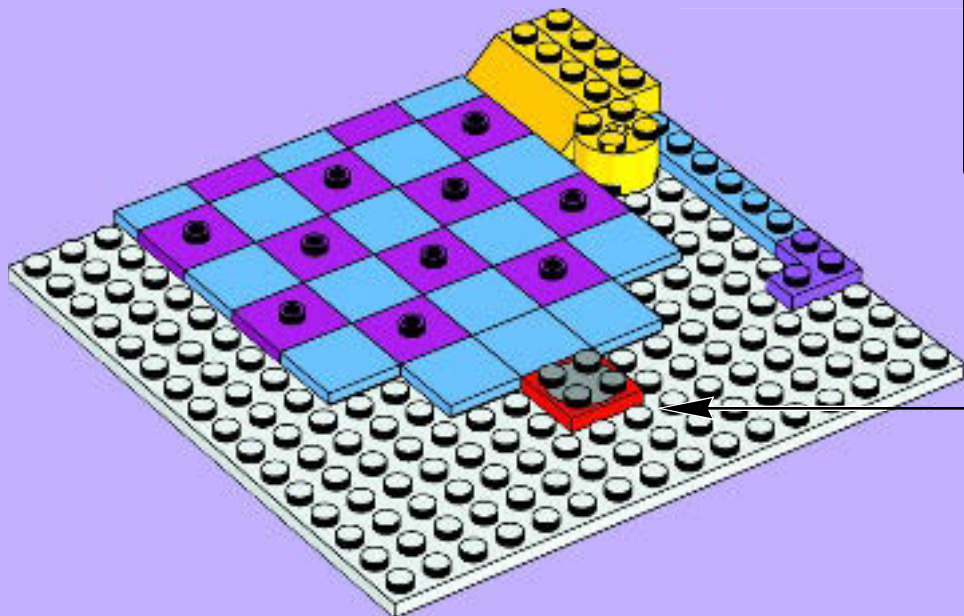



6x



2x

6

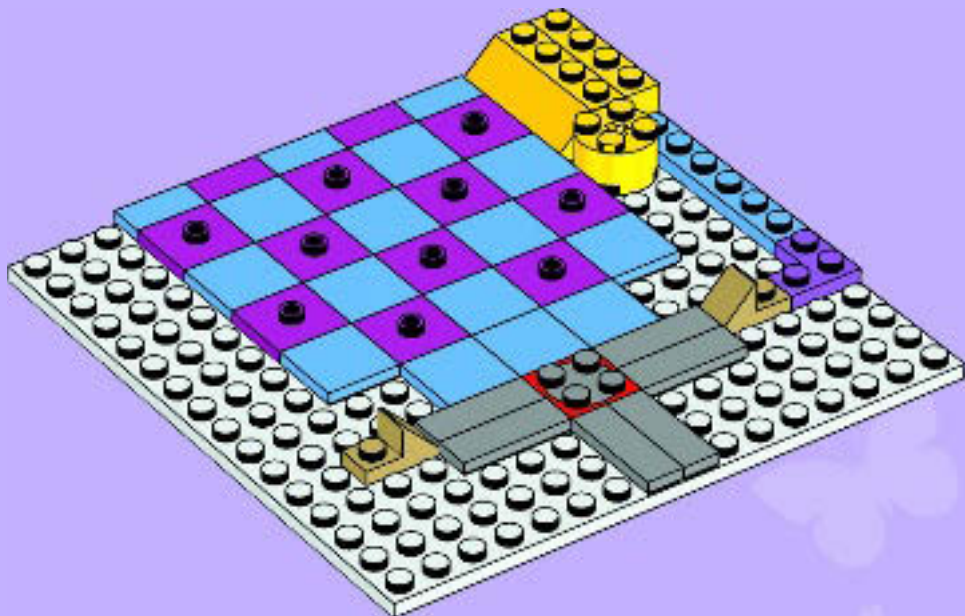

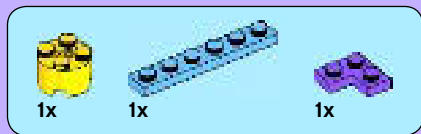

7

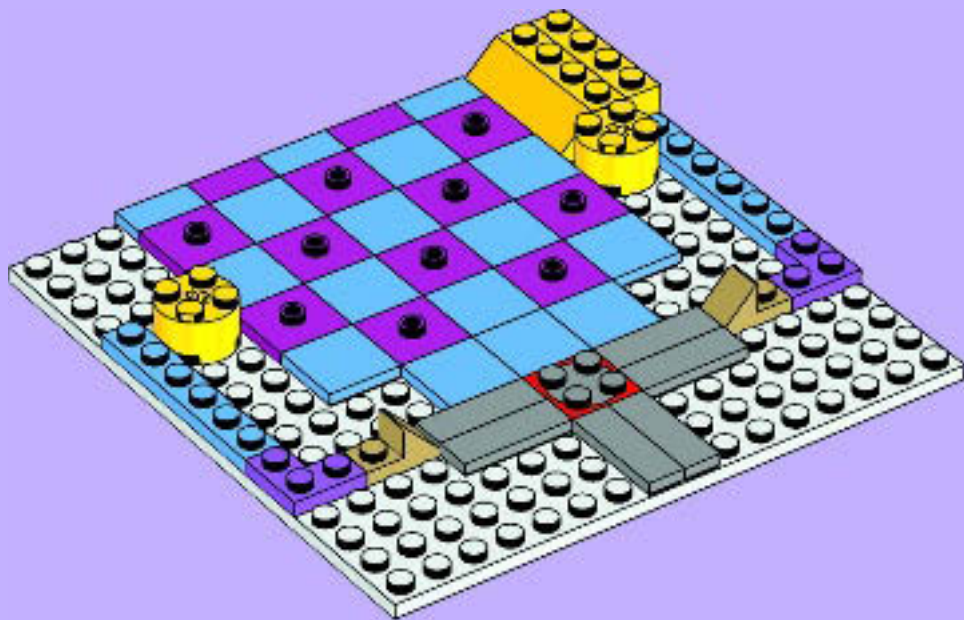



2x



1x

8

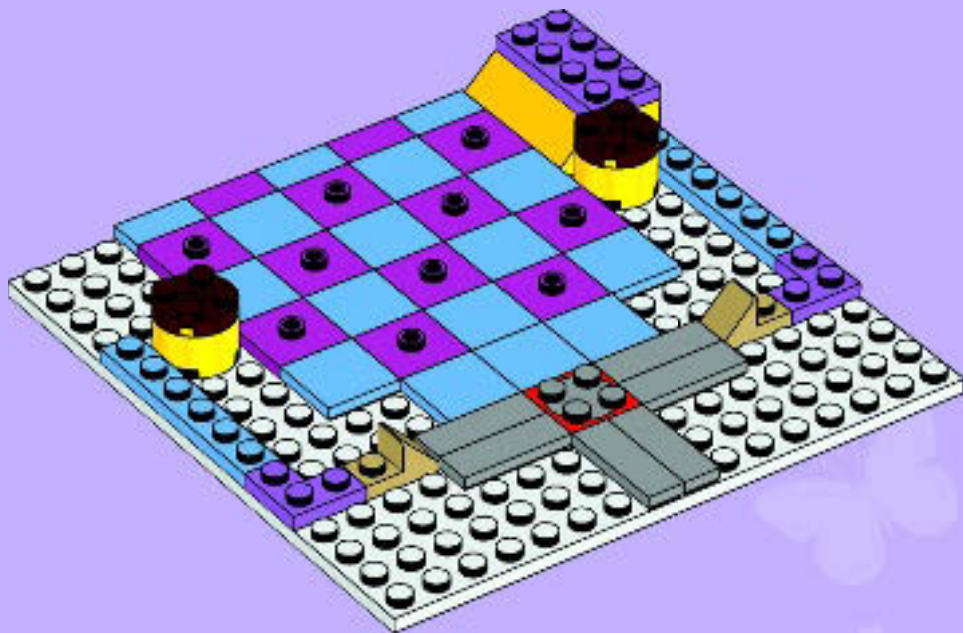



9

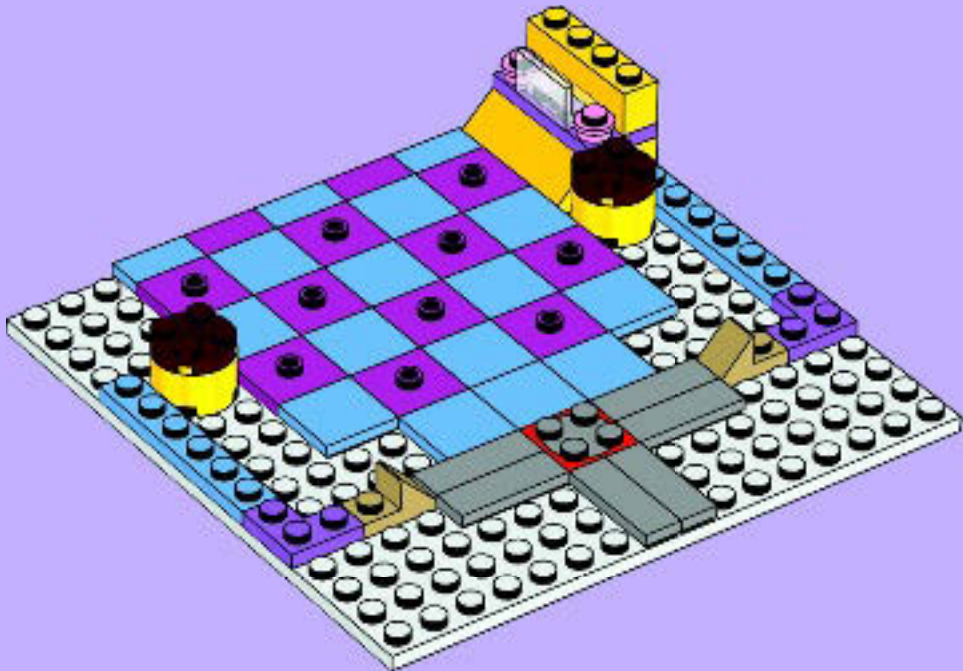

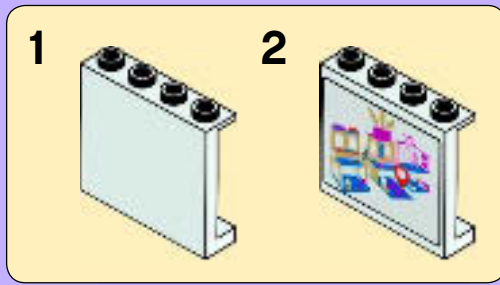
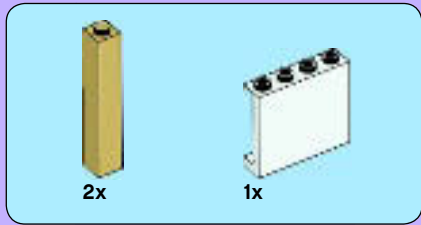

10



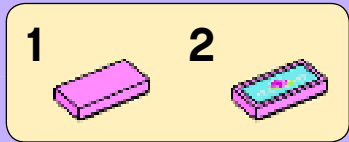
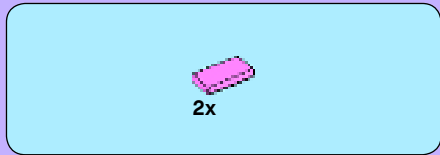

11

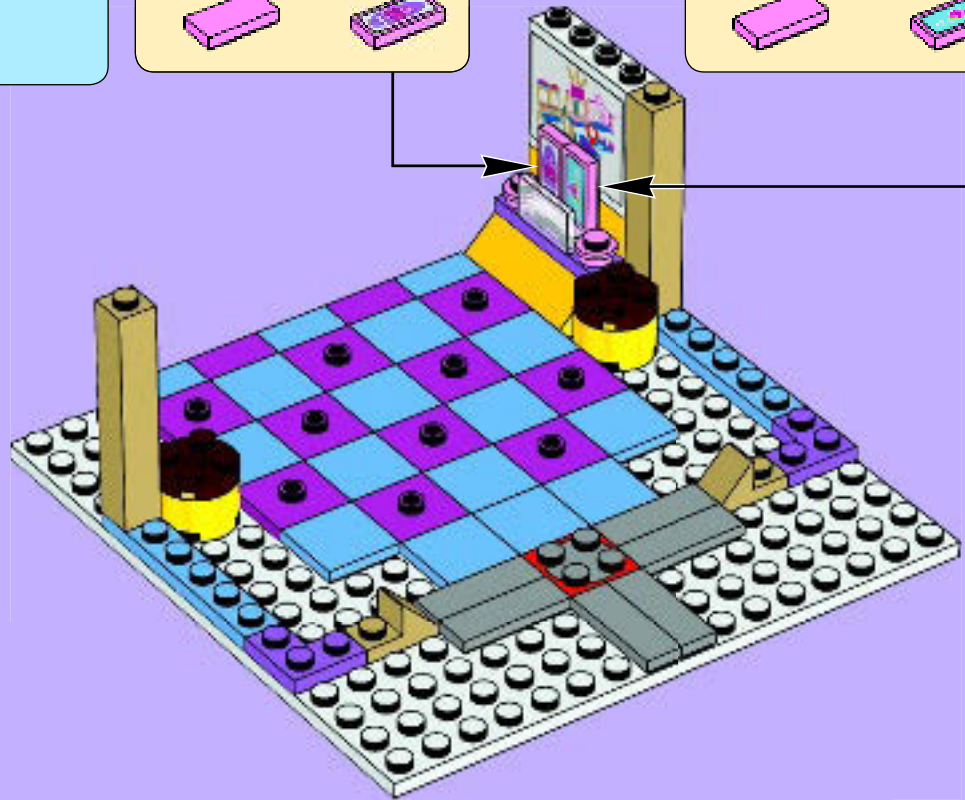

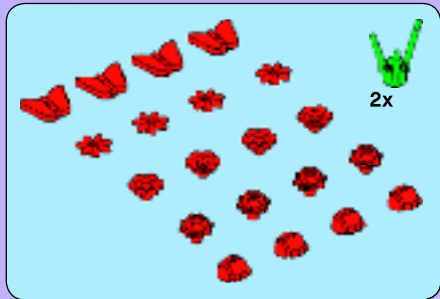

12

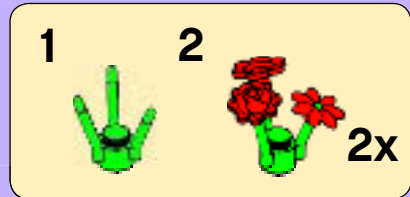

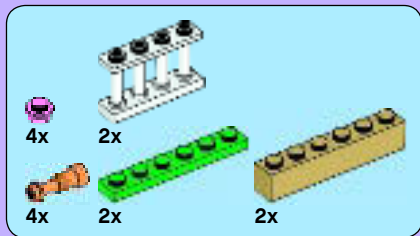

13

1

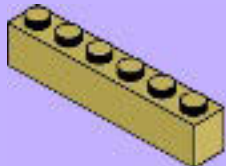

2

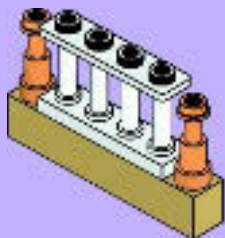

3



4

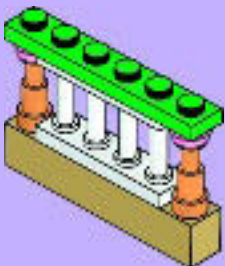

2x

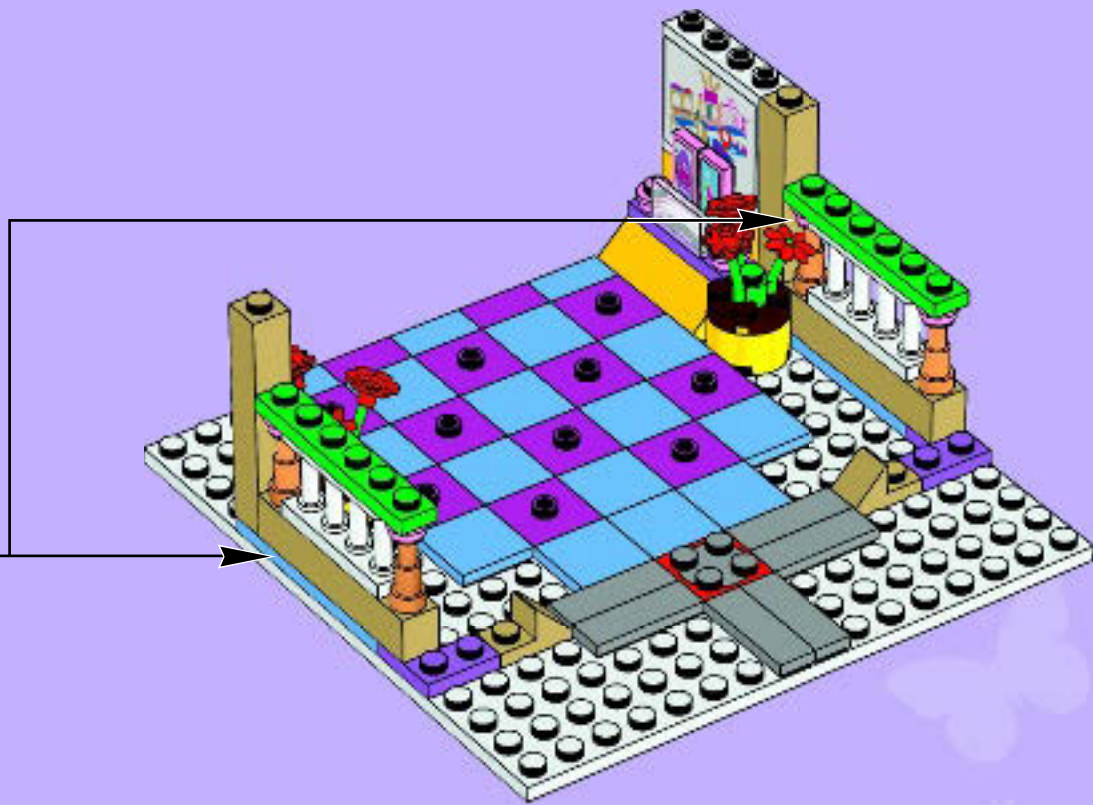

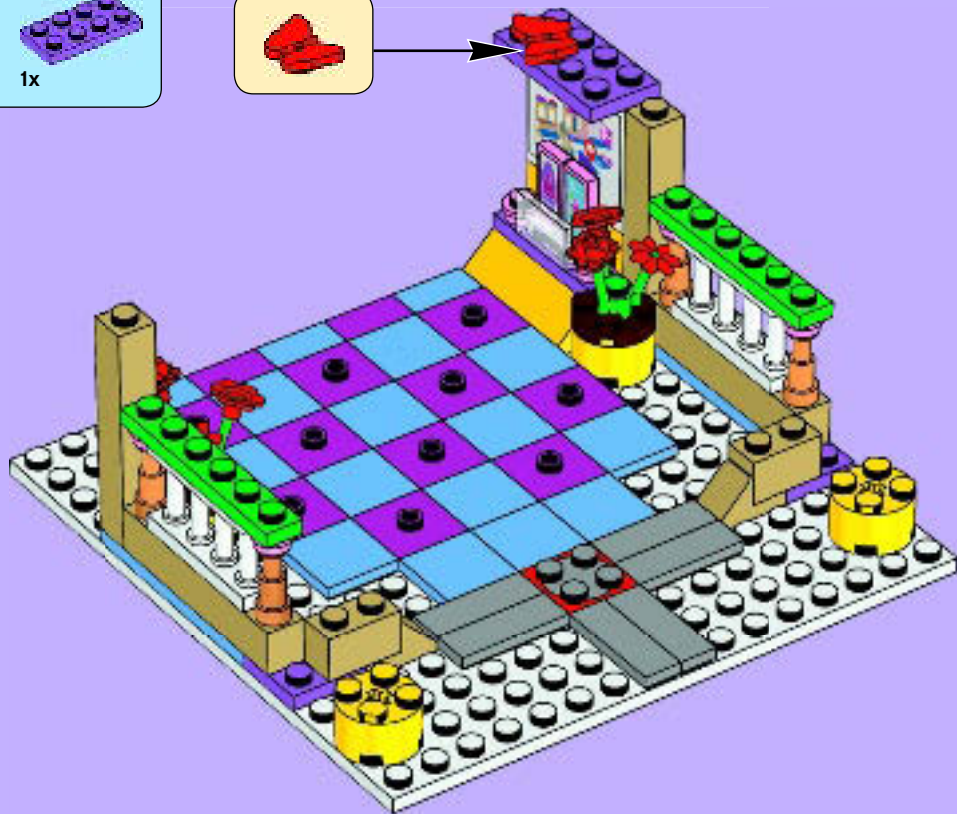

14



15



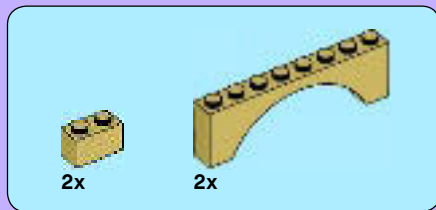

16



4x  2x  2x 

17

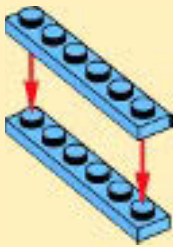

 2x

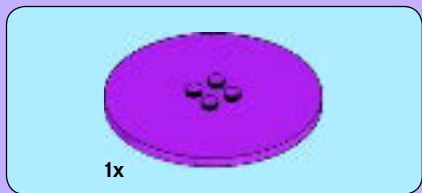

1



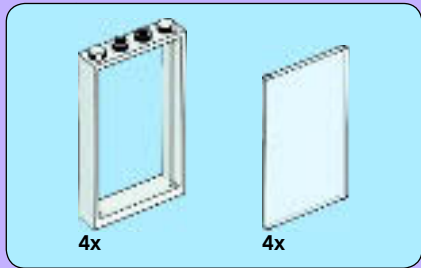

2

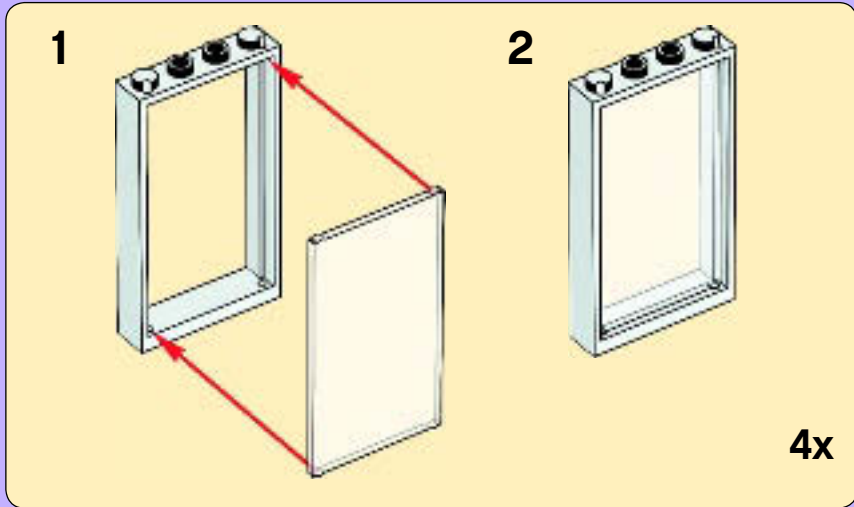

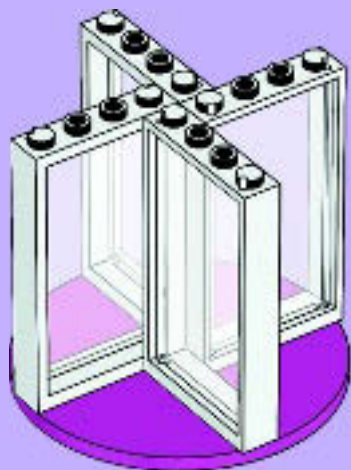

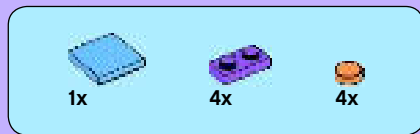

3

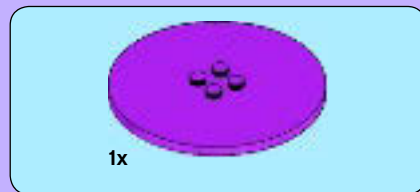
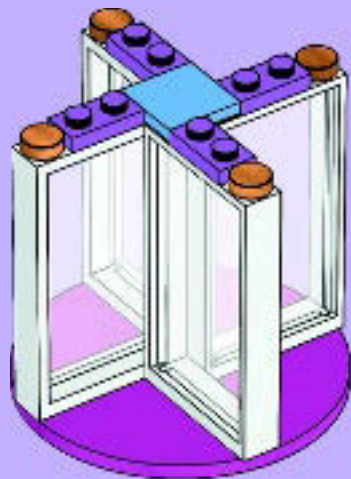

4





1x



1x

5

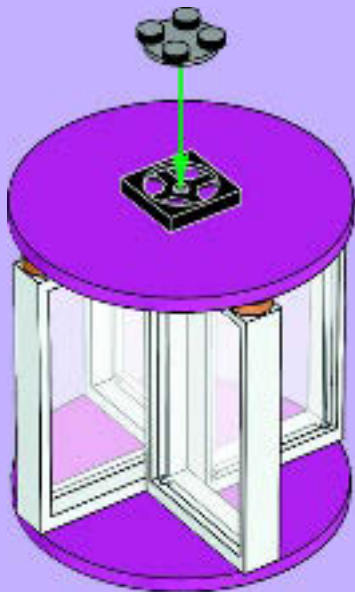

1x

6

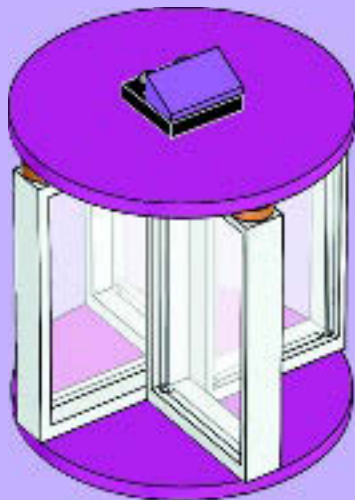

18

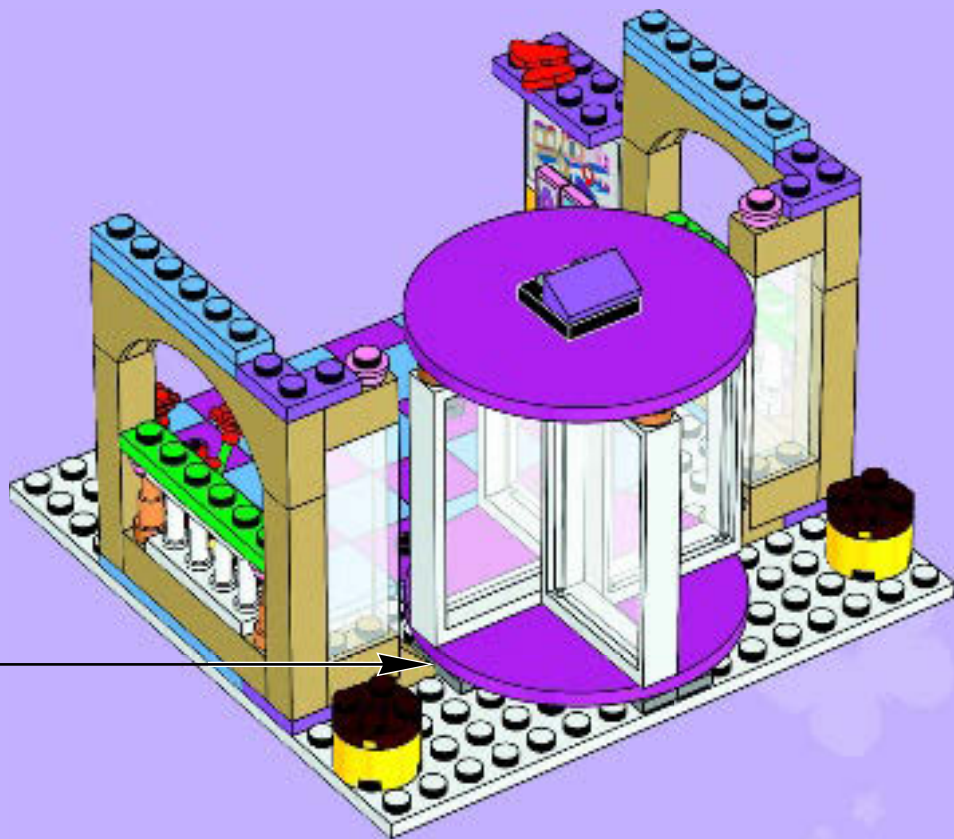

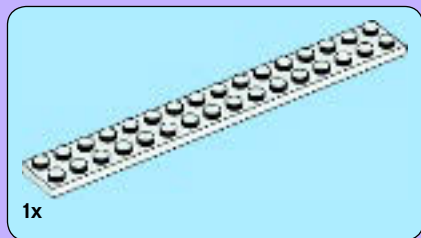

19



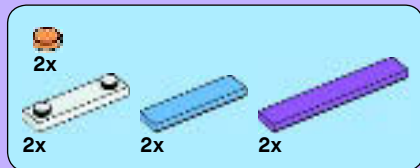

20





2x

21

1



2



2x

