



Friends



41095



 **WARNING: CHOKING HAZARD.**
Toy contains small parts and a small ball.
Not for children under 3 years.

LEGO.com/friends

Инструкция ЛЕГО (Lego) 41095-2

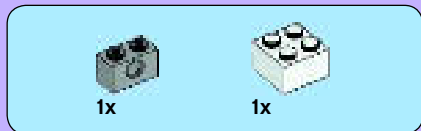
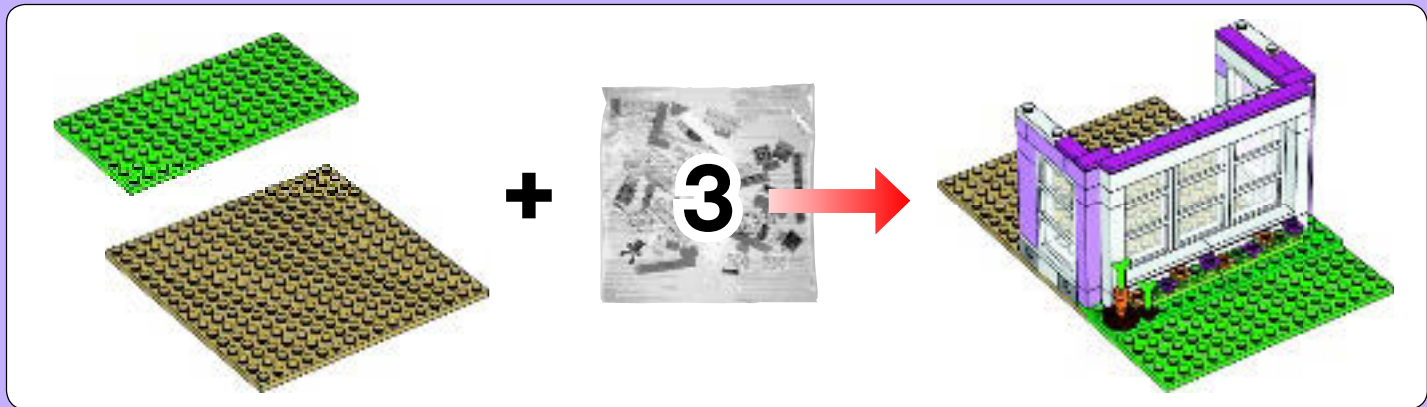

1

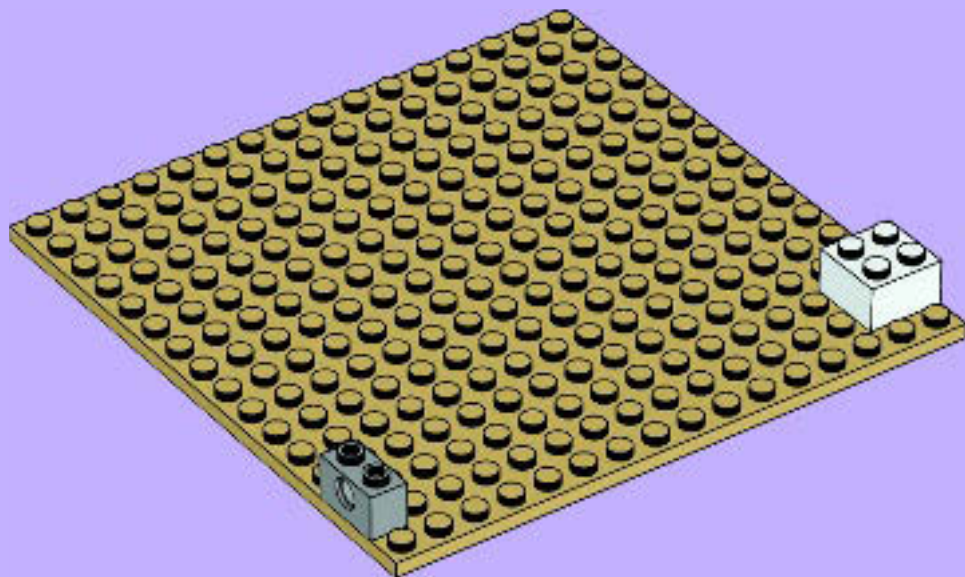

2

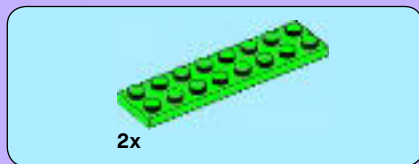

2



AVERTISSEMENT : RISQUE D'ÉTOUFFEMENT.
Le jouet contient des petites pièces ainsi qu'une petite boule.
Il ne convient pas aux enfants de moins de 3 ans.



ADVERTENCIA: PELIGRO DE ASFIXIA.
Juguete que contiene partes pequeñas y una pelota pequeña.
No recomendado para niños menores de 3 años.

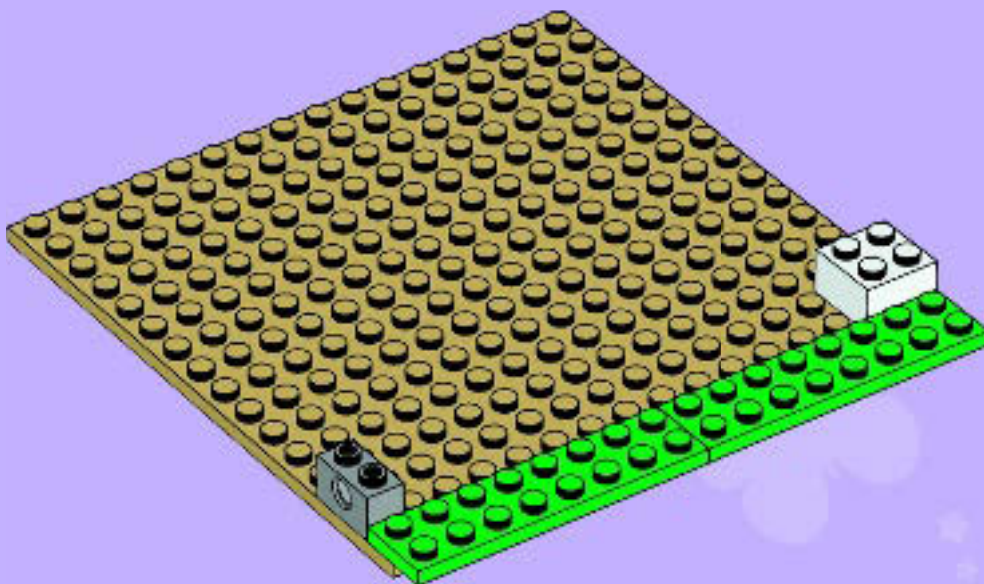



3

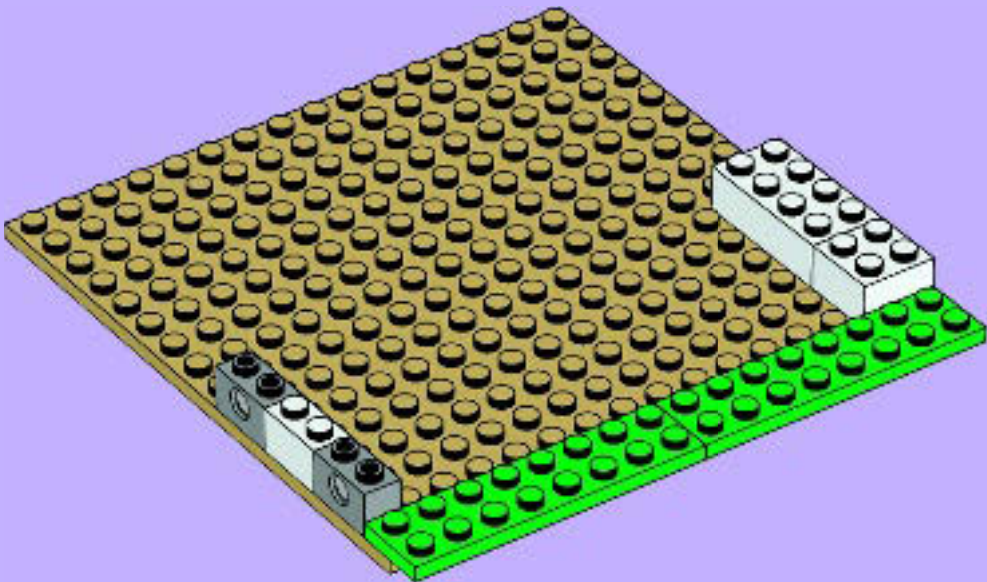

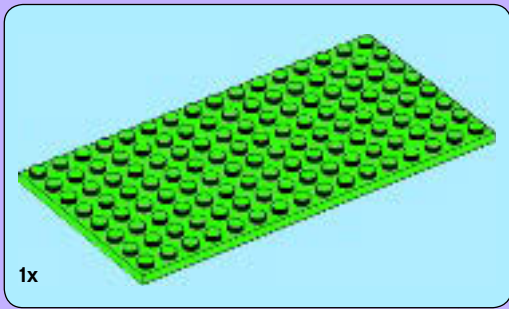

4

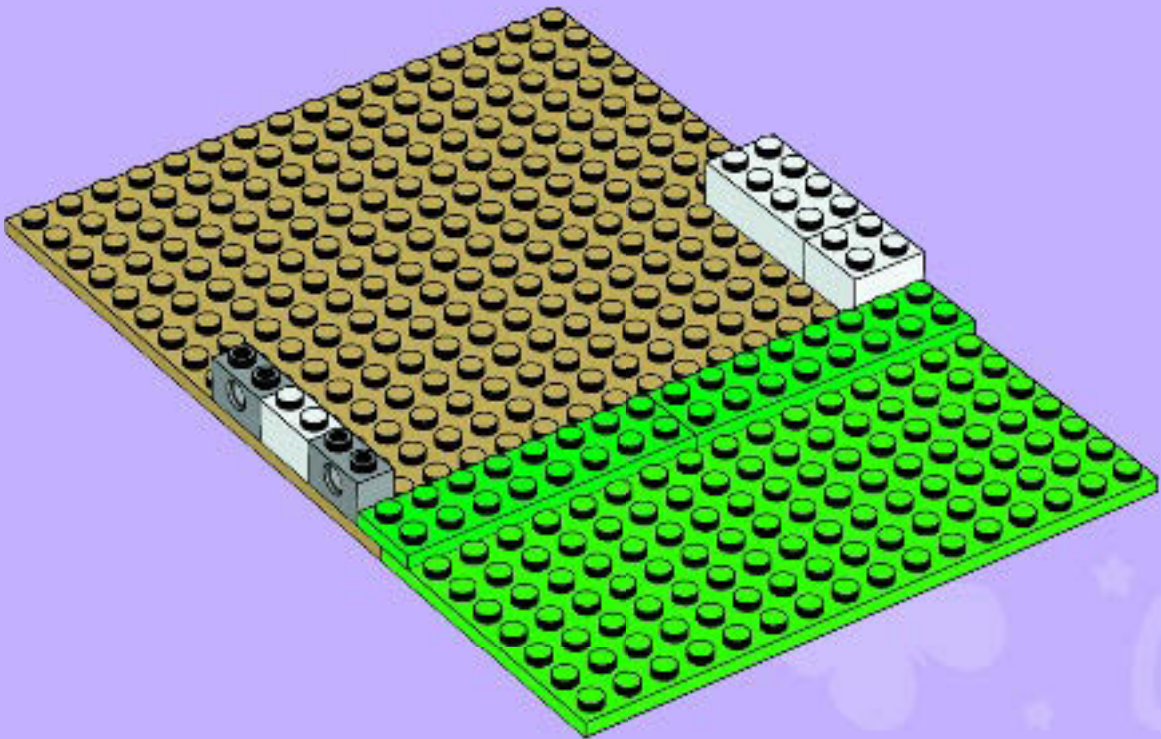

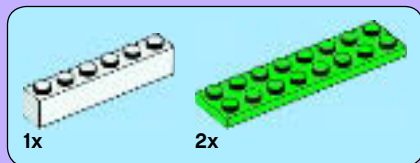

5

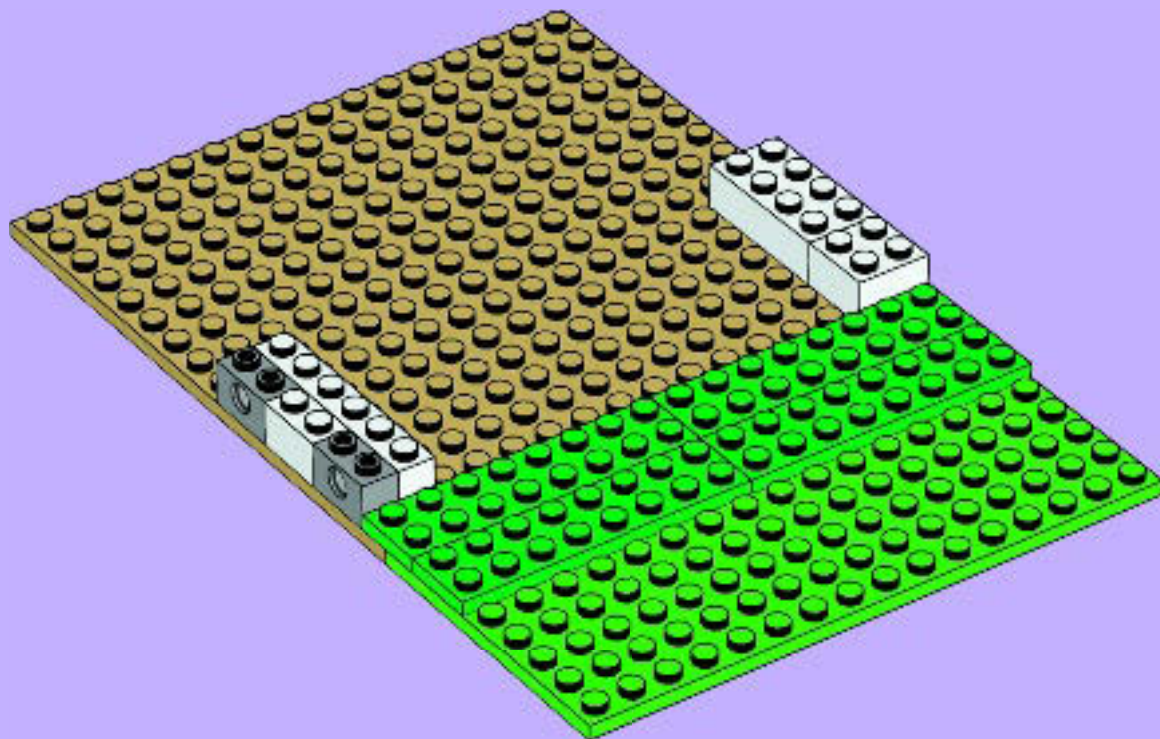



6

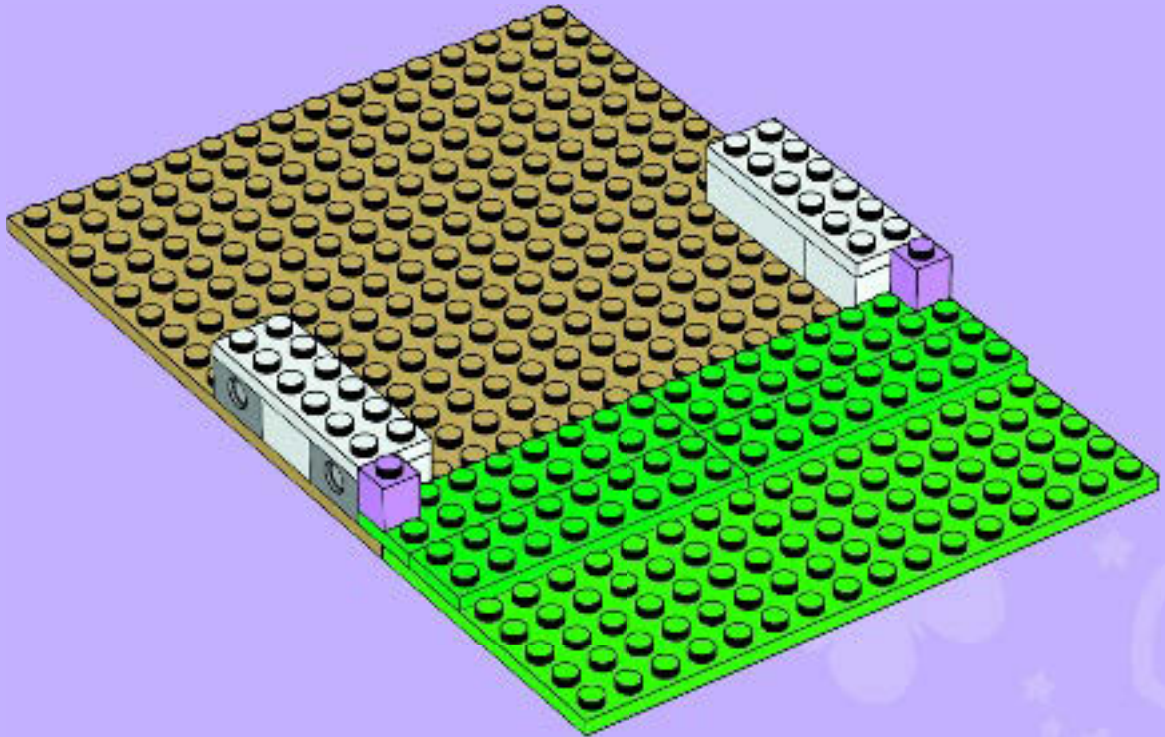

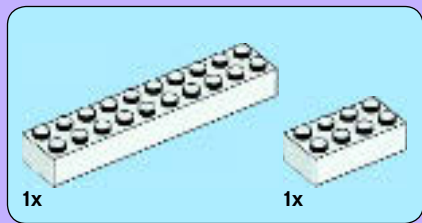

7

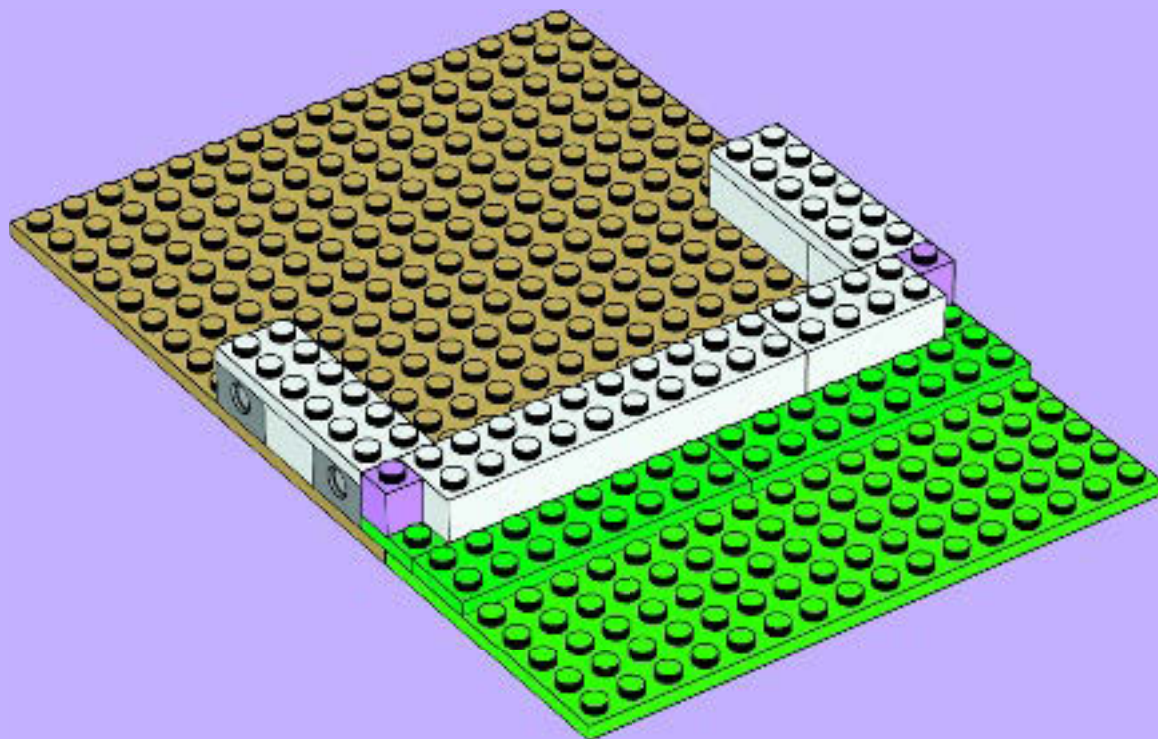



8



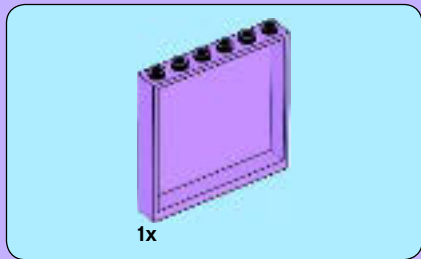

9

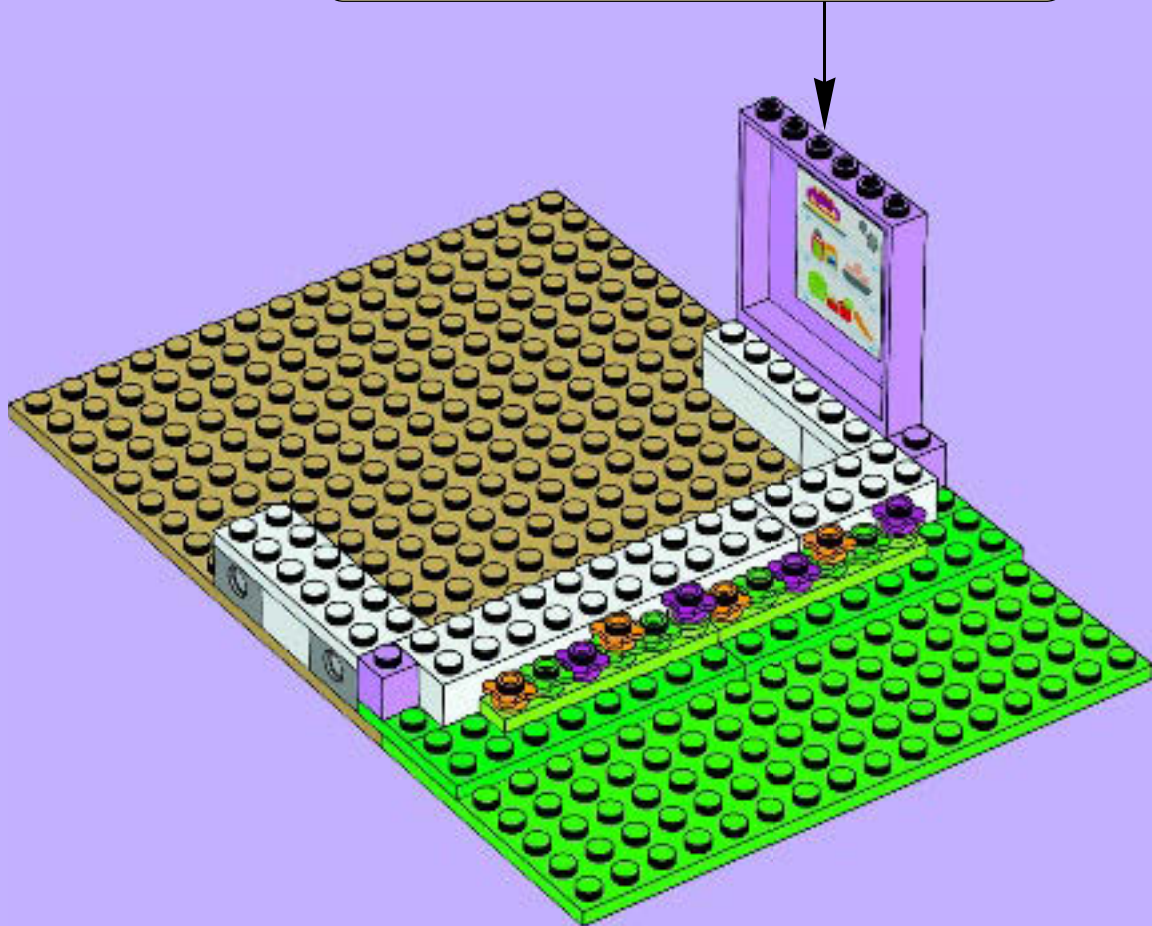
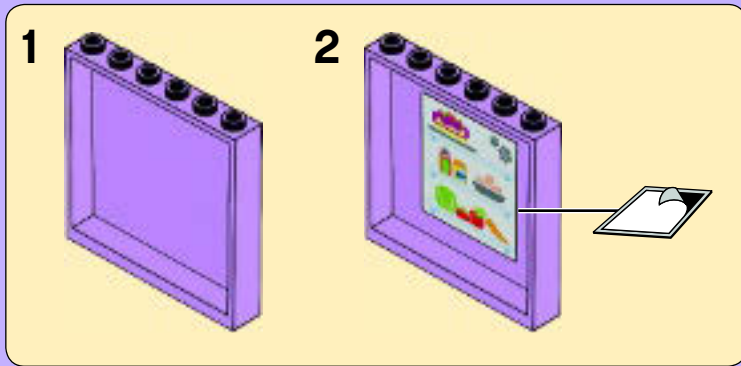

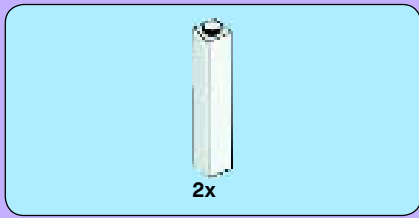

10

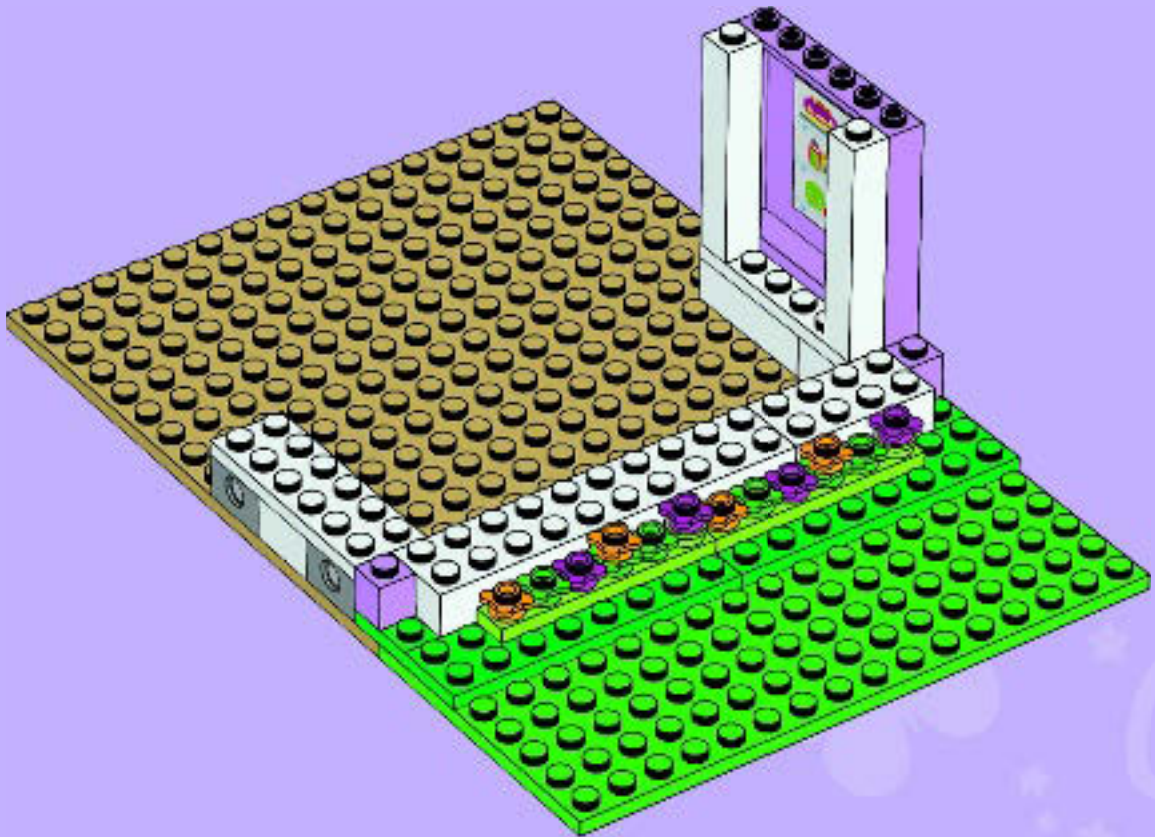

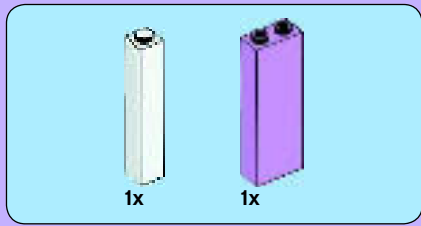

11

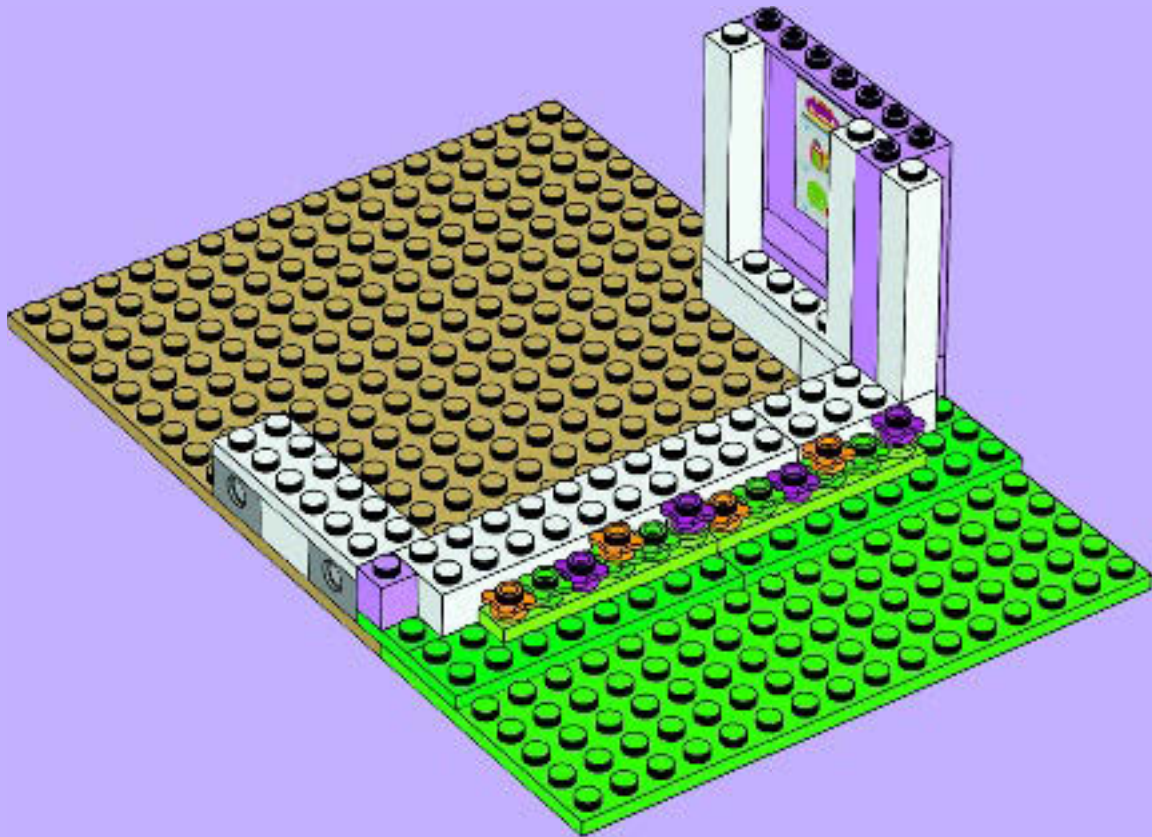

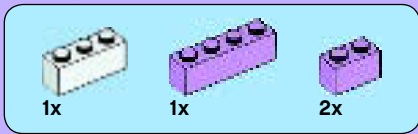

12

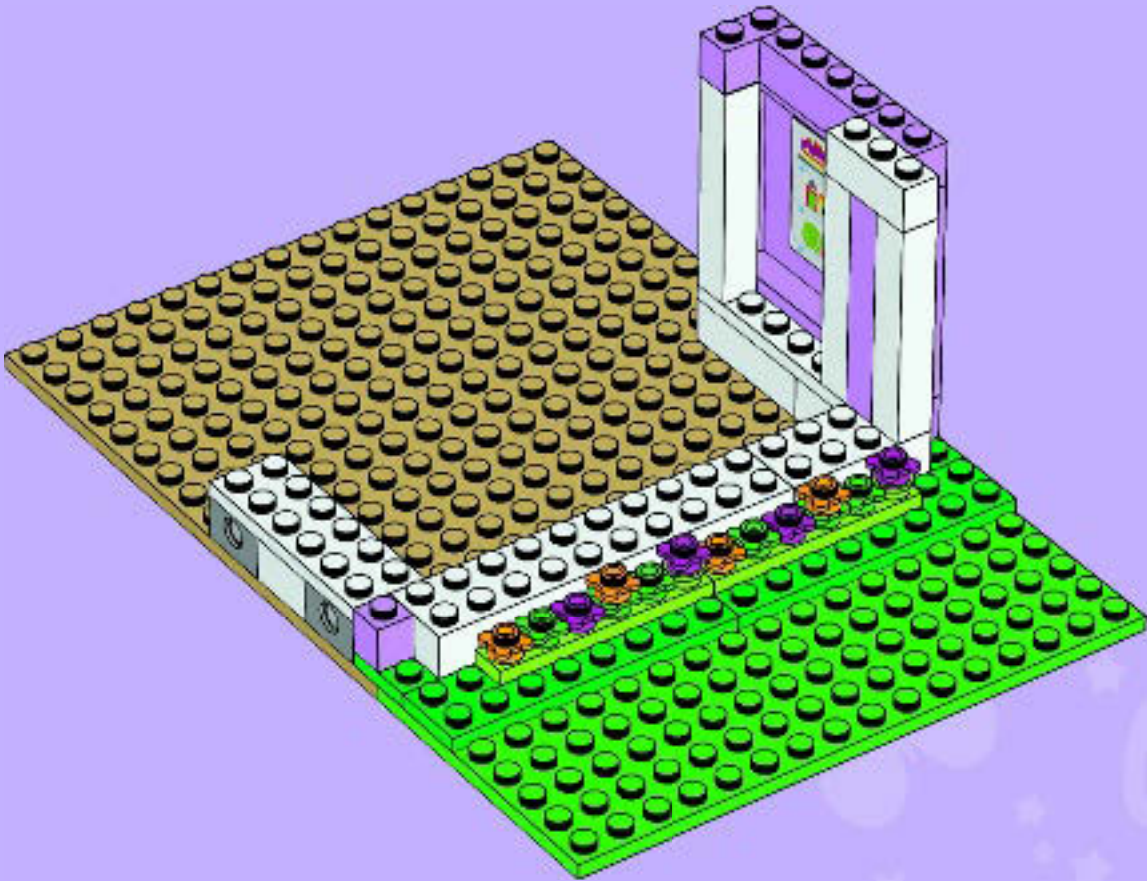

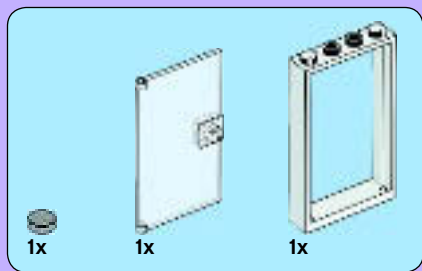

13

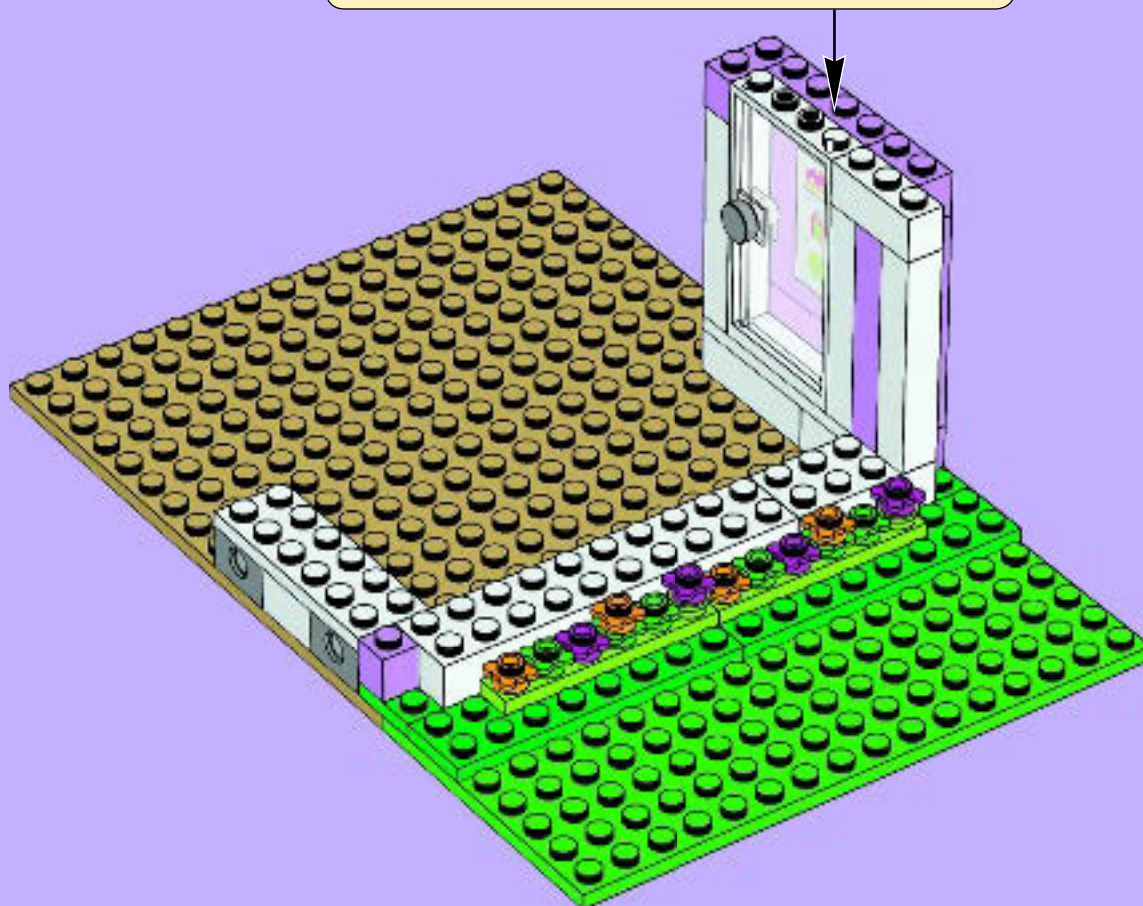
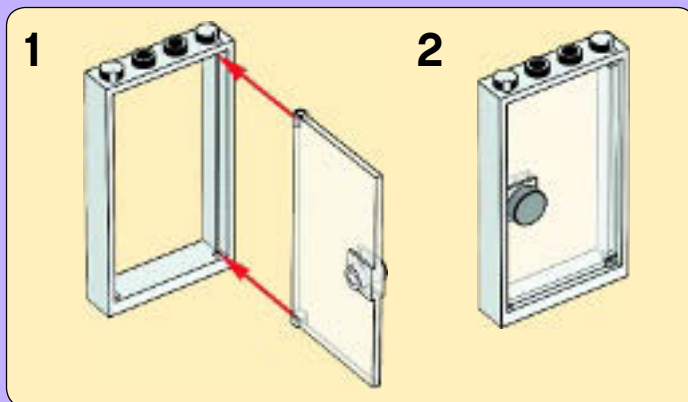



14

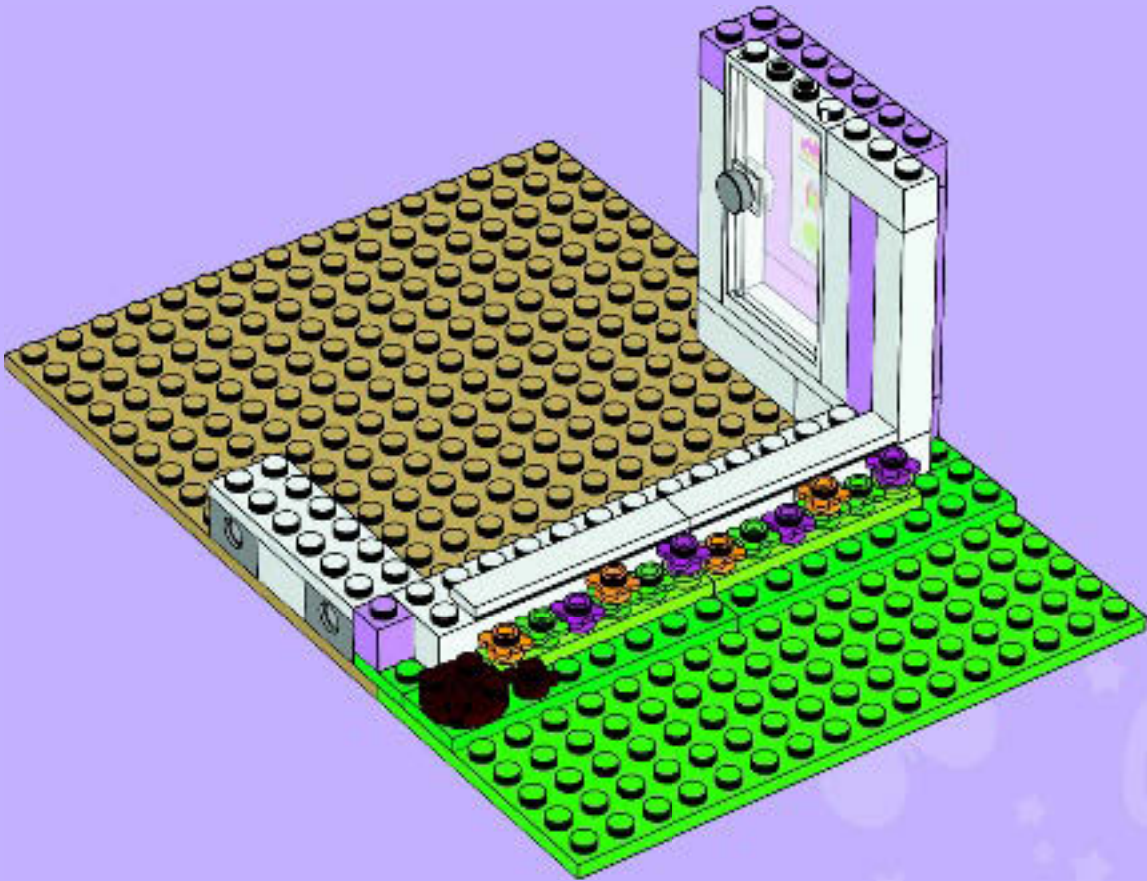

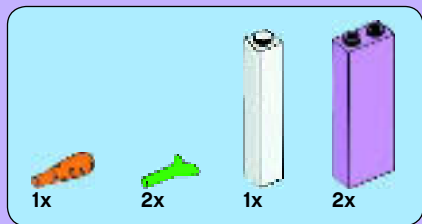

15

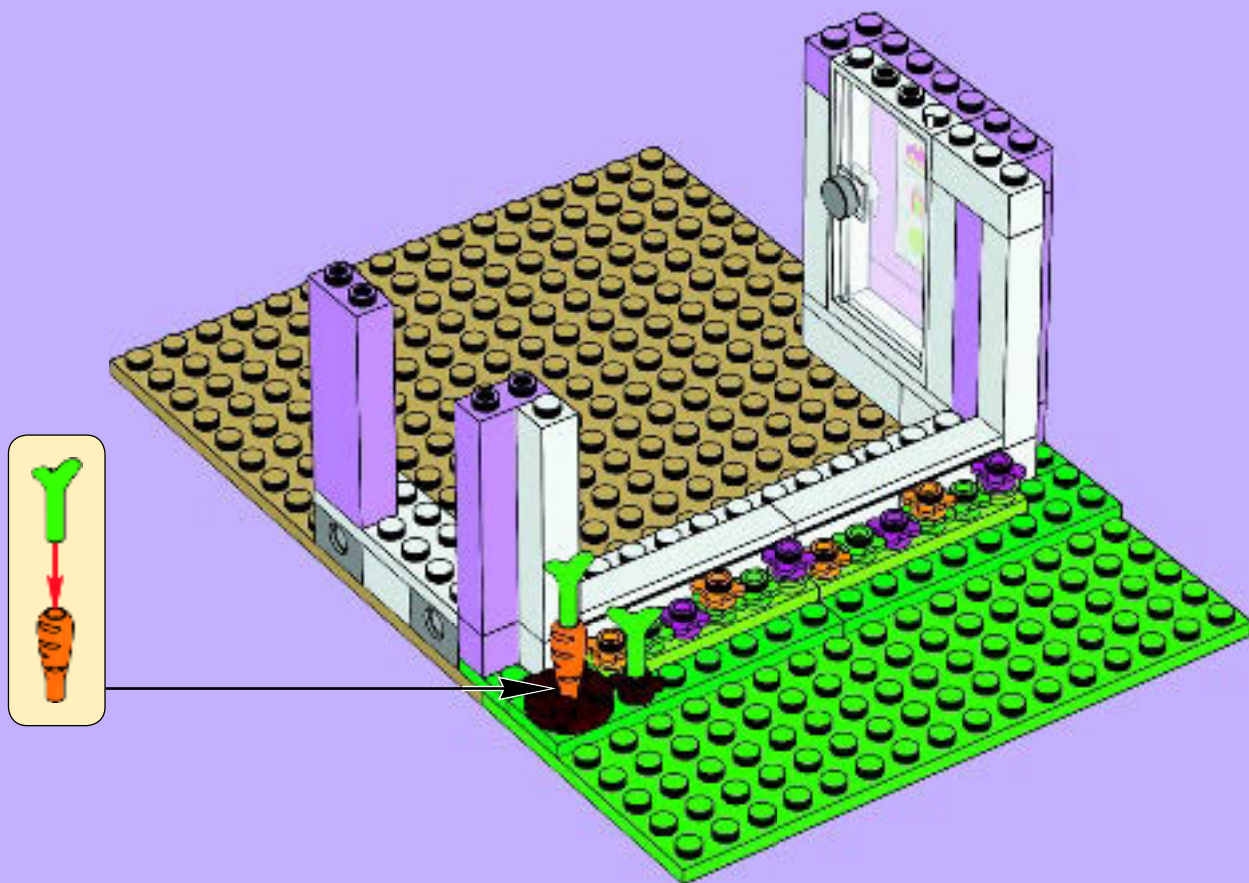

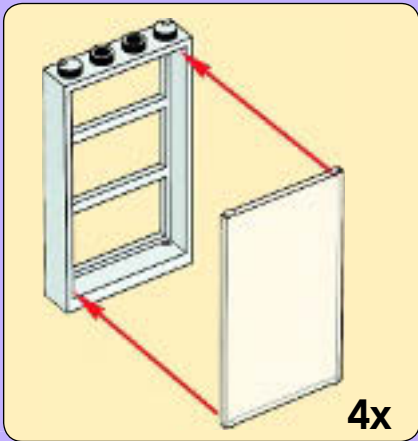
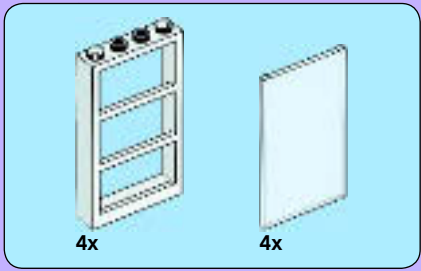

16

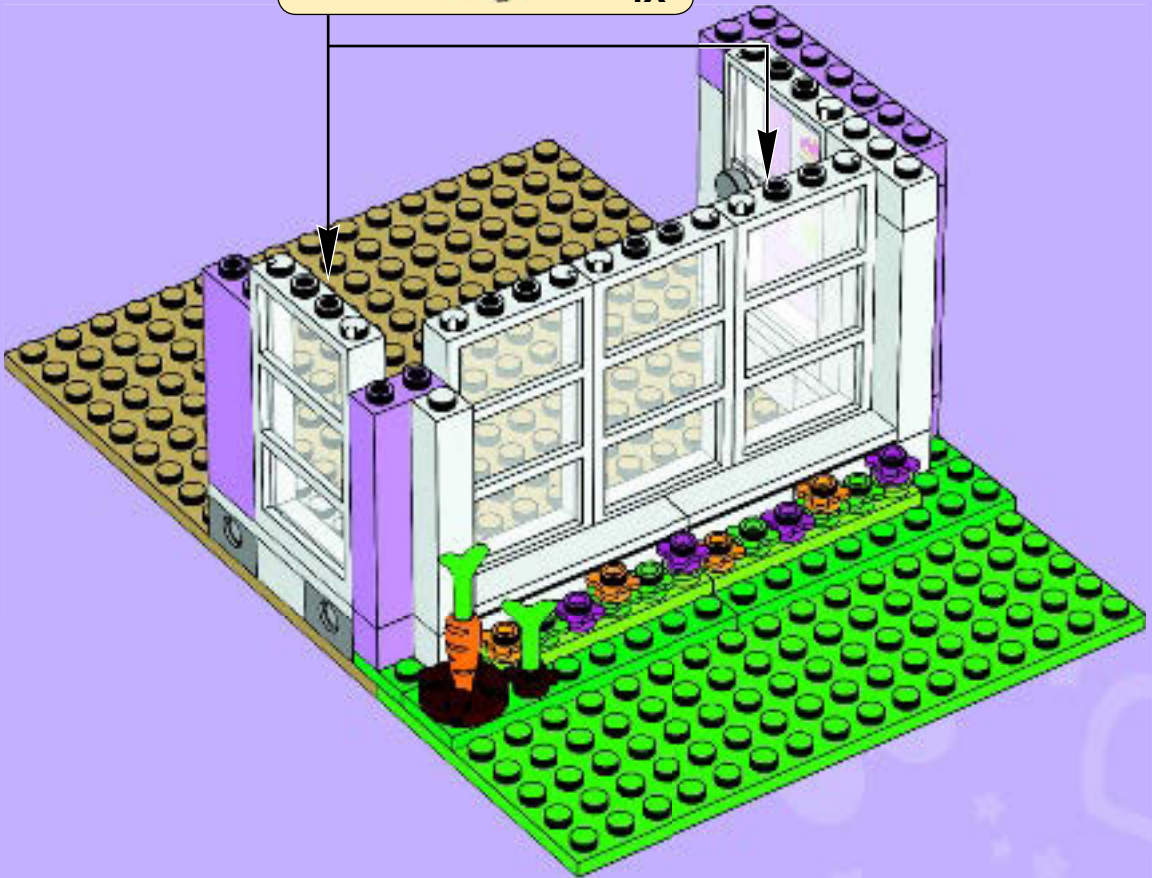



17

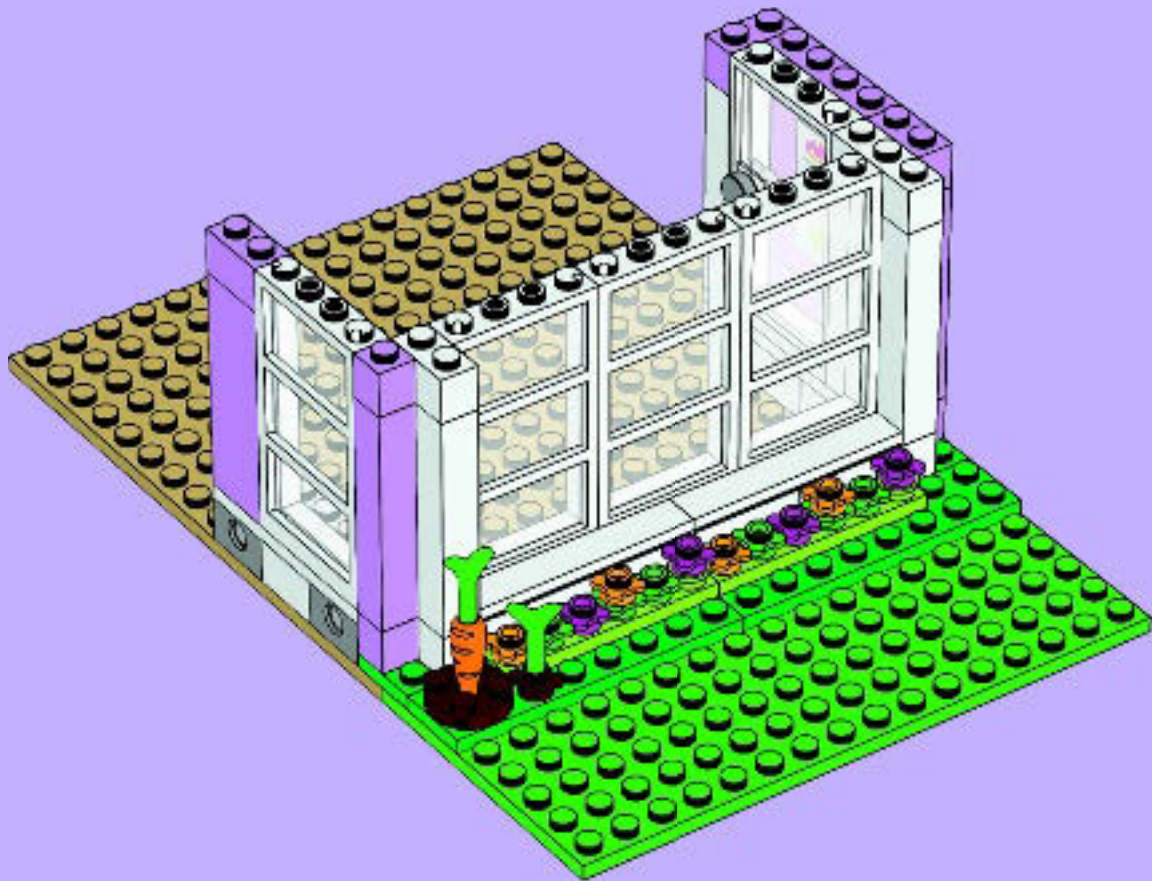

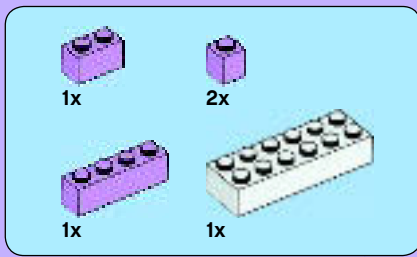

18

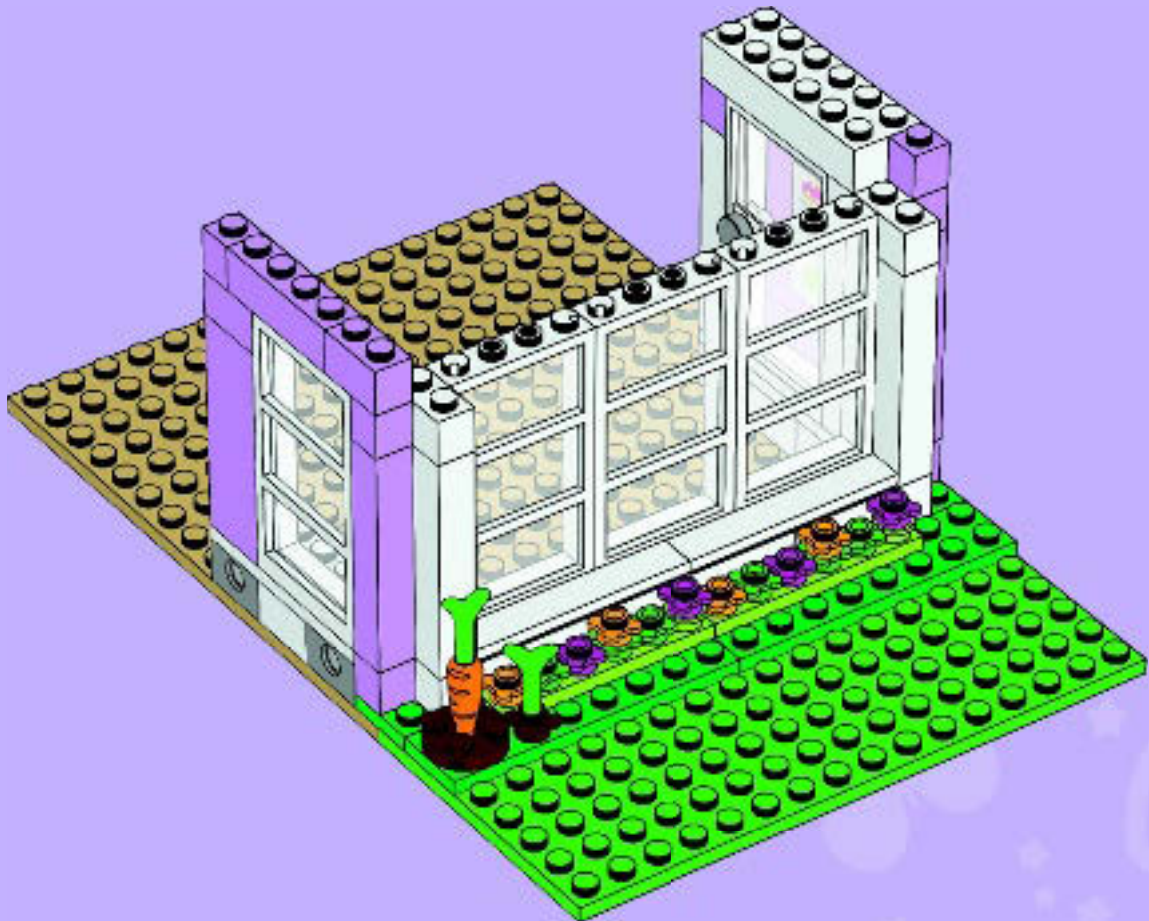

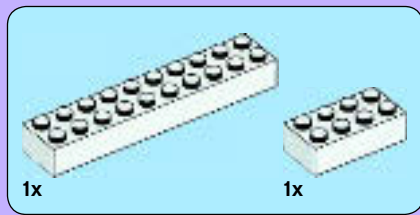

19





2x



2x

20

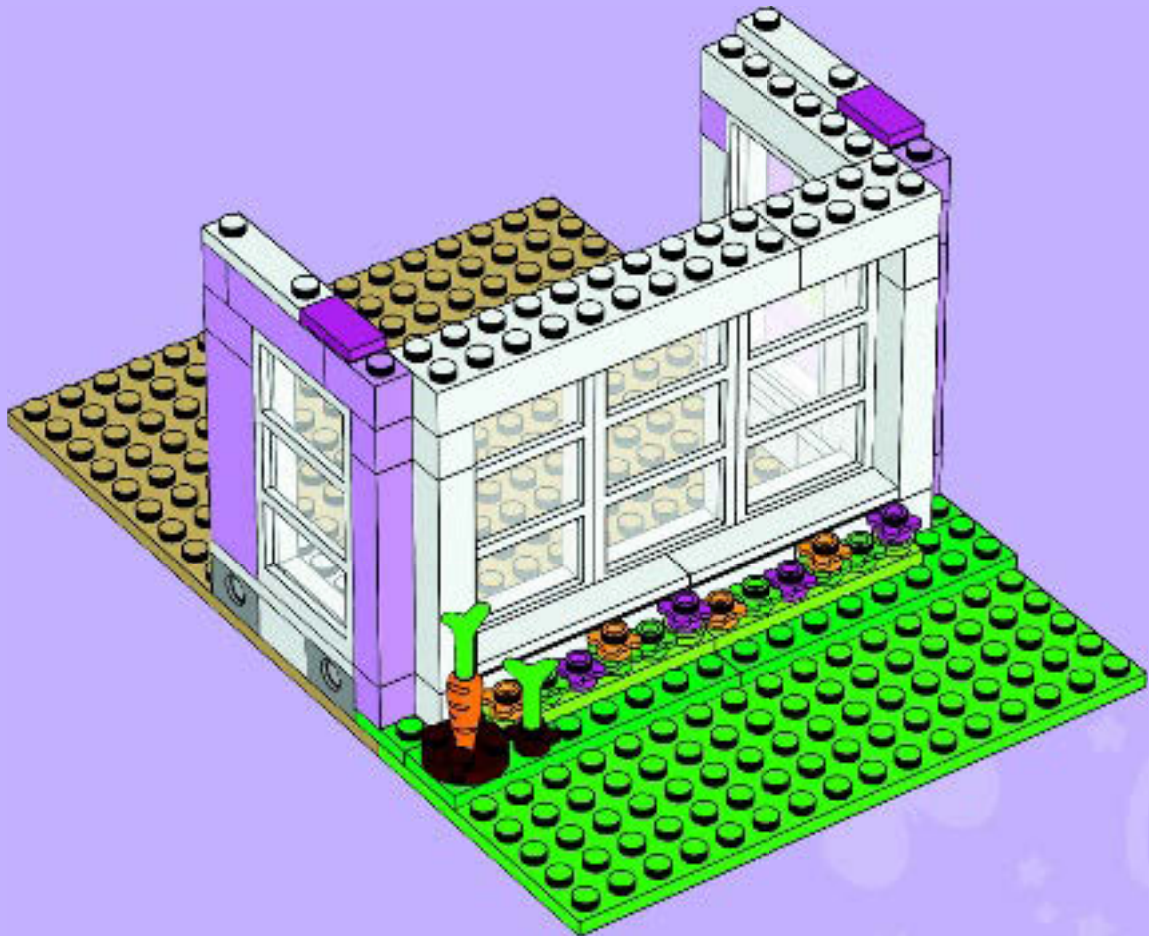

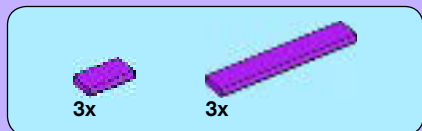

21



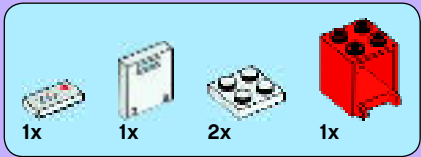
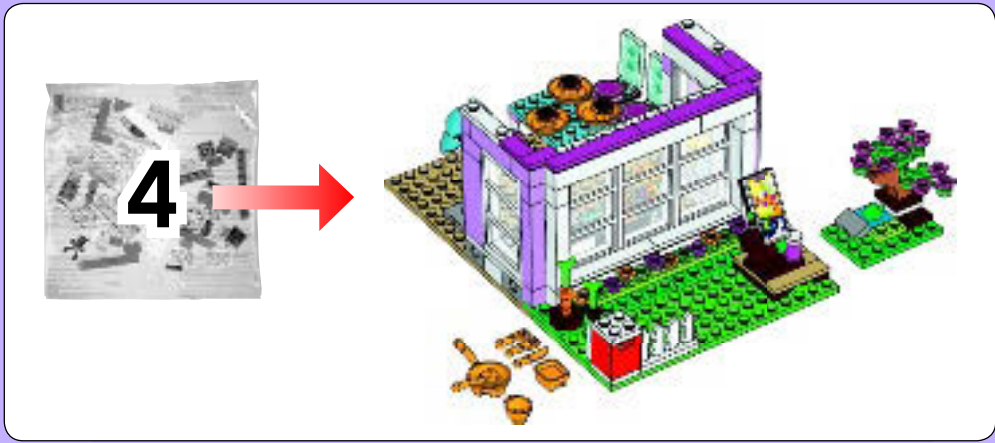

22

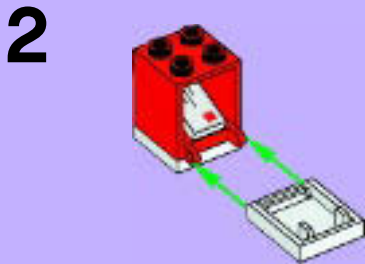



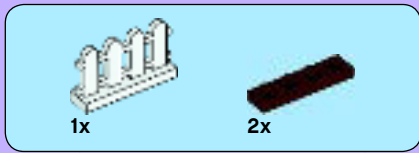

23





4x

24



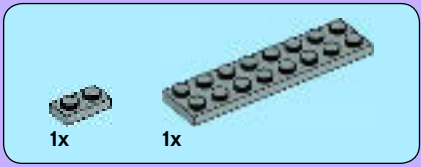

1

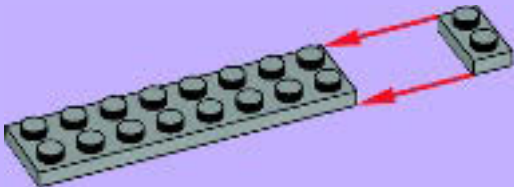

2

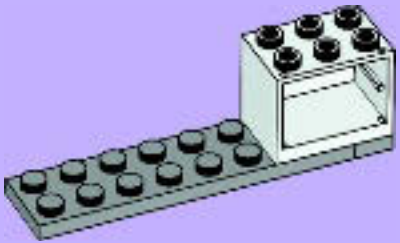

3

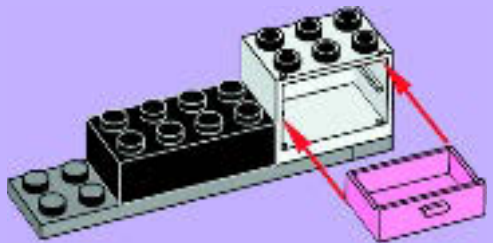

4

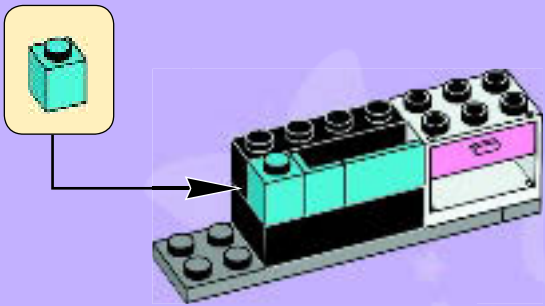

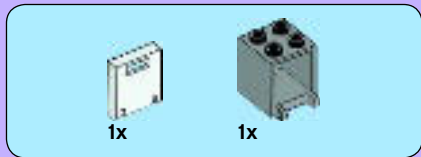

5

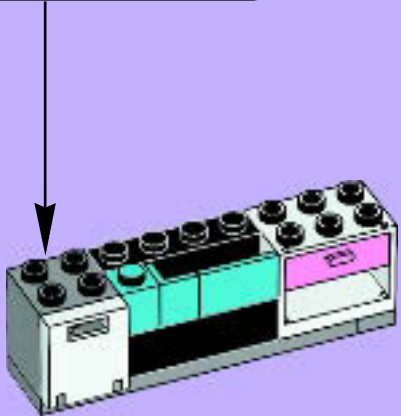
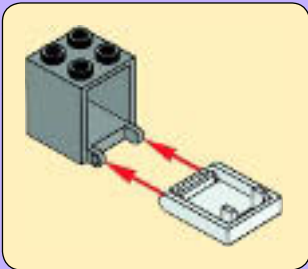

6

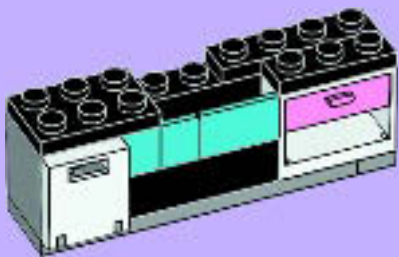

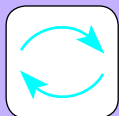



26

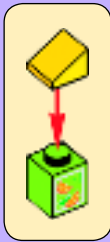
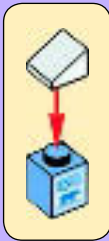

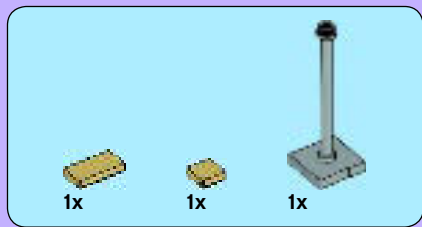

27



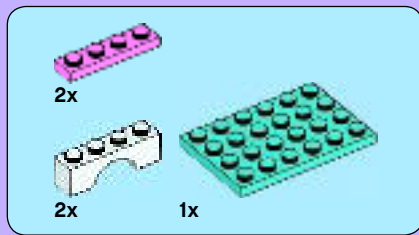

28

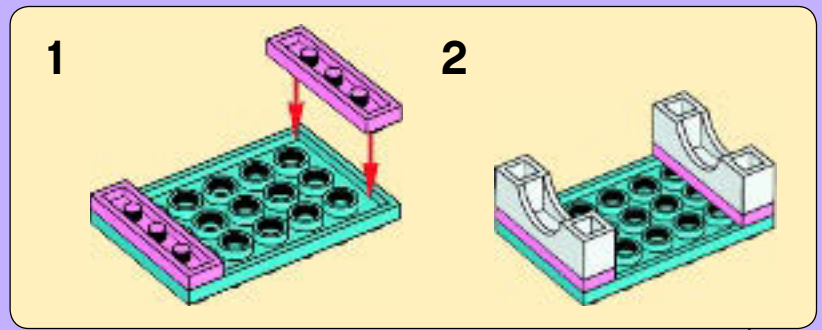



1x



1x

29

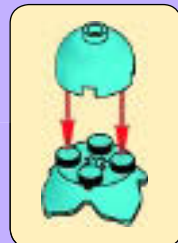



3x



6x



3x



3x

30

1



2



3



4



3x





3x

31

1



2



3x





1

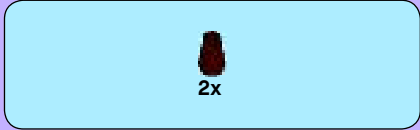

2

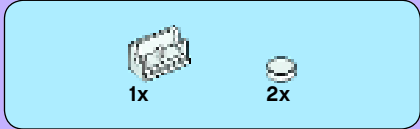

3



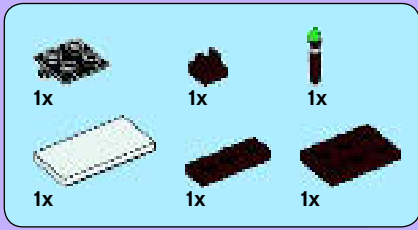

4

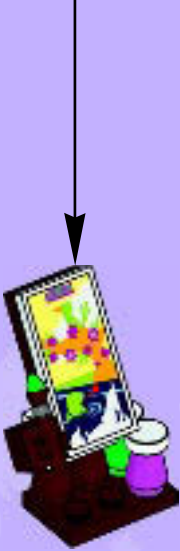
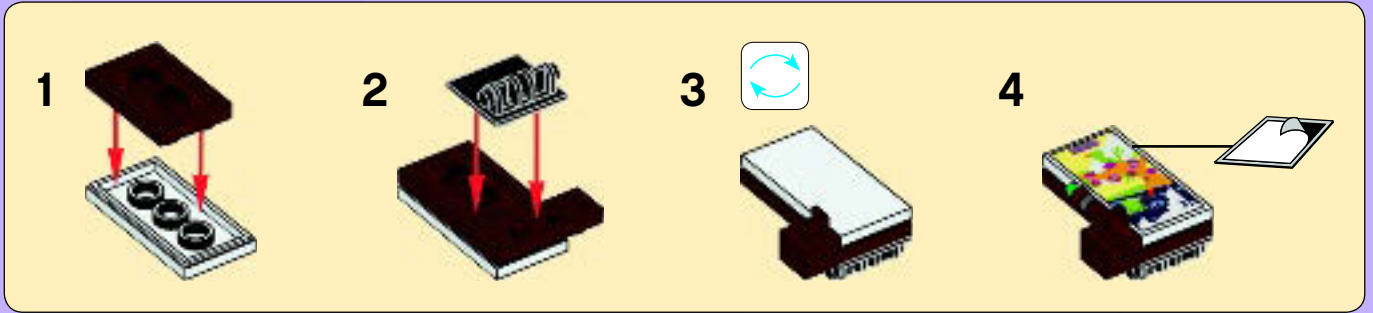



1



2



3

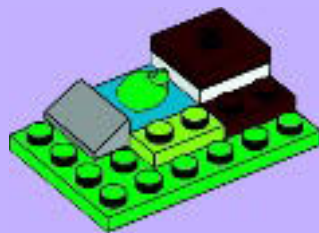

4





5



6

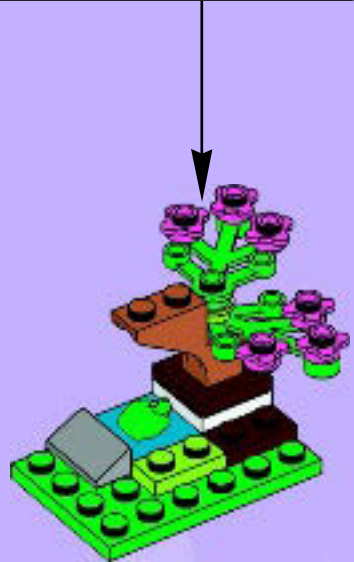
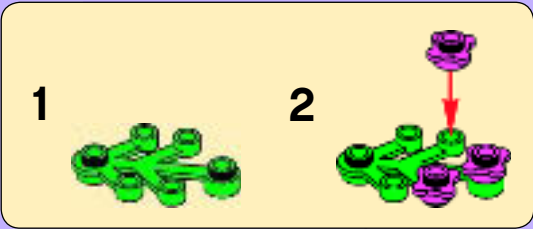



7



8

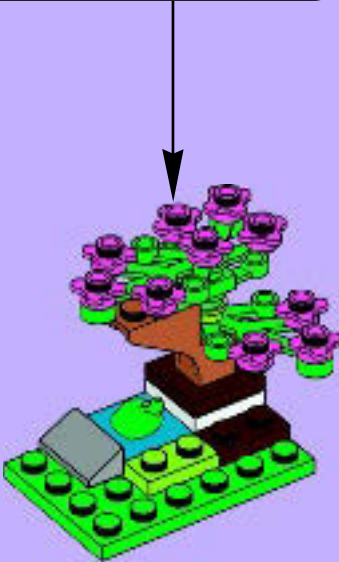
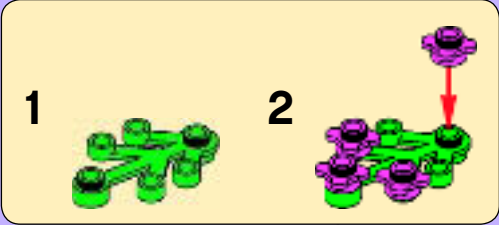

32

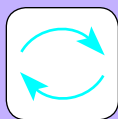



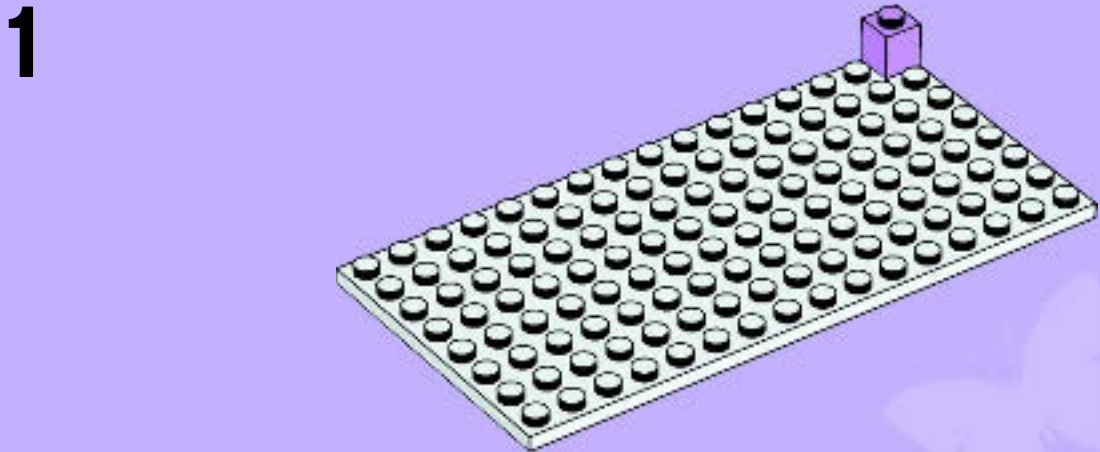
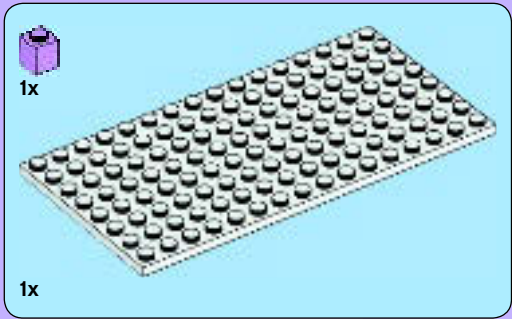
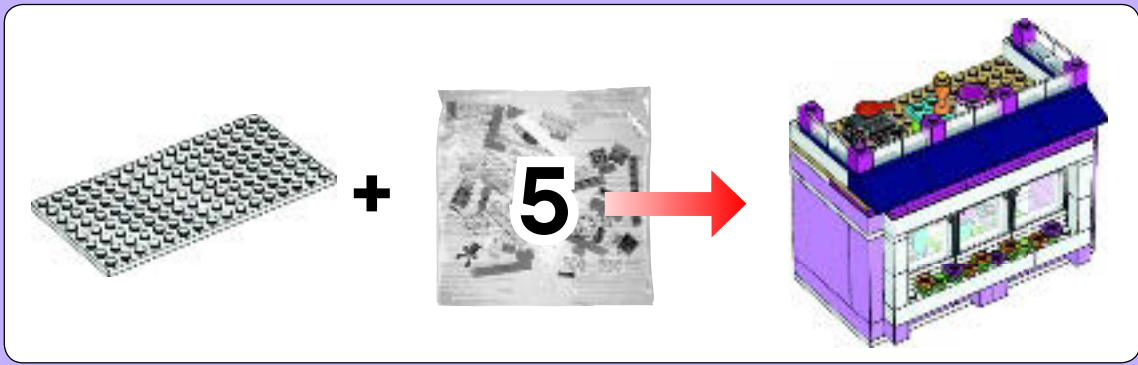



2

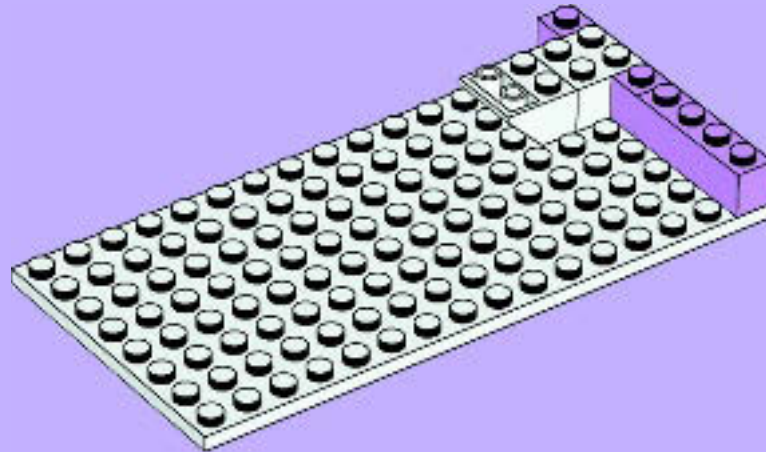

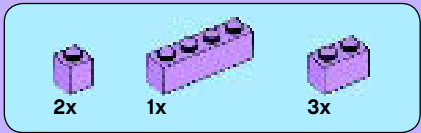

3

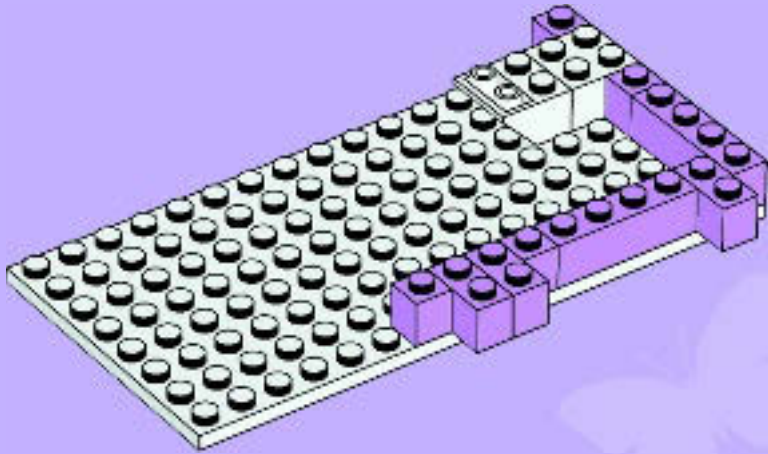

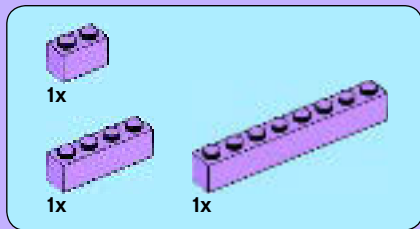

4

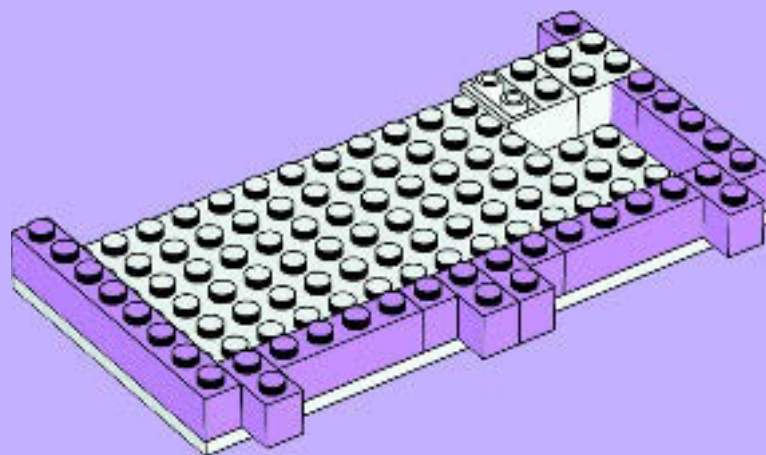

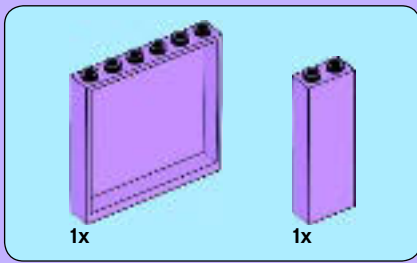

5

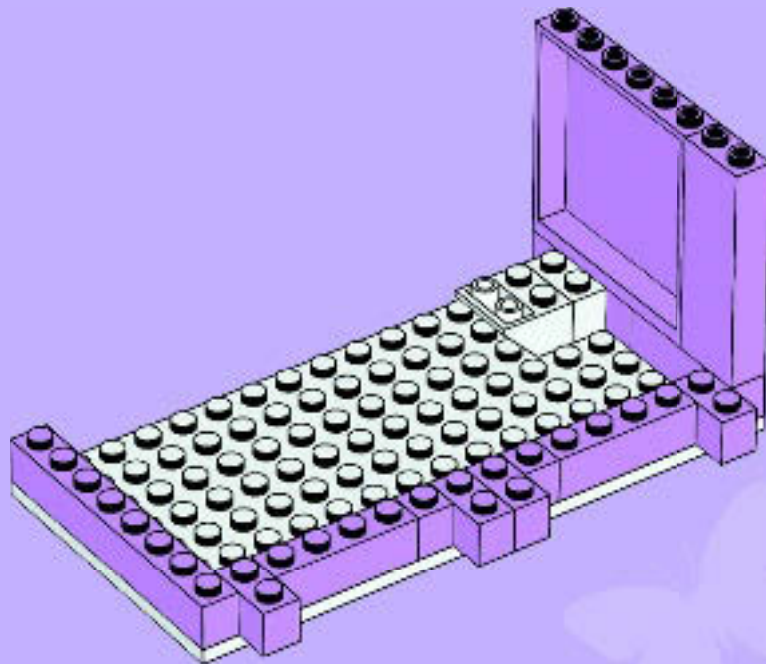

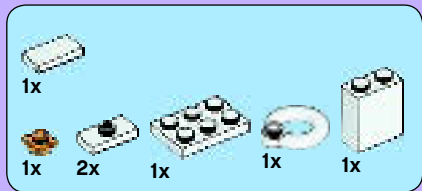

6

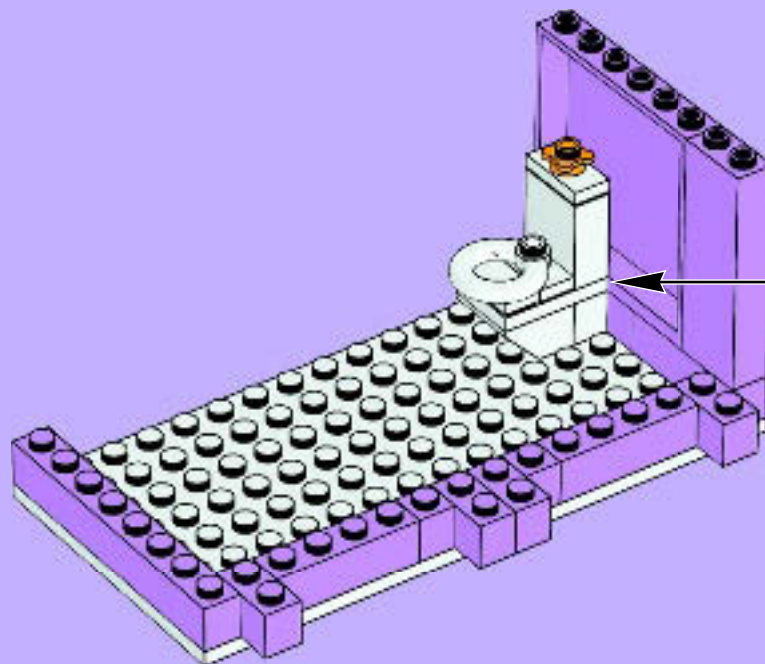
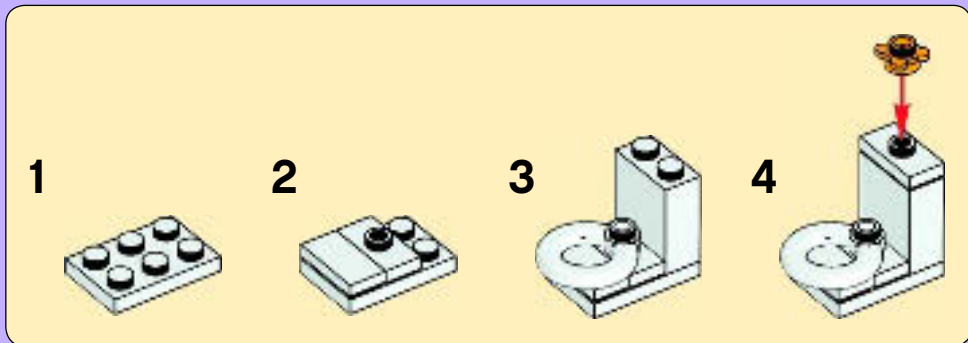

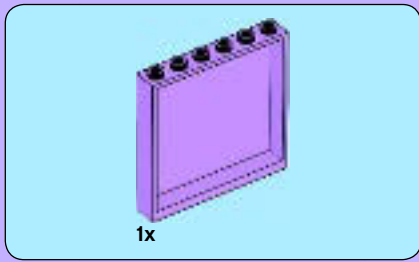

7

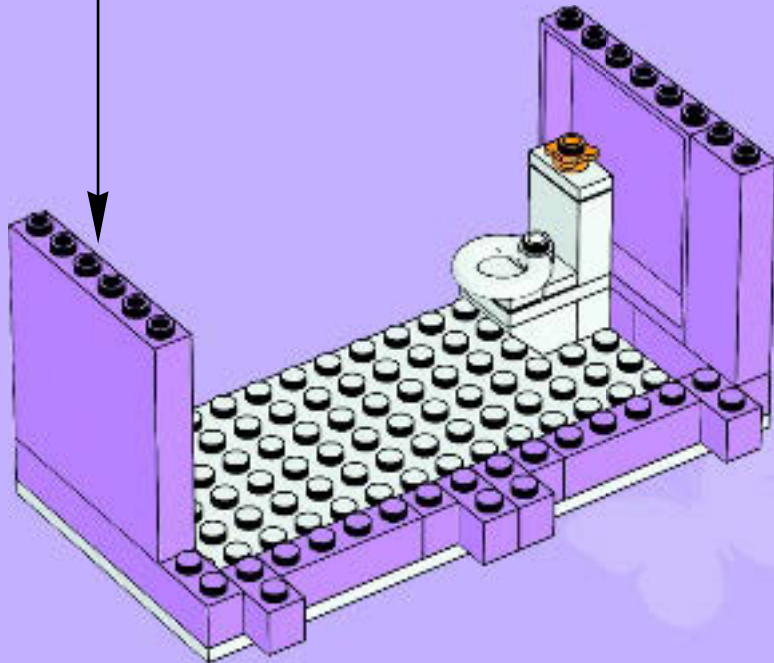
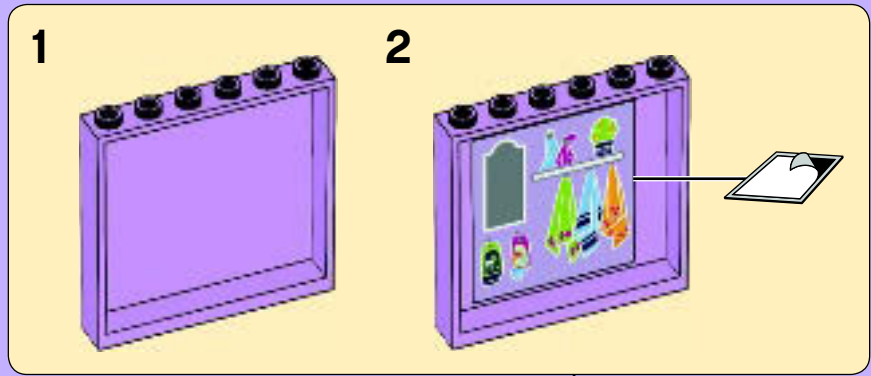

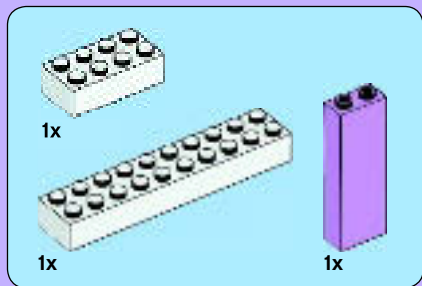

8

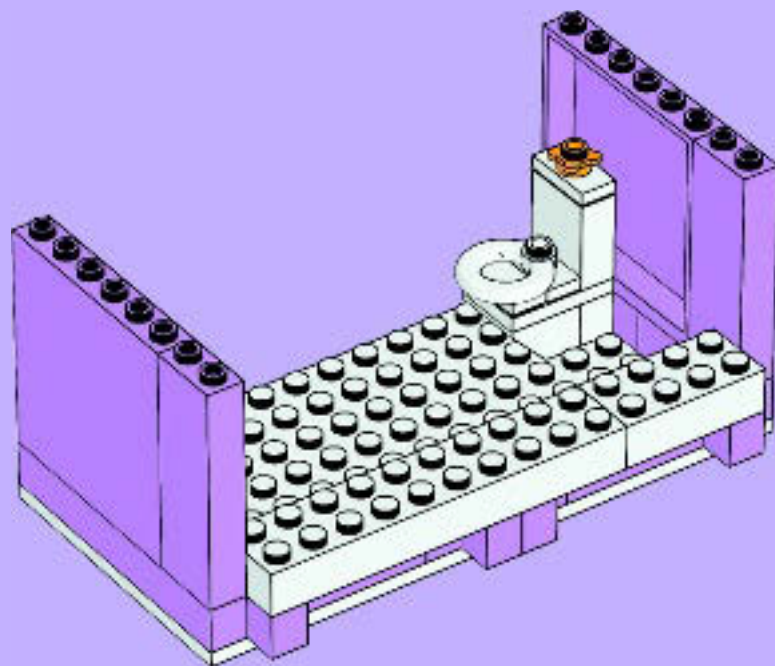



4x

9

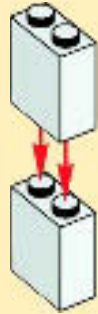

2x

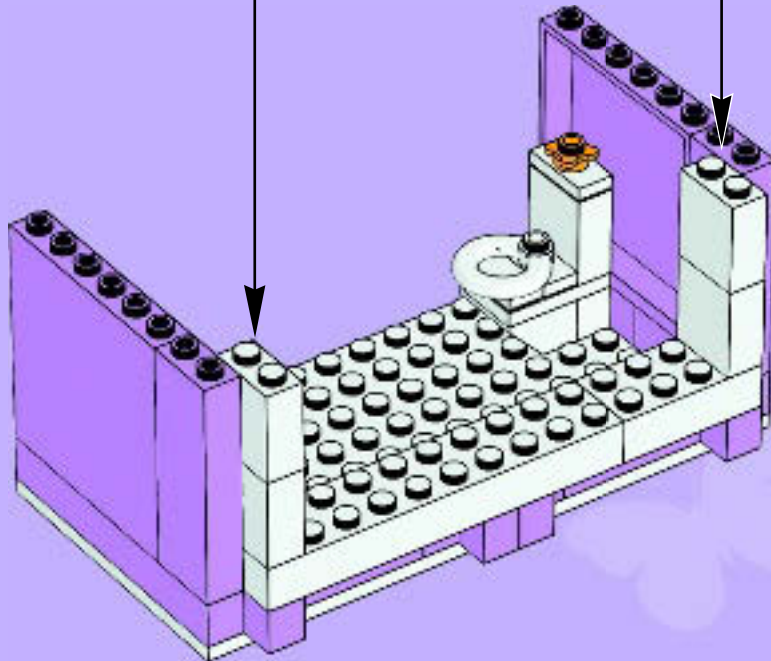

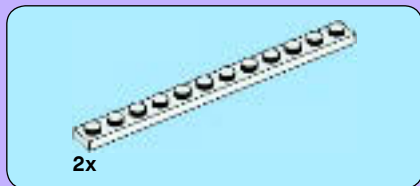

10

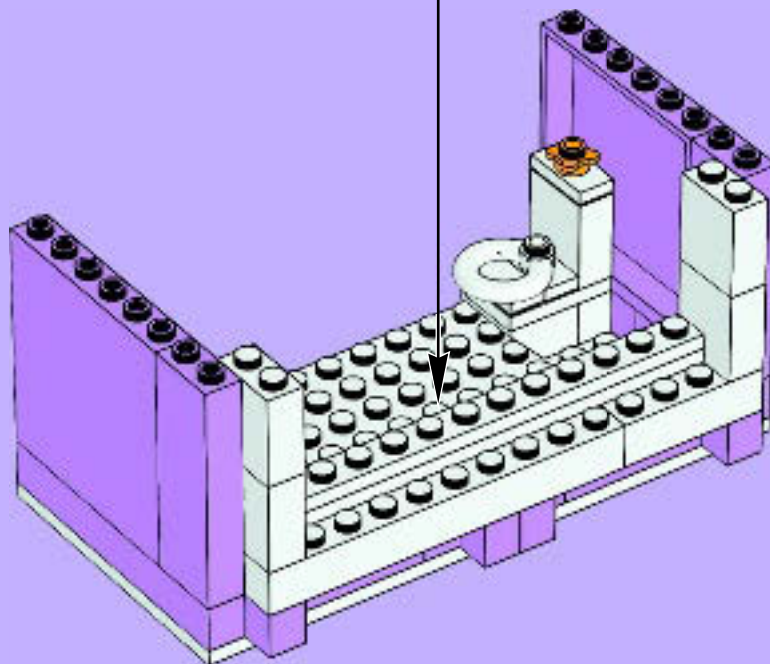
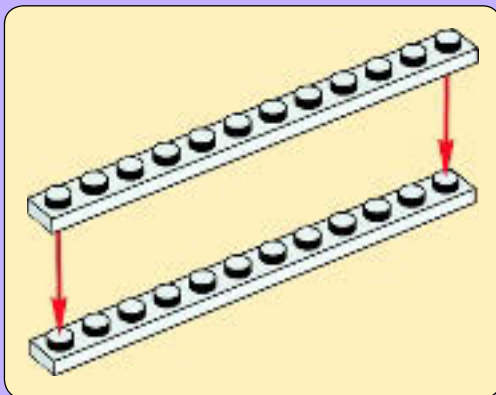

3x 1x 2x 3x

11

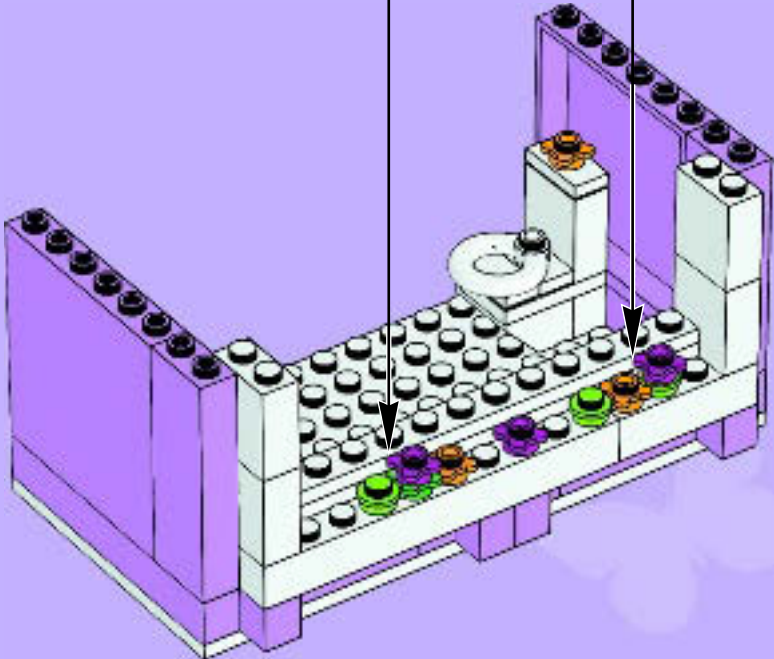
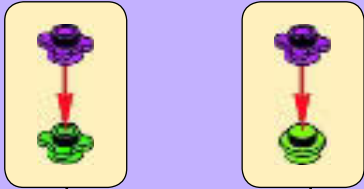

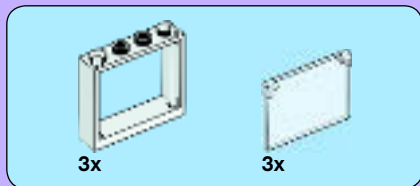

12

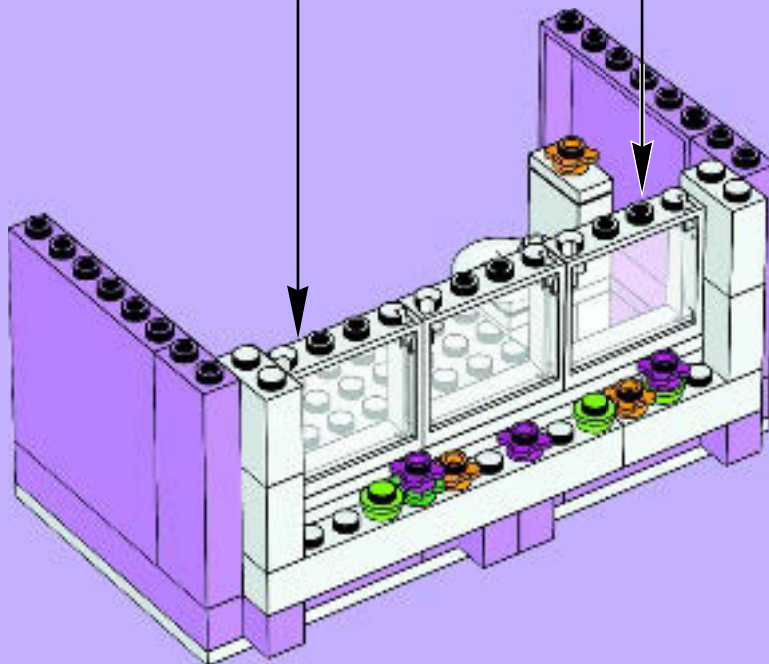
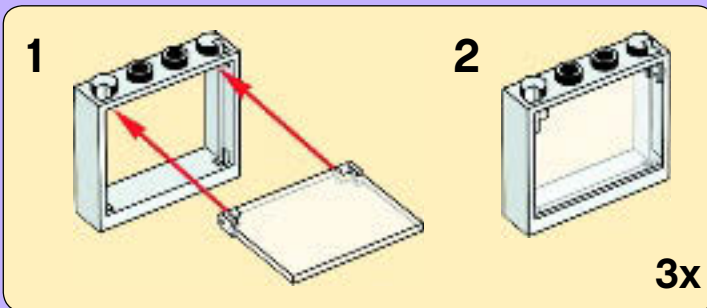

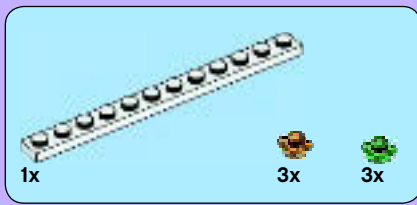

13

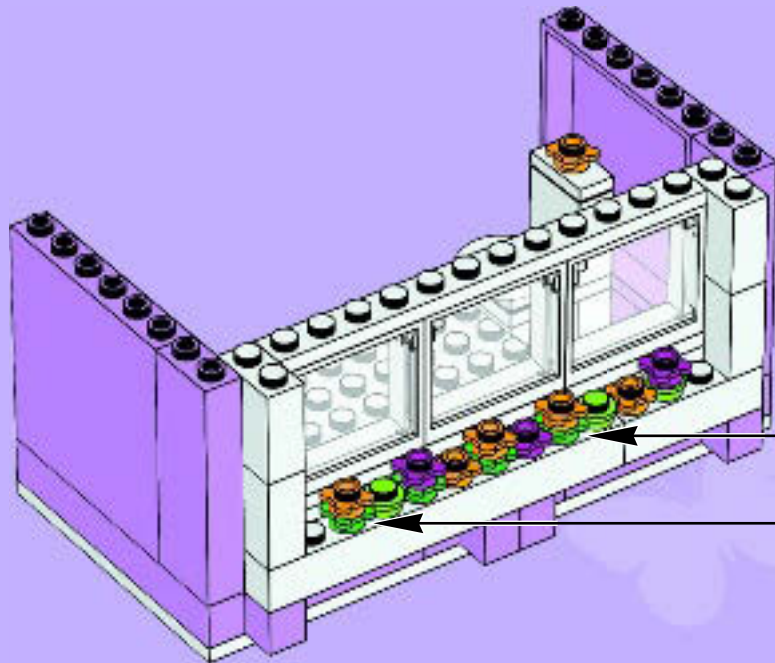
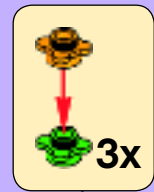



4x

14

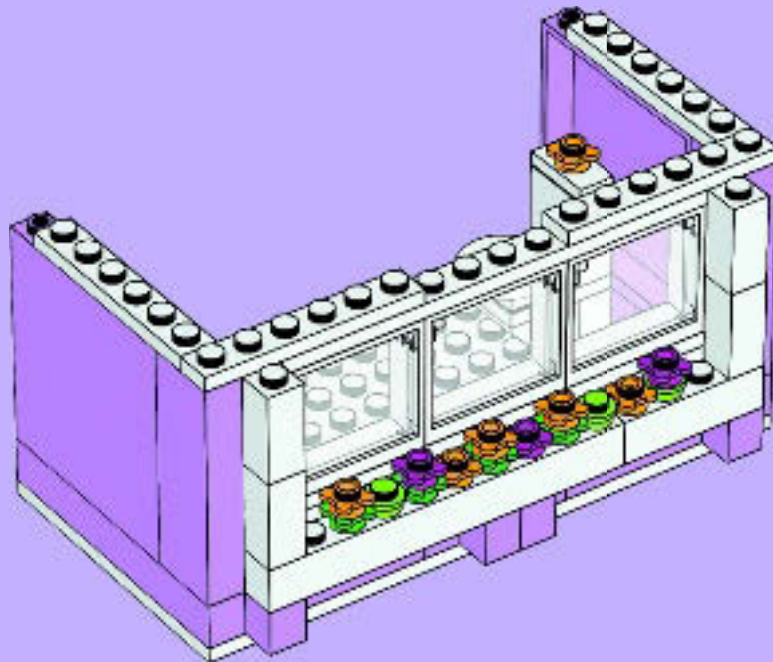



4x



1x

15



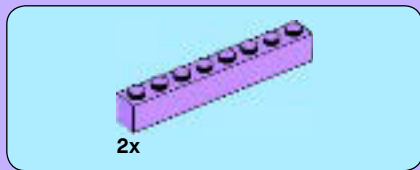

16

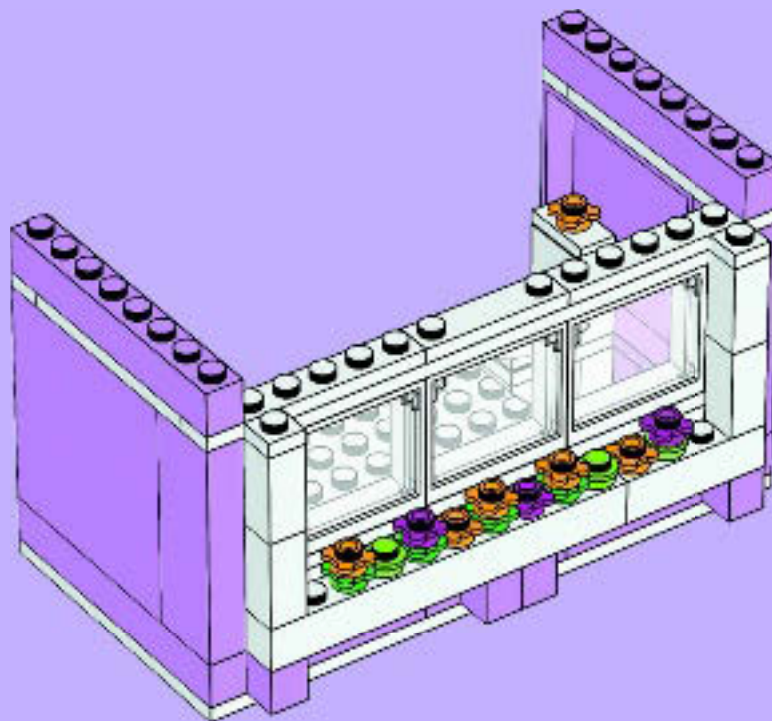

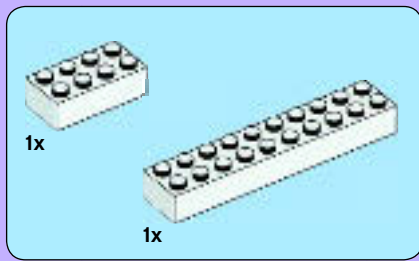

17





2x



2x

18

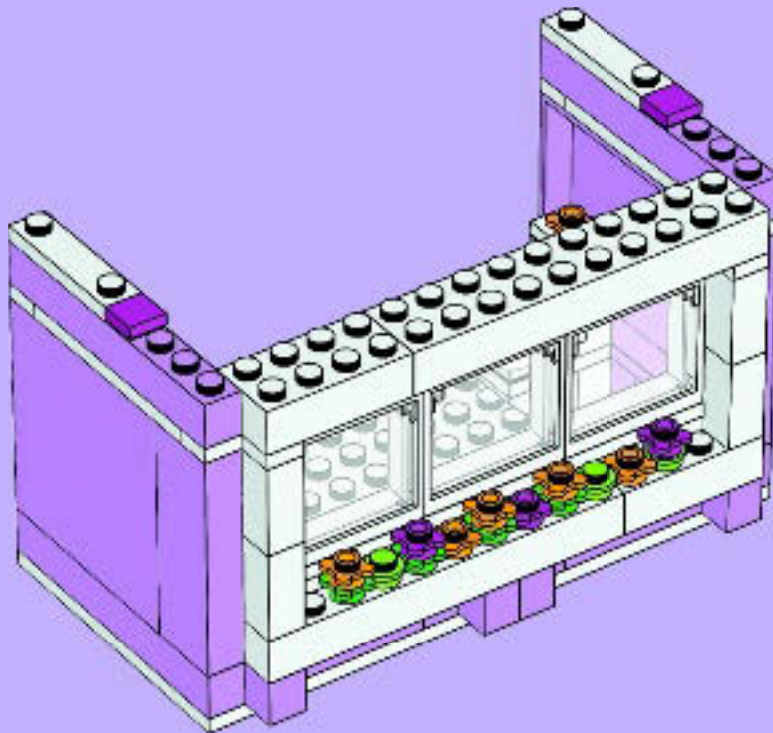

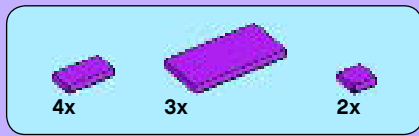

19

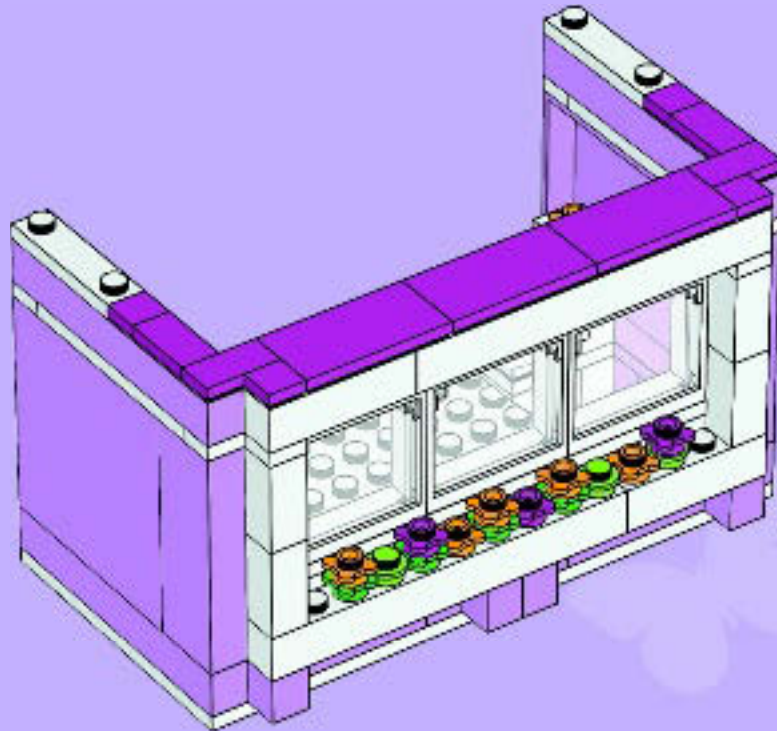



1

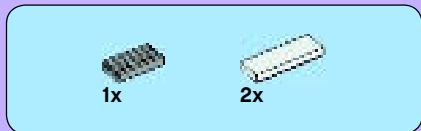

2

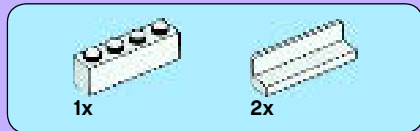
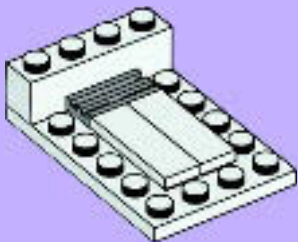

3

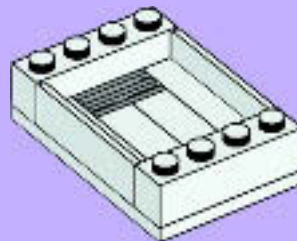

4

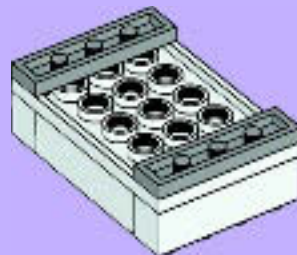
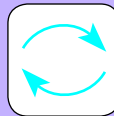

20

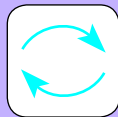



21

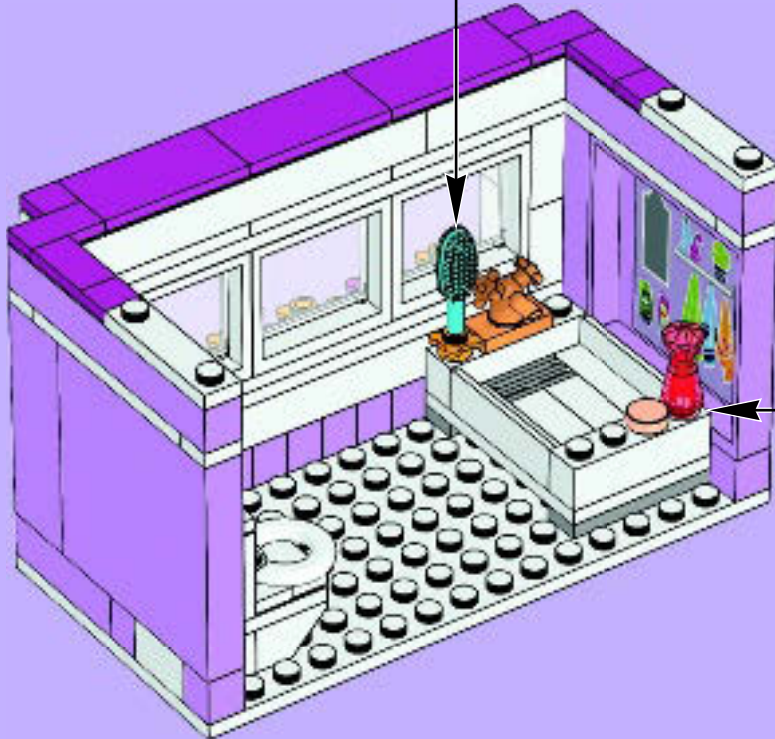
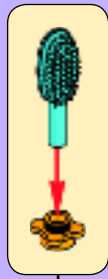



1

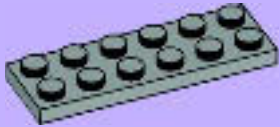

2

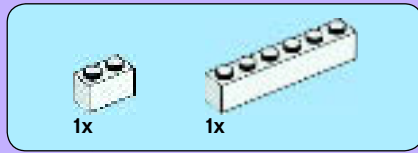
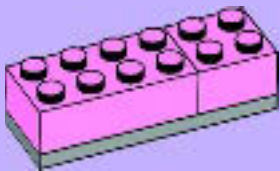

3

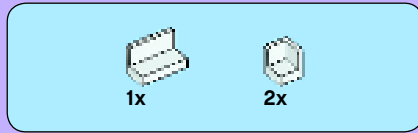
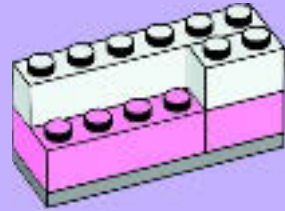

4

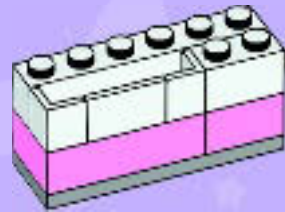



5

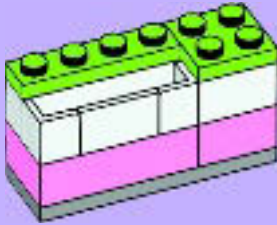

22

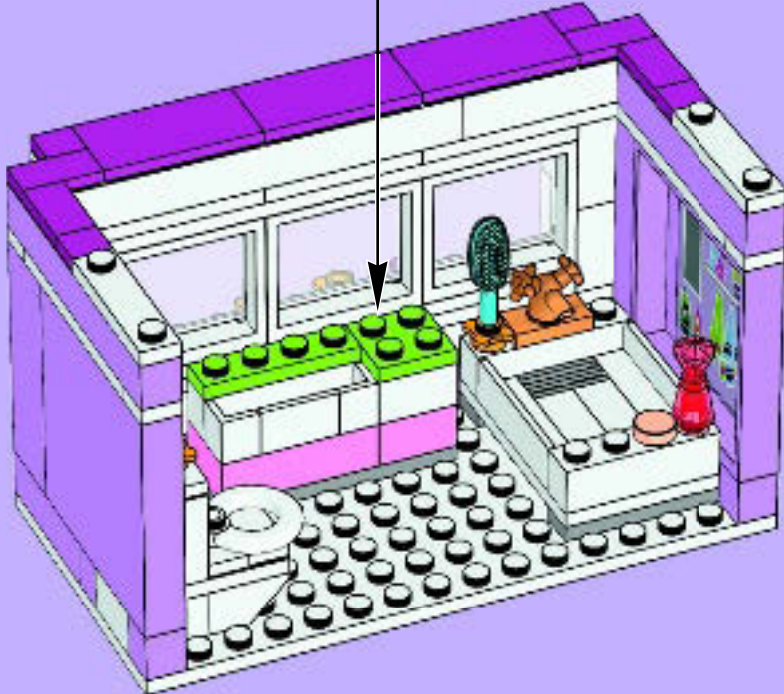



23

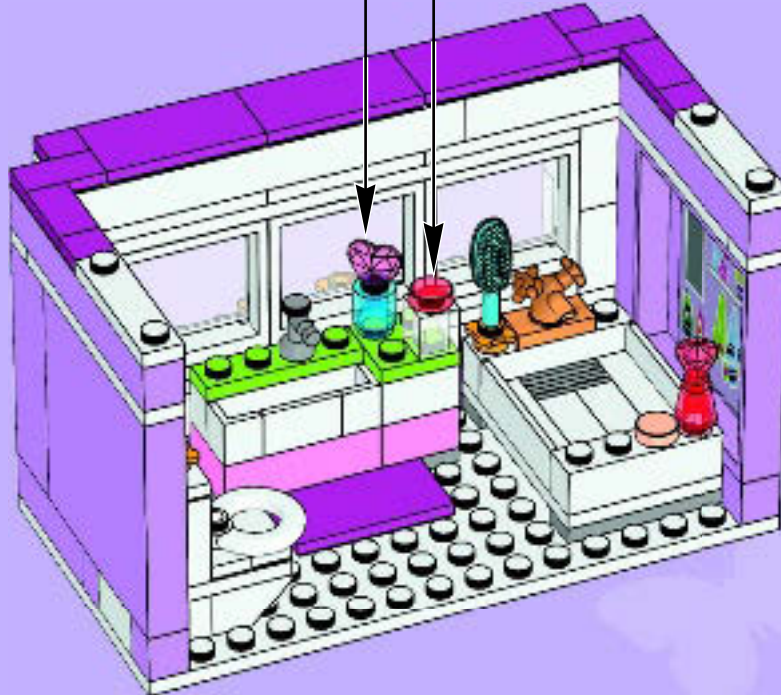

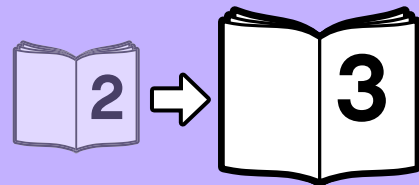



Friends



LEGO.com/heartcard



GET IT ON
 Google play

Available on the
 App Store

Apple, the Apple logo and iPad are trademarks of Apple Inc., registered in the U.S. and other countries. App Store is a service mark of Apple Inc./Apple, le logo Apple et iPad sont des marques de commerce d'Apple Inc., déposées aux États-Unis et dans d'autres pays. App Store est une marque de service d'Apple Inc./Apple, el logotipo de Apple e iPad son marcas comerciales de Apple Inc. registradas en EE. UU. y otros países. App Store es una marca de servicio de Apple Inc. Google Play is a trademark of Google Inc./Google Play est une marque de commerce de Google Inc./Google Play es una marca comercial de Google Inc.



Friends

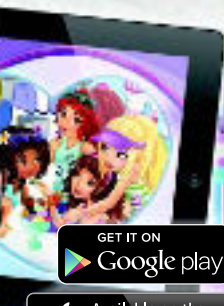

GET IT ON
 Google play

Available on the
App Store



Apple, the Apple logo and iPad are trademarks of Apple Inc., registered in the U.S. and other countries. App Store is a service mark of Apple Inc./Apple, le logo Apple et iPad sont des marques de commerce d'Apple Inc., déposées aux États-Unis et dans d'autres pays. App Store est une marque de service d'Apple Inc./Apple, el logotipo de Apple e iPad son marcas comerciales de Apple Inc. registradas en EE. UU. y otros países. App Store es una marca de servicio de Apple Inc. Google Play is a trademark of Google Inc./Google Play est une marque de commerce de Google Inc./Google Play es una marca comercial de Google Inc.

LEGO and the LEGO logo are trademarks of the/son des marques de commerce du/son marcas registradas de LEGO Group. ©2015 The LEGO Group. 6117923

LEGO.com/friends