



TECHNIC

42021





1x

1

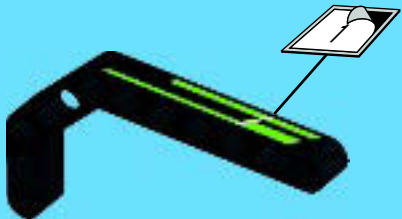

2



2x



1x

2

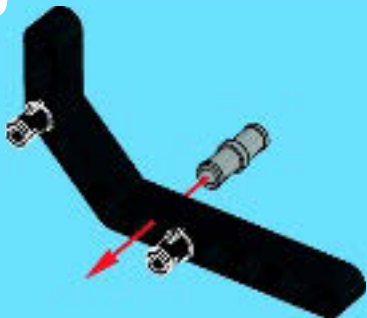



3

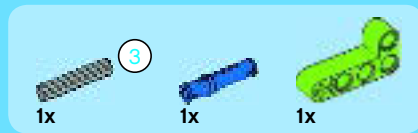
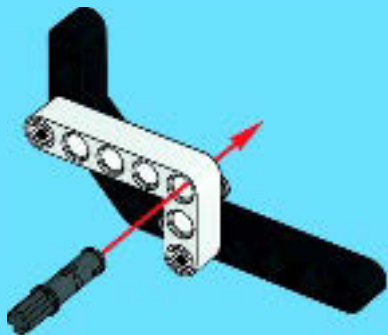

4

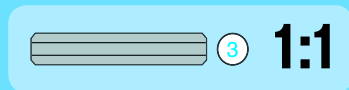
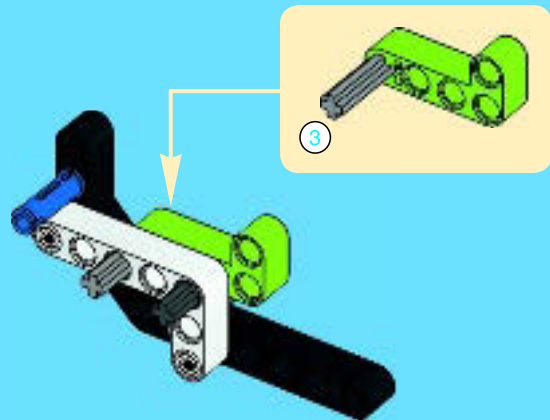

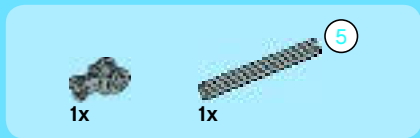

5

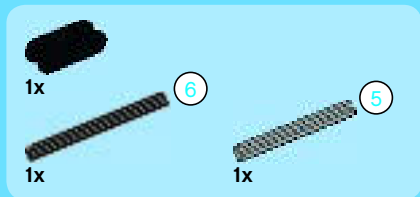
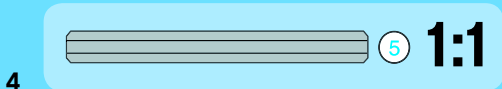
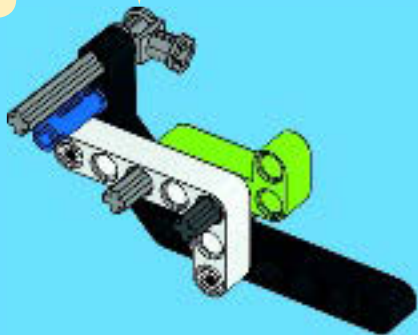
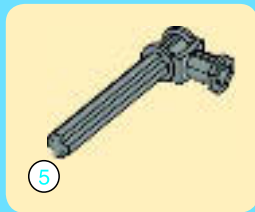

6

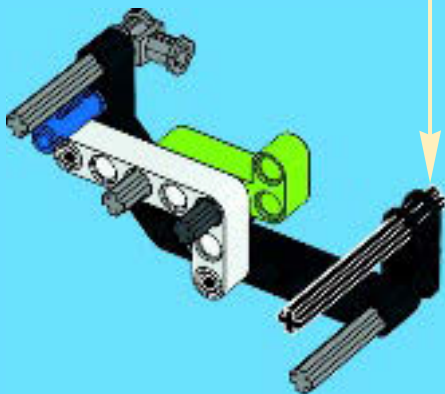
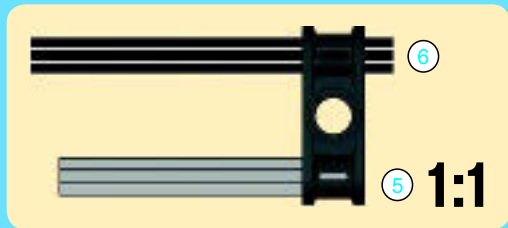



7

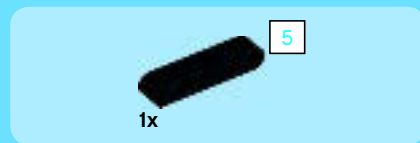
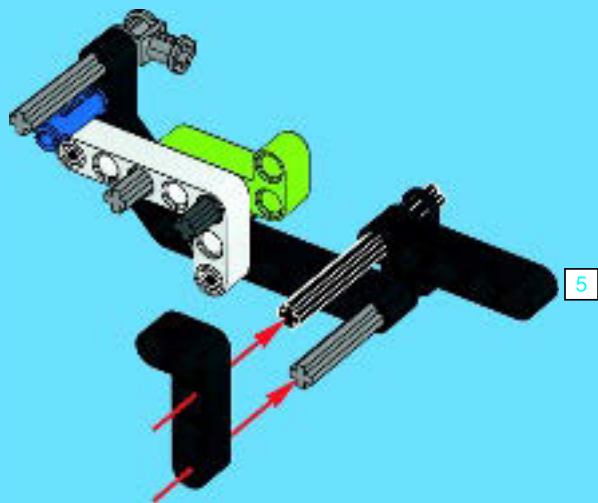

8

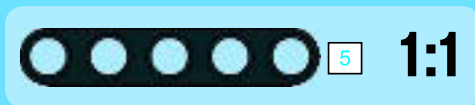
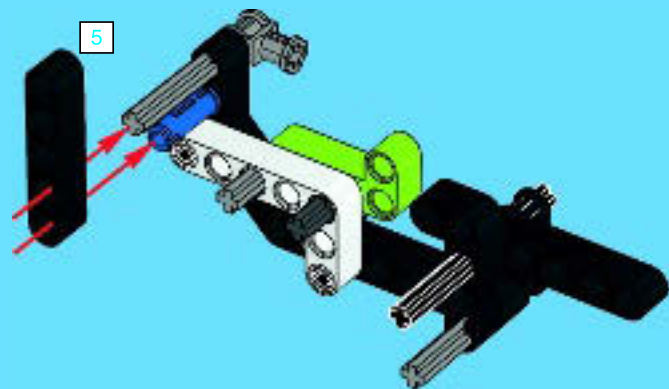



1



6

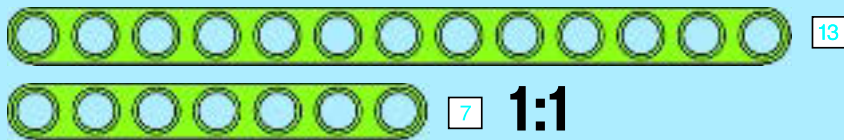

2

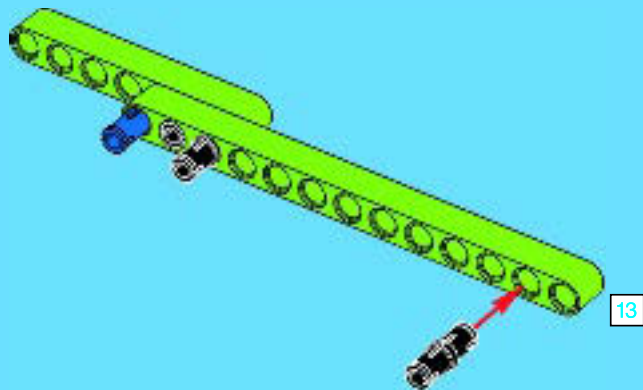

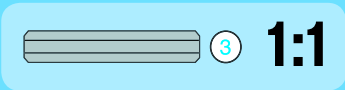
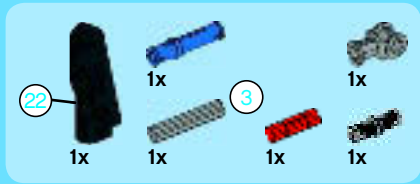

3

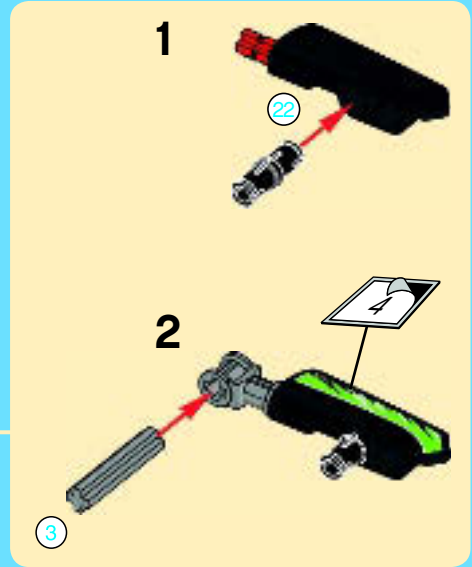
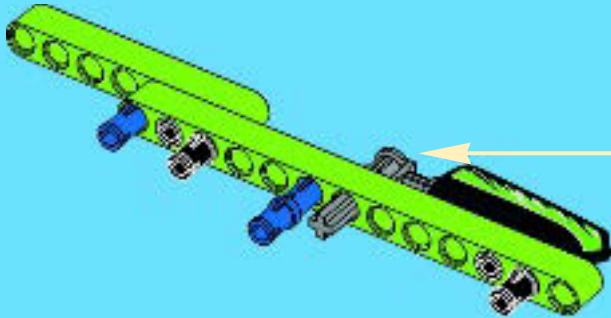

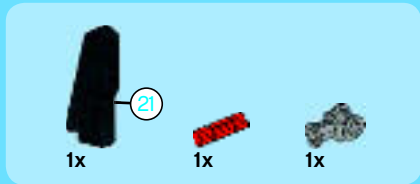

4

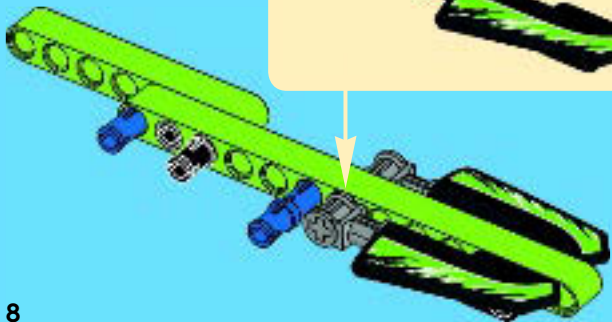
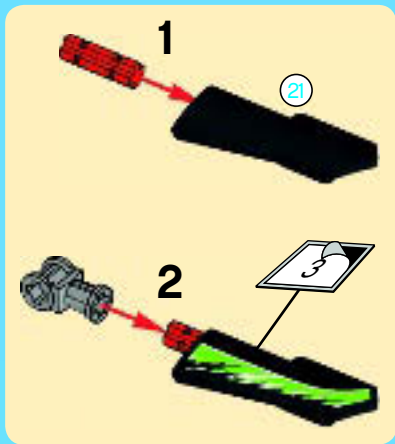

8



5

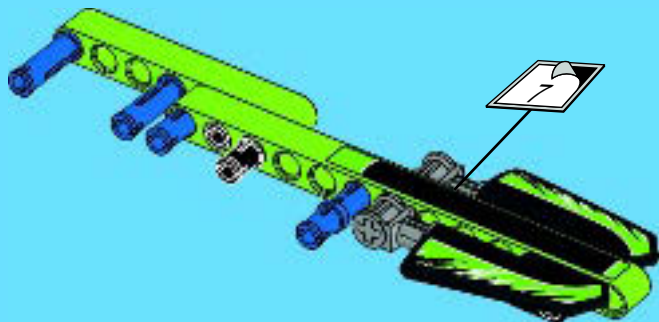

9

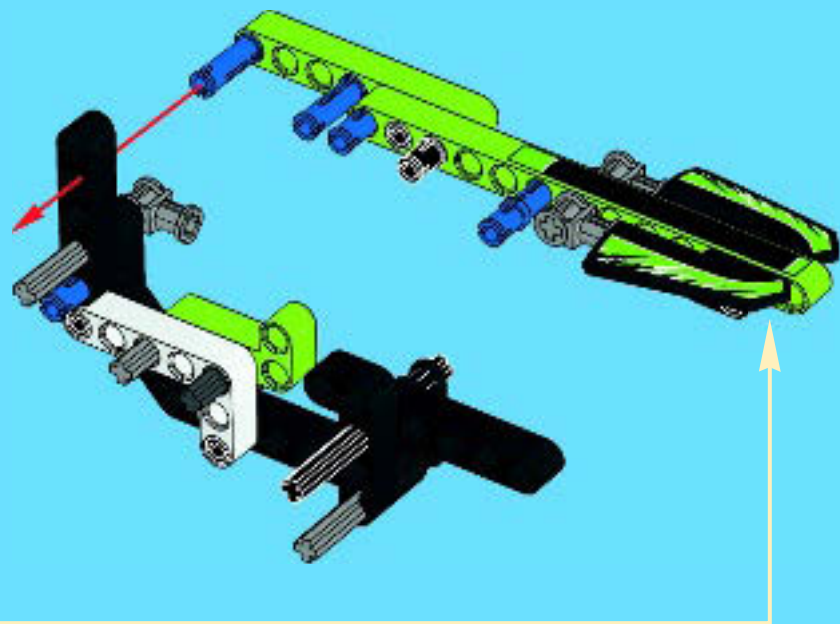

10

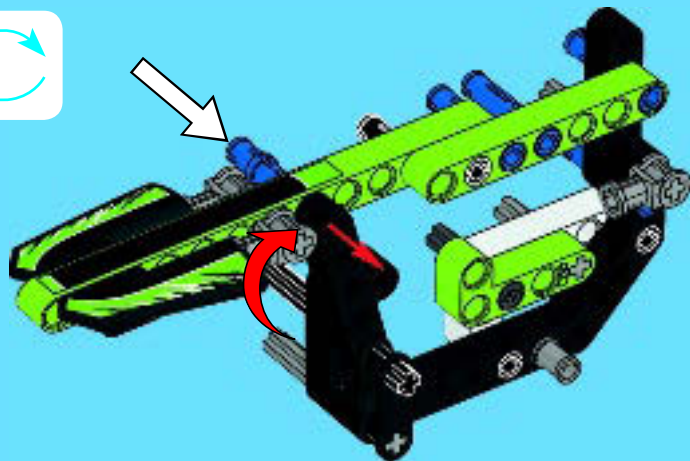



11

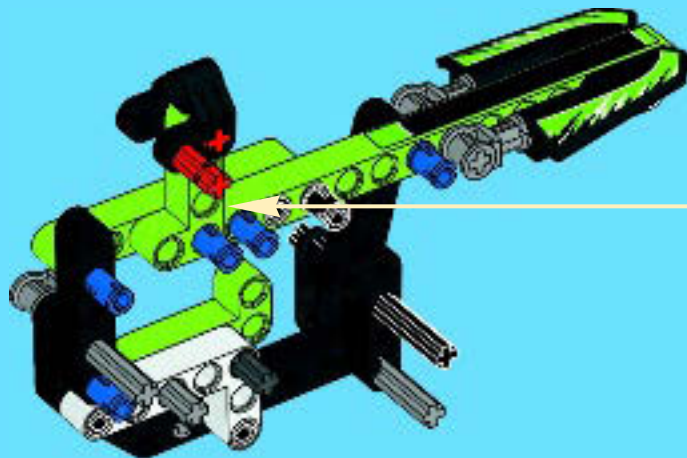
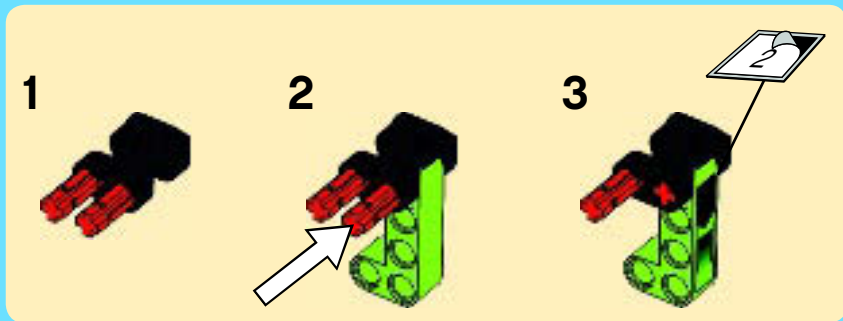

12

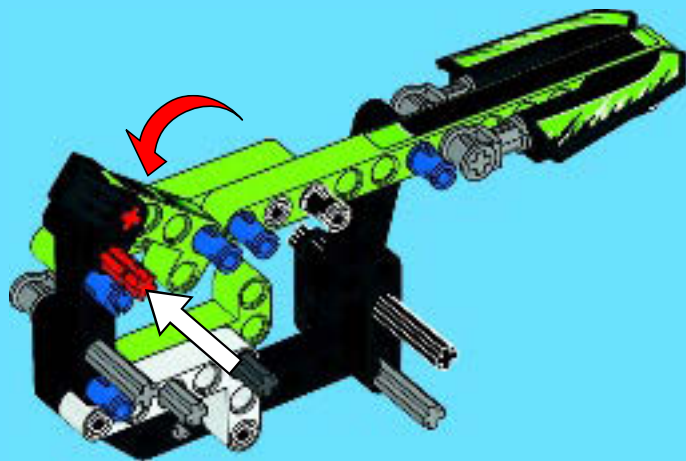

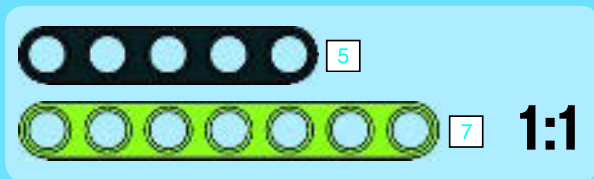
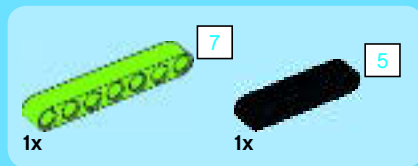

13

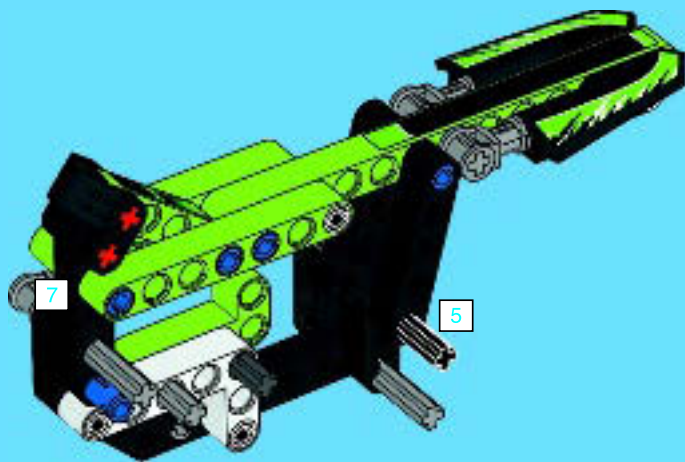

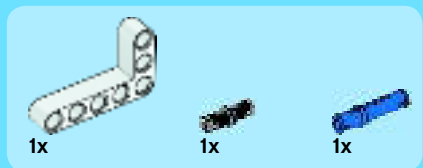

1

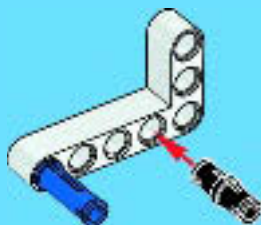

2

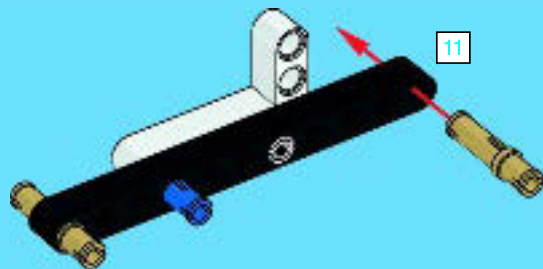



4x

3

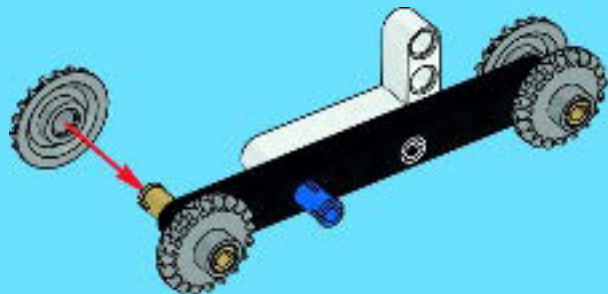

1x



1x

4

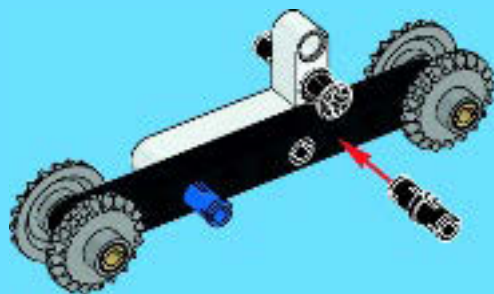

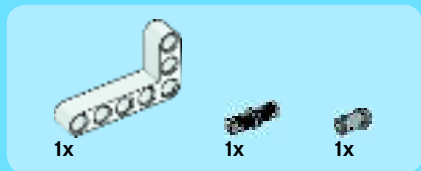

5

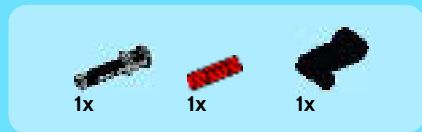
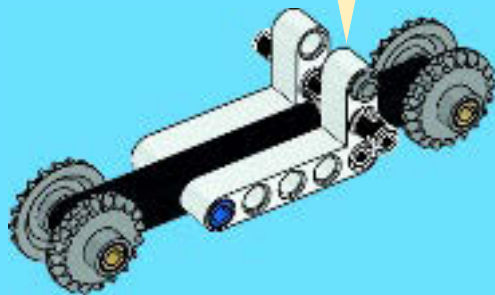
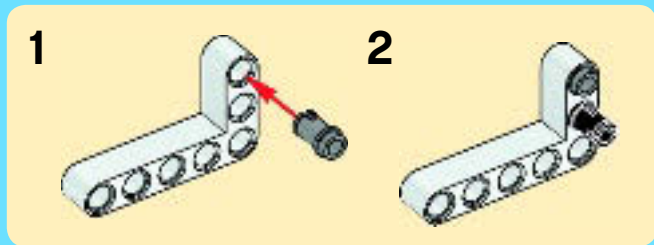

6

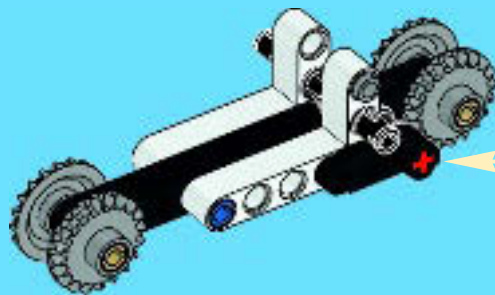
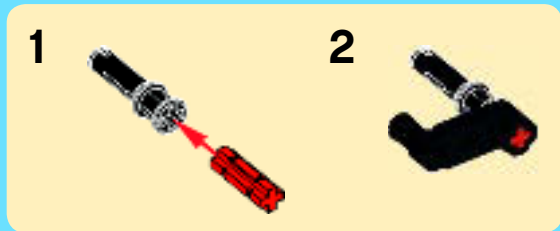



7

35x

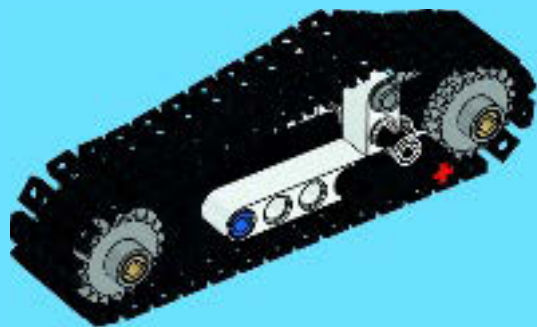



8

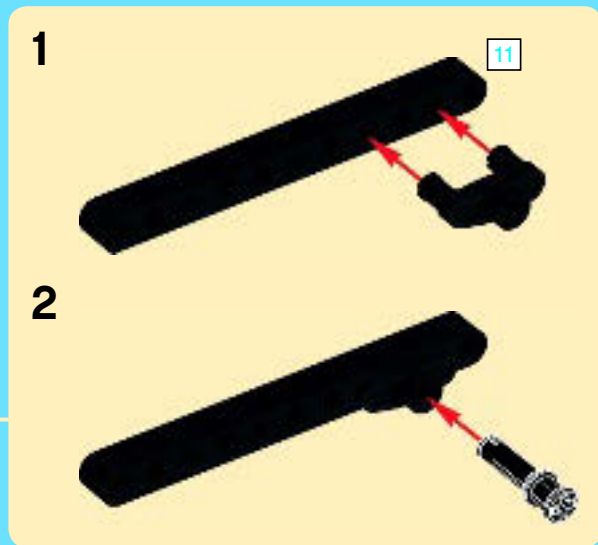
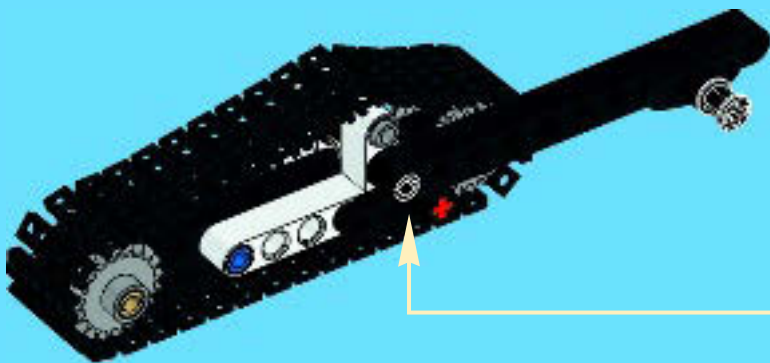

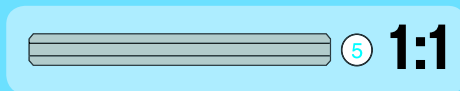
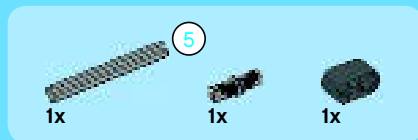

9

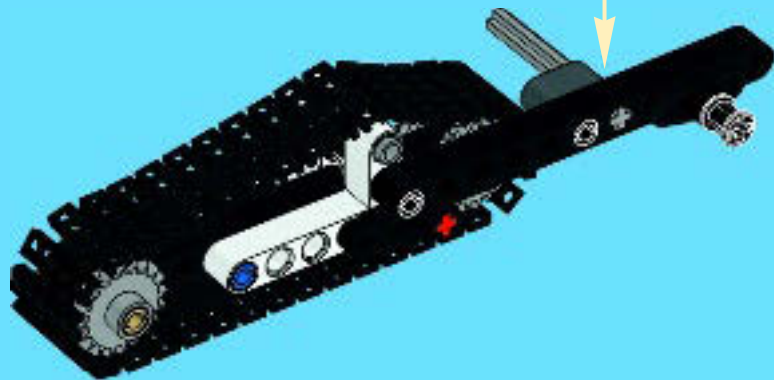
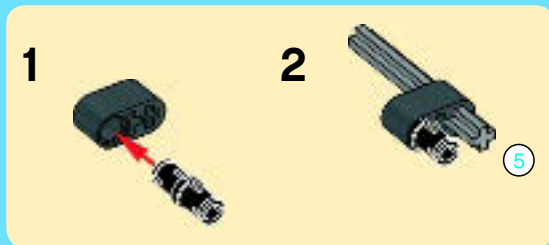

14





1x



1x

15

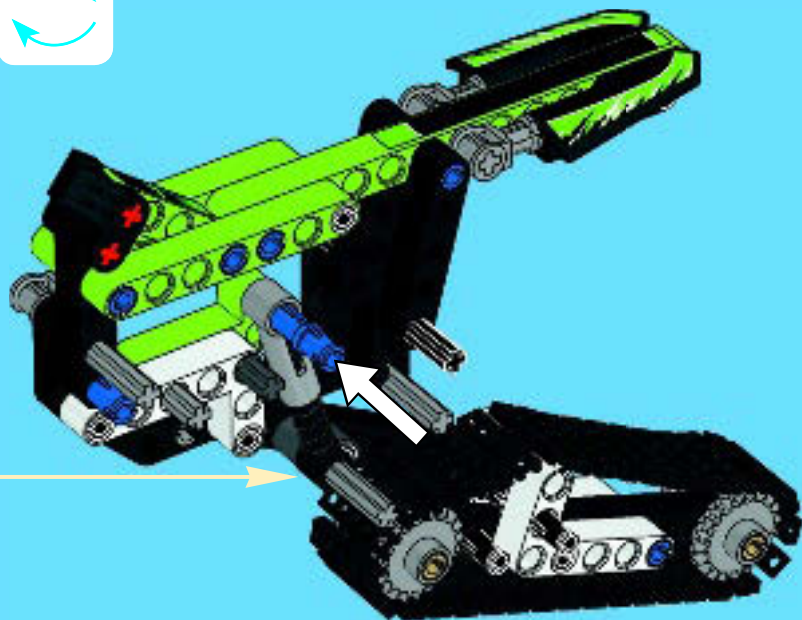



1x



1x

16

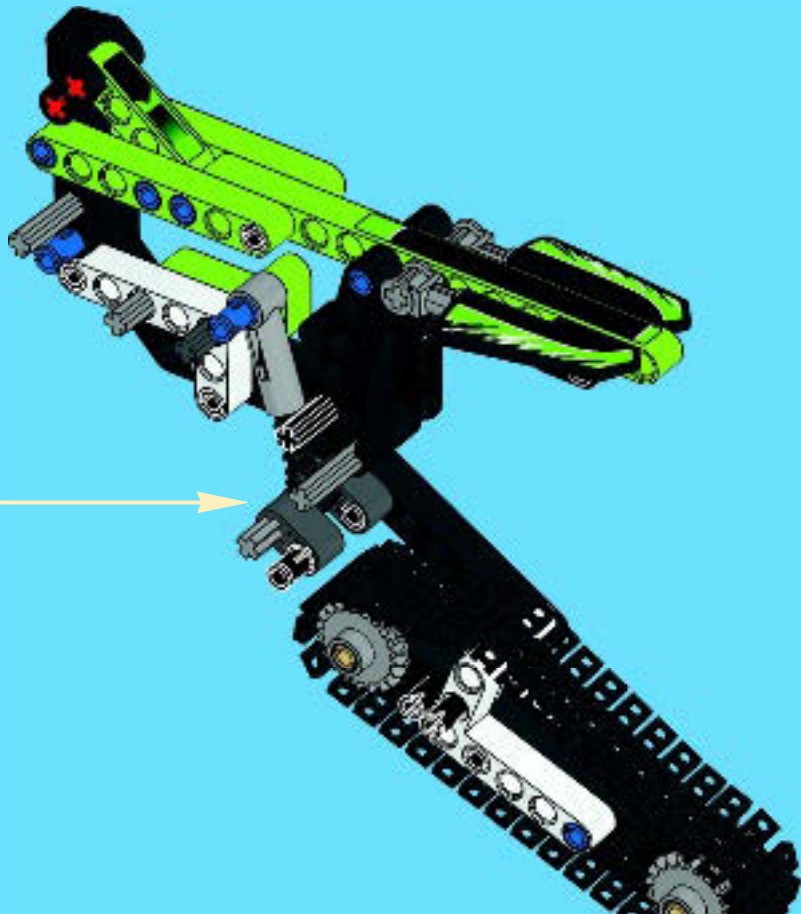

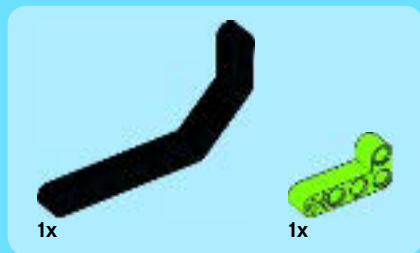

17

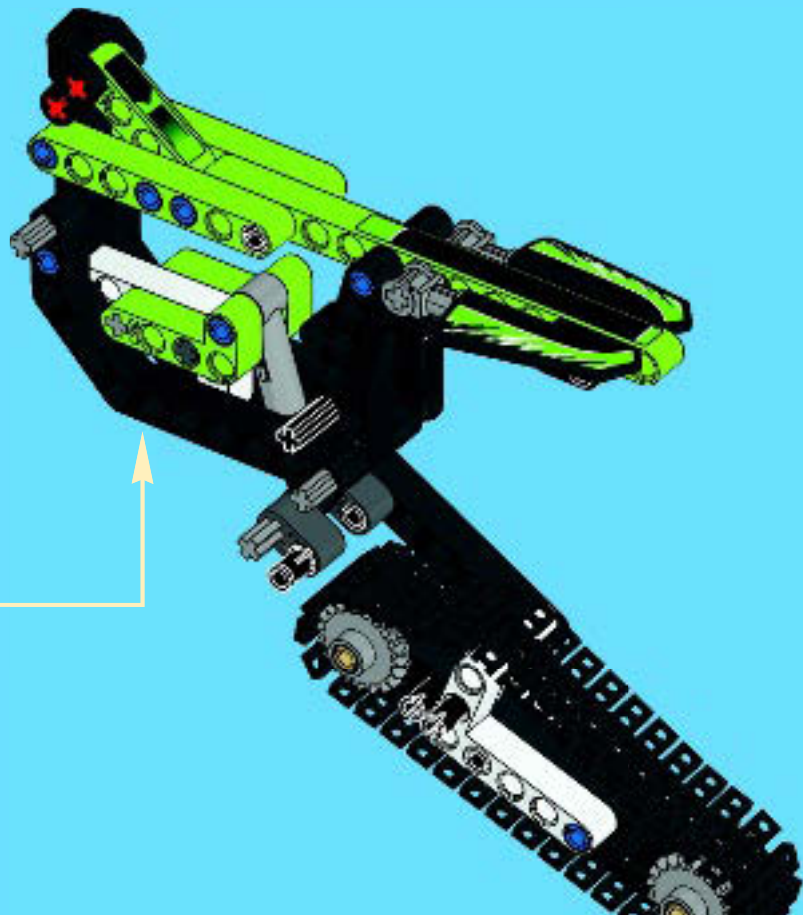
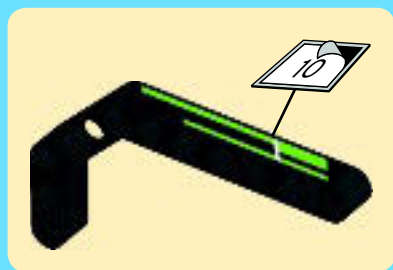



1x



1x

18

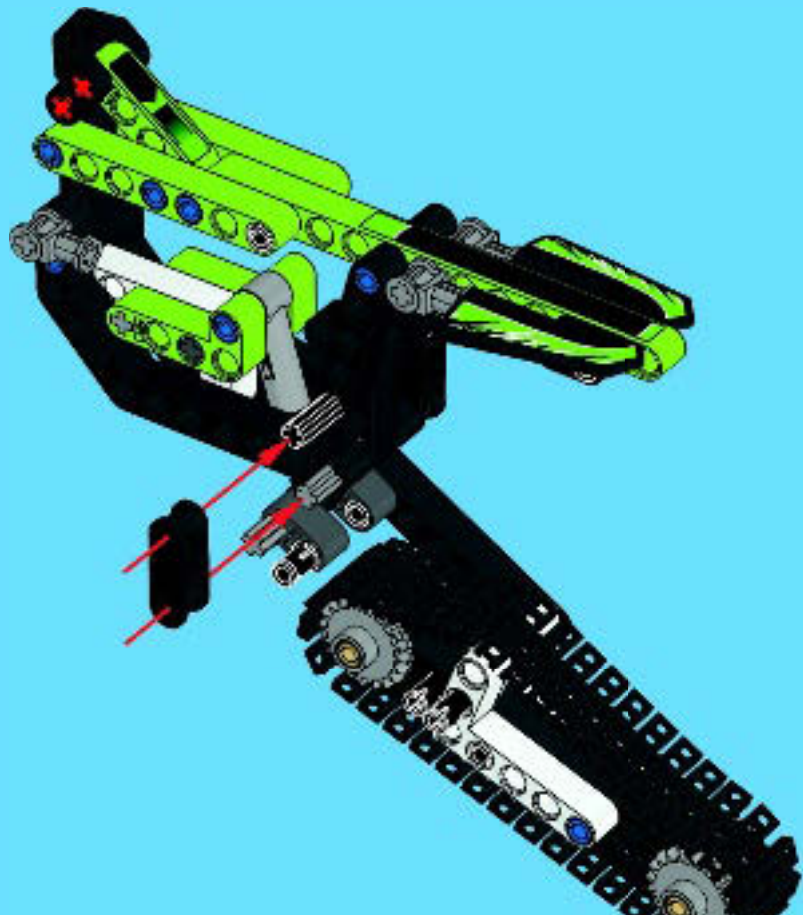

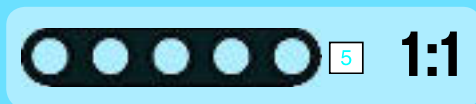

19

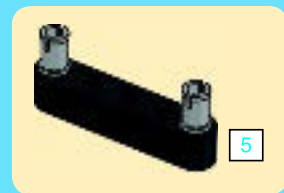
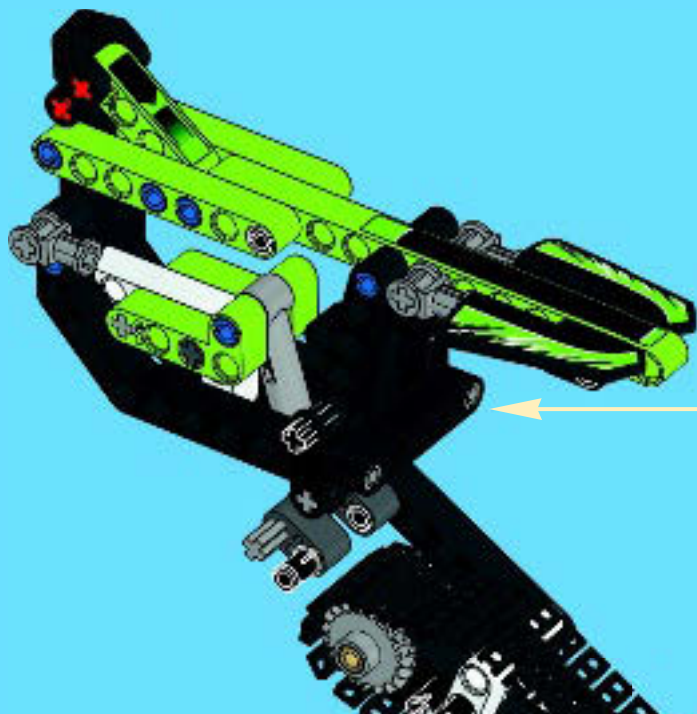



20

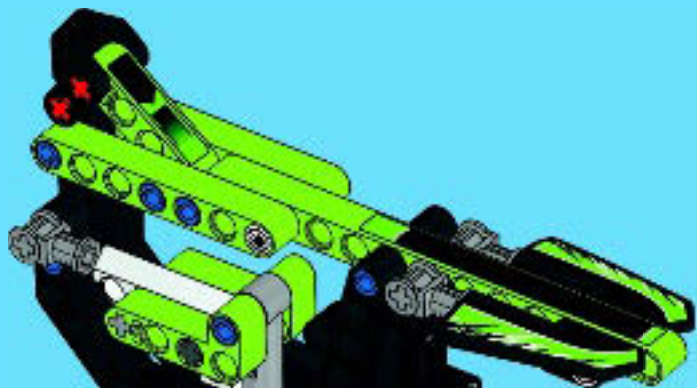
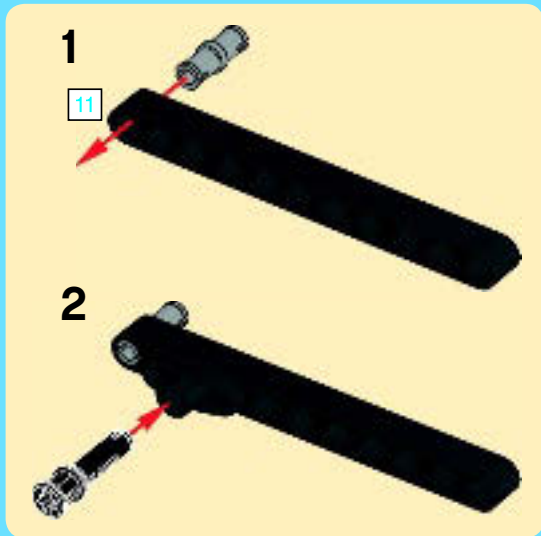

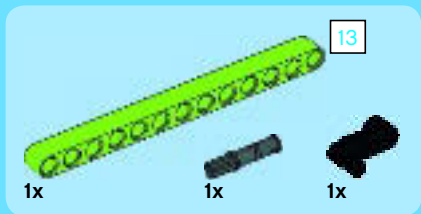
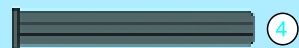

1

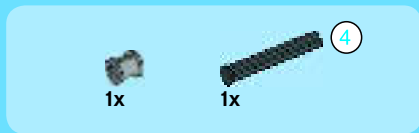
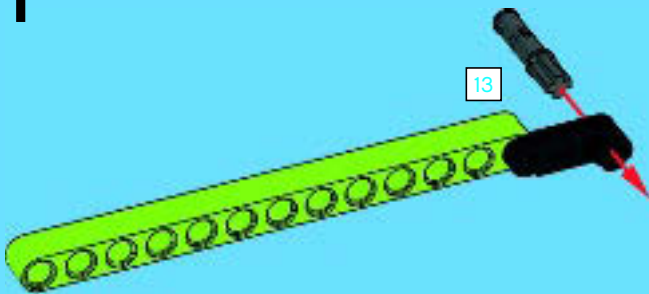

2

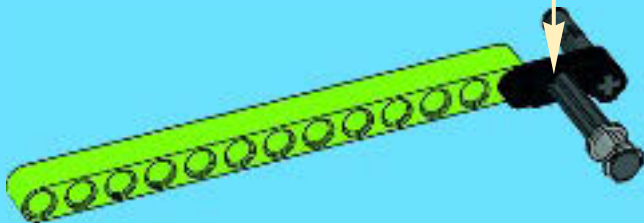
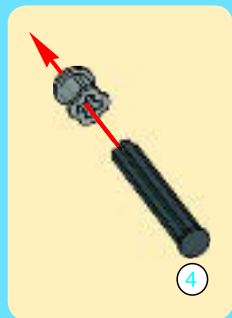



3

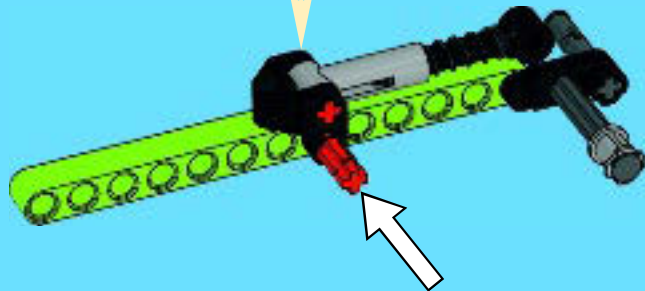
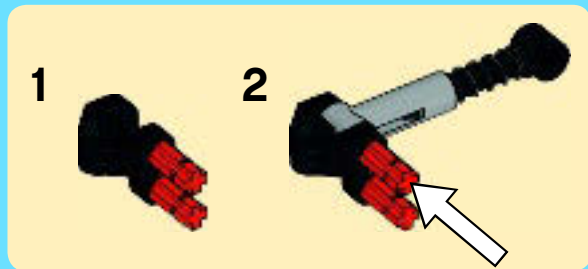

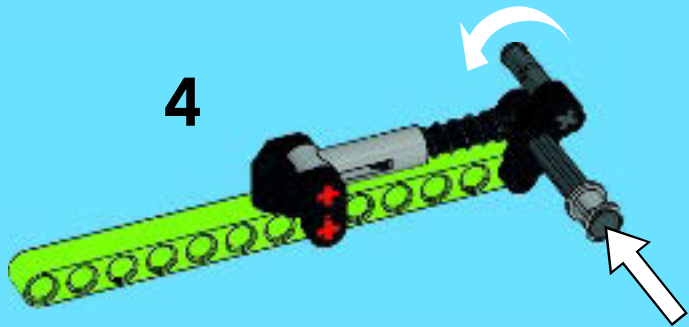

5

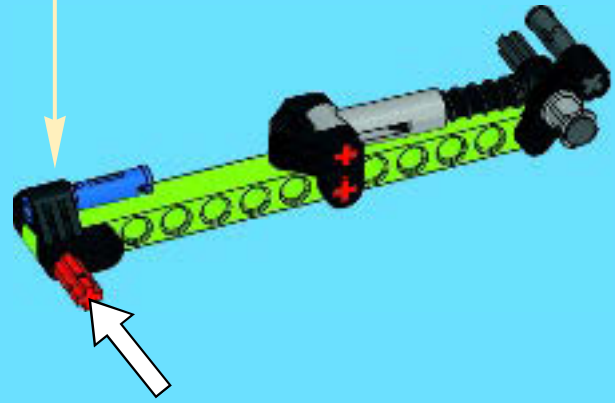
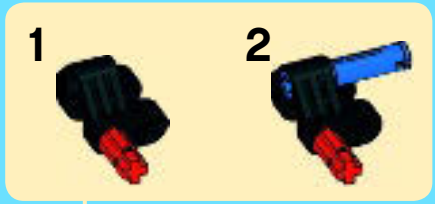



1x



1x

4

6



4

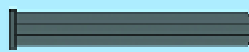
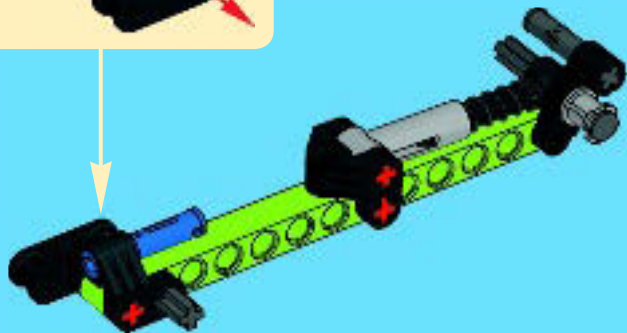

4

1:1



1x

6



2x

7



6

1:1

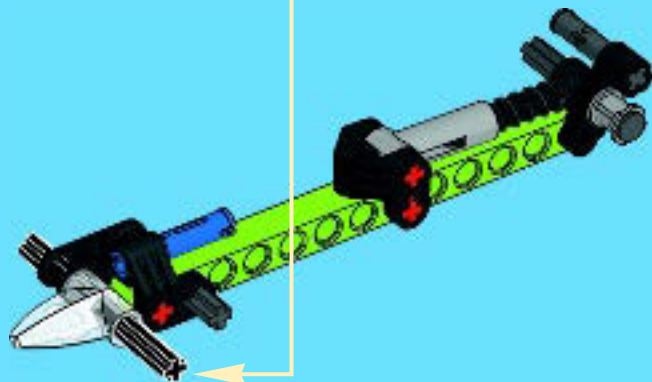



1x

8

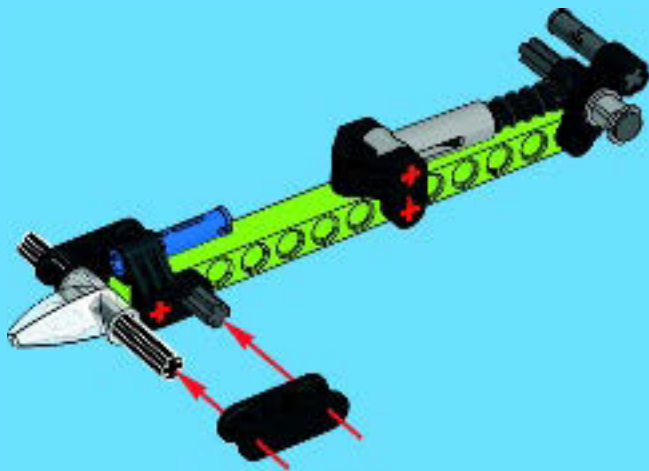

2x



2x



2x

9

1



2



2x

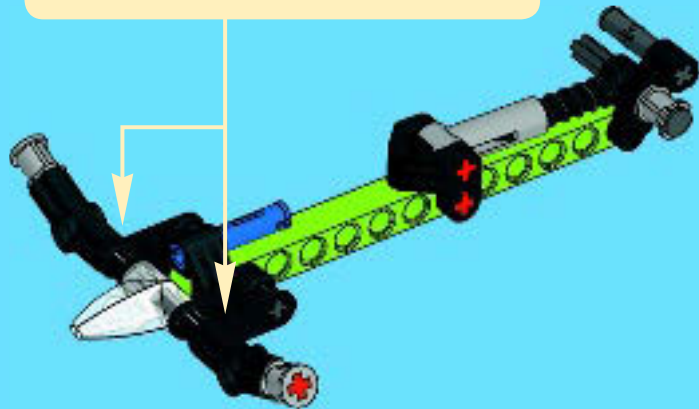

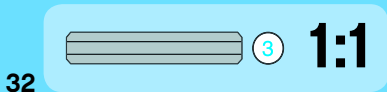
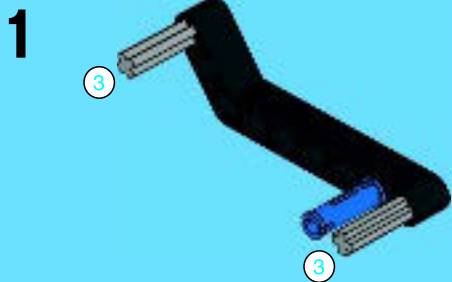
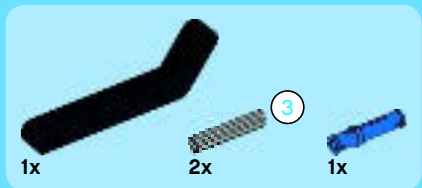

2

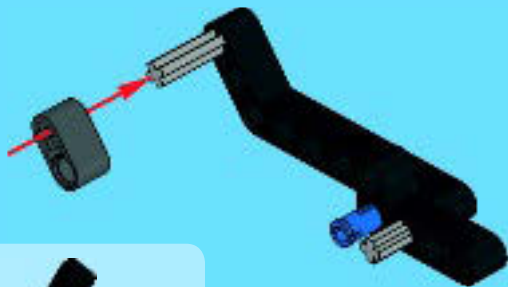

3

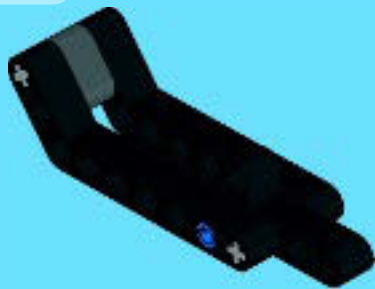

10

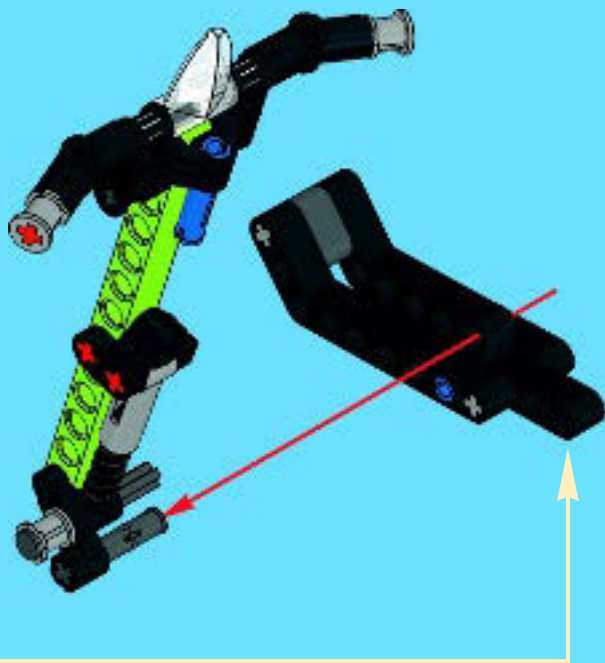

11



21

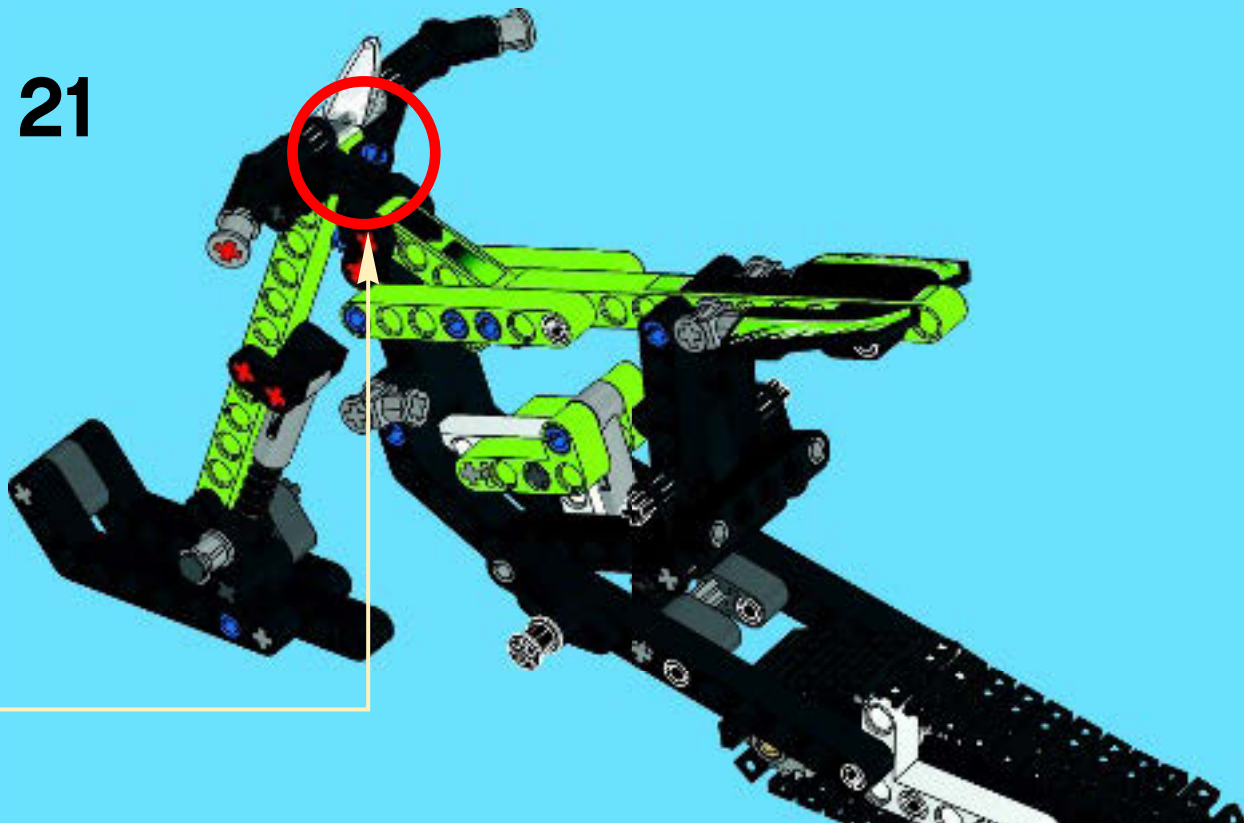



1x

22

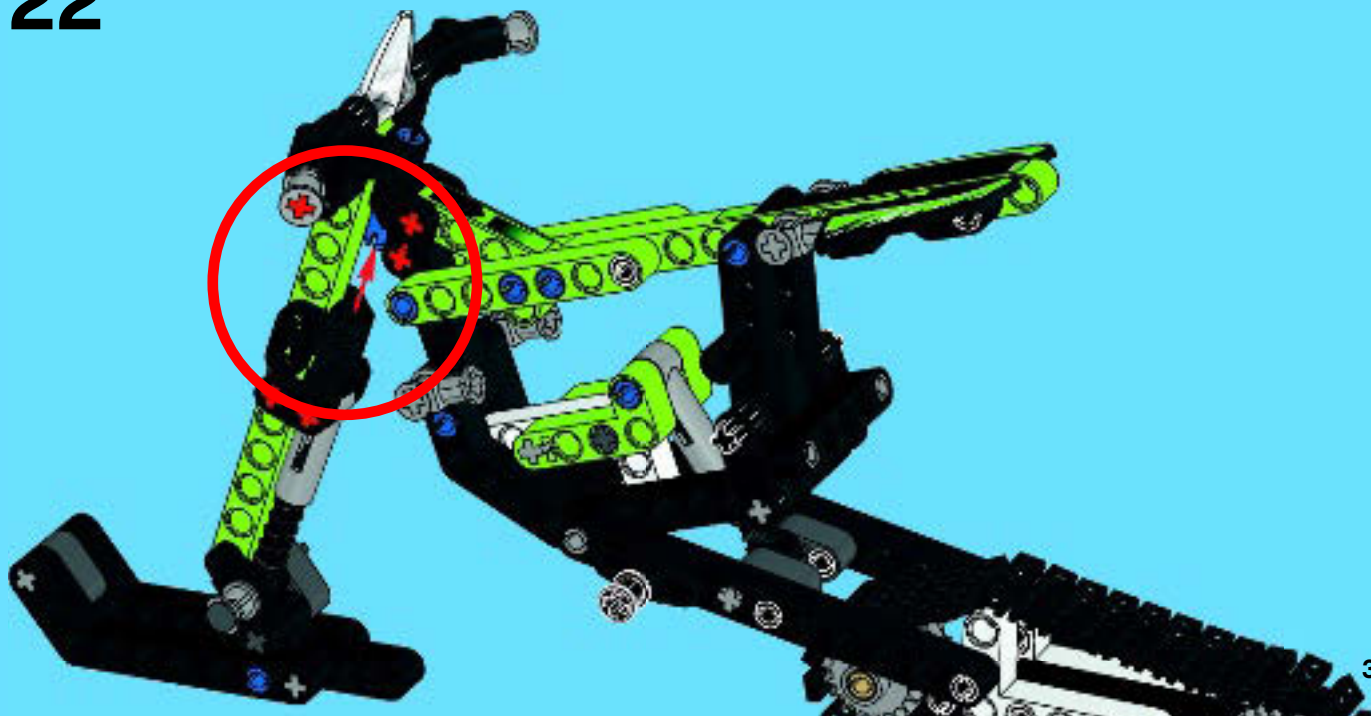



2x

23



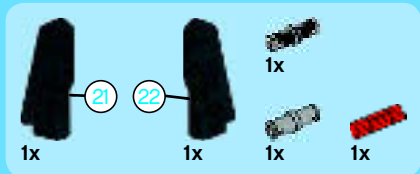

24

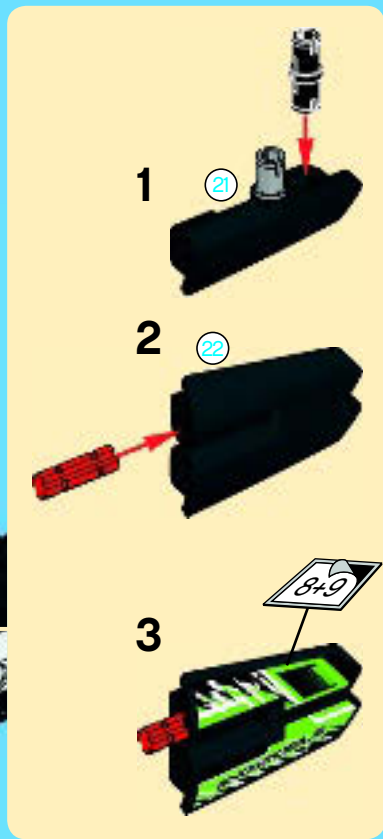
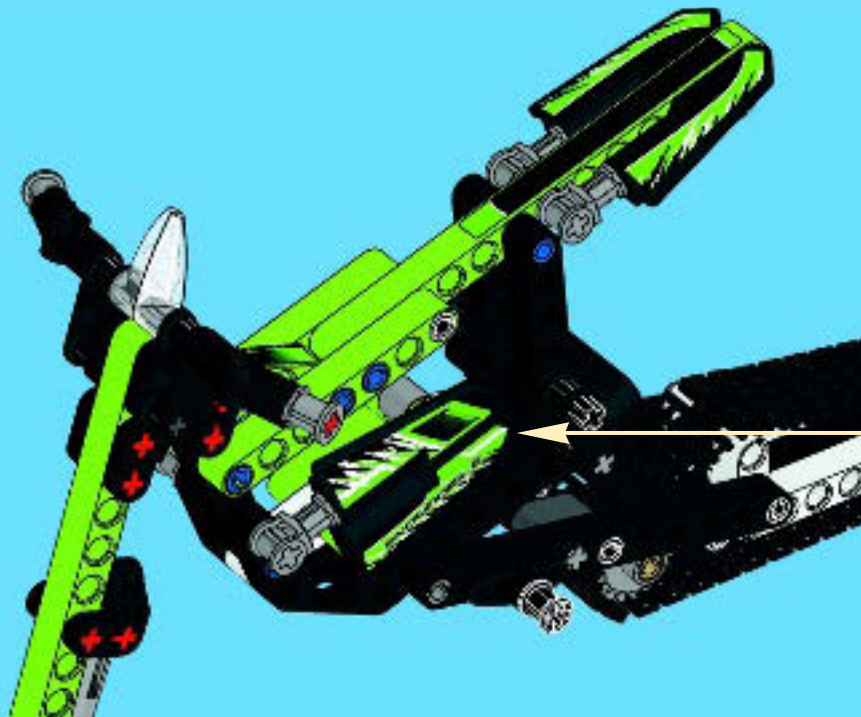

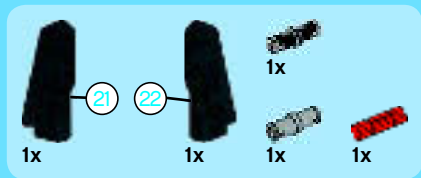

25

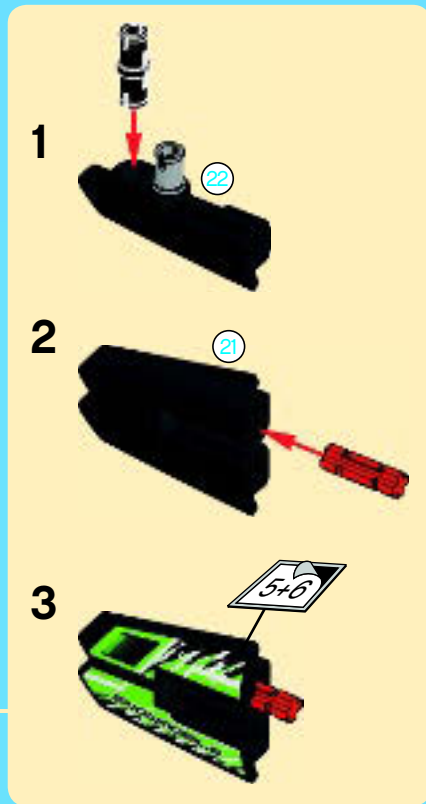





WIN!

Go to LEGO.com/productfeedback to fill out a survey for a chance to win a cool LEGO® Product.

No purchase necessary.
Open to all residents where not prohibited.



LEGO.com/productfeedback

GEWINNE!

Nimm an der Umfrage auf LEGO.com/productfeedback teil und hab die Chance ein cooles LEGO® Produkt zu gewinnen!

Die Teilnahme am Gewinnspiel führt zu keinerlei Kaufverpflichtungen. Teilnahme in allen nicht ausgeschlossenen Ländern möglich.

 LEGO.com

6073144 / 6073145

WIN!

Ga naar LEGO.com/productfeedback, vul een enquêteformulier in en maak kans op een cool LEGO® product.

Geen aankoopverplichting.
Iedereen mag deelnemen, uitgezonderd ingezetenden van landen waar een enquêteverbod geldt.

GAGNE!

Visite LEGO.com/productfeedback pour répondre à un questionnaire et avoir une chance de gagner un produit LEGO® très cool!

Aucune obligation d'achat.
Ouvert à tous les résidents des pays autorisés.

当てよう!

LEGO.com/productfeedback にアクセスして、アンケートにご記入ください。当選者にはレゴ®製品を差し上げます。

お買い上げの必要はありません。
禁止されていない限り、すべての皆様にご利用いただけます。

LEGO and the LEGO logo are trademarks of the/son des marques de commerce de/son marcas registradas de LEGO Group. ©2014 The LEGO Group.