



# CREATOR

5765



**WARNING:** CHOKING HAZARD.  
Toy contains small parts and a small ball.  
Not for children under 3 years.

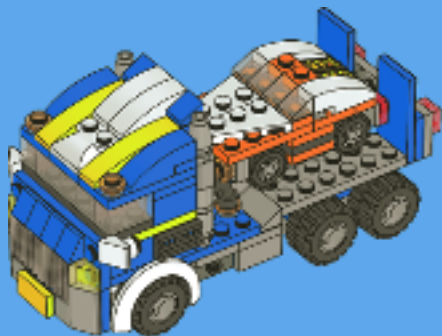
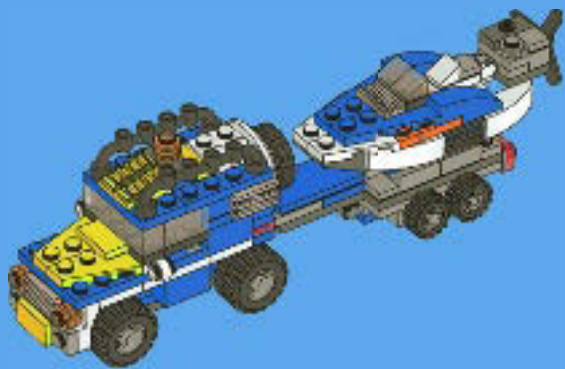



1x

1

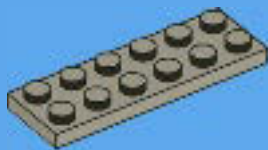

2x



1x



1x

2



**AVERTISSEMENT** : RISQUE D'ÉTOUFFEMENT.  
Le jouet contient des petites pièces ainsi qu'une petite boule.  
Il ne convient pas aux enfants de moins de 3 ans.



**ADVERTENCIA**: PELIGRO DE ASFIXIA.  
Juguete que contiene partes pequeñas y una pelota pequeña.  
No recomendado para niños menores de 3 años.

2x

2x

2x

4x

3

1

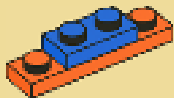

2

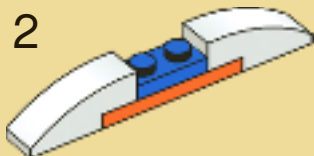

3

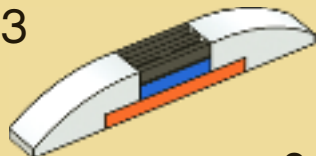

2x





2x



1x



1x

# 4



1x



1x



1x

# 5

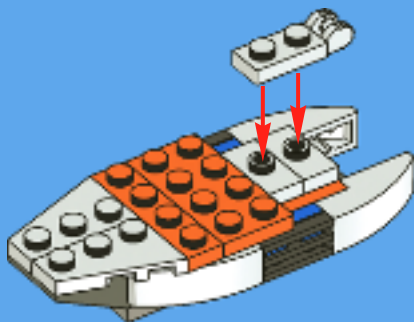



1x



1x



2x

# 6

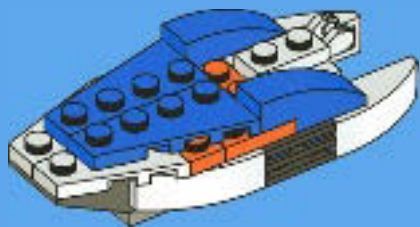

6



1x



1x



2x



1x



1x

# 7

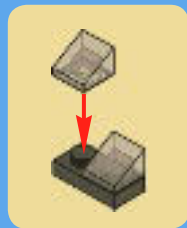

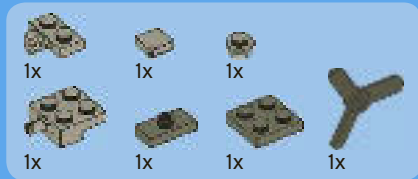

8

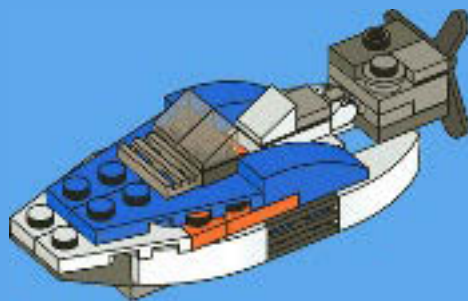
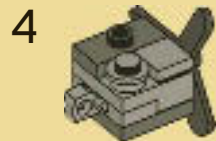



1x



1x

1

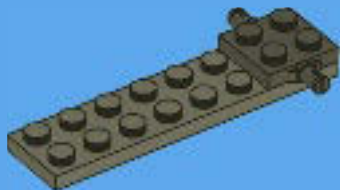

1x



1x



1x

2

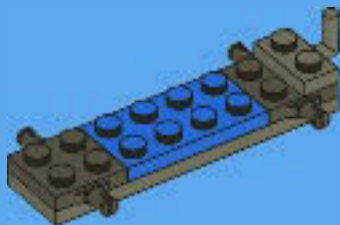





3

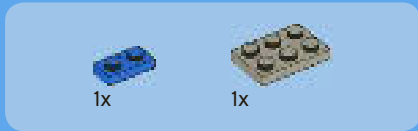
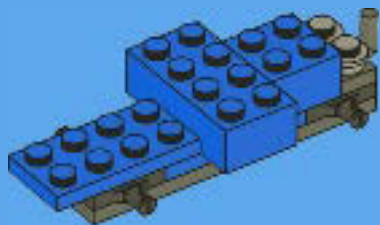

4

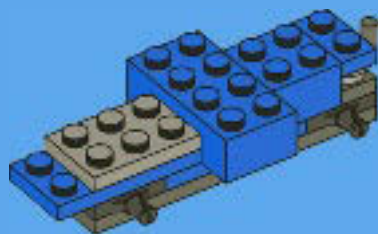



1x



1x

# 5

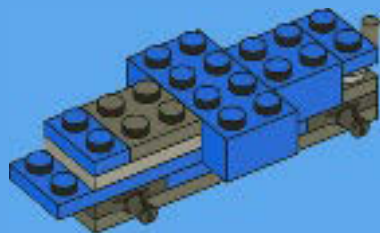

1x



2x



1x



1x

# 6

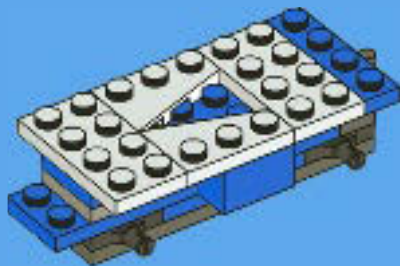



7

1

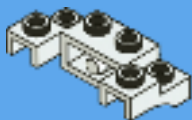

2



3

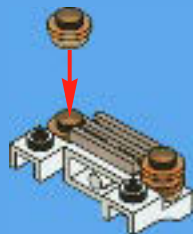

4

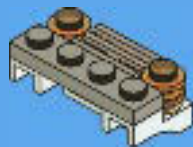

5



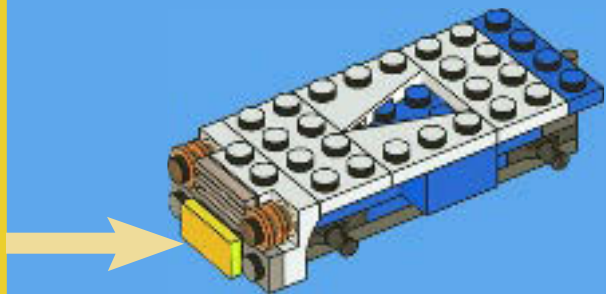

2x



2x

8

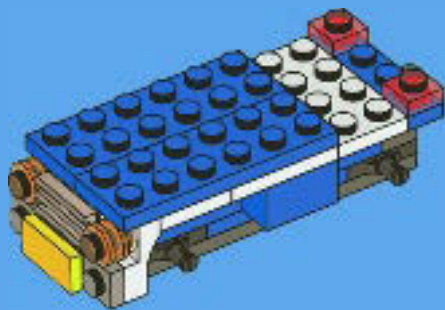



2x



2x



4x

# 9

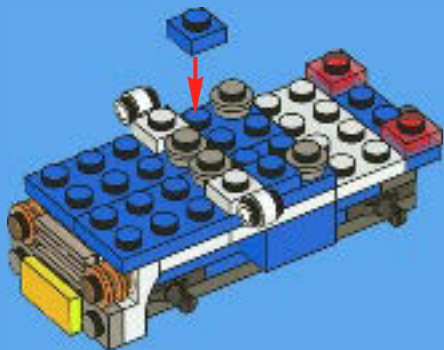

1x



1x

# 10





4x



1x

# 11

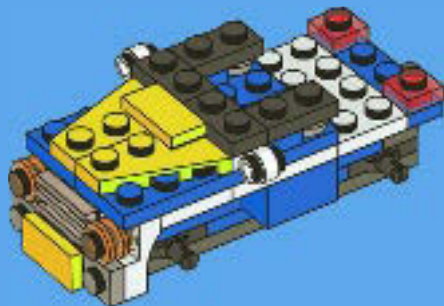

1x



2x

# 12

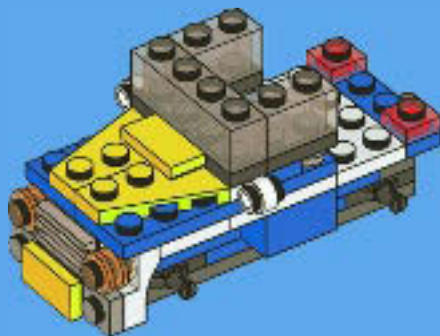



2x

13

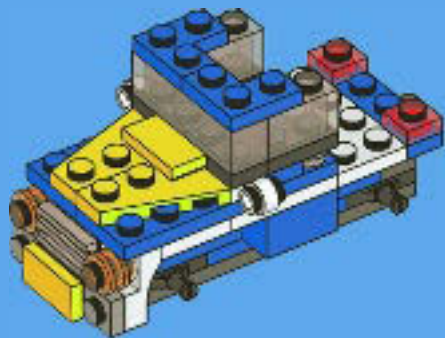

1x

14

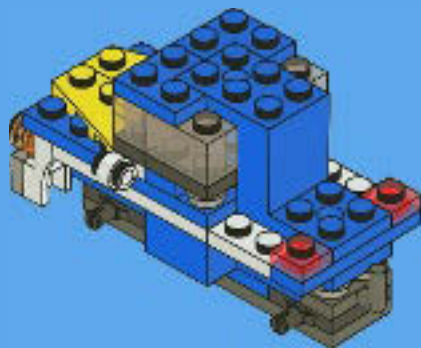



1x



2x

15

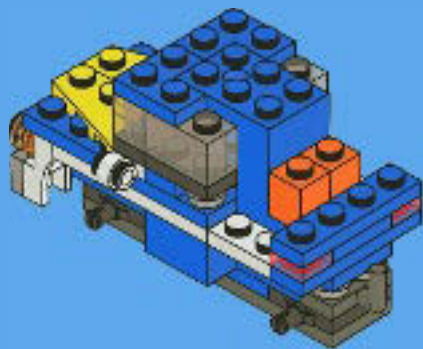





2x



2x

# 16

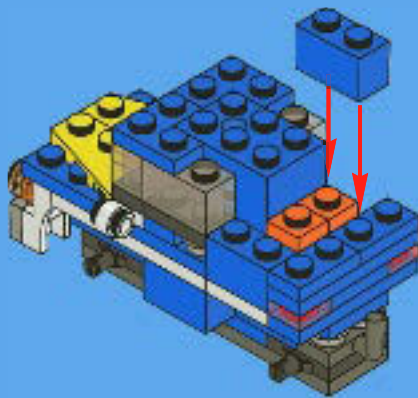



2x



2x



1x

# 17

1



2



2x

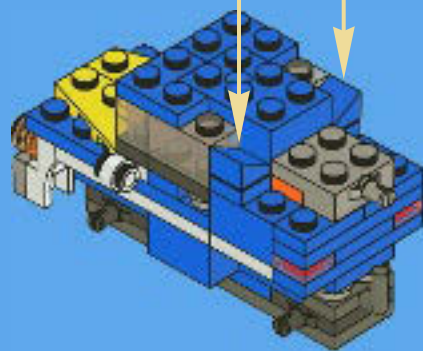



2x



4x

# 18

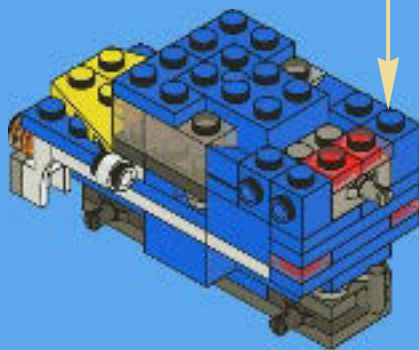



2x



1x

19

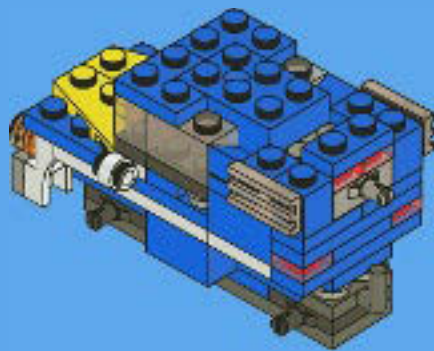



1x

20

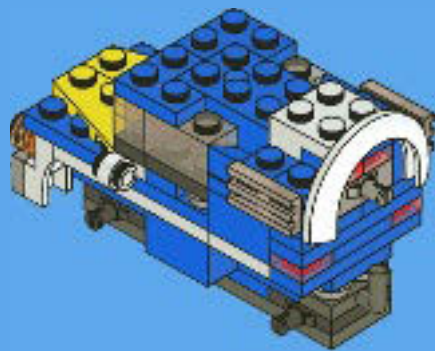



1x



2x



1x



1x

# 21

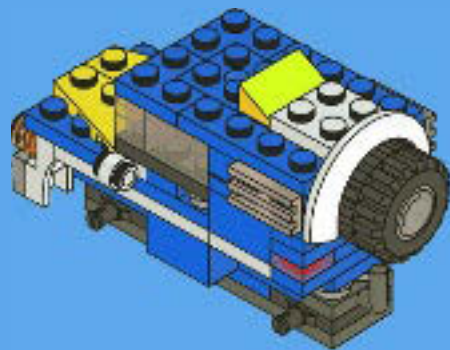



2x



1x



1x

# 22

1



2

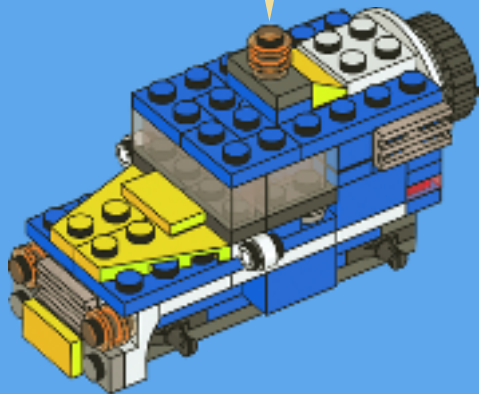



2x



2x

# 23

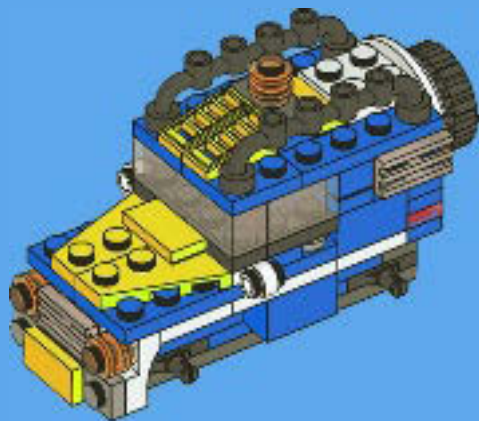





4x



4x

# 24





1x



1x

1

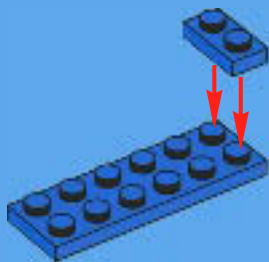

4x

2

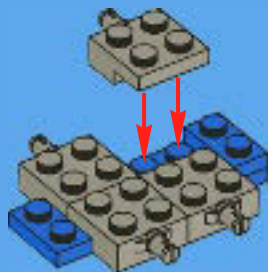



2x

3

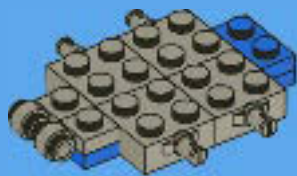

2x

4

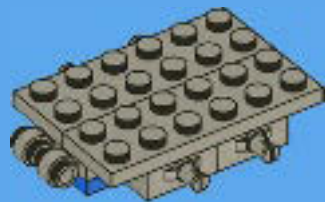



1x



2x



2x



1x

# 5

1

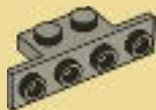

2



1x

# 6

2x

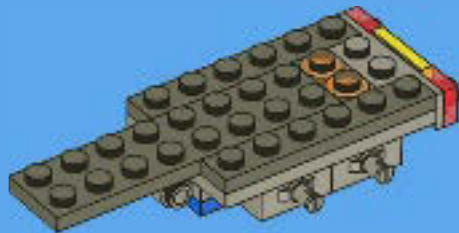



1x



1x



4x

# 7

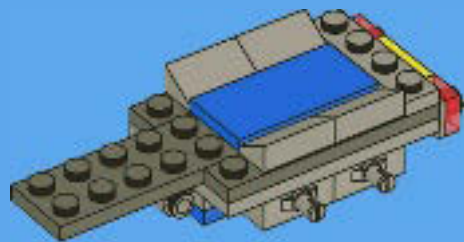

1x



2x



1x

# 8

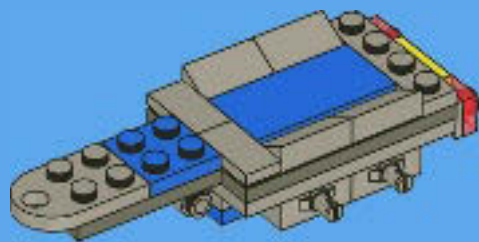



4x



4x



1x

9

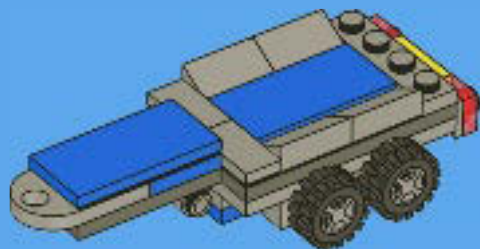

25

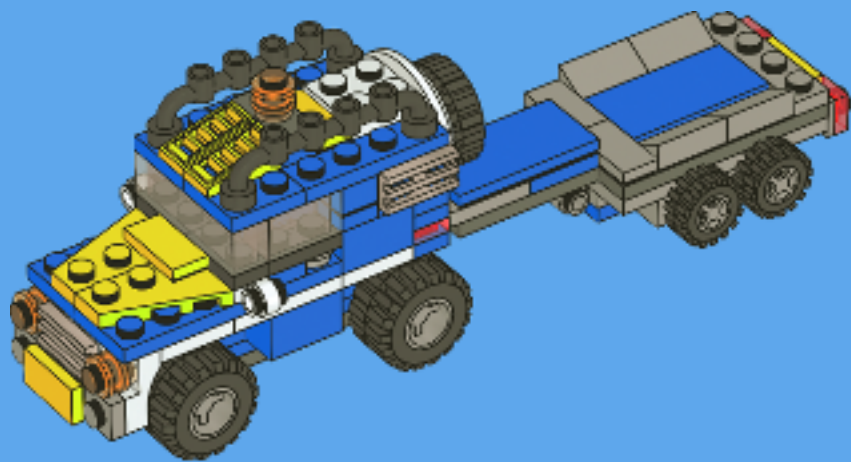

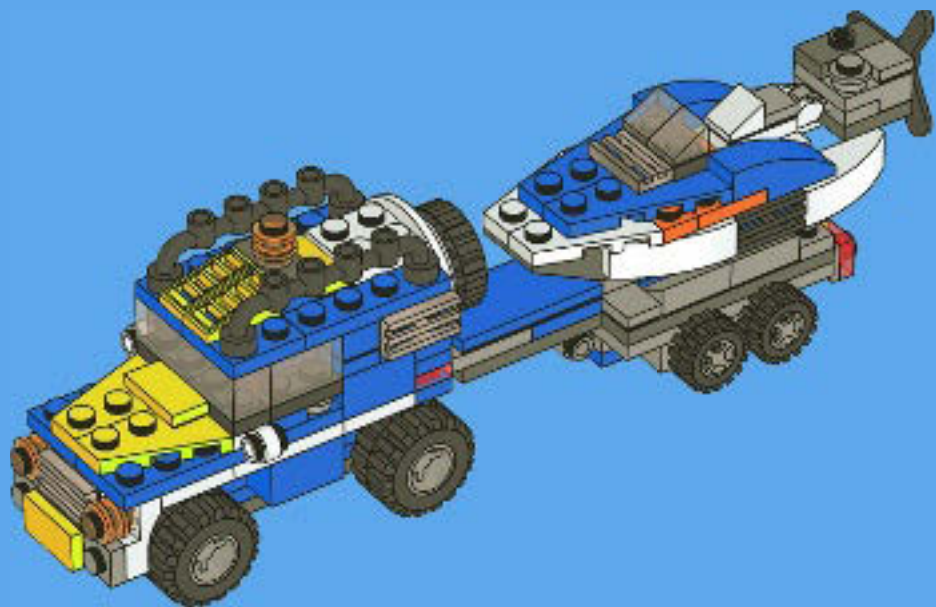





1

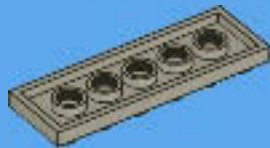

2

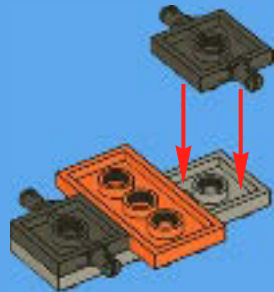



2x

3



2x



1x



1x

4

1

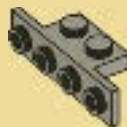

2





2x



1x

# 5

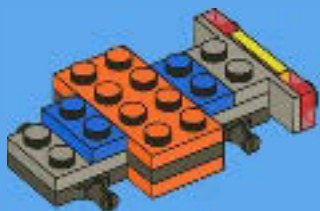

2x



1x



1x



1x

# 6

1

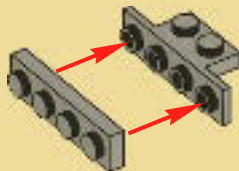

2

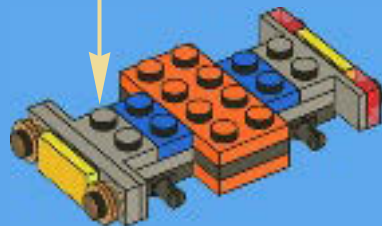



1x



1x

7



2x

8

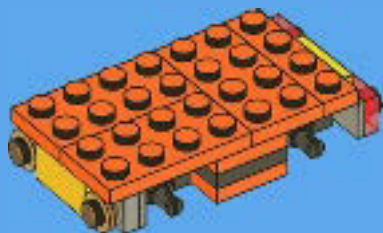



1x



1x

9



2x



1x

10





2x



2x

# 11

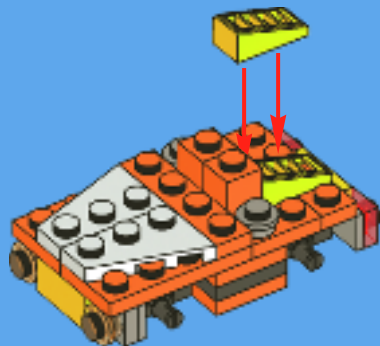

2x

# 12





4x

13



4x



4x

14





1x

1

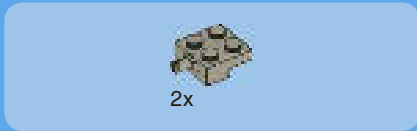
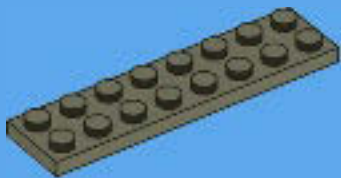

2x

2

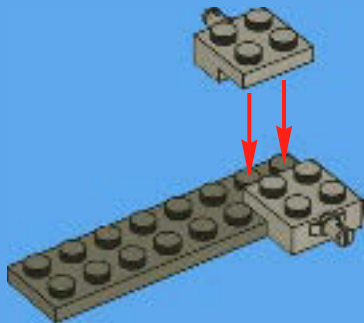





1x



2x

3

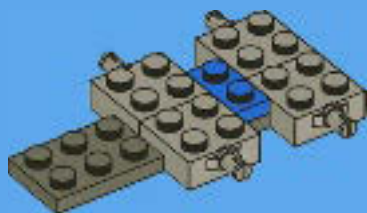

1x



1x

4

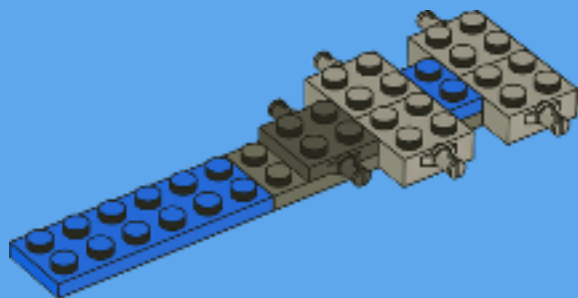



1x

5

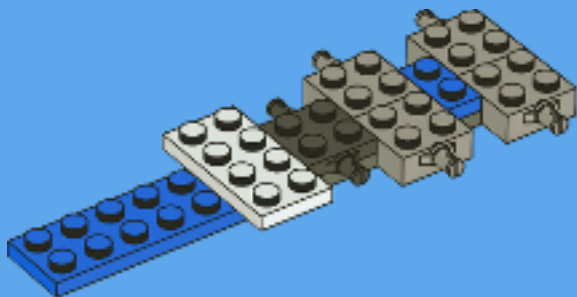

1x



1x



2x

6

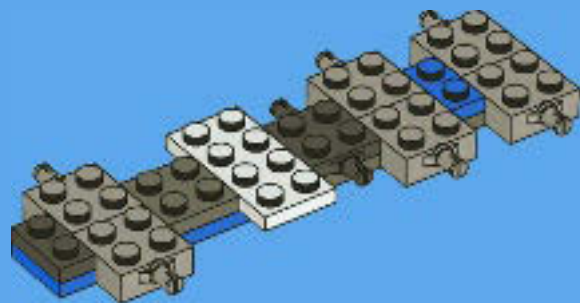



2x



2x

7

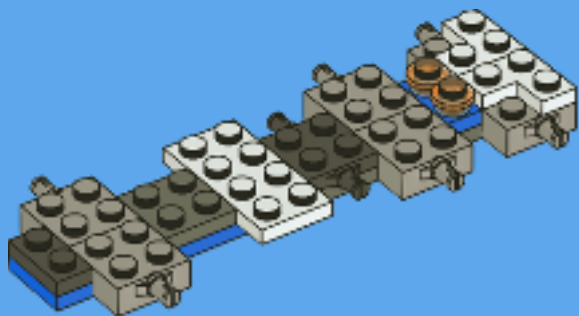

2x



2x

8

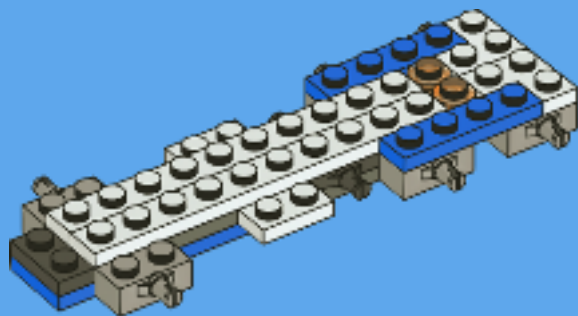



1

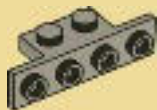

2

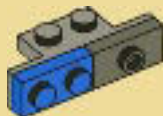

3

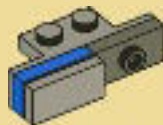

9

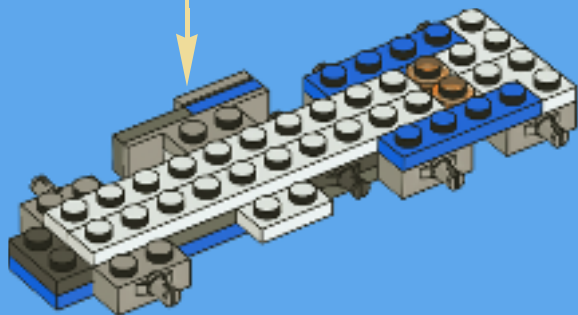



10

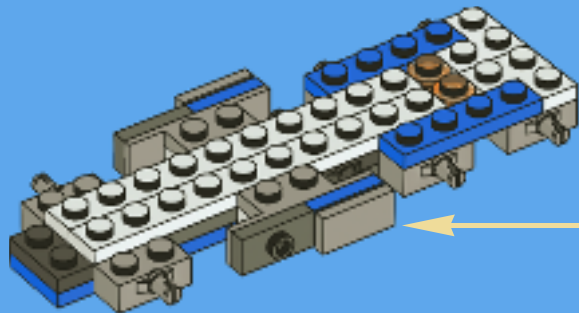
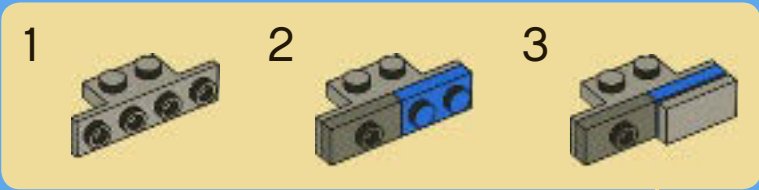



2x



2x



1x

# 11

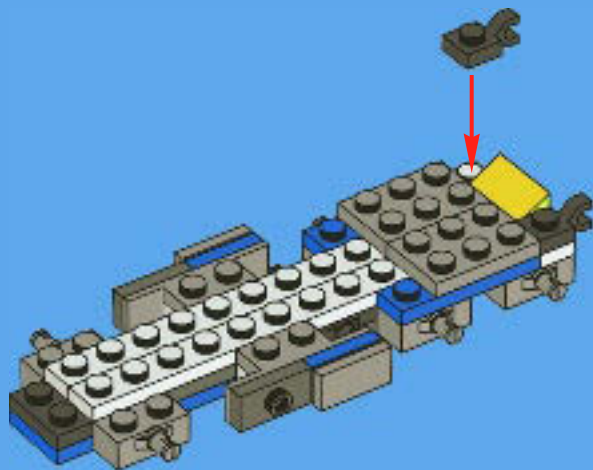

1x



2x

# 12

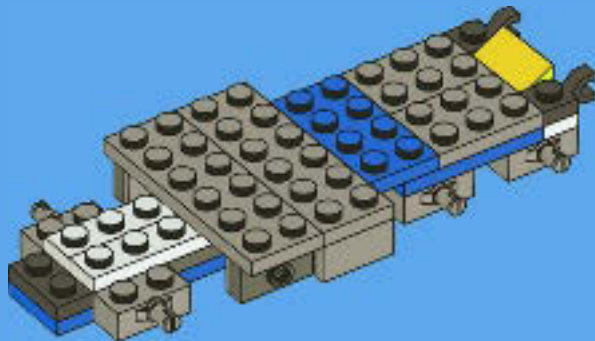



1x



1x

# 13

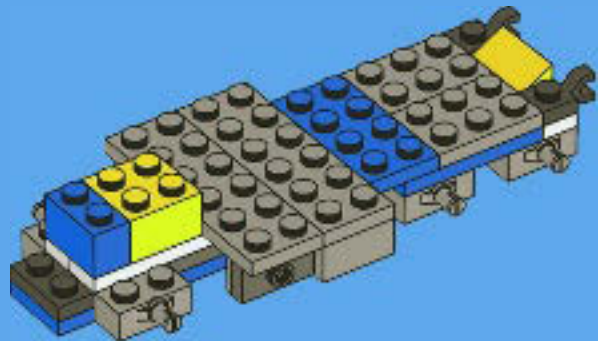

1x



2x



1x

# 14

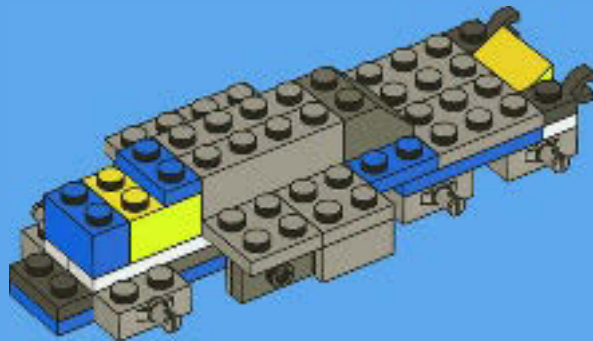



2x

# 15

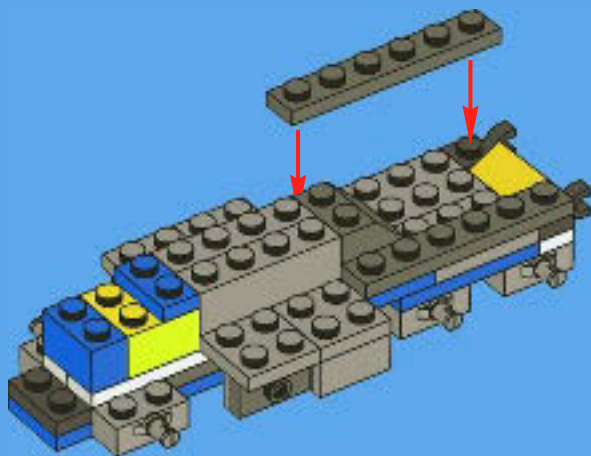

2x



2x

# 16

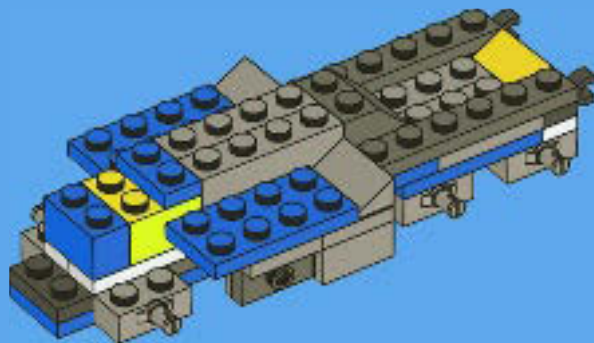





1x



2x

# 17

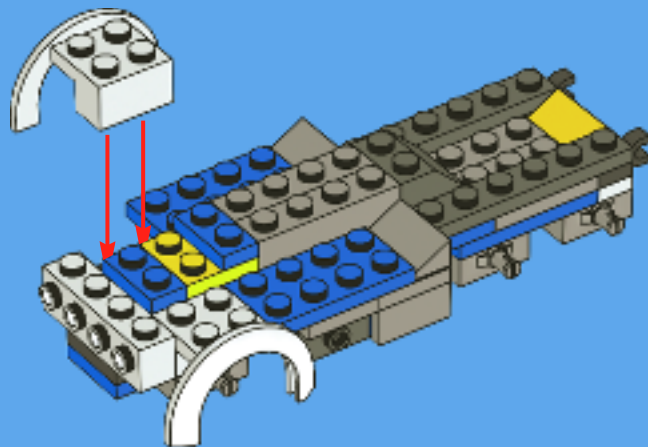



2x



1x



2x

# 18

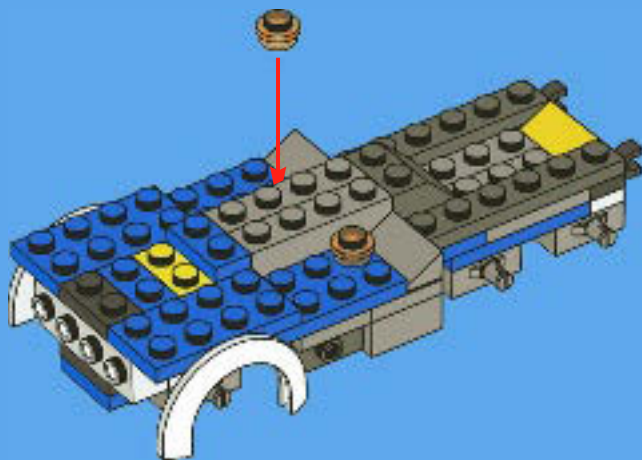



1x



2x

# 19

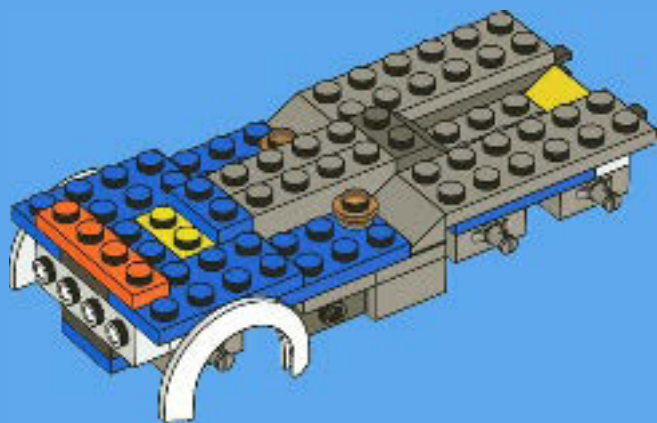



2x



1x



1x

# 20

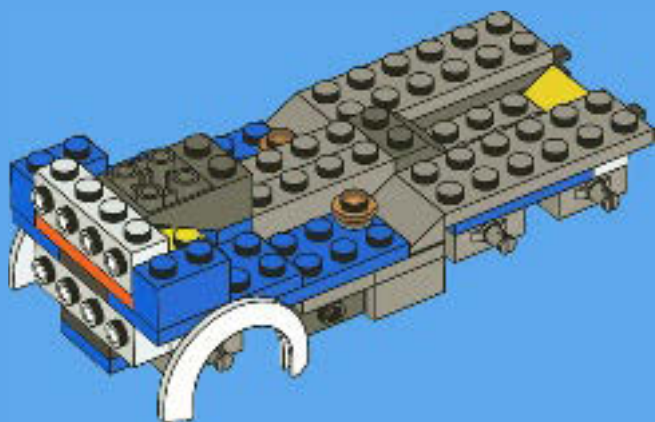



1

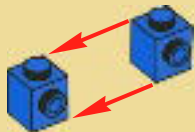

2



21

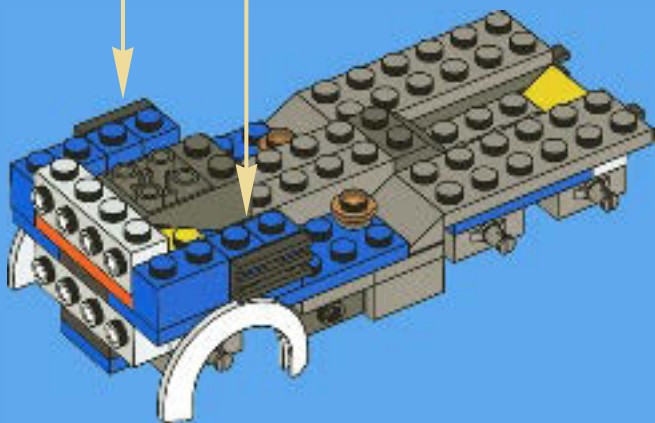



2x

22

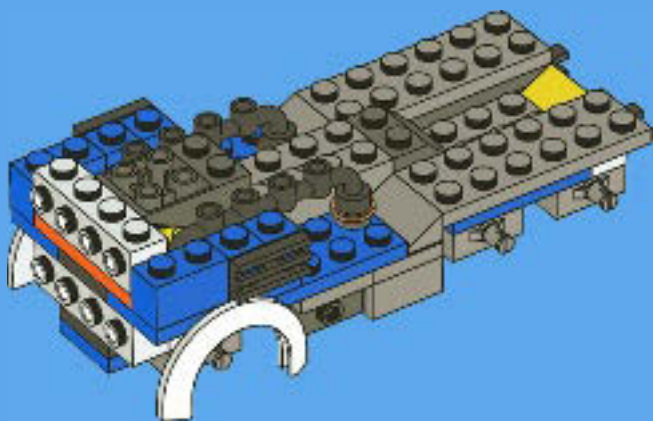



2x



1x



1x

# 23

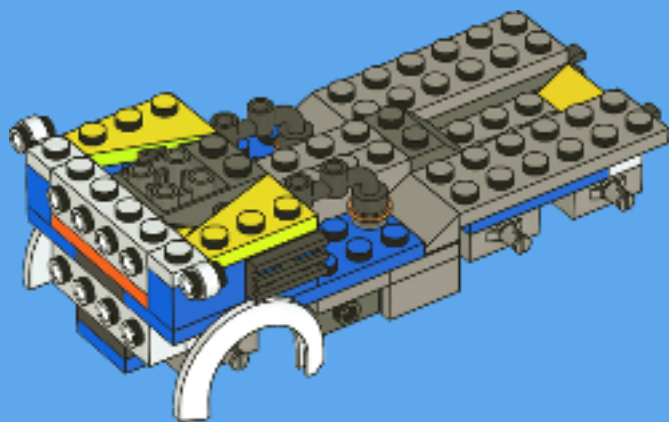



1x



1x



1x

# 24

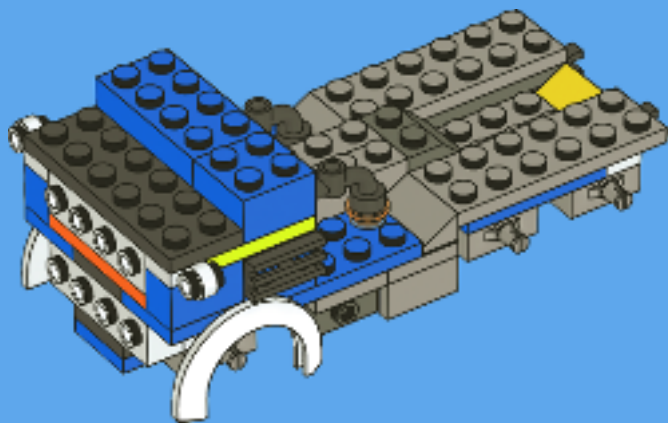





2x

1

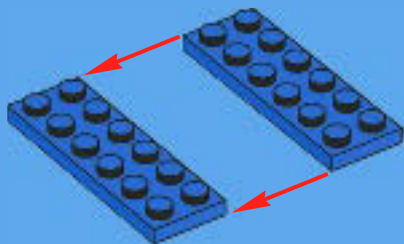

2x

2





1x



4x

3

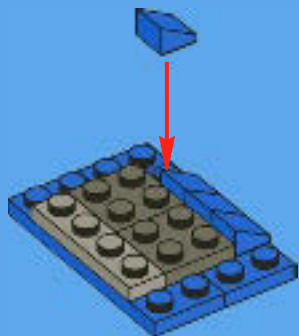

2x



2x

4





1x



2x



4x

5

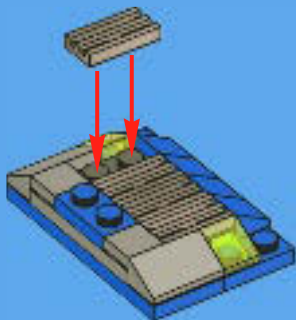

1x

6

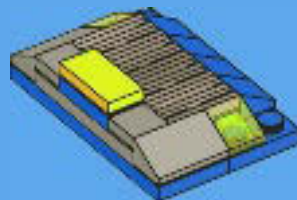

25

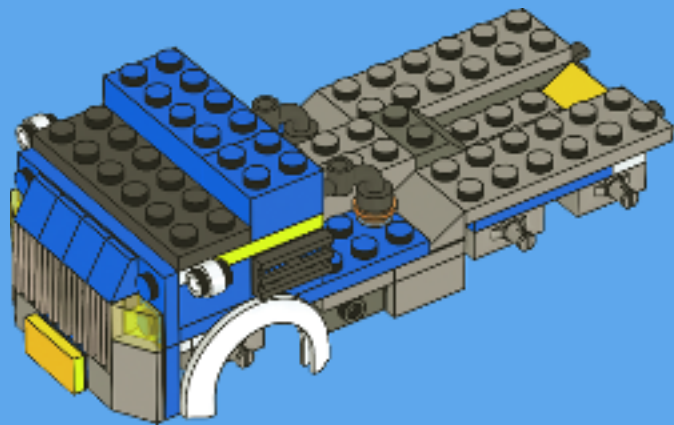



1x

26

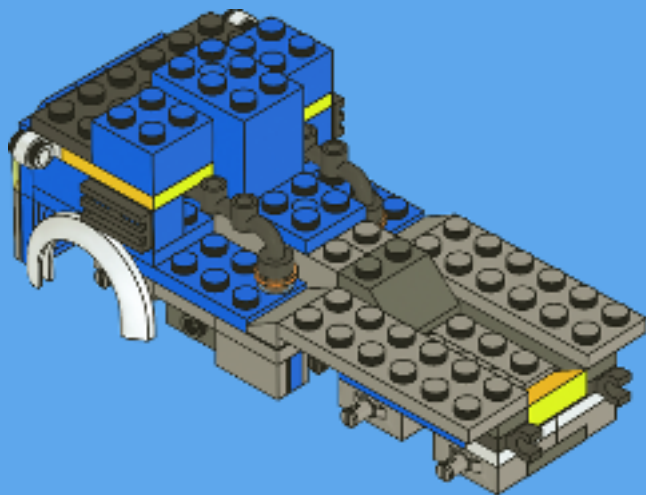



1x



2x



2x

# 27

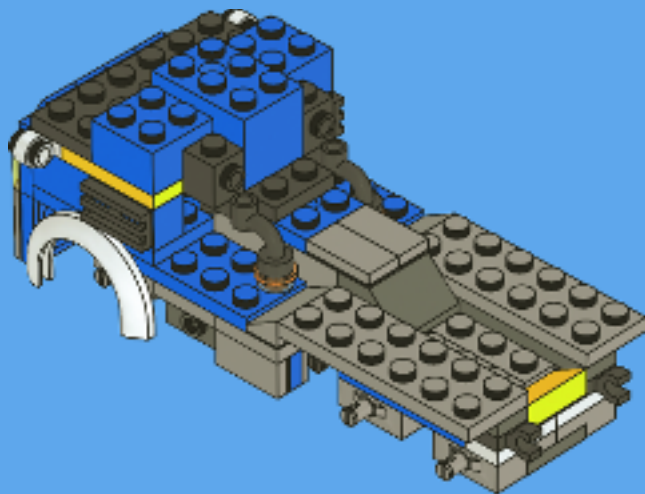



4x



2x

28

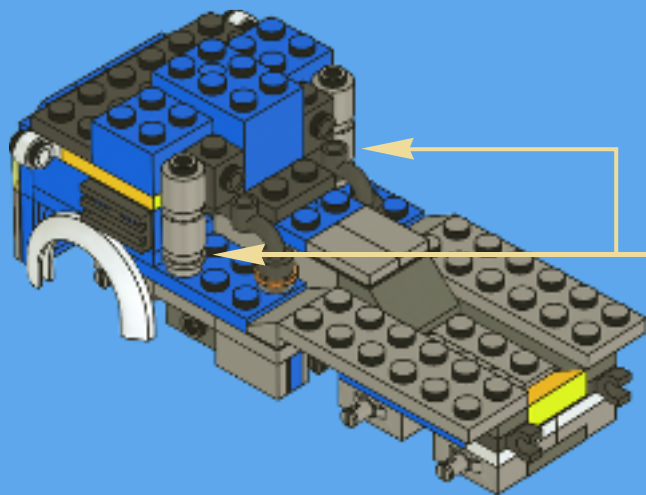

2x



2x



1x

# 29

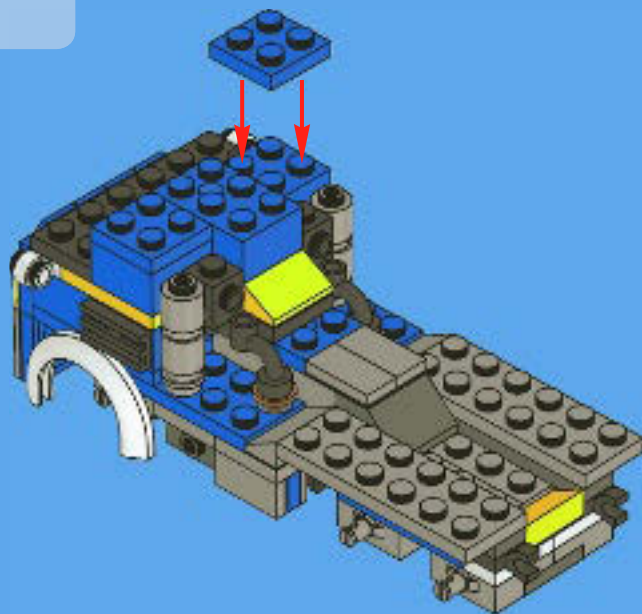





2x



1x

30

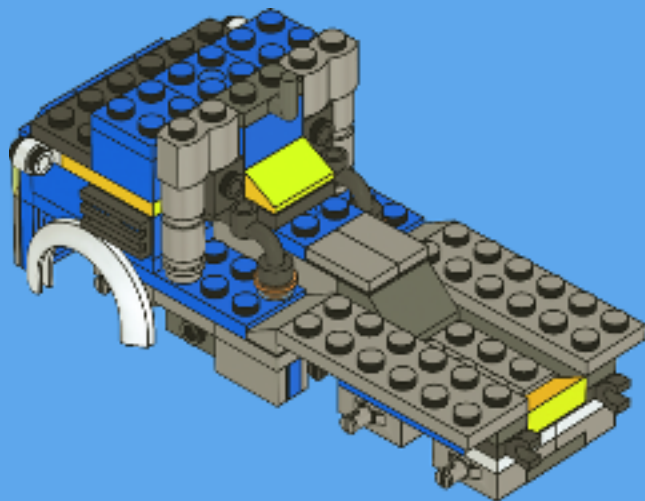



1x



2x

# 31

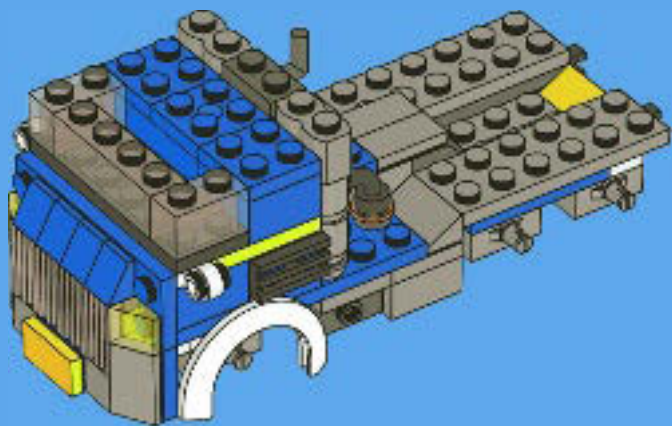



1x



1x



1x

# 32

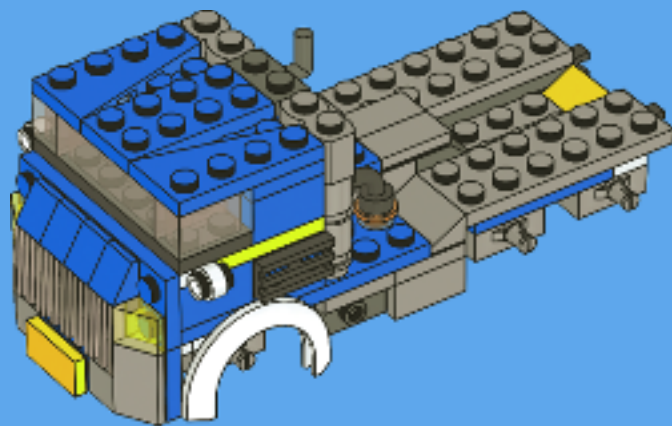



1x



1x



2x



2x

# 33

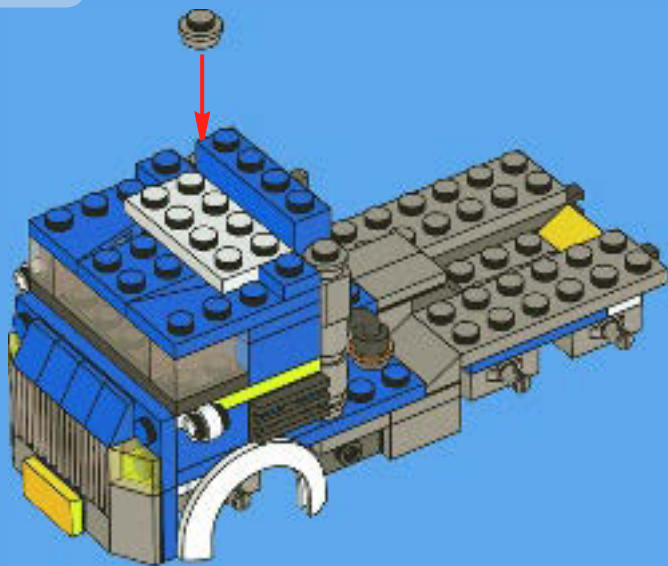



2x



2x

# 34

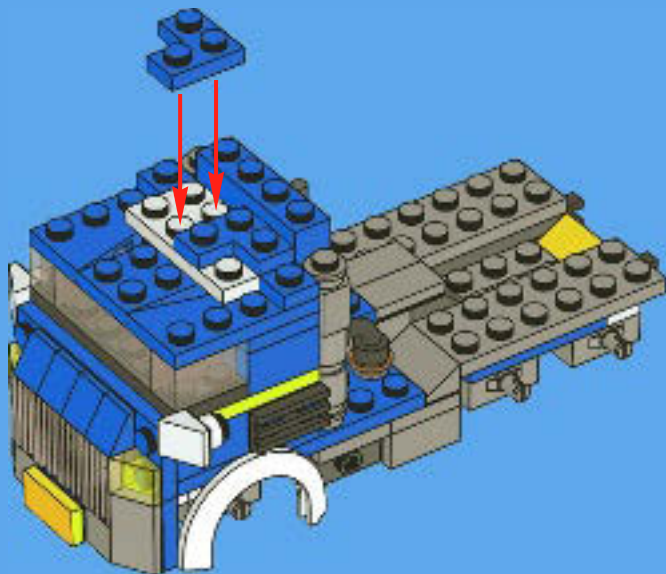



2x



1x

# 35

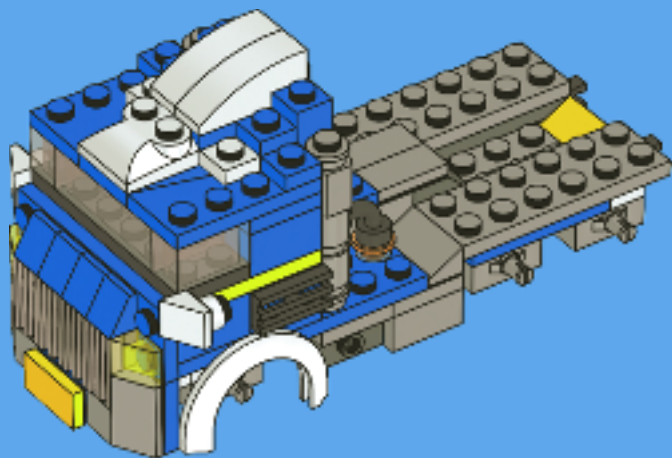



2x



2x

# 36

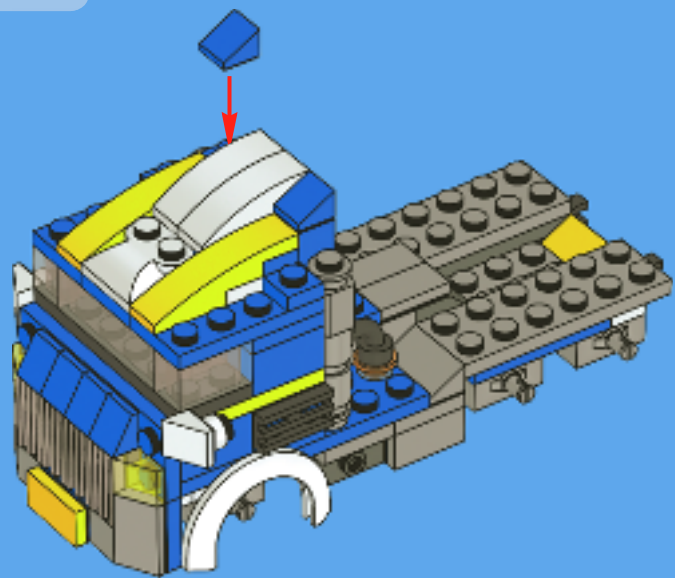



2x



2x



2x



# 37

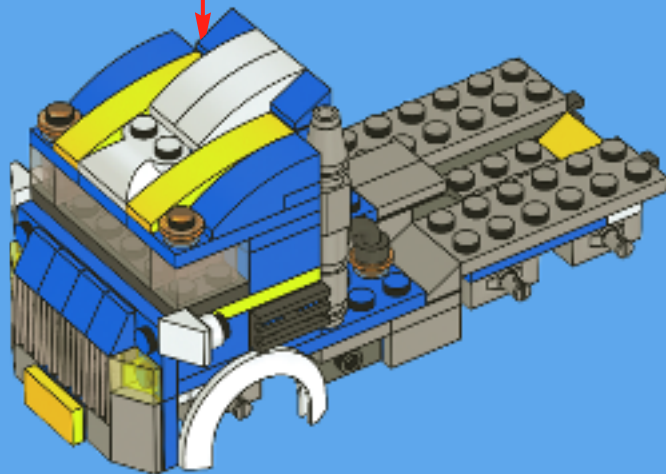





1x

1



2x



2x

2

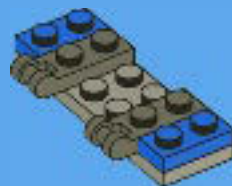



2x

3

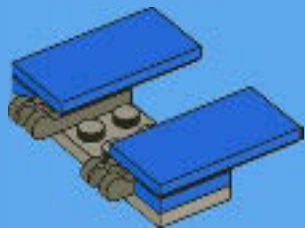

2x

4

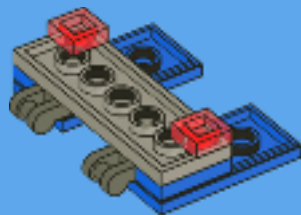

38

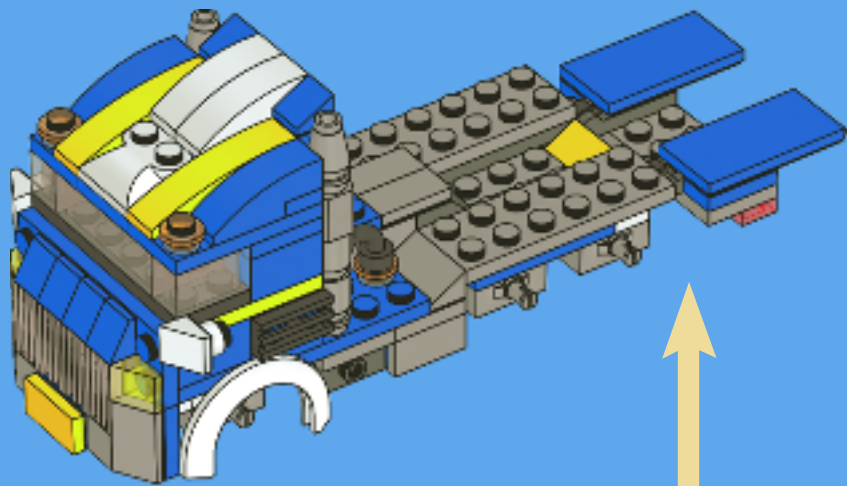



1x

39

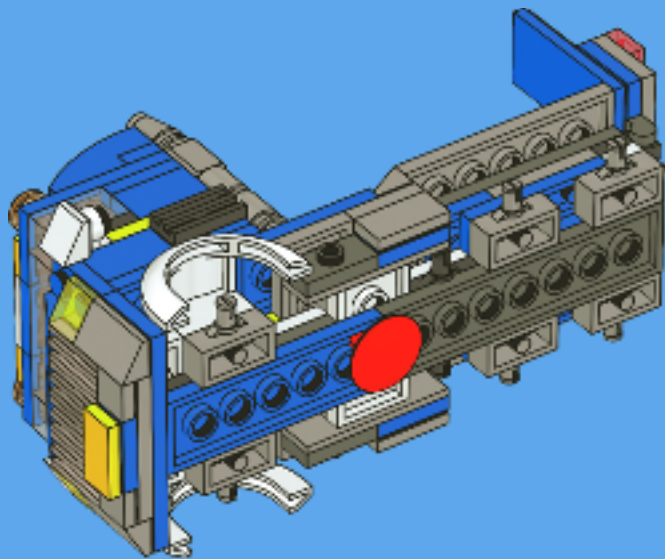



6x



6x

40

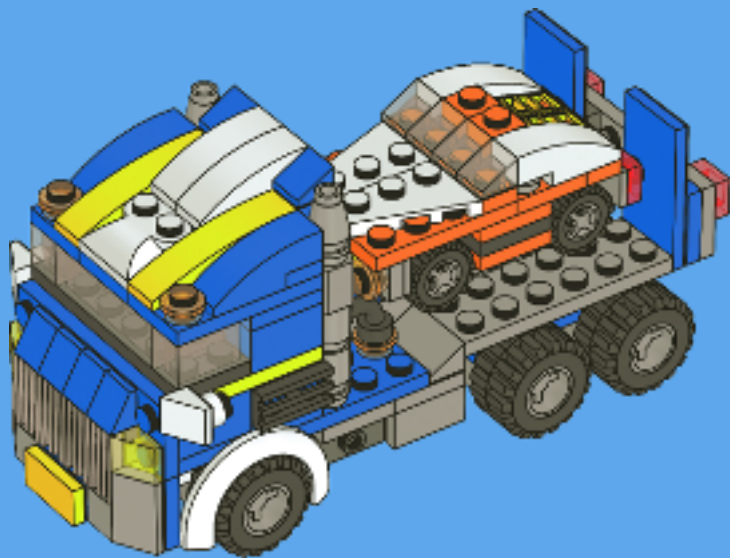



CREATOR

5763





# CREATOR

5764





# CREATOR

5766







CREATOR

5892





# TECHNIC

8068





www.LEGOclub.com



LEGO Club Email



LEGO Club Magazine

**LEGO club**

**FREE! GRATIS! GRATUIT!**

**SIGN UP ONLINE!**

**www.LEGOclub.com**



**00800 5346 5555\***



**1-866-534-6258 • 1-877-518-5346**

US & Canada only

One call enrollment

- \* Freephone. Mobile charges may apply.
- \* Numéro sans frais. Des frais peuvent s'appliquer avec les téléphones cellulaires.
- \* Gebührenfrei. Kosten für Anrufe aus Mobilfunknetzen können abweichen.
- \* Gratis telefoonnummer vanaf vaste lijn.
- \* Det er et gratis nummer, når du ringer fra fasttelefon.
- \* Det är gratis, när du ringer från en fast telefon.
- \* Numéro sans frais. Des frais peuvent s'appliquer avec les téléphones portables.

Go to [www.LEGOsurvey.com/product](http://www.LEGOsurvey.com/product) to fill out a survey for a chance to win a cool LEGO® Product.

No purchase necessary.

Open to all residents where not prohibited.

[www.LEGOsurvey.com/product](http://www.LEGOsurvey.com/product)

## GEWINNE!

Nimm an der Umfrage auf [www.LEGOsurvey.com/product](http://www.LEGOsurvey.com/product) teil und hab die Chance ein cooles LEGO® Produkt zu gewinnen!

Die Teilnahme am Gewinnspiel führt zu keinerlei Kaufverpflichtungen. Teilnahme in allen nicht ausgeschlossenen Ländern möglich.

4625489

## WIN!

Ga naar [www.LEGOsurvey.com/product](http://www.LEGOsurvey.com/product), vul een enquêteformulier in en maak kans op een cool LEGO® product.

Geen aankoopverplichting. Iedereen mag deelnemen, uitgezonderd ingezetenden van landen waar een enquêteverbod geldt.

LEGO and the LEGO logo are trademarks of the LEGO Group. ©2011 The LEGO Group. ©2011 LucasFilm Ltd. & TM. All rights reserved.

## GAGNE!

Visite [www.LEGOsurvey.com/product](http://www.LEGOsurvey.com/product) pour répondre à un questionnaire et avoir une chance de gagner un produit LEGO® très cool!

Aucune obligation d'achat. Ouvert à tous les résidents des pays autorisés.

## 当てよう!

[www.LEGOsurvey.com/product](http://www.LEGOsurvey.com/product) にアクセスして、アンケートにご記入ください。当選者にはレゴ®製品を差し上げます。

お買い上げの必要はありません。禁止されていない限り、すべての皆様にご利用いただけます。