



CREATOR

5766



1

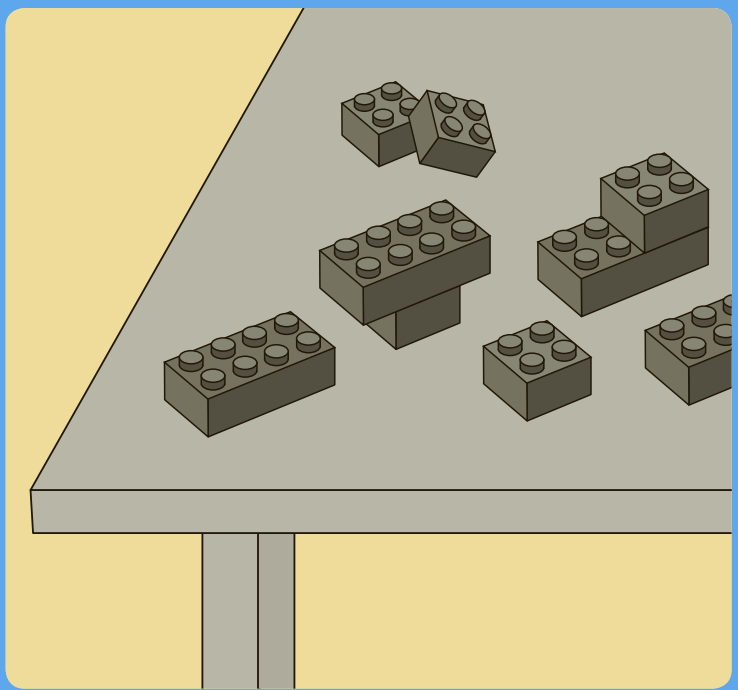
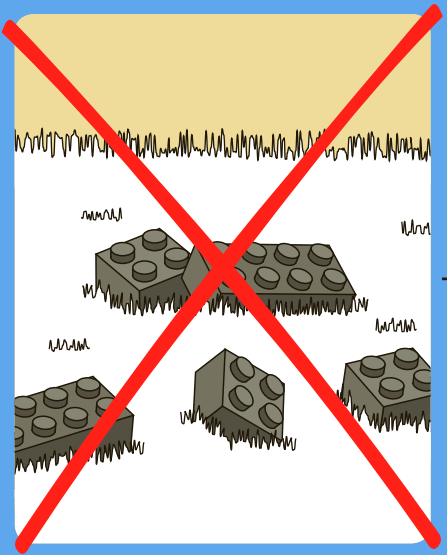

2

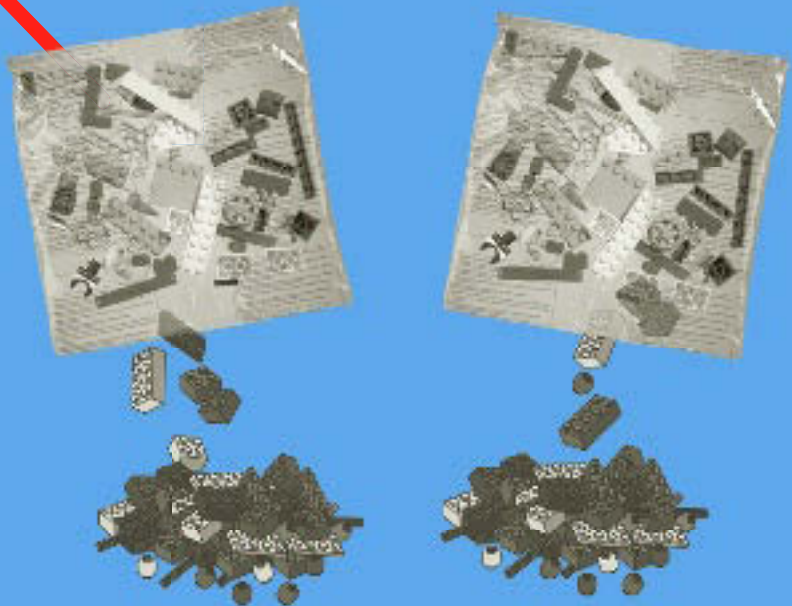

3

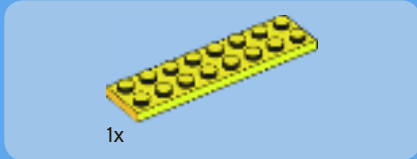
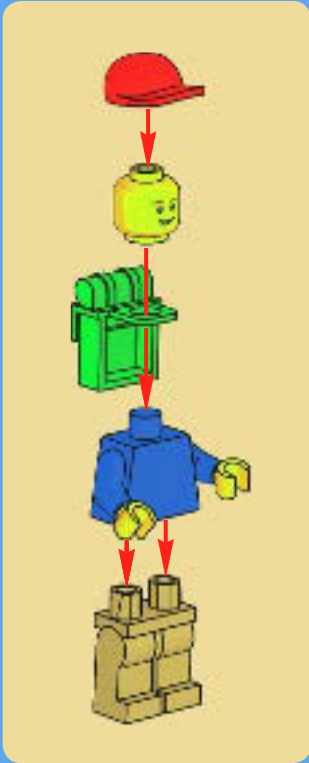

1

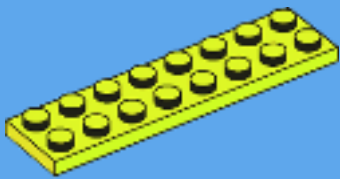

2

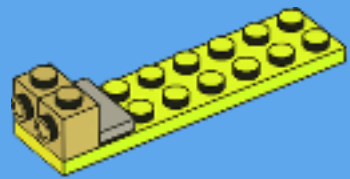



2x



2x

3



4x

5

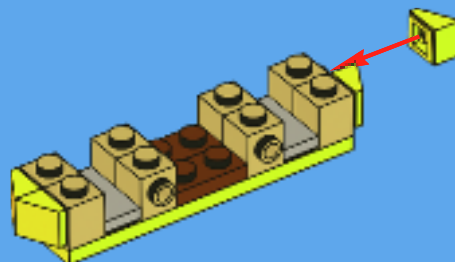

1x



4x

4

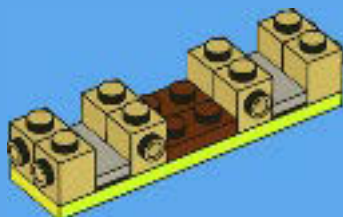

2x

6

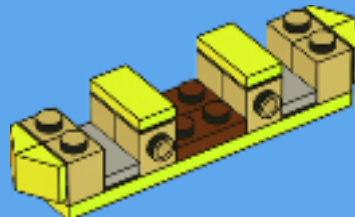



2x



2x



4x

7

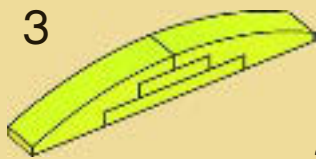
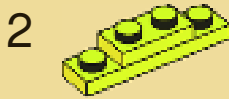

2x

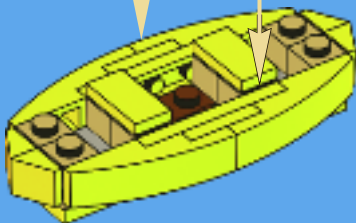

2x

8



1x

9





1x

1x

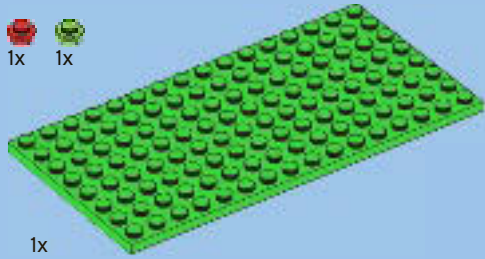

1x

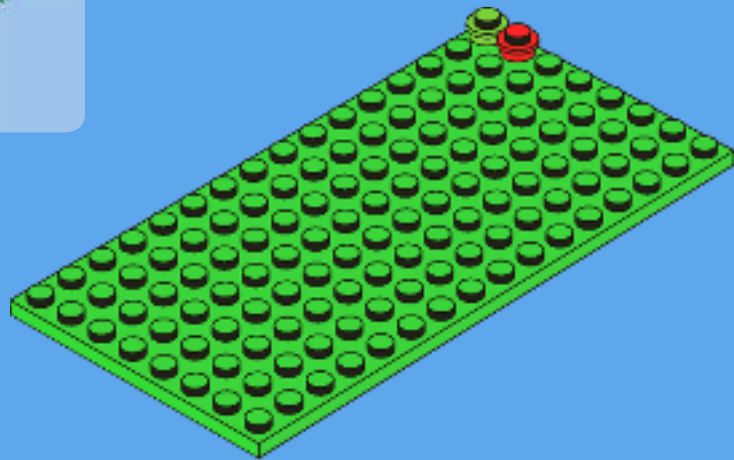

1



1x

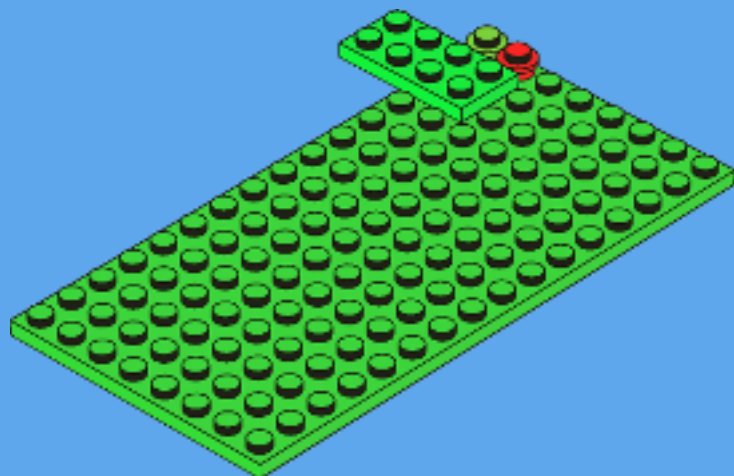

2



1x

3

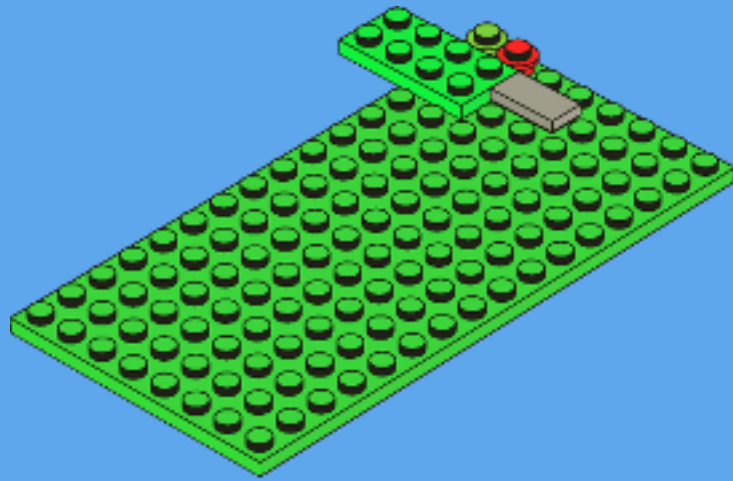

4

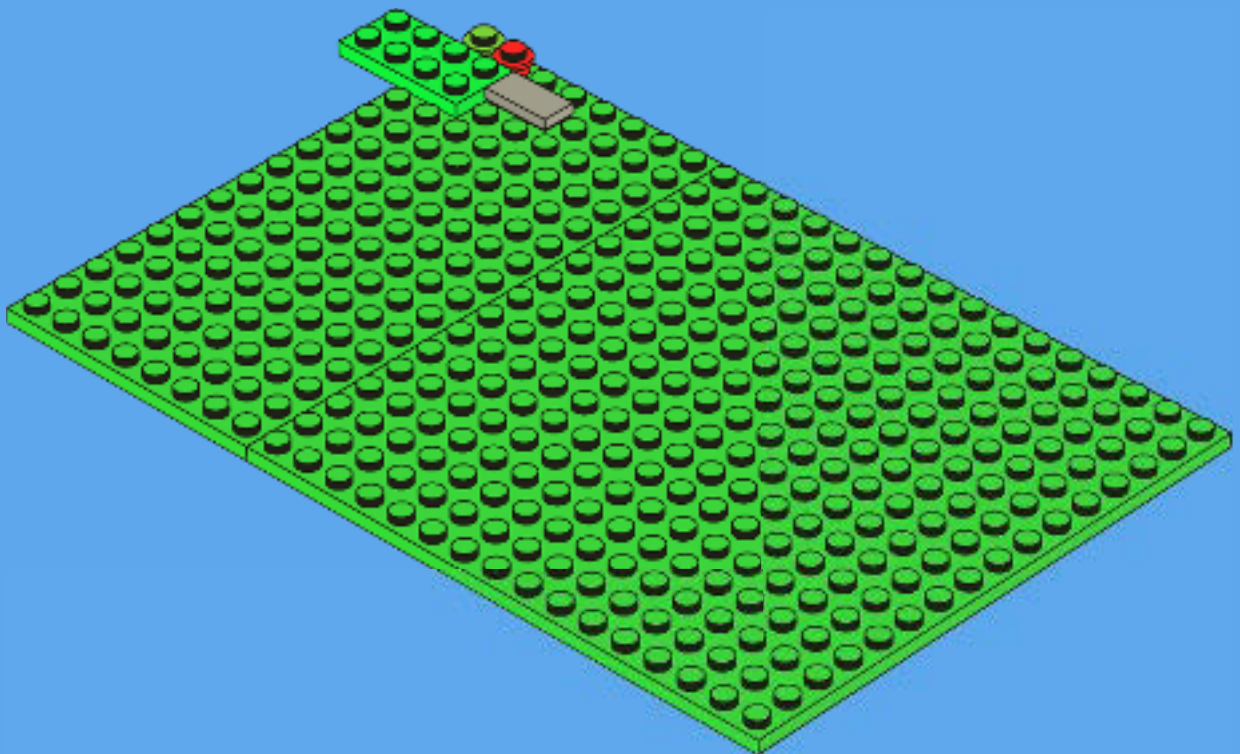



1x



1x



1x

5

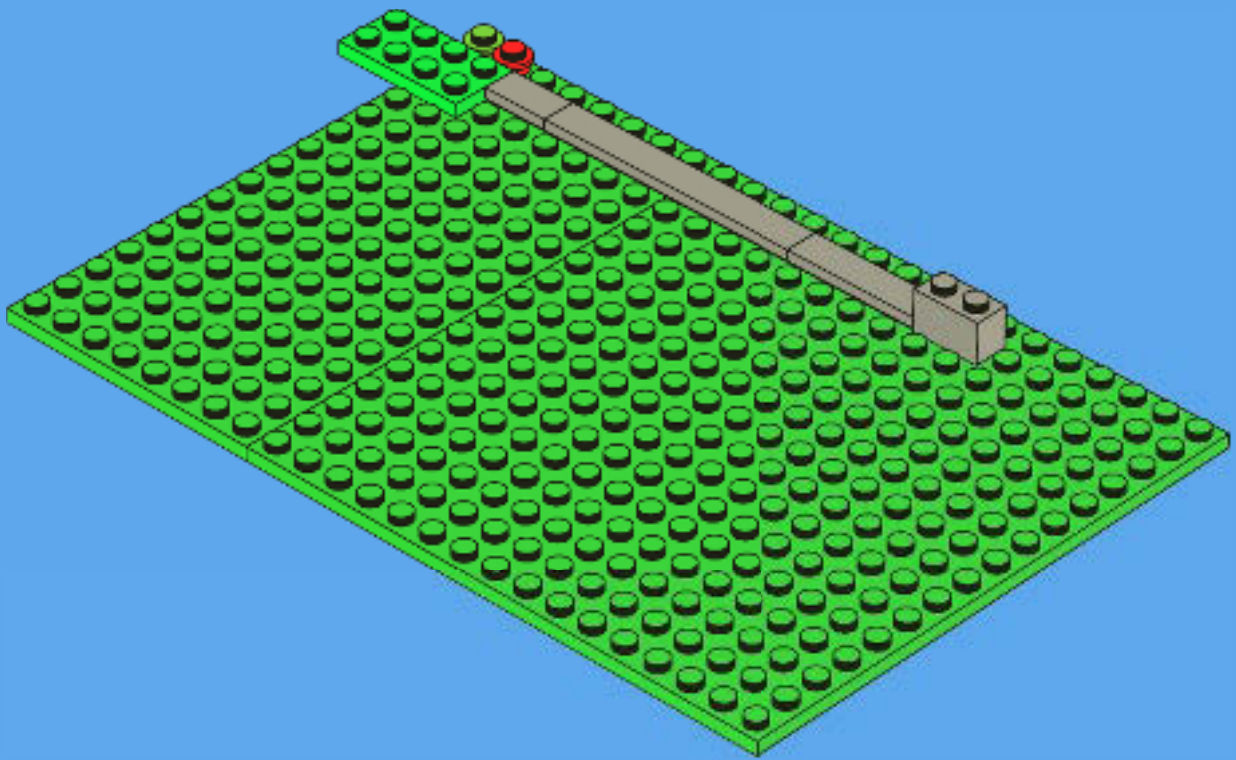

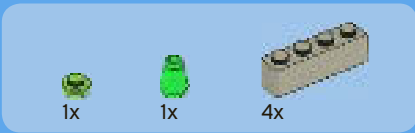

6

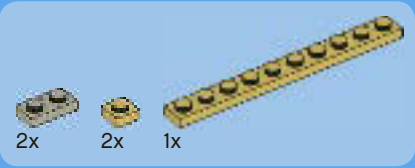
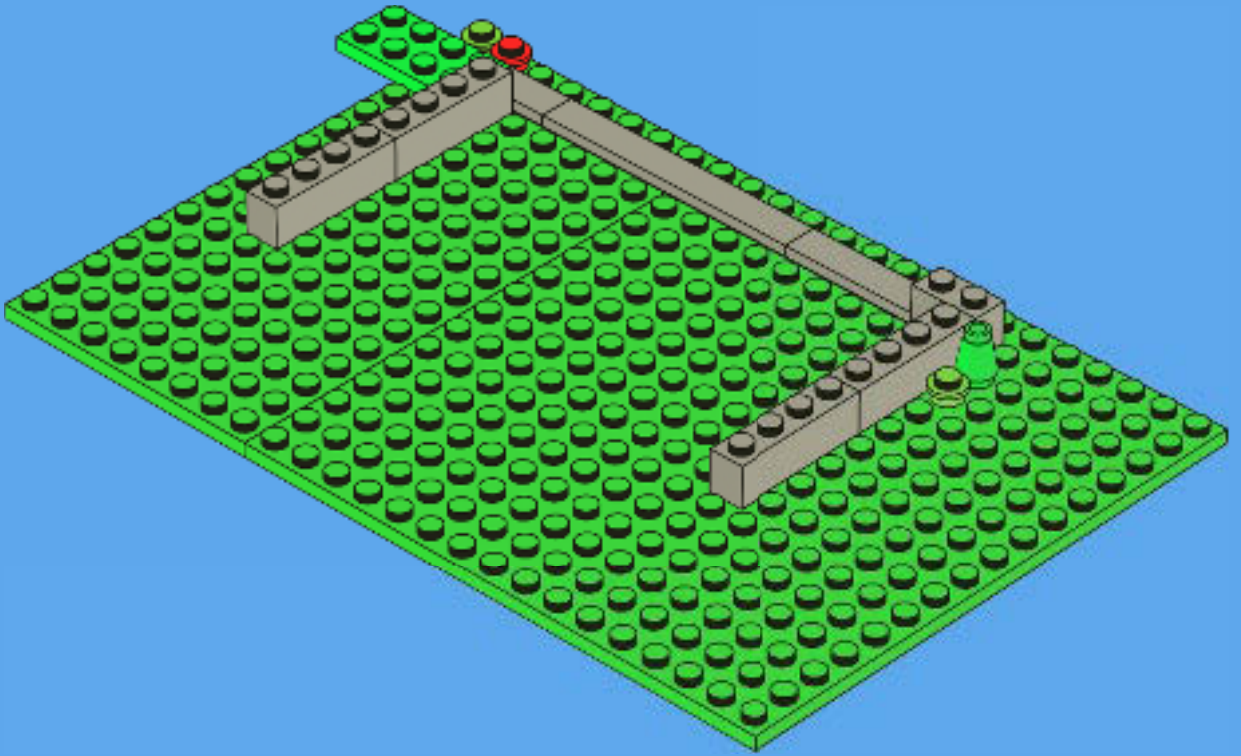

7

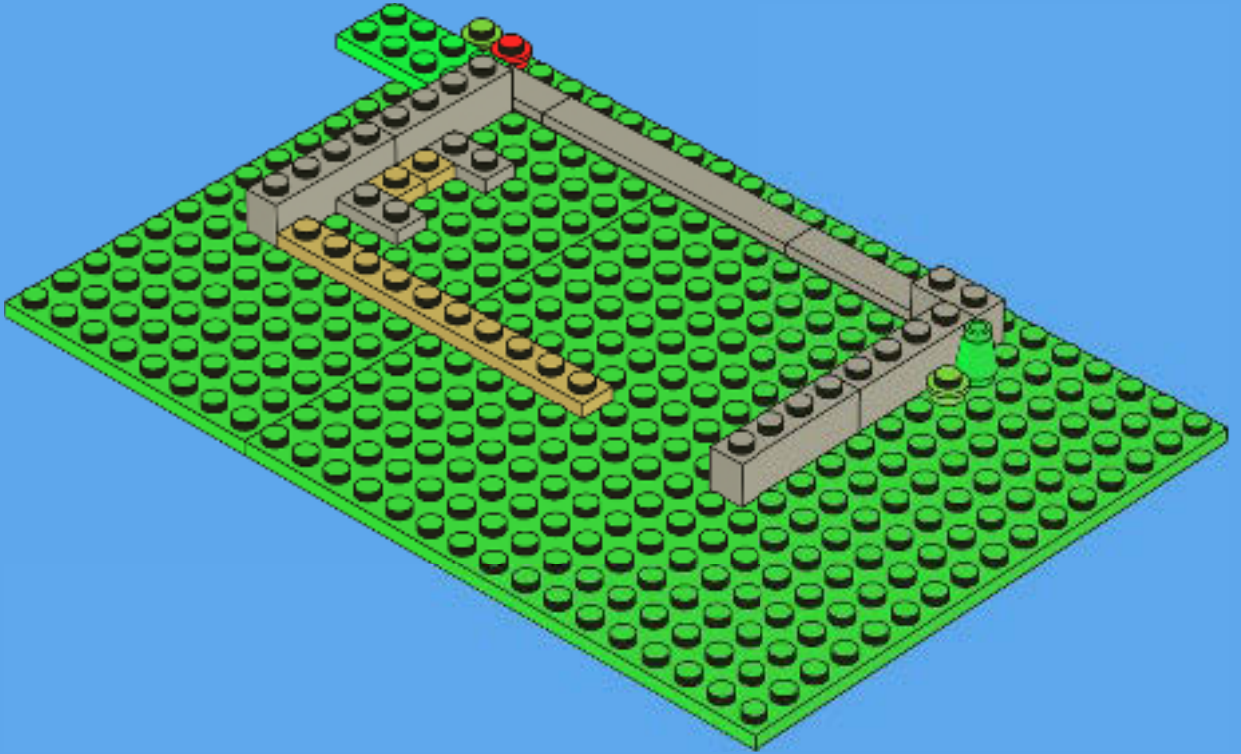

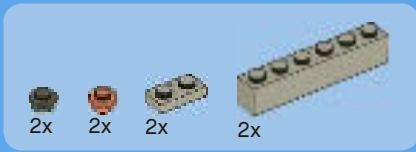

8



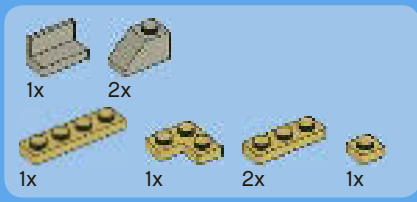

9

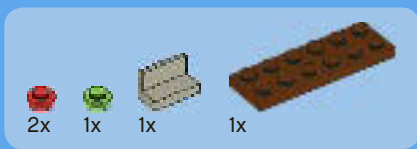
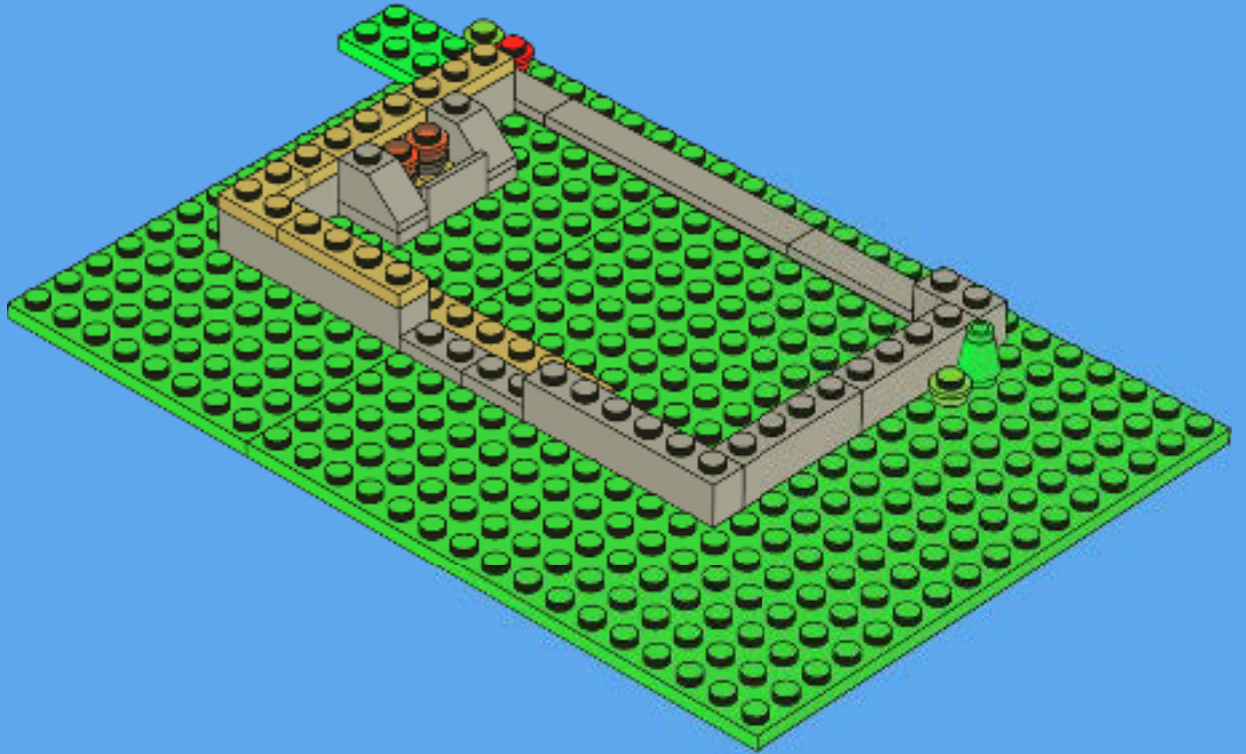

10

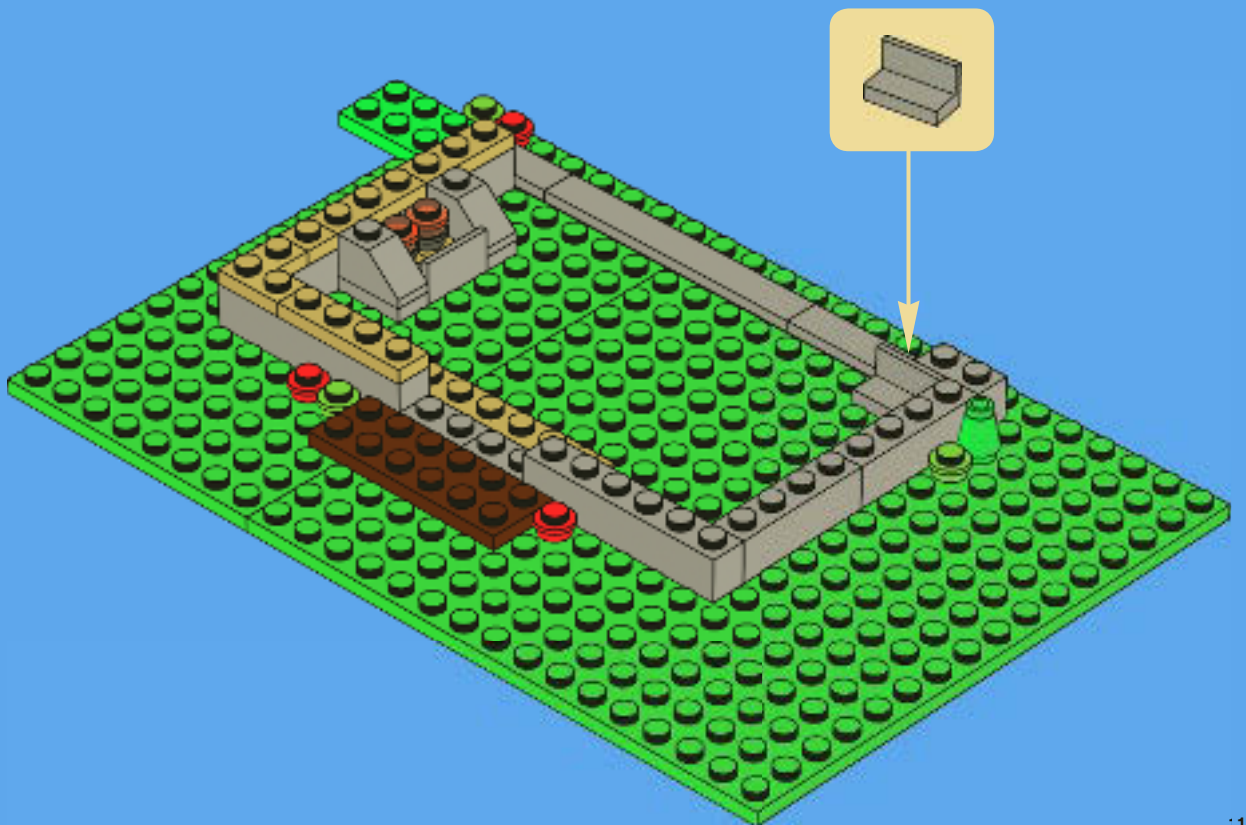

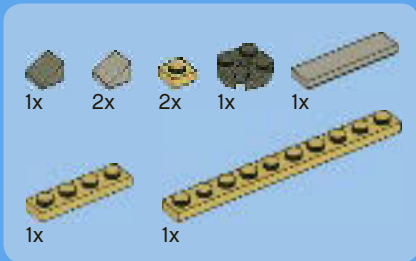

11

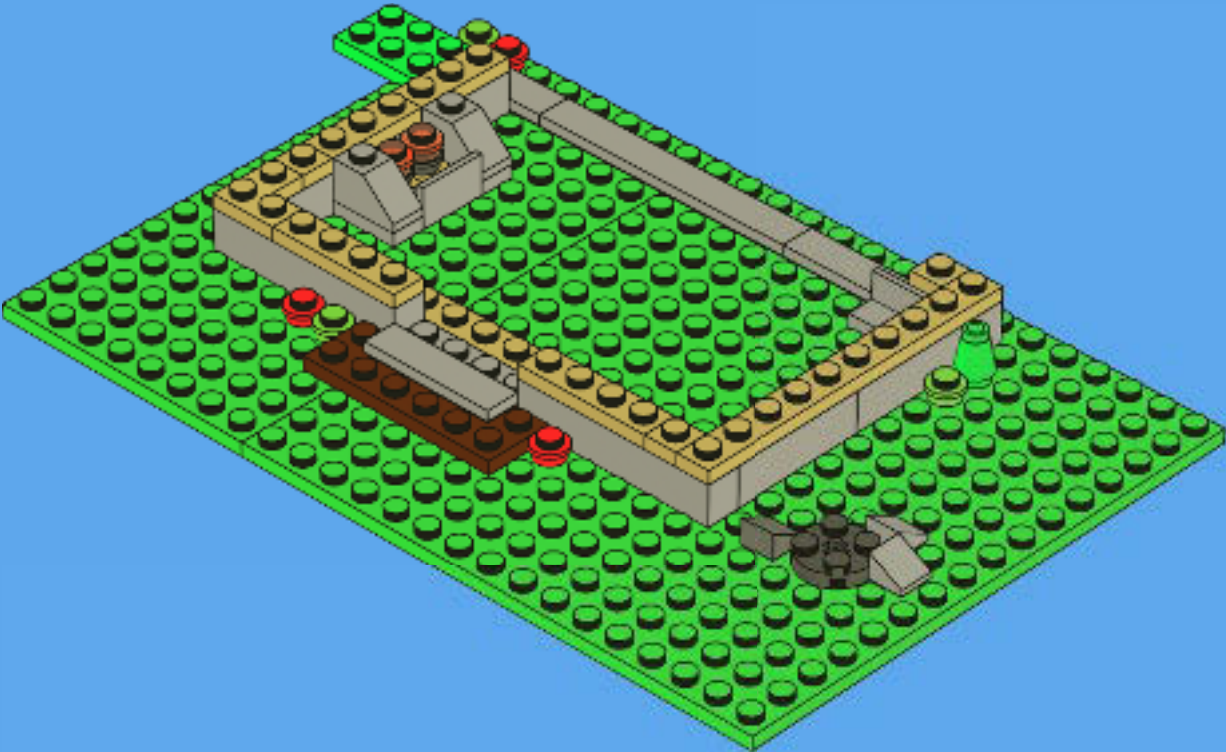



2x



4x



2x



1x



1x

12

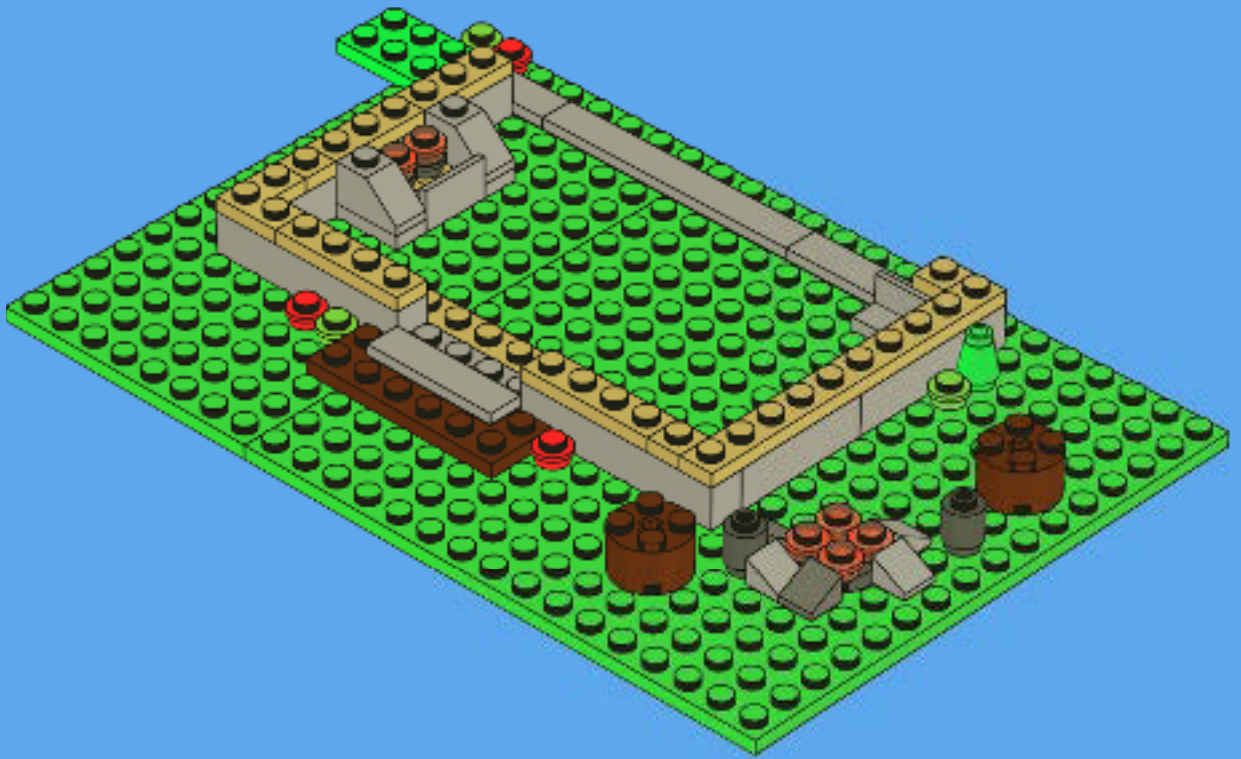

2x



1x



1x



1x

13

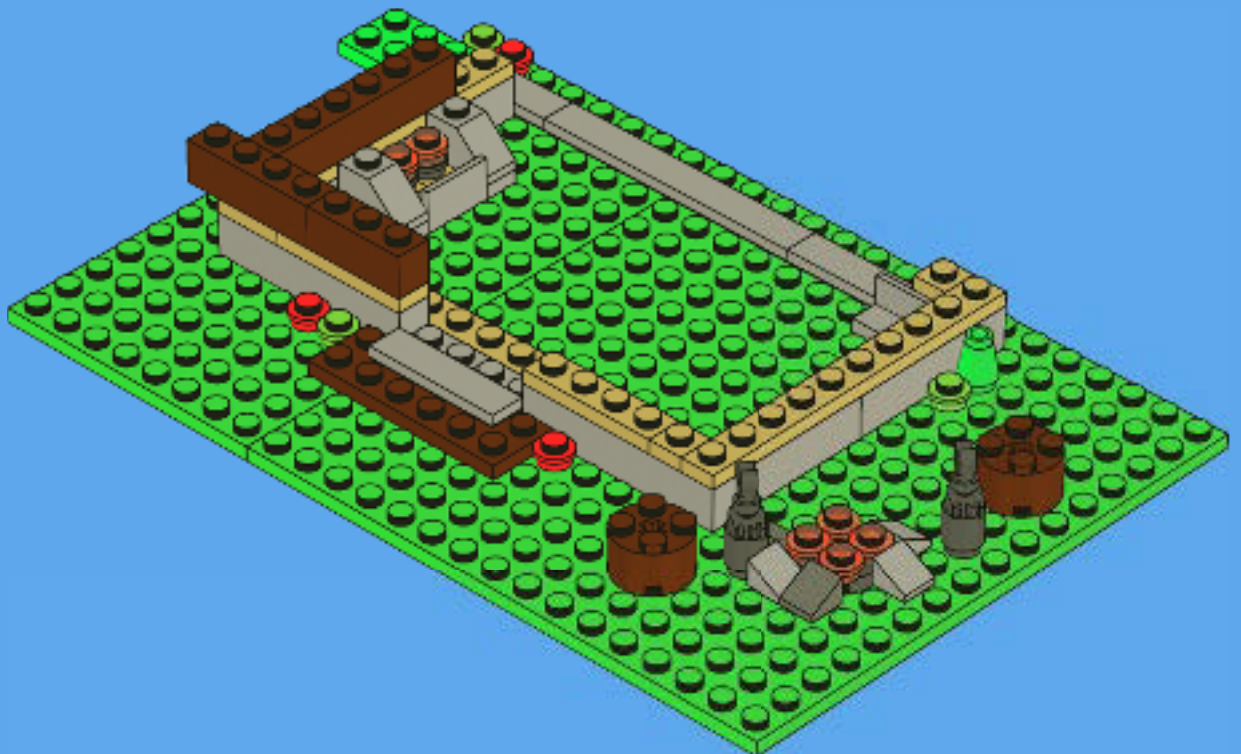



14

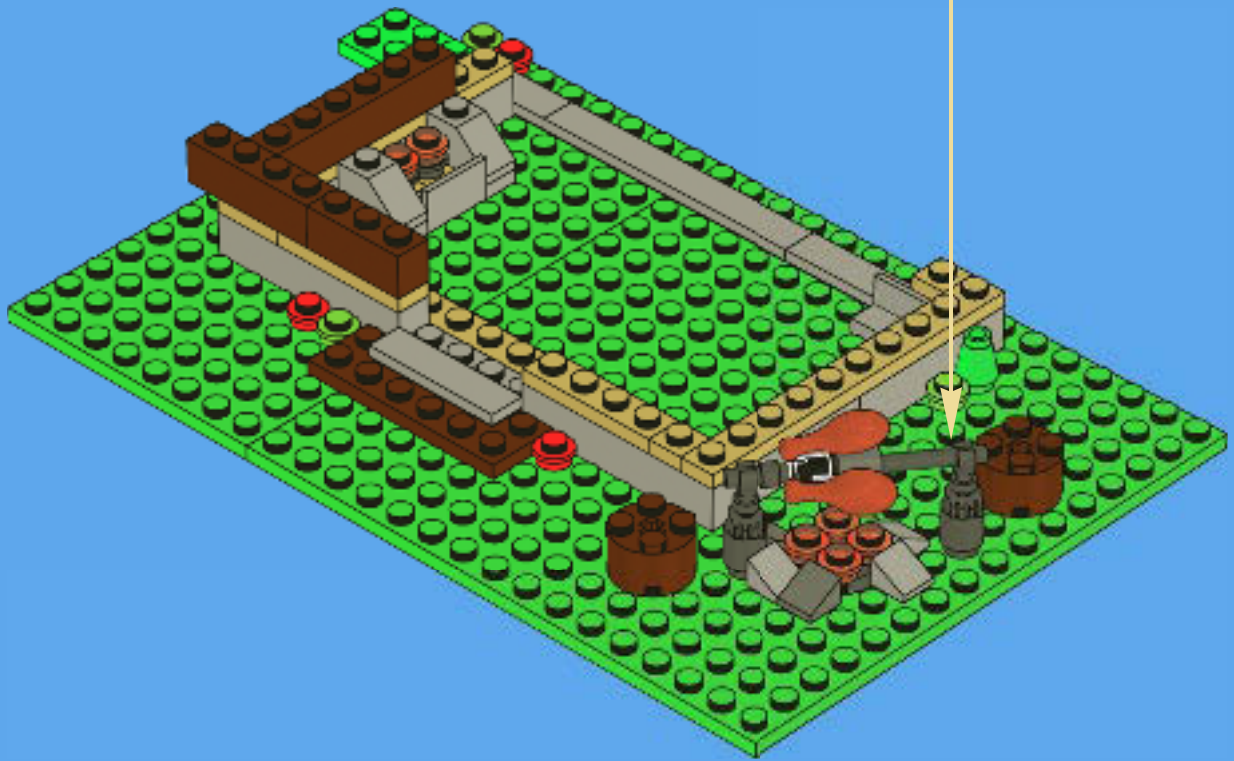
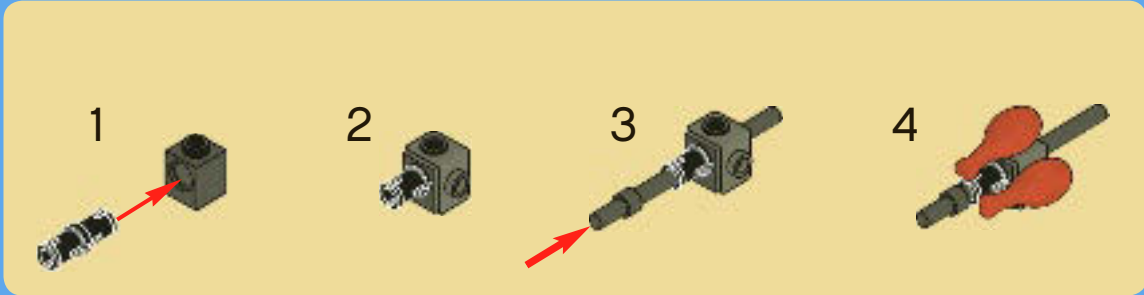



2x



3x

15

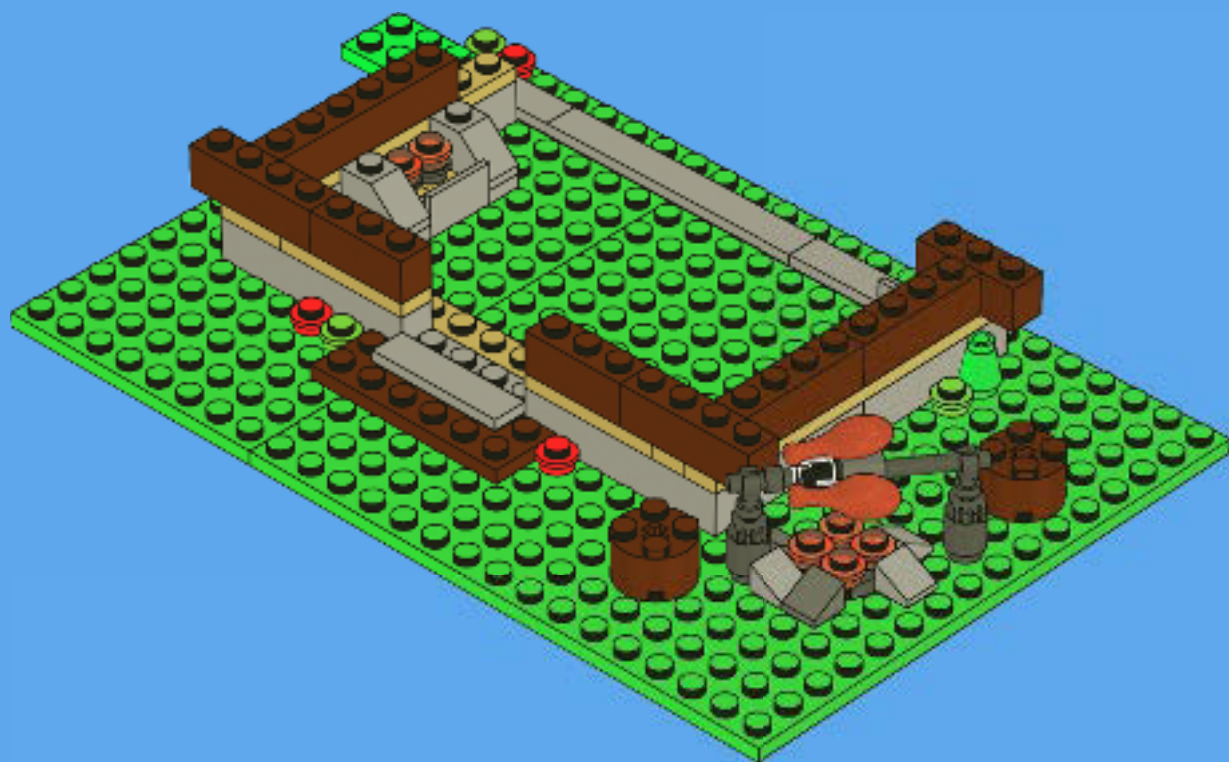

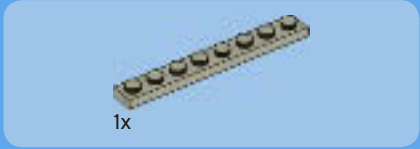

1

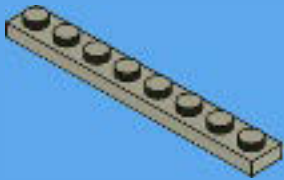

2

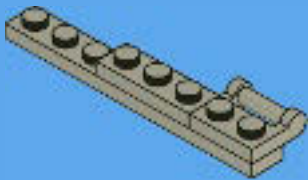

3

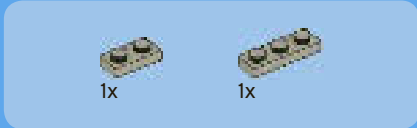
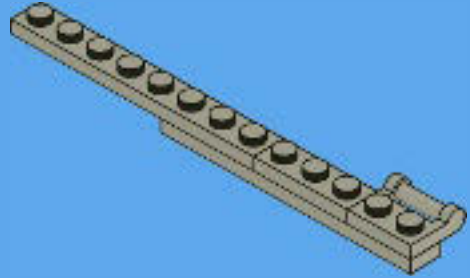

4

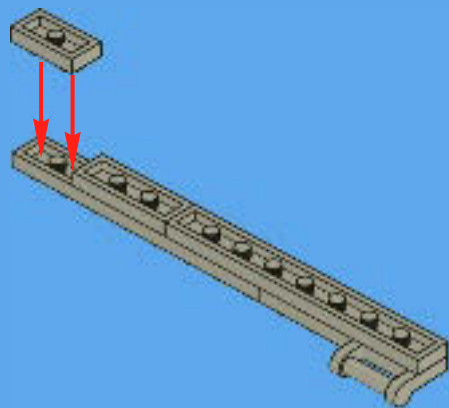

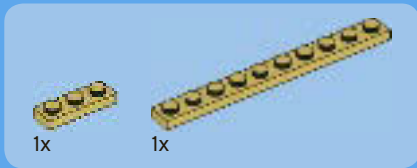

5

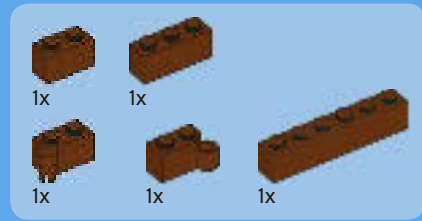
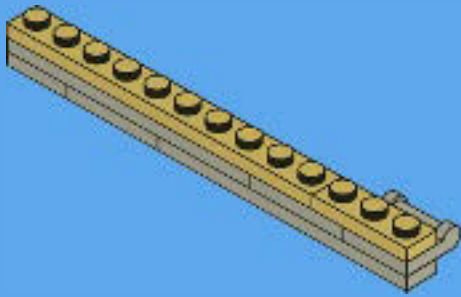

6

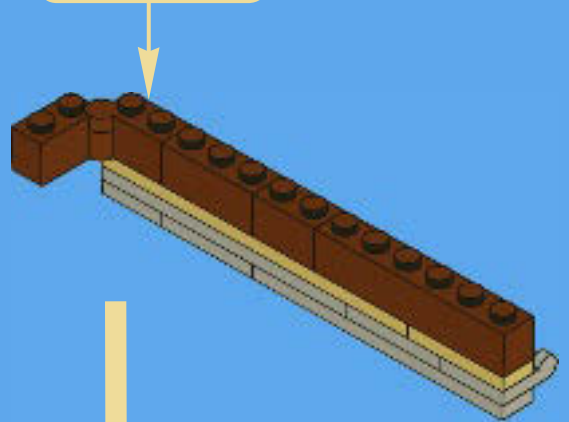

16



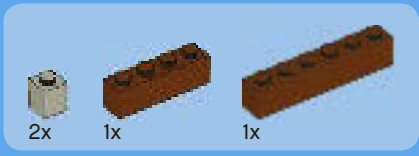

17

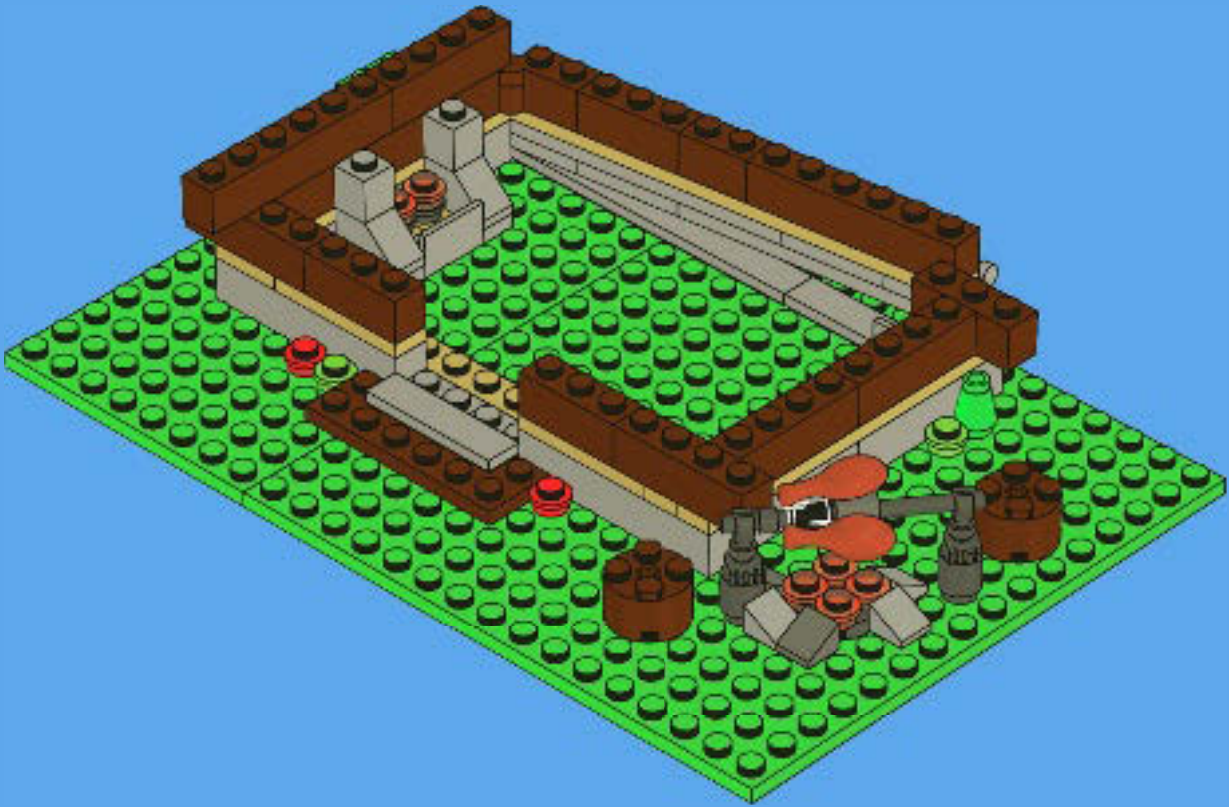



1x



1x



1x

18





2x



1x

19

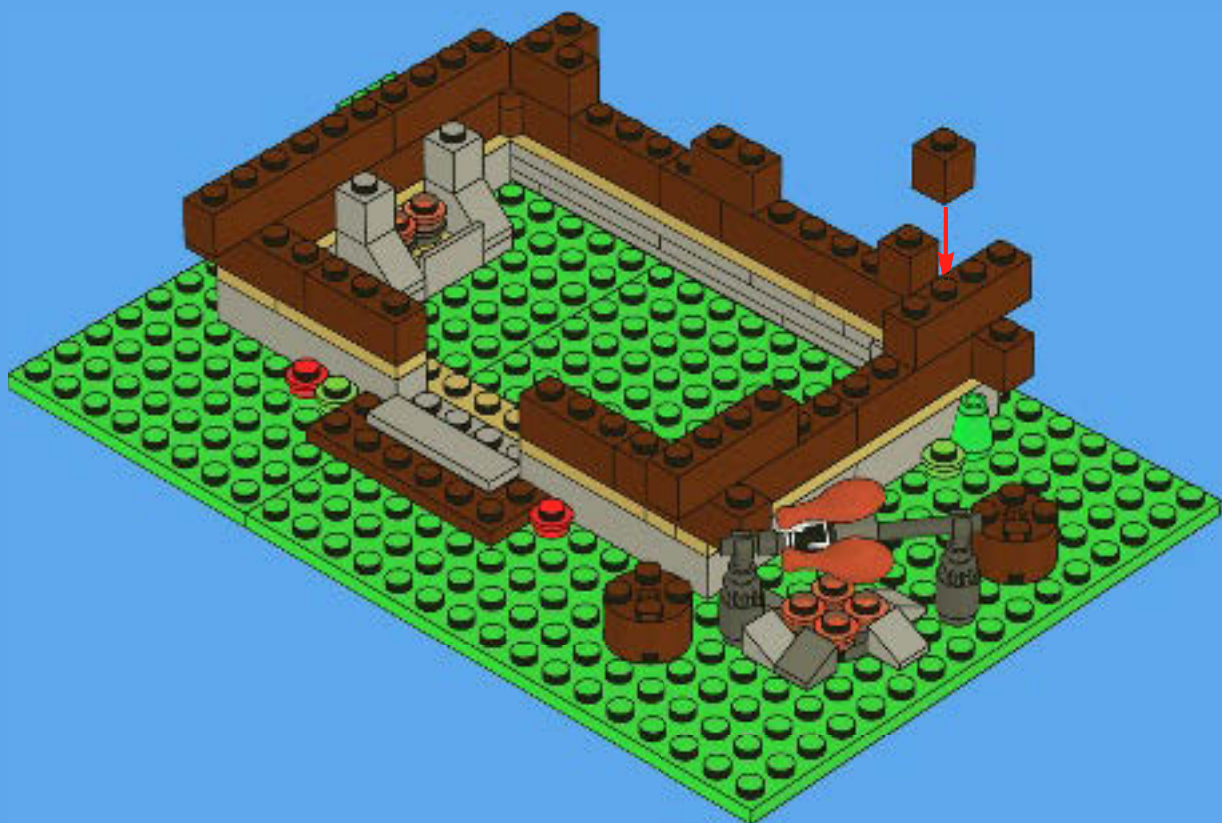



20

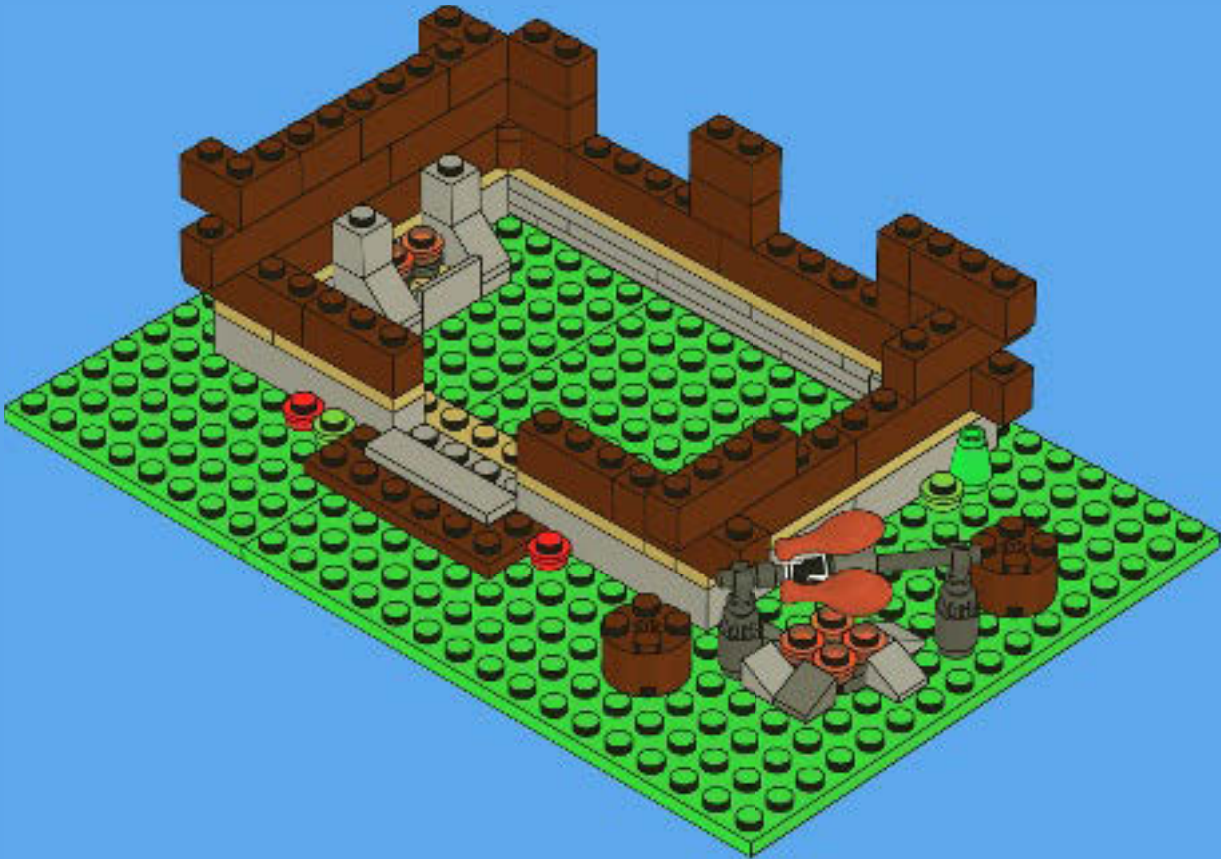

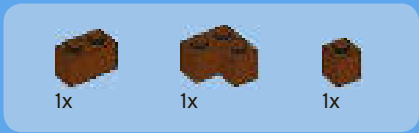

21

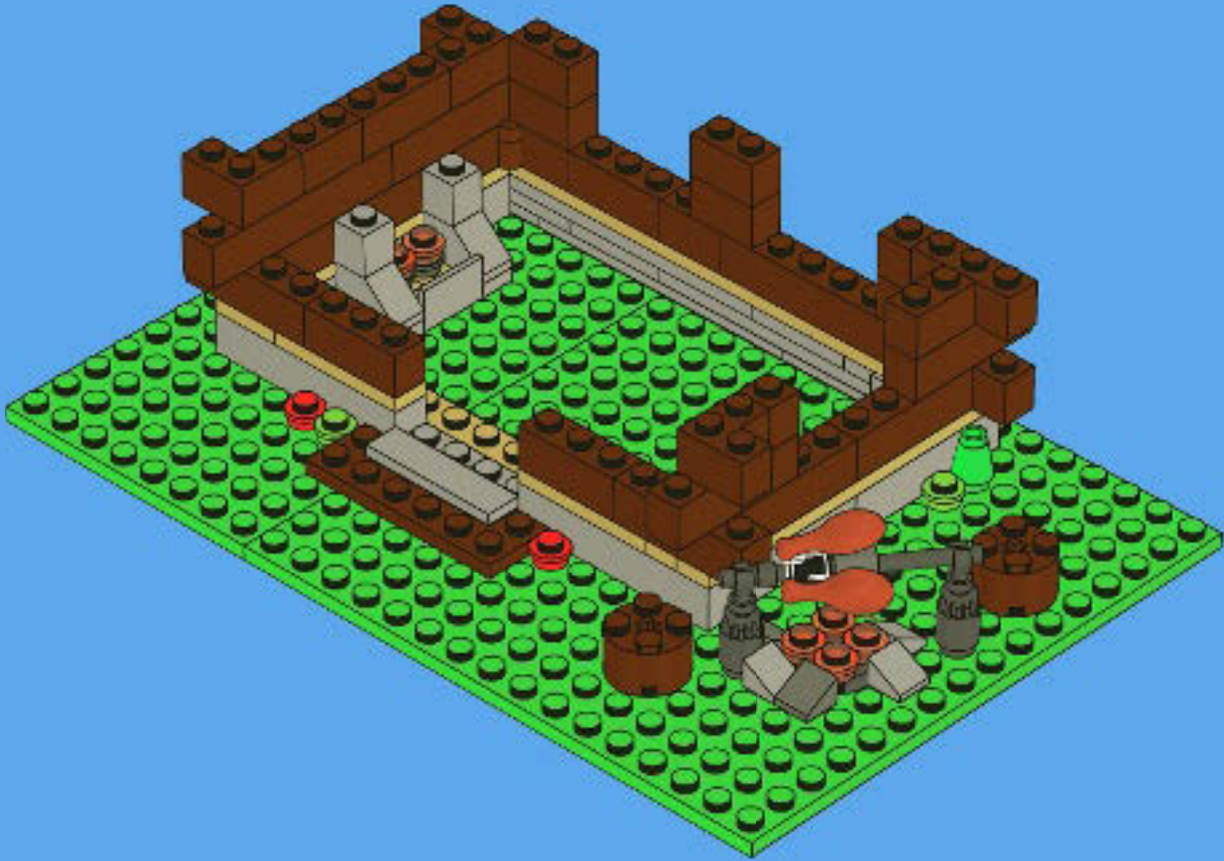

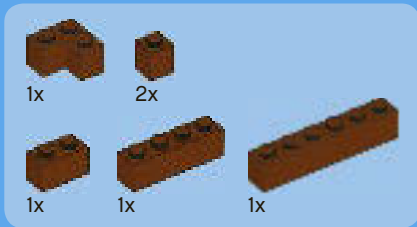

22

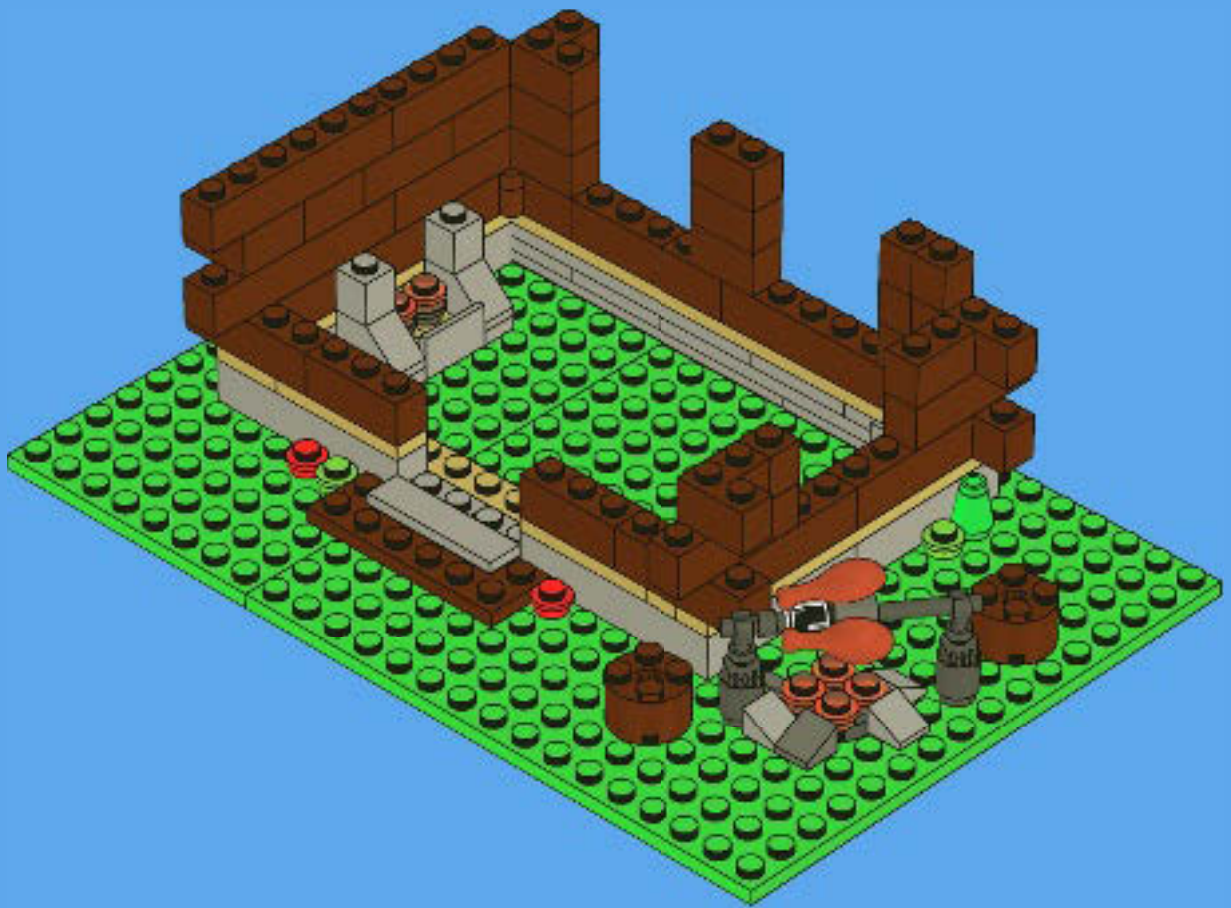



2x



4x



2x

23

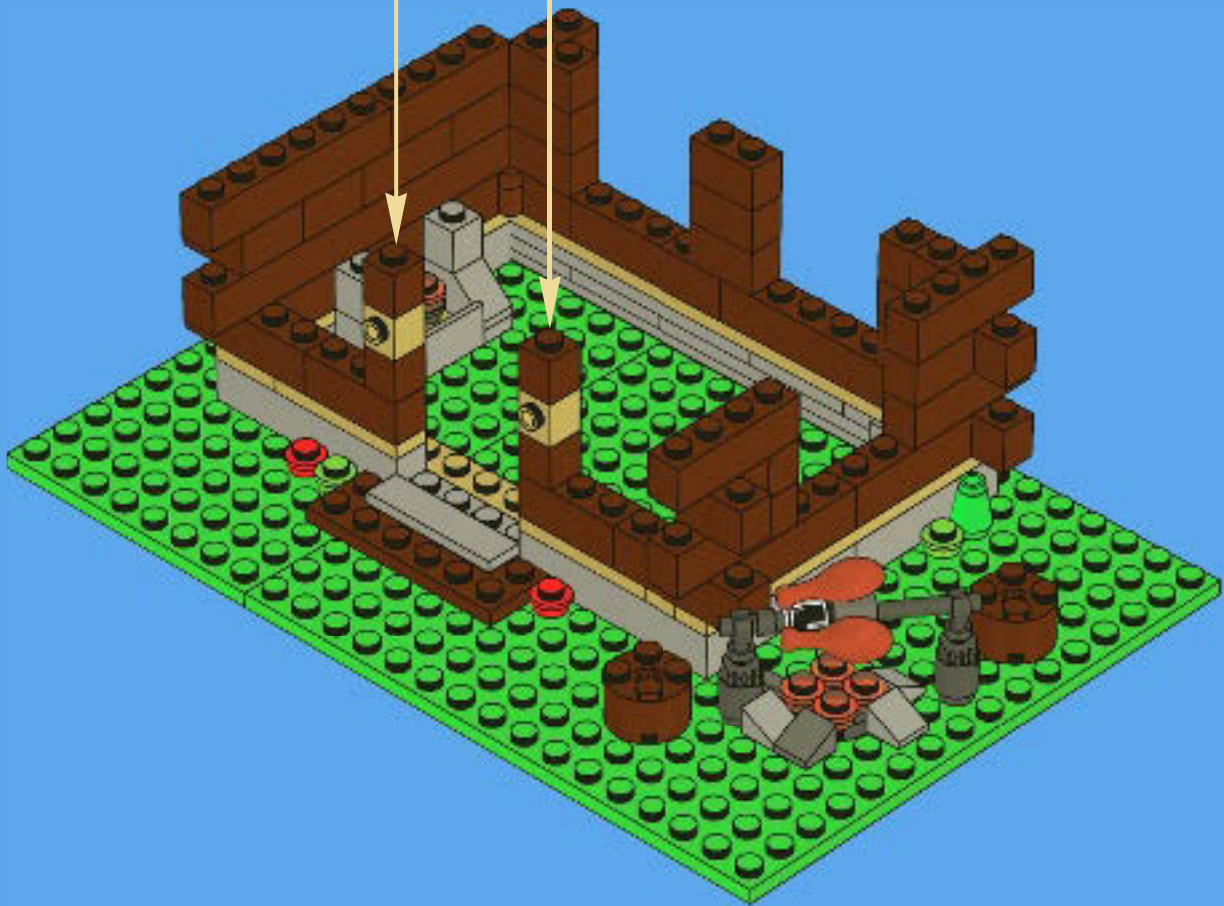
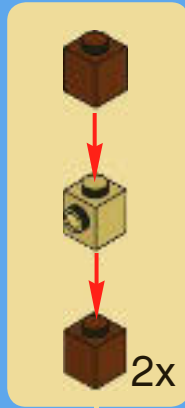



10x



5x

24

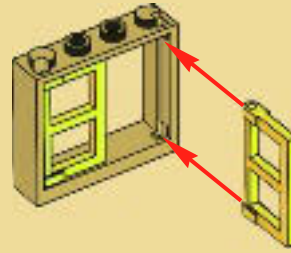

5x



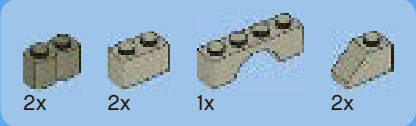

25

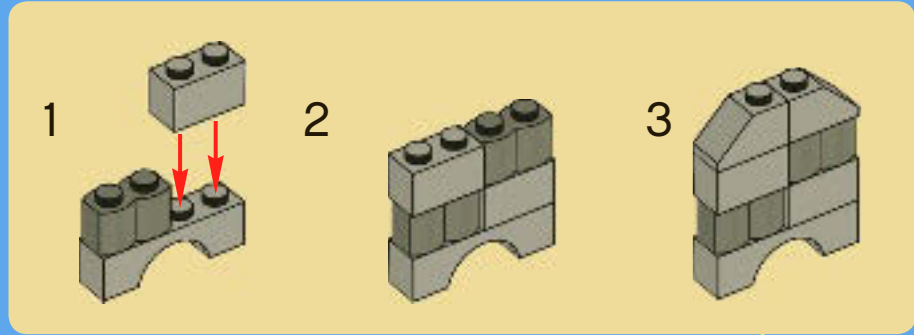

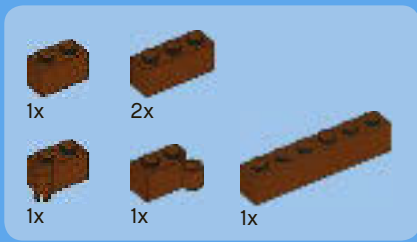

26





1x



2x



4x

27



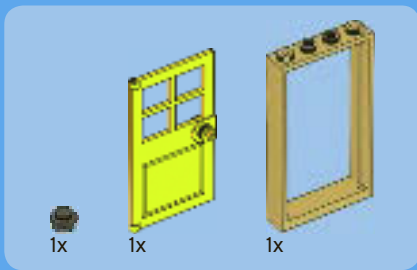

28

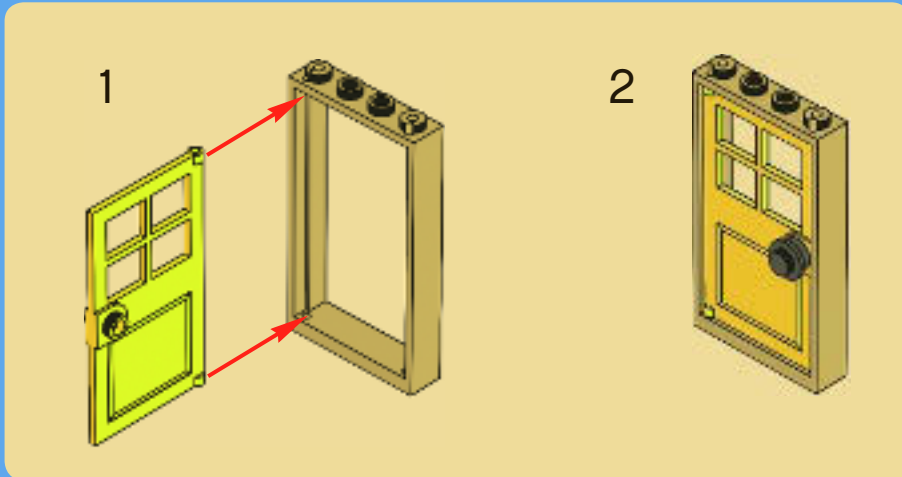

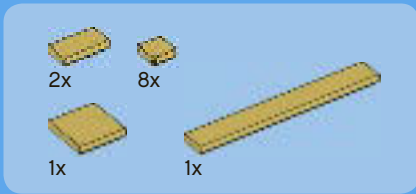

29



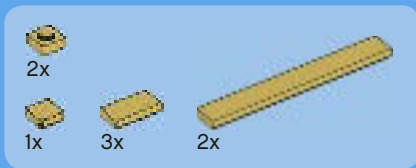

30





2x



2x



2x

31

1



2



3



2x



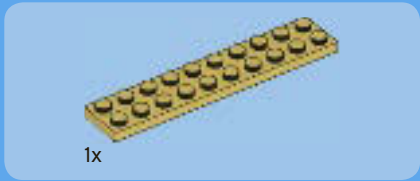
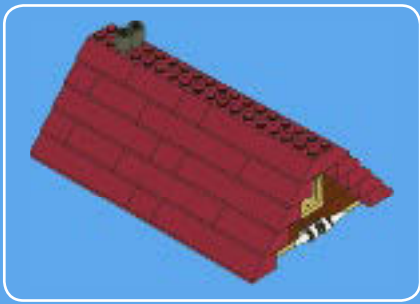

1

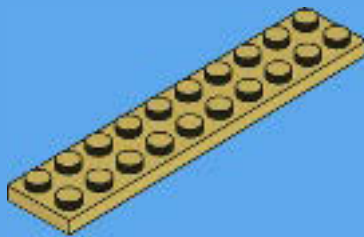

2

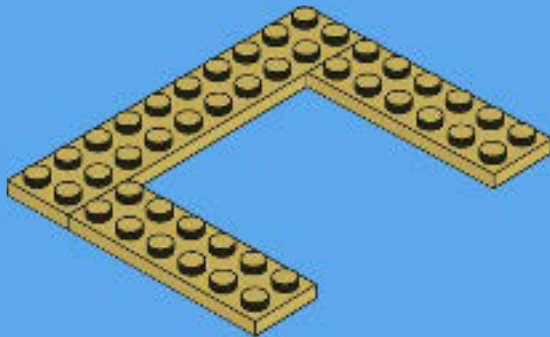



2x



2x

3

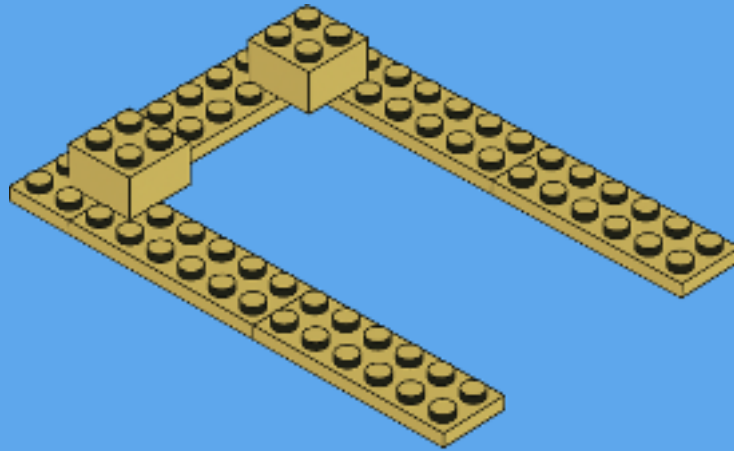

2x



1x

4

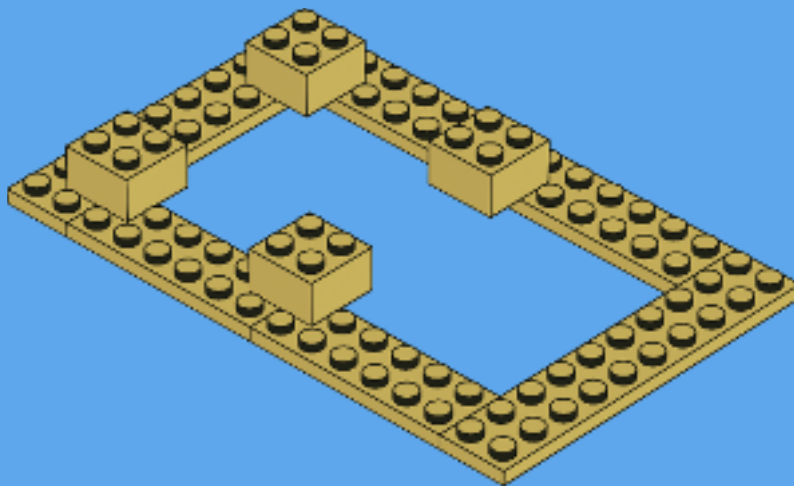



5

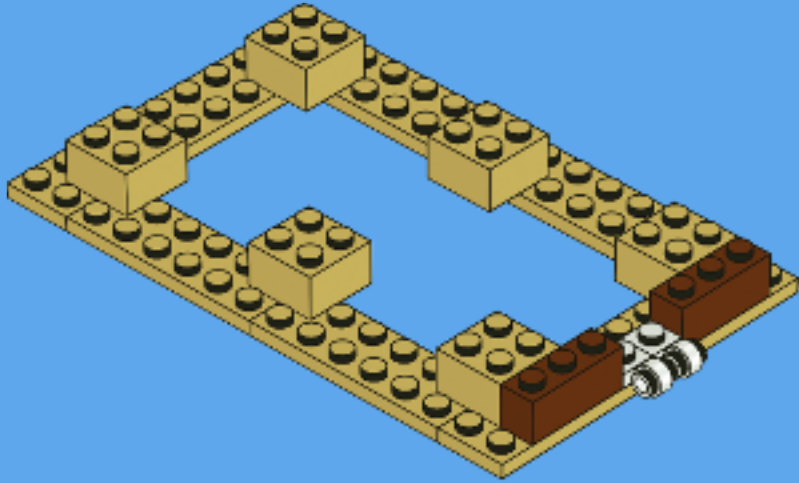

6

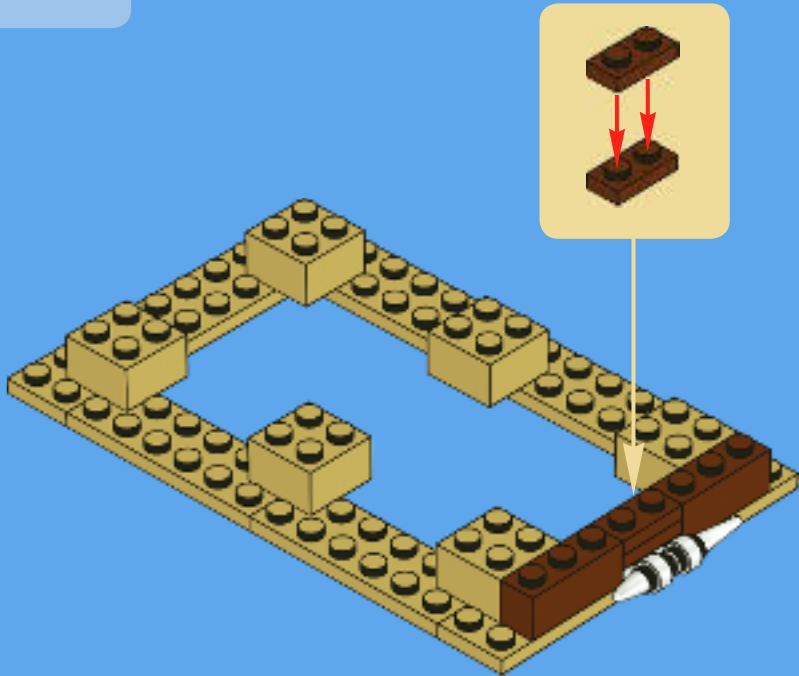



1x



2x



2x

7

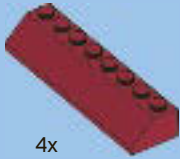
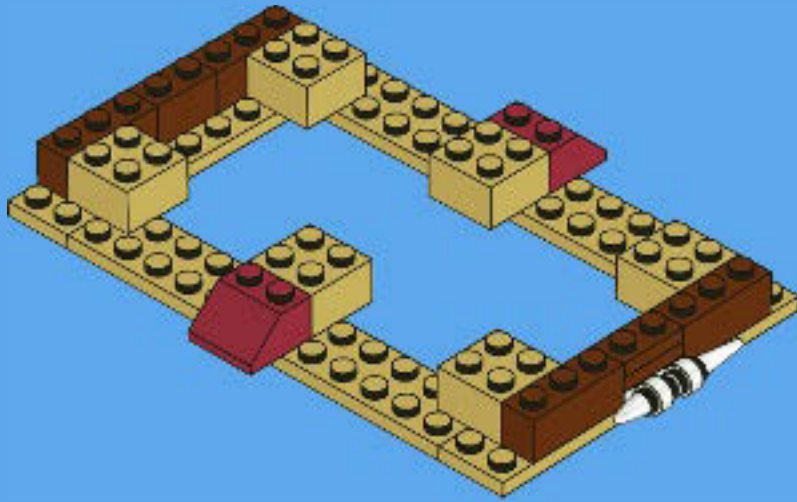

4x

8

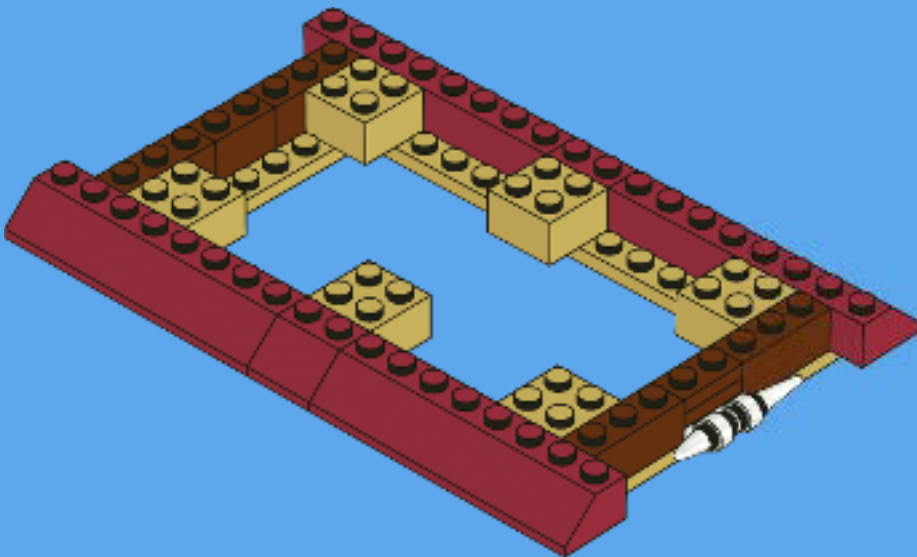



9

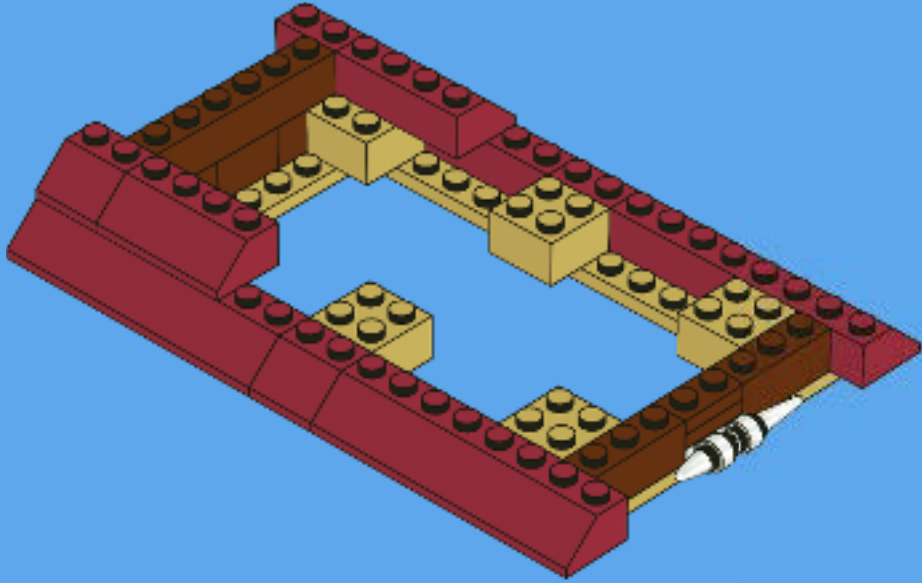

10

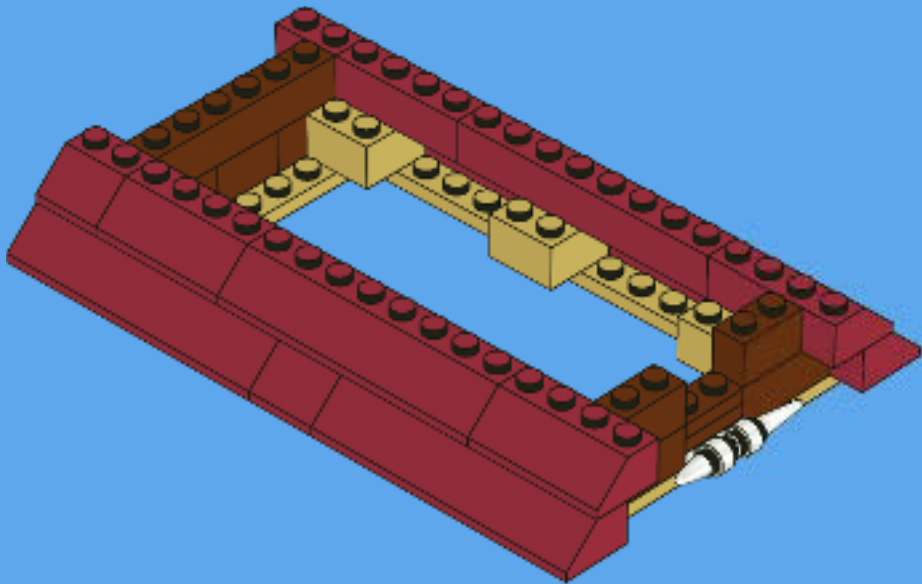



6x

11

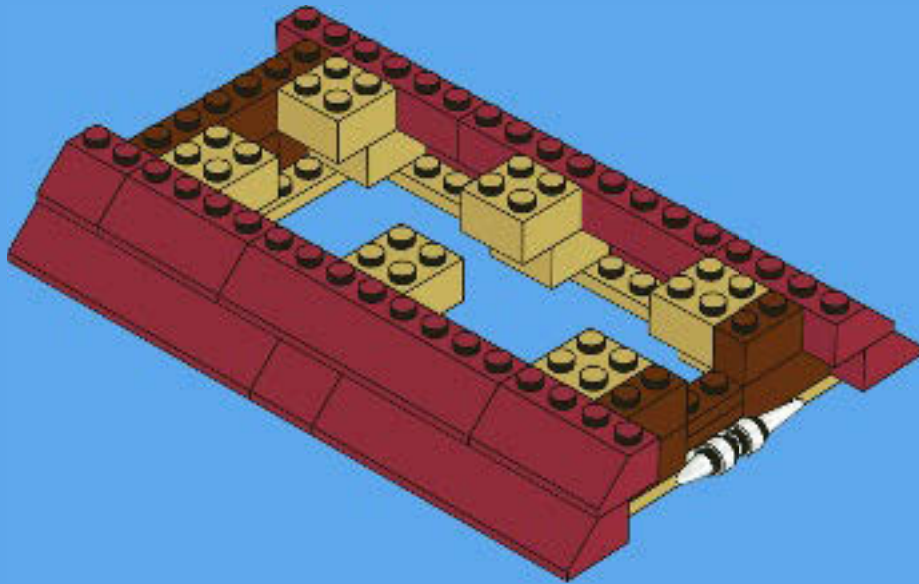

1x



2x

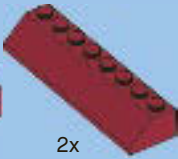

2x

12

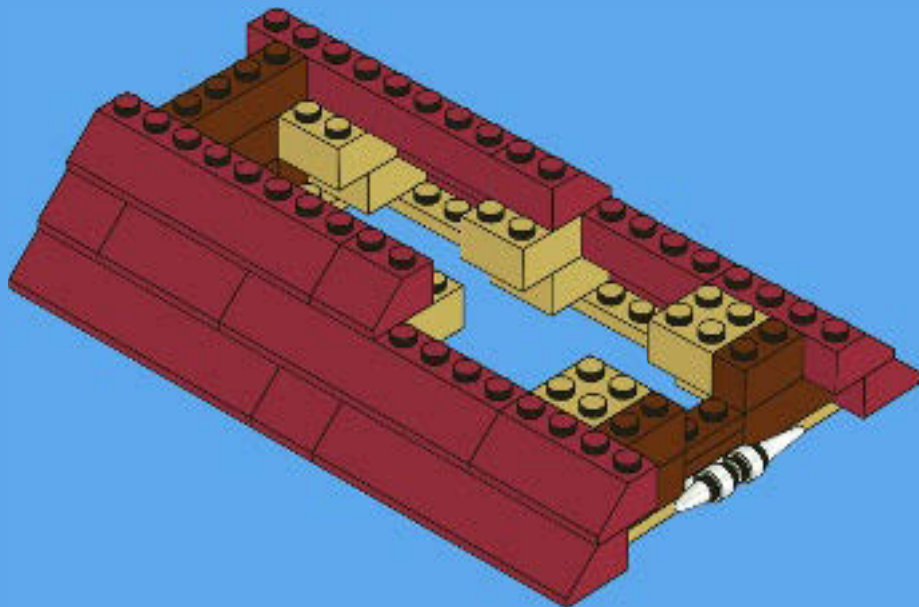



13

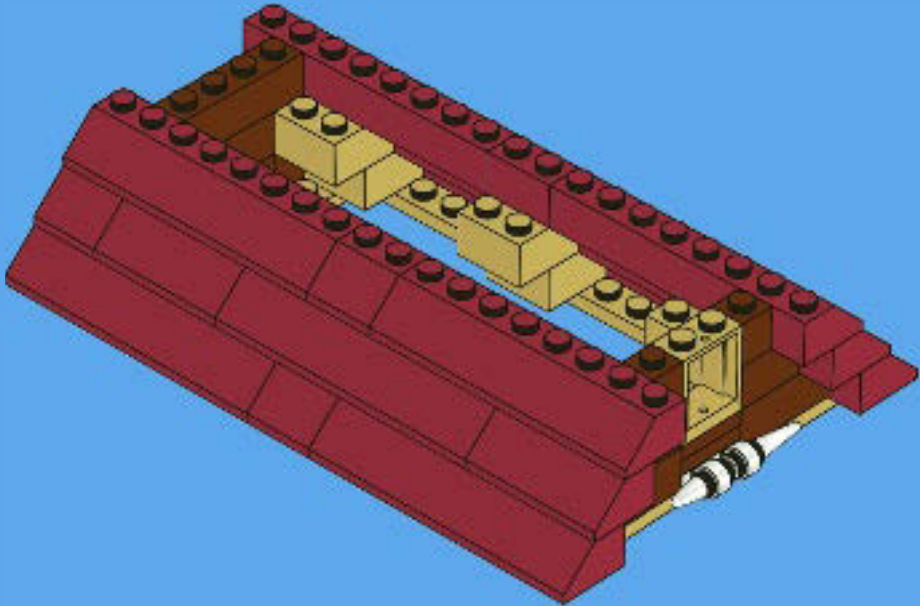

14

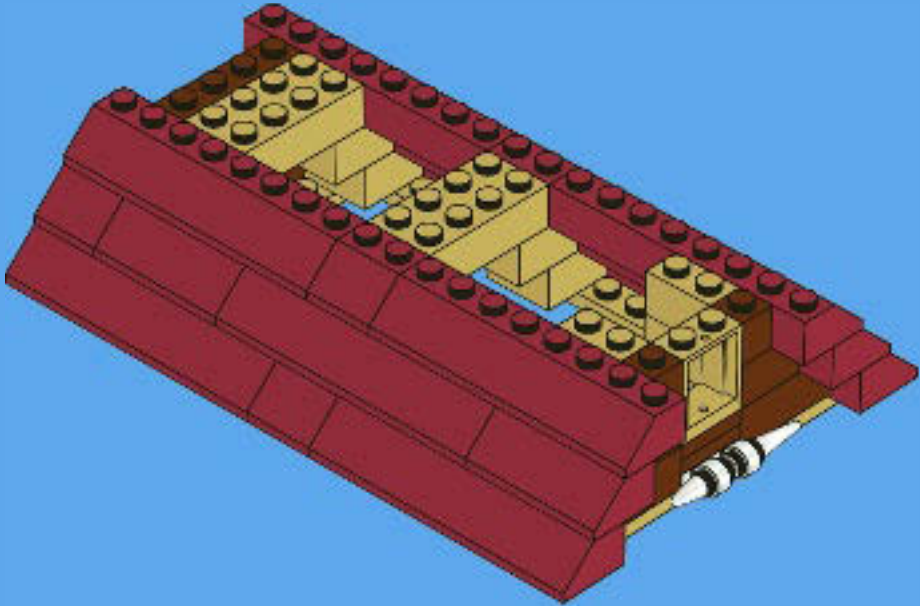

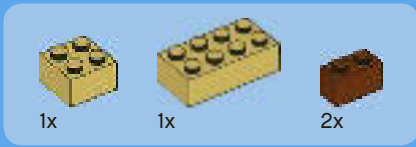

15

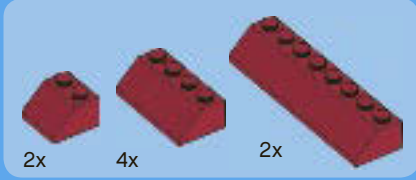
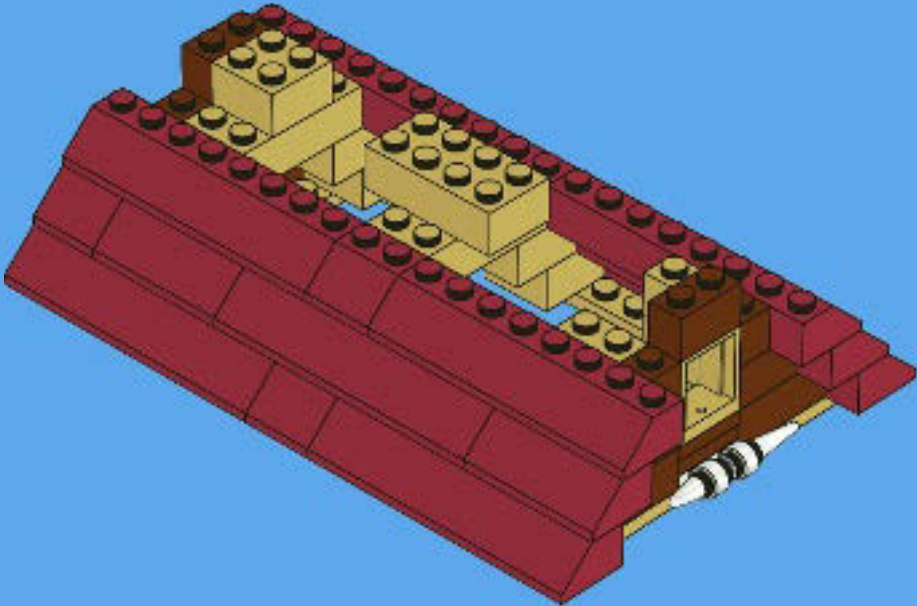

16

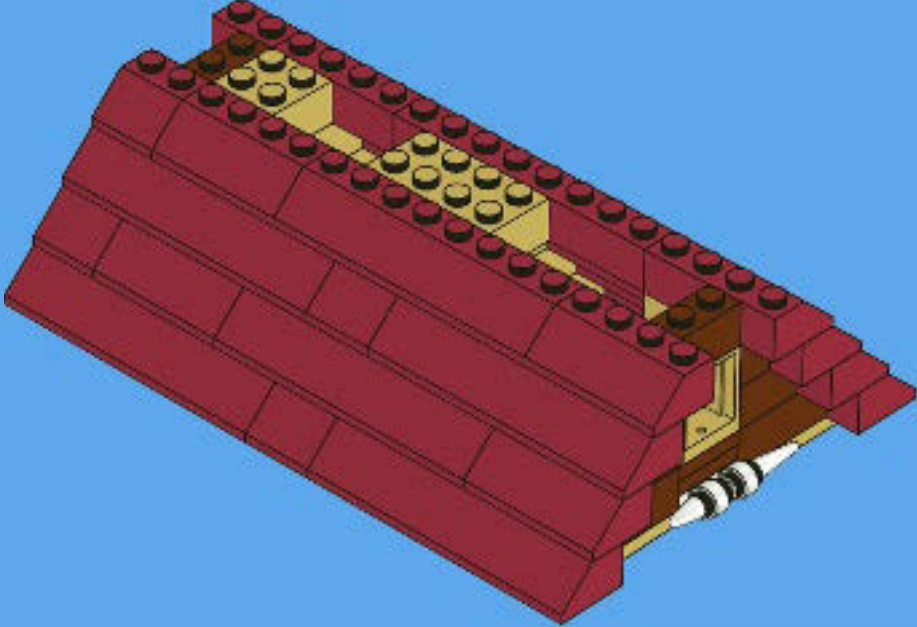

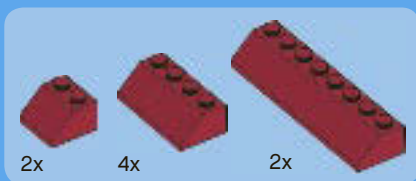

17

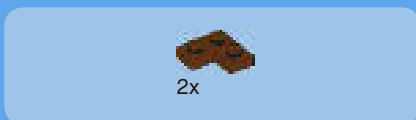
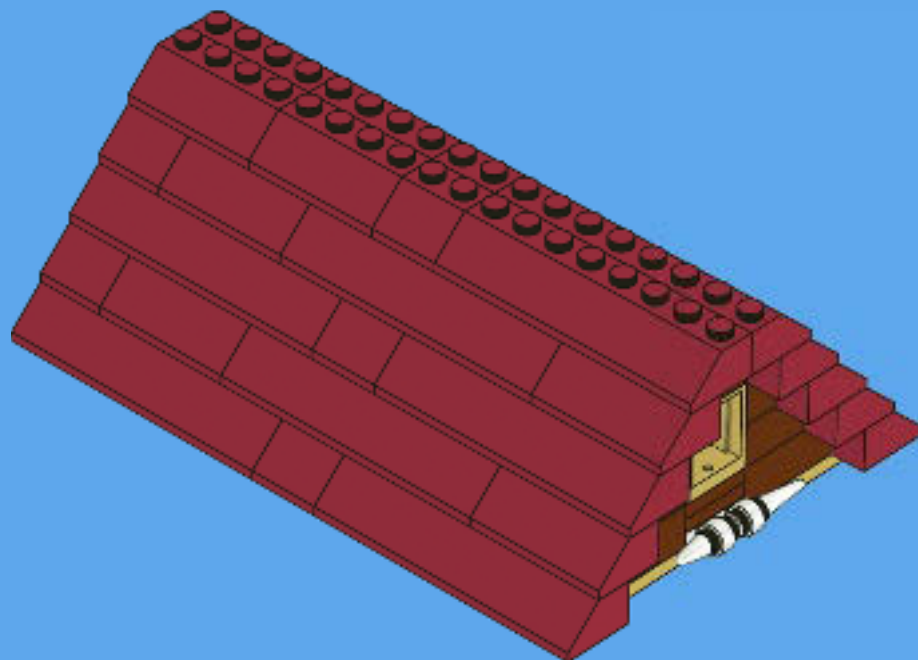

18

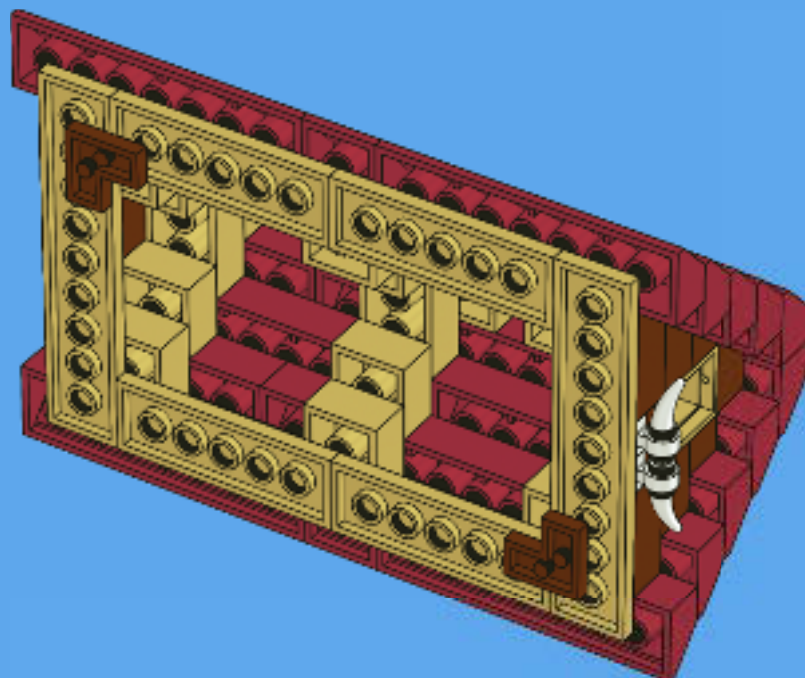



2x

32



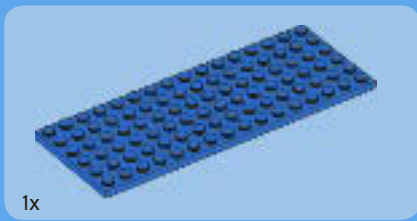

1x

33





1x



2x



1x

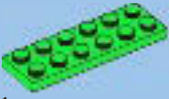

1x

34

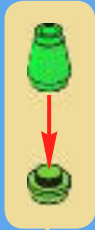



1x

1



1x

1x

3x

2

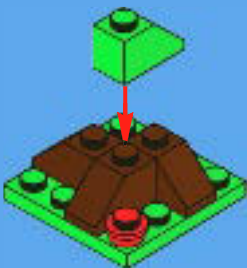

2x

3

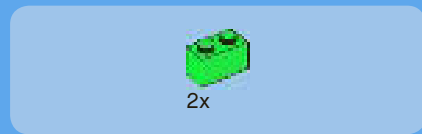
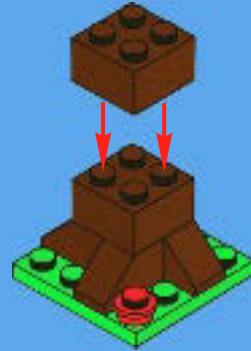

2x

4



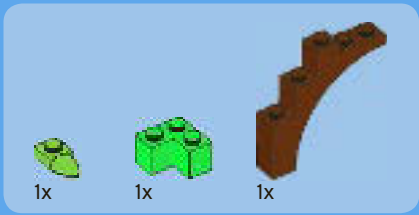

5

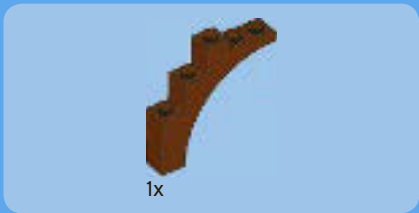
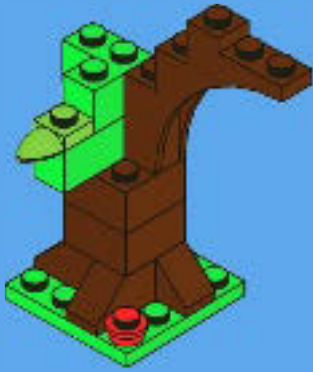

6



7



8





9

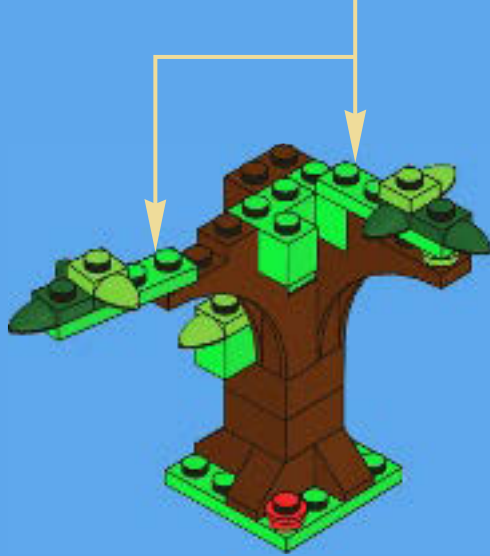
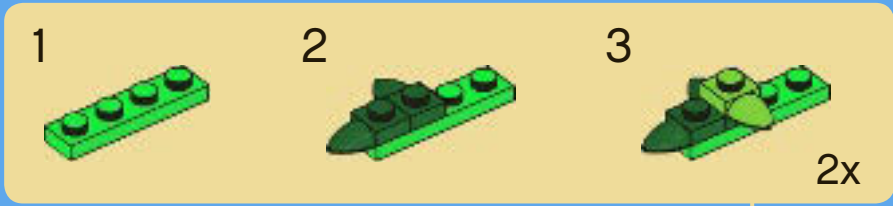

10





1x



2x



1x

11

1



2



3



1x



2x



1x

12

1



2



3





1x

13



1x



1x

14



35



36



- 2x 408101
- 2x 4568387
- 2x 4109995
- 13x 4114306
- 3x 4114319
- 10x 4579260
- 9x 4125253
- 7x 4159553
- 5x 4114026
- 1x 4114077
- 1x 4185177
- 3x 4121921
- 2x 4113233
- 4x 4113993
- 3x 4544139
- 3x 4143333
- 2x 4249019
- 1x 4578107
- 5x 4578109
- 1x 4107623
- 1x 4578110
- 4x 614121
- 1x 4562544
- 1x 4275815
- 4x 4504381
- 4x 4522035
- 2x 306924
- 2x 302324
- 2x 371024
- 1x 303424
- 10x 4528136
- 1x 4528550
- 1x 4570043
- 4x 4107736
- 1x 300328
- 2x 4125281
- 3x 4529239
- 2x 4121969
- 5x 371028
- 2x 302028
- 1x 4243821
- 1x 379528
- 1x 4598714
- 2x 4278013
- 2x 4278415
- 2x 4153989
- 6x 3005747
- 6x 4183133
- 7x 4611784
- 8x 4501970
- 10x 4609925
- 12x 4541380
- 14x 4585518
- 12x 4211242
- 14x 4211149
- 2x 4211210
- 5x 4211200
- 14x 4211220
- 15x 4211225
- 7x 4211193
- 2x 4215448
- 2x 4215449
- 2x 4211166
- 3x 4211199
- 2x 4544167
- 5x 4211150
- 2x 4211257
- 1x 4211247
- 1x 4609635
- 2x 4504378
- 1x 4210469
- 2x 4211095
- 4x 306226
- 1x 654126
- 5x 614126
- 1x 403226
- 2x 459926
- 1x 4538722
- 2x 4249857
- 1x 4121715
- 2x 4211389
- 3x 4211388
- 4x 4211394
- 2x 4211393
- 1x 4610353
- 1x 4611777
- 1x 4611373
- 3x 4521921
- 4x 4211614
- 1x 4211435
- 5x 4211398
- 1x 4244627
- 2x 4211515
- 3x 4211414
- 2x 4211429
- 2x 4211356
- 2x 4211425
- 1x 4211481

Customer Service
Kundenservice
Service Consommateurs
Servicio Al Consumidor
www.lego.com/service or dial
 00800 5346 5555 :     
 1-800-422-5346 :  

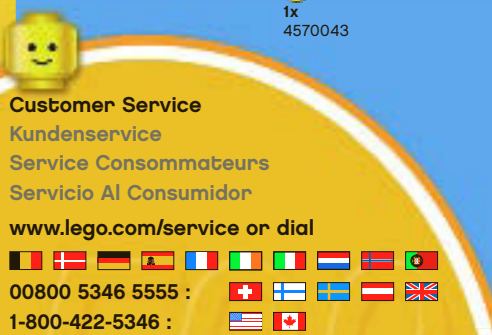



CREATOR



5762



5763



5764



5761



5765





creator.LEGO.com/designers

creator.LEGO.com/movies

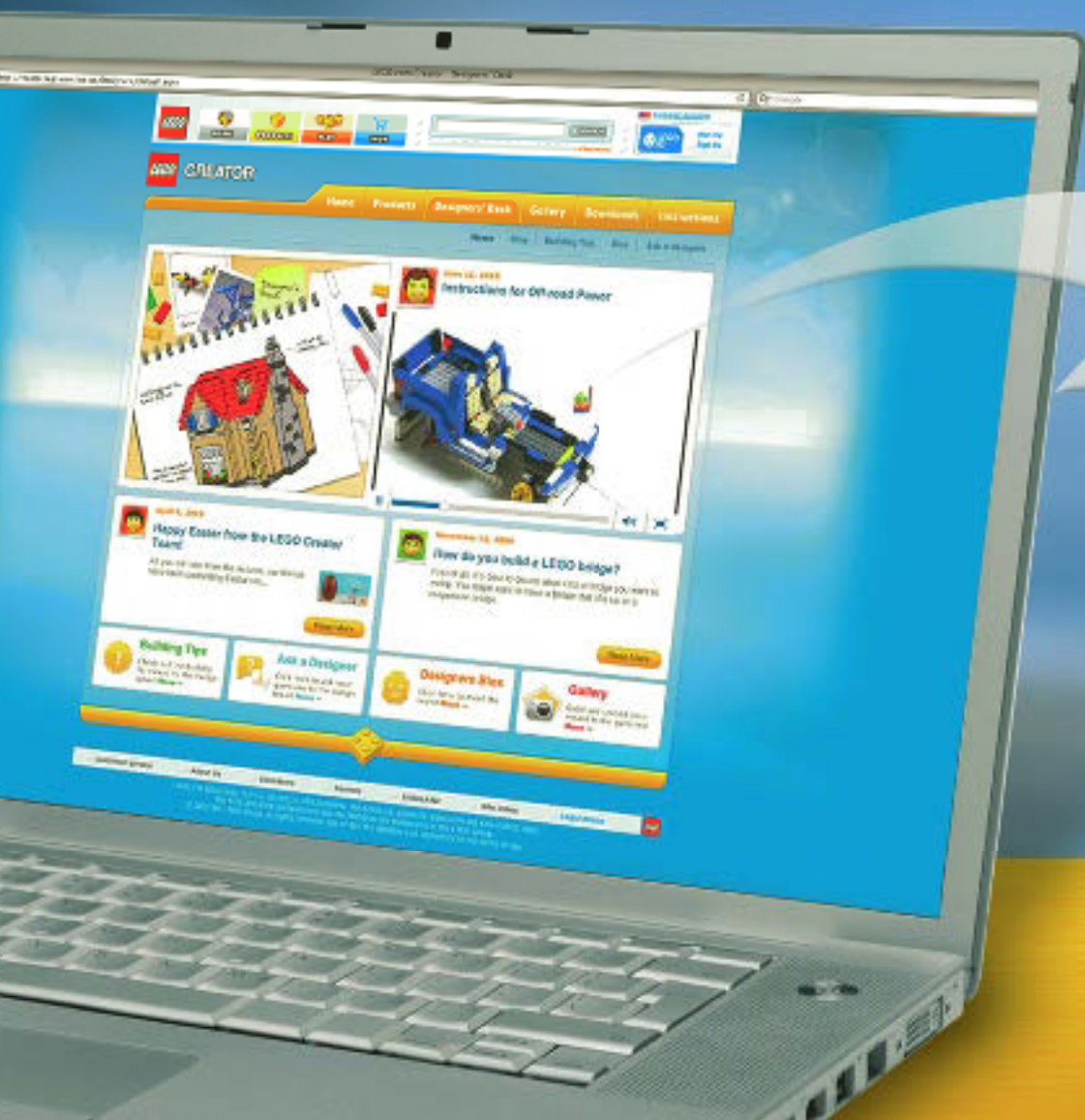

3 IN 1



FREE! GRATIS! GRATUIT!



www.LEGOclub.com



LEGO® Club Magazine



LEGO® Club Email

SIGN UP ONLINE!

www.LEGOclub.com

VISIT THE WORLD'S
BIGGEST LEGO® SHOP!

www.LEGOshop.com

GO TO
www.LEGOclub.com

00800 5346 5555*

1-866-534-6258 • 1-877-518-5346

US & Canada only

Canada seulement



* Freephone. Mobile charges may apply. * Numéro sans frais. Des frais peuvent s'appliquer avec les téléphones cellulaires. * Gebührenfrei, Kosten für Anrufe aus Mobilfunknetzen können abweichen. * Gratis telefoonnummer vanaf vaste lijn. * Det er et gratis nummer, når du ringer fra fasttelefon. * Det är gratis, när du ringer från en fast telefon. * Numéro sans frais. Des frais peuvent s'appliquer avec les téléphones portables.



WIN!

Go to www.LEGOsurvey.com/product to fill out a survey for a chance to win a cool LEGO® Product.

No purchase necessary.

Open to all residents where not prohibited.

 www.LEGO.com



www.LEGOsurvey.com/product

GEWINNE!

Nimm an der Umfrage auf www.LEGOsurvey.com/product teil und hab die Chance ein cooles LEGO® Produkt zu gewinnen!

Die Teilnahme am Gewinnspiel führt zu keinerlei Kaufverpflichtungen. Teilnahme in allen nicht ausgeschlossenen Ländern möglich.

WIN!

Ga naar www.LEGOsurvey.com/product, vul een enquêteformulier in en maak kans op een cool LEGO® product.

Geen aankoopverplichting.
Iedereen mag deelnemen, uitgezonderd ingezetenden van landen waar een enquêteverbod geldt.

GAGNE !

Visite www.LEGOsurvey.com/product pour répondre à un questionnaire et avoir une chance de gagner un produit LEGO® très cool !

Aucune obligation d'achat.
Ouvert à tous les résidents des pays autorisés.

当てよう!

www.LEGOsurvey.com/product にアクセスして、アンケートにご記入ください。当選者にはレゴ®製品を差し上げます。

お買い上げの必要はありません。
禁止されていない限り、すべての皆様にご利用いただけます。