

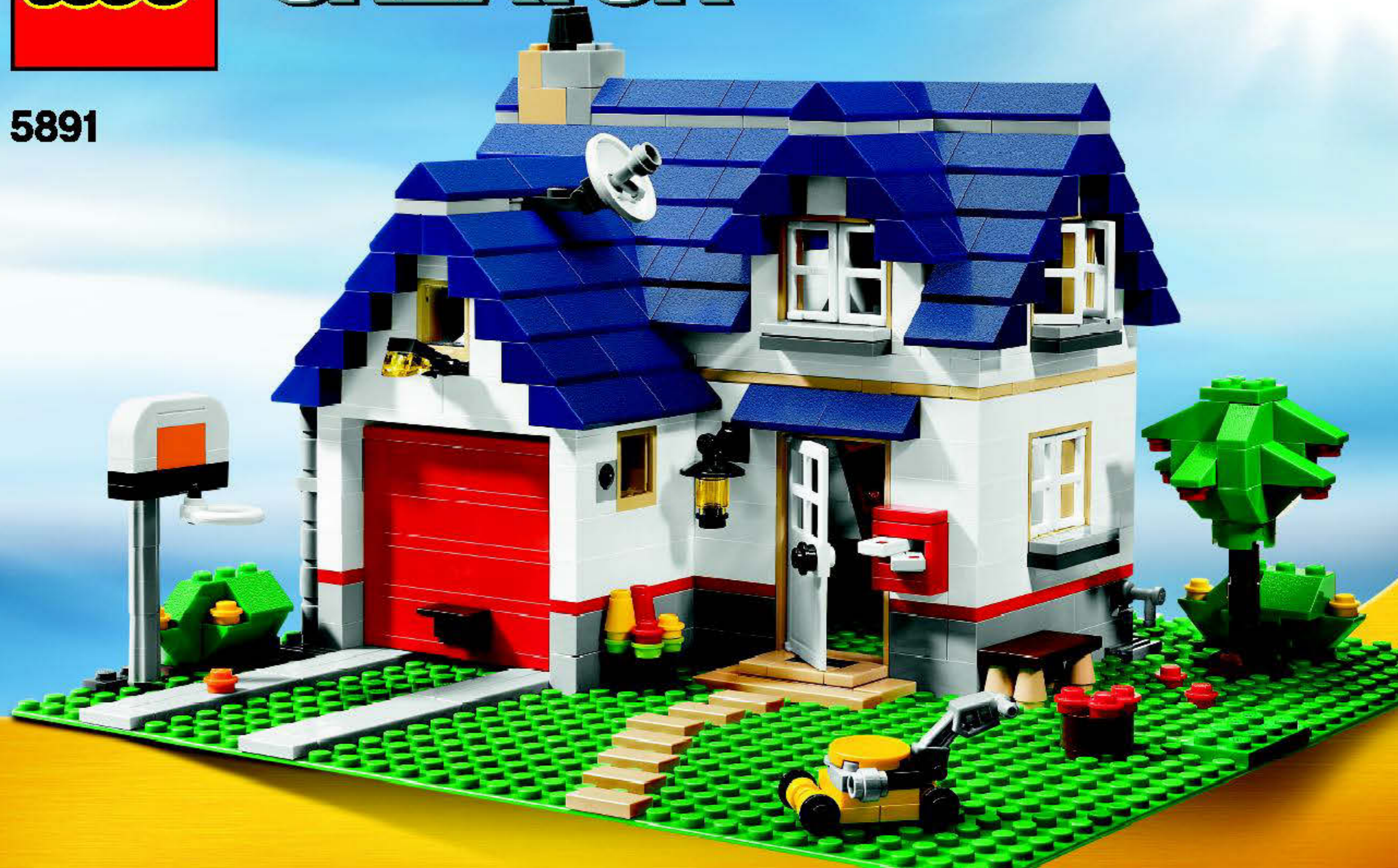

# CREATOR

5891





1

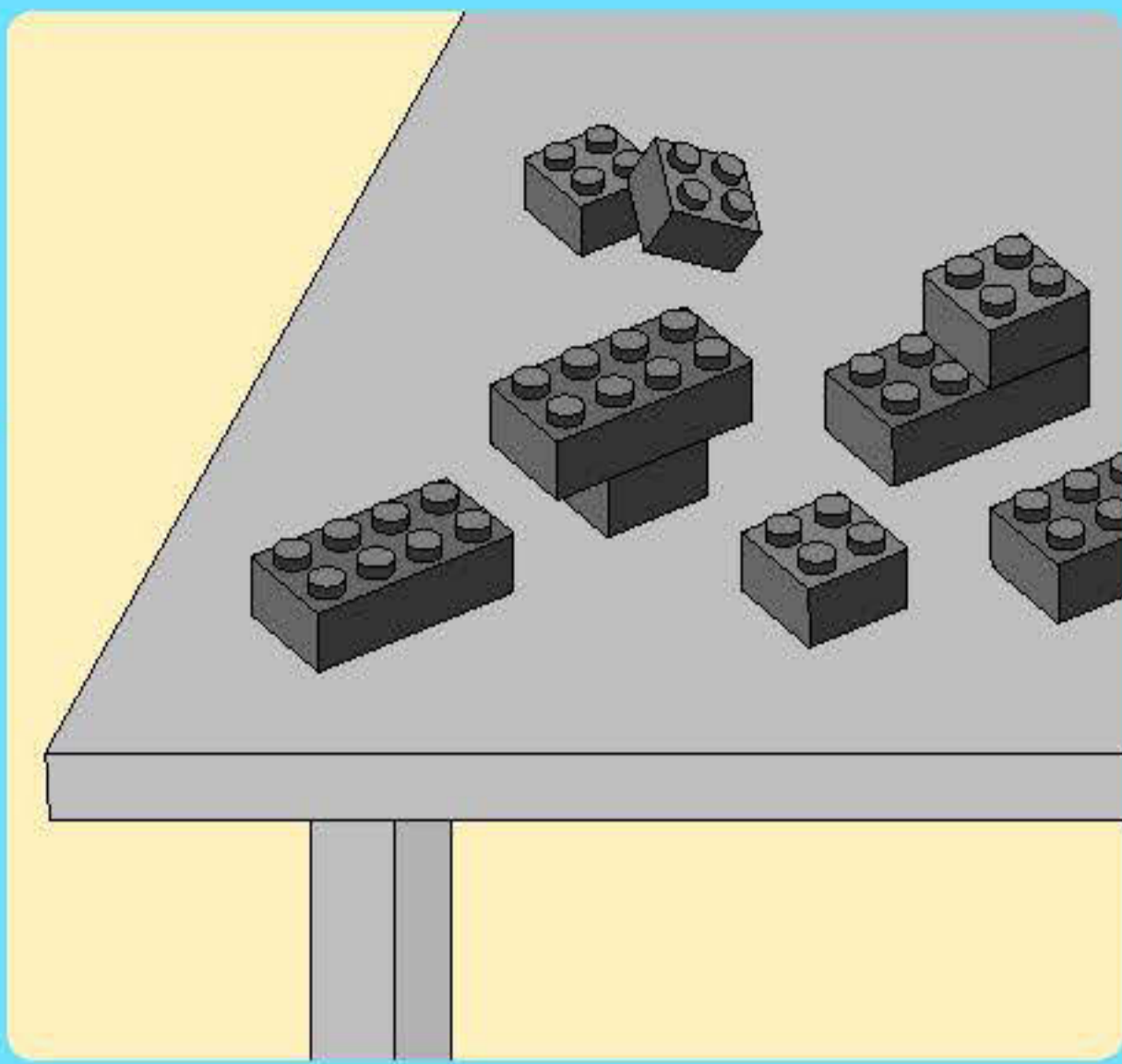
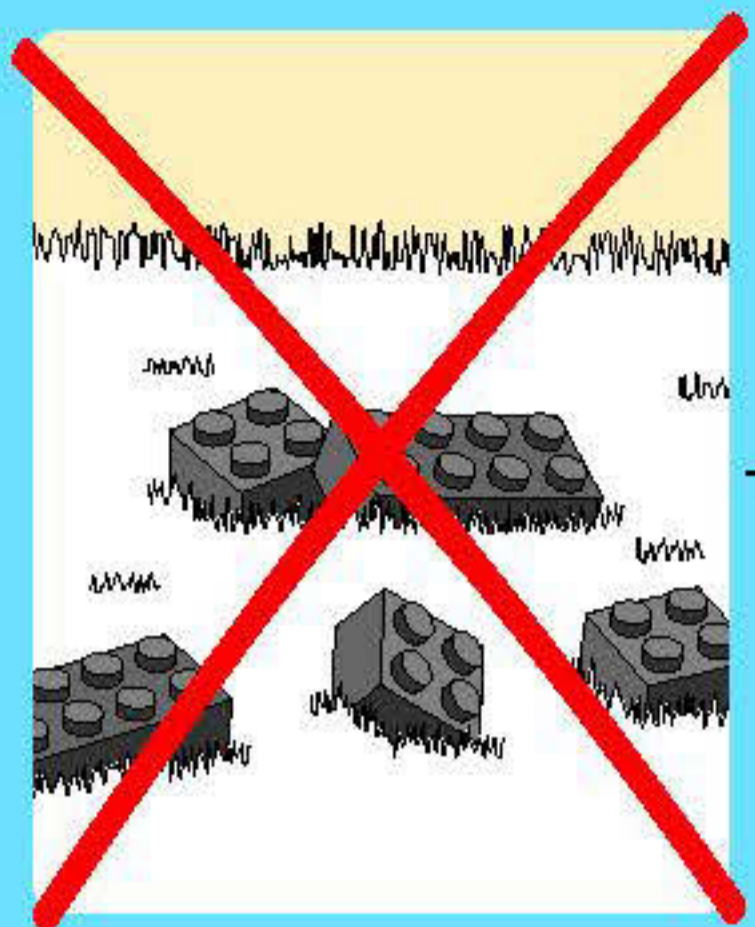

2

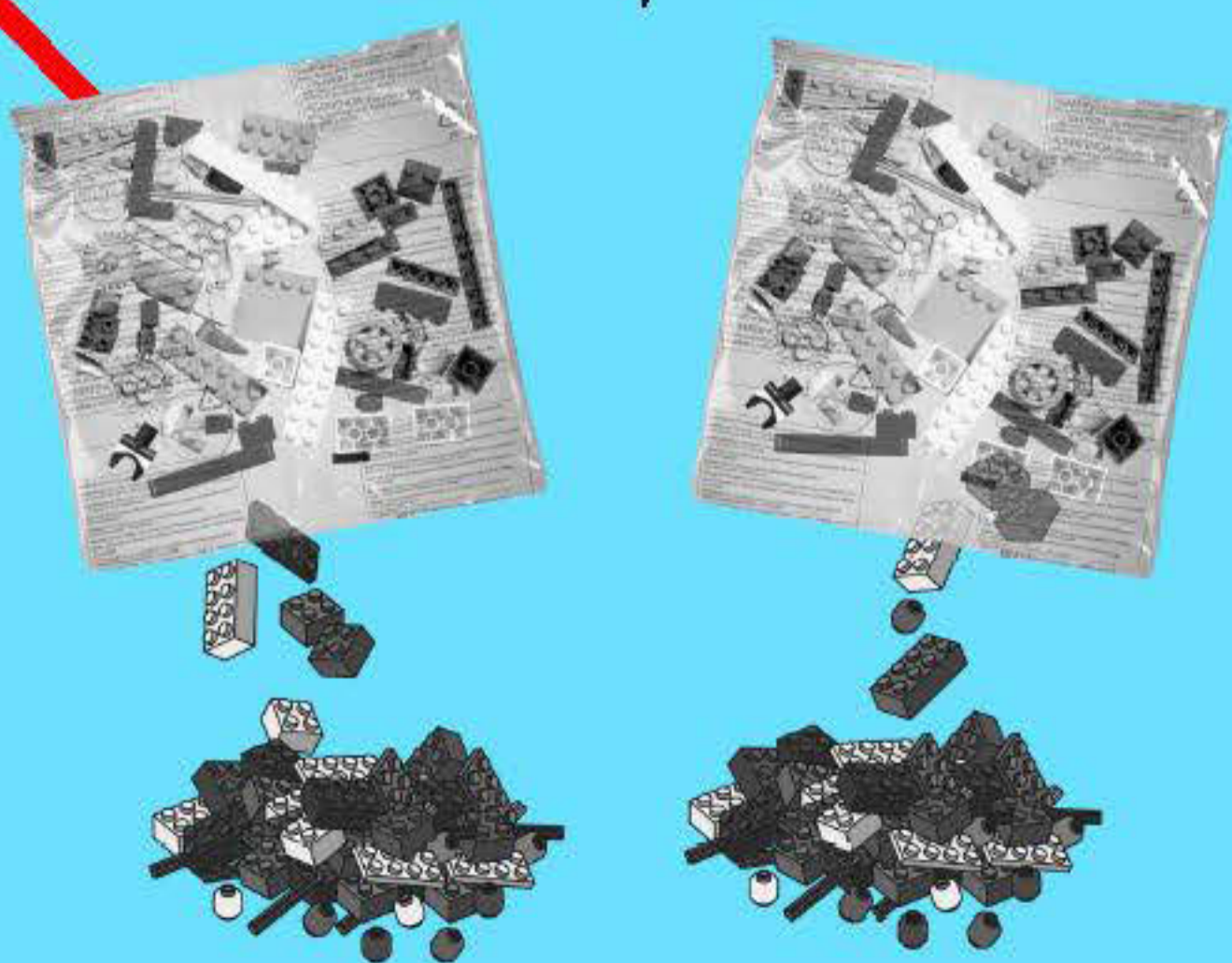
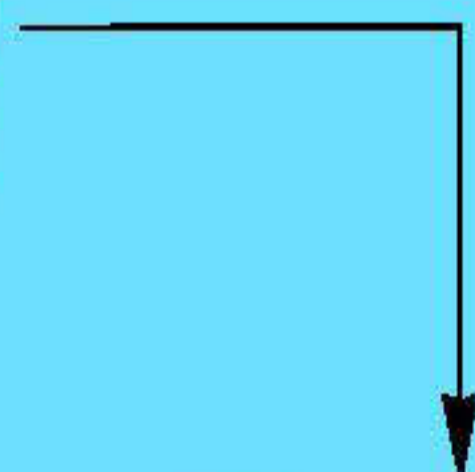



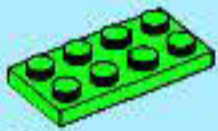

2x

1

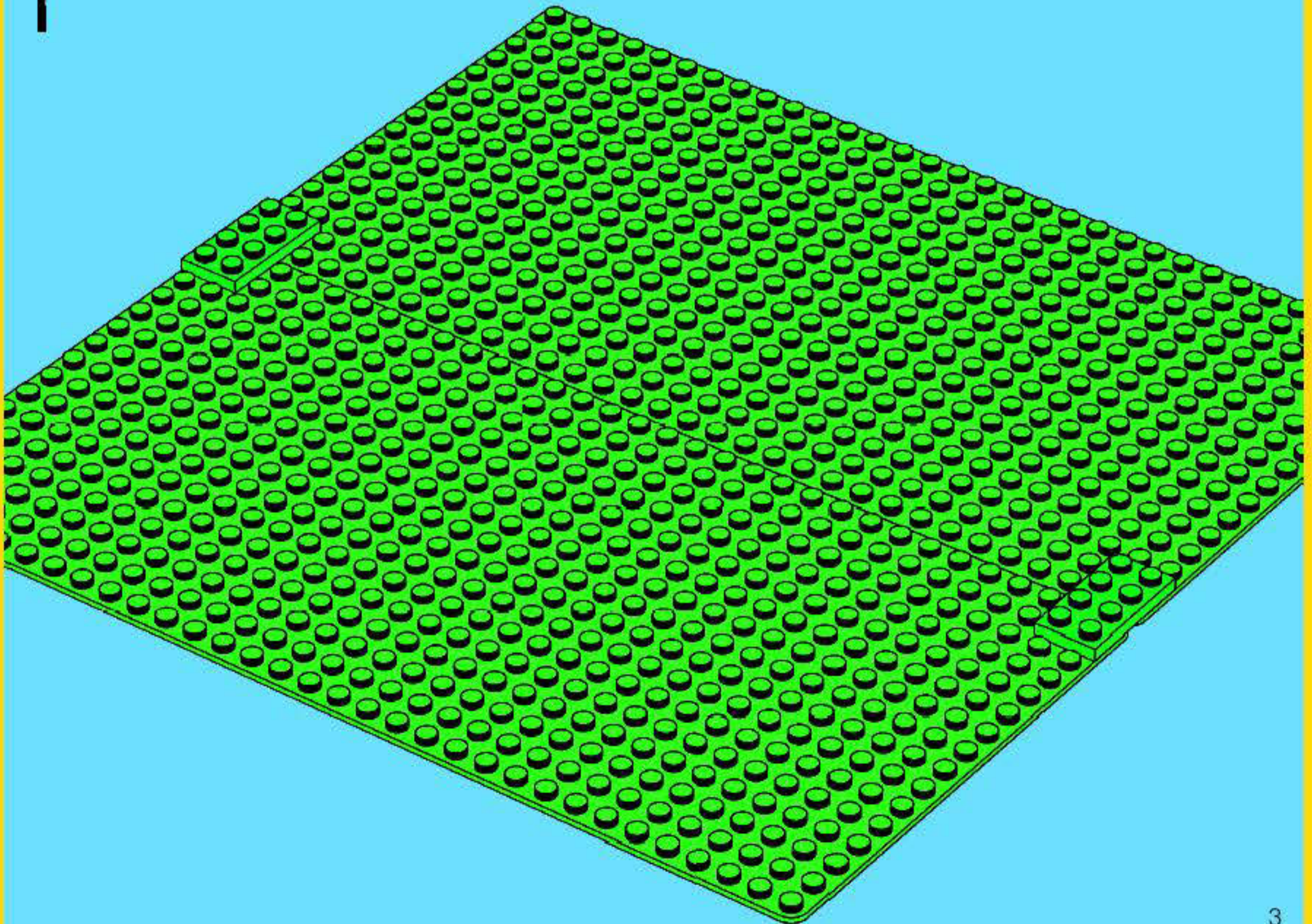





1x



1x



1x

# 2

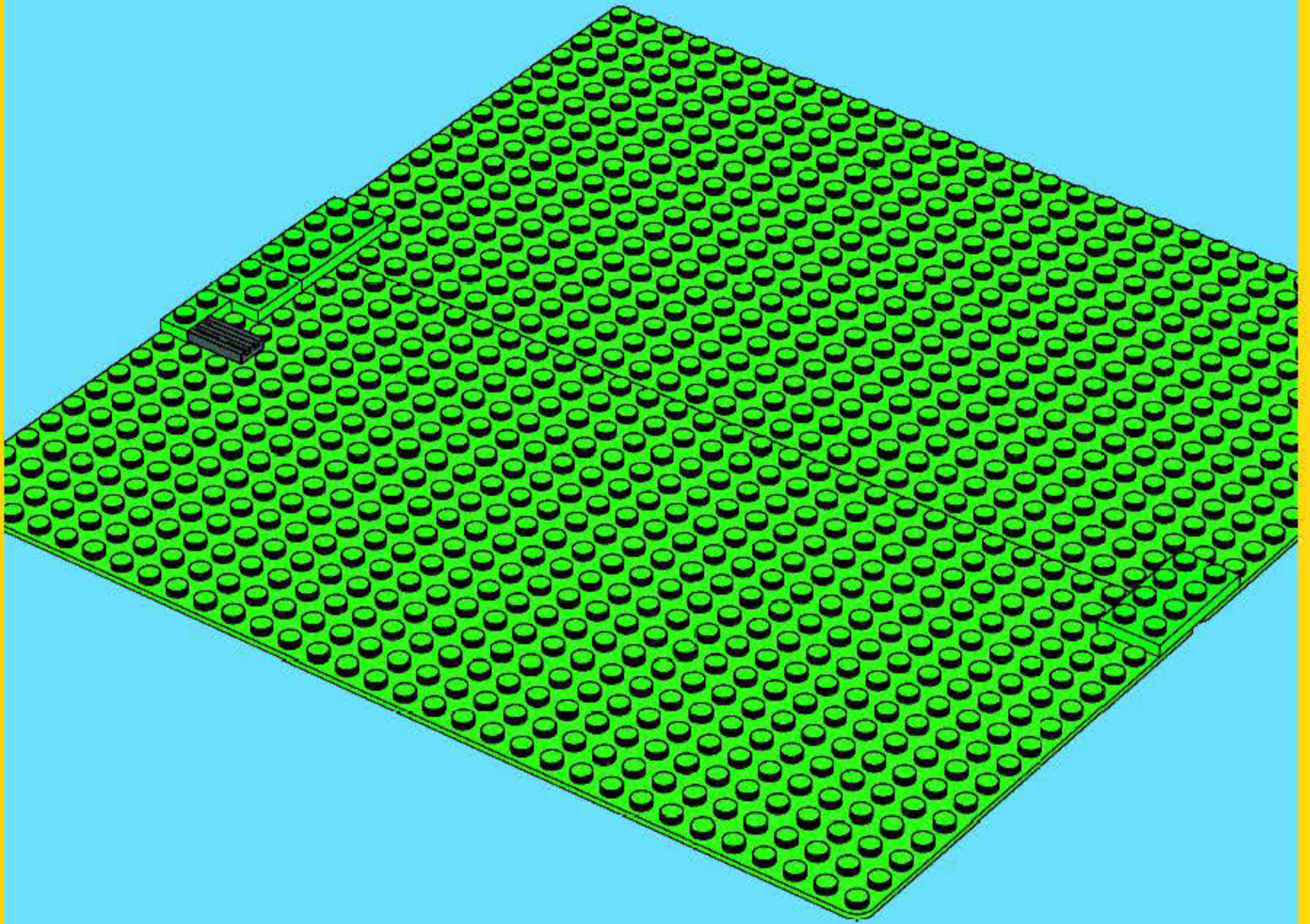



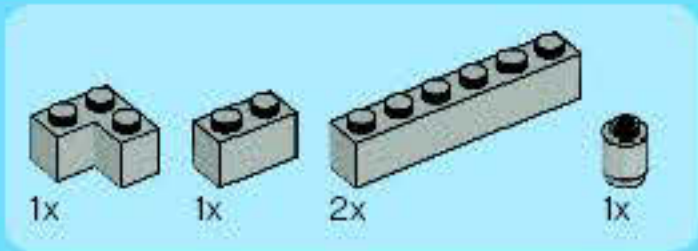

3

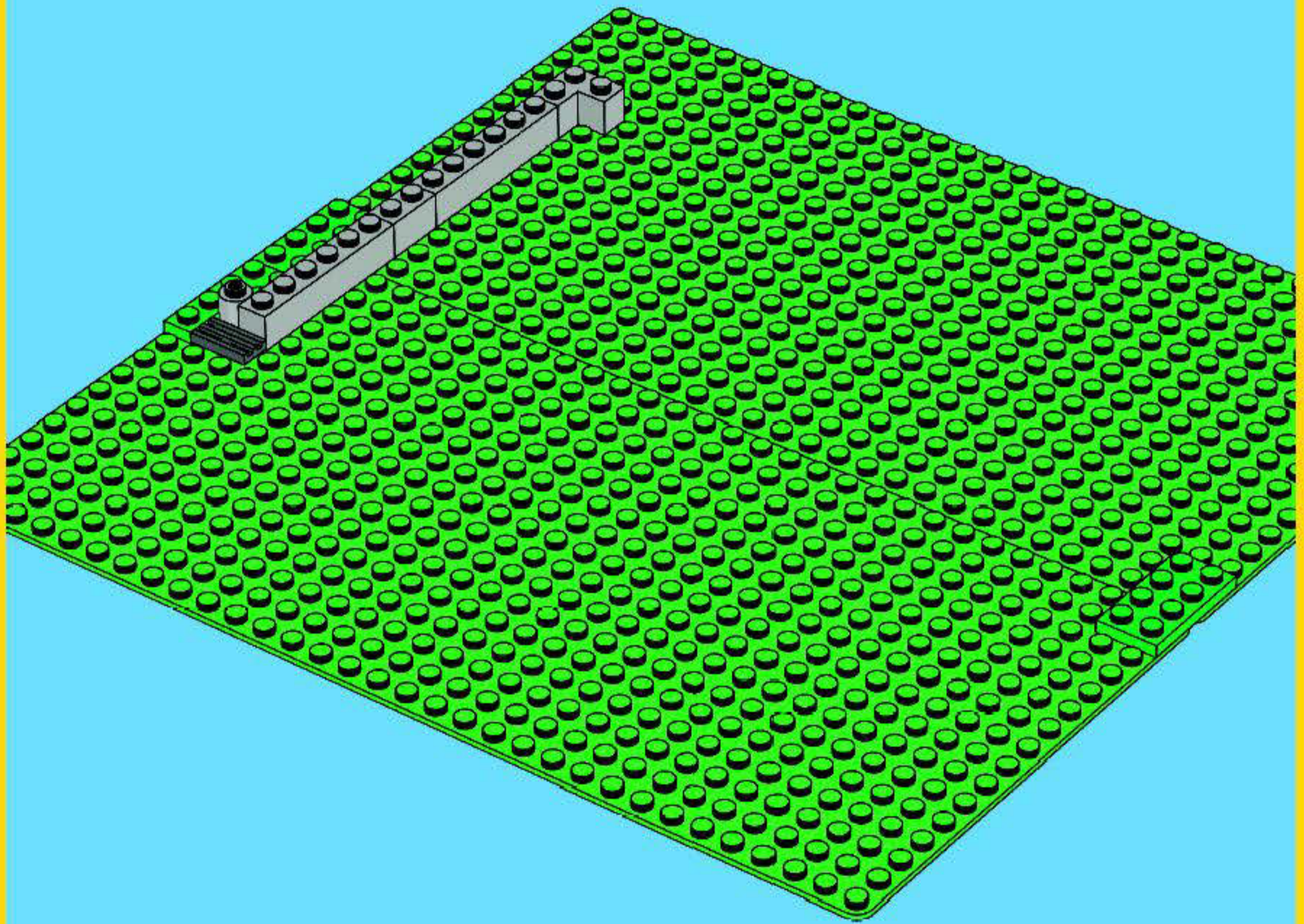



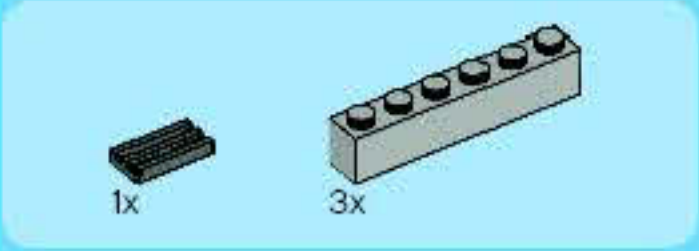

4

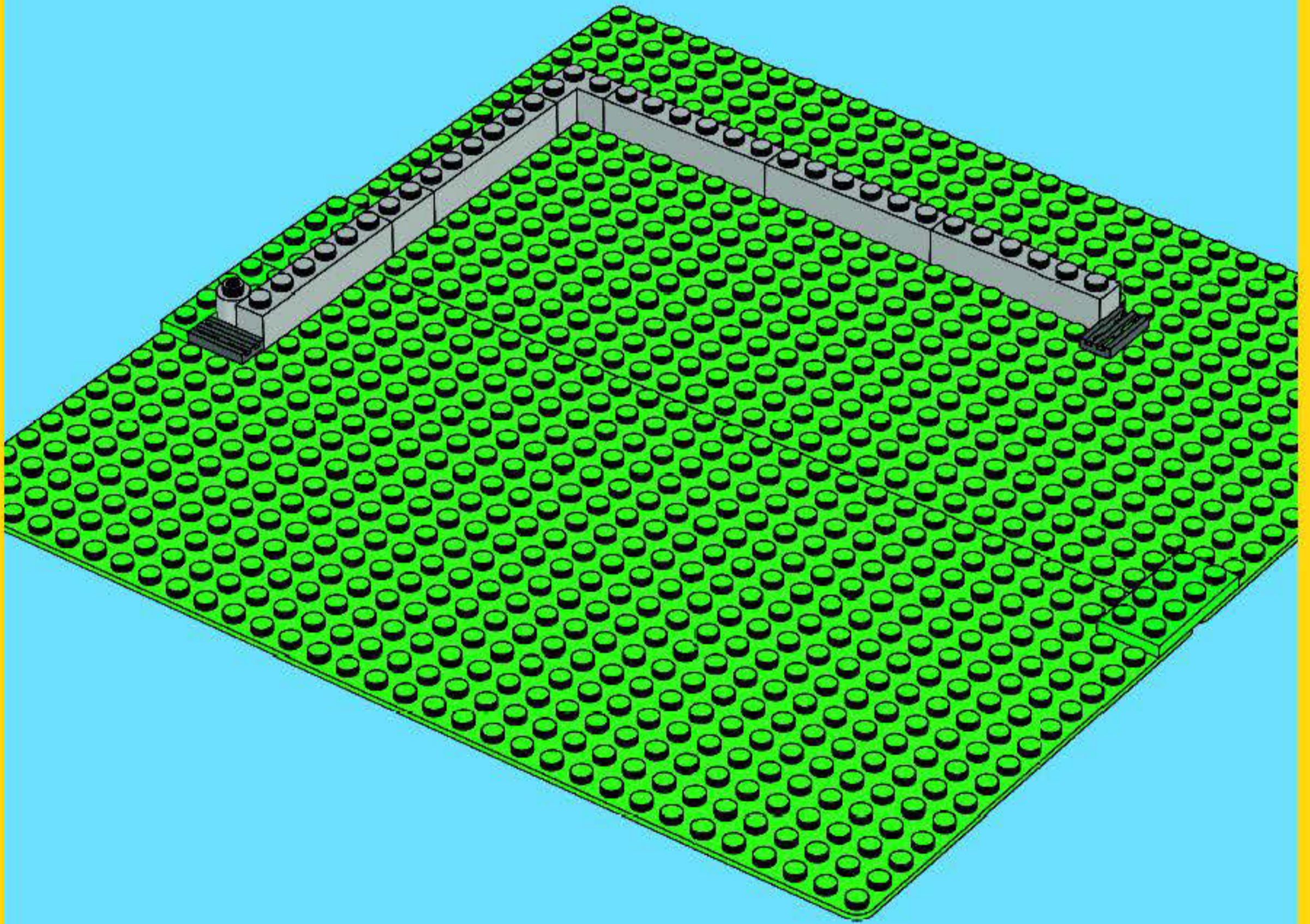





1x

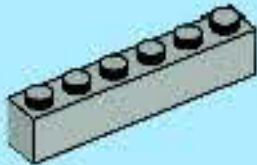

1x



3x



2x

# 5

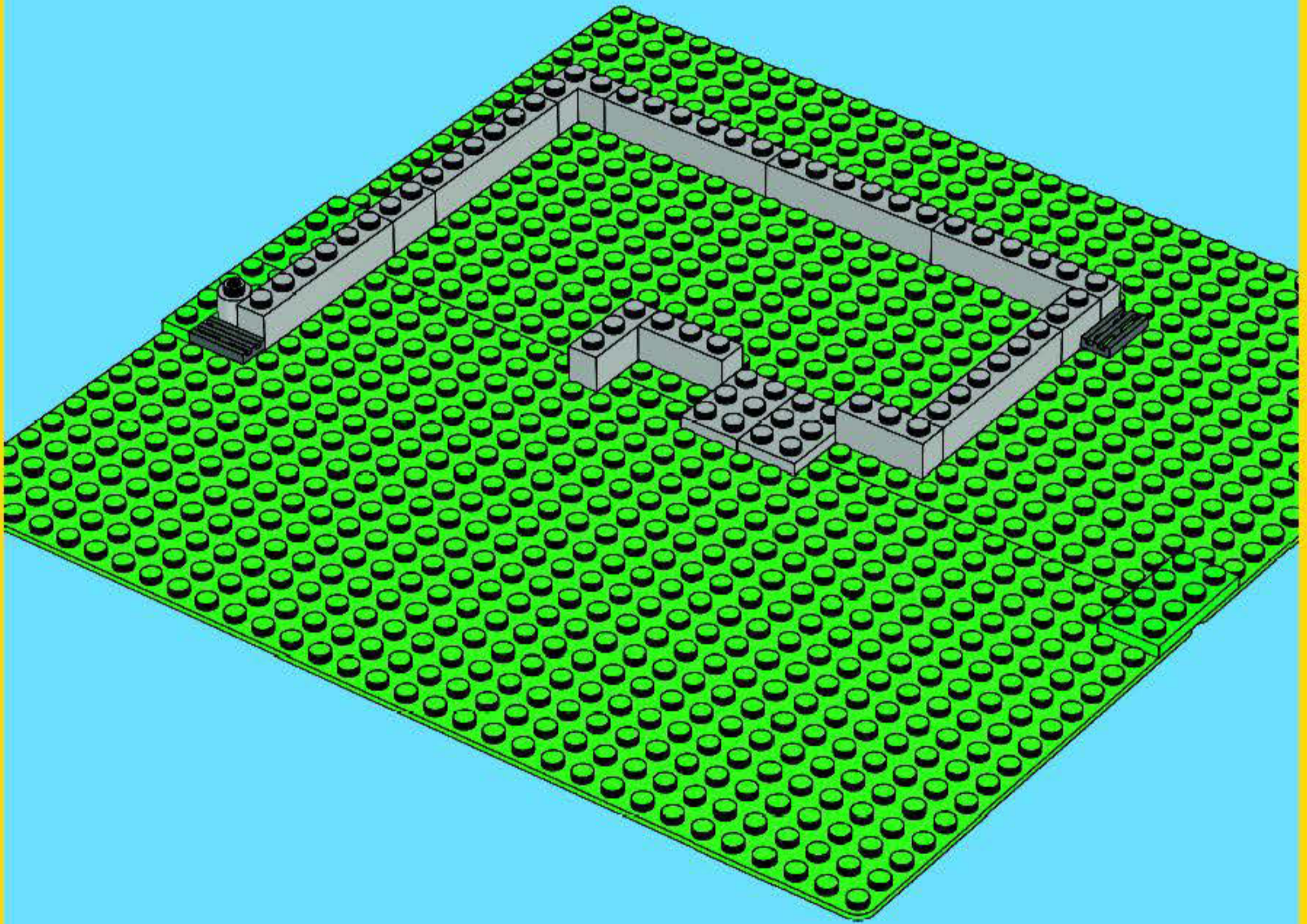





1x



2x

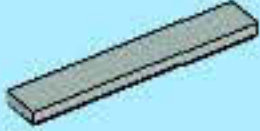

8x

# 6

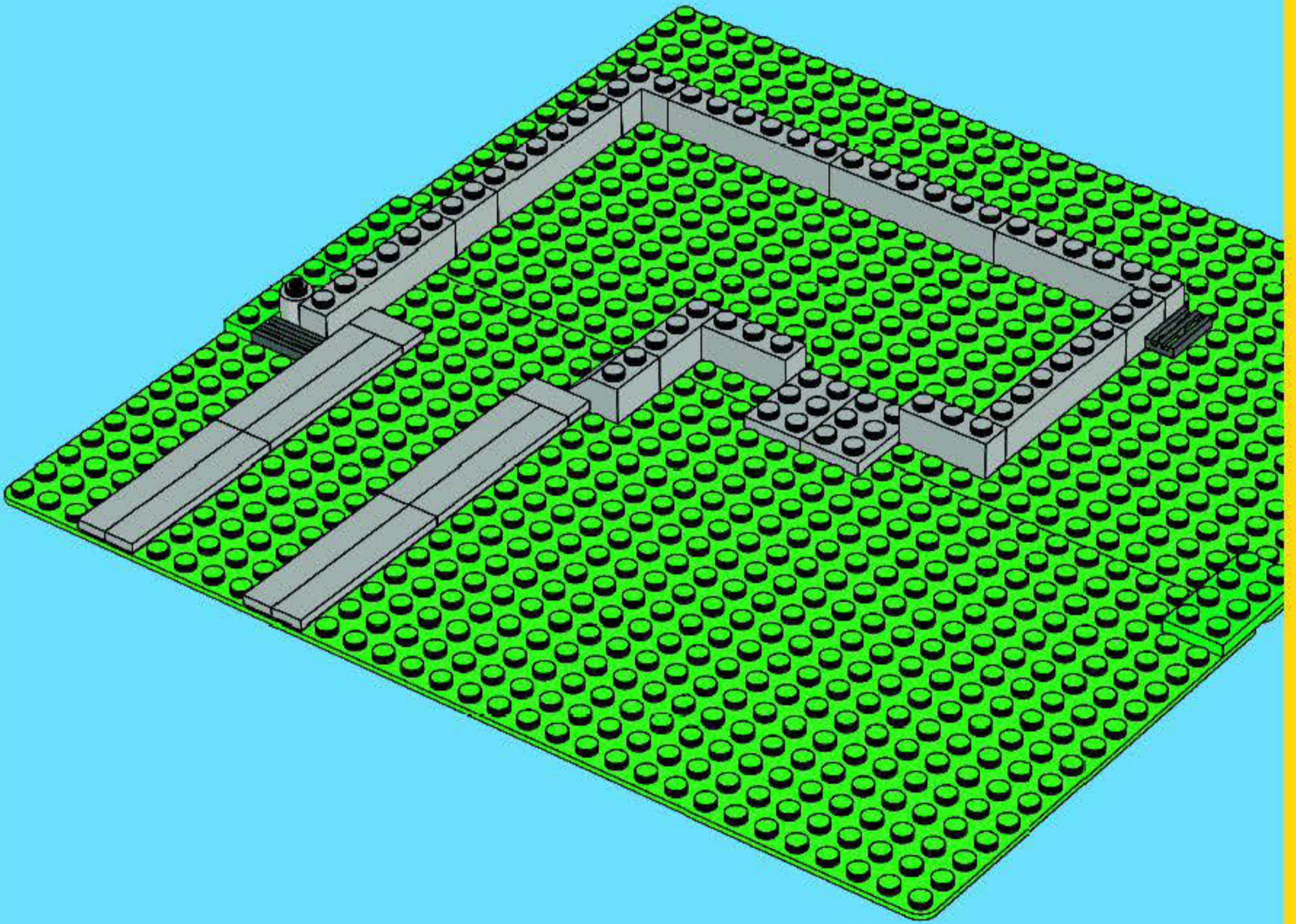



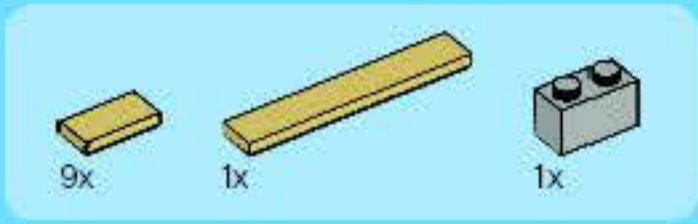

7

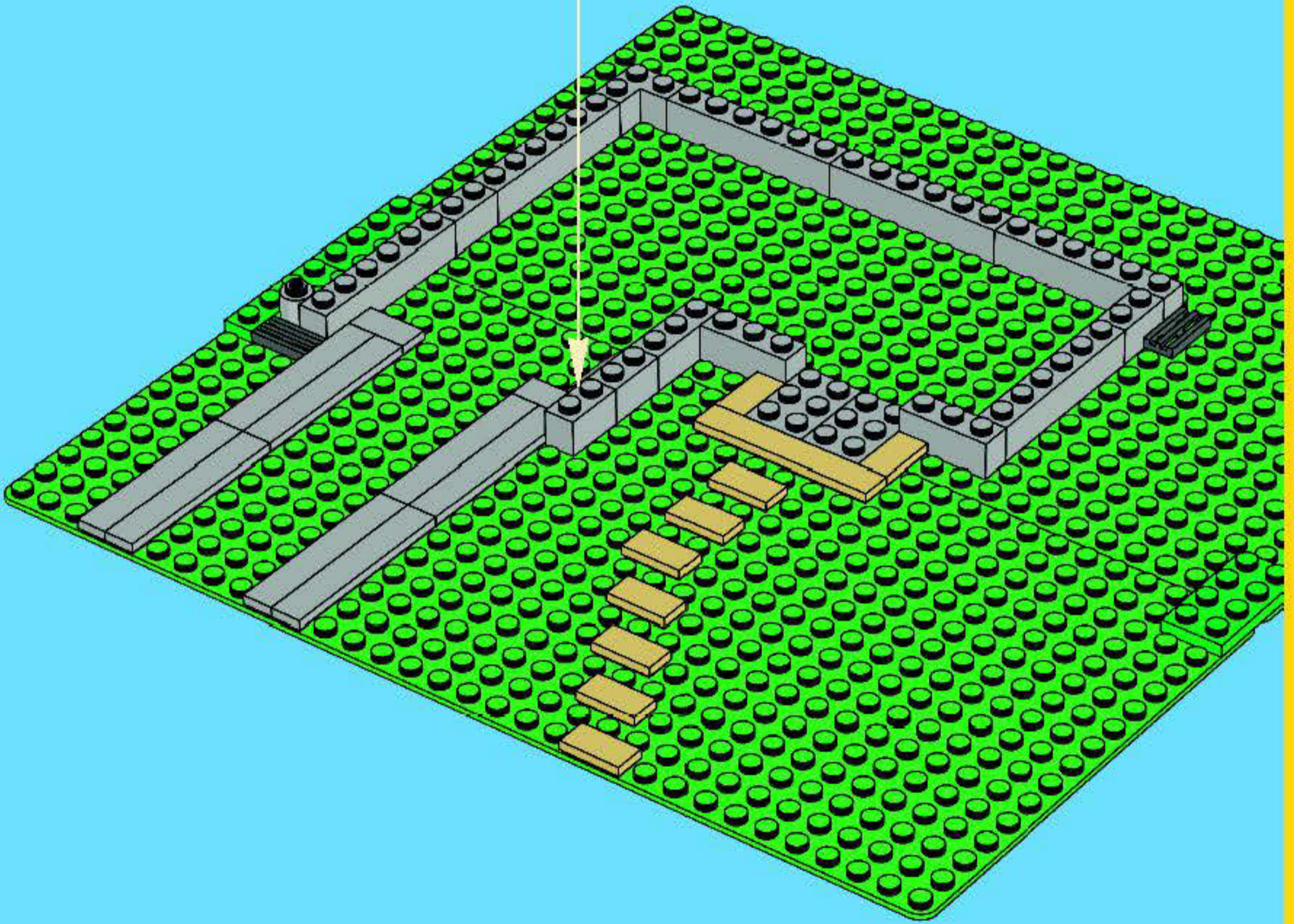
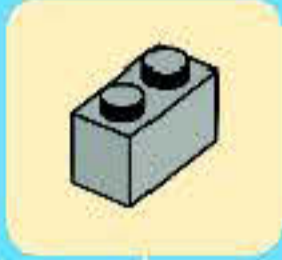





2x



4x



4x

8

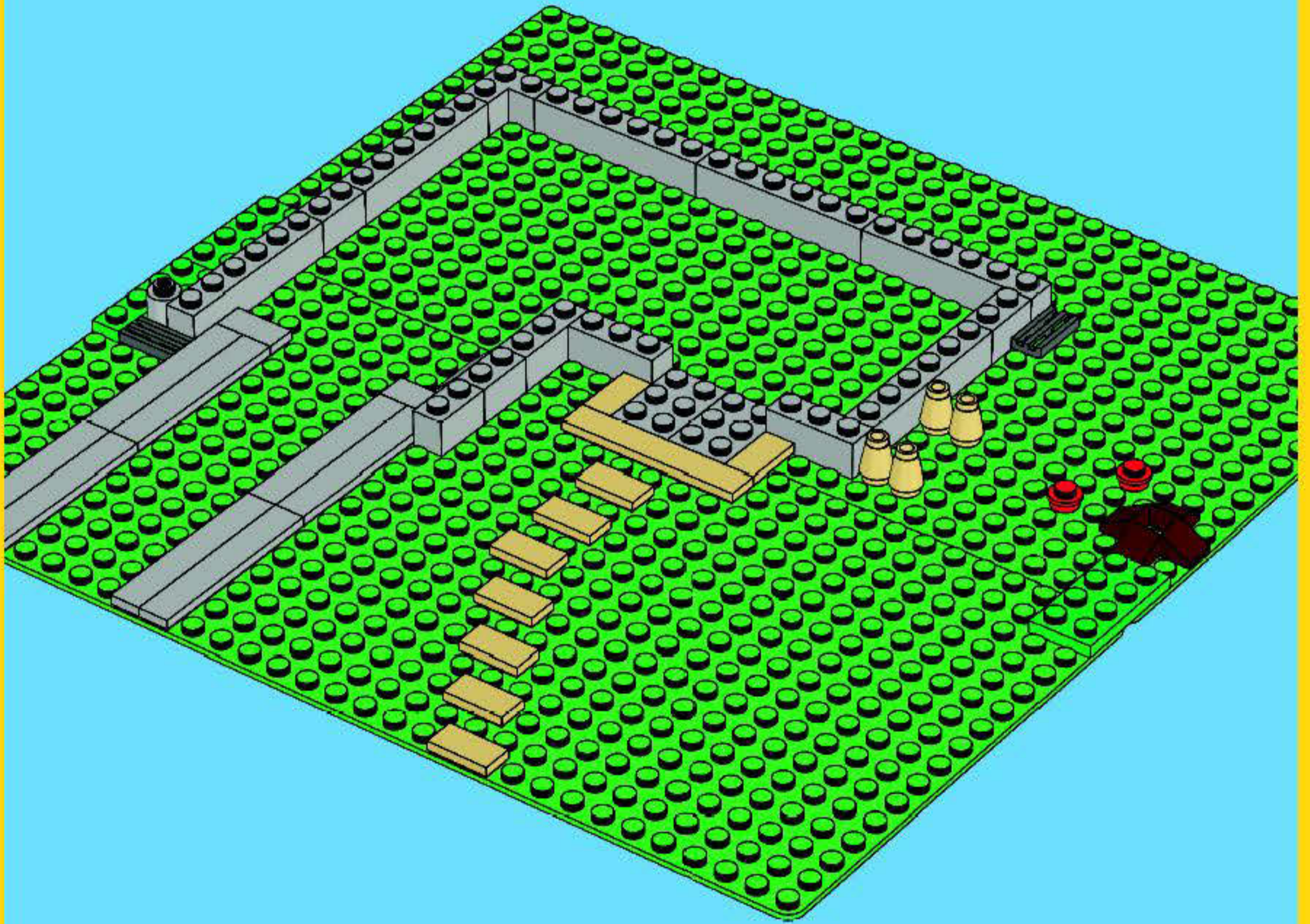





3x



1x

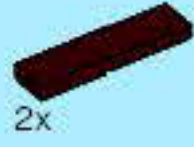

2x

9

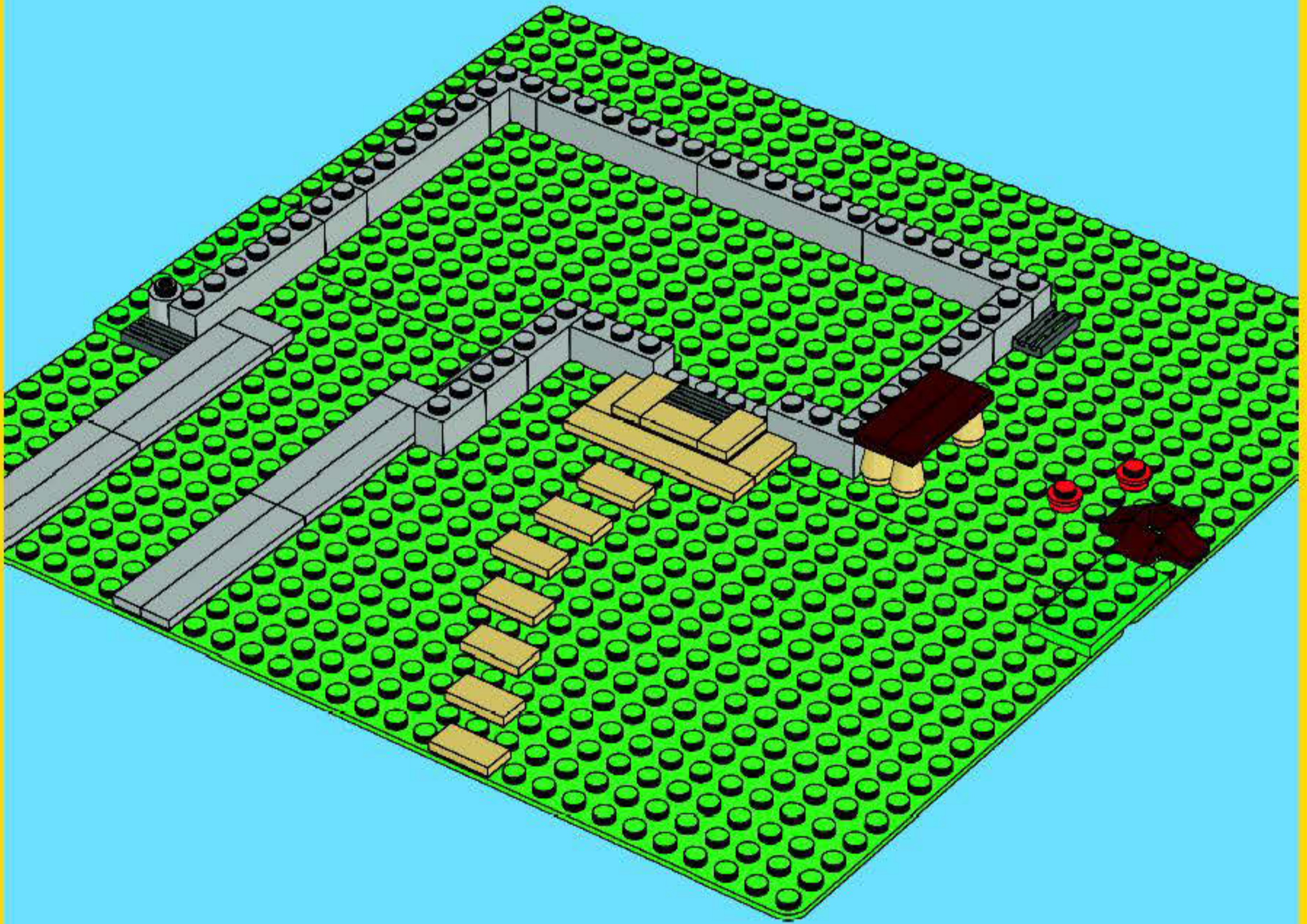



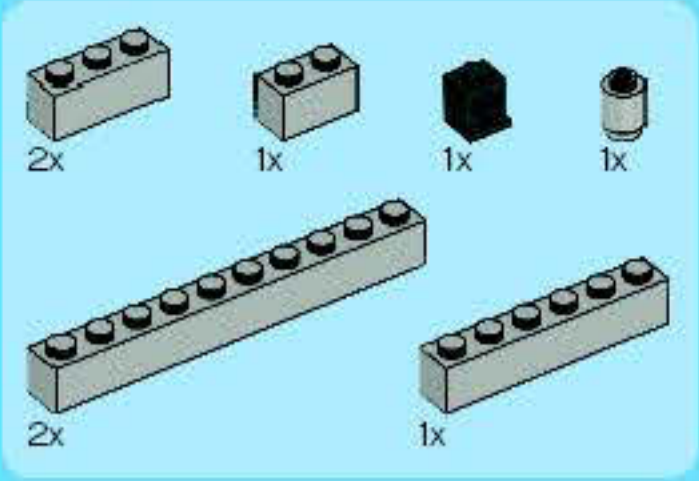

# 10

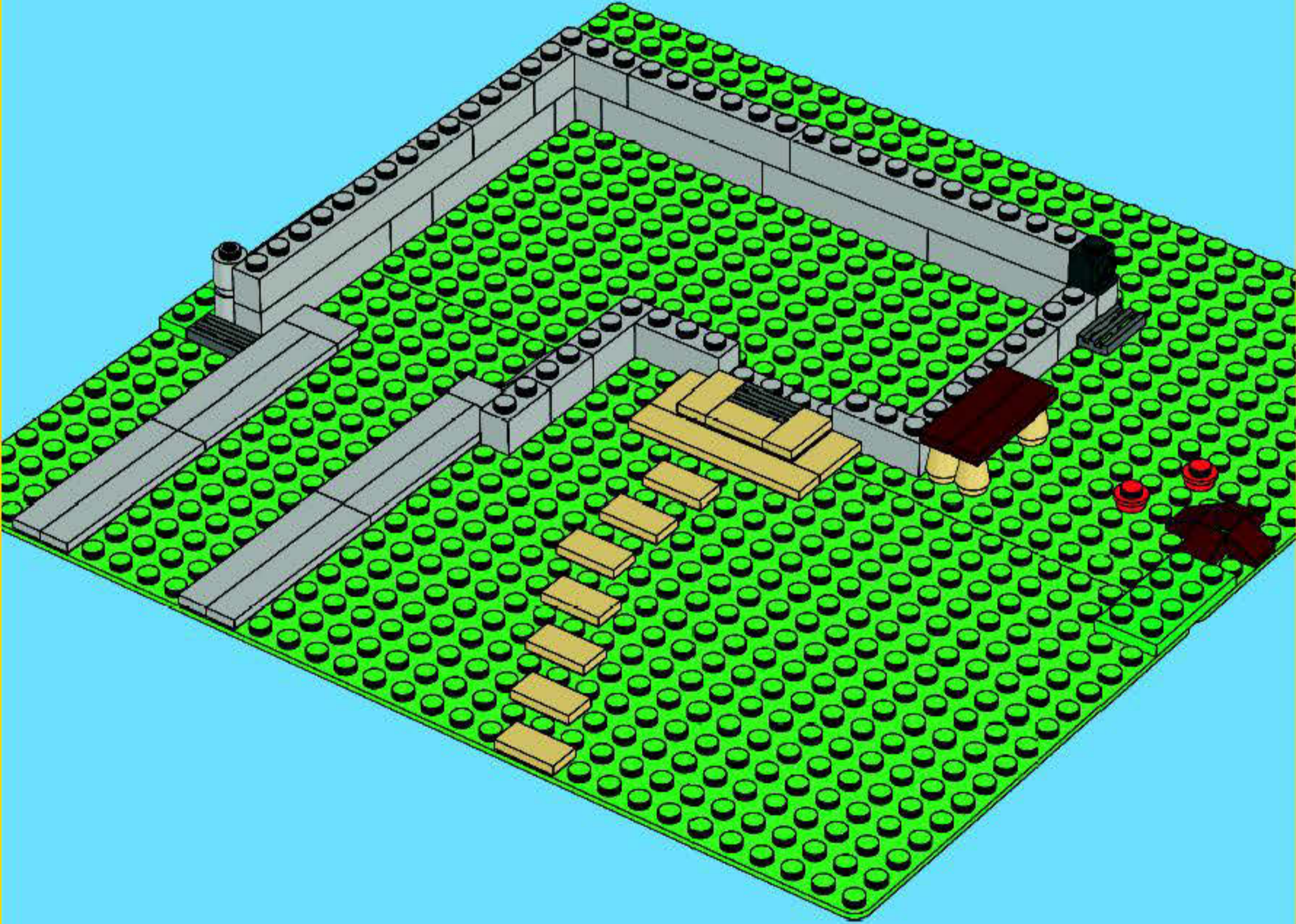



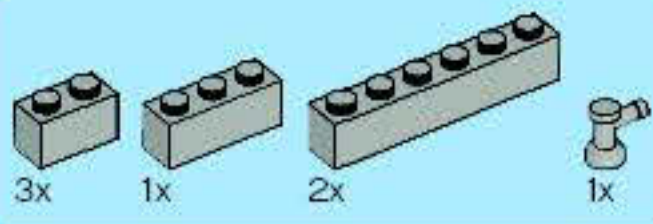

11

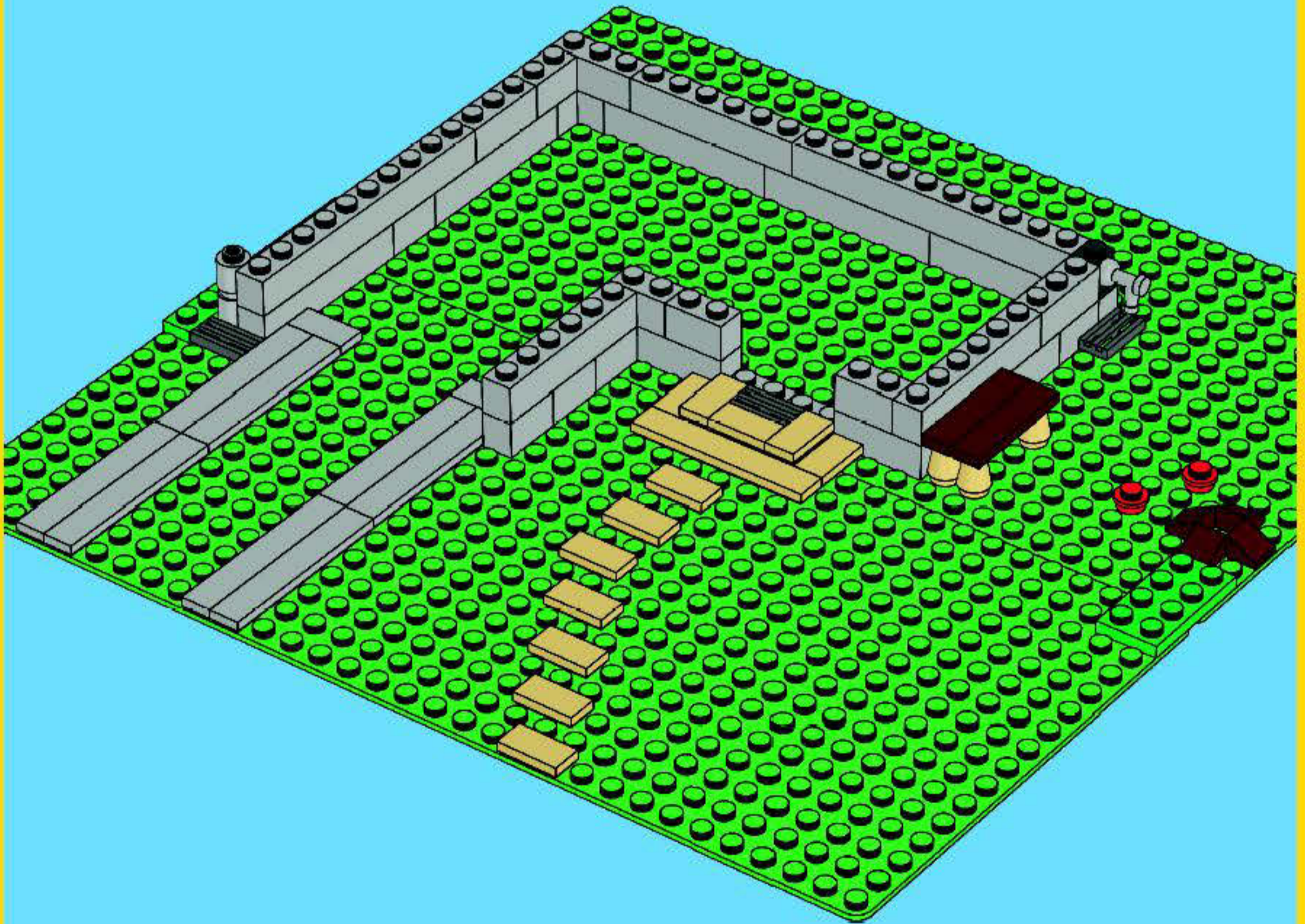





12

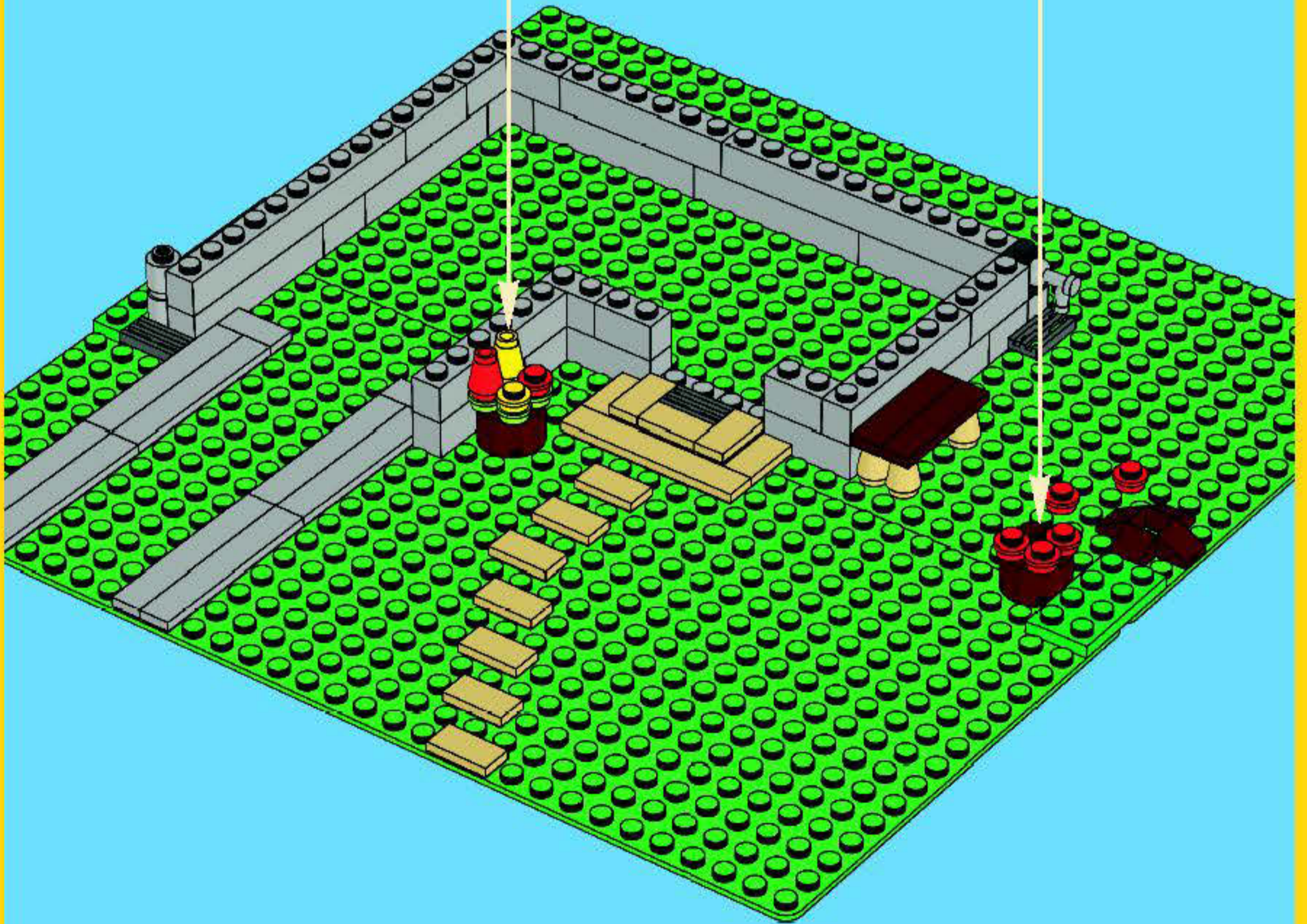







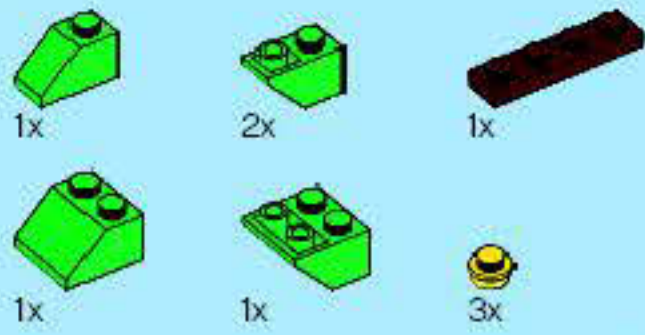

14

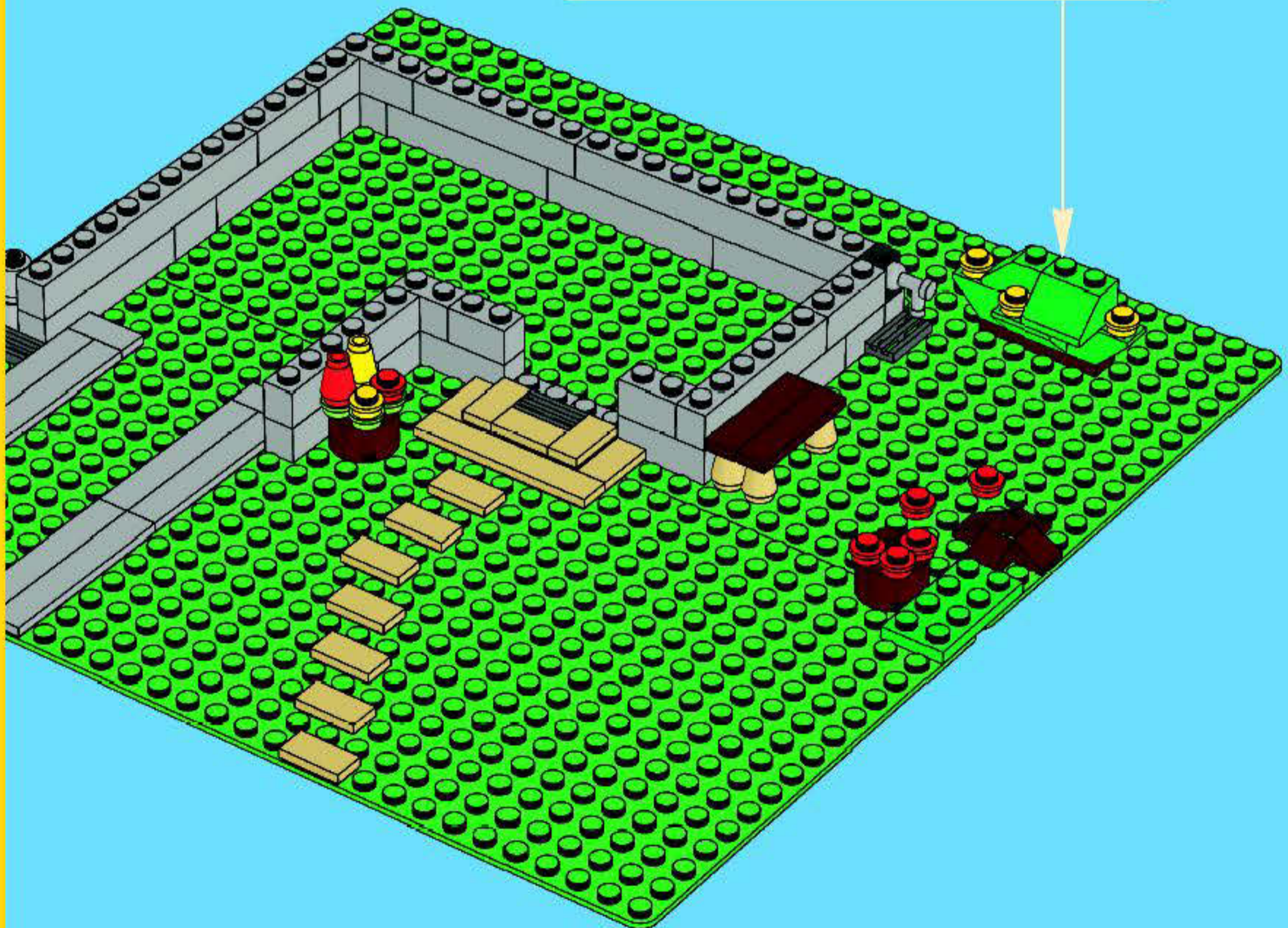
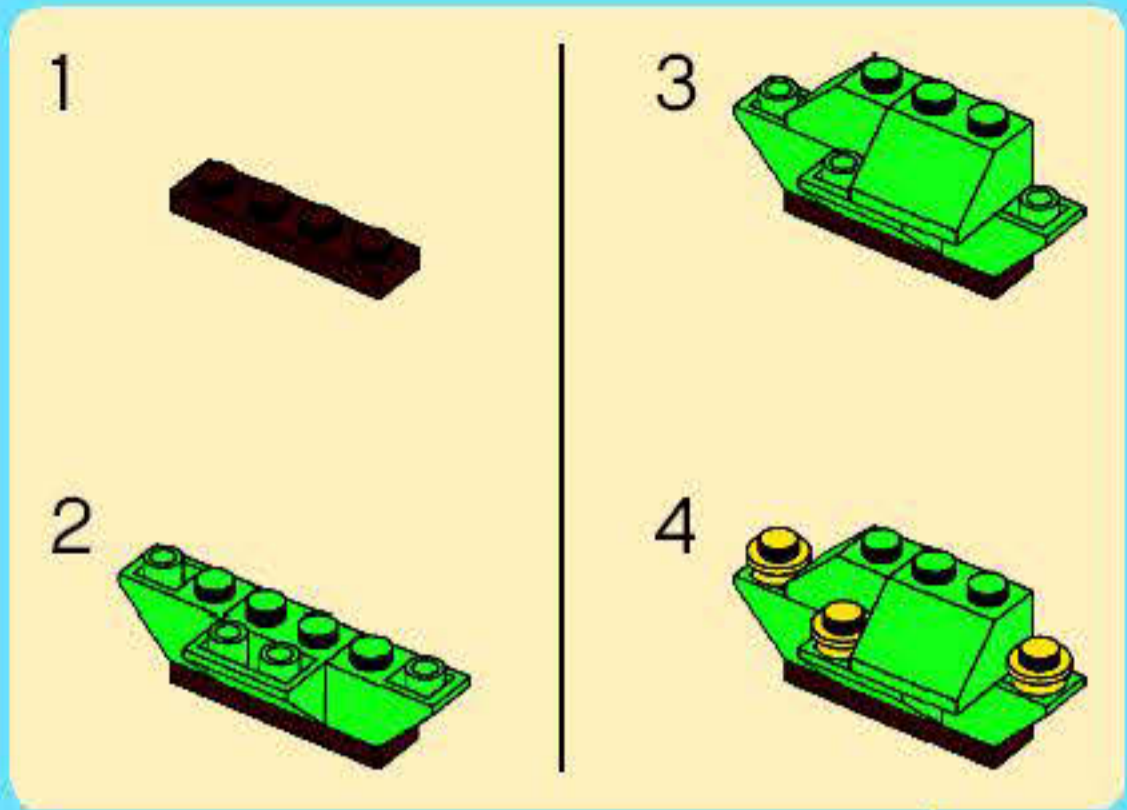



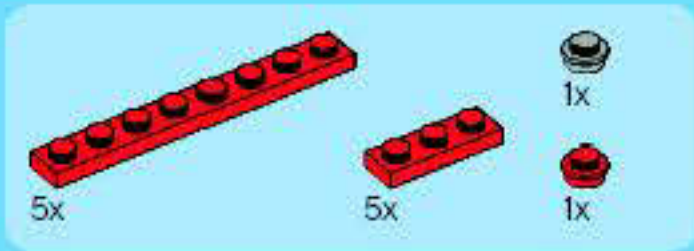

15

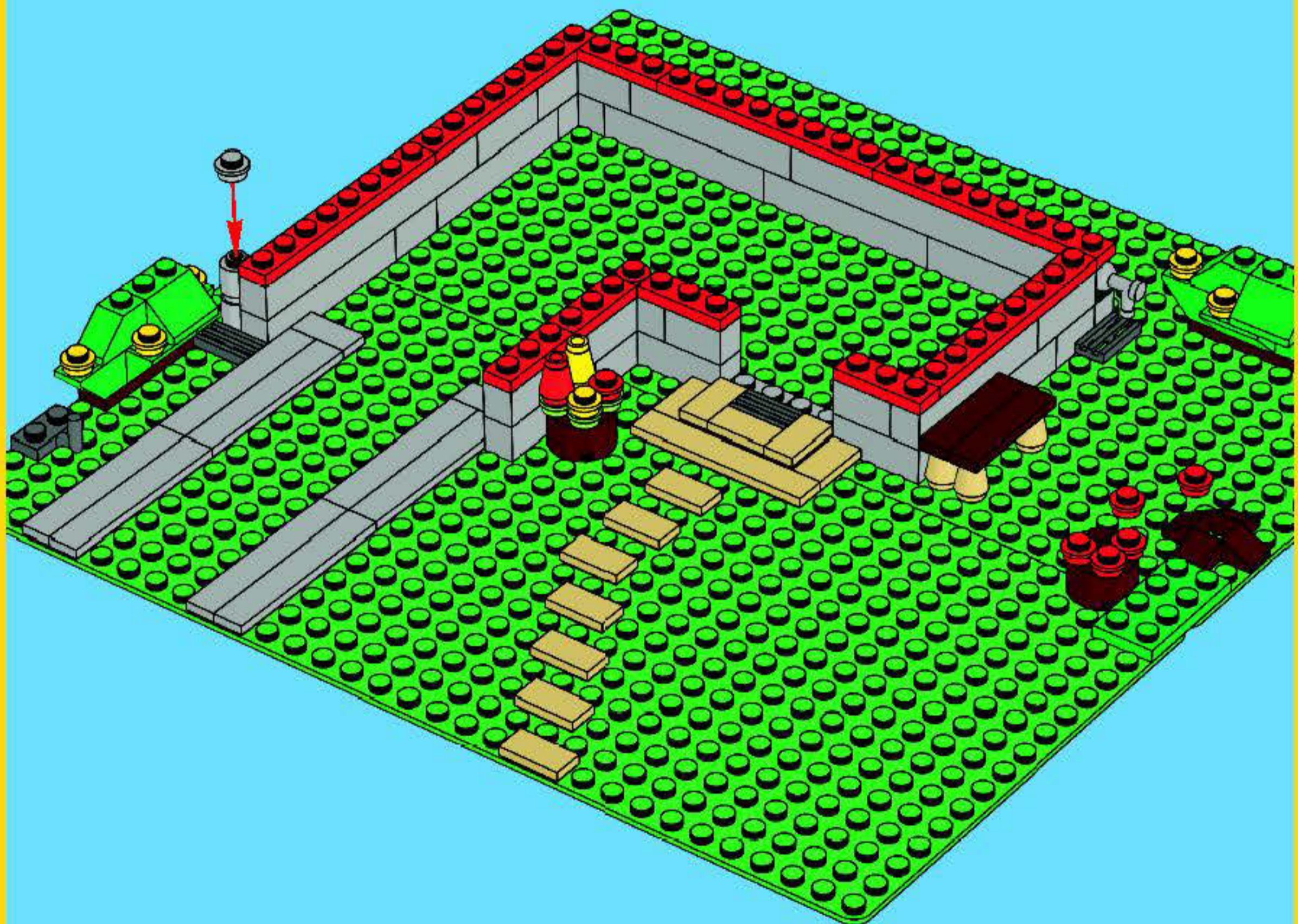



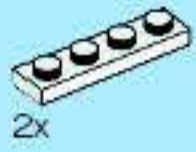

2x

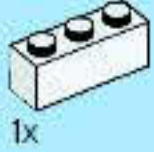

1x



1x

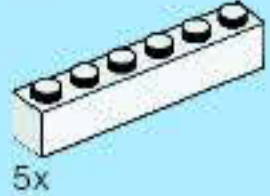

5x

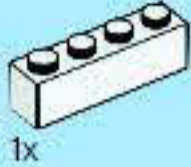

1x

# 16

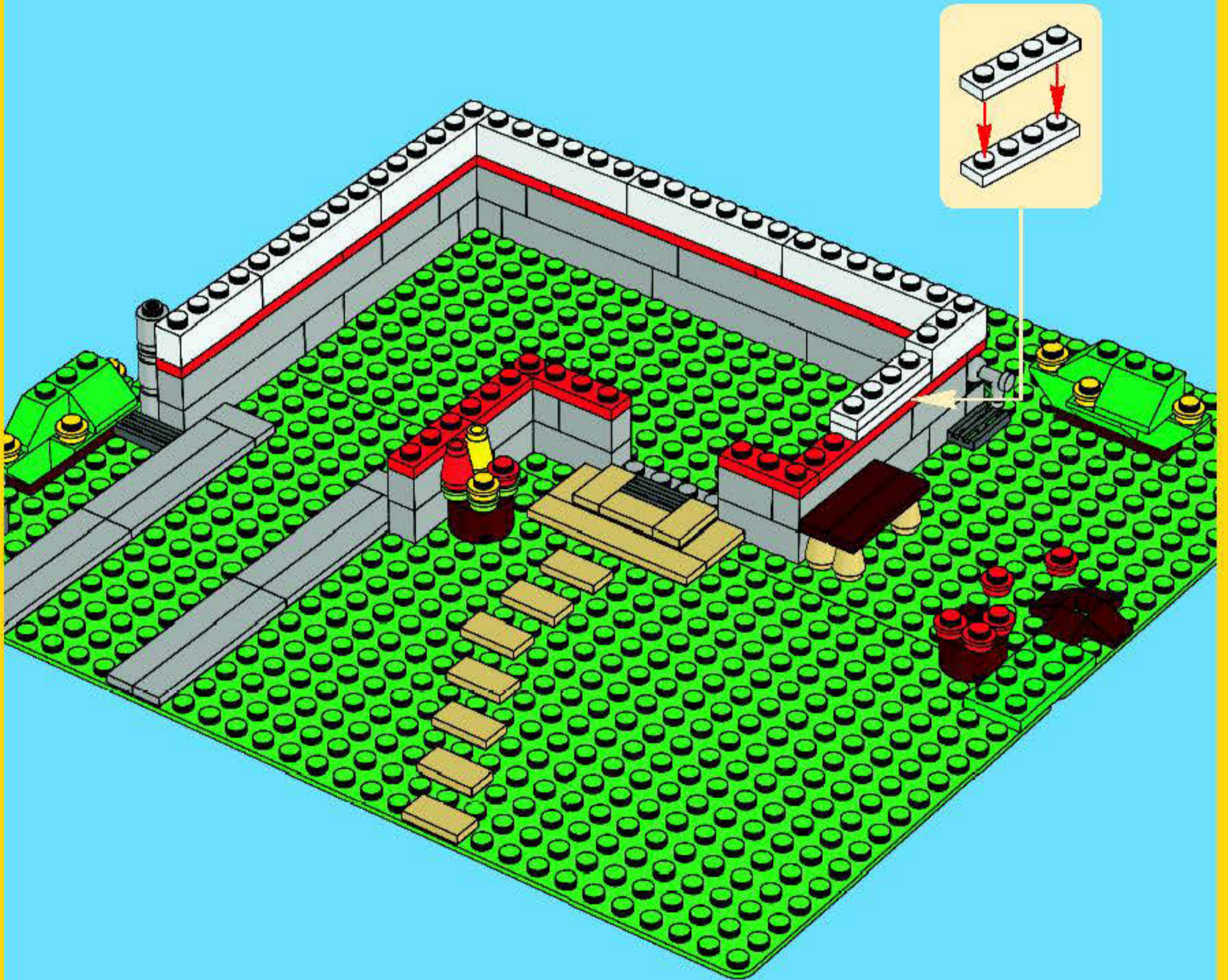



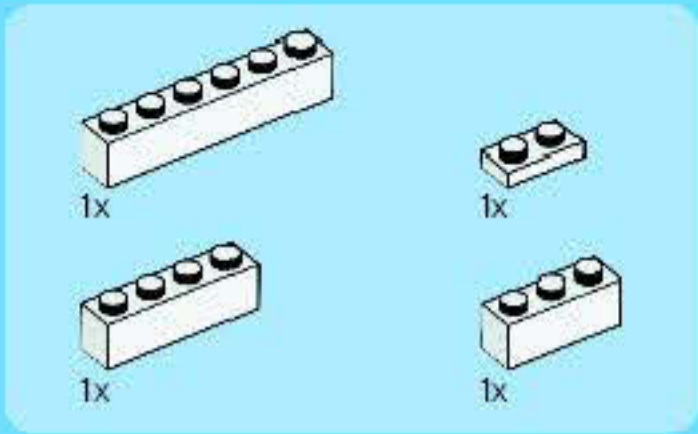

17

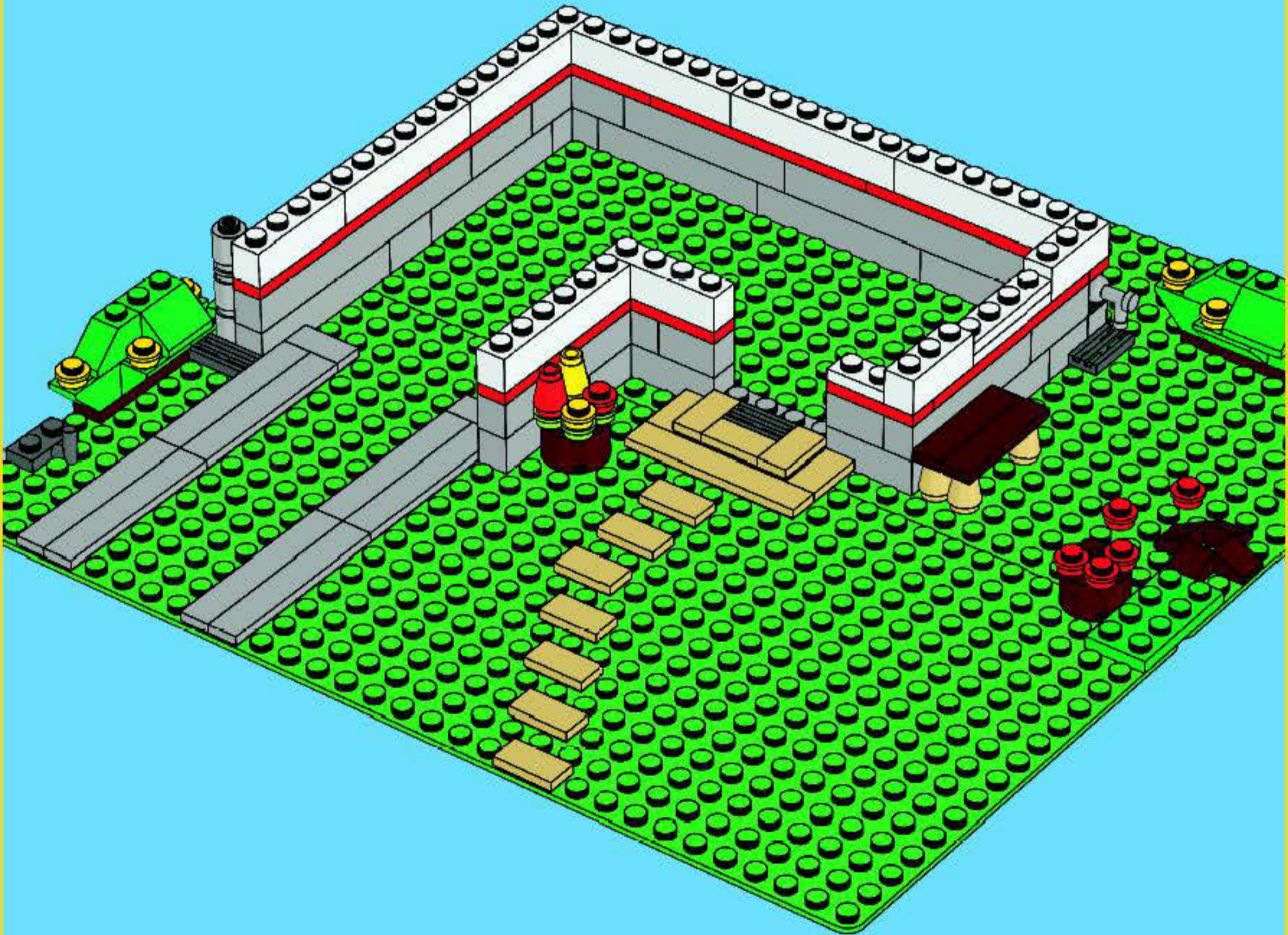



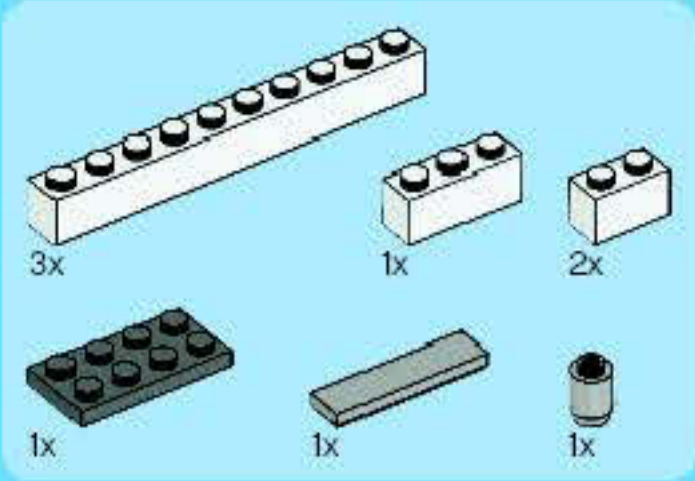

18

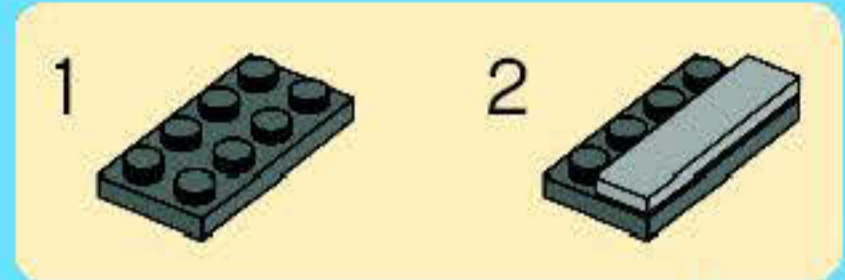



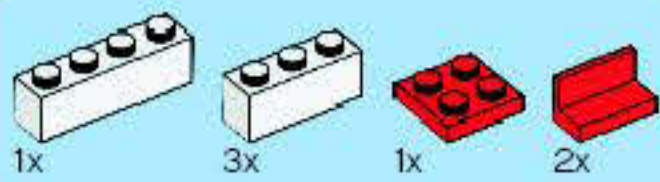

19

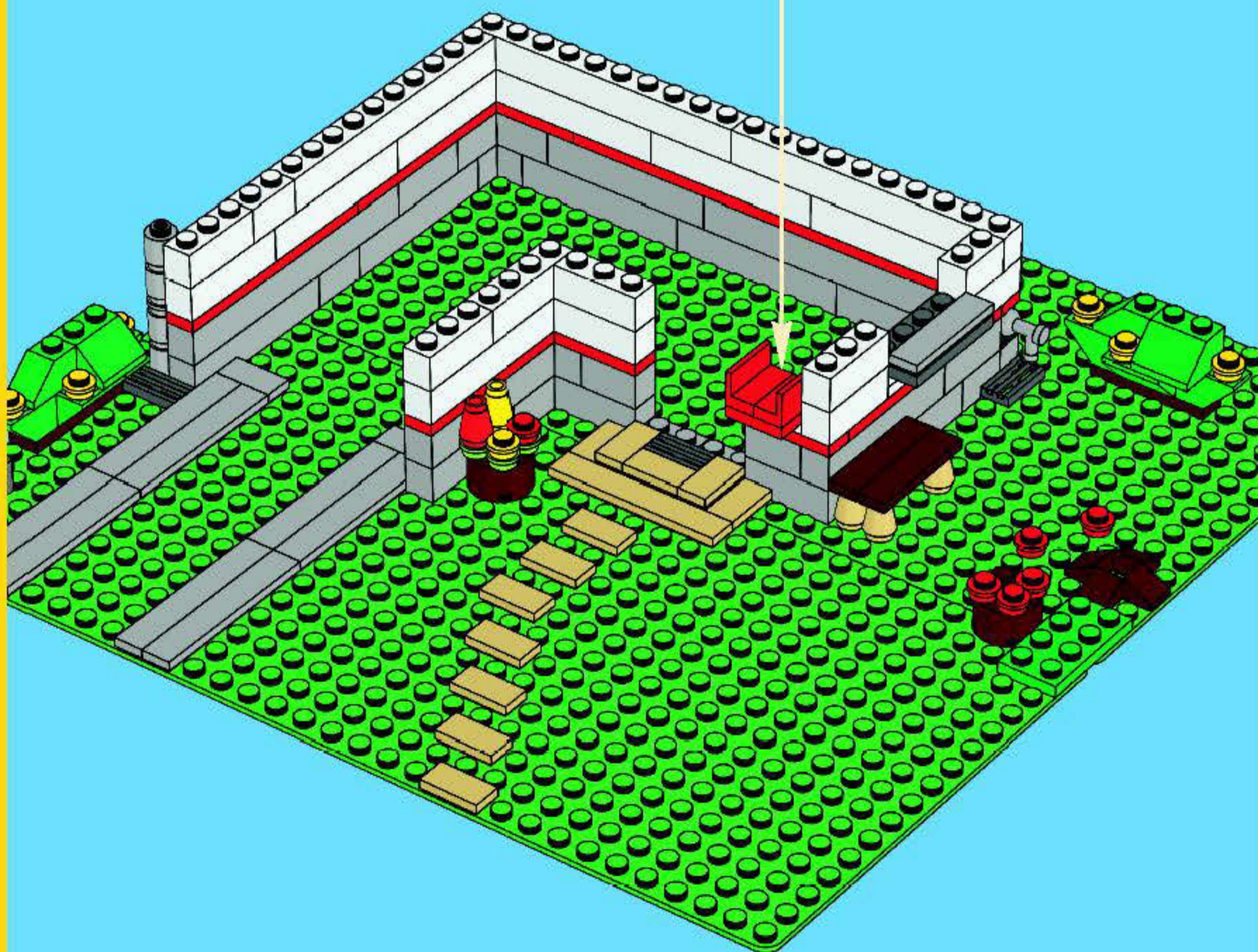
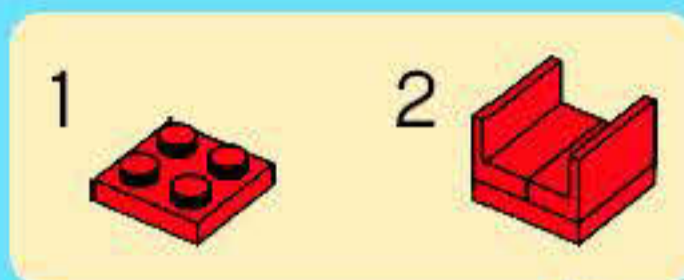



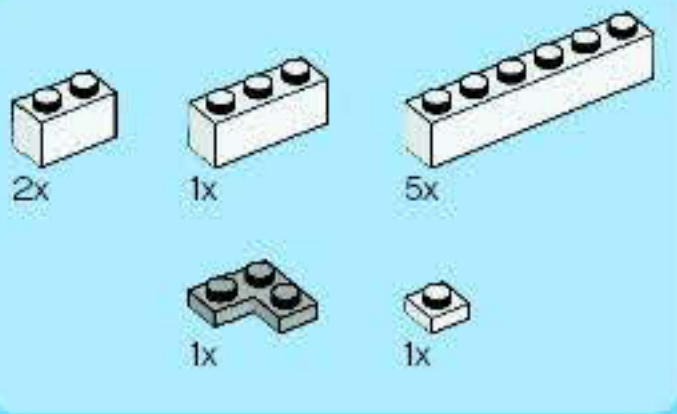

20

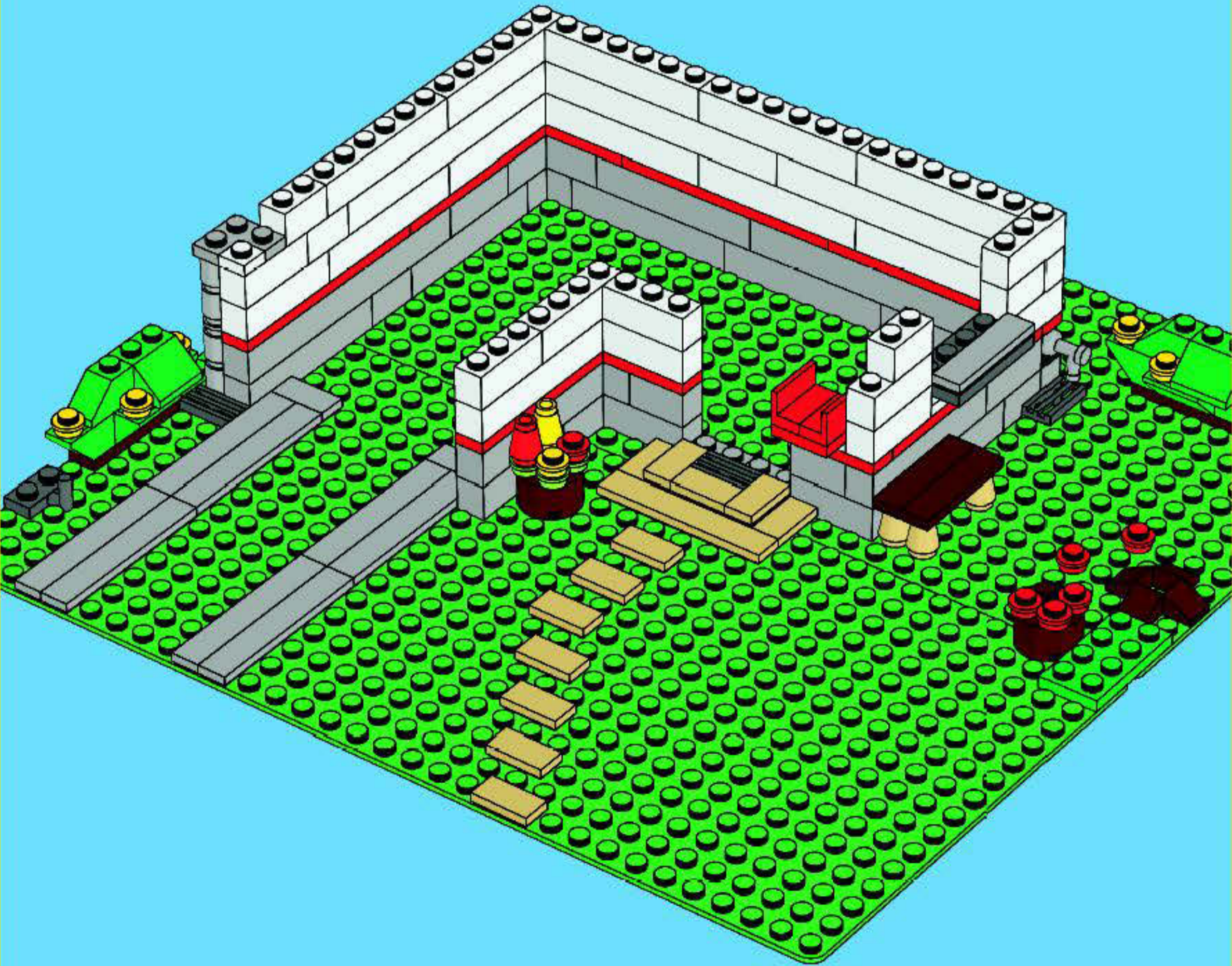





1x

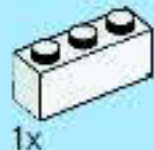

1x

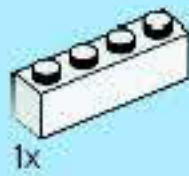

1x



1x

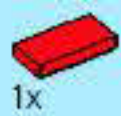

1x



1x

# 21

1



2

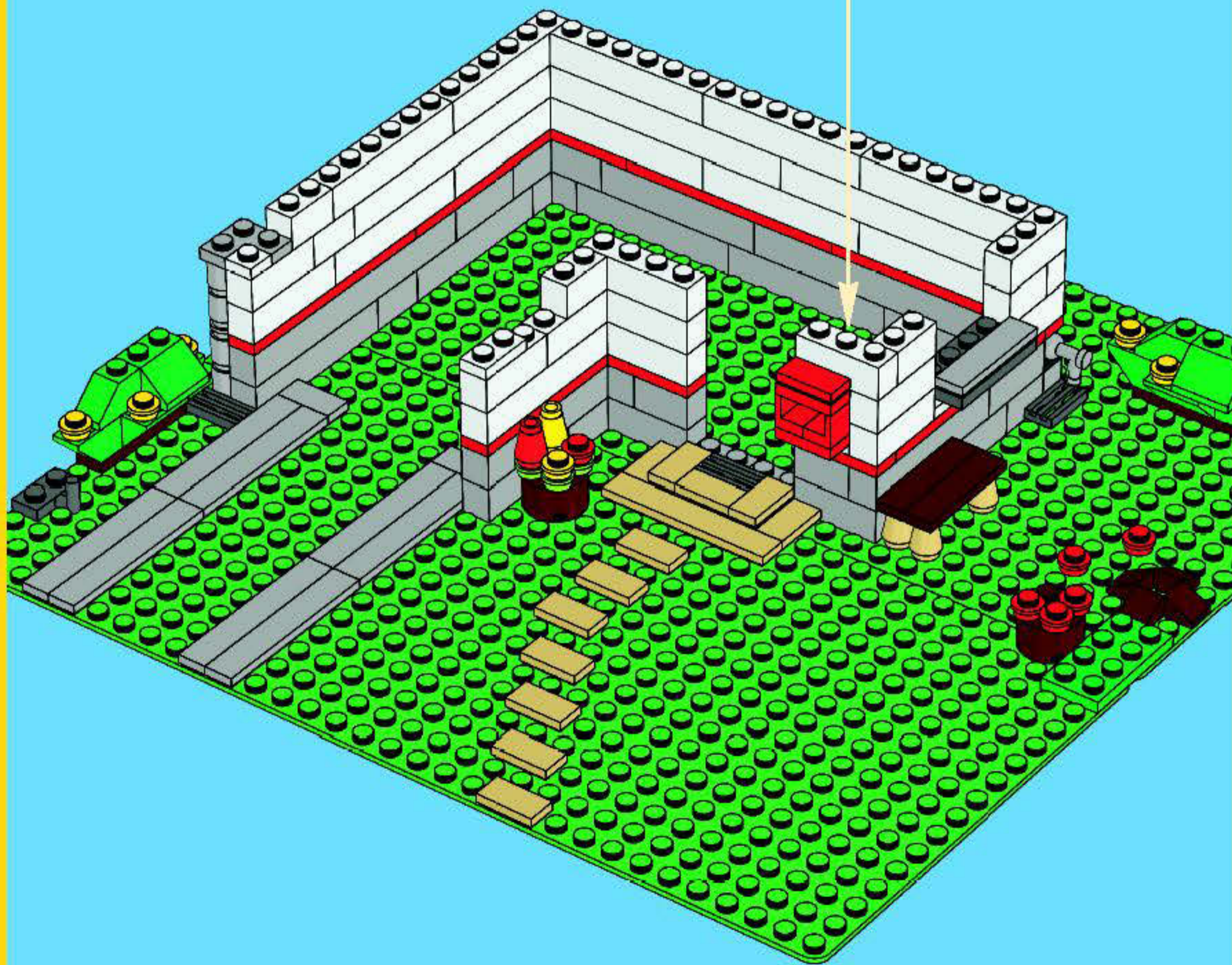
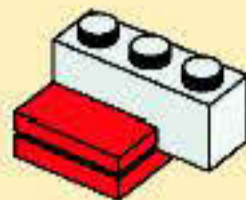



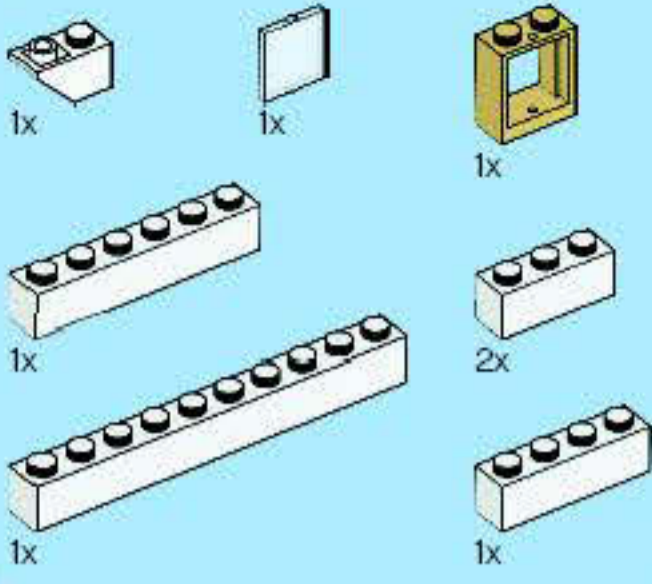

22

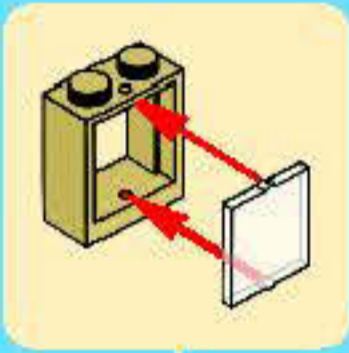



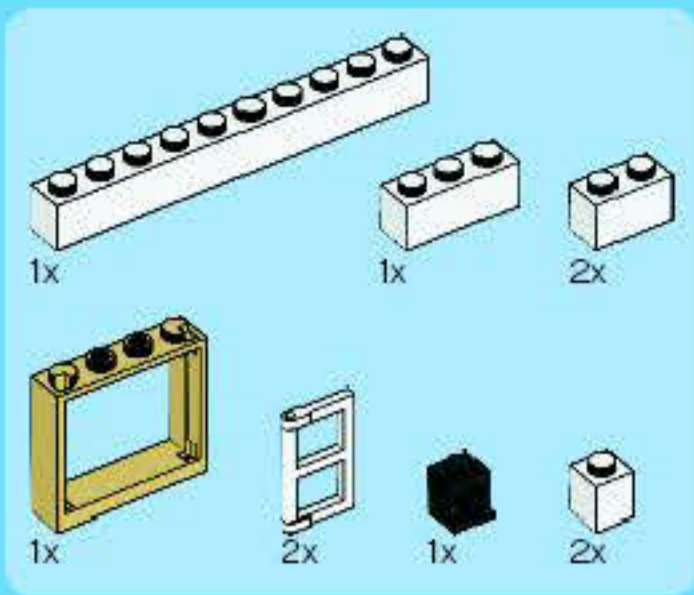

23

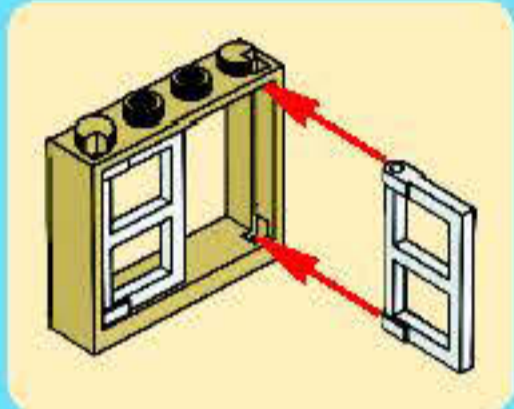
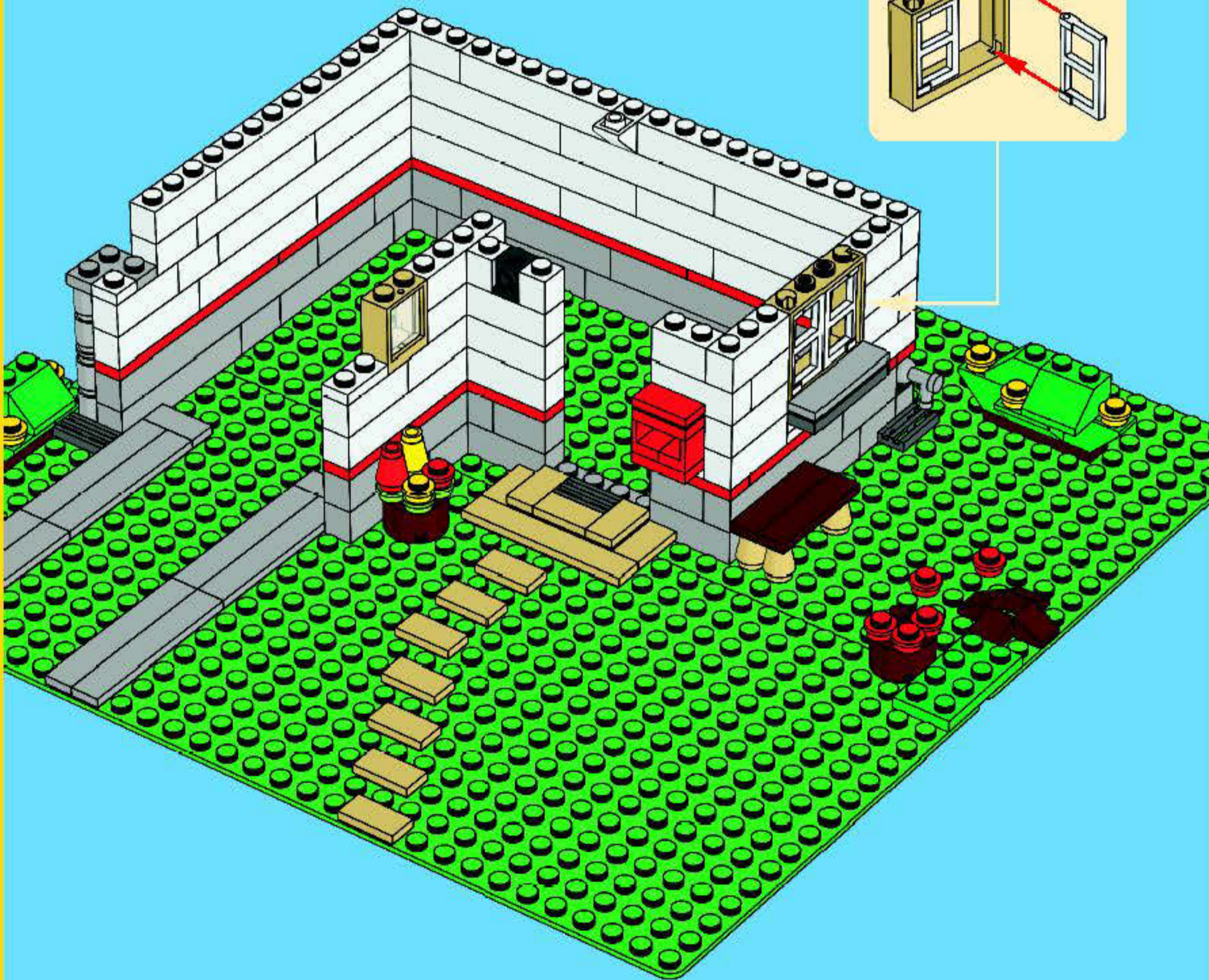



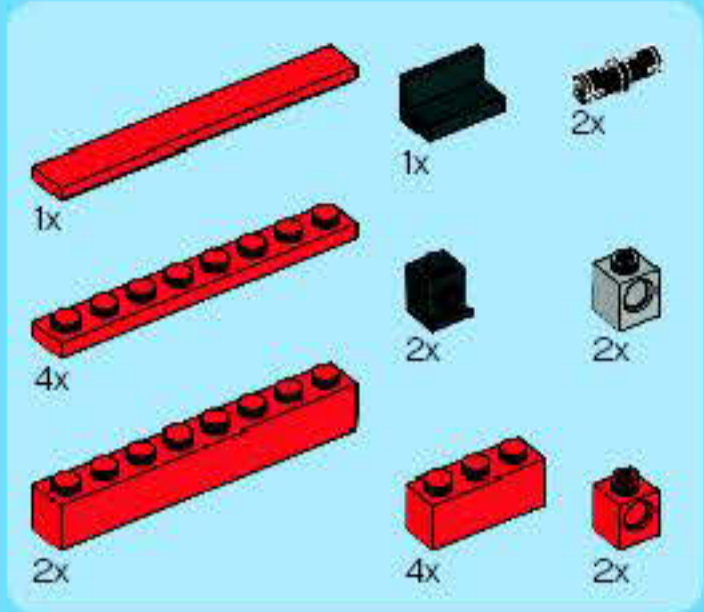
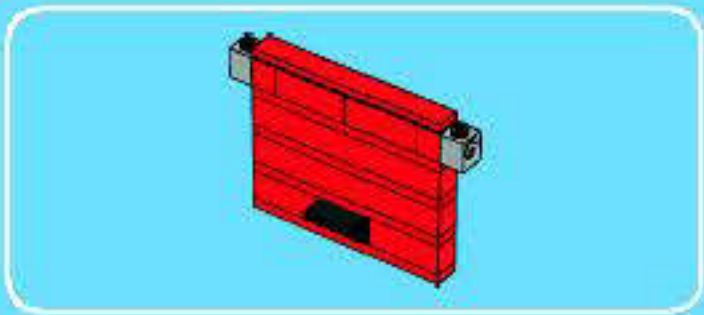

24

1

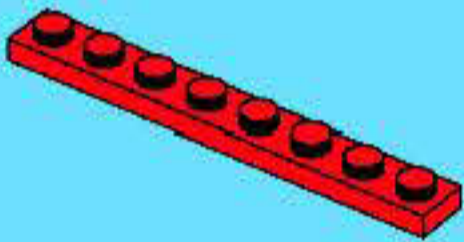

2

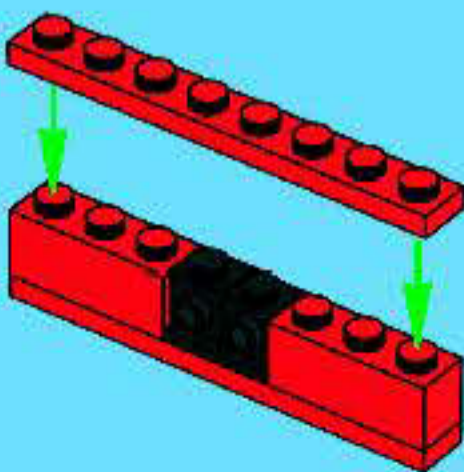

3

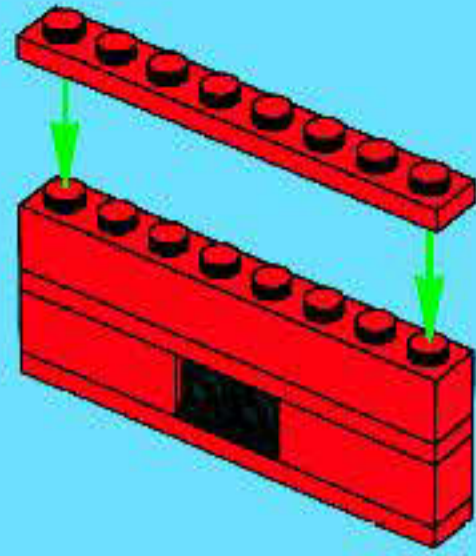

4

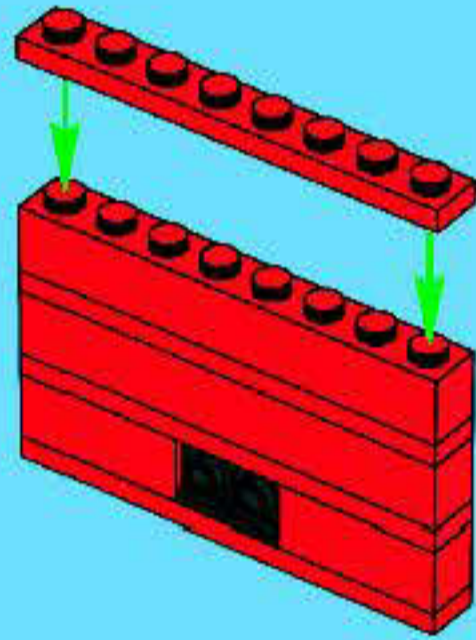

5

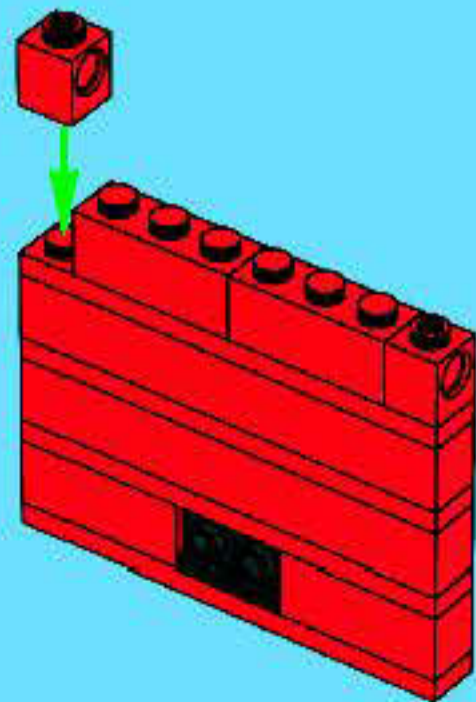



6

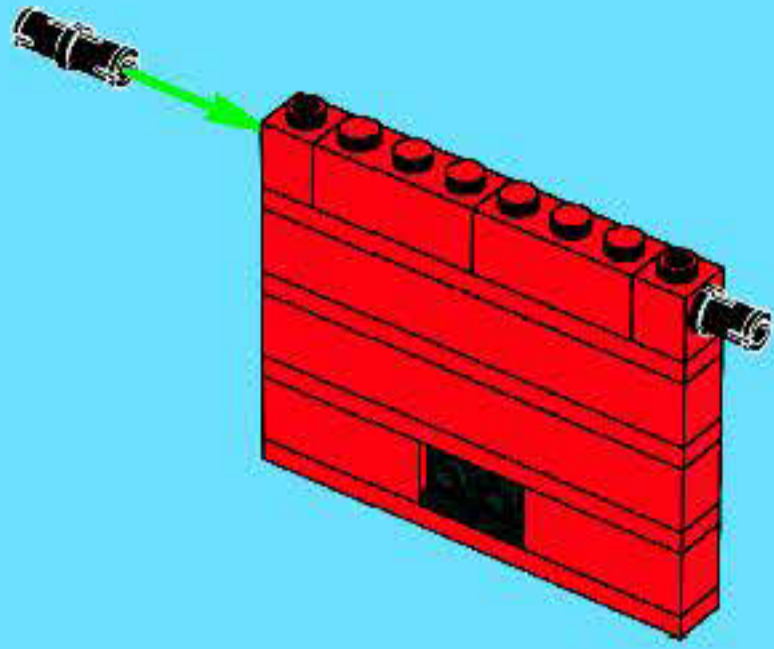

7

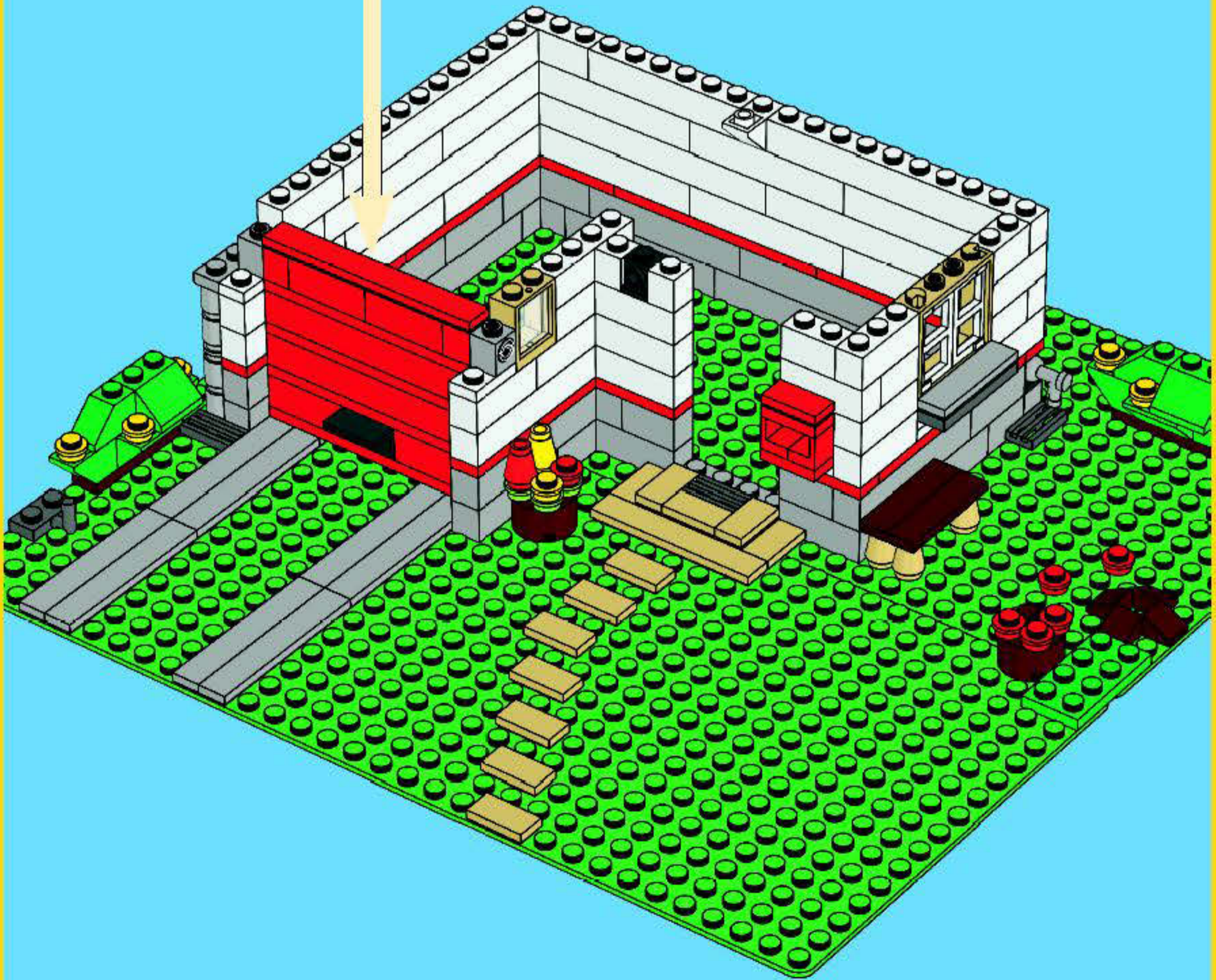
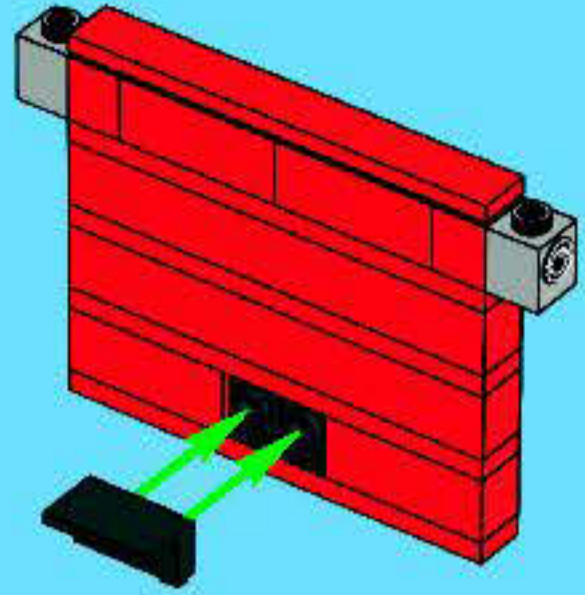





2x



1x

# 25

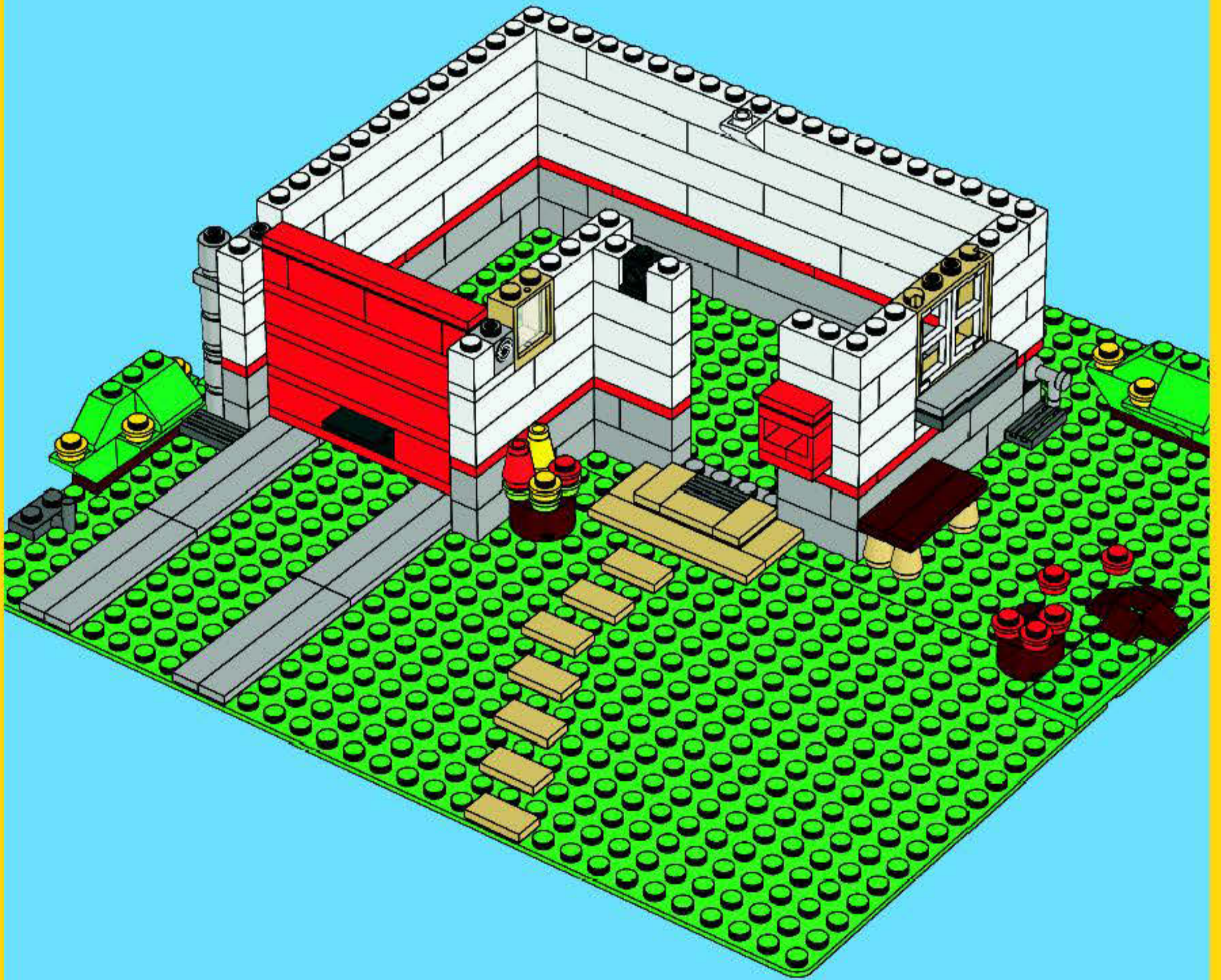





4x



1x

# 26

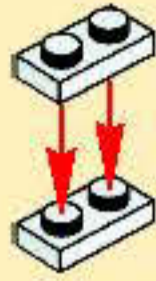

2x

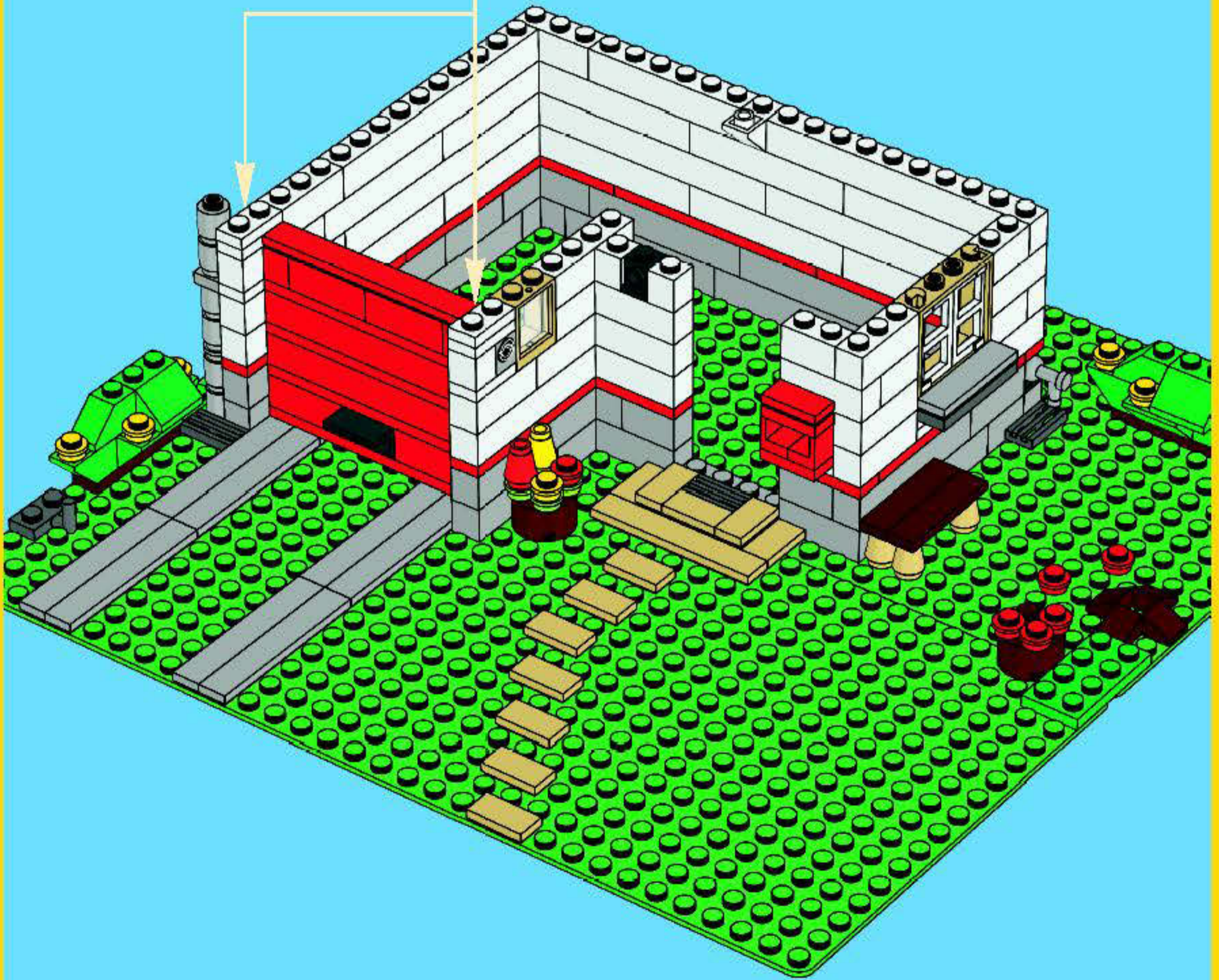



27

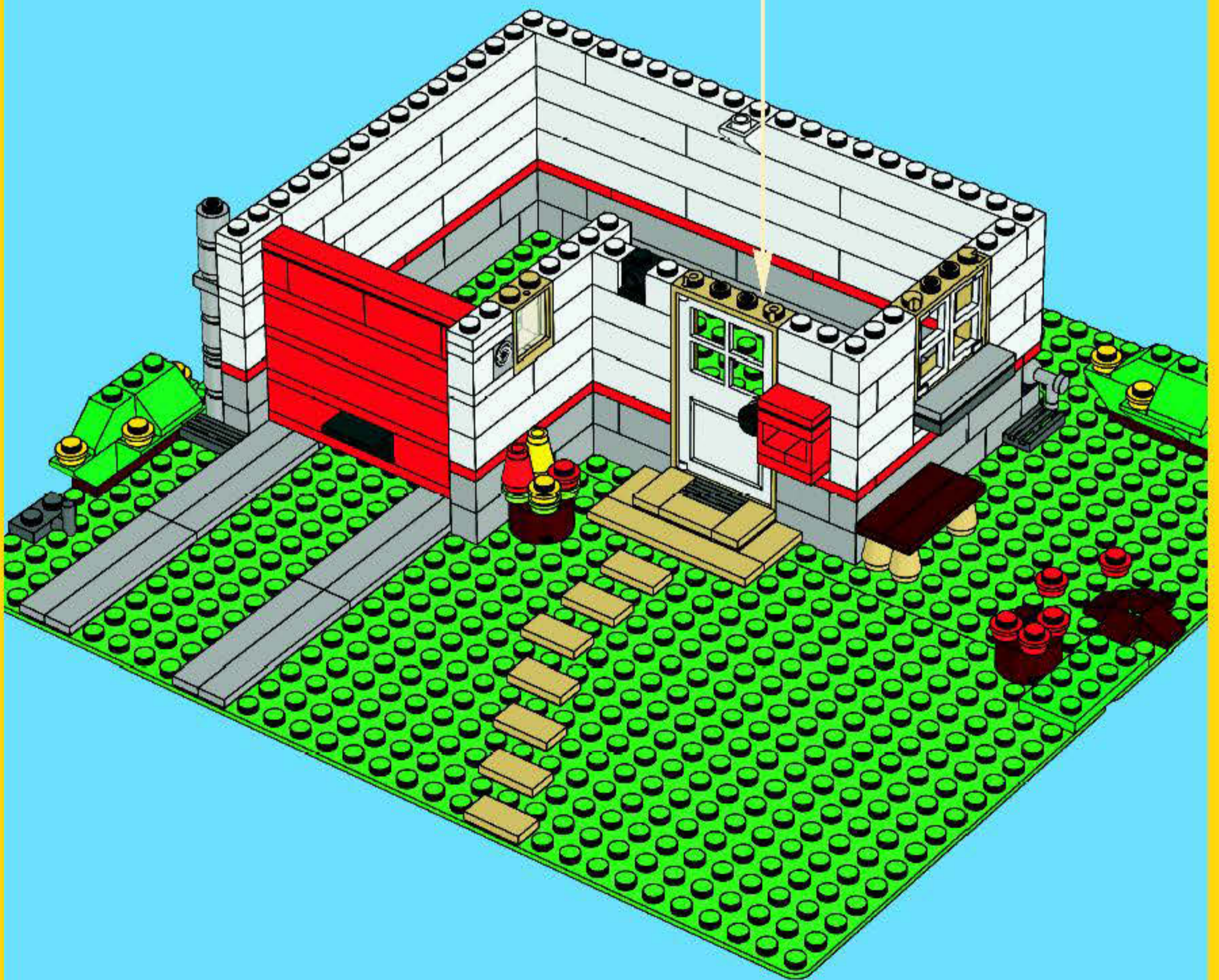
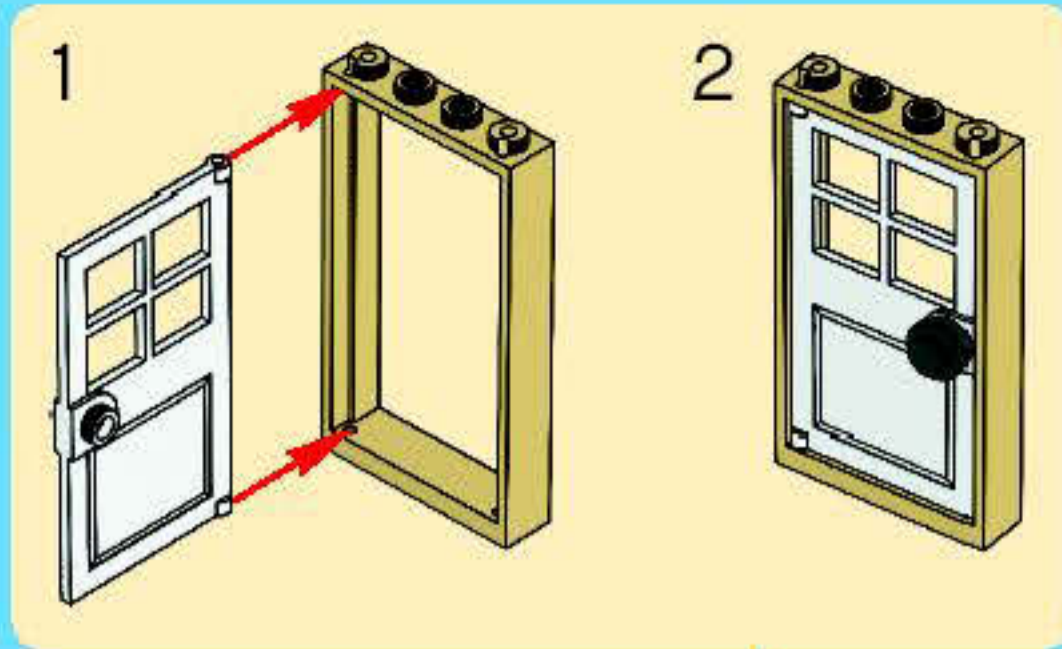
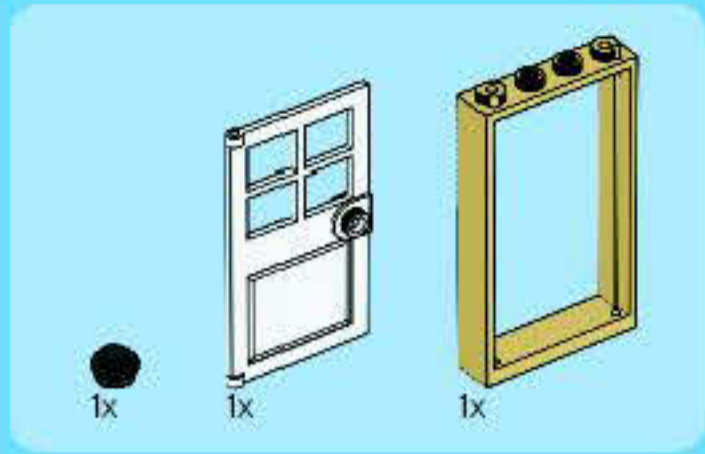



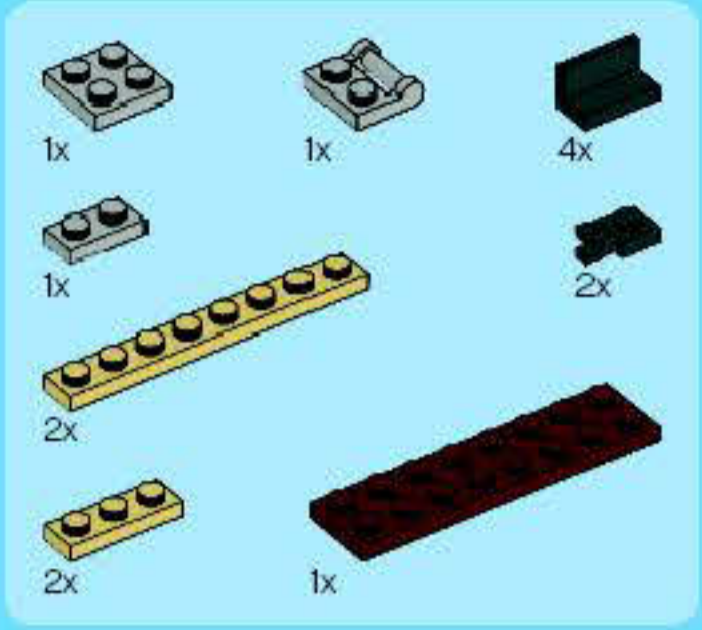

# 28

1

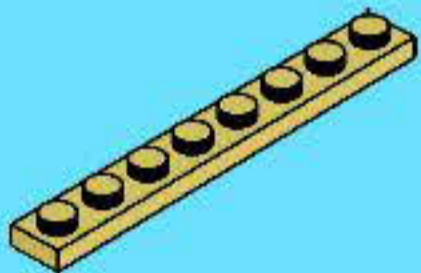

2

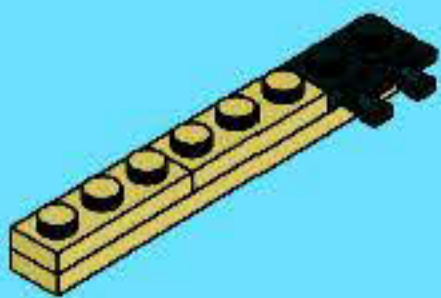

3

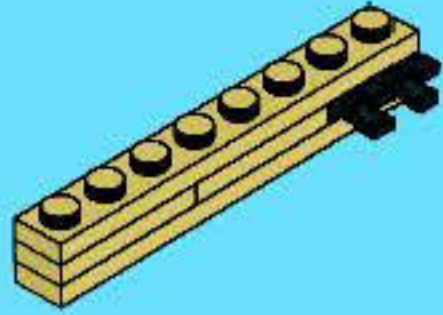

4

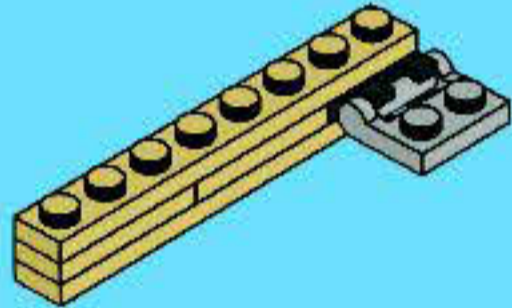

5

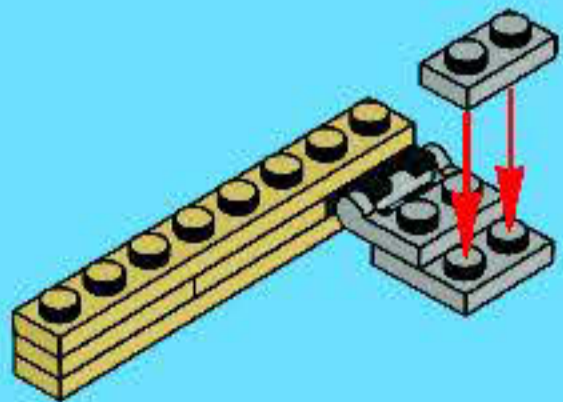



6

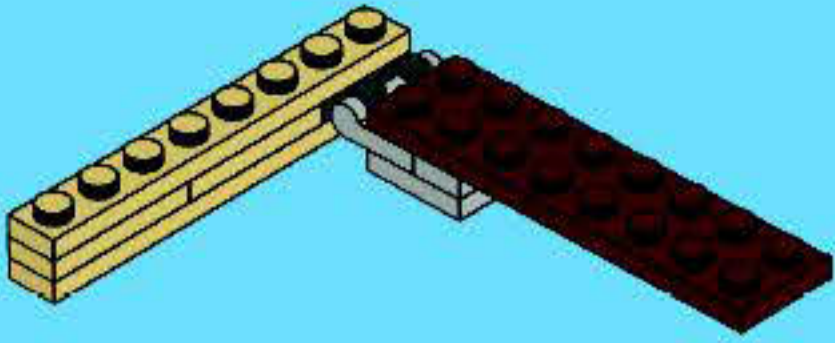

7

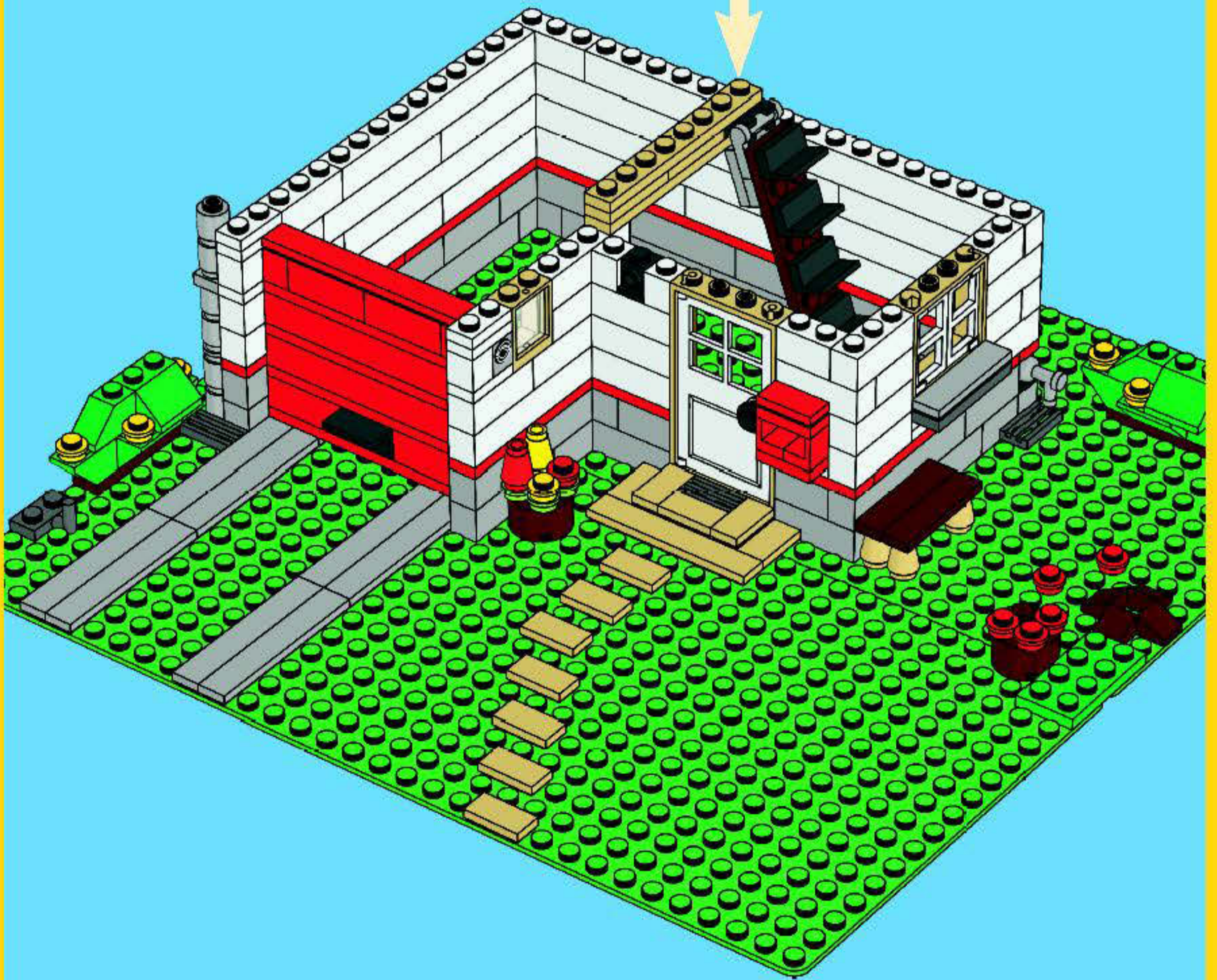
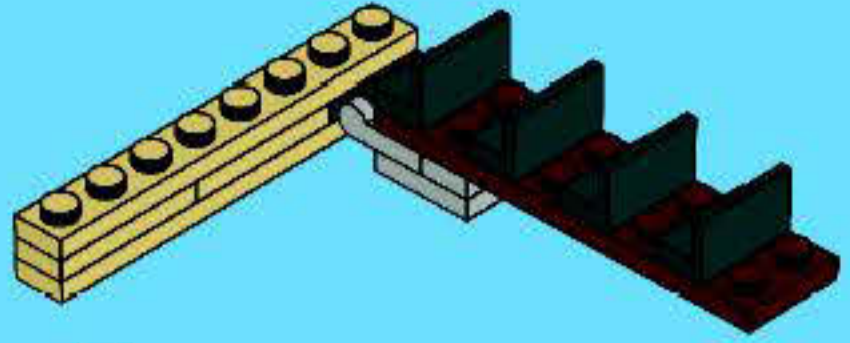



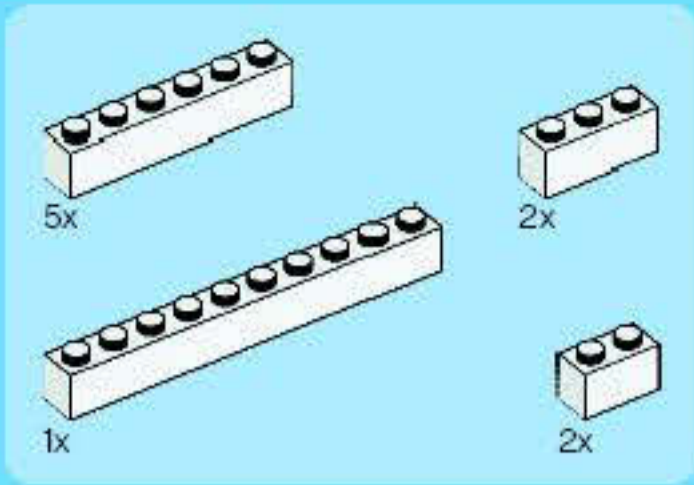

29

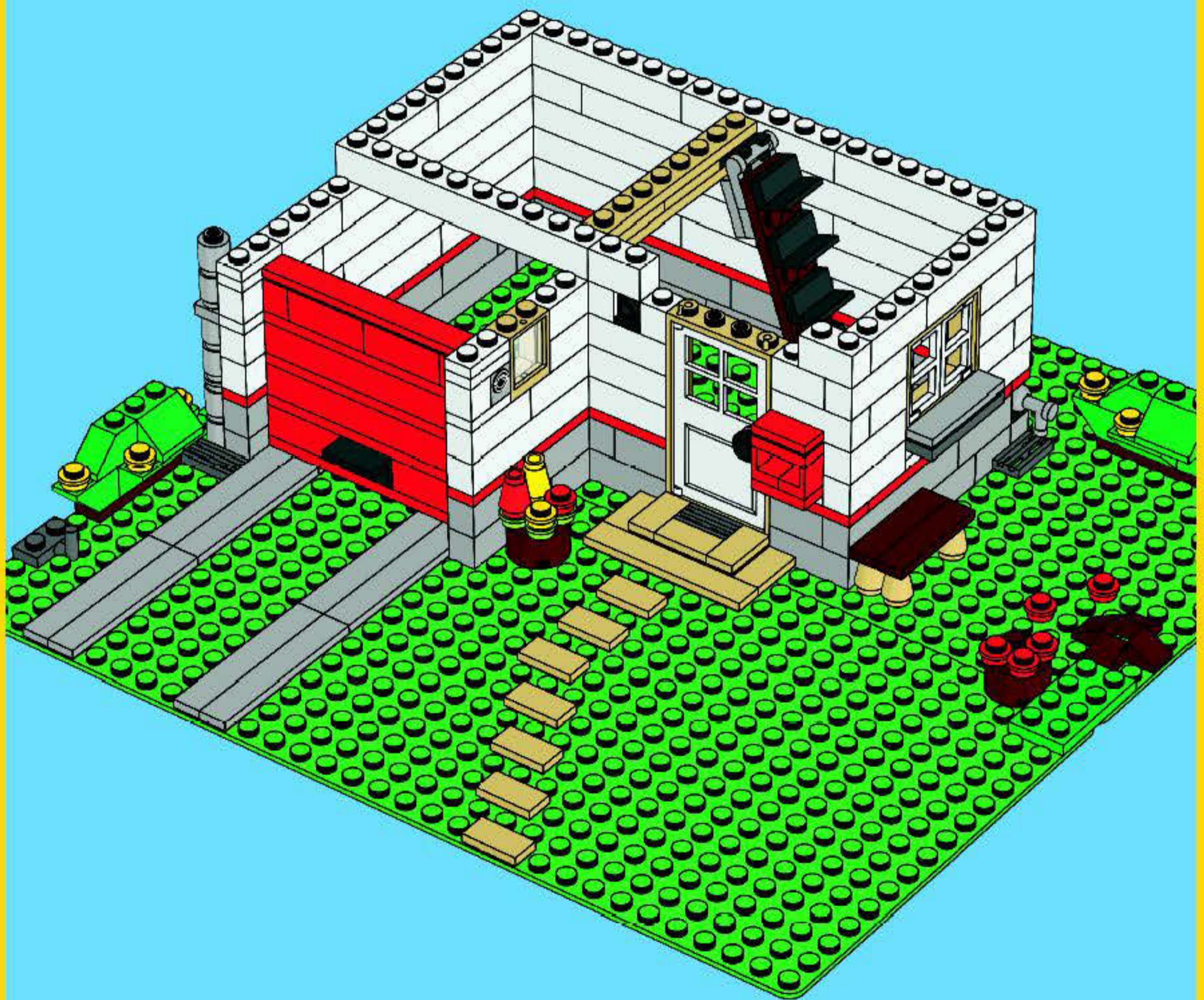





1x



1x



2x



1x

# 30

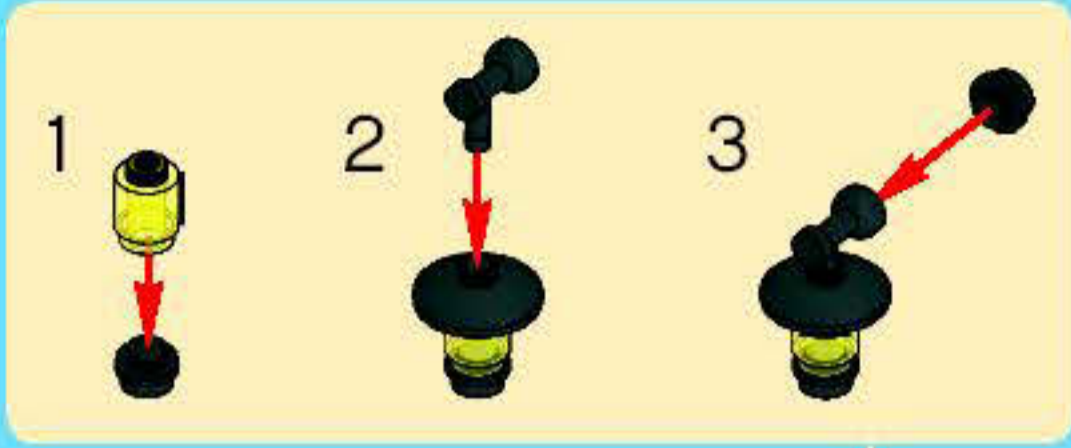



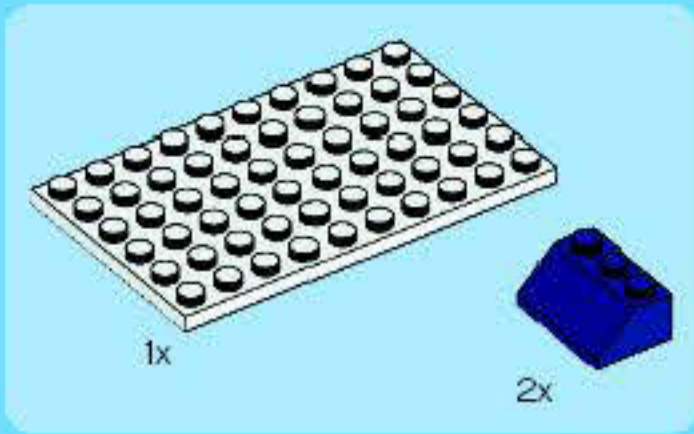

31

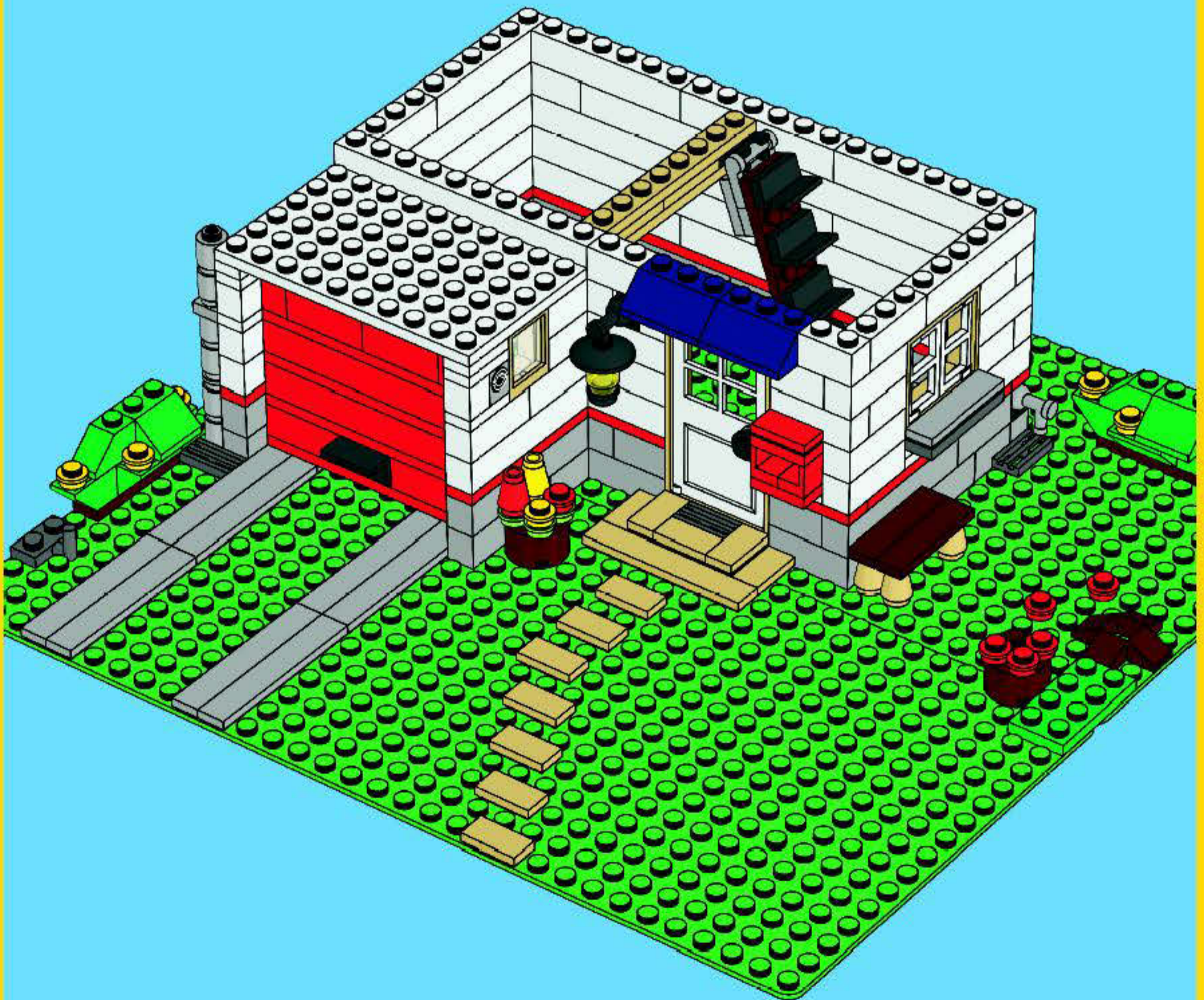



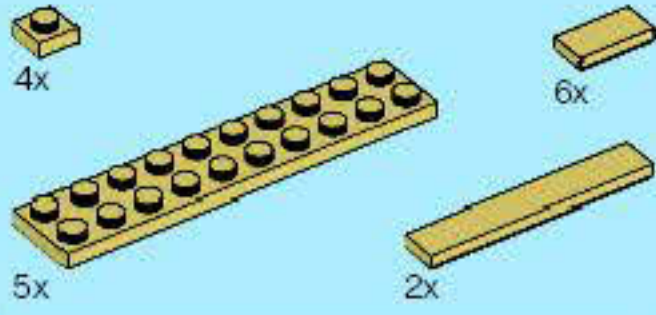

32

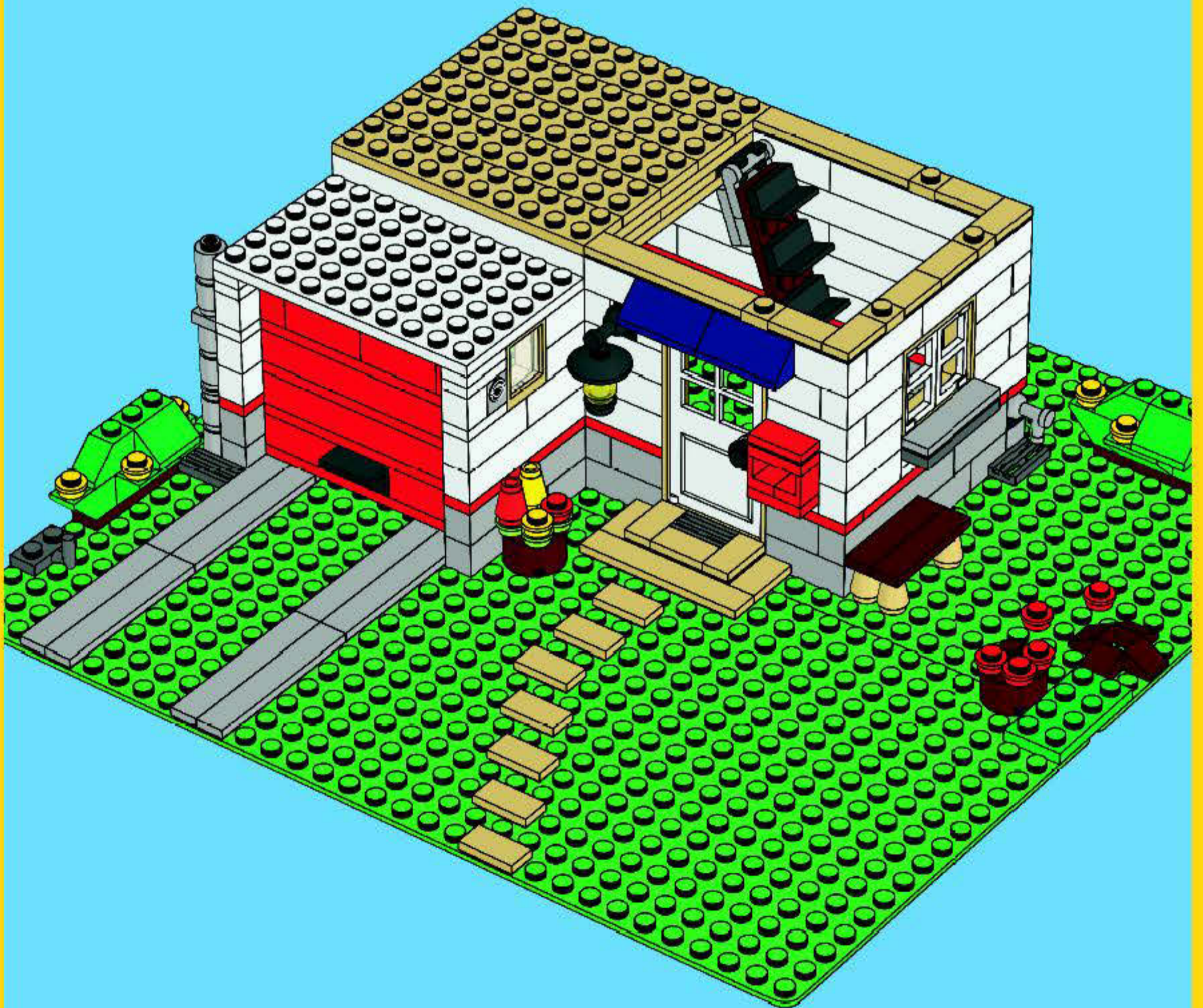



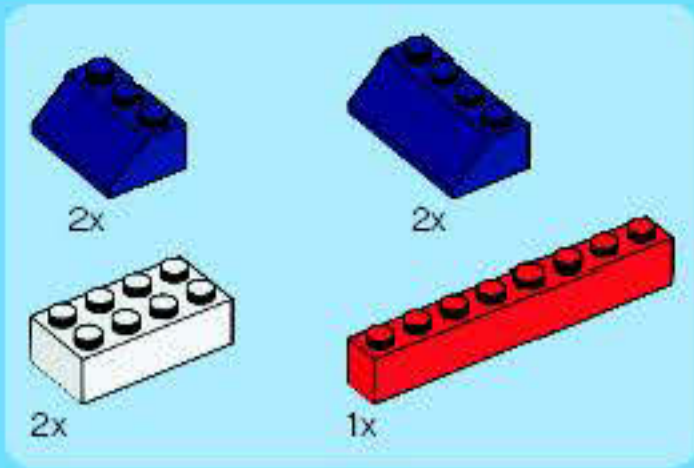

33

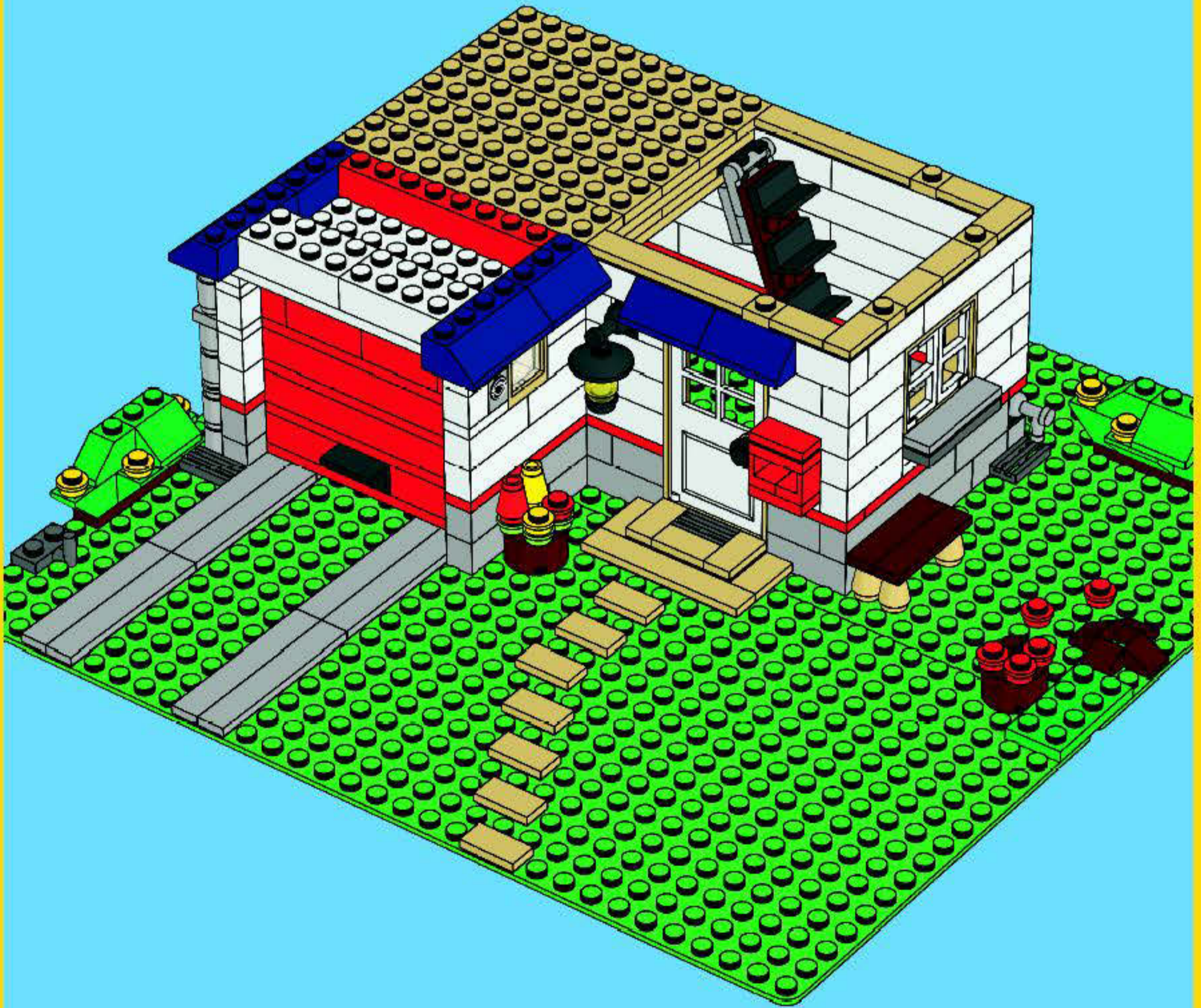



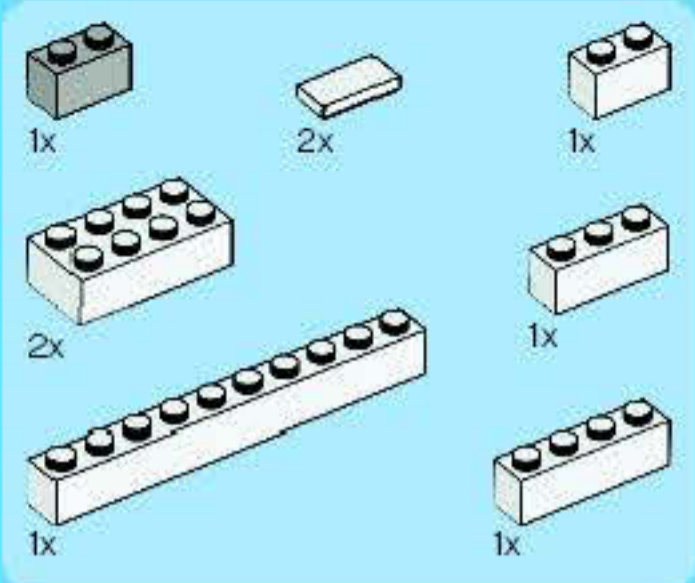

34

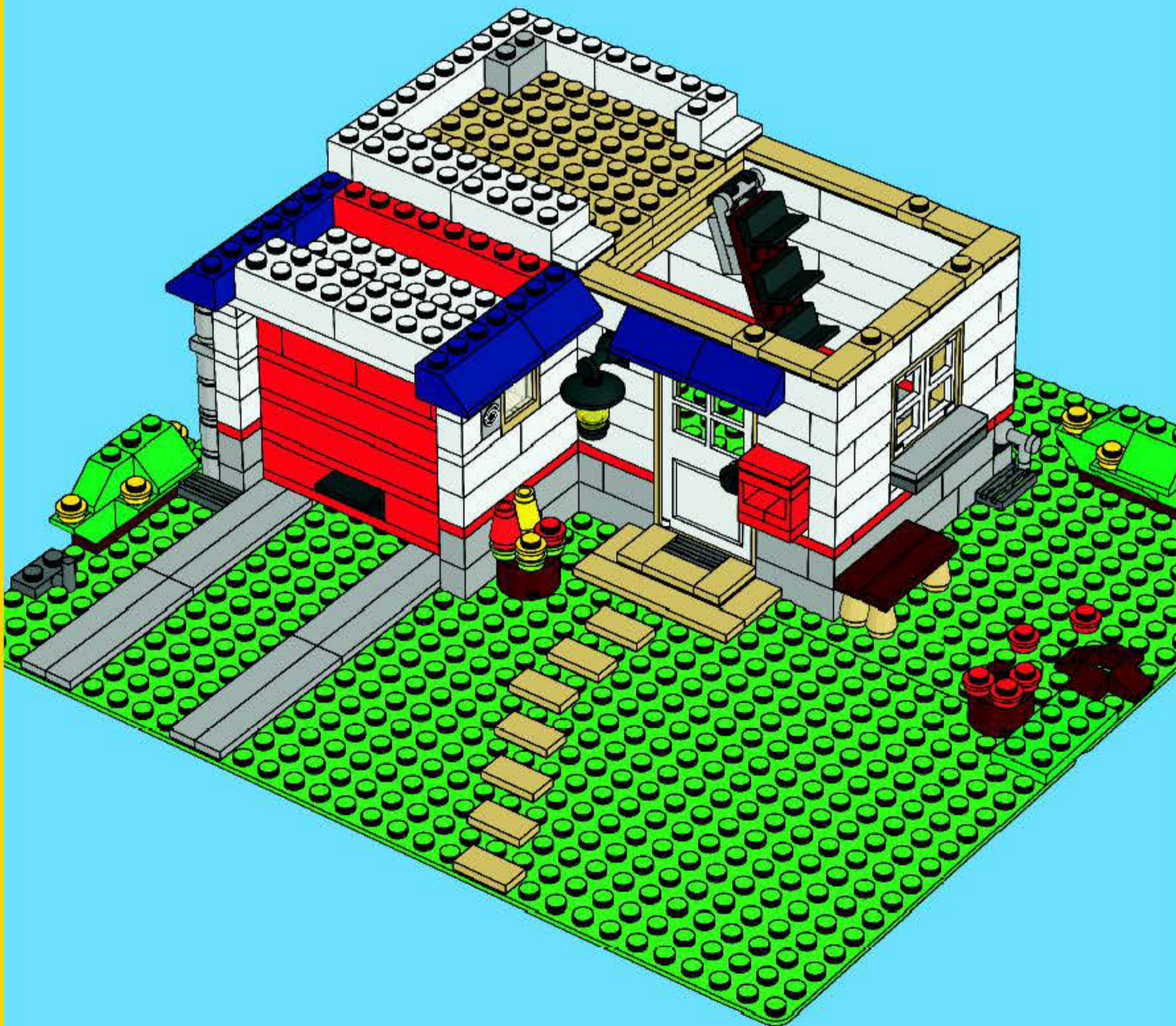



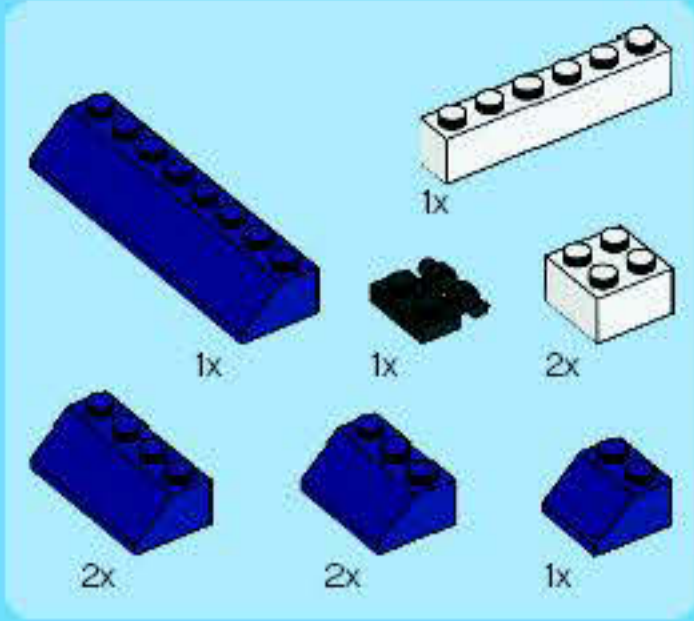

35

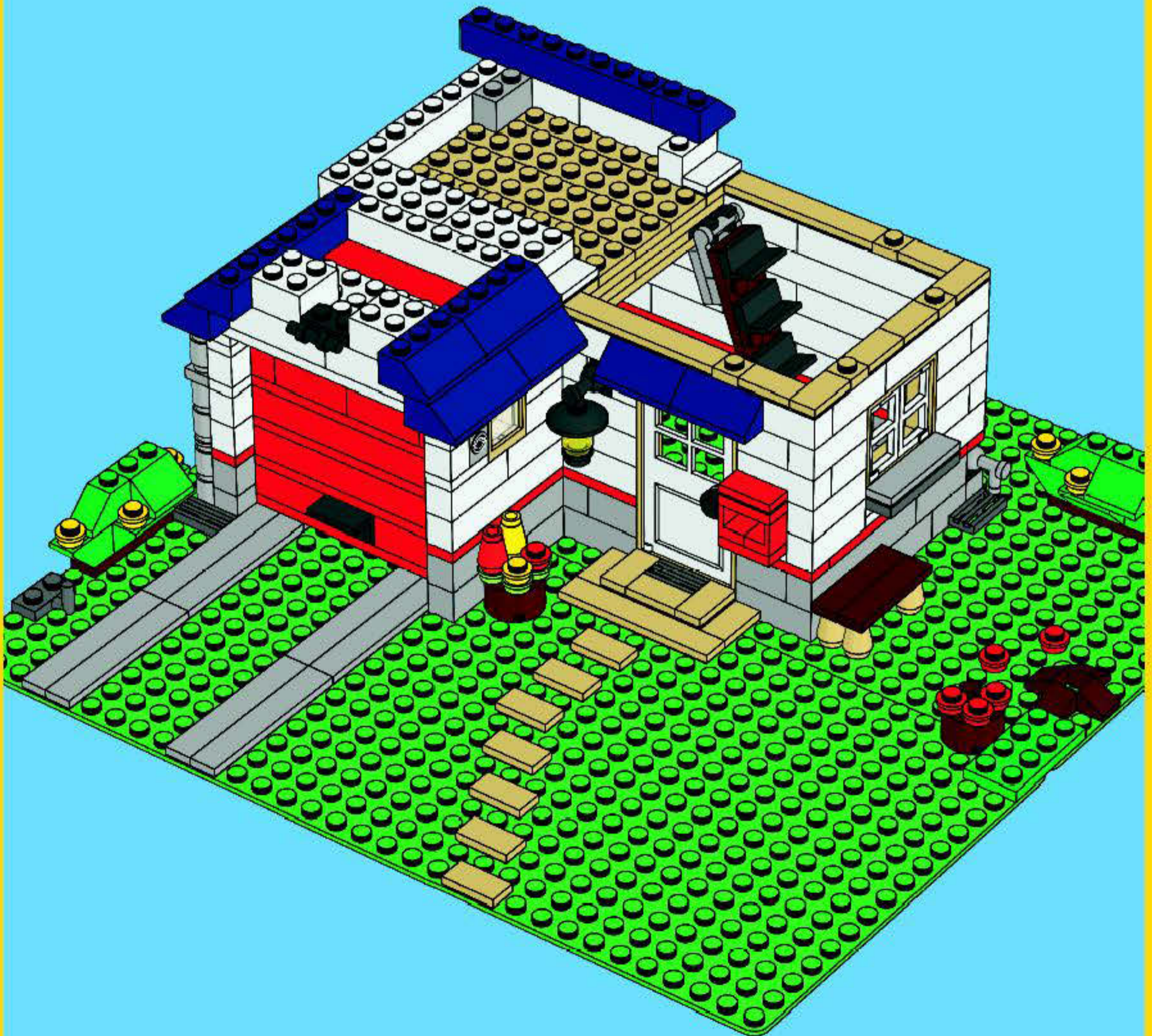



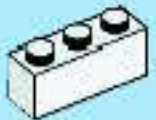

2x



2x



1x



1x

# 36

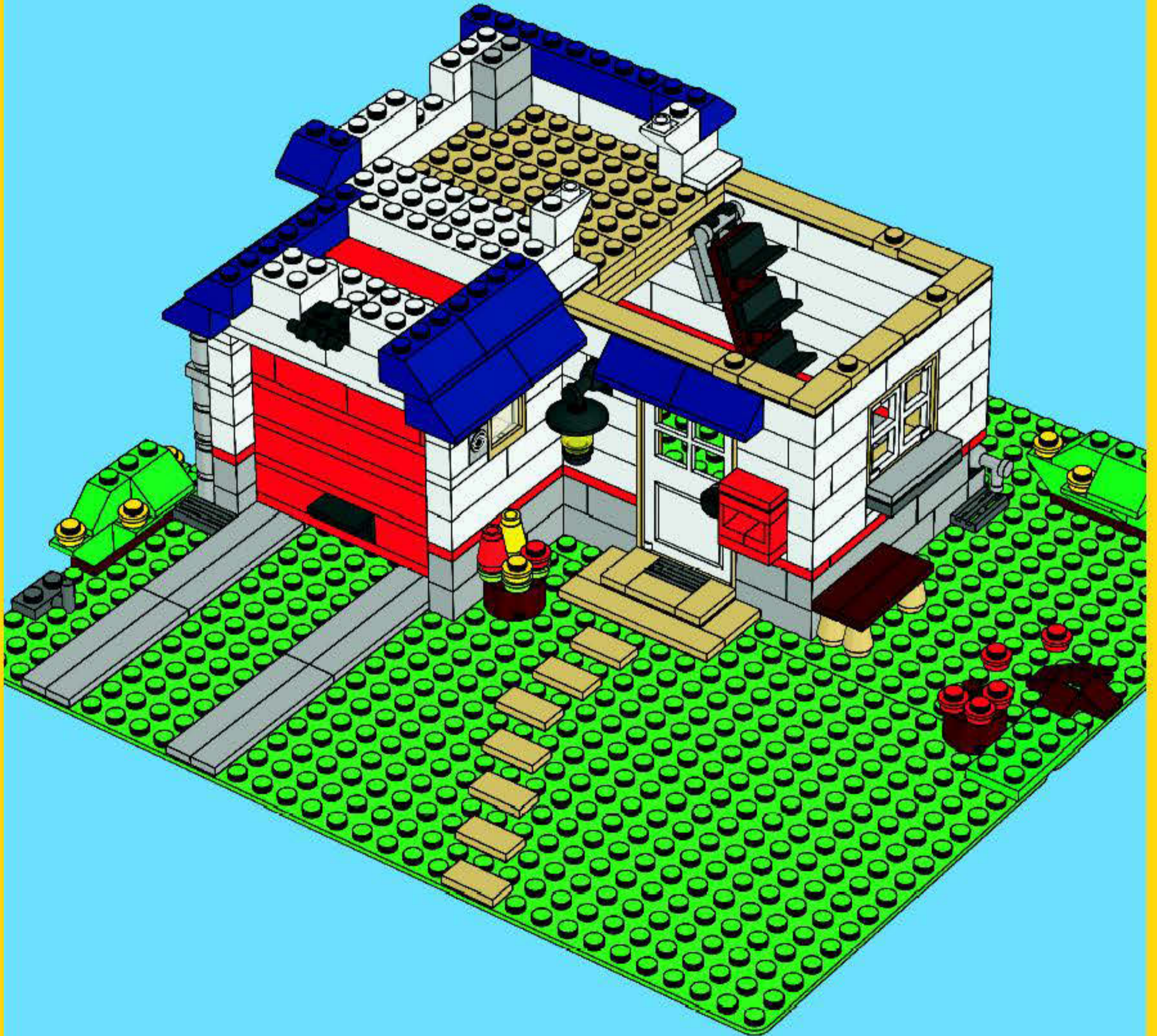





2x



2x



2x

# 37

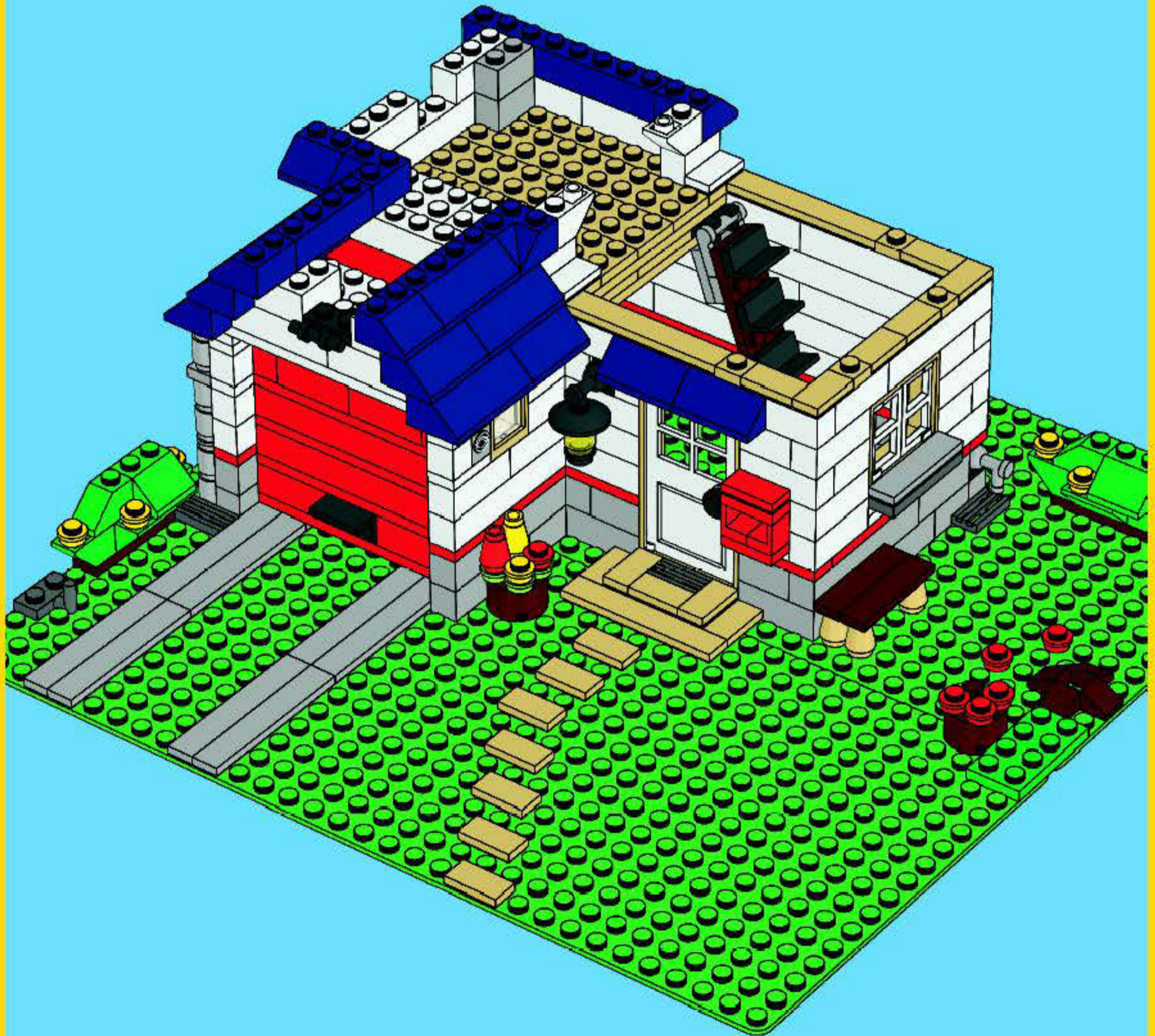



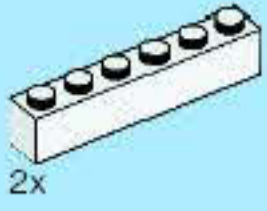

38

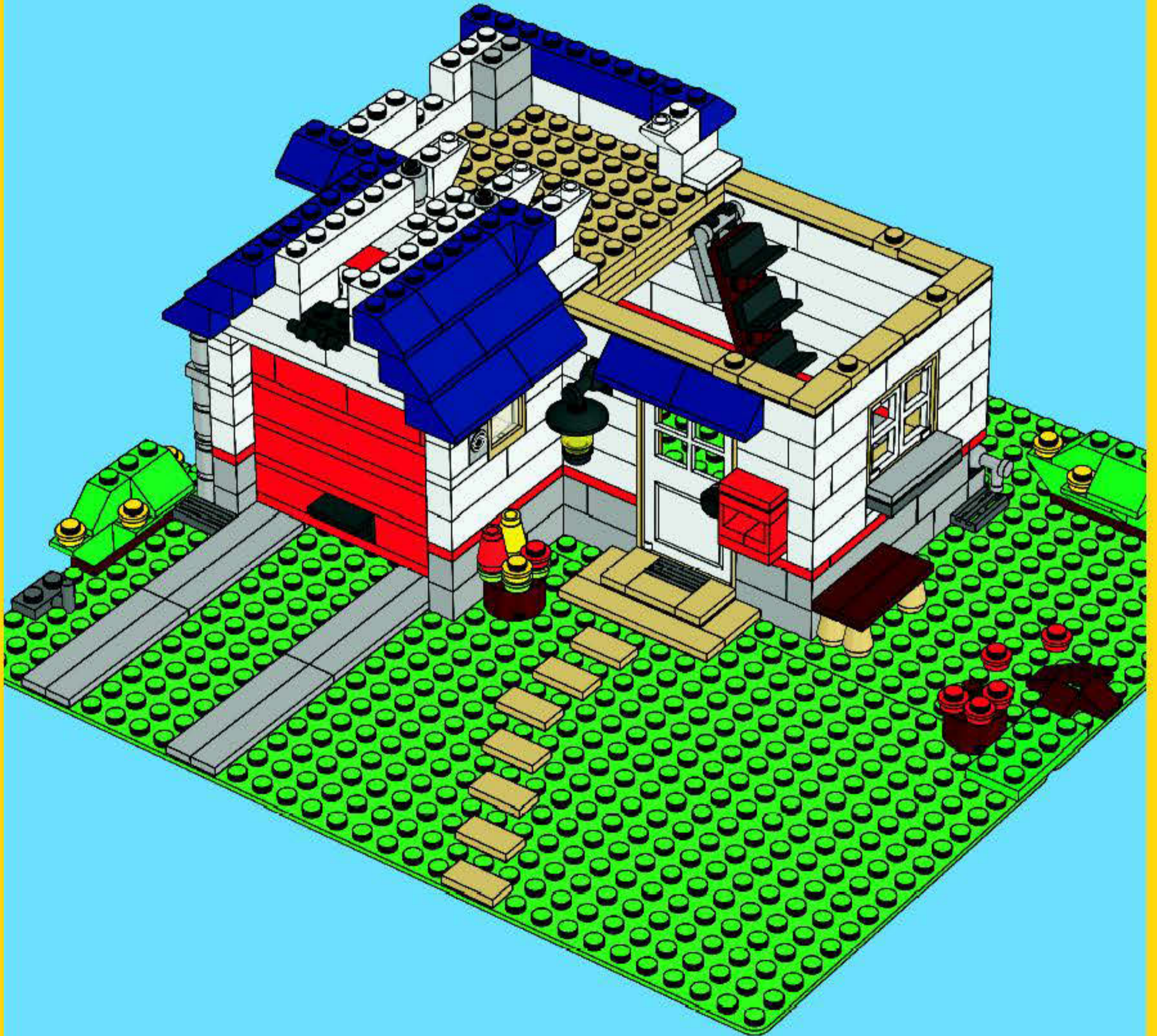



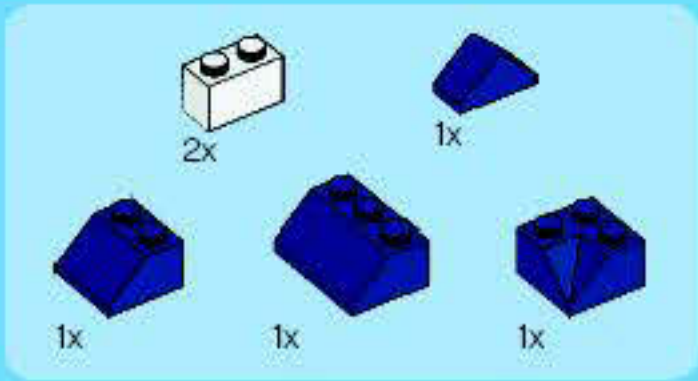

39

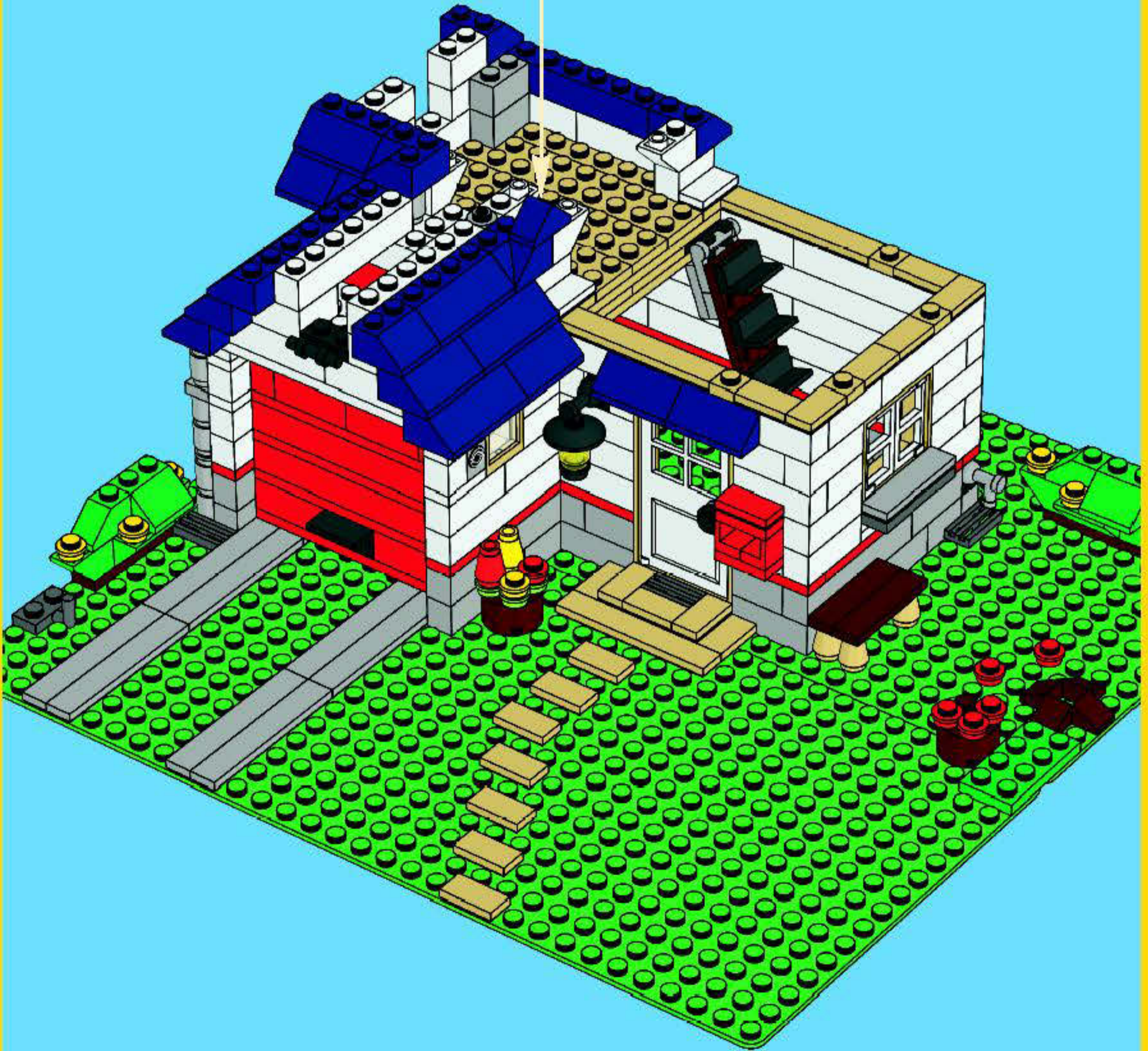



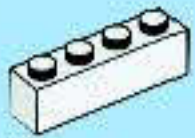

1x

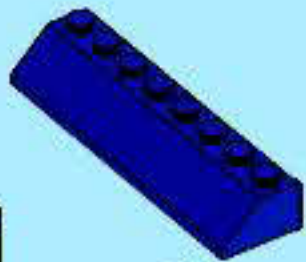

1x



1x



1x

# 40

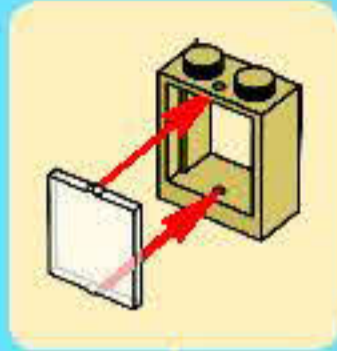





2x



1x



1x



2x



1x

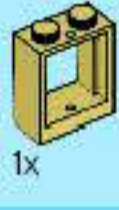

1x

# 41

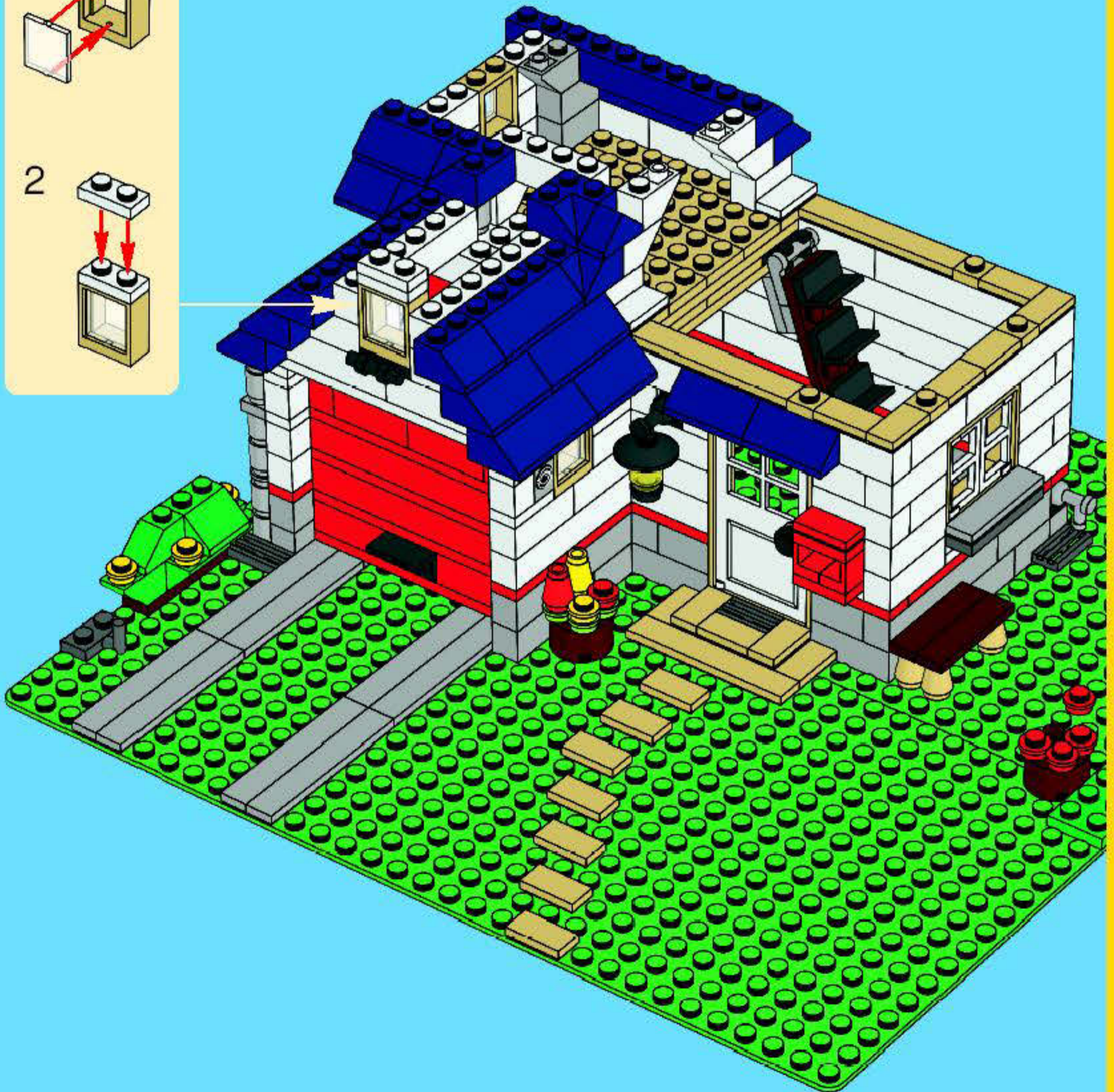
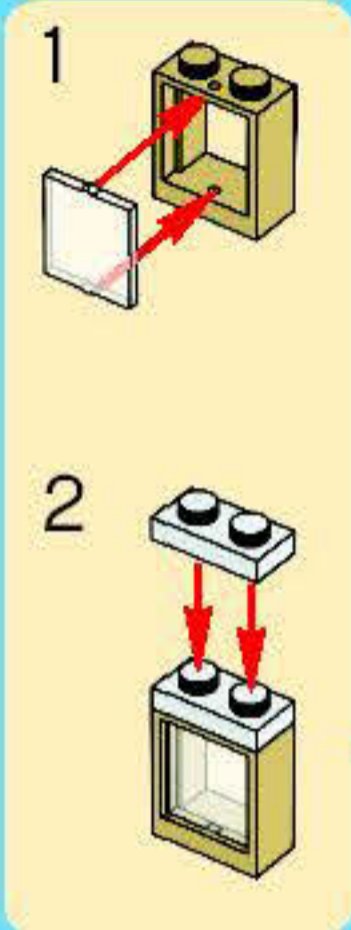



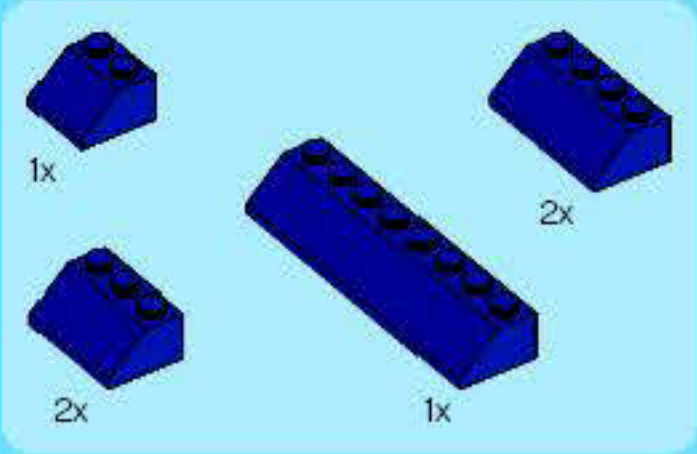

42





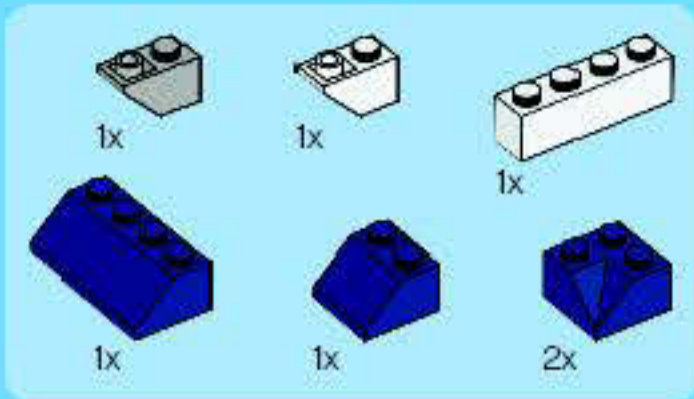

43





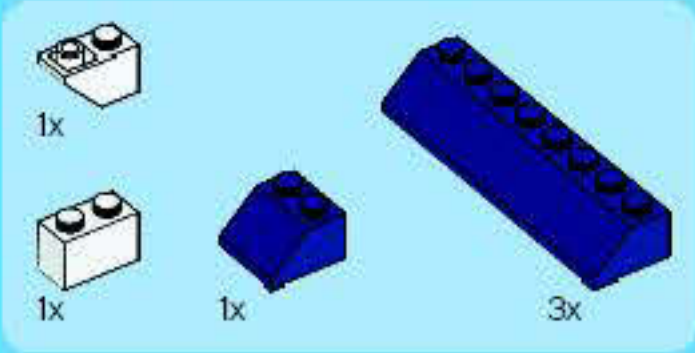

44





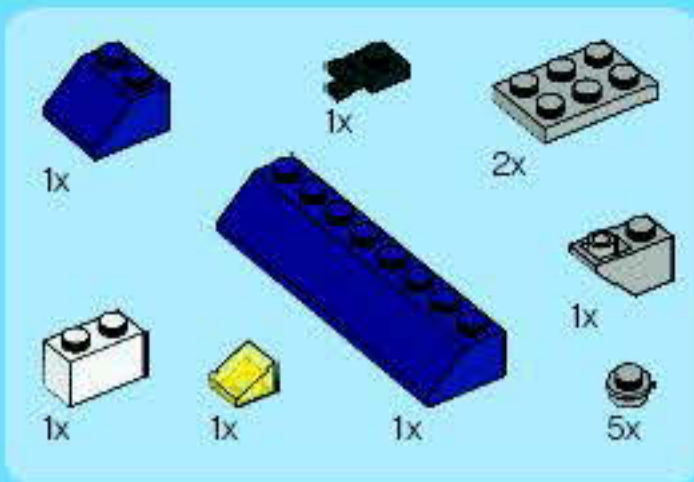

45

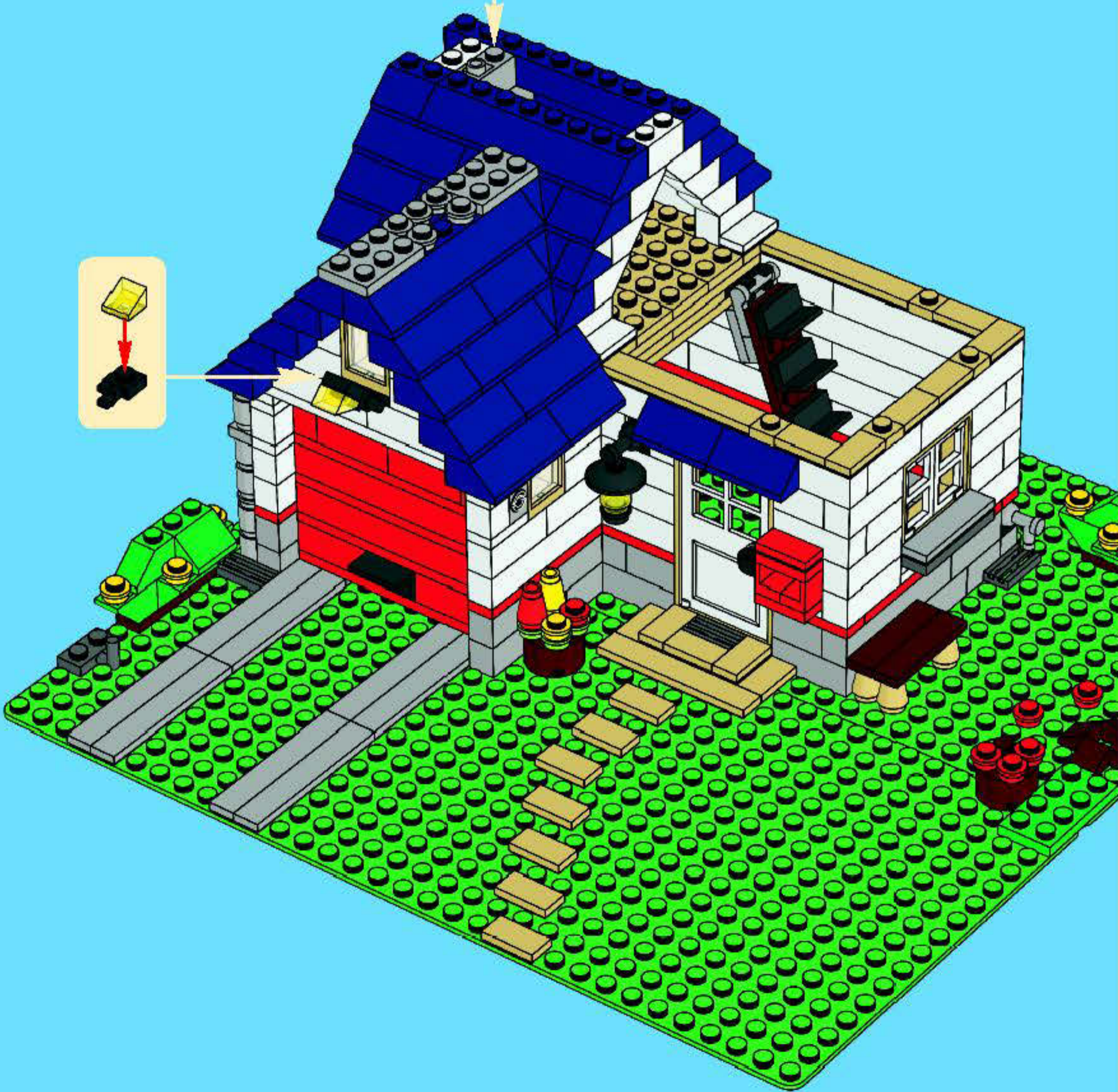



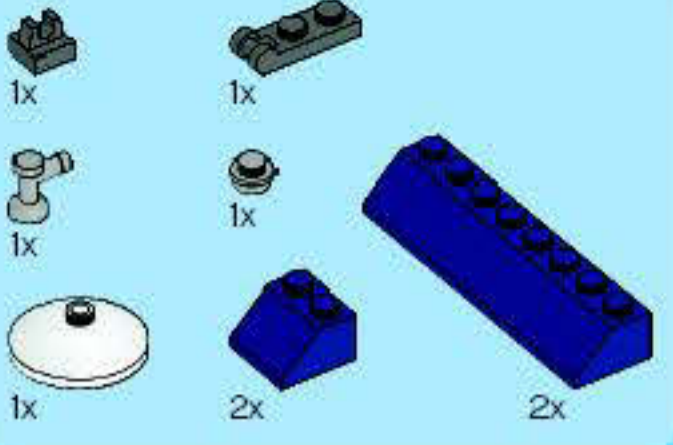

46





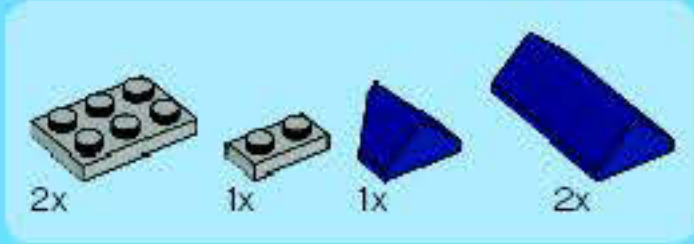

47







3x



1x

# 48







1x



1x



2x



1x



1x

# 49

1

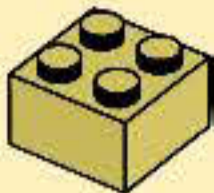

2

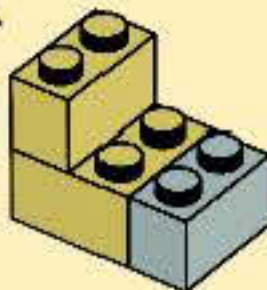

3

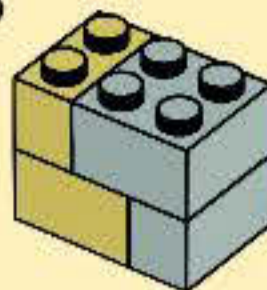

4

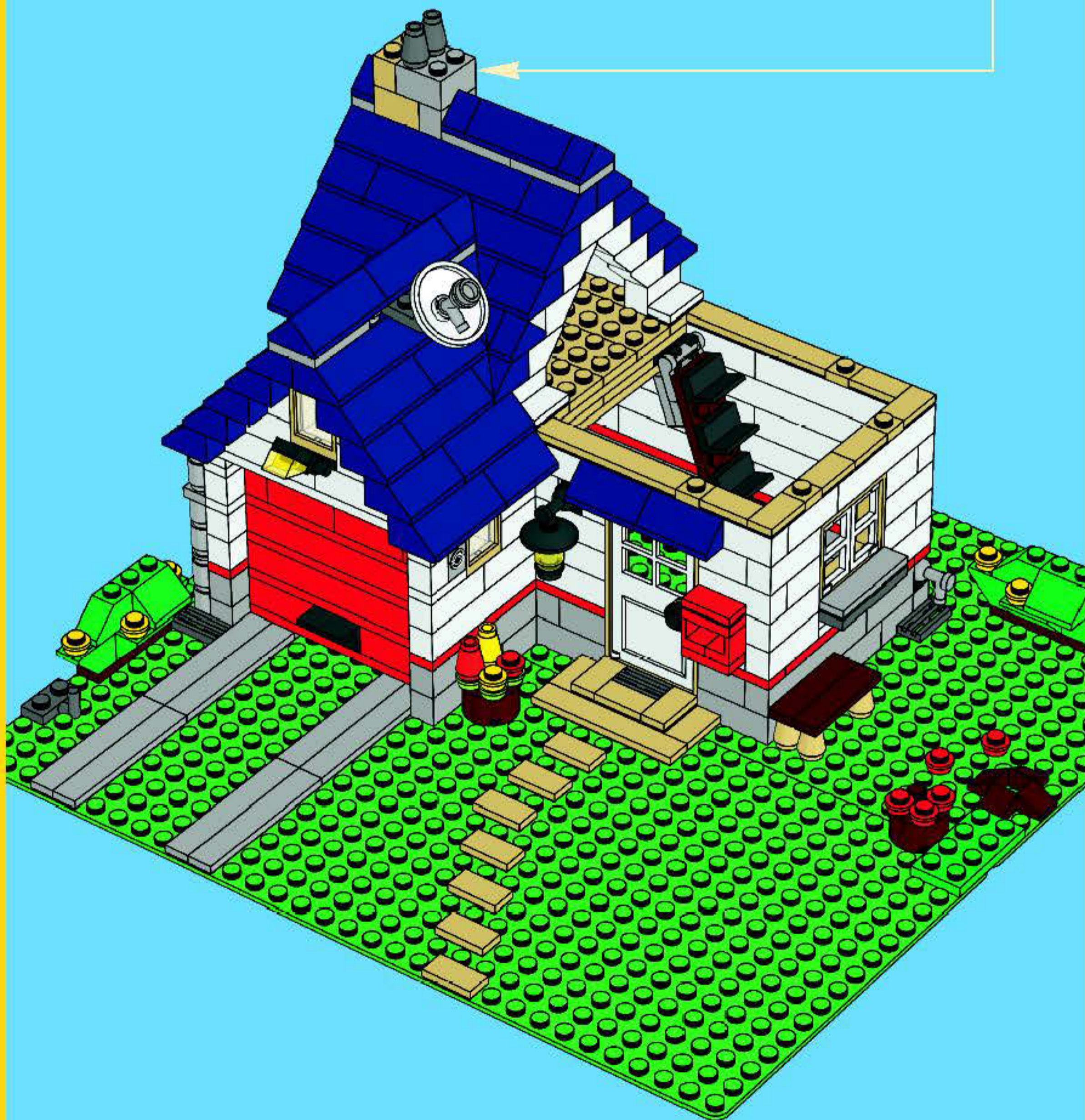
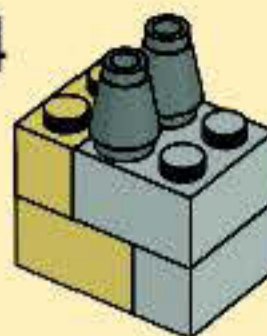



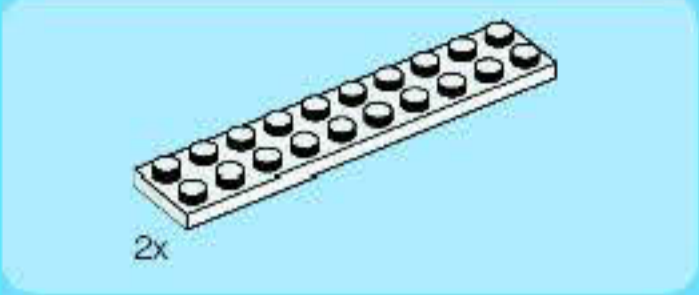
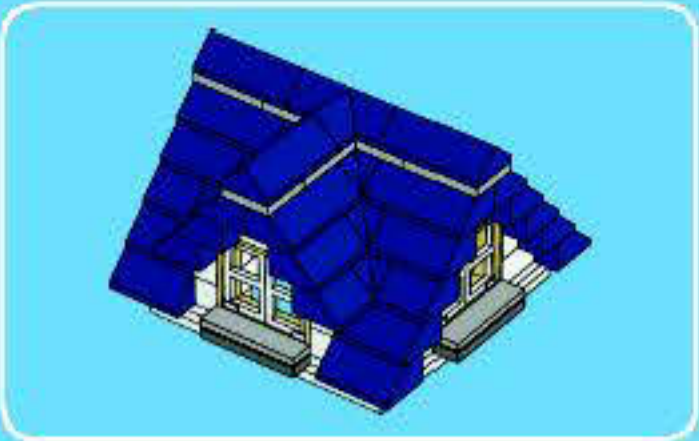

2x

1

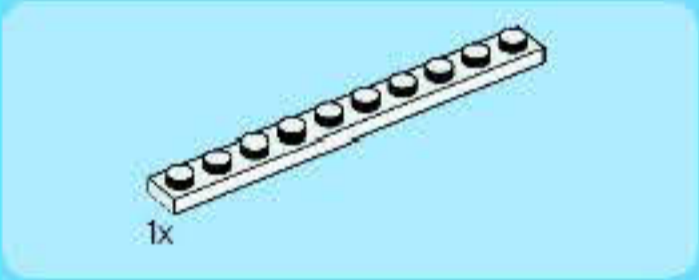
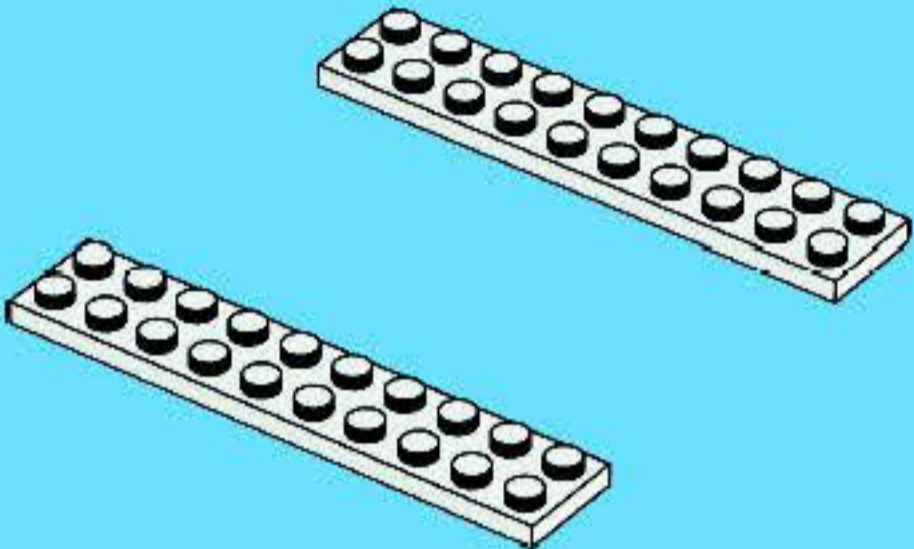

1x

2

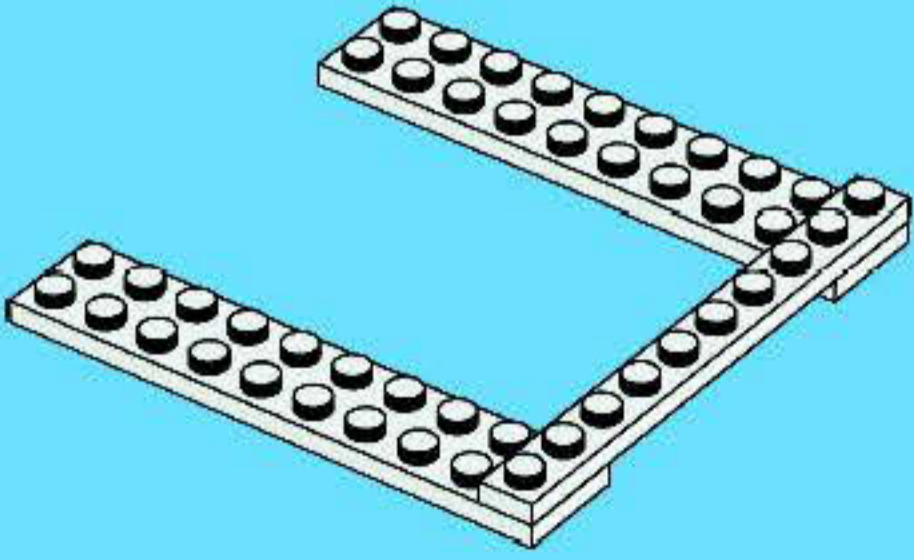



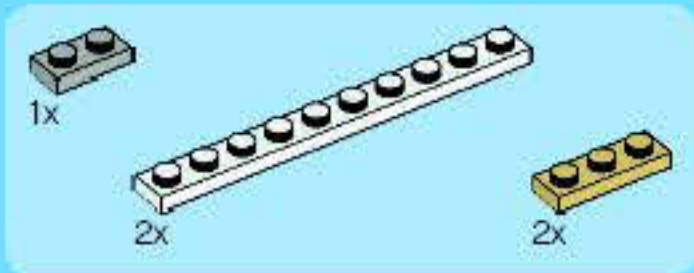

3

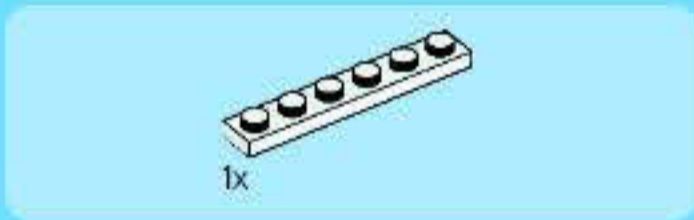
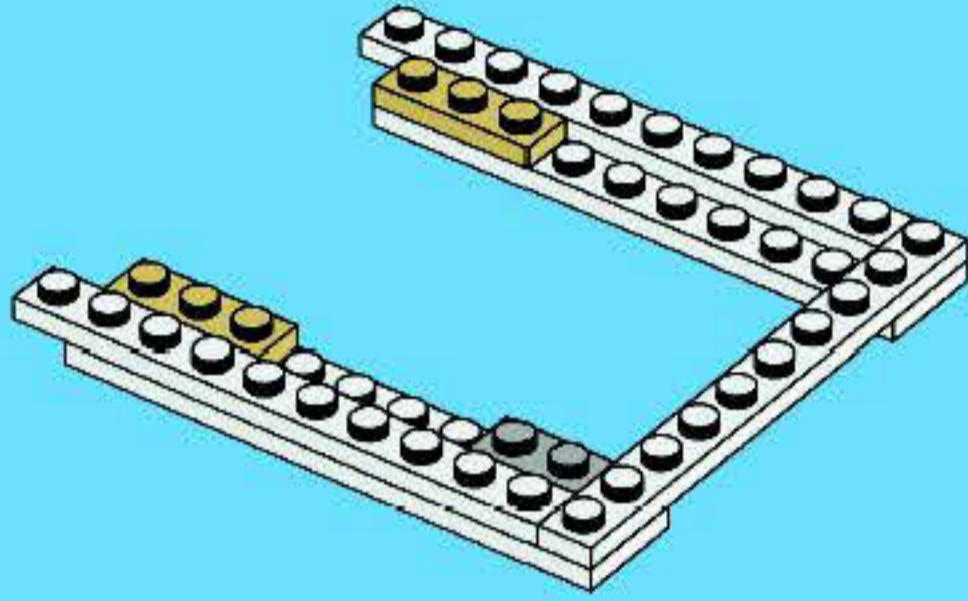

4

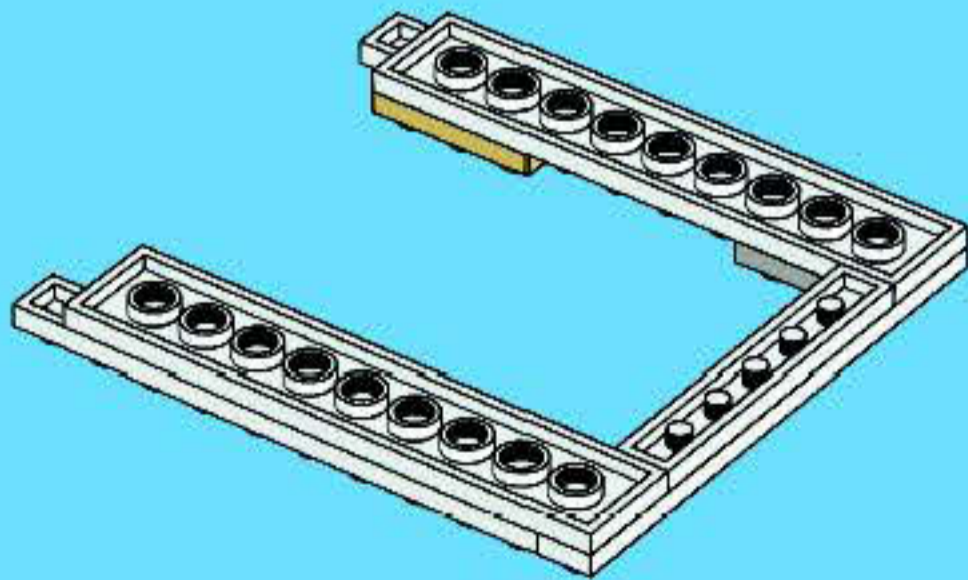



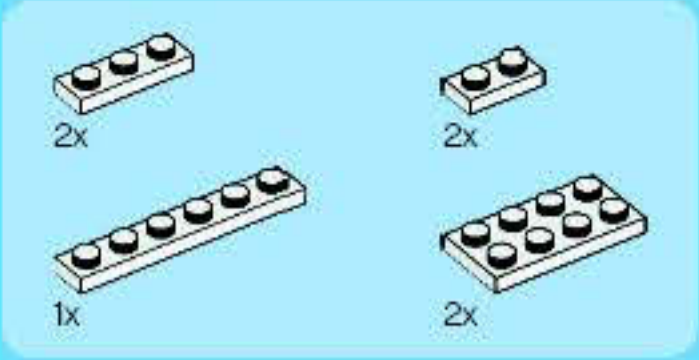

5

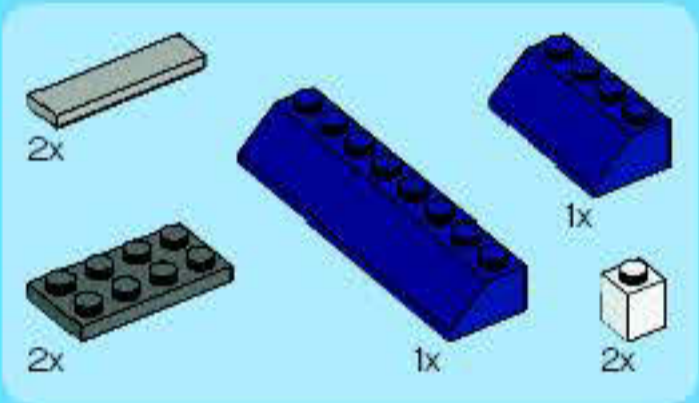
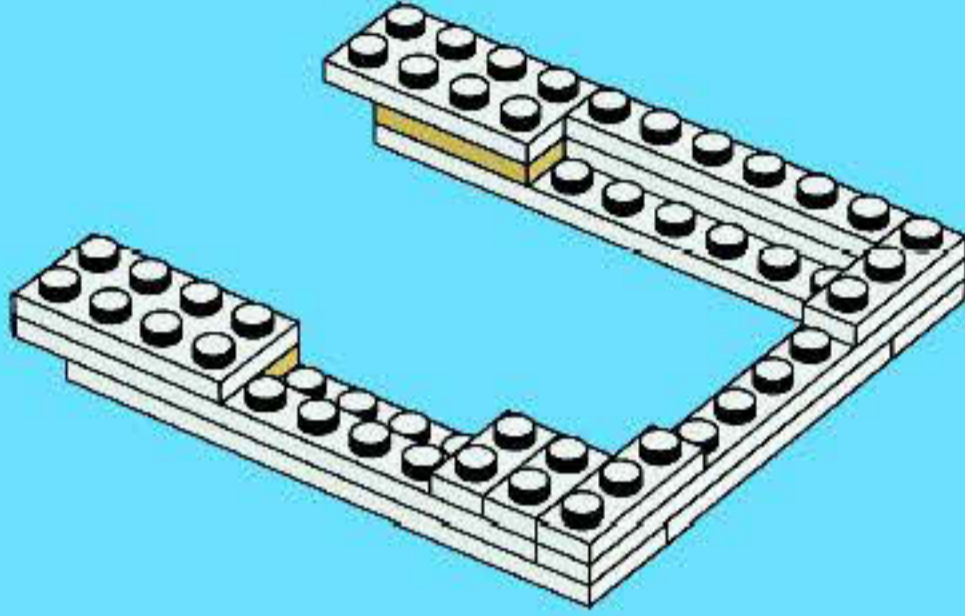

6

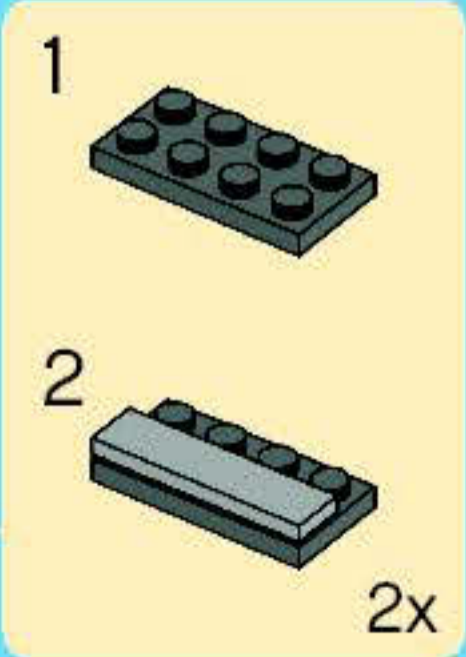
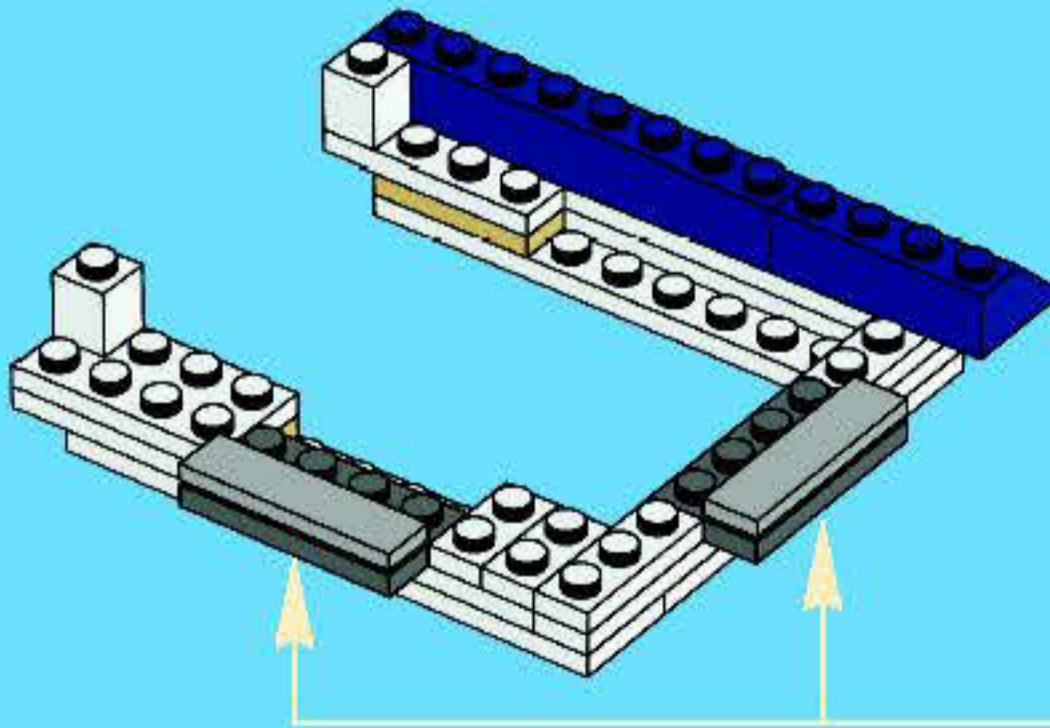





2x



2x



4x

7

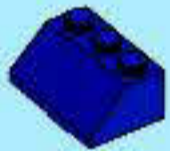
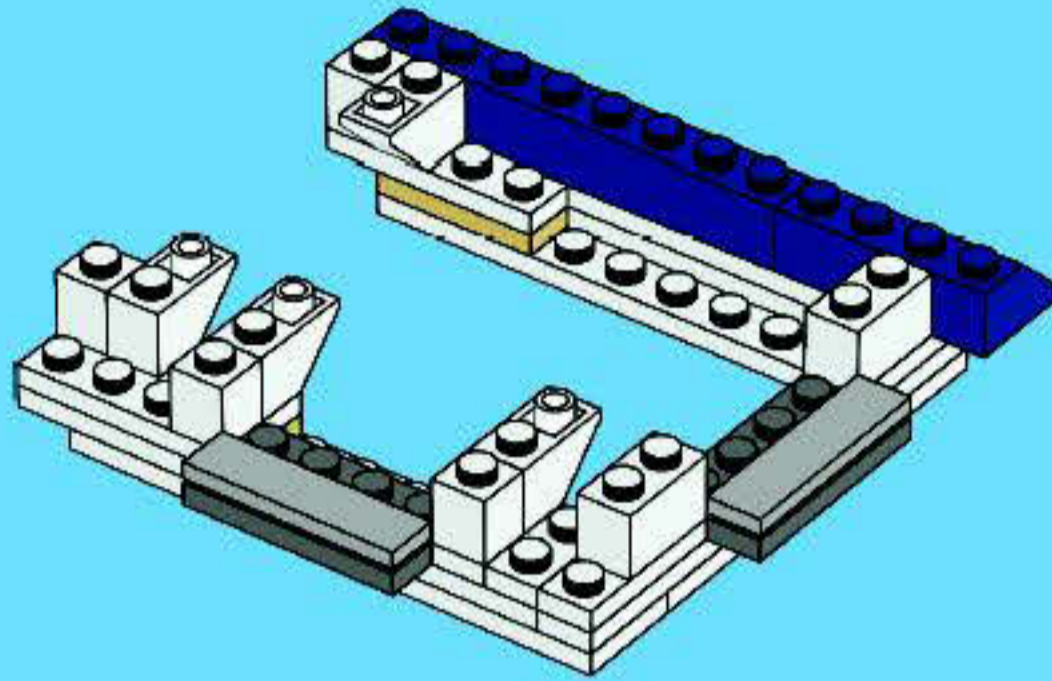

2x



2x

8

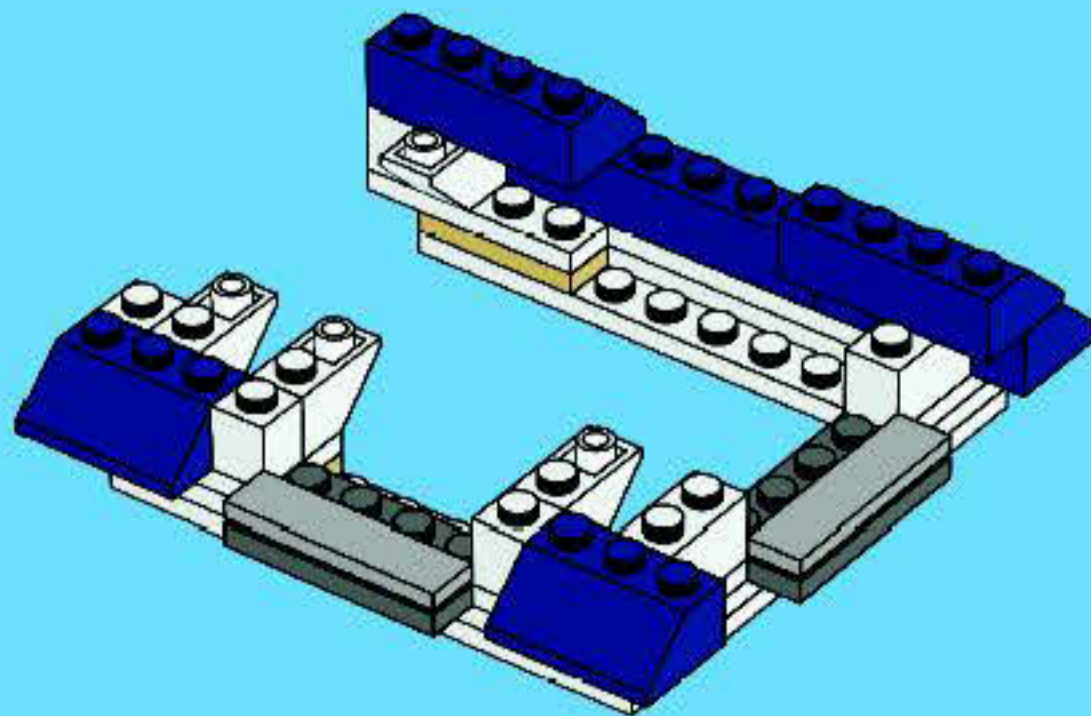



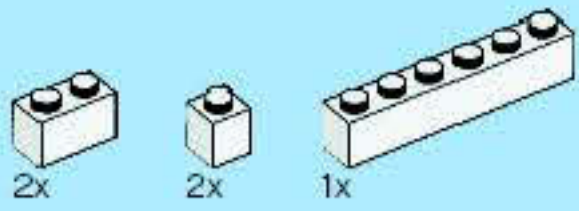

9

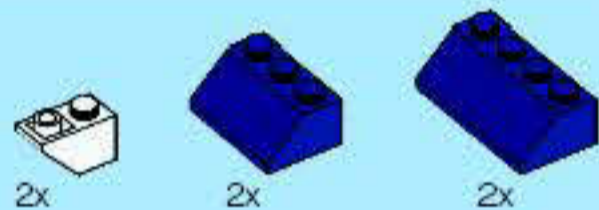
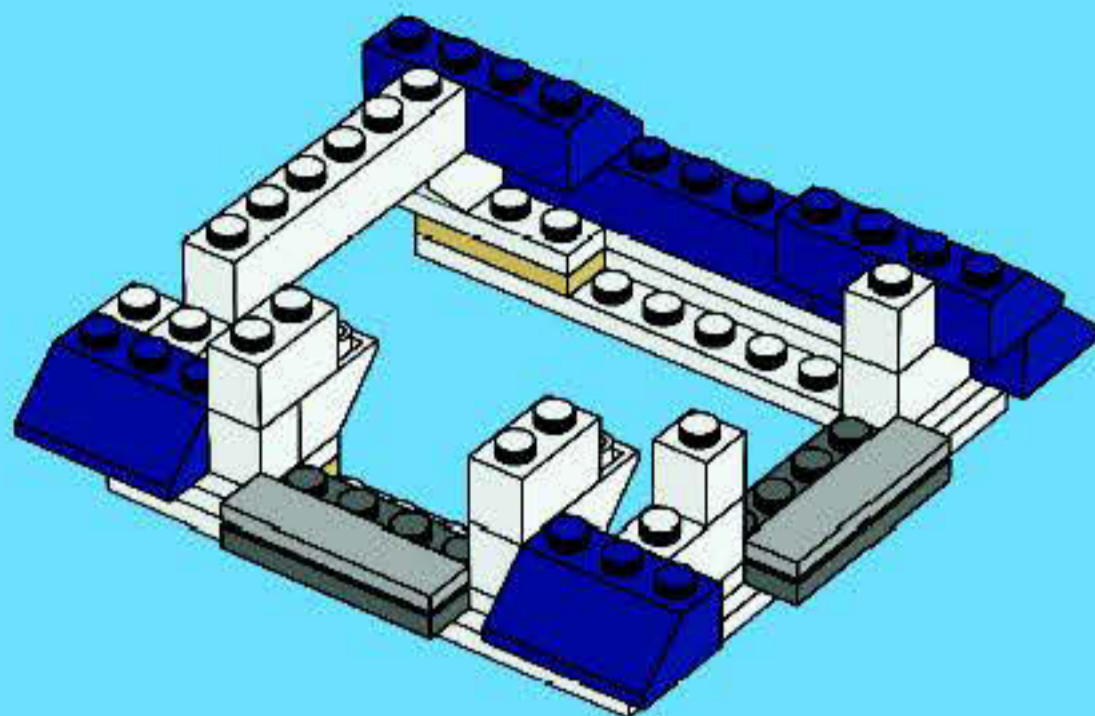

10

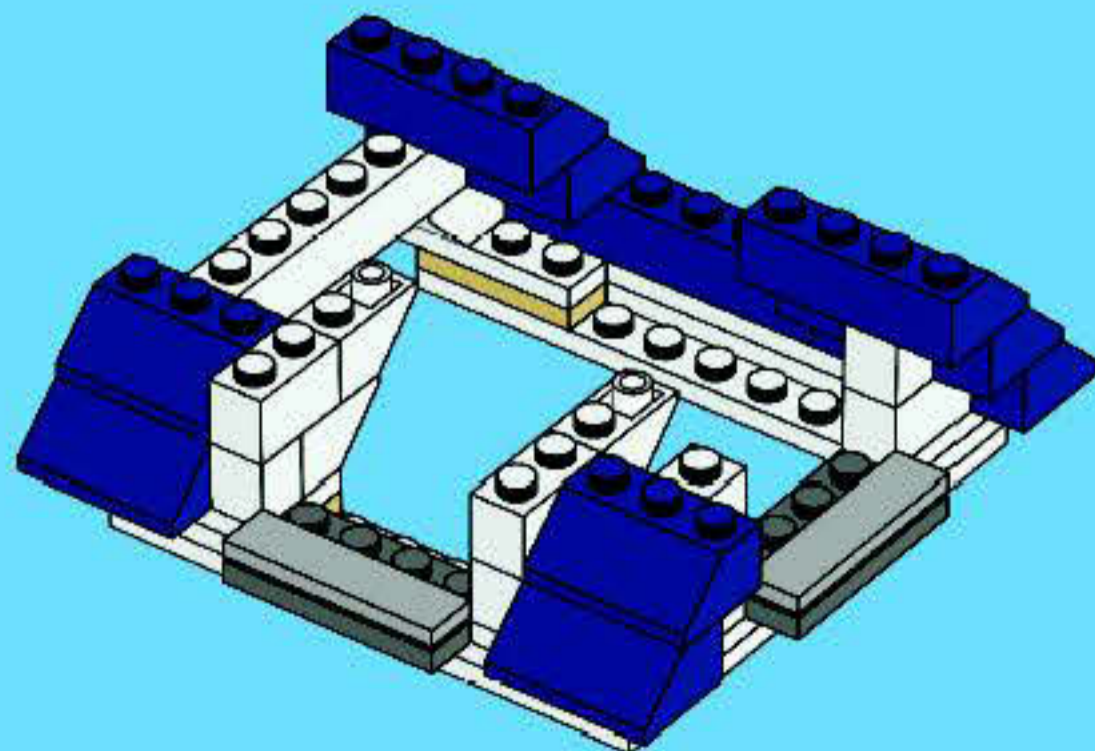



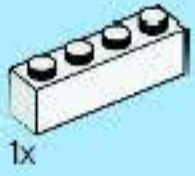

1x



2x



2x

# 11

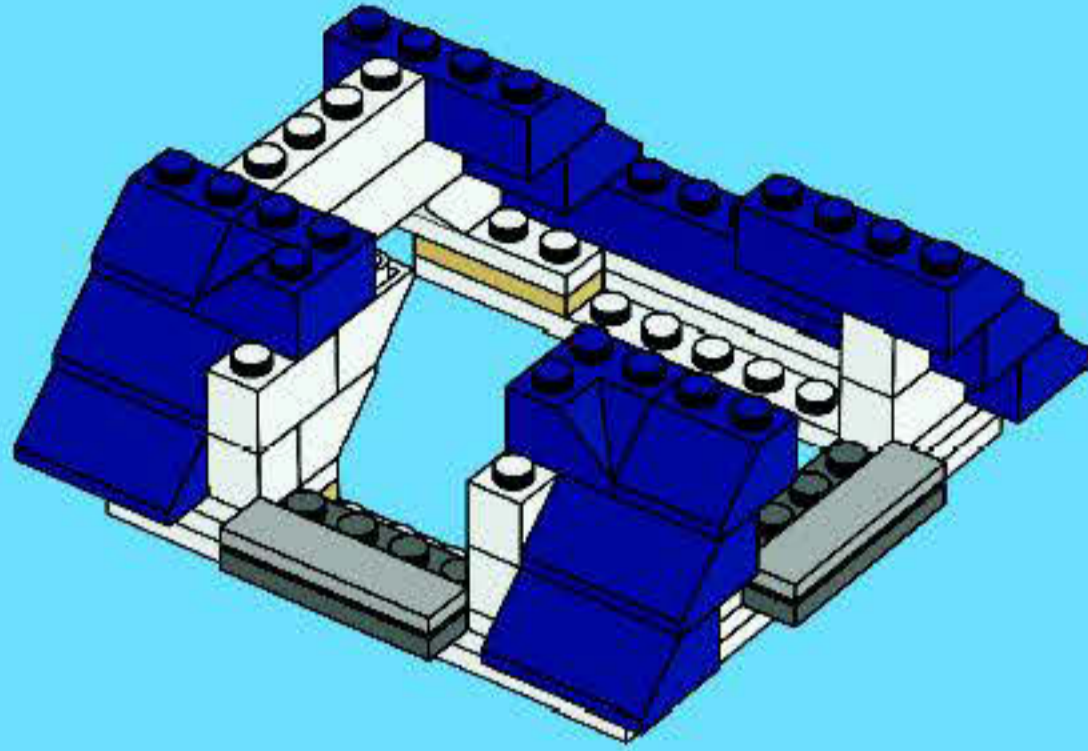

4x

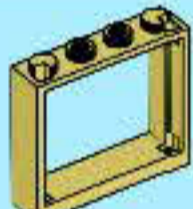

2x

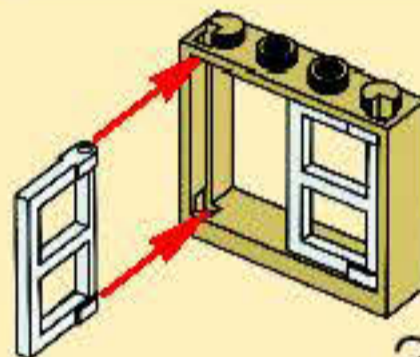

2x

# 12

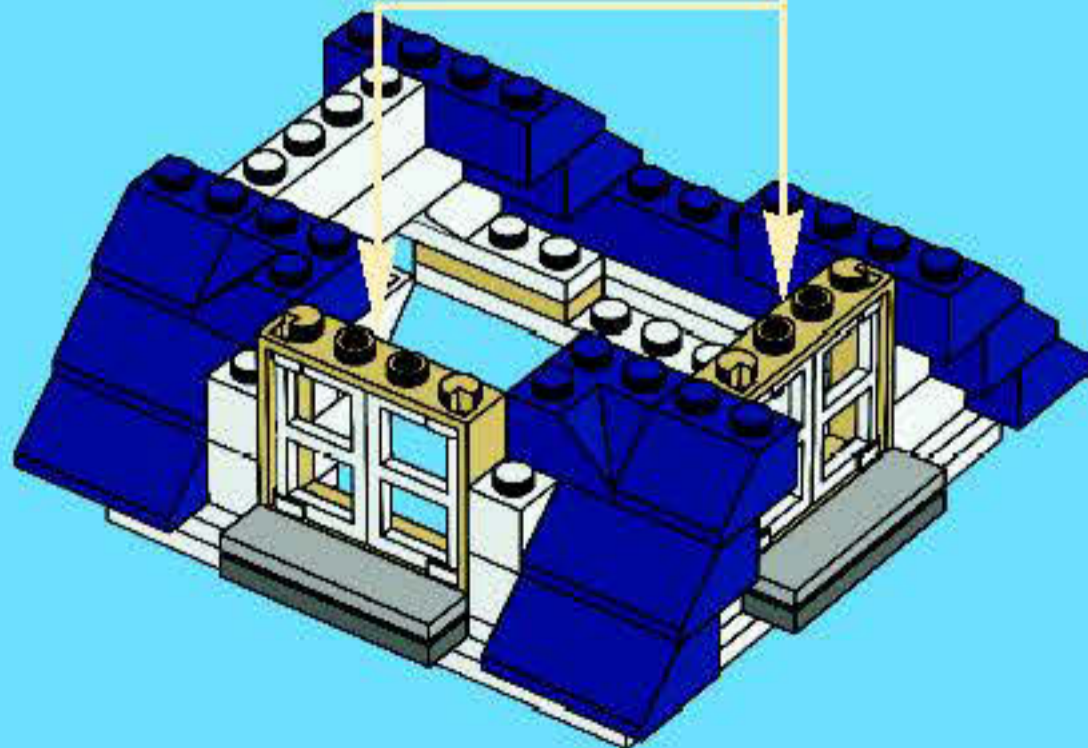



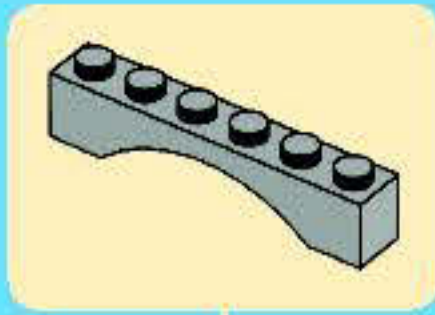
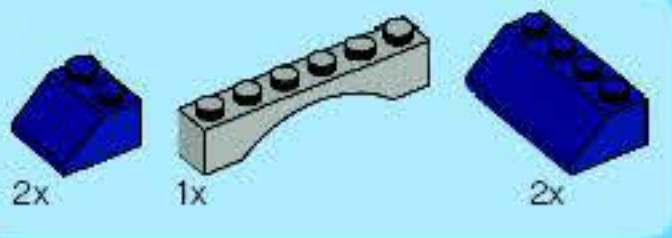

13

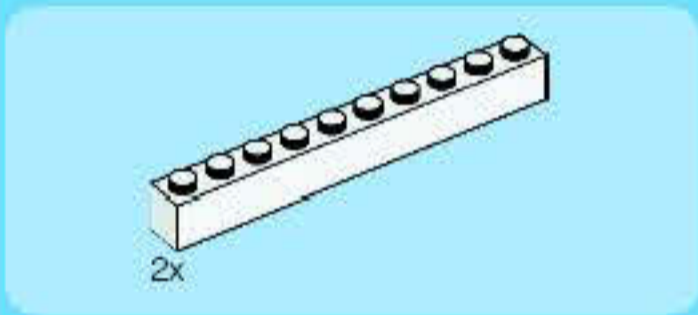
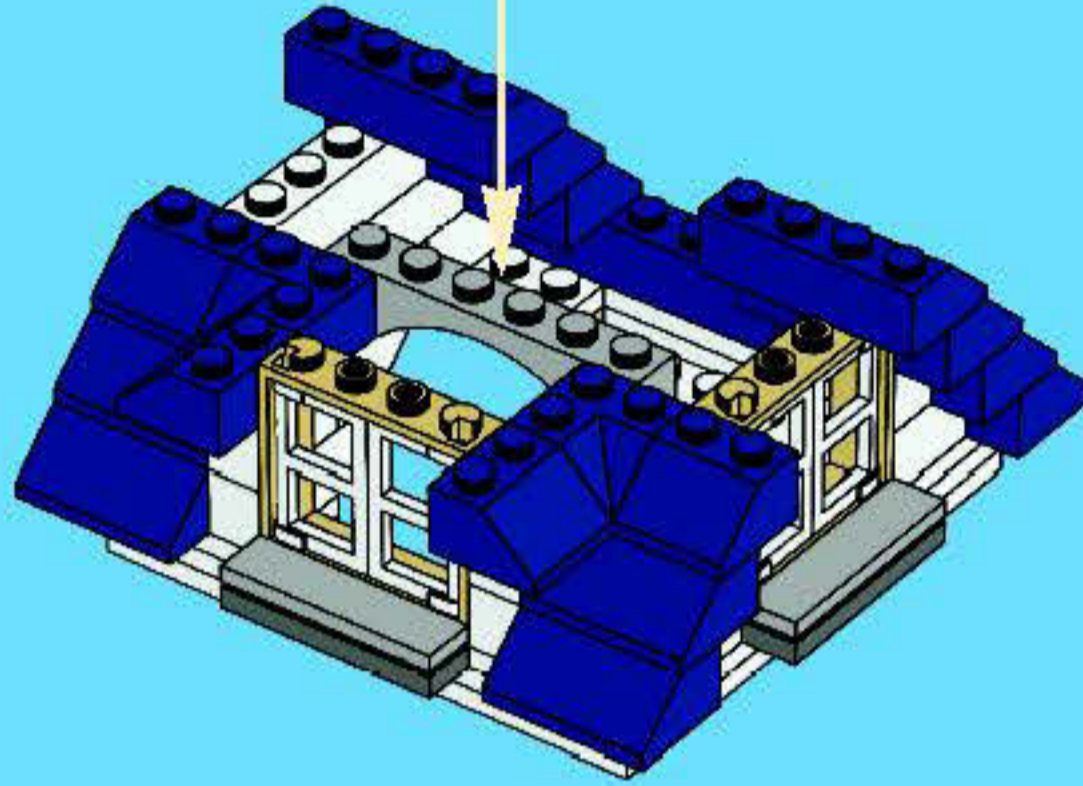

14

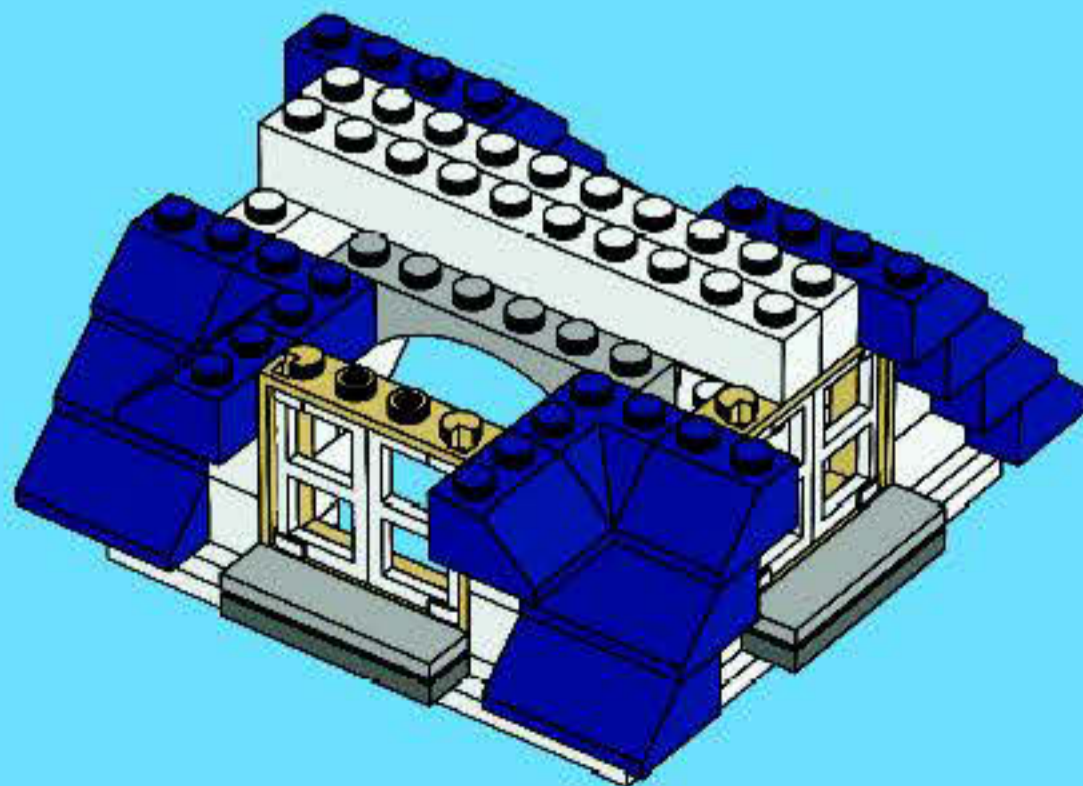





2x



2x

15

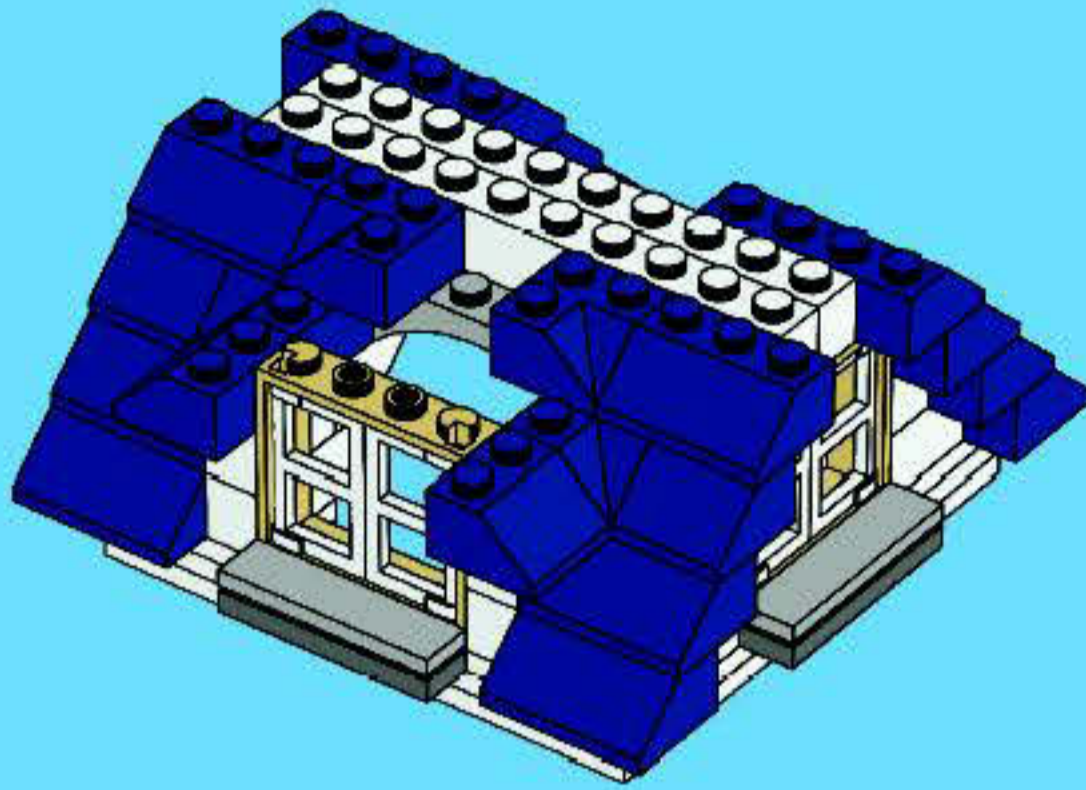

1x



2x

16

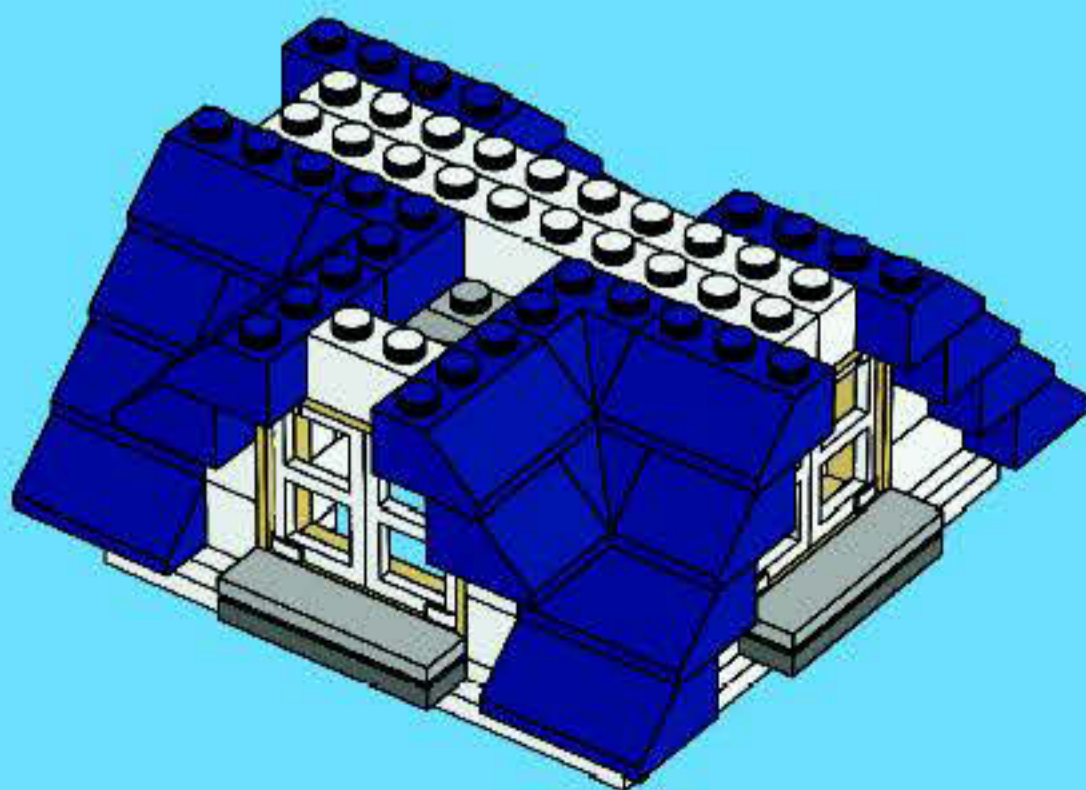



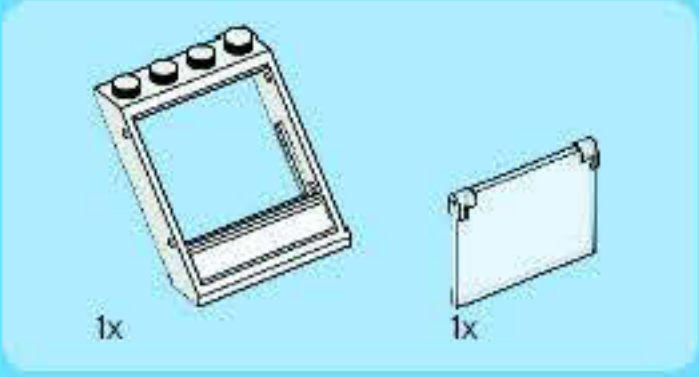

17

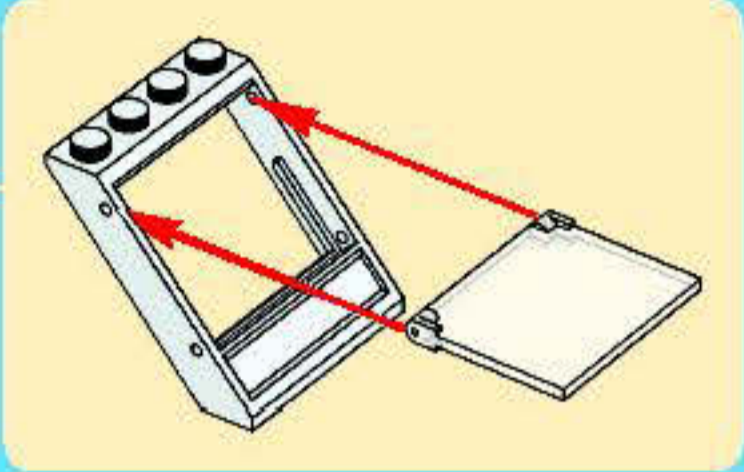
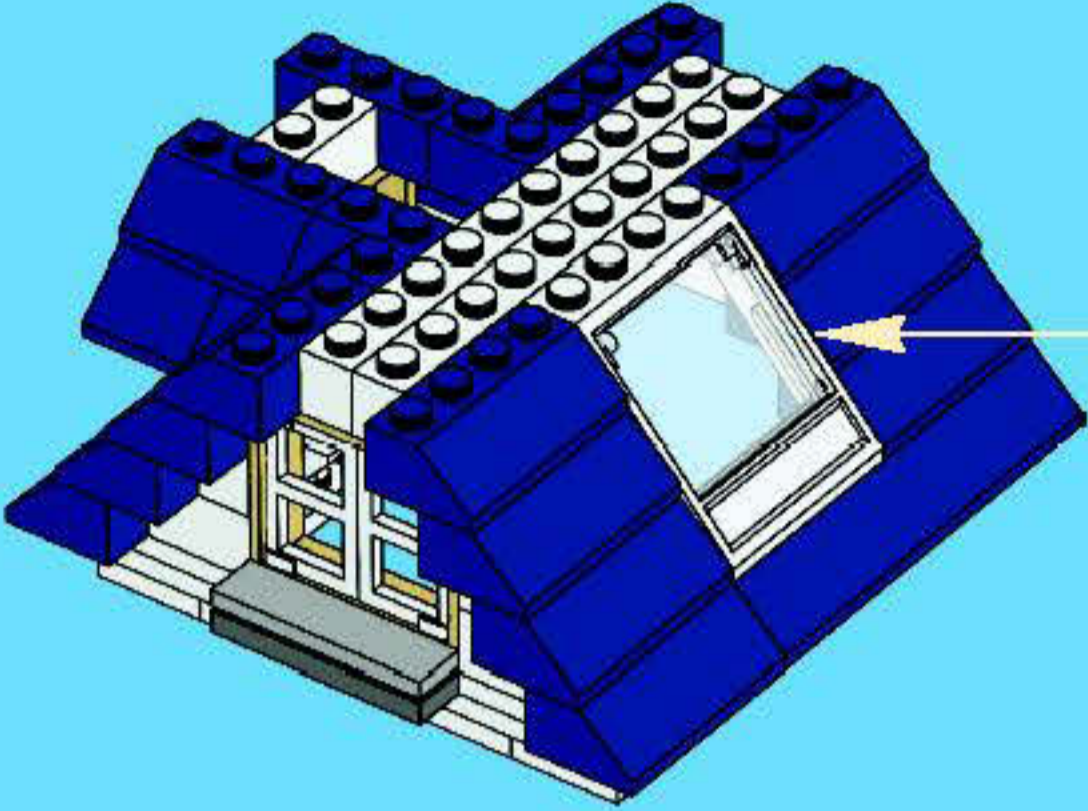

18

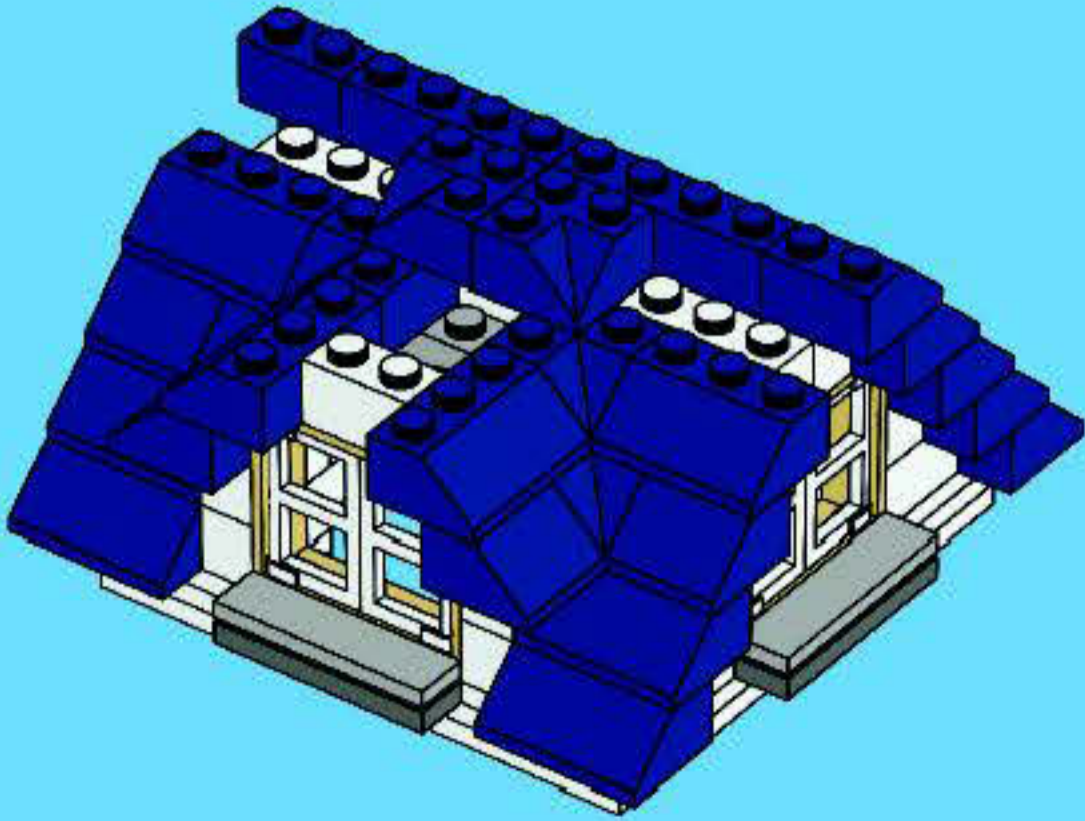





4x

19

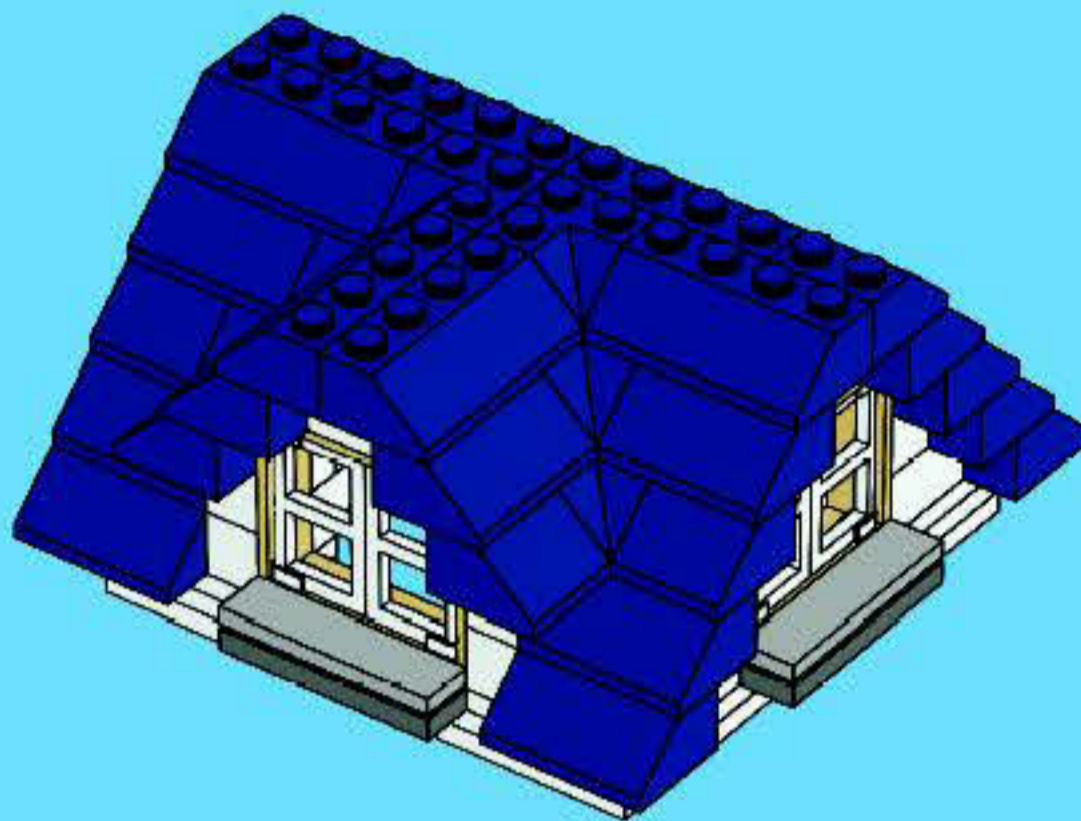

5x



1x

20

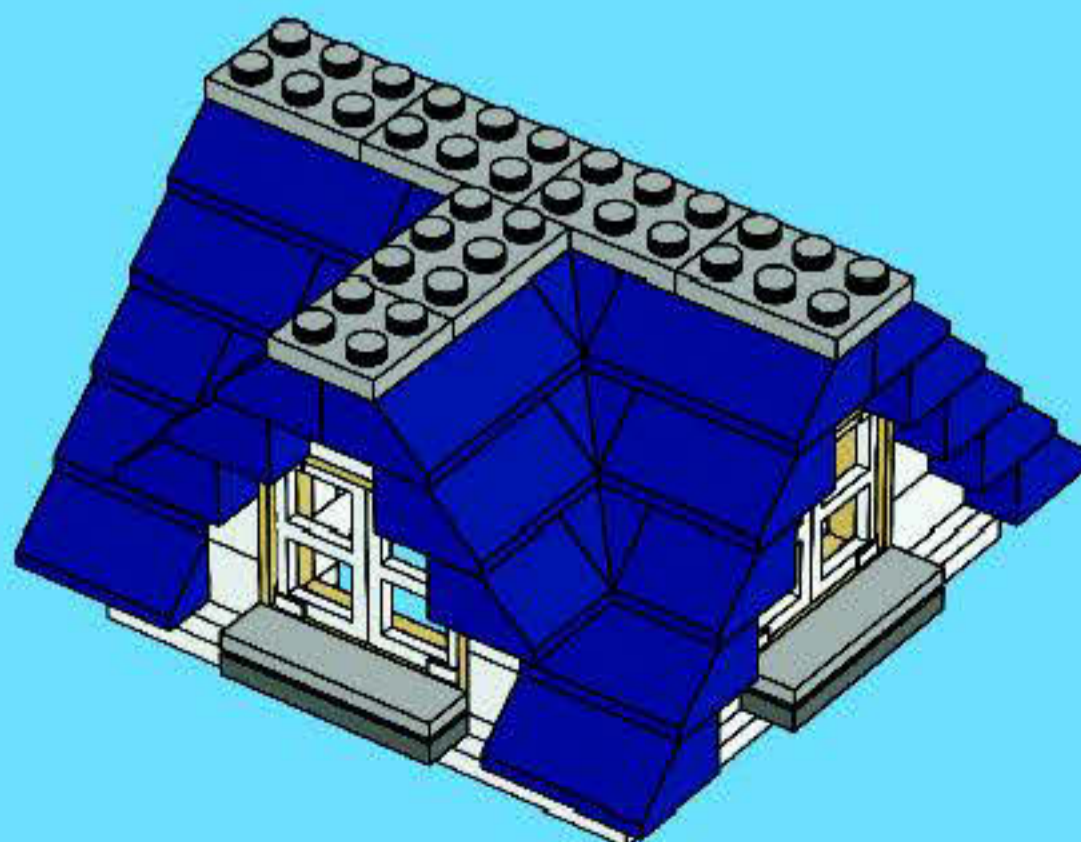





1x



4x

21

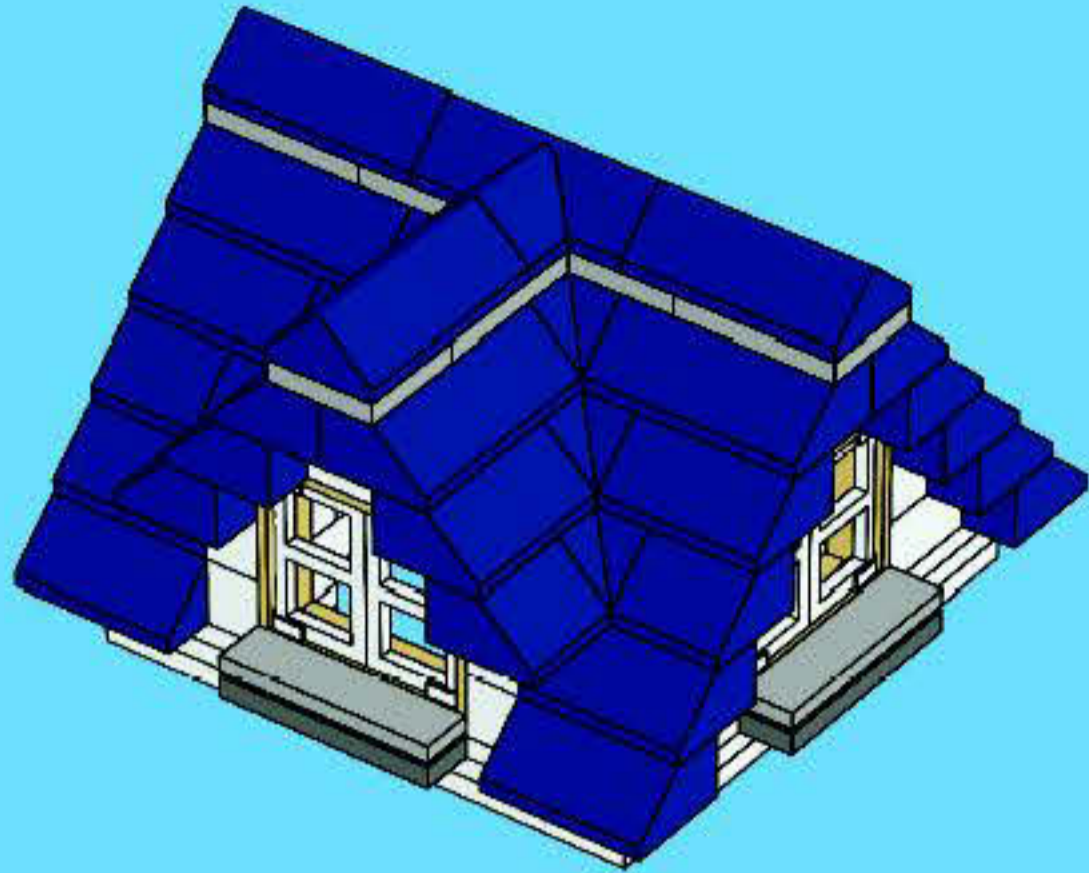

50





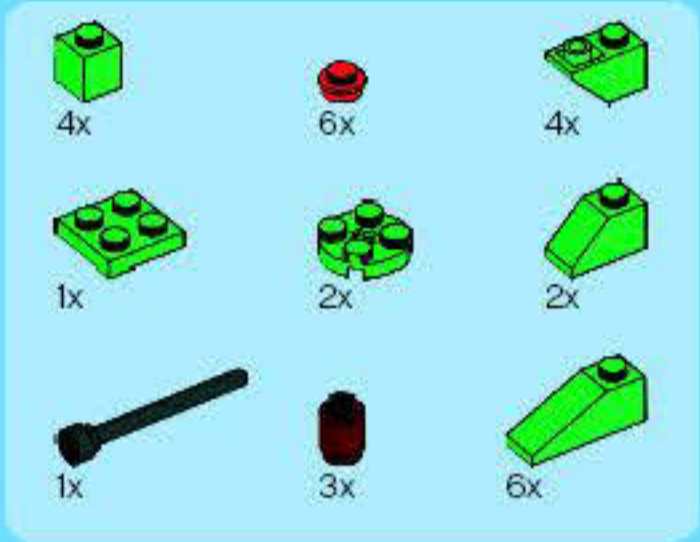

51

1

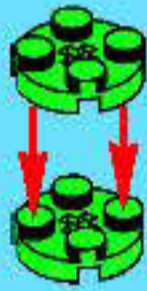

2

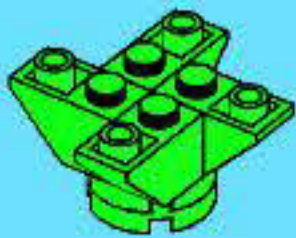

3

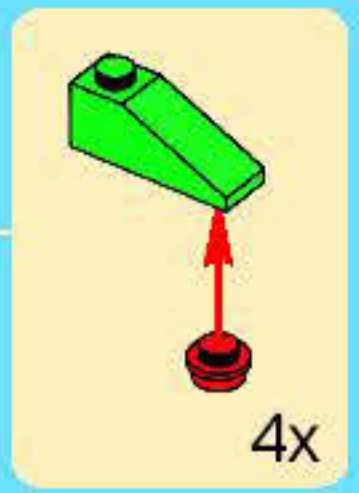

4

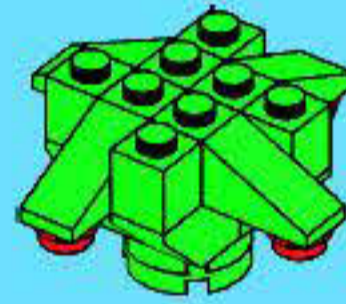

5

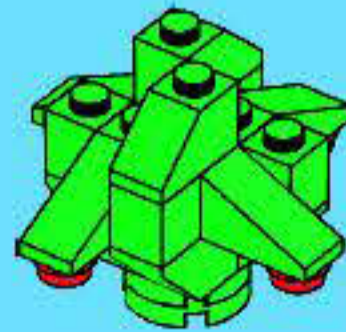



6

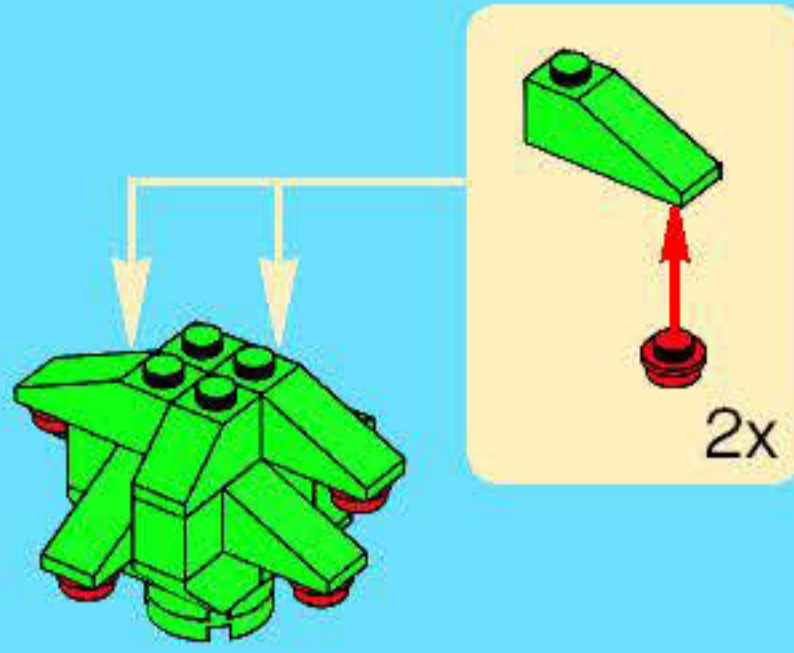

7

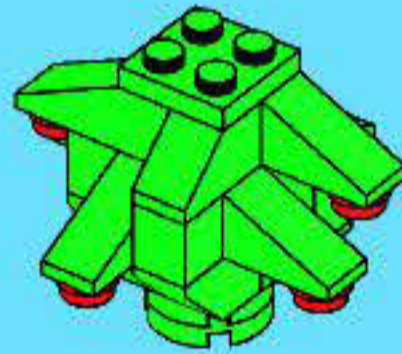

8

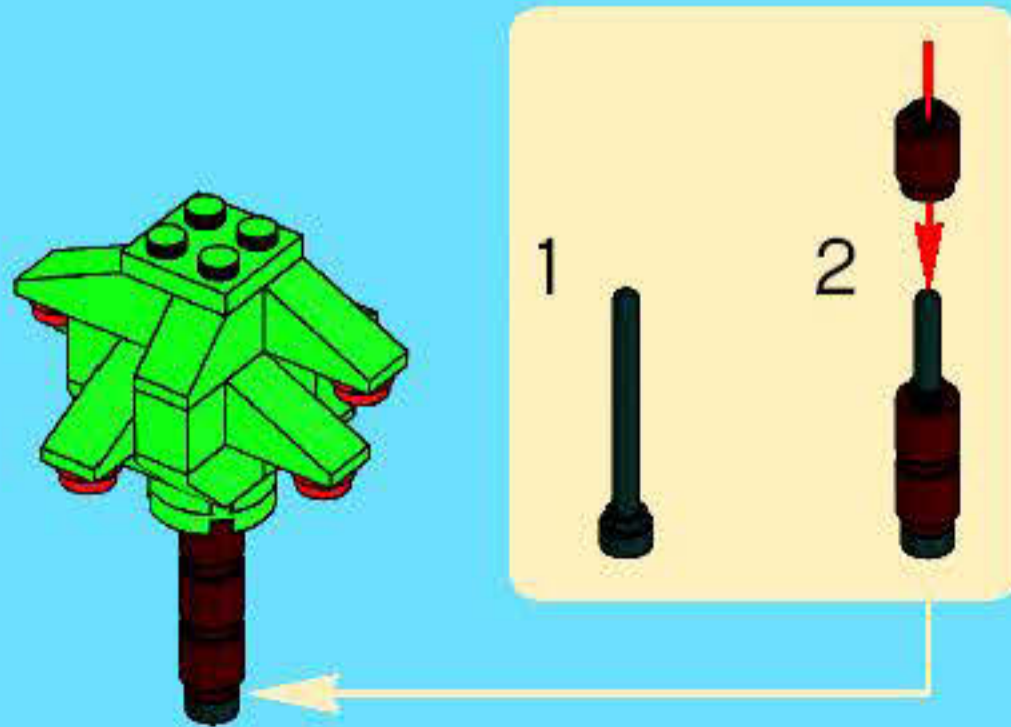







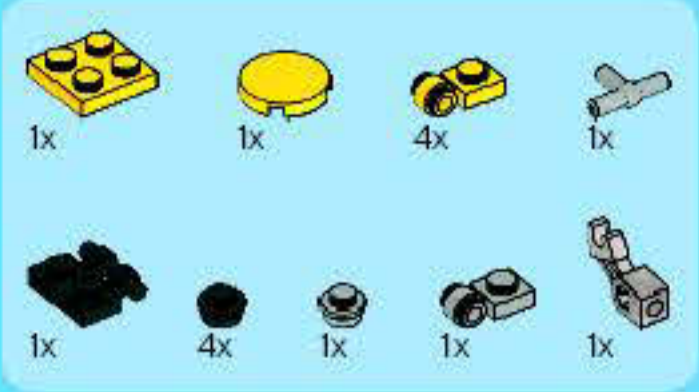

52

1



2



3



4



5

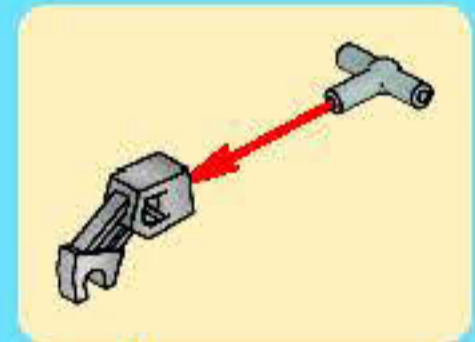

6





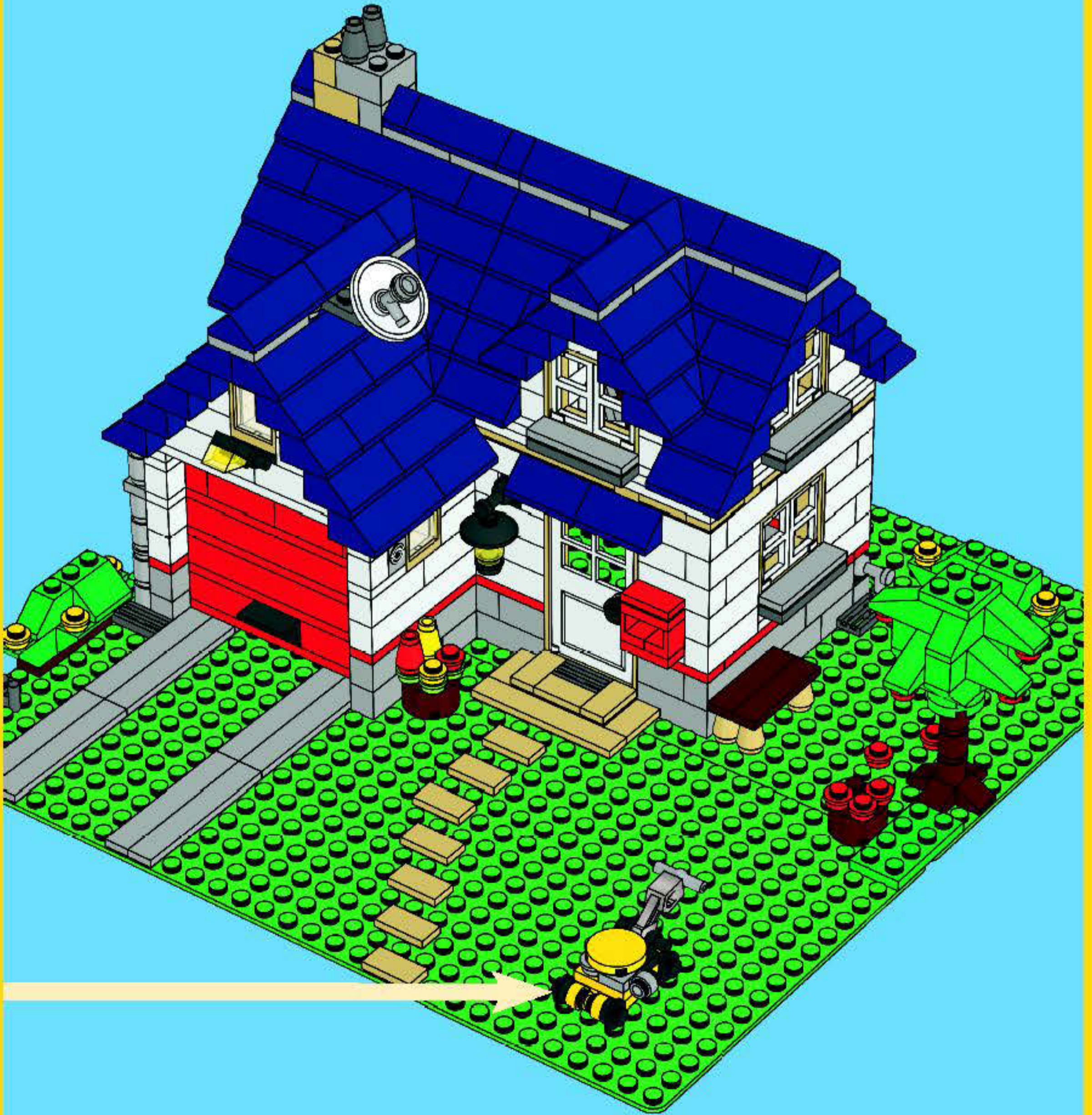



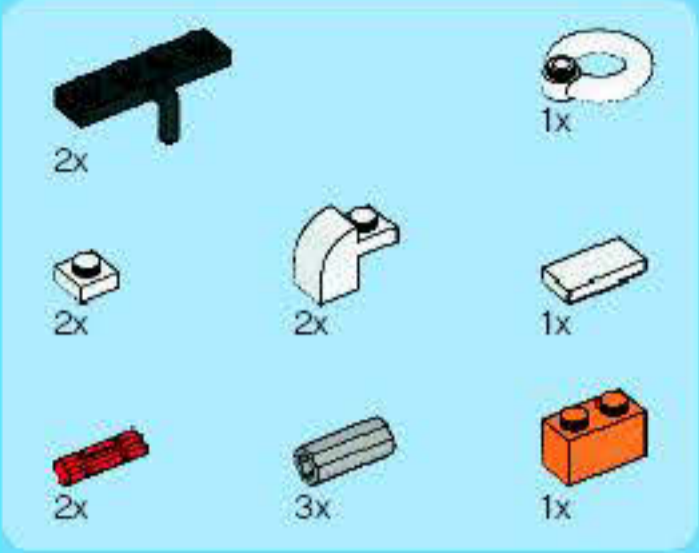
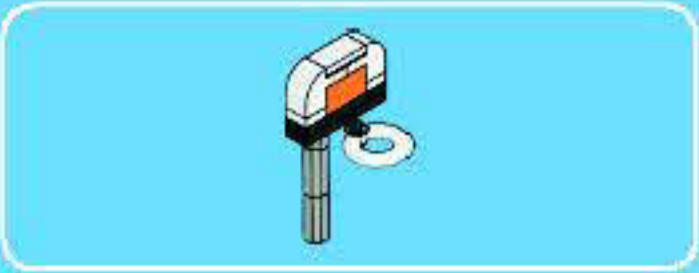

# 53

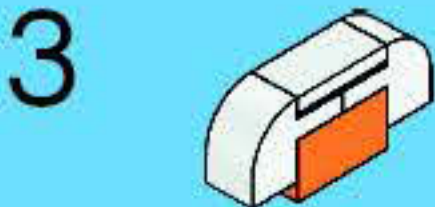

4

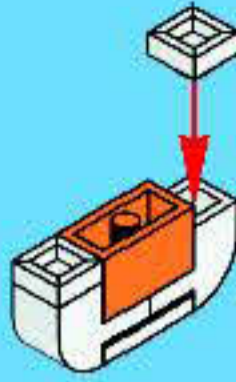

5



6

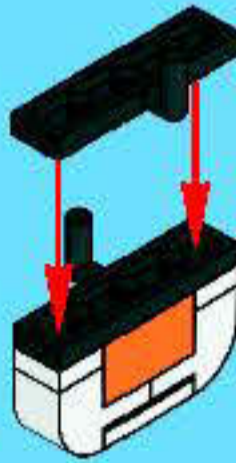

7





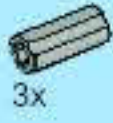

8

1



2



3

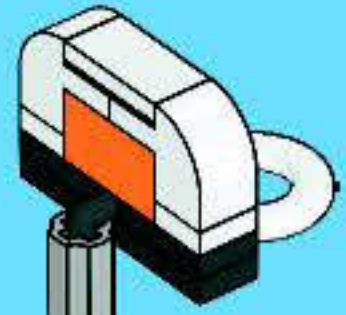





1x



2x

# 54













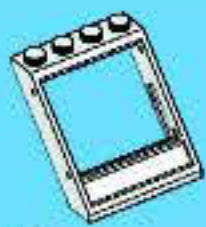



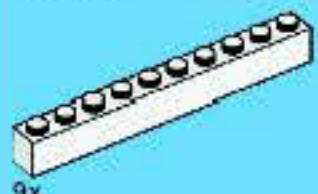















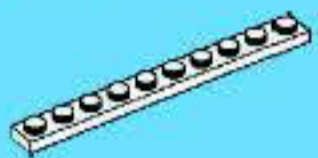



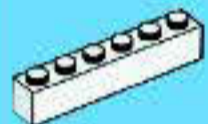







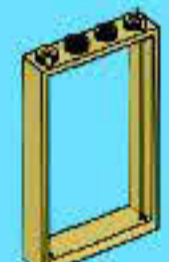





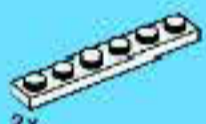



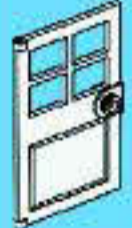
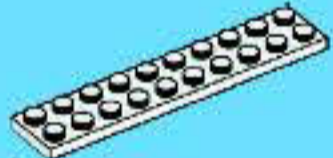



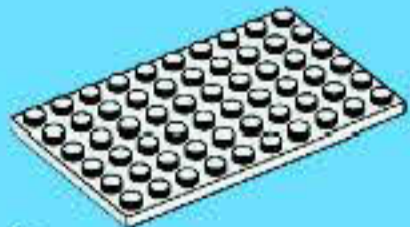



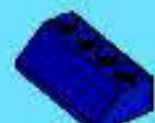

# CREATOR





|   |  |   |   |  |
|---|--|---|---|--|
| <br>10x<br>300501    | <br>1x<br>4536519    | <br>1x<br>4260942     | <br>5x<br>362321      | <br>1x<br>4109995    |
| <br>9x<br>611101    | <br>1x<br>4297083   | <br>1x<br>3006844    | <br>9x<br>346021     | <br>1x<br>4114306   |
| <br>19x<br>300401   | <br>1x<br>4179580   | <br>2x<br>4211166    | <br>2x<br>302221     | <br>18x<br>4114026  |
| <br>16x<br>362201   | <br>3x<br>302401    | <br>2x<br>4211194   | <br>13x<br>614121    | <br>3x<br>4157277   |
| <br>9x<br>301001    | <br>3x<br>447701    | <br>2x<br>4211190   | <br>2x<br>654121     | <br>3x<br>4578107  |
| <br>21x<br>300901 | <br>10x<br>302301 | <br>1x<br>4211211 | <br>2x<br>486521    | <br>3x<br>4578109 |
| <br>2x<br>300301  | <br>2x<br>362301  | <br>4x<br>4504376  | <br>2x<br>4578106  | <br>1x<br>4578110 |
| <br>4x<br>300101  | <br>2x<br>371001  | <br>3x<br>4211183  | <br>4x<br>4578104  | <br>4x<br>4529237 |
| <br>2x<br>609101  | <br>2x<br>366601  | <br>2x<br>4142865  | <br>7x<br>4579236  | <br>4x<br>4159553 |
| <br>1x<br>4521943 | <br>2x<br>383201  | <br>4x<br>362221  | <br>17x<br>4153653 | <br>4x<br>4121921 |
| <br>3x<br>306901  | <br>1x<br>4528341 | <br>3x<br>300821  | <br>17x<br>4568711 | <br>2x<br>4114324 |
| <br>2x<br>4521848 | <br>15x<br>366501 | <br>1x<br>306921   | <br>22x<br>4578094 | <br>5x<br>4249019 |
|   | <br>6x<br>4520842 | <br>1x<br>416221  | <br>10x<br>4578092 |  |
|   |  | <br>1x<br>4529234  |   |  |



- 1x 415024
- 2x 4121715
- 2x 4211521
- 8x 4211549
- 2x 4211503
- 4x 408124
- 4x 300528
- 1x 4211477
- 2x 4211535
- 1x 4525464
- 1x 302328
- 10x 4211388
- 1x 4211477
- 2x 4529240
- 1x 302224
- 2x 302228
- 6x 4211428
- 3x 4211398
- 1x 302228
- 2x 302228
- 9x 4211393
- 1x 4244627
- 1x 614124
- 2x 403228
- 6x 4211428
- 1x 4211397
- 1x 4521187
- 1x 4121739
- 2x 302028
- 1x 4211387
- 2x 4211397
- 3x 4211065
- 1x 4157103
- 2x 4142989
- 1x 4211349
- 11x 4211396
- 1x 4260885
- 4x 407026
- 8x 4121969
- 1x 4211424
- 3x 4211437
- 1x 4211396
- 1x 4260885
- 1x 474026
- 4x 4107637
- 1x 4211424
- 3x 4211437
- 3x 4210631
- 3x 4517925
- 6x 4107637
- 1x 4211353
- 1x 4211410
- 3x 4552035
- 2x 4140588
- 2x 303928
- 3x 4512360
- 8x 4211412
- 1x 4552033
- 2x 3004326
- 7x 614126
- 2x 4211414
- 8x 4211525
- 1x 4494600
- 7x 614126
- 2x 4142717
- 3x 4211508
- 4x 4183133
- 1x 459926
- 2x 4219648
- 3x 4211356
- 1x 395726

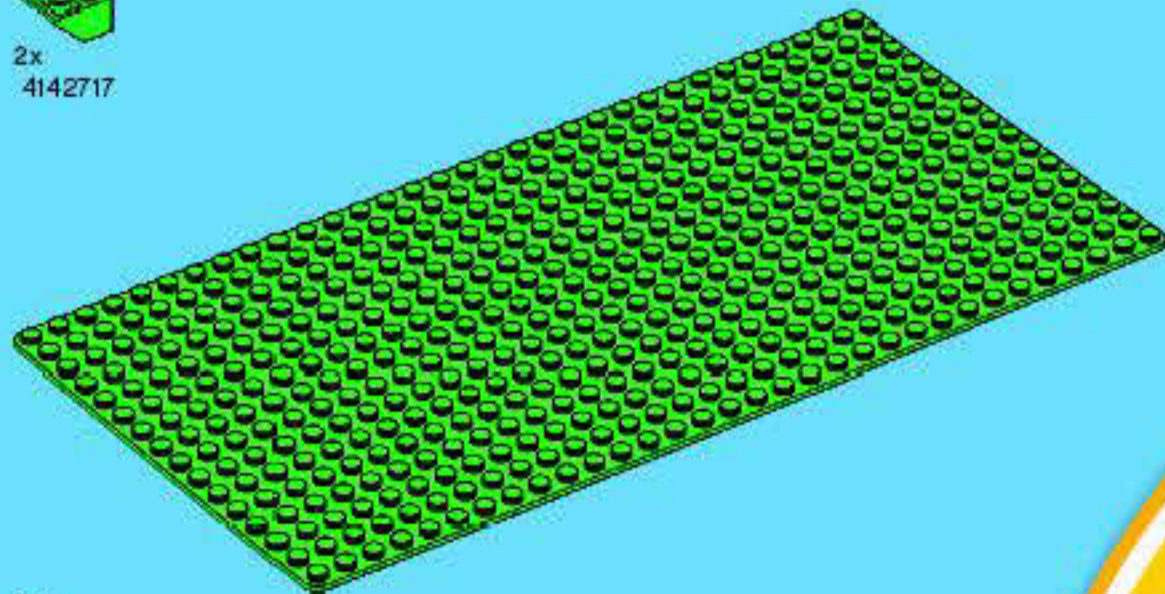

2x 4219648

Customer Service  
Kundenservice  
Service Consommateurs  
Servicio Al Consumidor

[www.lego.com/service](http://www.lego.com/service) or dial



: 00800 5346 5555

: 1-800-422-5346







# WIN!



Go to [www.nielsen.com/LEGO](http://www.nielsen.com/LEGO) to fill out a survey for a chance to win a cool LEGO® Product. No purchase necessary. Open to all residents where not prohibited.

 [www.LEGO.com](http://www.LEGO.com)

## [www.nielsen.com/LEGO](http://www.nielsen.com/LEGO)

### GEWINNE!

Nimm an der Umfrage auf [www.nielsen.com/LEGO](http://www.nielsen.com/LEGO) teil und hab die Chance ein cooles LEGO® Produkt zu gewinnen!  
Die Teilnahme am Gewinnspiel führt zu keinerlei Kaufverpflichtungen. Teilnahme in allen nicht ausgeschlossenen Ländern möglich.

### WIN!

Ga naar [www.nielsen.com/LEGO](http://www.nielsen.com/LEGO), vul een enquêteformulier in en maak kans op een cool LEGO® product.  
Geen aankoopverplichting. Iedereen mag deelnemen, uitgezonderd ingezetenden van landen waar een enquêteverbod geldt.

### GAGNE!

Visite [www.nielsen.com/LEGO](http://www.nielsen.com/LEGO) pour répondre à un questionnaire et avoir une chance de gagner un produit LEGO® très cool!  
Aucune obligation d'achat. Ouvert à tous les résidents des pays autorisés.

### 当てよう!

[www.nielsen.com/LEGO](http://www.nielsen.com/LEGO)にアクセスして、アンケートにご記入ください。当選者にはレゴ製品を差し上げます。  
お買い上げの必要はありません。禁止されていない限り、すべての年齢にご利用いただけます。