



CITY

60015



WARNING: CHOKING HAZARD.
Small parts. Not for children under 3 years.

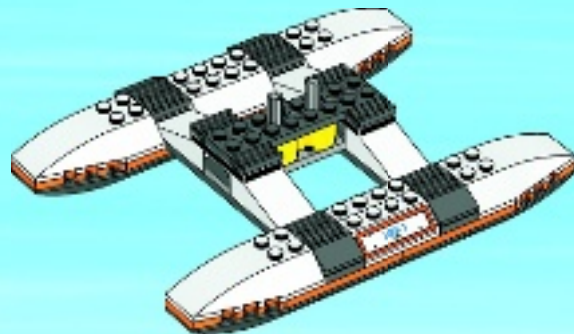
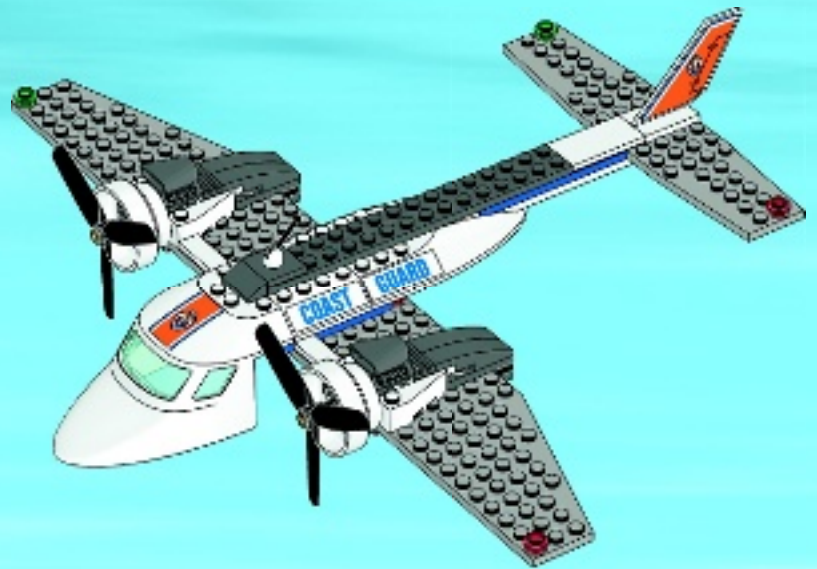
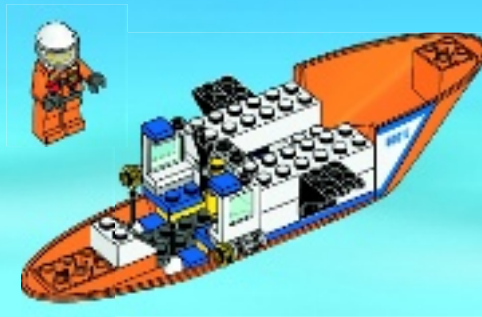

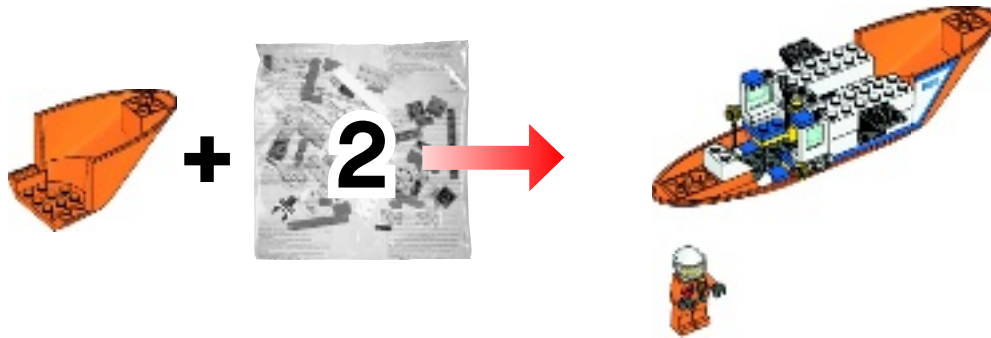

⚠️ **AVERTISSEMENT** : RISQUE D'ÉTOUFFEMENT.
Contient des petites pièces. Ne convient pas aux enfants de moins de 3 ans.

⚠️ **ADVERTENCIA**: PELIGRO DE ASFIXIA.
No recomendado para niños menores de 3 años. Contiene piezas pequeñas.

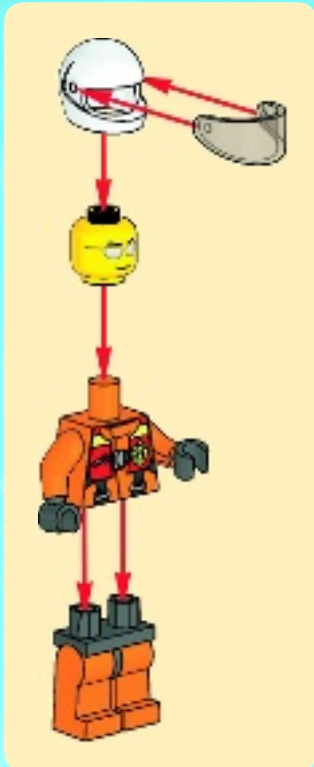

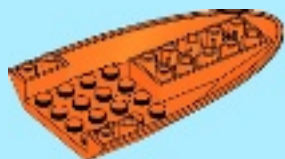

1x

1

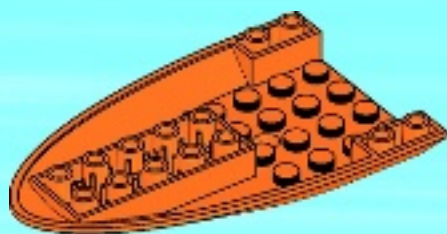



2

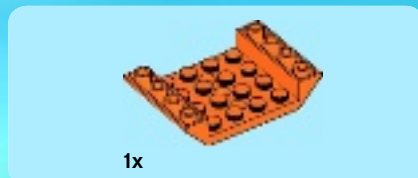
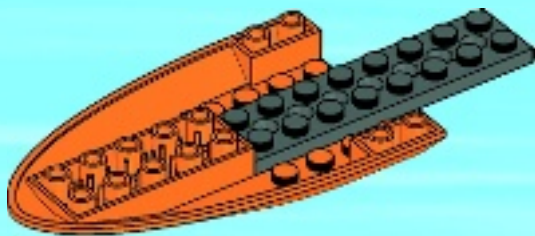

3

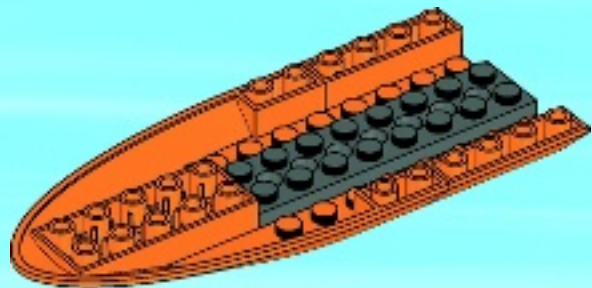



2x



2x

4

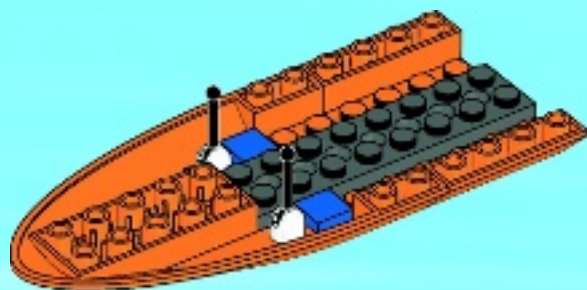



2x

5

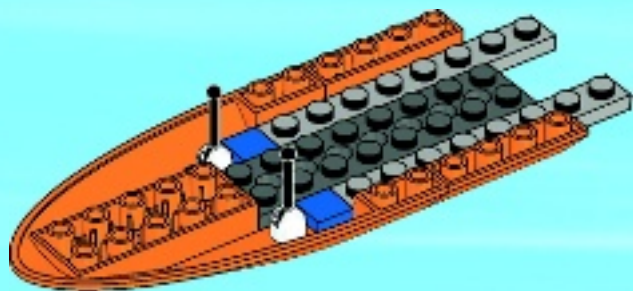

2x

6

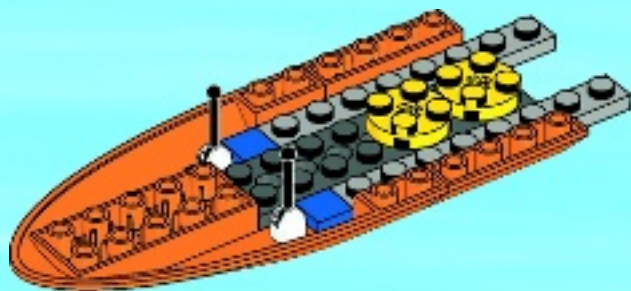



2x

7



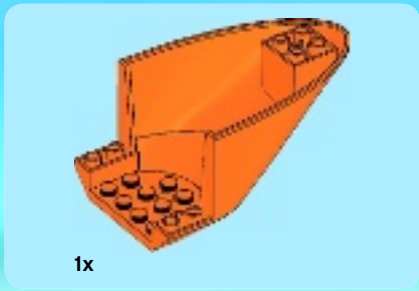

8

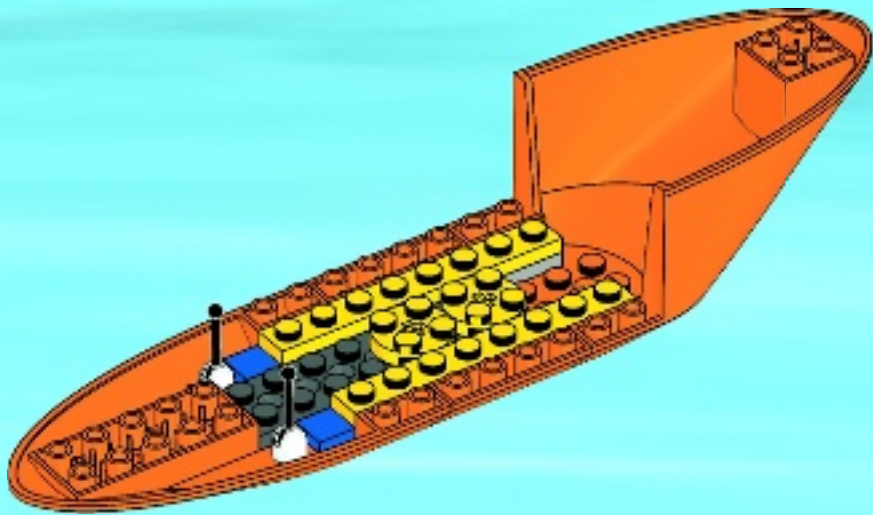

9

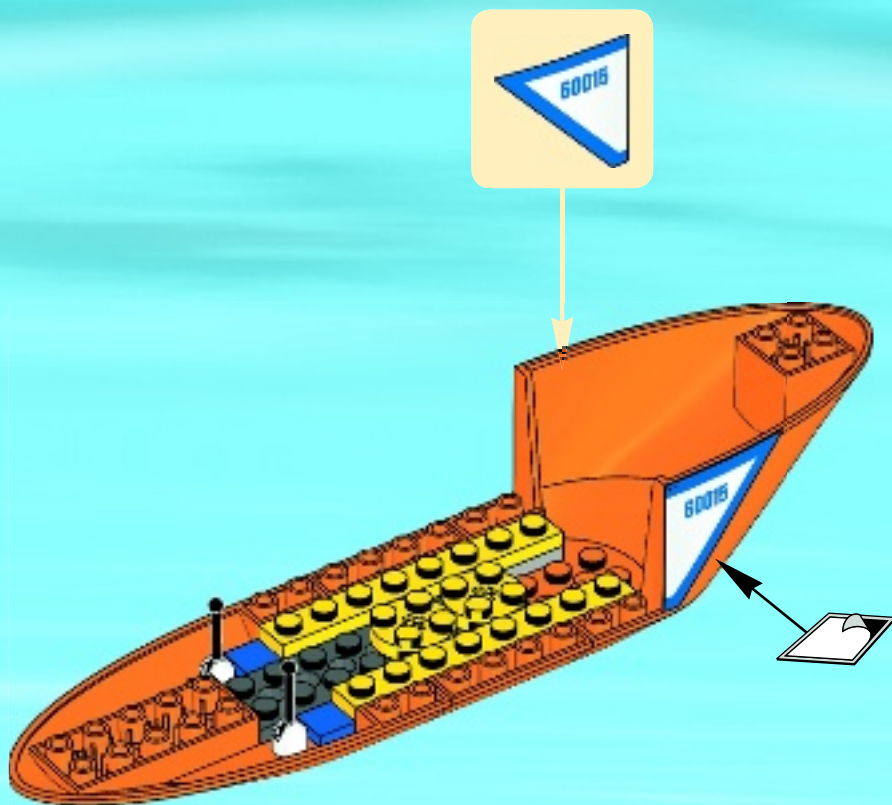



1x



1x

10

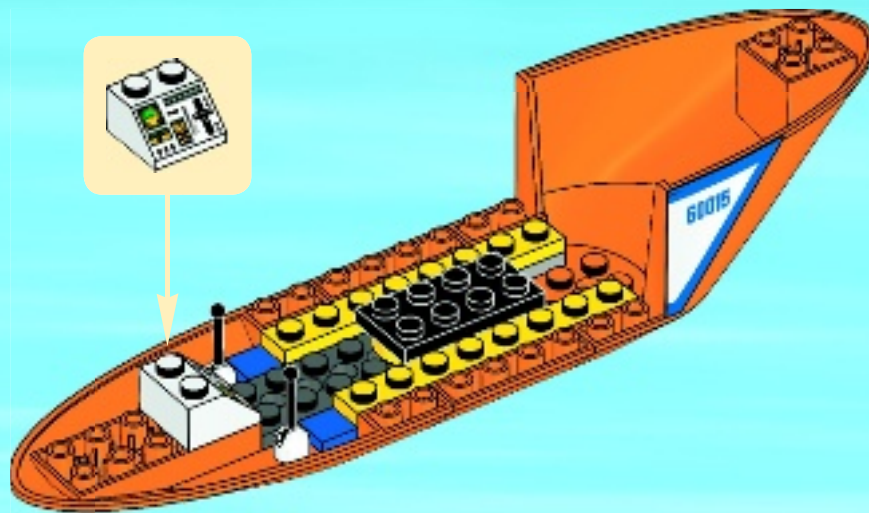

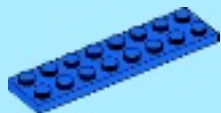

2x

11

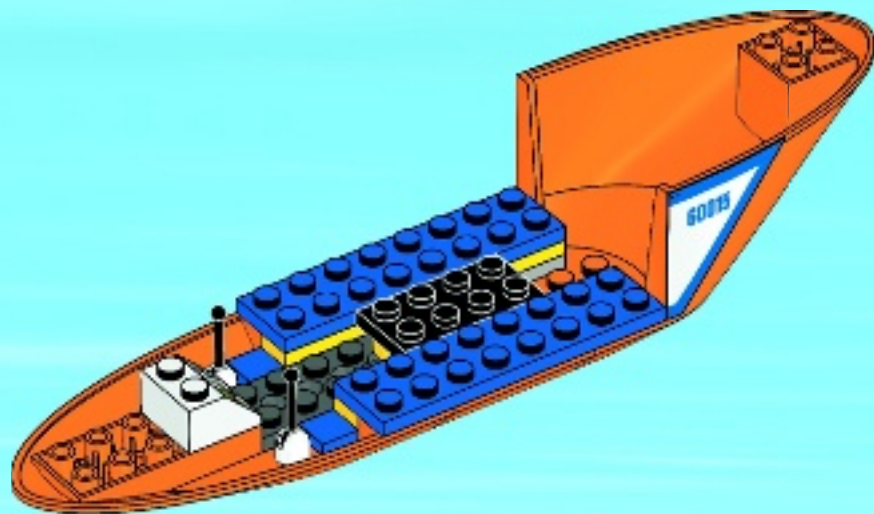

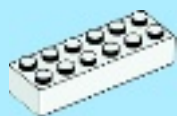

1x

12

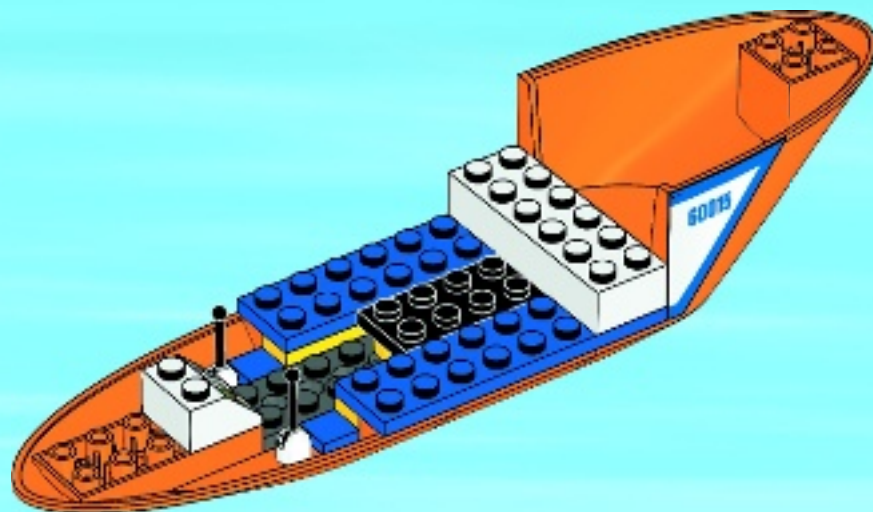



4x

13

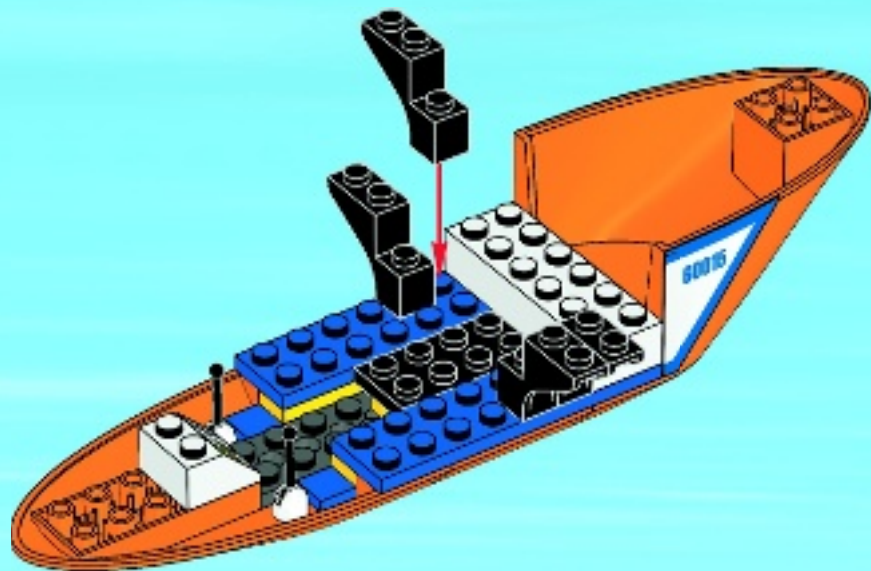

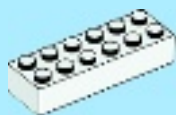

1x



2x

14

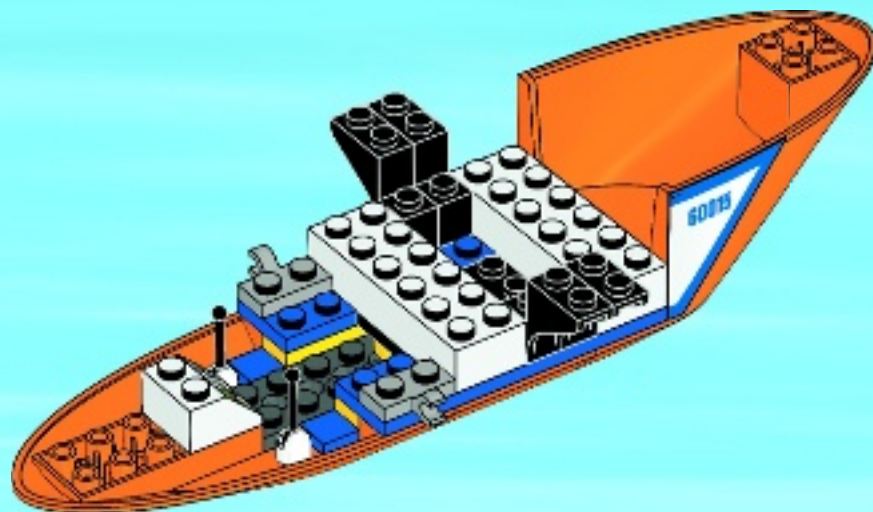

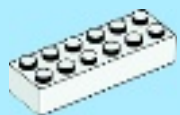

2x



2x

15

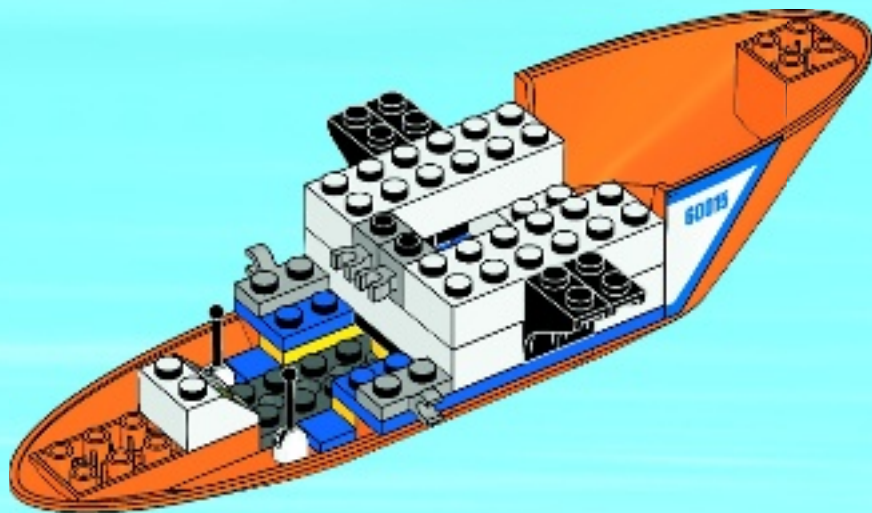



1x



1x



1x

16





2x



2x

17

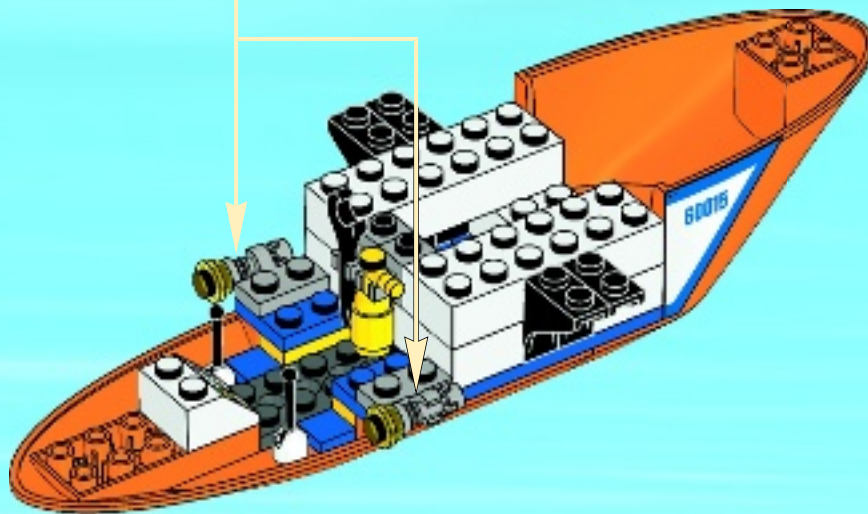
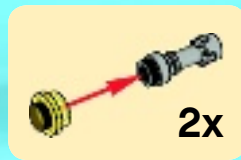



2x



2x

18

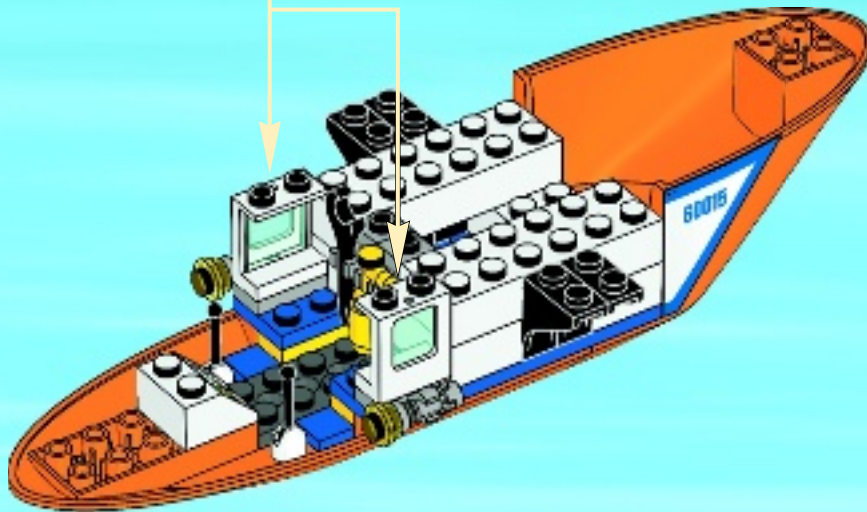
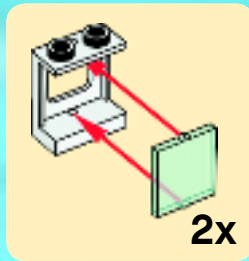



2x

19

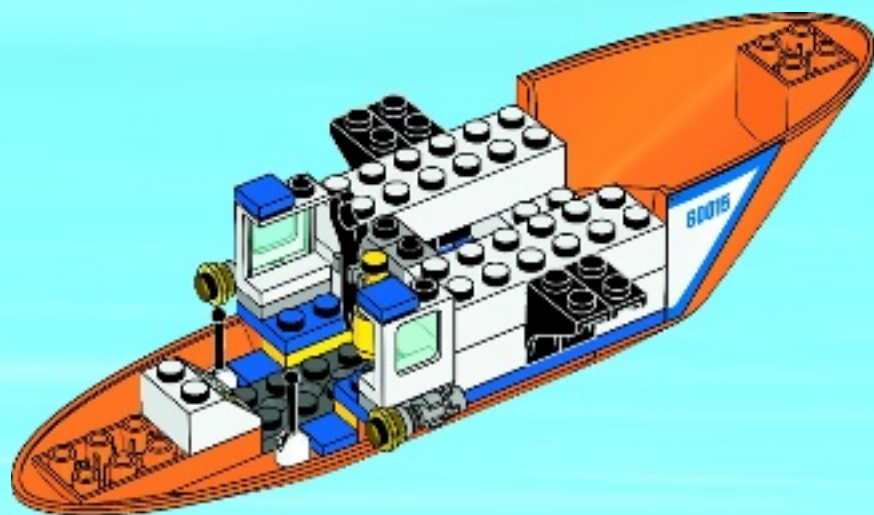

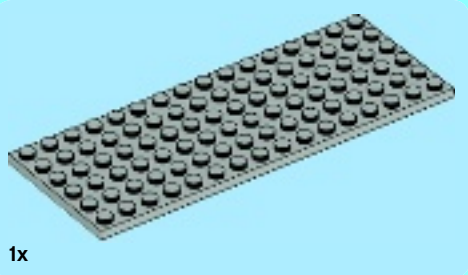
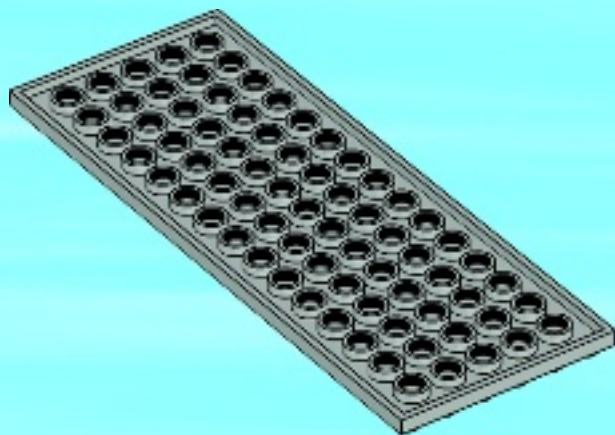
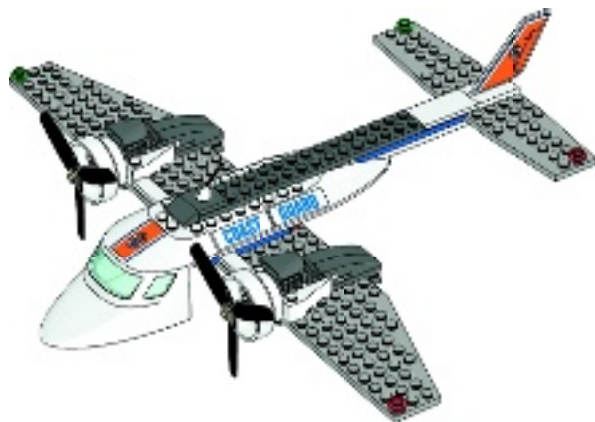

1x

1

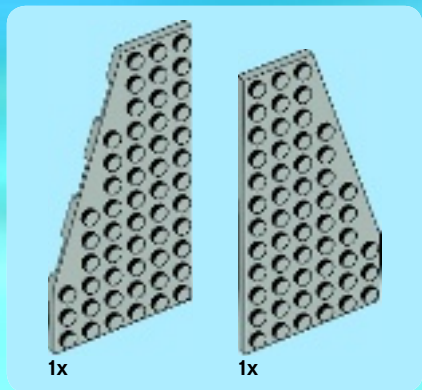

2

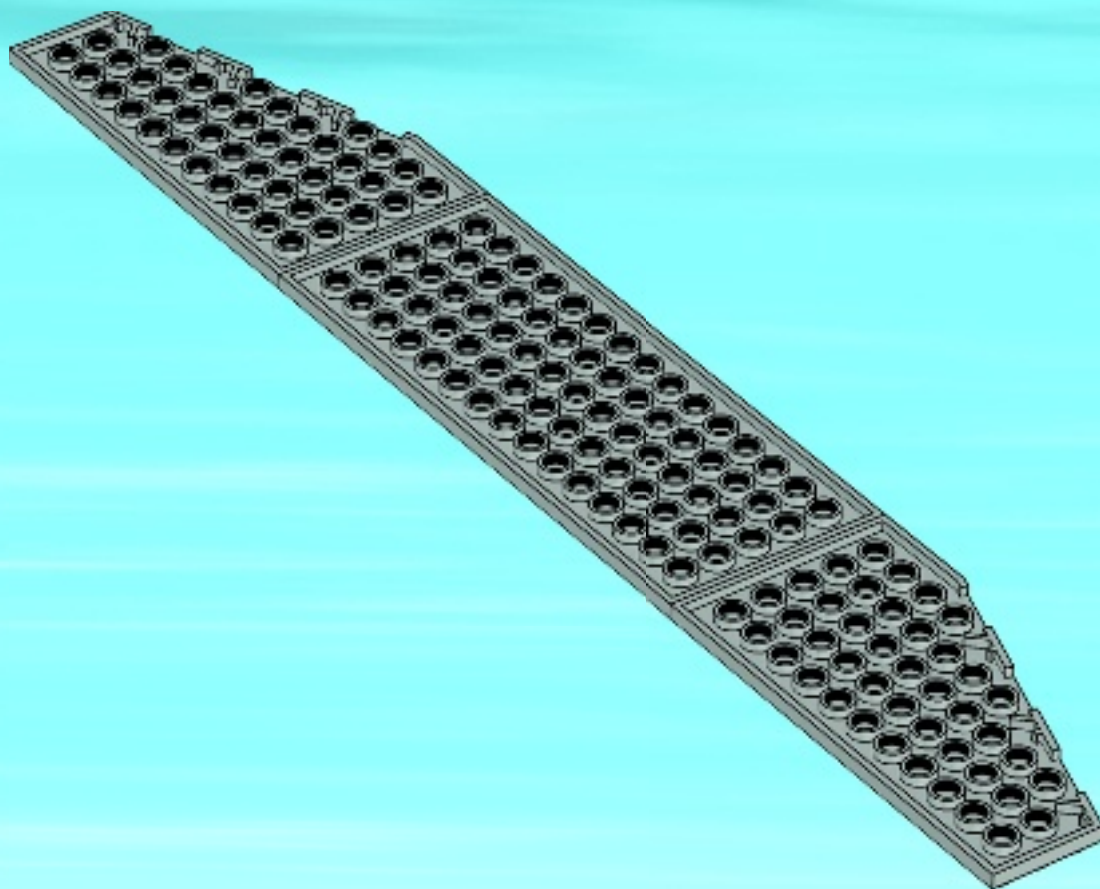



2x

3

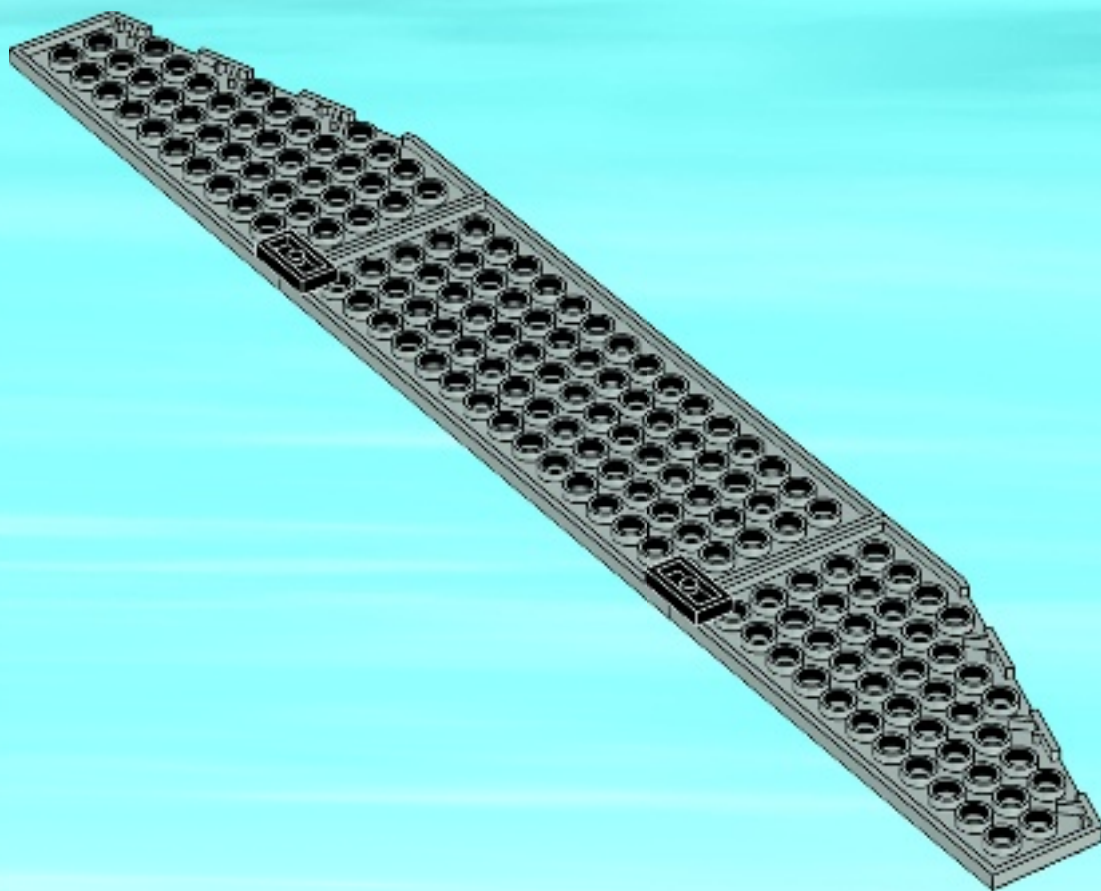



2x

4

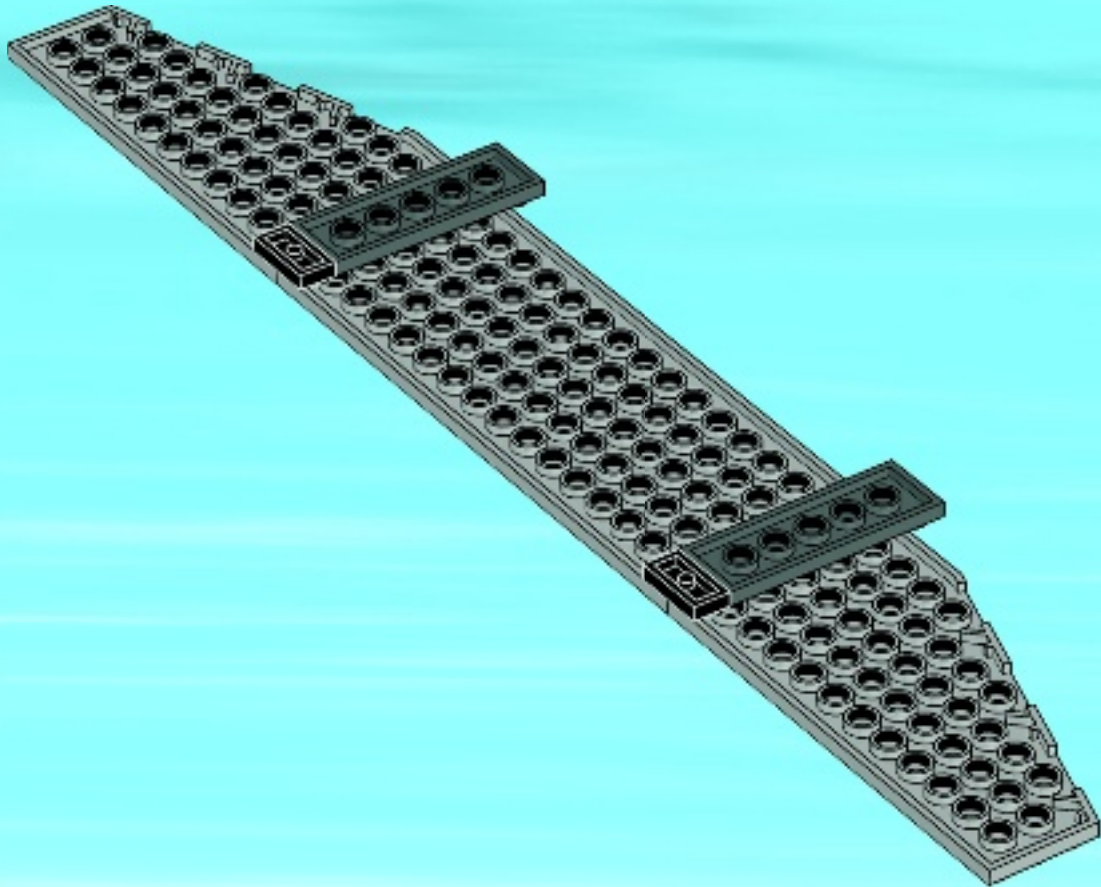



2x

5

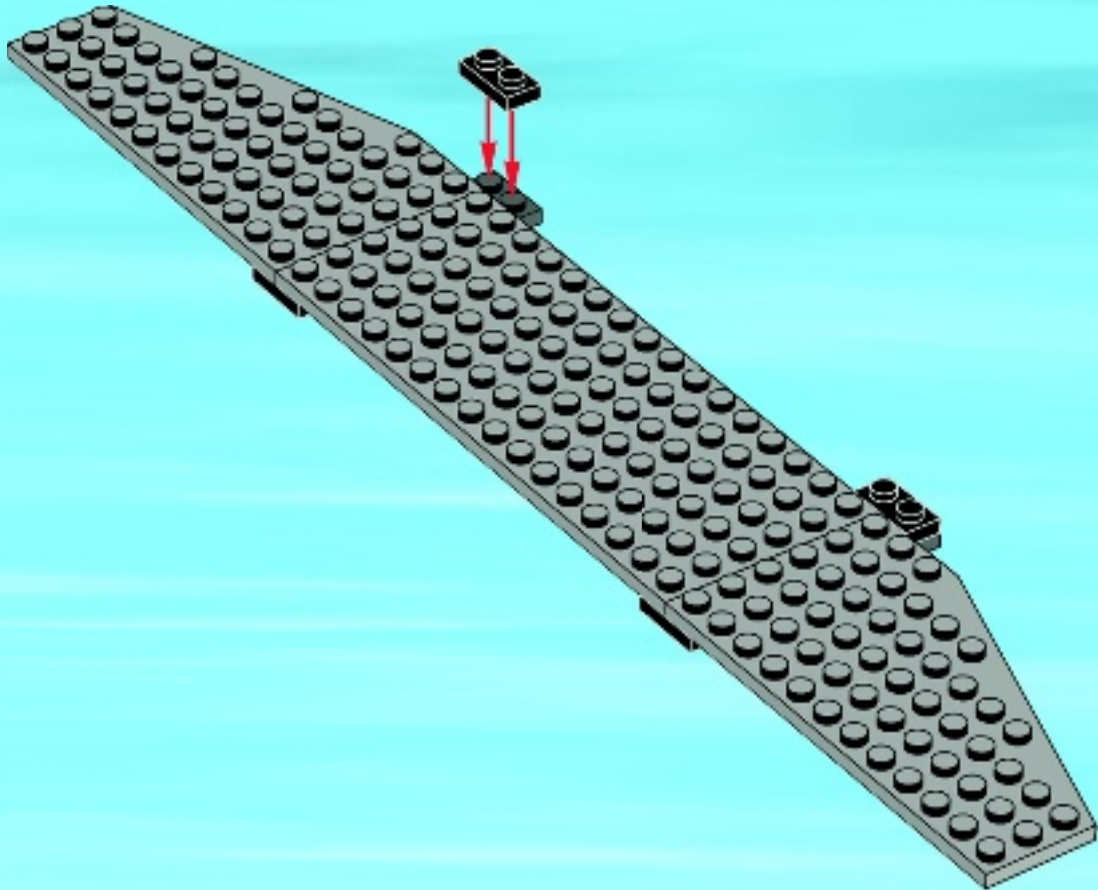



2x

6

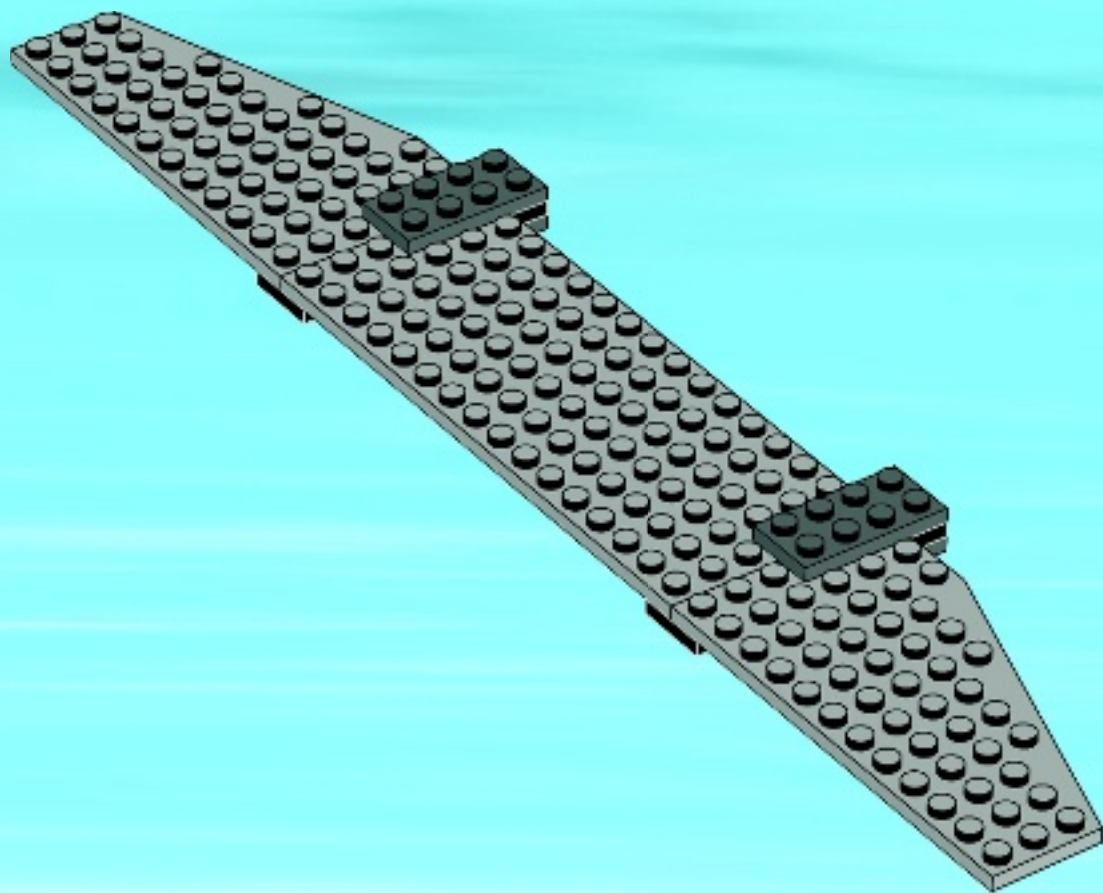



8x

7

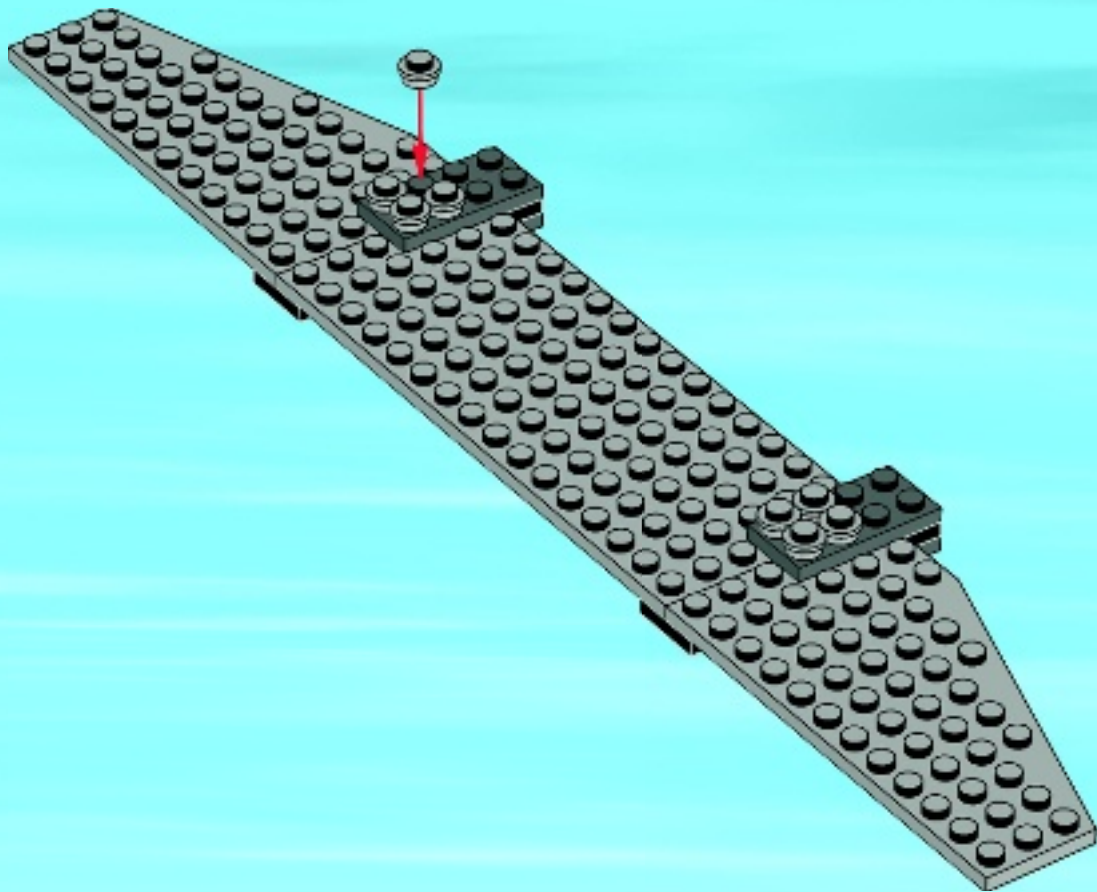



1x



1x

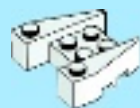

2x

8

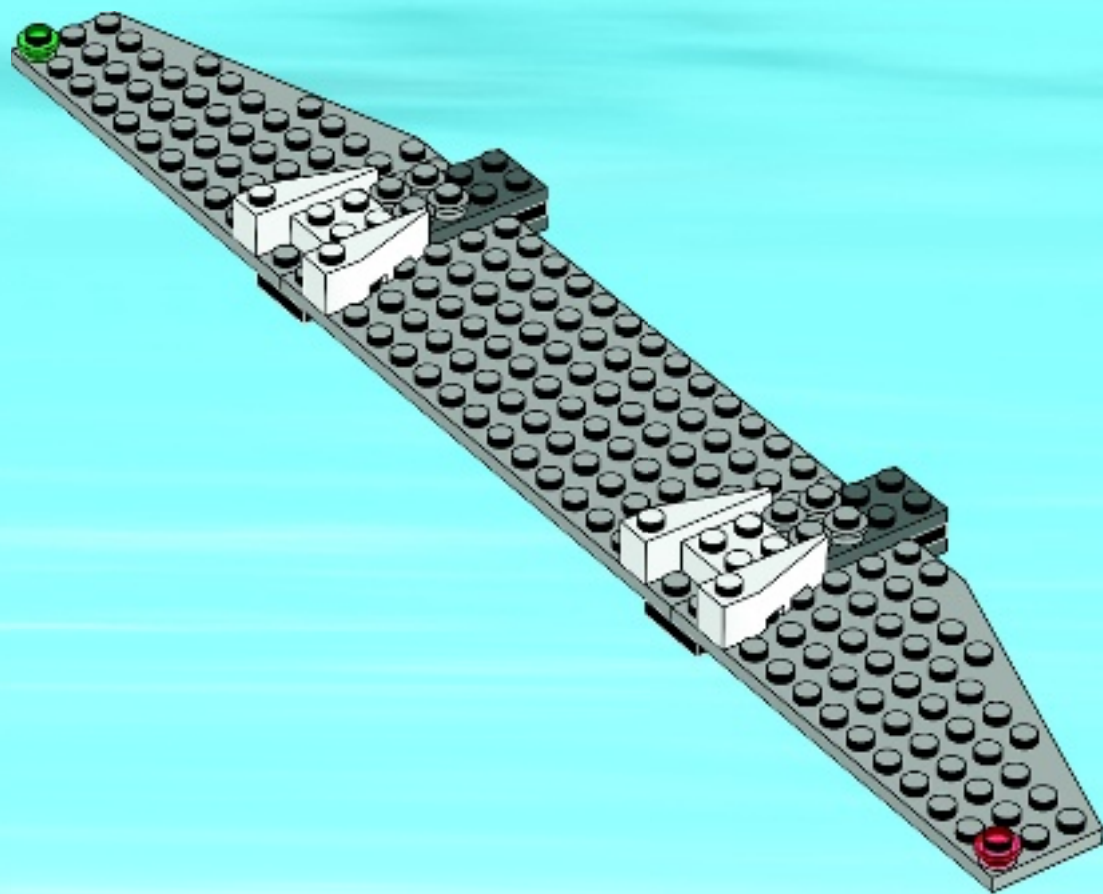



2x



2x

9

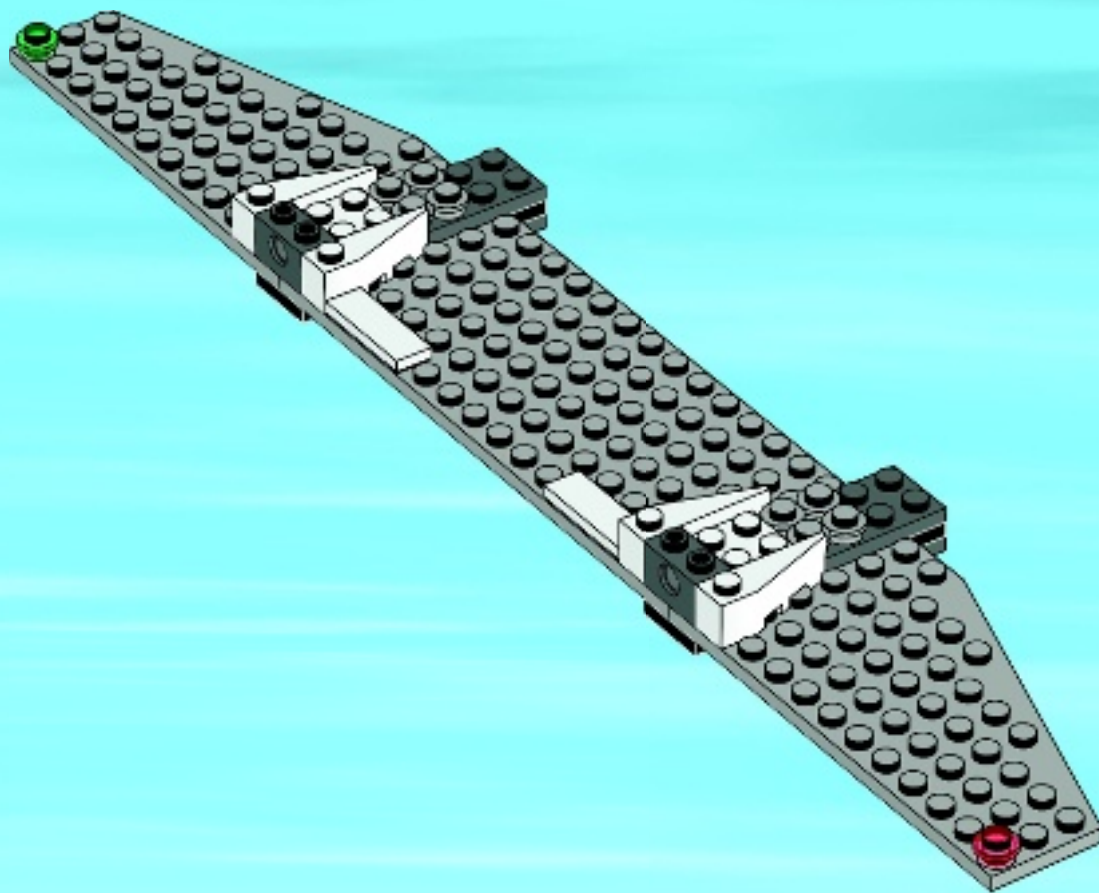



2x

10

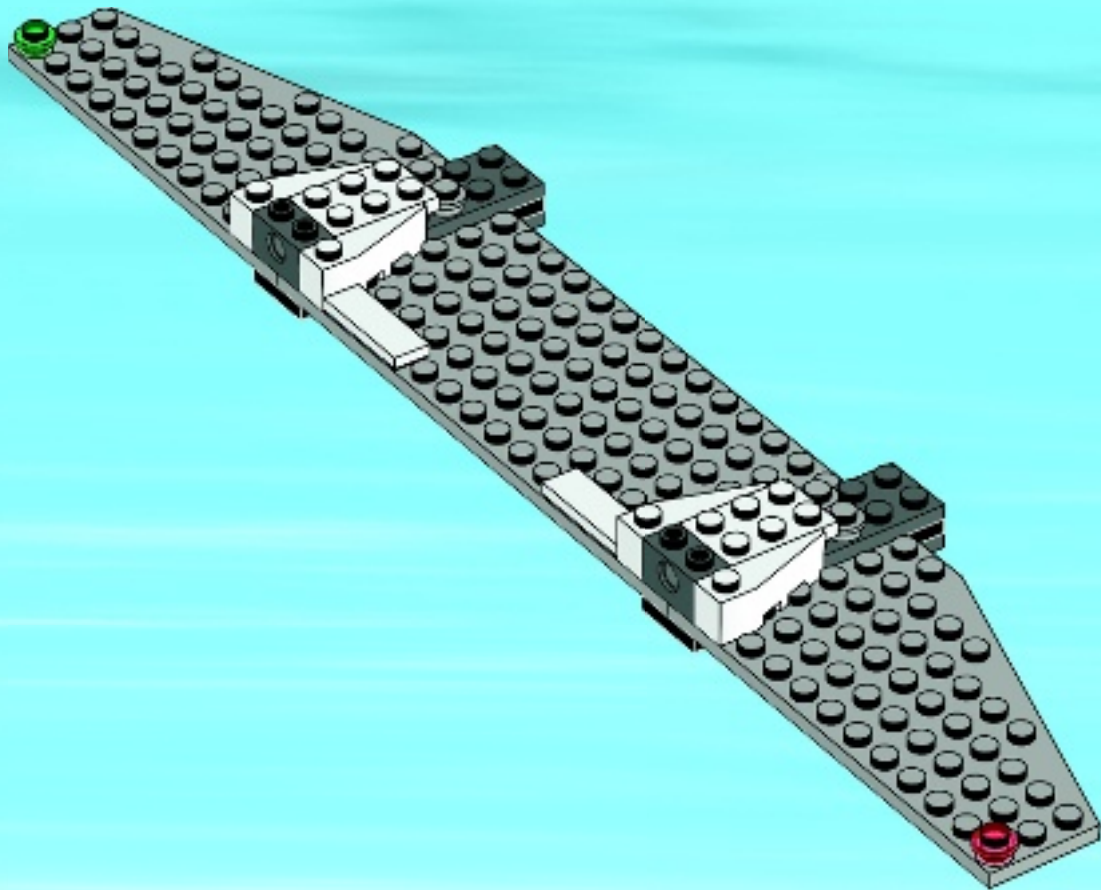



2x



4x

11

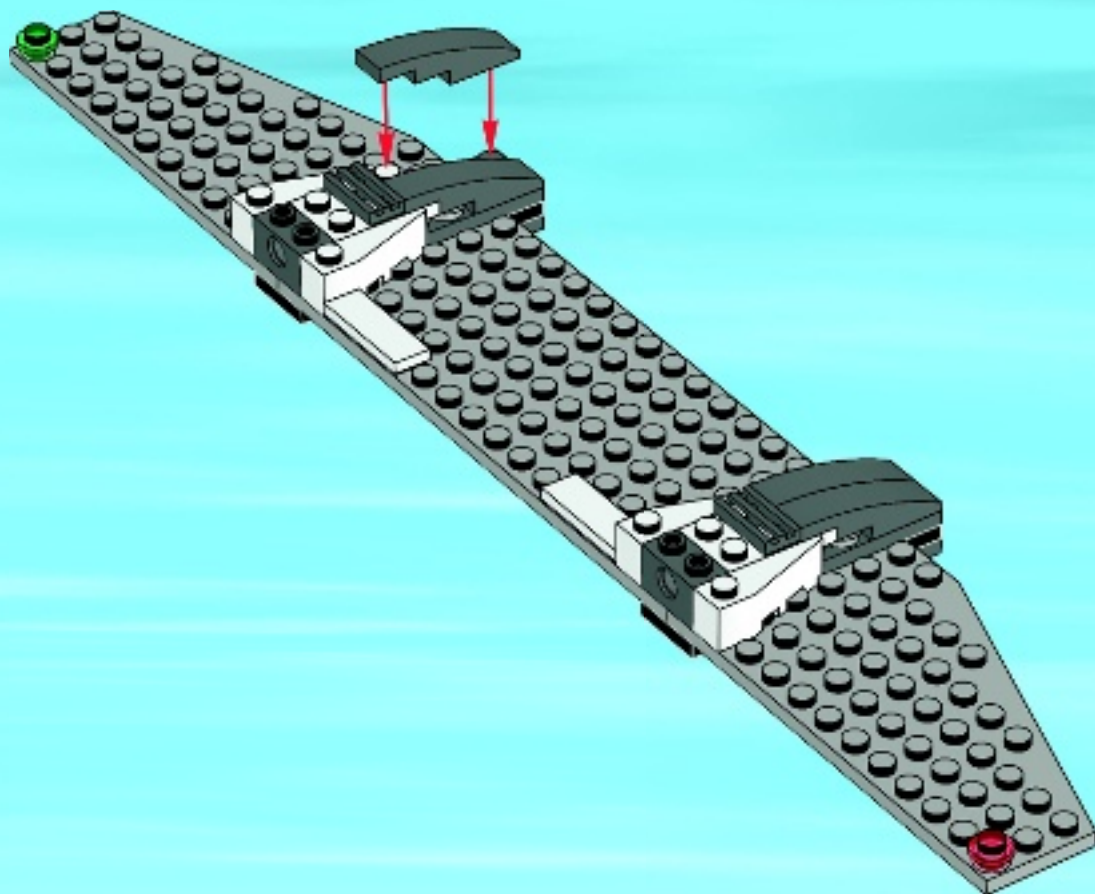



2x

12

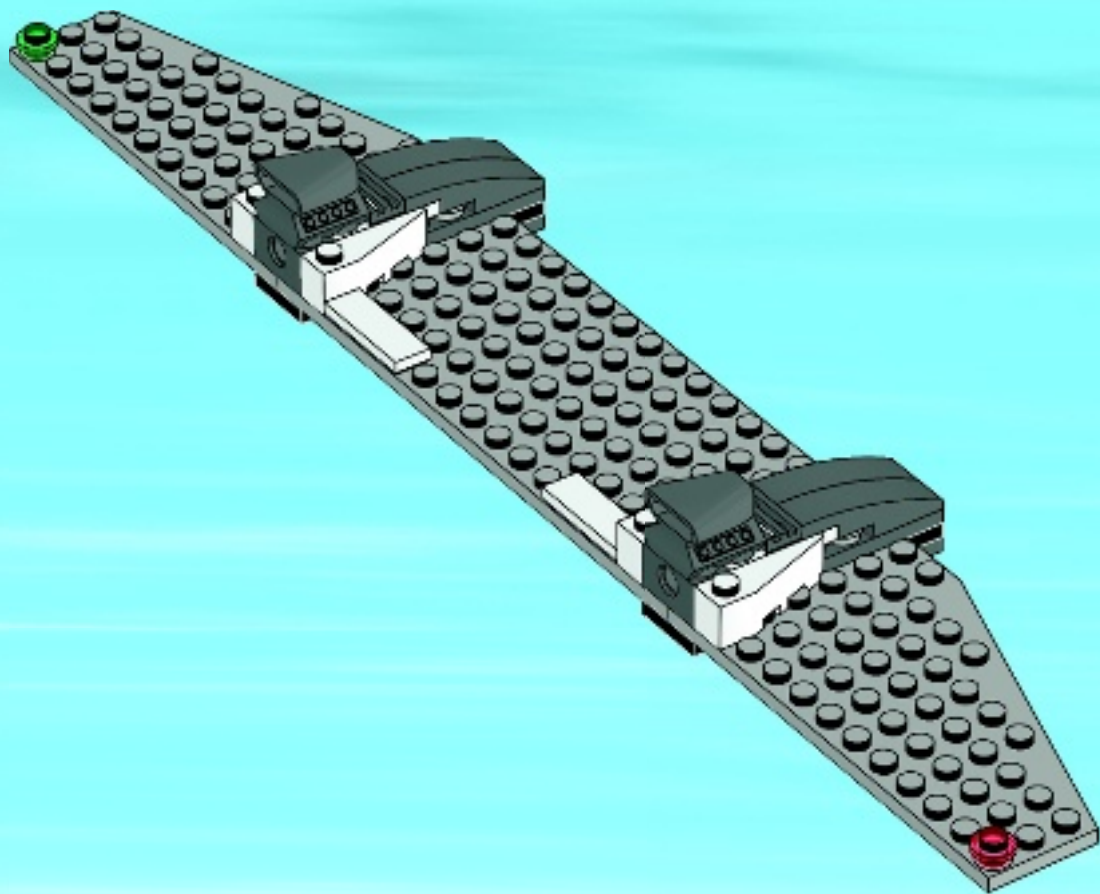

20

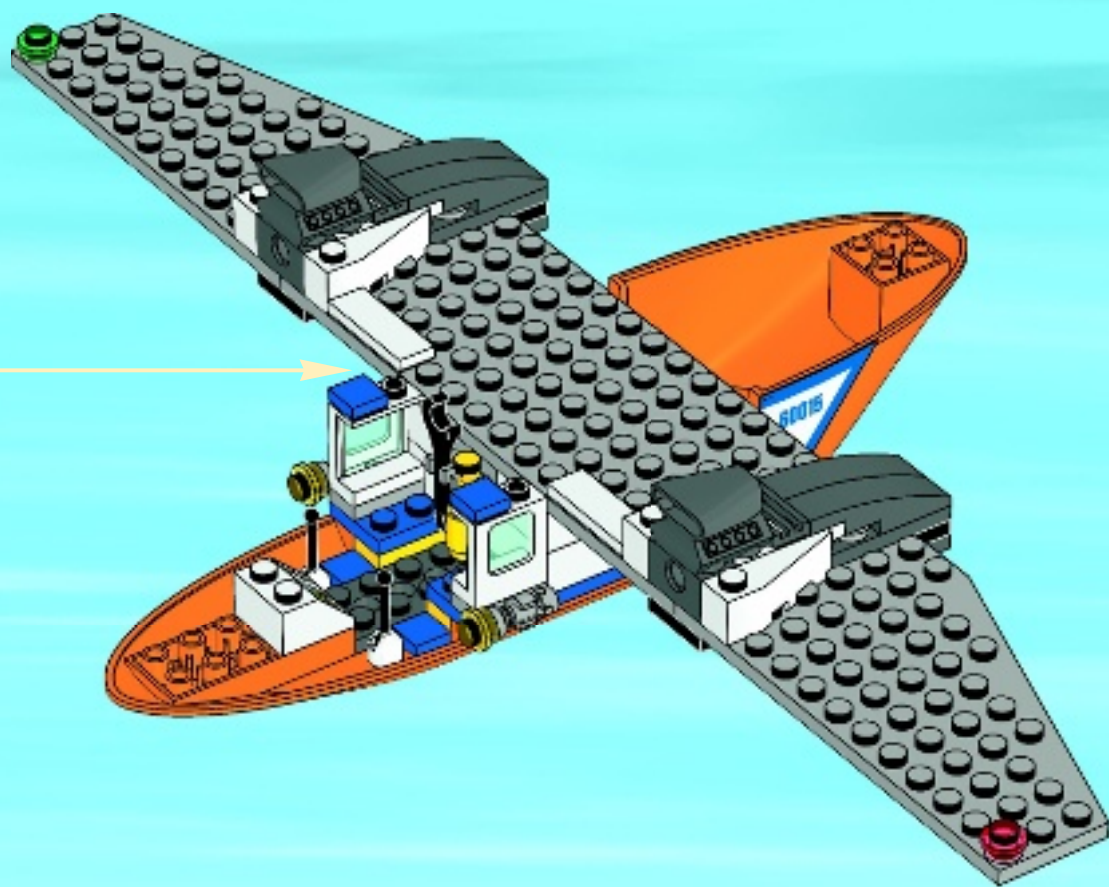



2x



1x



1x

21

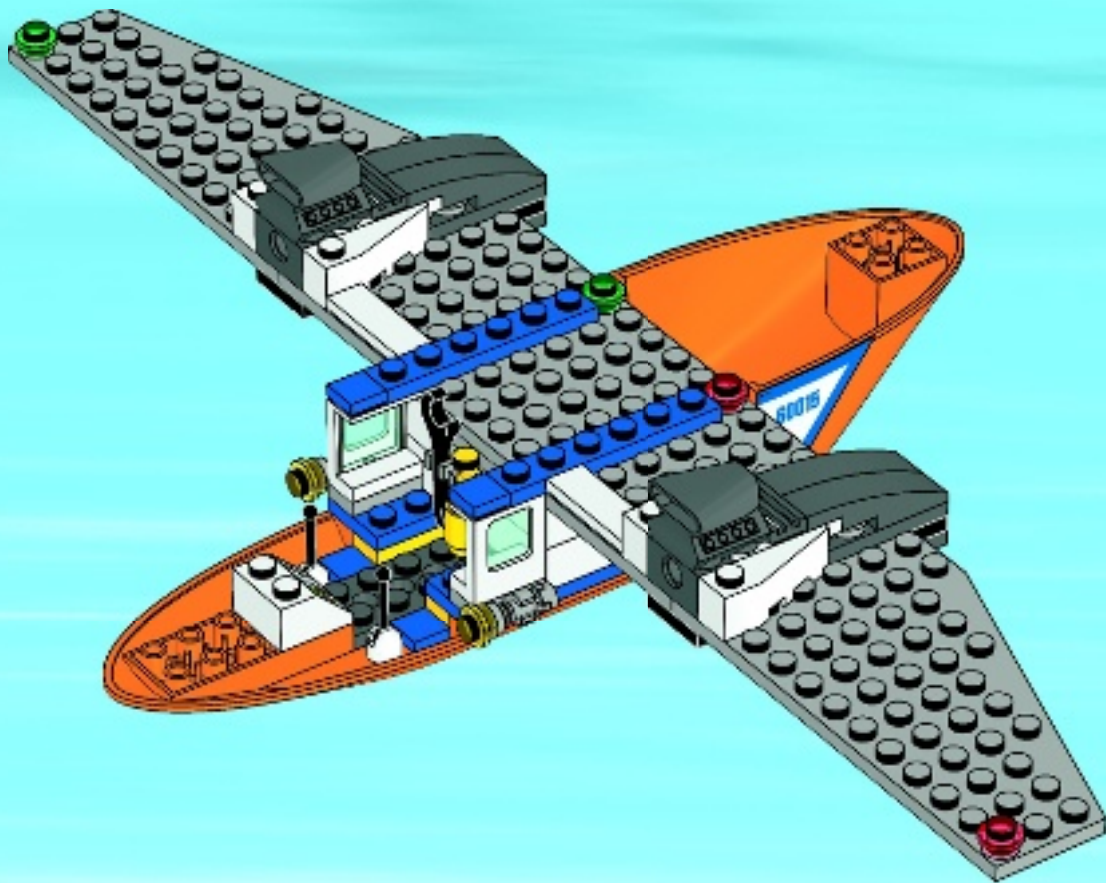

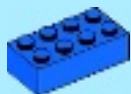

1x



2x

22

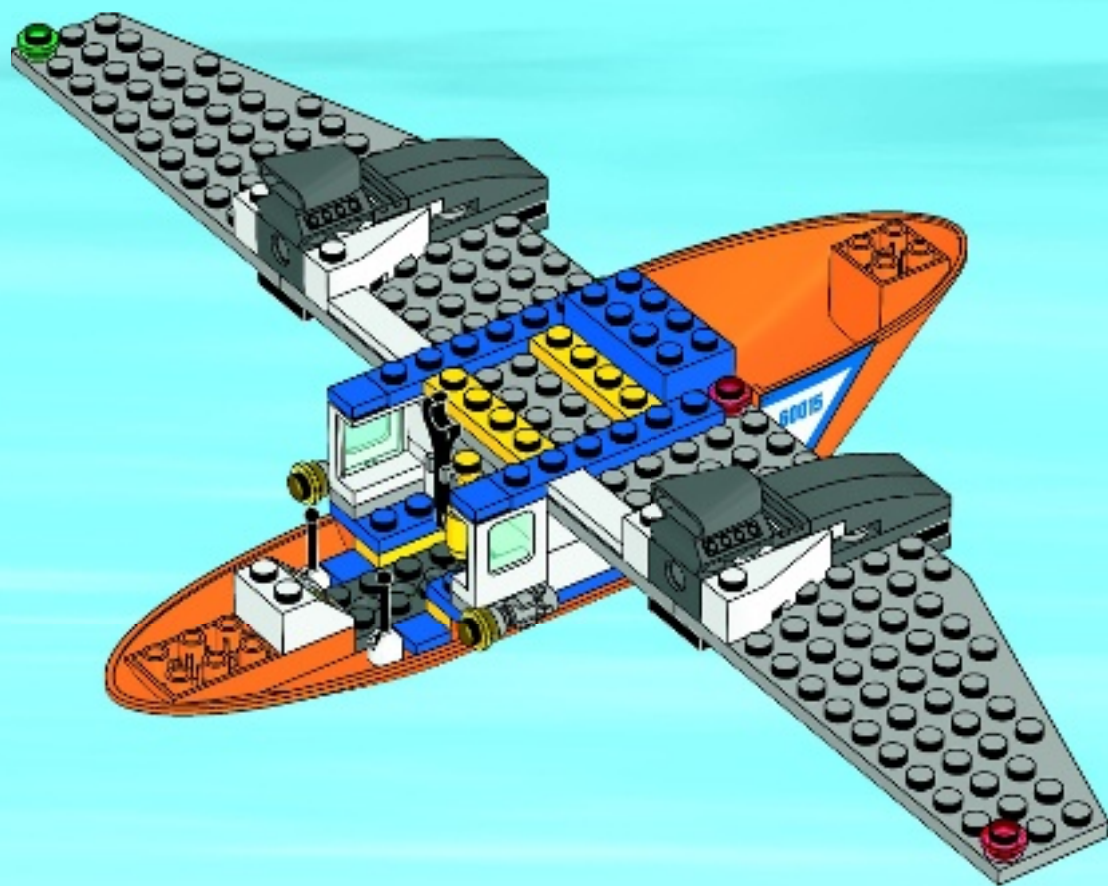

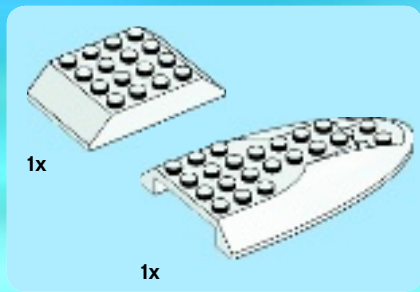

23

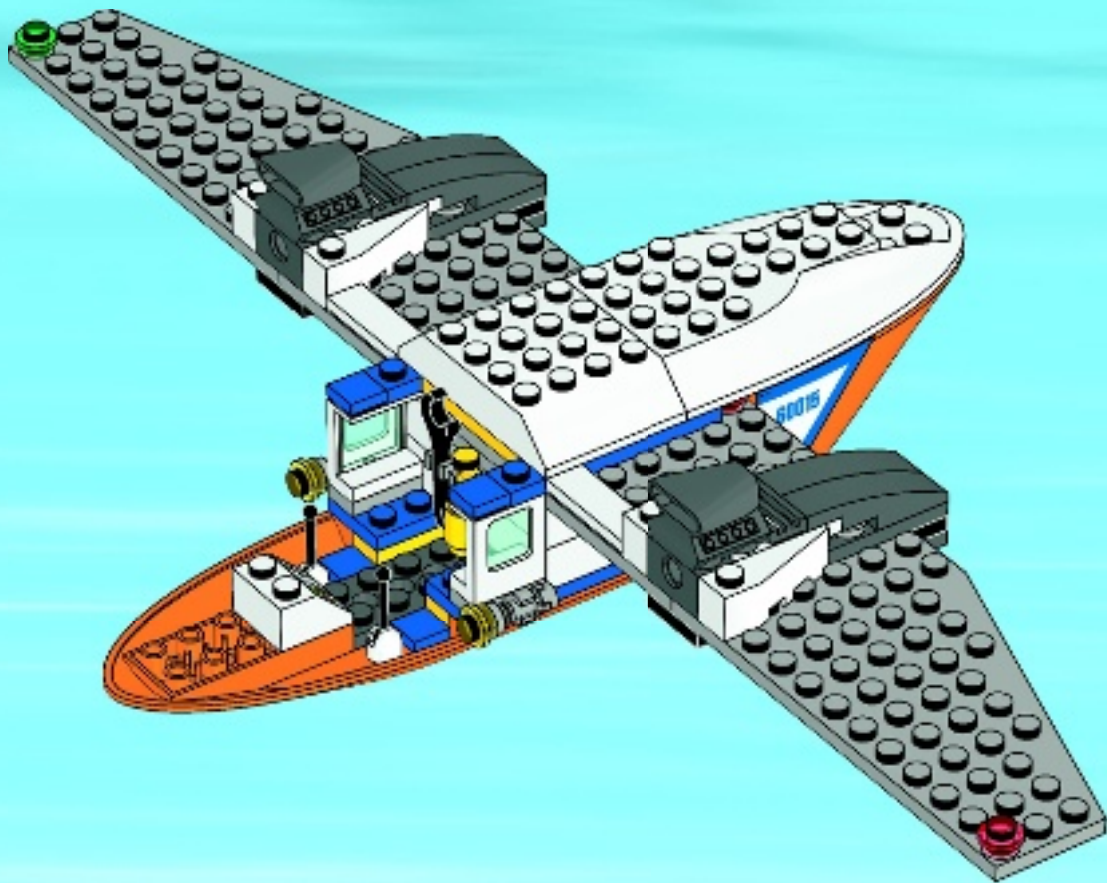

24

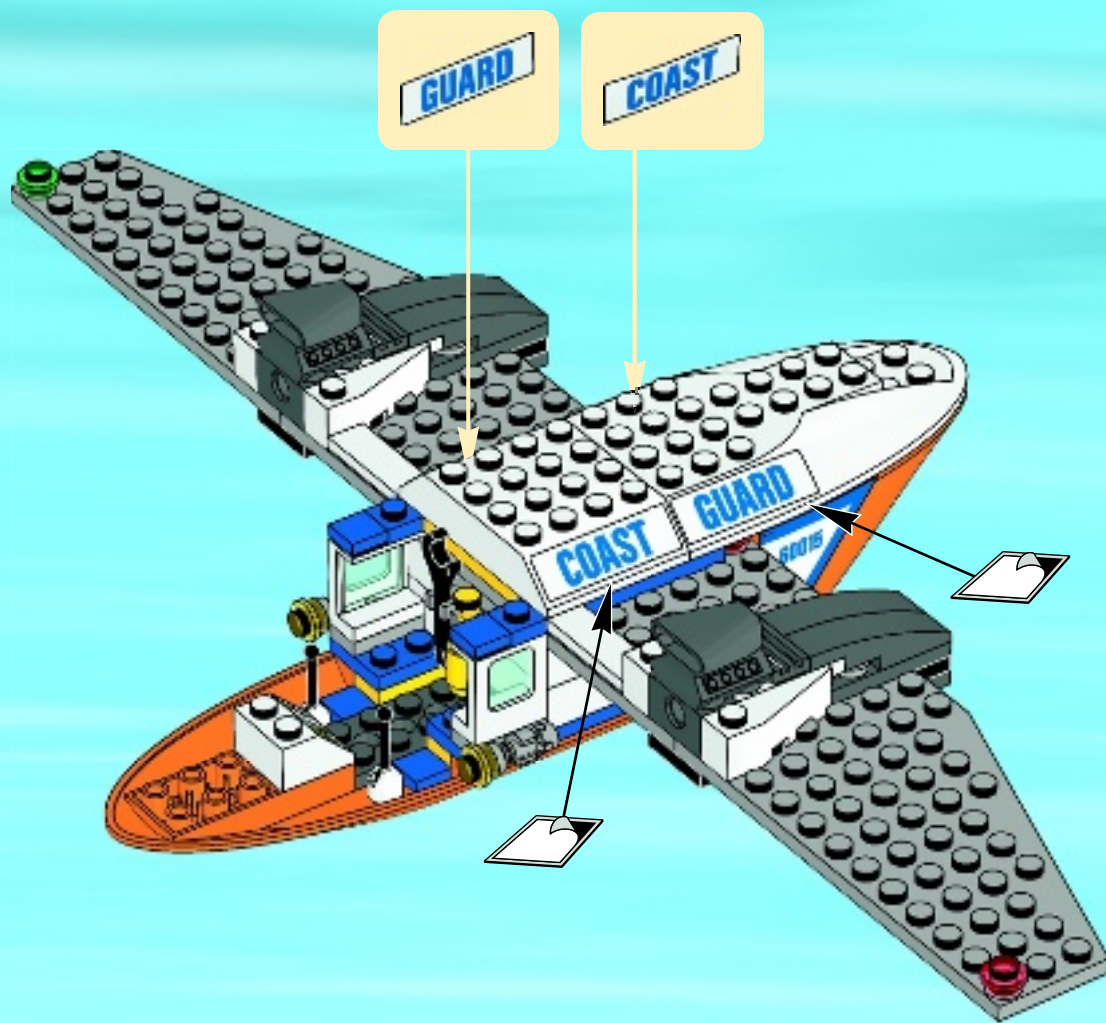

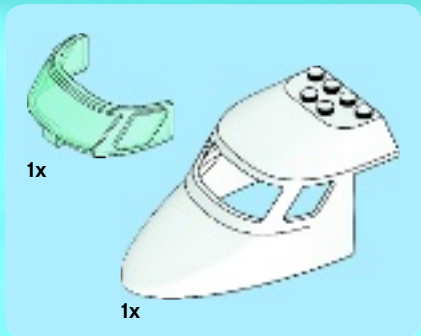

25

1

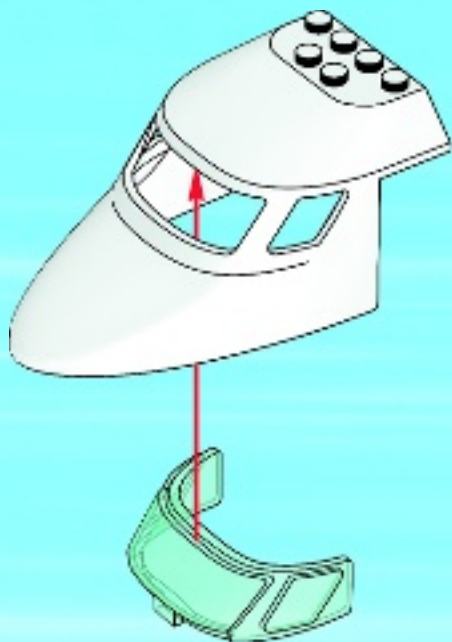

2



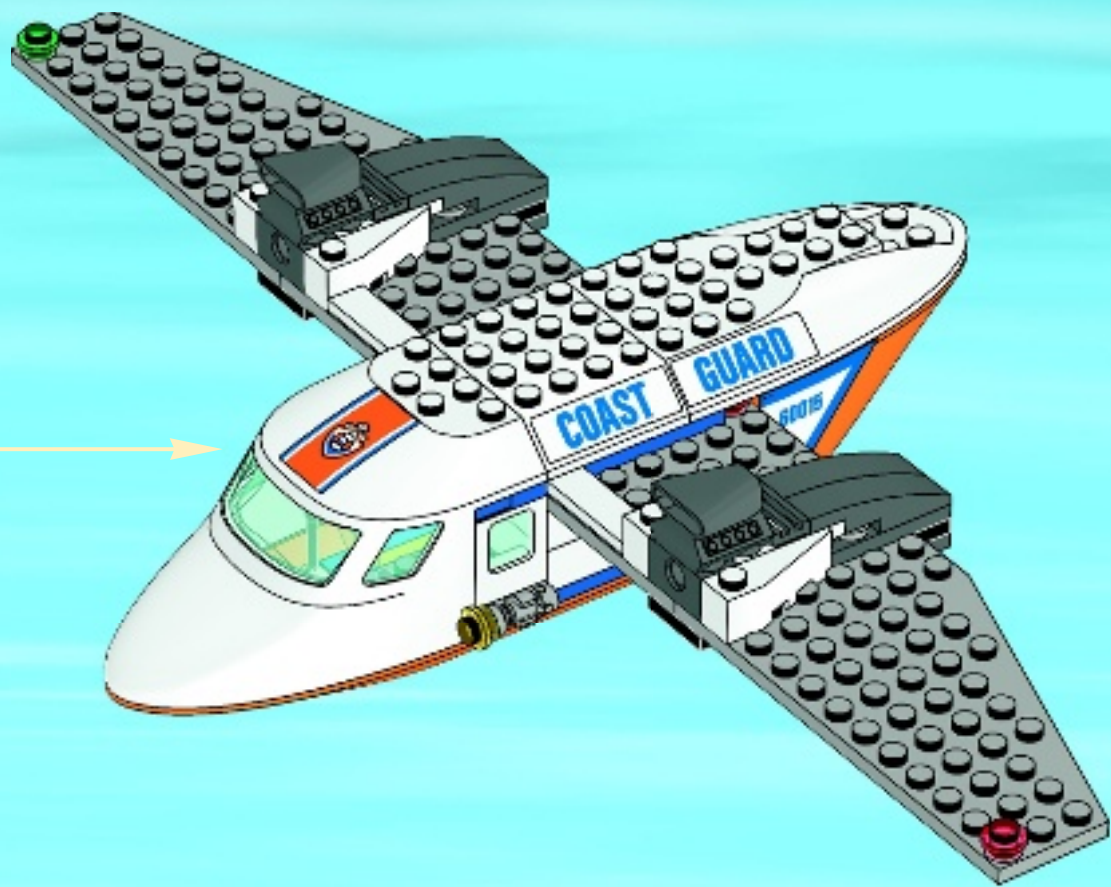

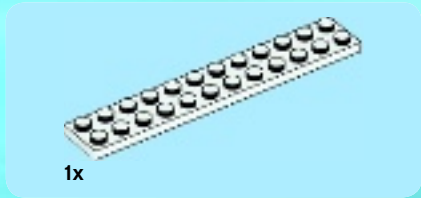

1

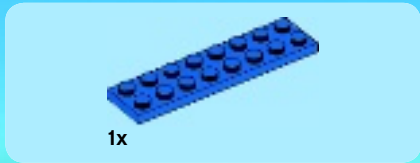
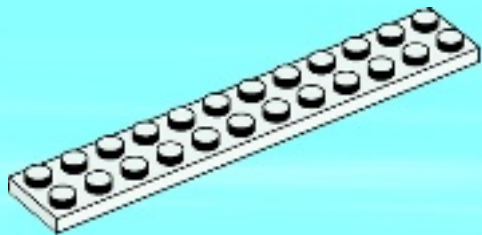

2



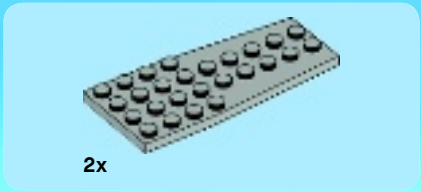

3

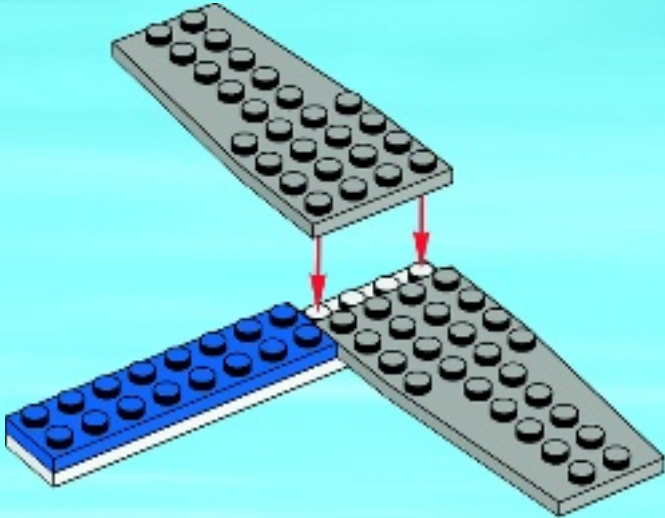



1x

4

1

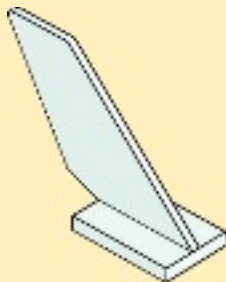

2

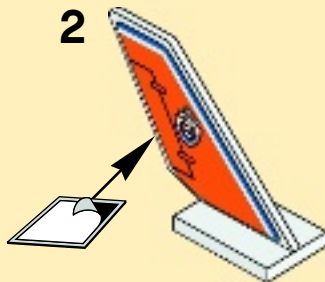

3

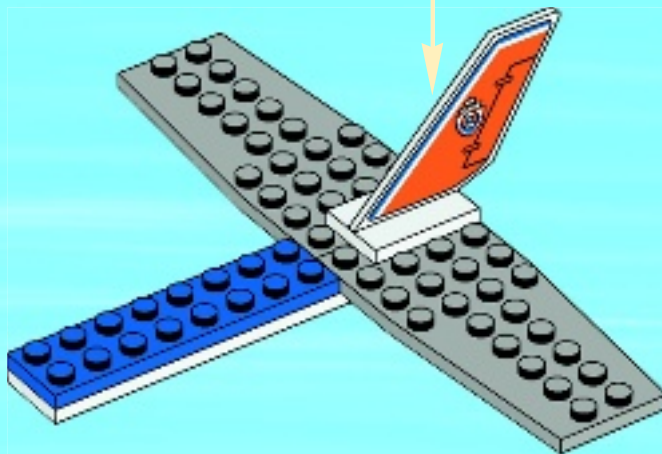
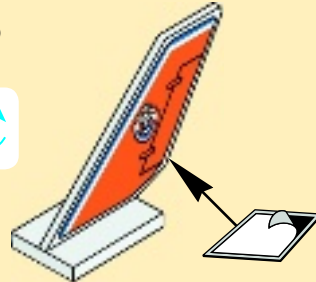



1x



1x



1x

5



26

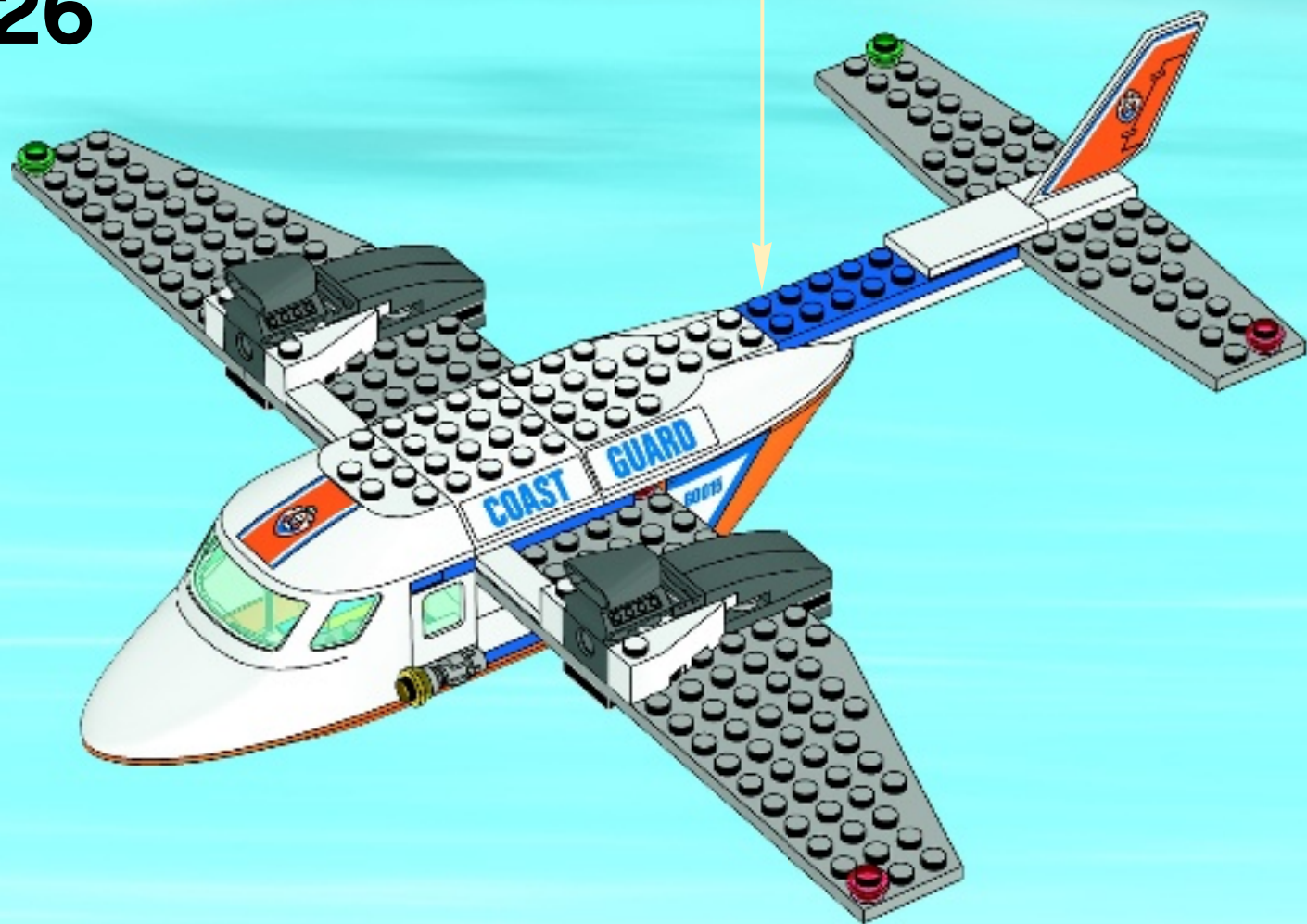

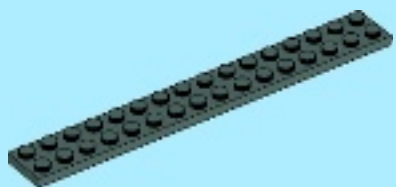

1x

27

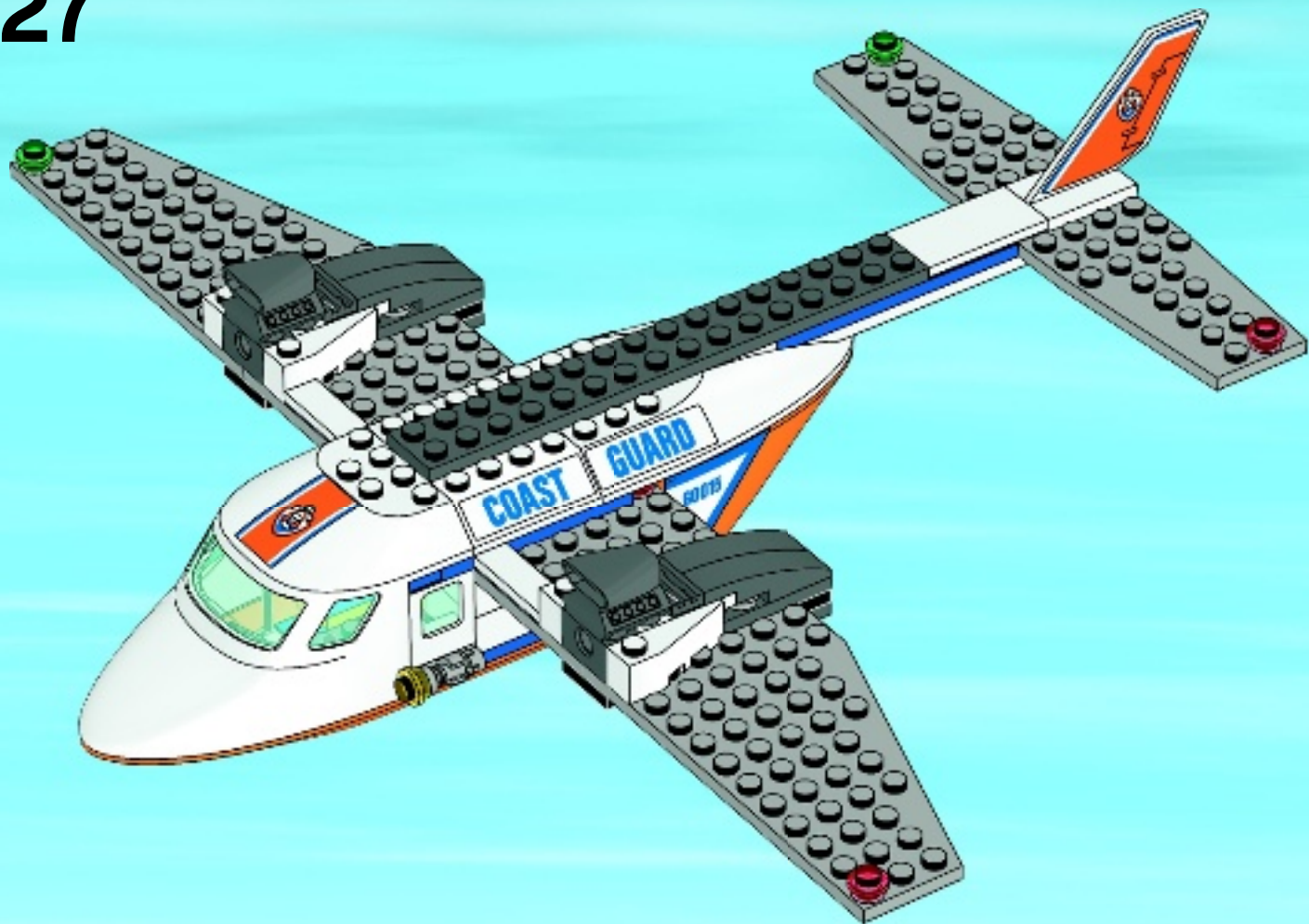



1x



1x

28

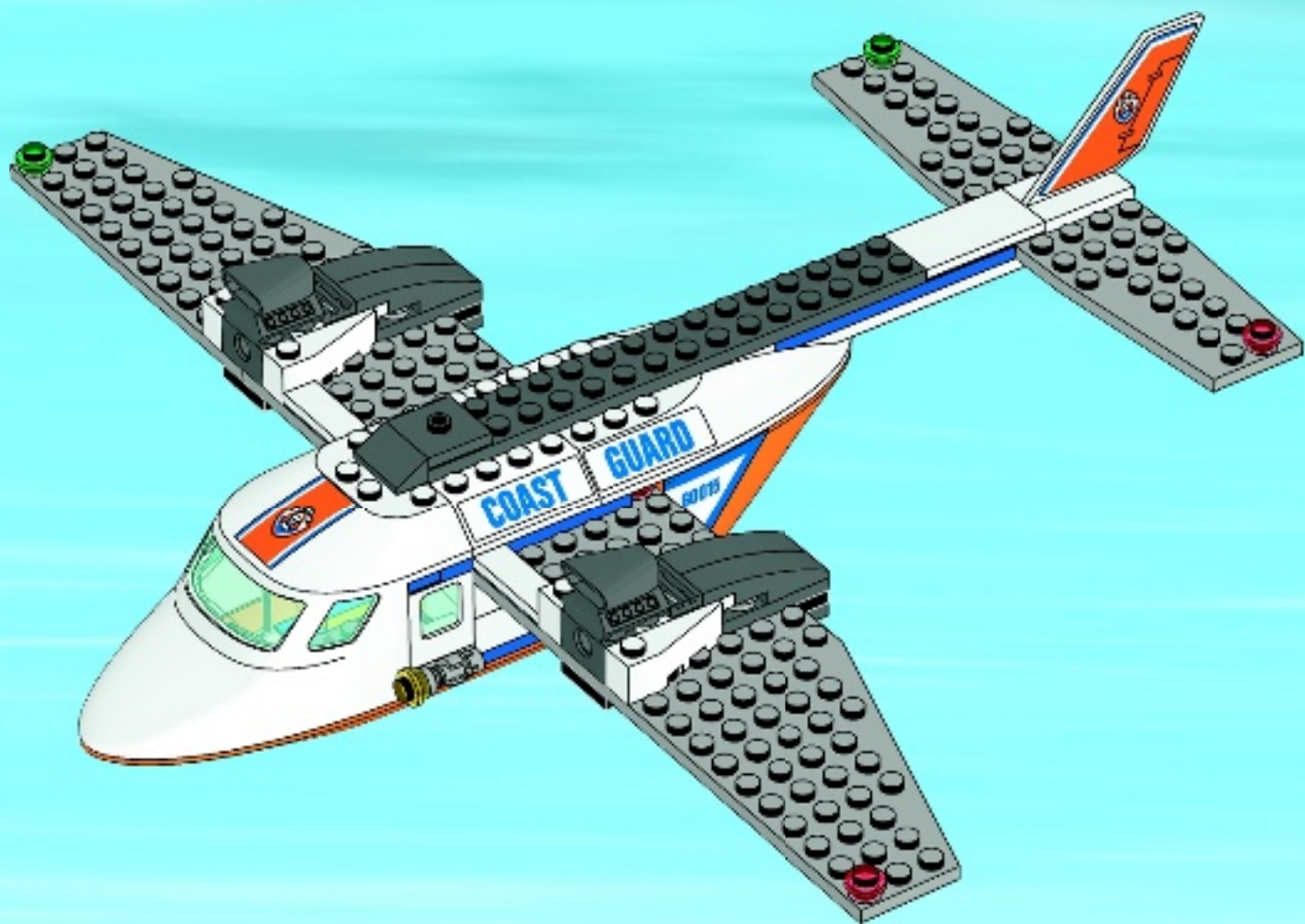



29

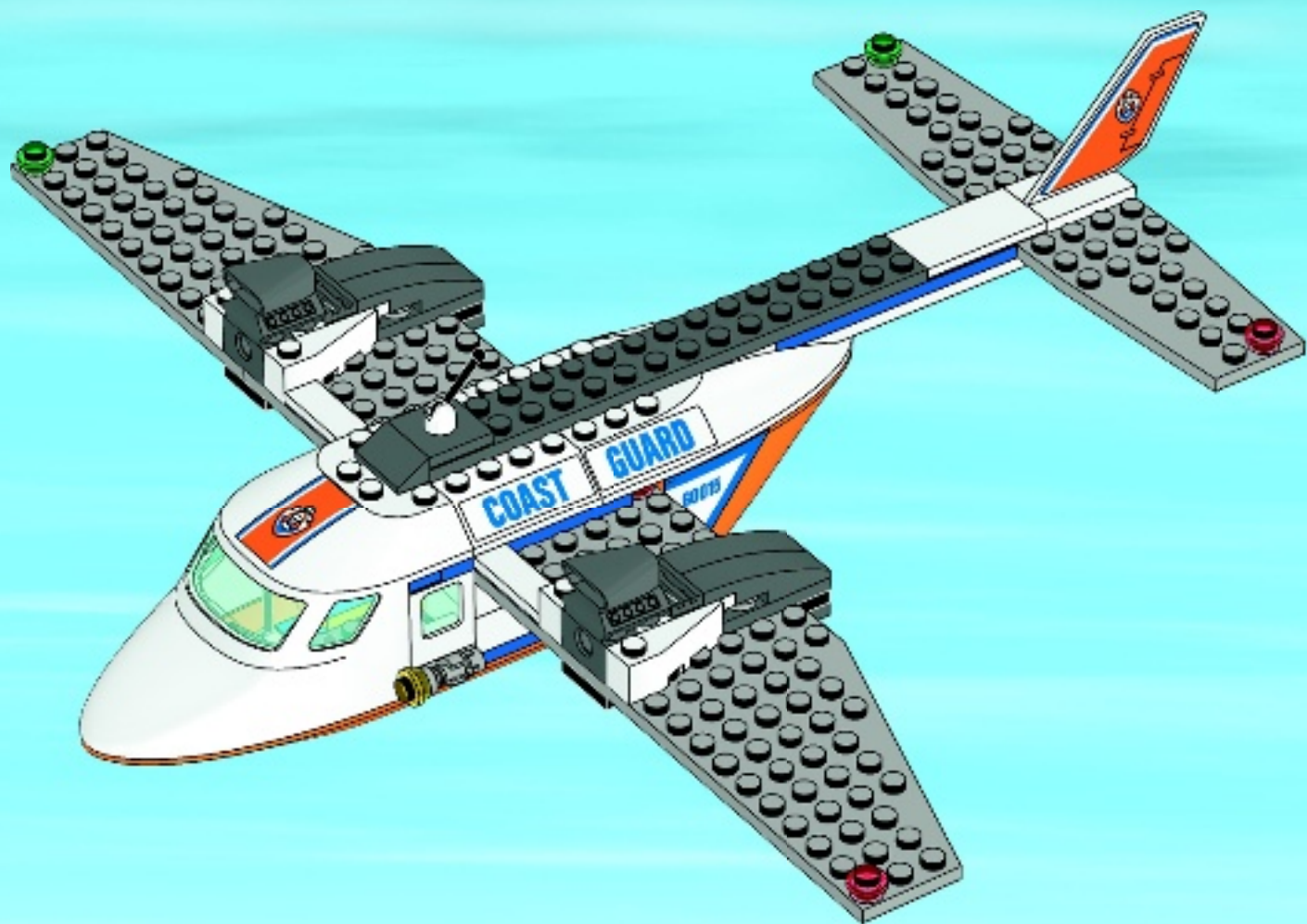



1x

1



1x

2





1x

3



4



1x



2x

30

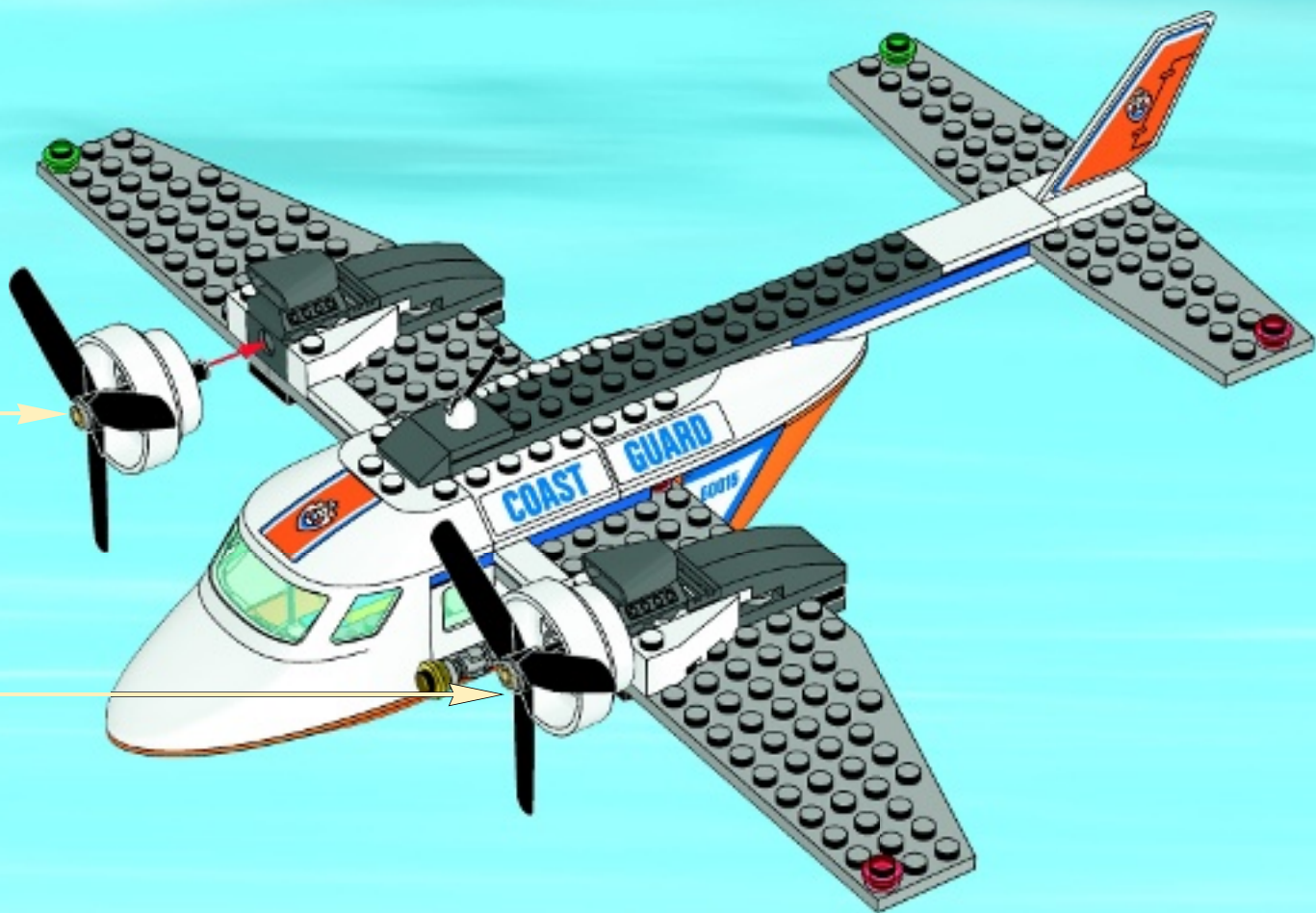

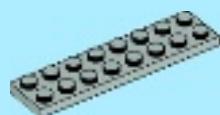

1x

1

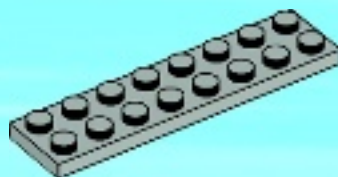



2x

2

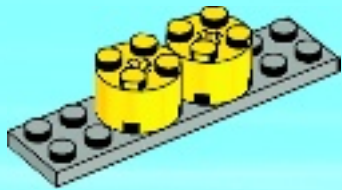

2x

3

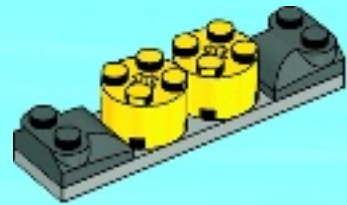

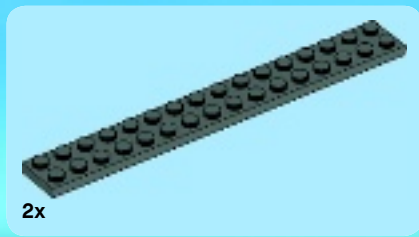

4

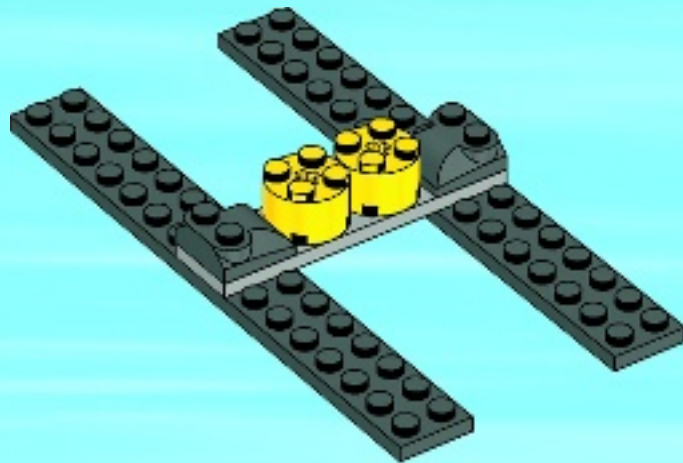



4x

5

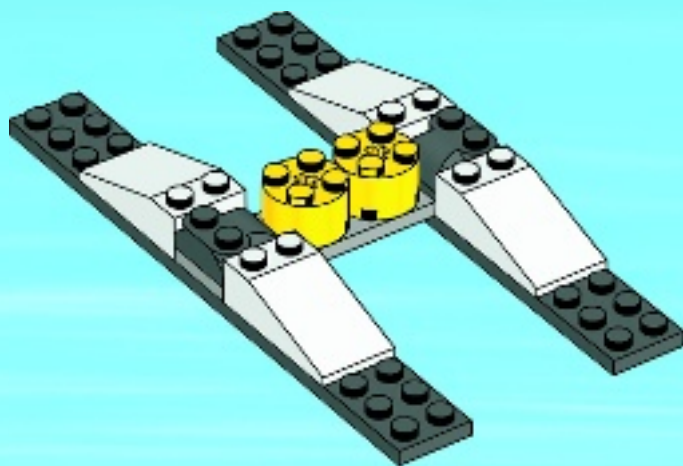



2x

6

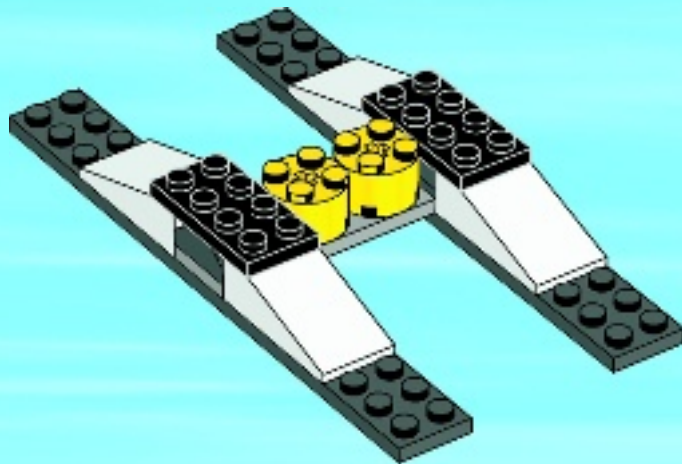



1x

7

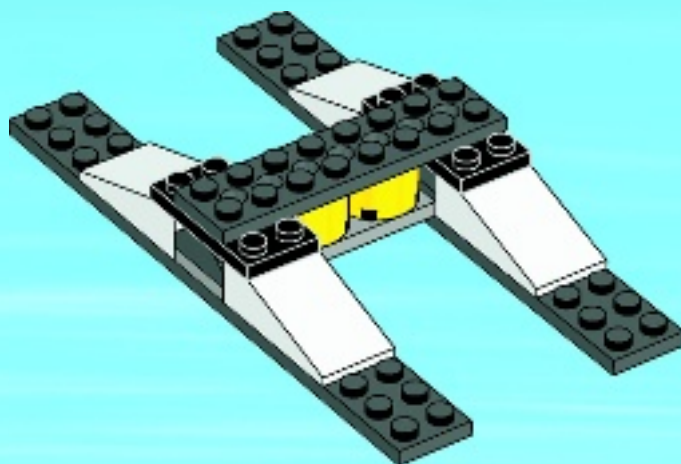



4x

8

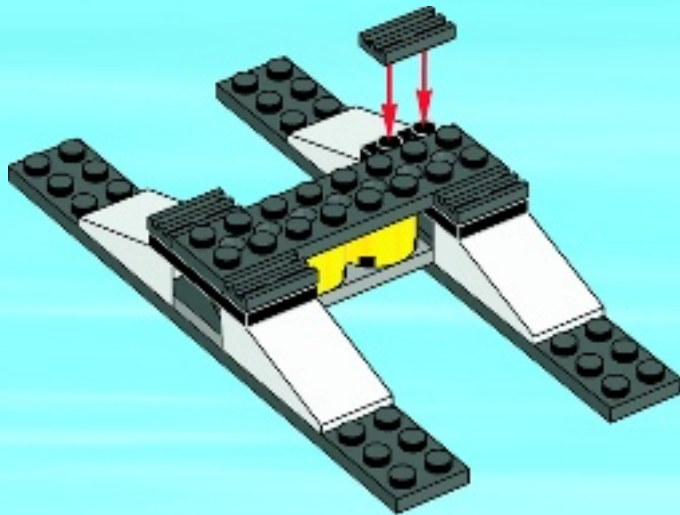



2x

9

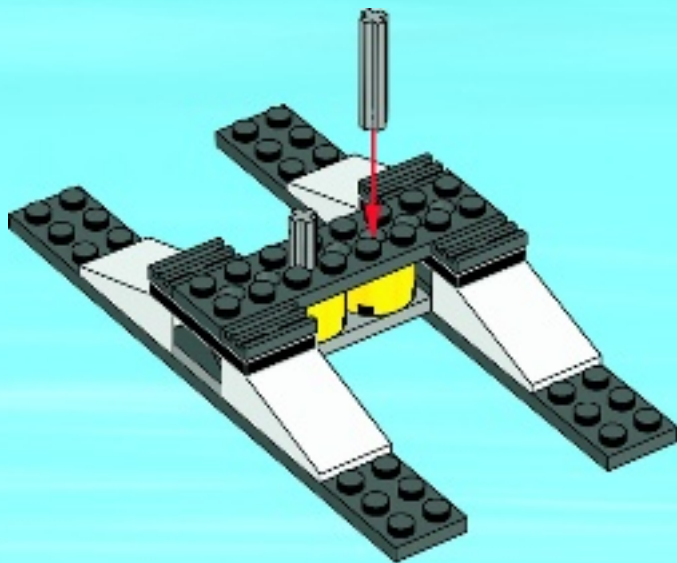



1x

1

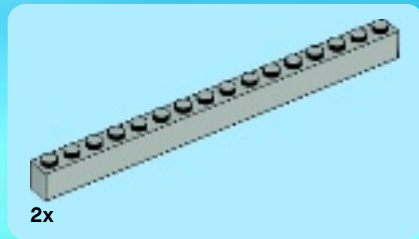
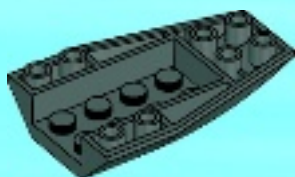

2x

2

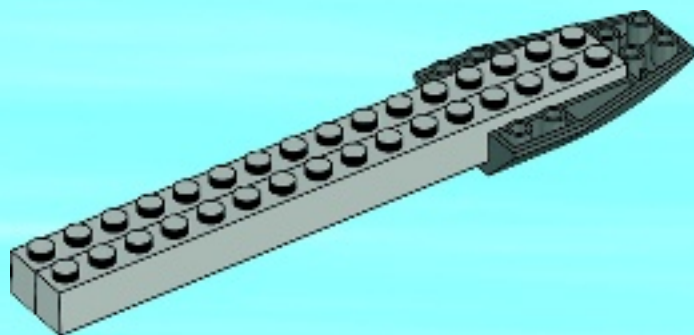



1x

3

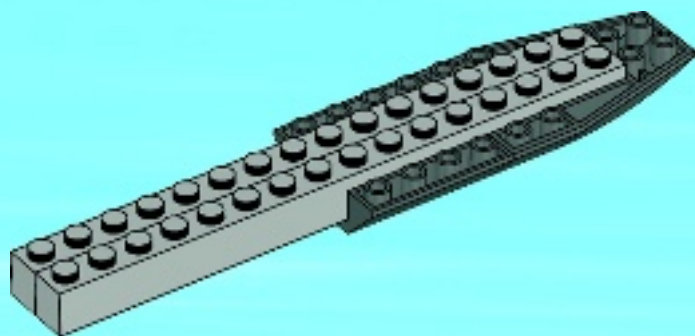



2x

4

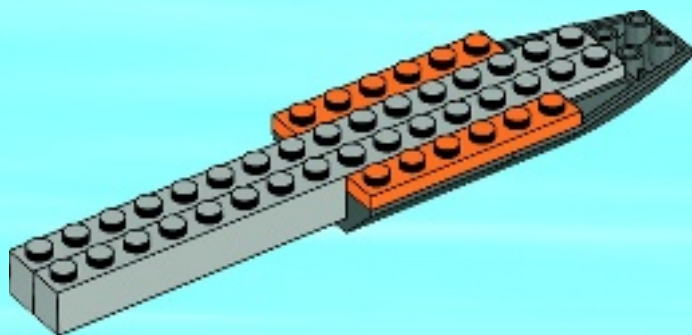



1x



1x

5

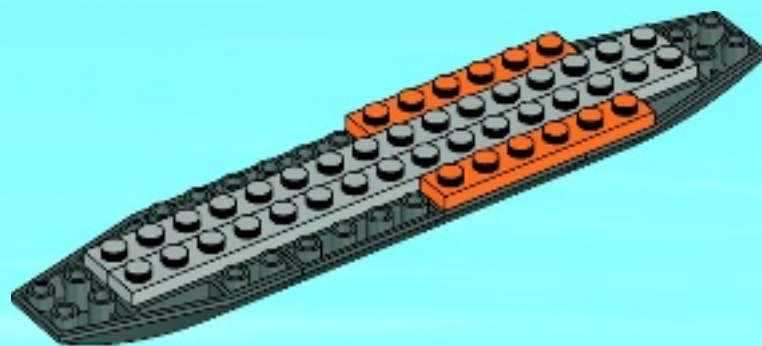



2x

6

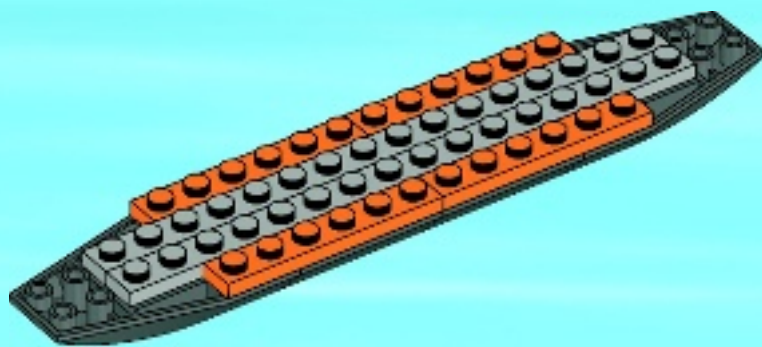



2x

7

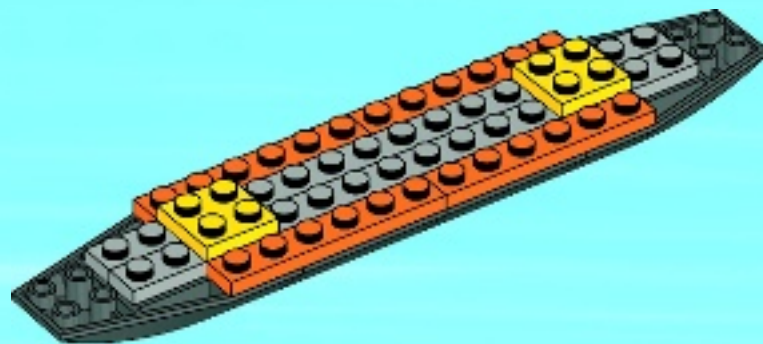



2x

8

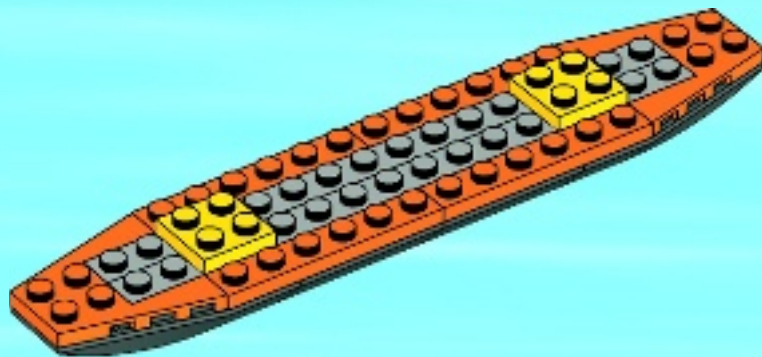

2x

10

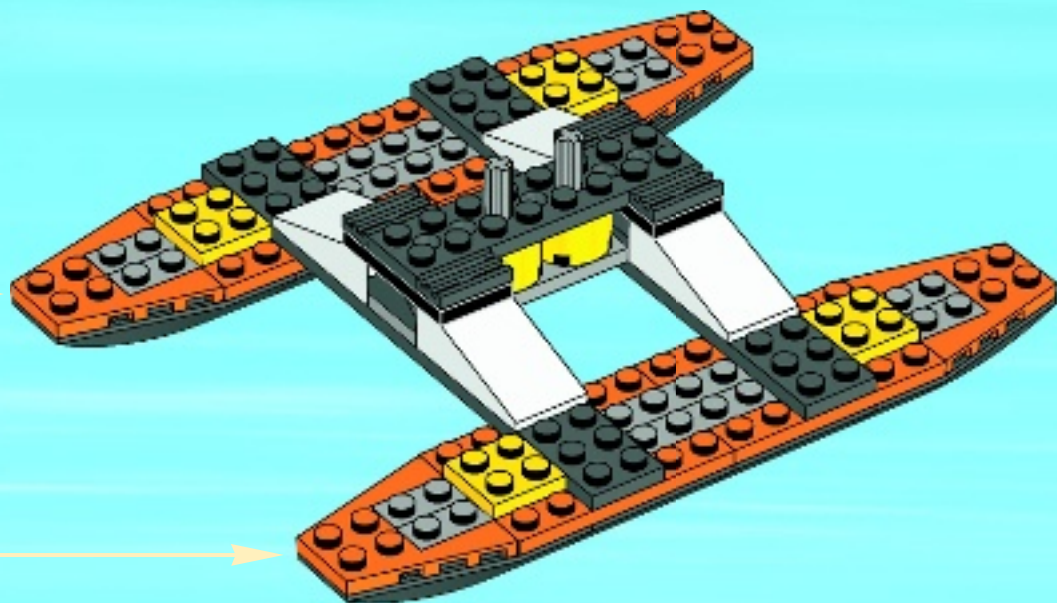



4x

11

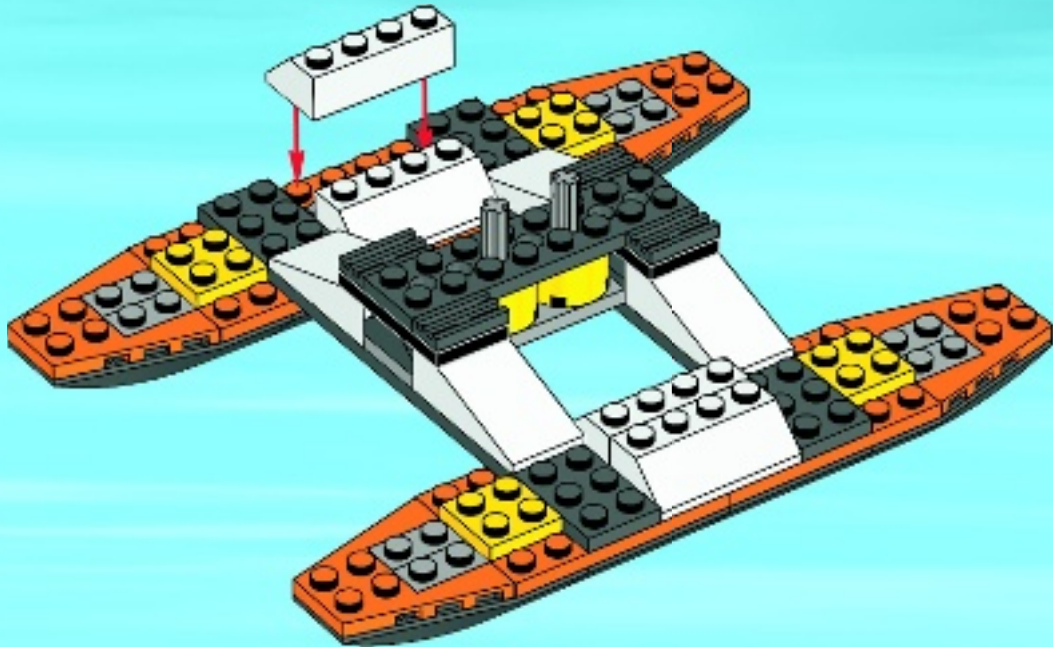



4x

12

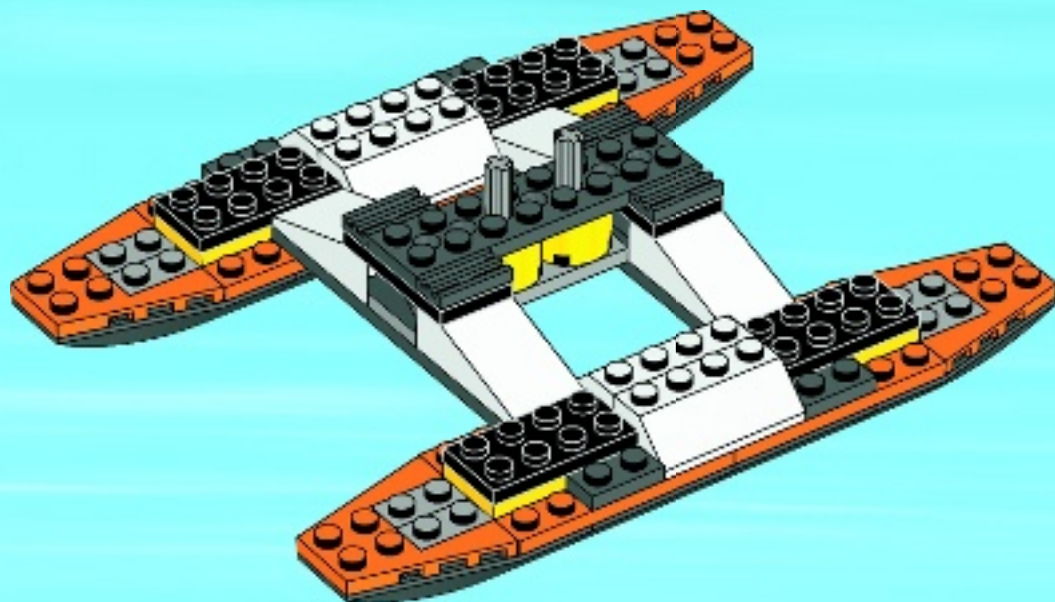



4x

13

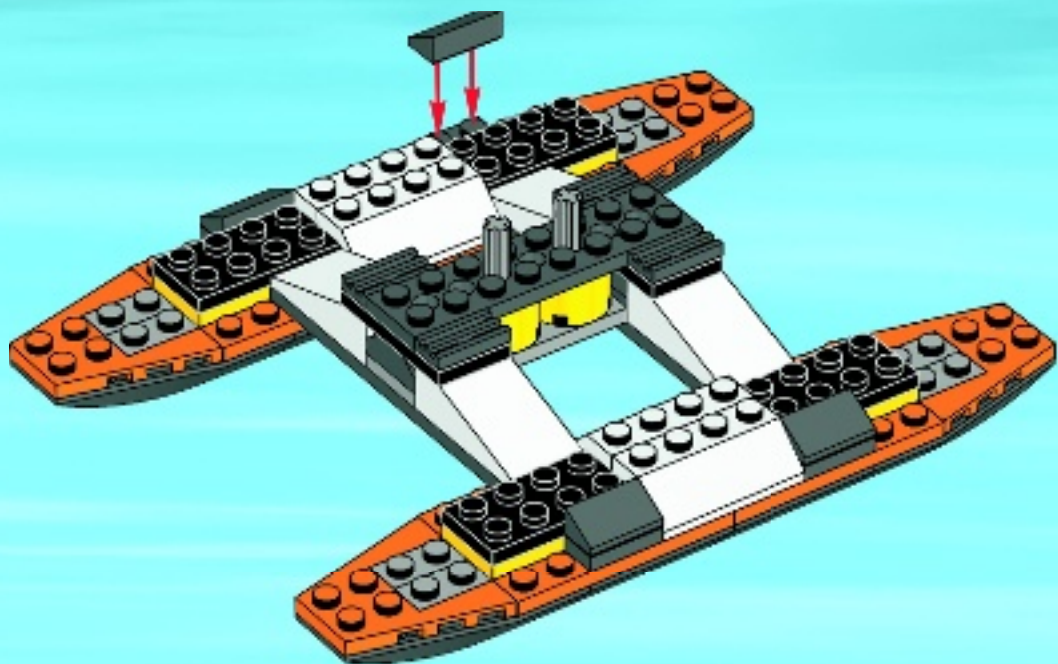



8x

14

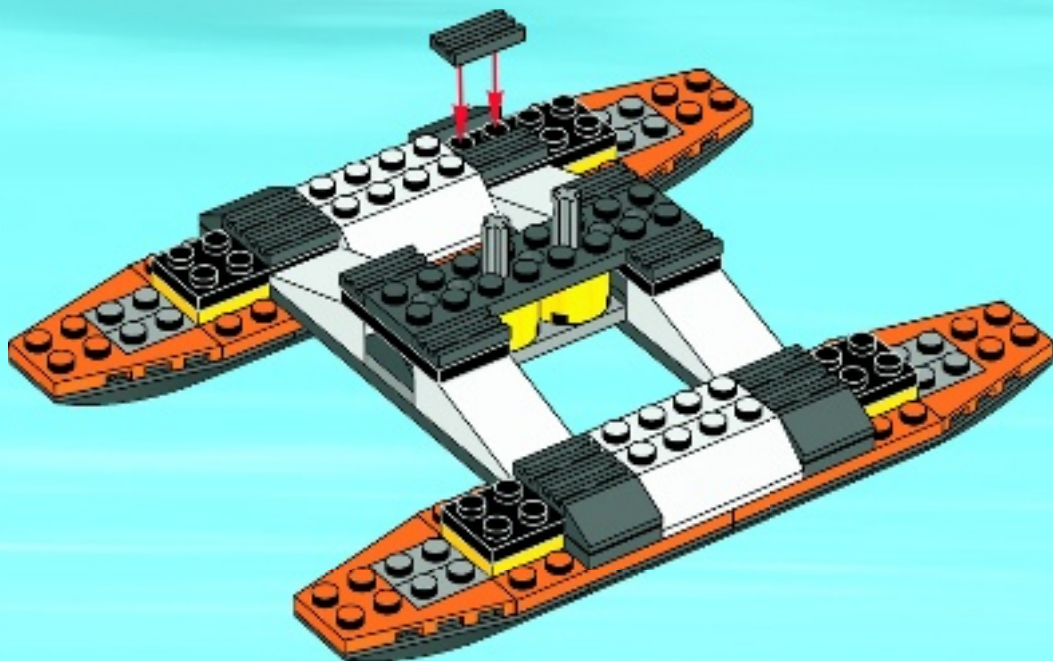



4x

15

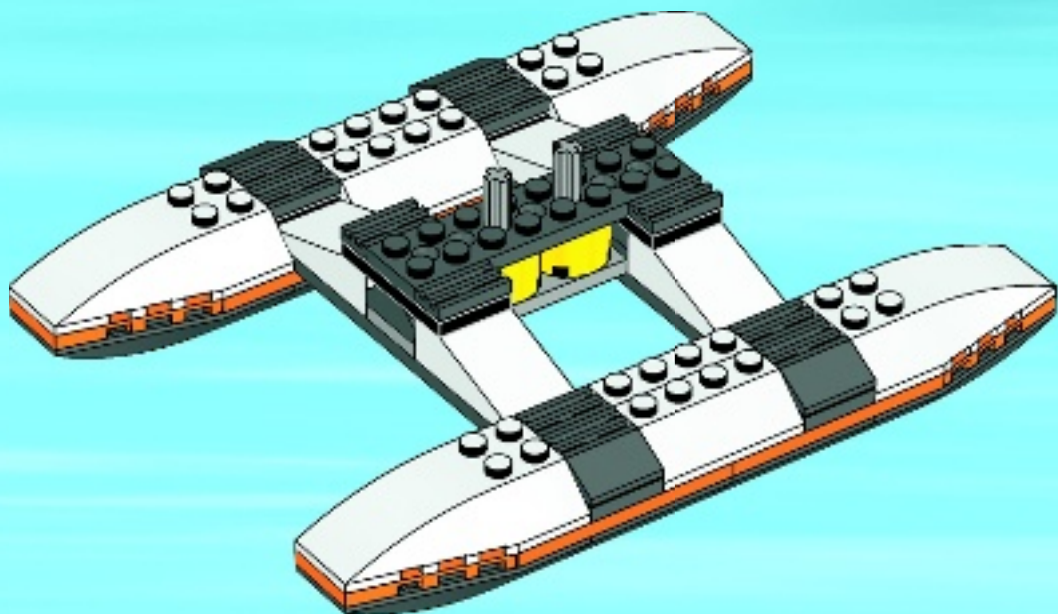

16

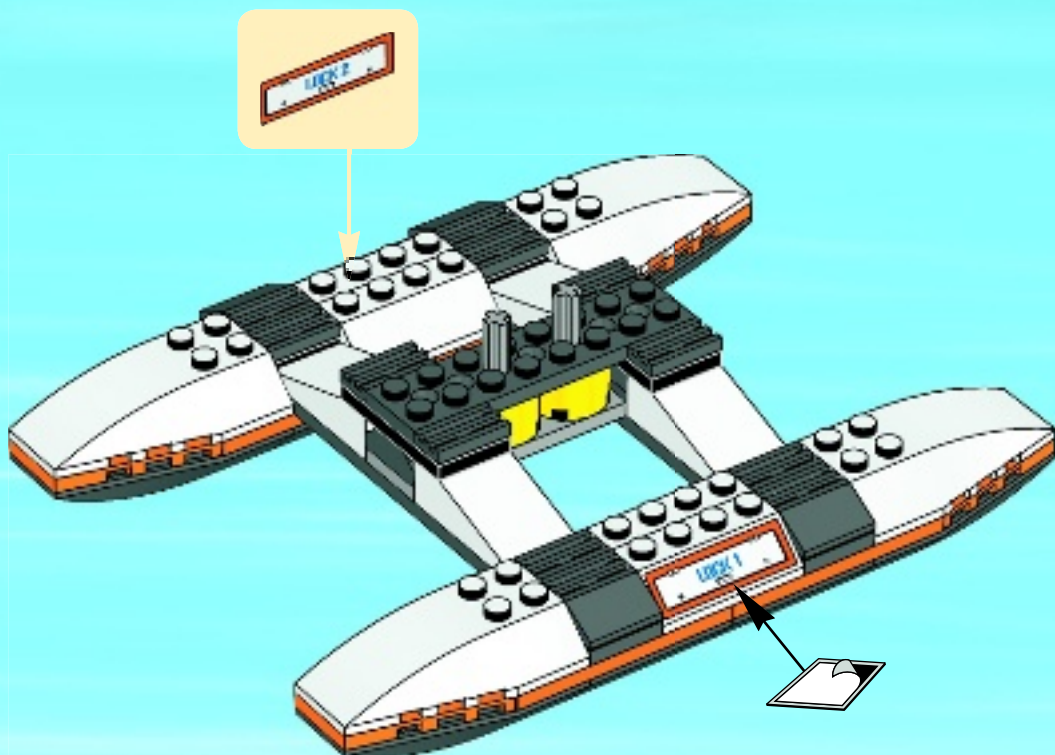

31

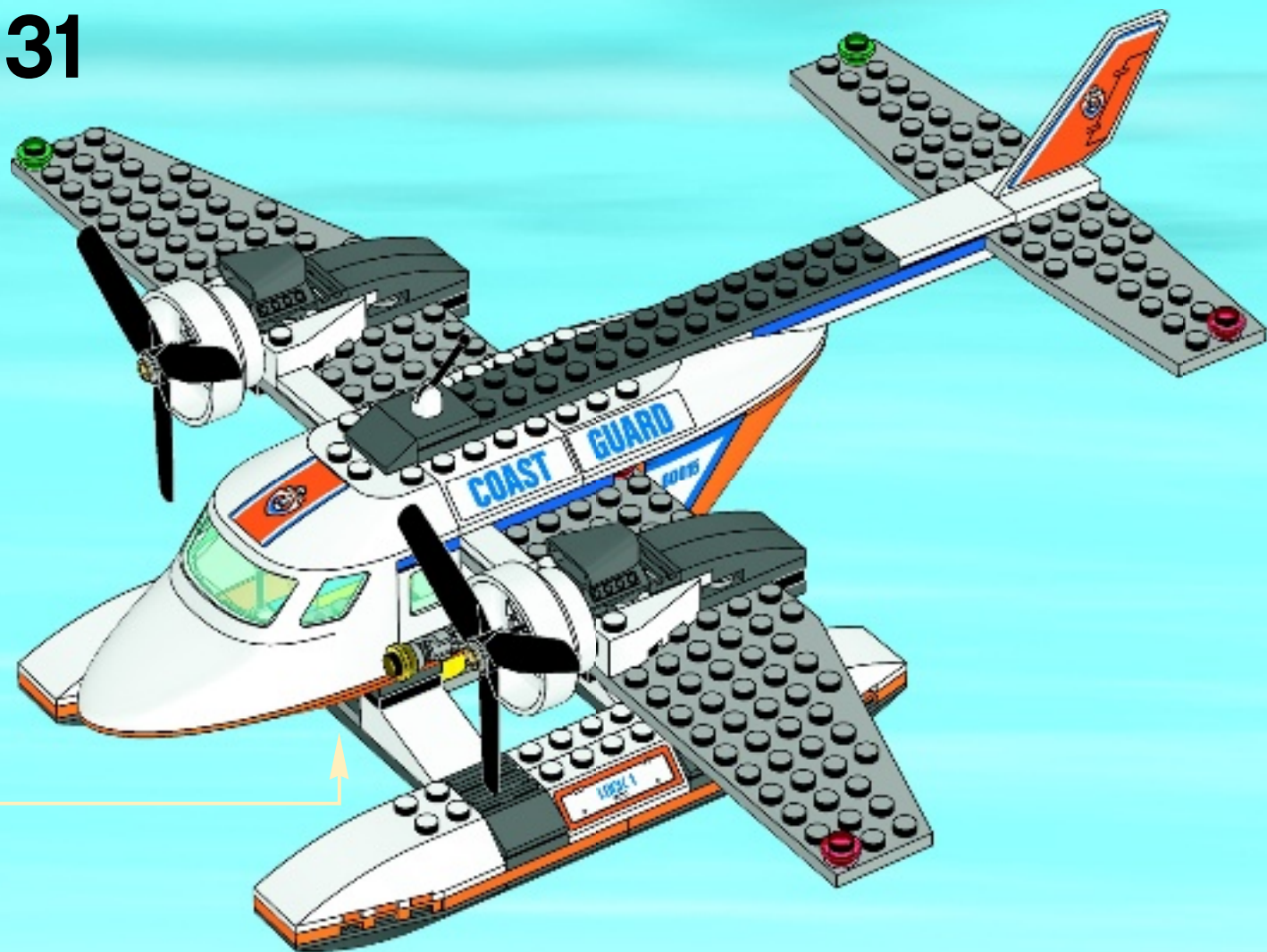

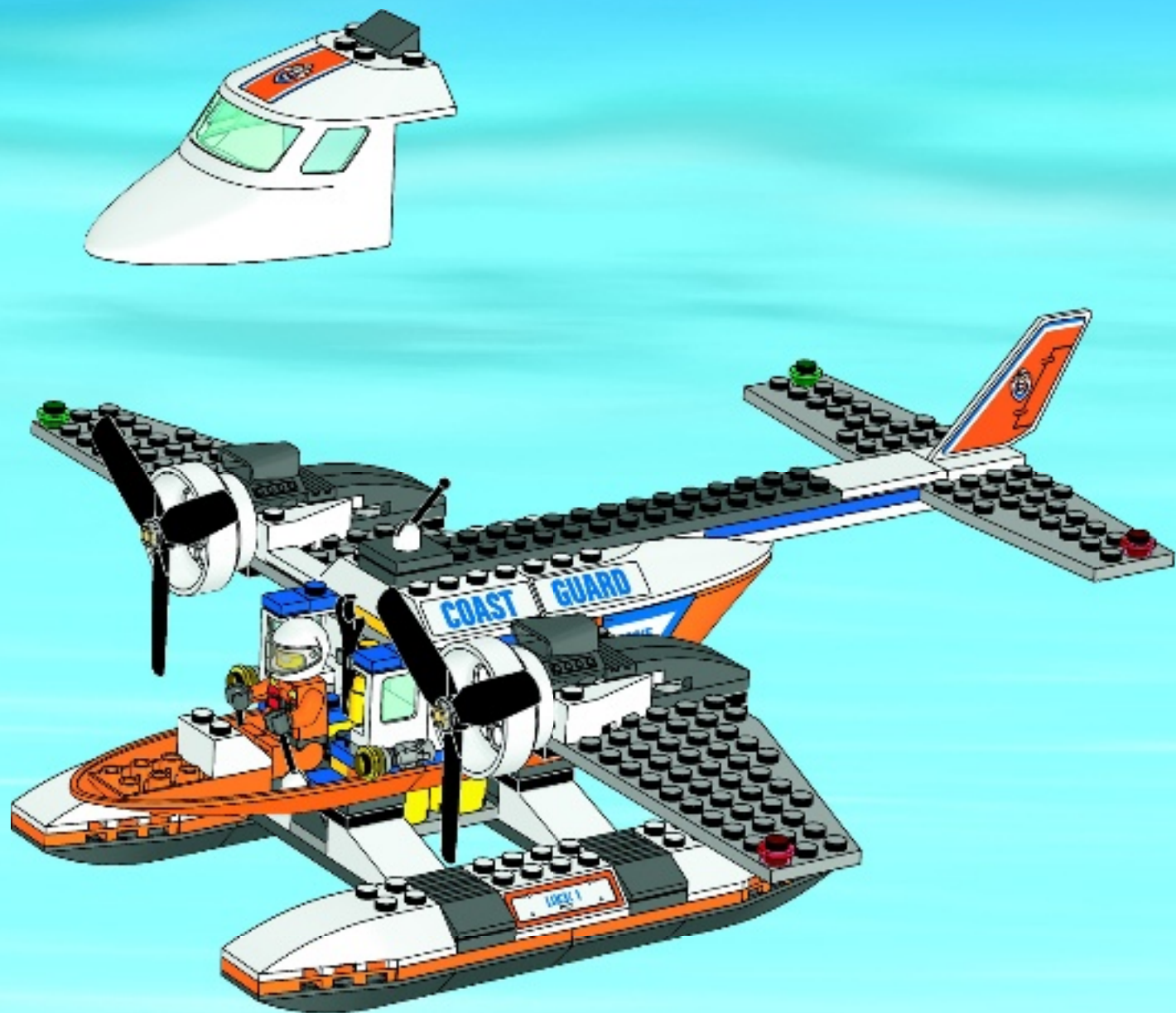



CITY



60014



60013



60012



60011

LEGO CITY

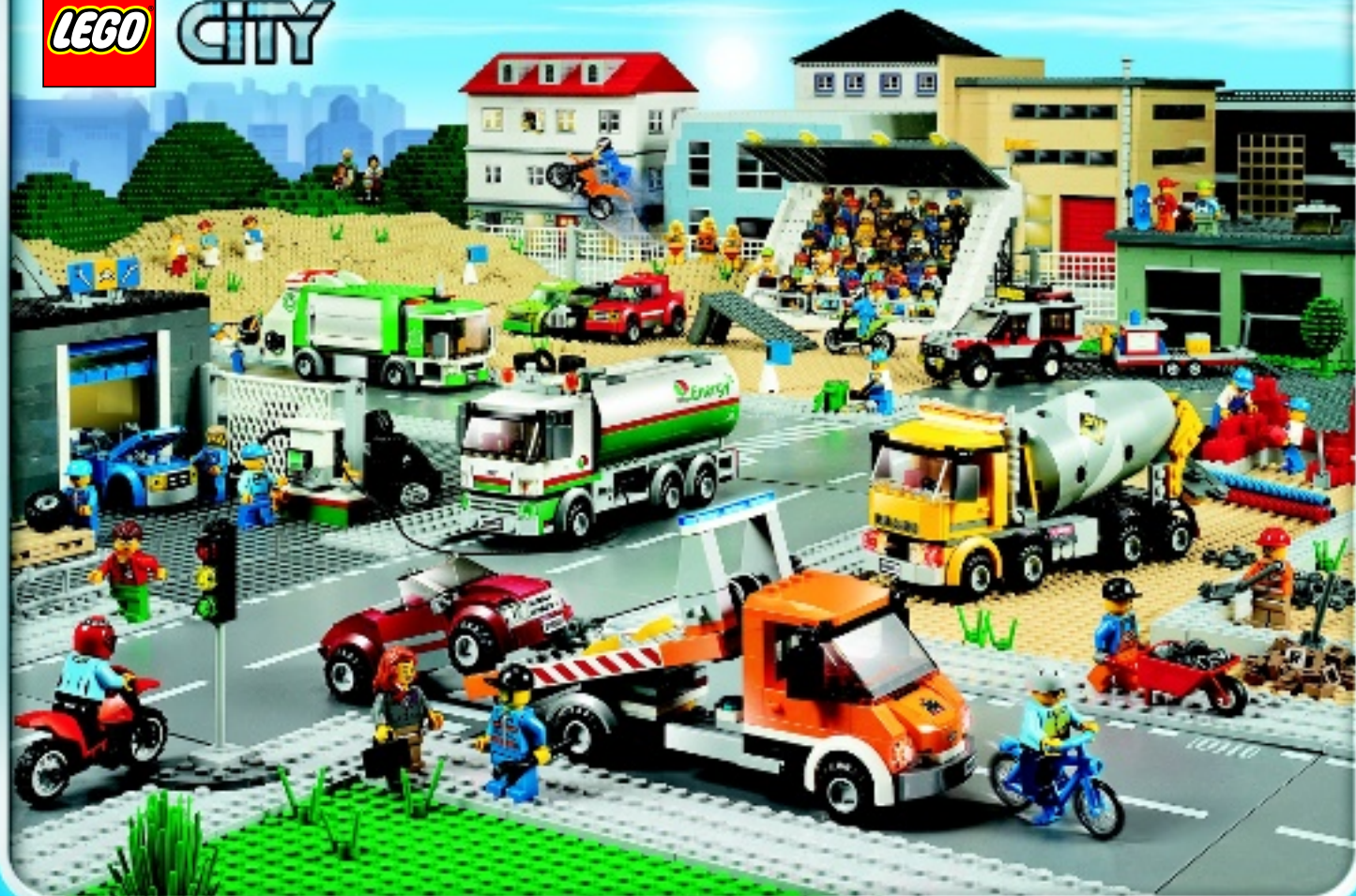

60016



60017



60018



4432



4433

LEGO CITY



60004



60003



60002



60001



60000

2x
300401



5x
4181142



2x
4563684



2x
4614247



2x
446001



1x
6032098



4x
303701



4x
4143000



1x
4568156



4x
4179869

78



2x
302101



1x
244501



2x
241201



2x
4558168



1x
4560178



1x
474001



2x
4507685



4x
73737



1x
4298609



1x
9551



2x
4512751

623901



1x
4560934



1x
4560932



2x
4666579



1x
300123

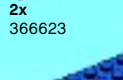

2x
366623

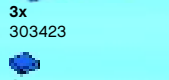

3x
303423



4x
4206330



1x
9341



1x
4143005



1x
306224

614324

2x
614324

4x
302224



2x
371024

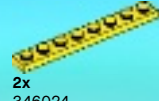

2x
346024



2x
403224



1x
4256320



1x
6022320



1x
4262093



1x
4506998



4x
4581280



4x
302326



4x
362326



8x
302026

366626

1x
366626

4x
4632571

2x
4515340



3x
243226

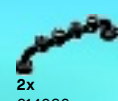

2x
614026



2x
6006739



1x
4540274



2x
4656122



1x
400626



2x
384926



2x
4142731



2x
4158848



2x
4297719



2x
4140801



2x
6021539

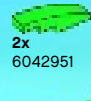

2x
6042951

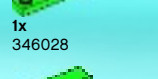

1x
346028



2x
243128



1x
4244363



3x
3005741



2x
4183544



2x
6023948



2x
4155537



1x
4567994



1x
6009015

3005744

2x
3005744

1x
4244573

3x
3005748

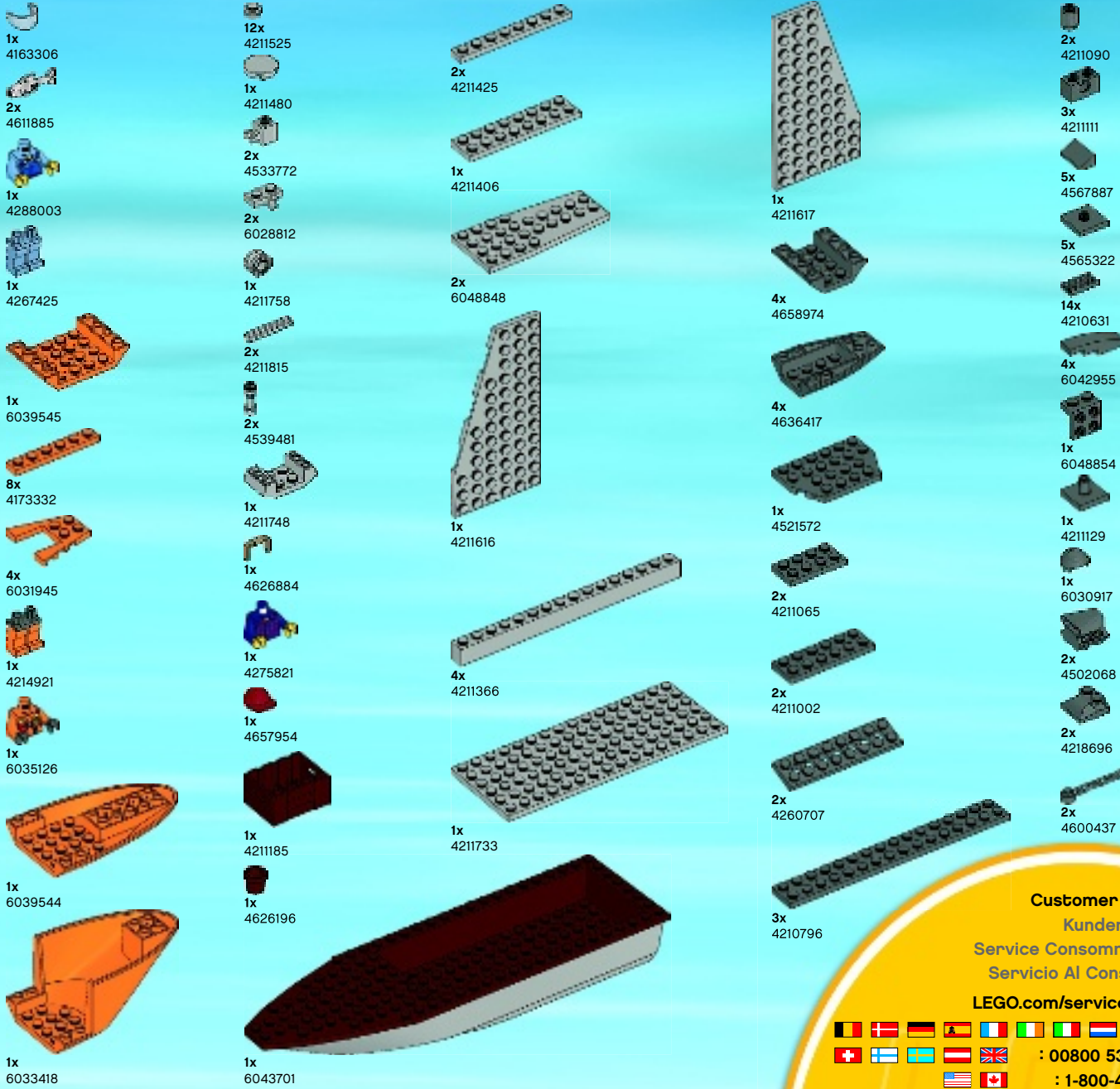

- 1x 4163306
- 2x 4611885
- 1x 4288003
- 1x 4267425
- 1x 6039545
- 8x 4173332
- 4x 6031945
- 1x 4214921
- 1x 6035126
- 1x 6039544
- 1x 6033418
- 12x 4211525
- 1x 4211480
- 2x 4533772
- 2x 6028812
- 1x 4211758
- 2x 4211815
- 2x 4539481
- 1x 4211748
- 1x 4626884
- 1x 4275821
- 1x 4657954
- 1x 4211185
- 1x 4626196
- 2x 4211425
- 1x 4211406
- 2x 6048848
- 1x 4211616
- 4x 4211366
- 1x 4211733
- 1x 6048854
- 1x 4211617
- 4x 4658974
- 4x 4636417
- 1x 4521572
- 2x 4211065
- 2x 4211002
- 2x 4260707
- 3x 4210796
- 2x 4211090
- 3x 4211111
- 5x 4567887
- 5x 4565322
- 14x 4210631
- 4x 6042955
- 1x 6048854
- 1x 4211129
- 1x 6030917
- 2x 4502068
- 2x 4218696
- 2x 4600437



Customer Service
Kundenservice
Service Consommateurs
Servicio Al Consumidor

LEGO.com/service or dial

- -
 -
 -
 -
 -
 -
 -
 -
 -
 -
 -
 -
- : 00800 5346 5555**
: 1-800-422-5346

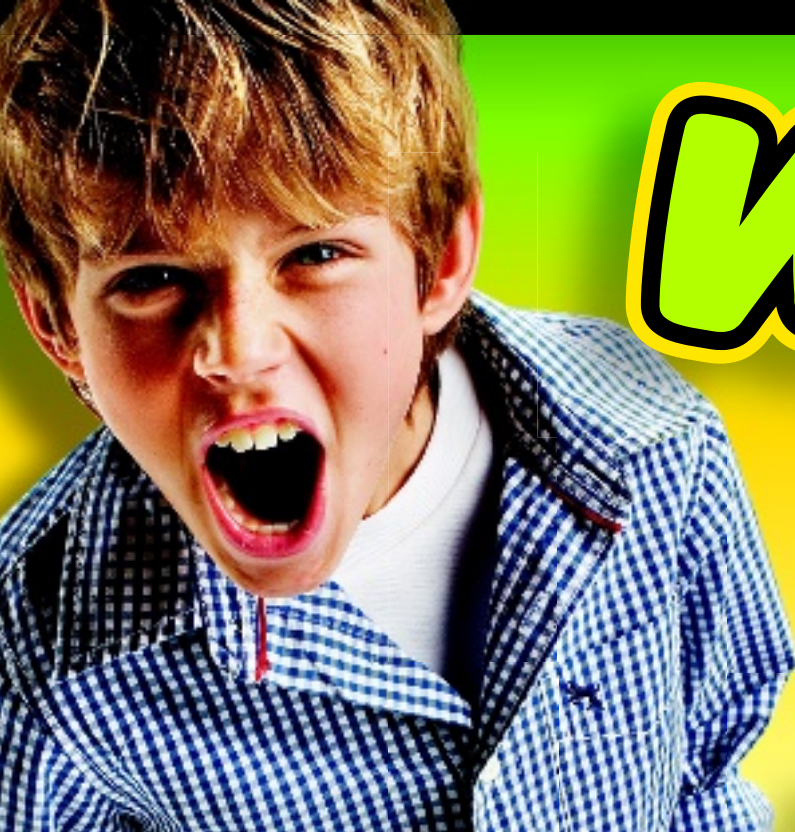

WIN!

Go to www.LEGOsurvey.com/product to fill out a survey for a chance to win a cool LEGO® Product.

No purchase necessary.

Open to all residents where not prohibited.



LEGO.com



www.LEGOsurvey.com/product

GEWINNE! WIN!

Nimm an der Umfrage auf www.LEGOsurvey.com/product teil und hab die Chance ein cooles LEGO® Produkt zu gewinnen!

Die Teilnahme am Gewinnspiel führt zu keinerlei Kaufverpflichtungen. Teilnahme in allen nicht ausgeschlossenen Ländern möglich.

Ga naar www.LEGOsurvey.com/product, vul een enquêteformulier in en maak kans op een cool LEGO® product.

Geen aankoopverplichting. Iedereen mag deelnemen, uitgezonderd ingezetenden van landen waar een enquêteverbod geldt.

GAGNE! 当てよう!

Visite www.LEGOsurvey.com/product pour répondre à un questionnaire et avoir une chance de gagner un produit LEGO® très cool!

Aucune obligation d'achat. Ouvert à tous les résidents des pays autorisés.

www.LEGOsurvey.com/product にアクセスして、アンケートにご記入ください。当選者にはレゴ®製品を差し上げます。

お買い上げの必要はありません

禁止されていない限り、すべての皆様にご利用いただけます。