



60025

CITY



WARNING: CHOKING HAZARD.
Small parts. Not for children under 3 years.

1



2



3



4





AVERTISSEMENT : RISQUE D'ÉTOUFFEMENT.
Contient des petites pièces. Ne convient pas aux enfants de moins de 3 ans.



ADVERTENCIA: PELIGRO DE ASFIXIA.
No recomendado para niños menores de 3 años. Contiene piezas pequeñas.

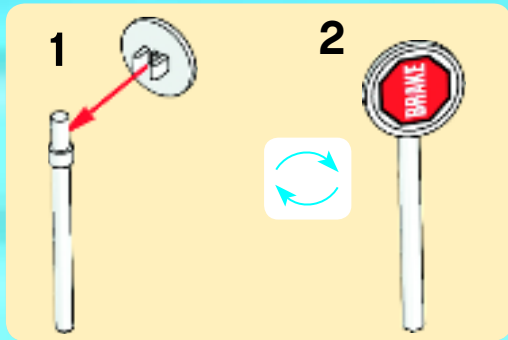
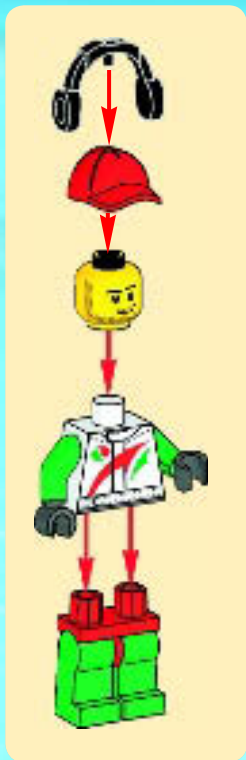

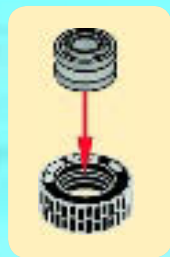



1

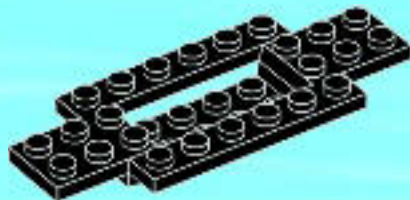



1x



1x

2

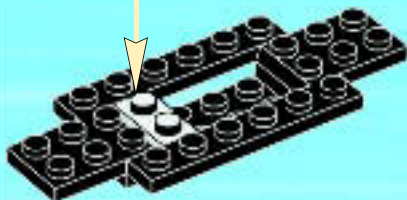
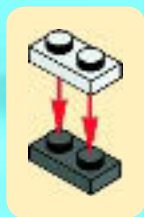



2x

3

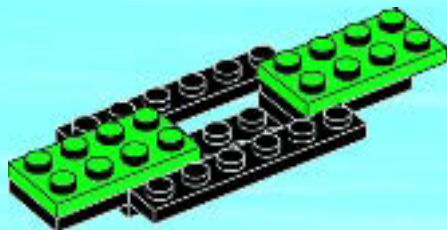

2x

4

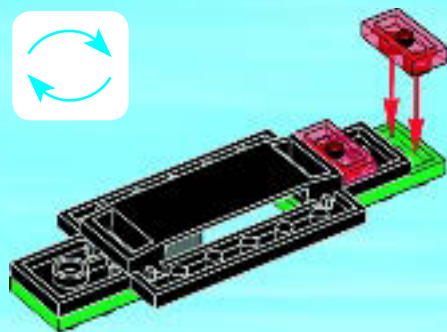



2x

5

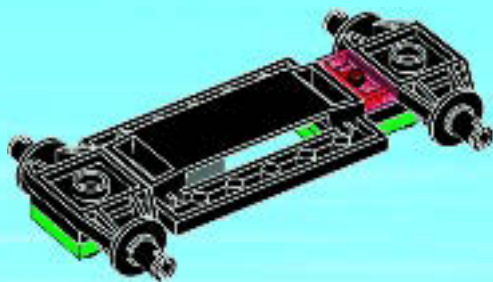



1x

6

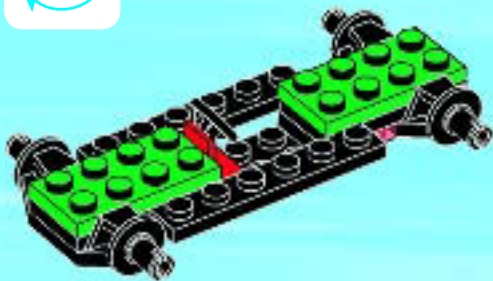

1x



1x

7

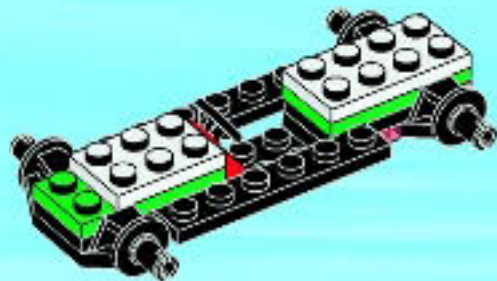



2x

8



2x

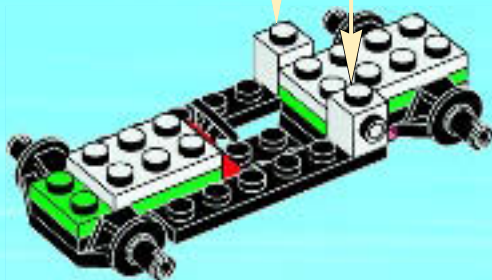



1x



2x

9

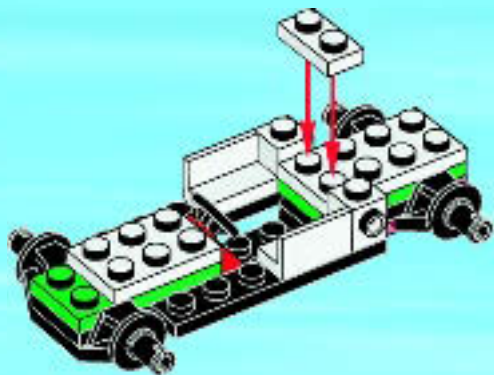

2x

10



2x

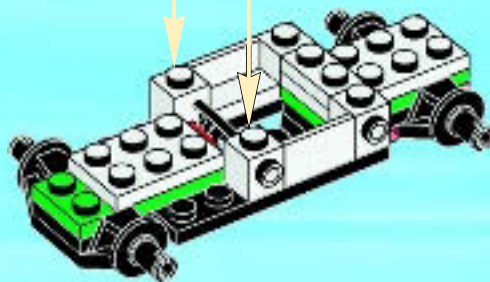



2x

11

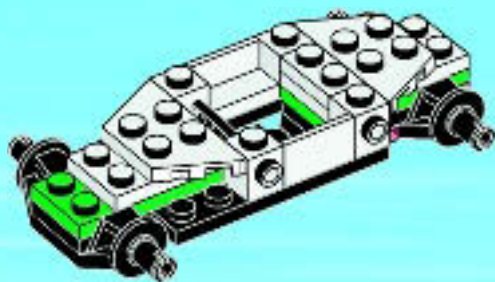



2x



2x

1



2

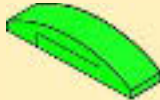

3



2x

12





1x



2x

13



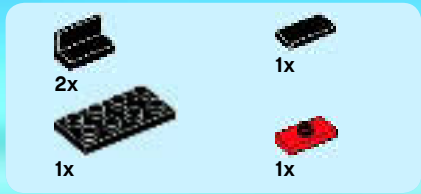

14

1



2



3



4

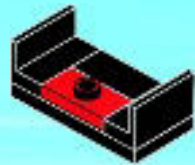

5

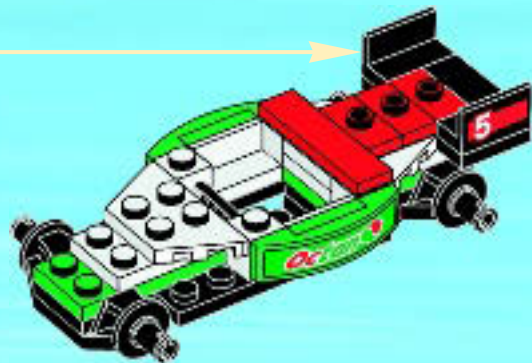
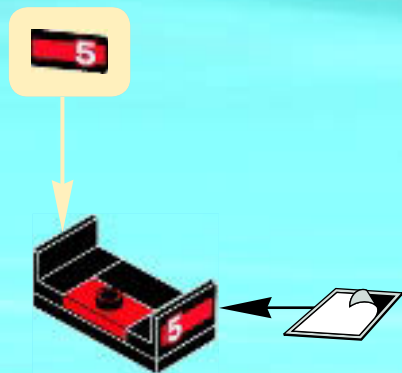



1x



1x



1x

15

1



2



3

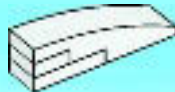

4

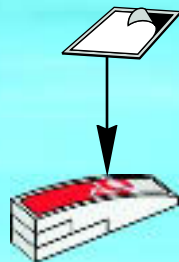



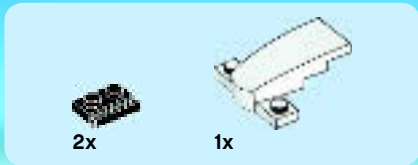

16

1

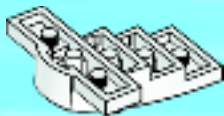

2

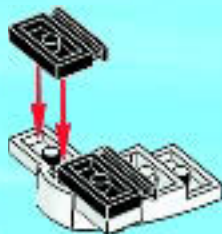

3

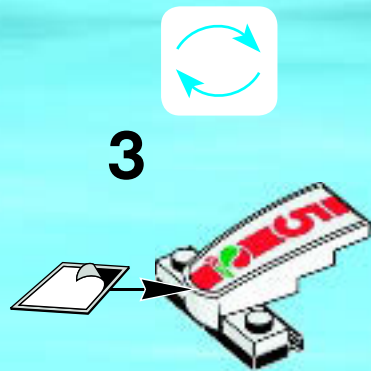

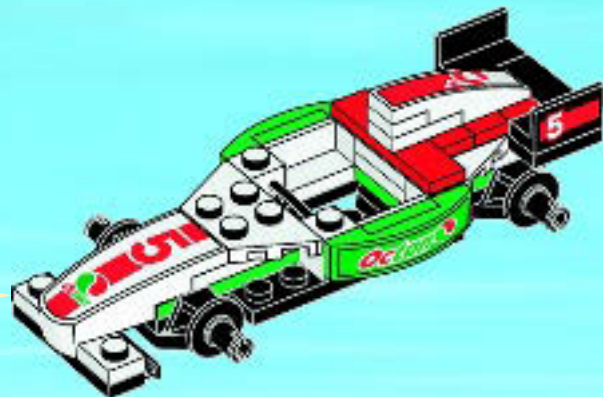



1x

17





4x

18

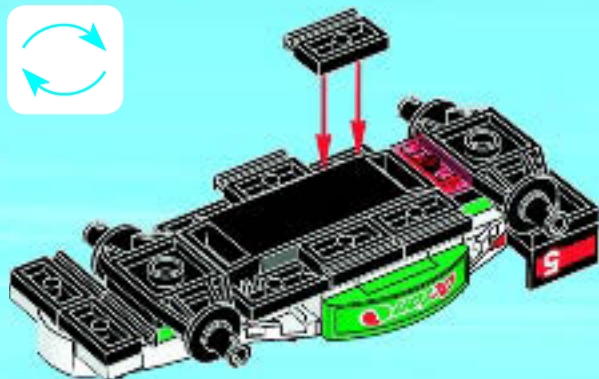



4x



4x

19

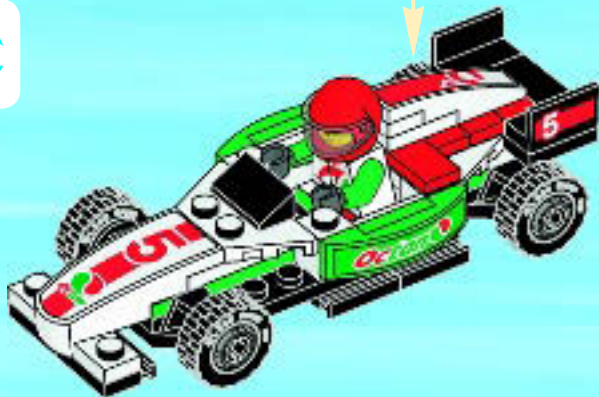
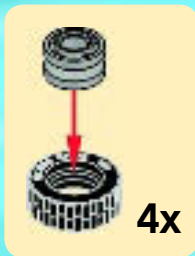

Nintendo



CITY
UNDERCOVER



Game and system sold separately/Le jeu et le système sont vendus séparément. ©2013 The LEGO Group.
™ & © Warner Bros. Entertainment Inc. (s13). Wii U is a trademark of/est une marque déposée de Nintendo. © 2013 Nintendo.

EVERYONE 10+

Cartoon Violence
Crude Humor

CONTENT RATED BY
ESRB



WIN!

Go to www.LEGOsurvey.com/product to fill out a survey for a chance to win a cool LEGO® Product.

No purchase necessary.

Open to all residents where not prohibited.



www.LEGOsurvey.com/product

GEWINNE!

Nimm an der Umfrage auf www.LEGOsurvey.com/product teil und hab die Chance ein cooles LEGO® Produkt zu gewinnen!

Die Teilnahme am Gewinnspiel führt zu keinerlei Kaufverpflichtungen. Teilnahme in allen nicht ausgeschlossenen Ländern möglich.

WIN!

Ga naar www.LEGOsurvey.com/product, vul een enquêteformulier in en maak kans op een cool LEGO® product.

Geen aankoopverplichting. Iedereen mag deelnemen, uitgezonderd ingezetenden van landen waar een enquêteverbod geldt.

GAGNE!

Visite www.LEGOsurvey.com/product pour répondre à un questionnaire et avoir une chance de gagner un produit LEGO® très cool!

Aucune obligation d'achat. Ouvert à tous les résidents des pays autorisés.

当てよう!

www.LEGOsurvey.com/product にアクセスして、アンケートにご記入ください。当選者にはレゴ®製品を差し上げます。

お買い上げの必要はありません。禁止されていない限り、すべての皆様にご利用いただけます。



LEGO.com

6048878

LEGO and the LEGO logo are trademarks of the/son des marques de commerce de/son marcas registradas de LEGO Group. ©2013 The LEGO Group.