



60051



CITY



1



2



3



4



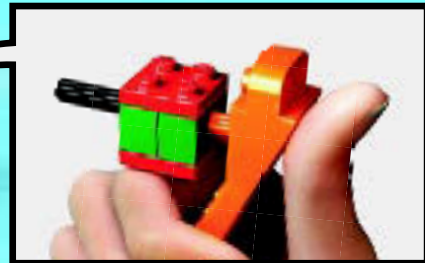

LEGO.com/brickseparator





2x

+

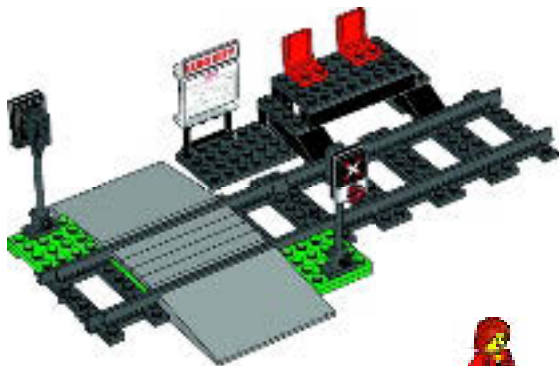

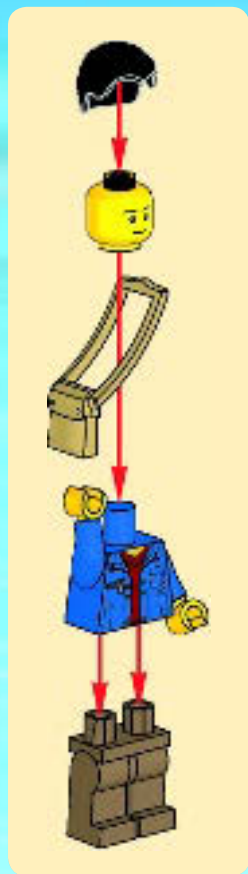

1



2



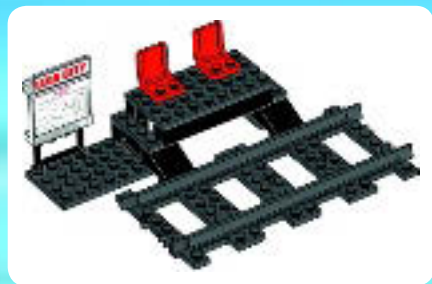

1x

1



1x

1x

2

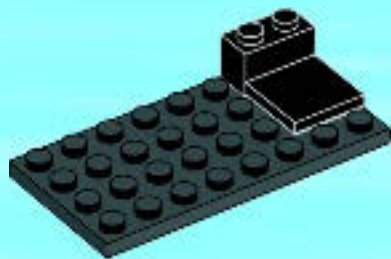



1x

3

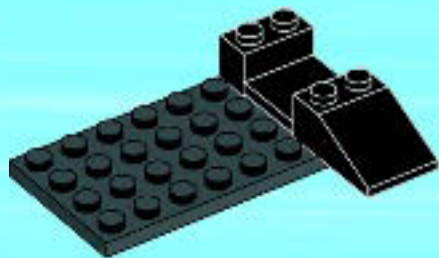



1x

4

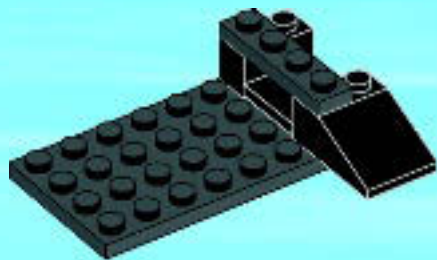

2x

5

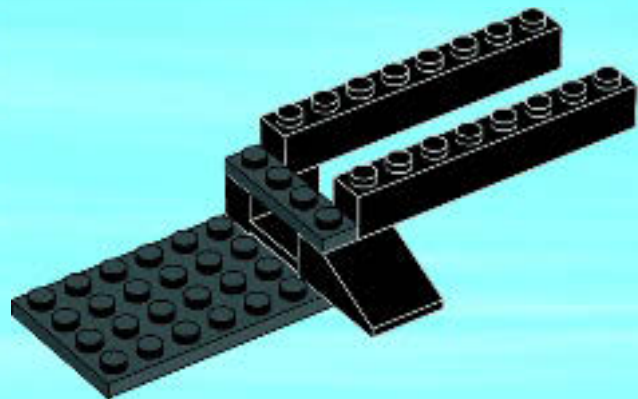

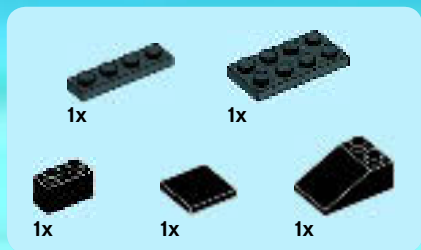

6

1



2



3

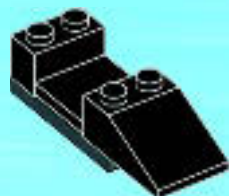

4

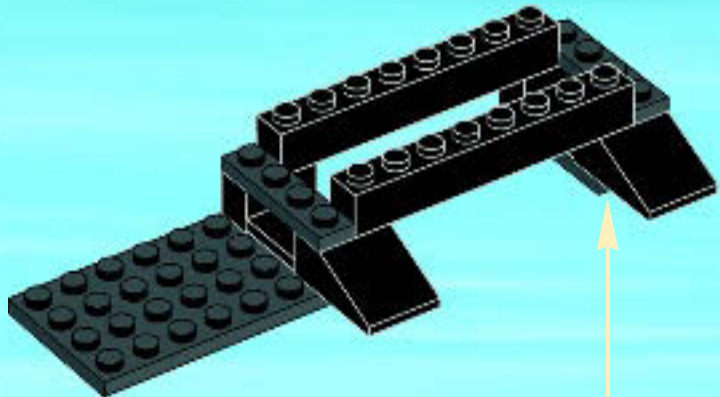
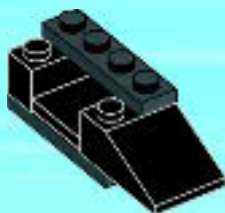



7

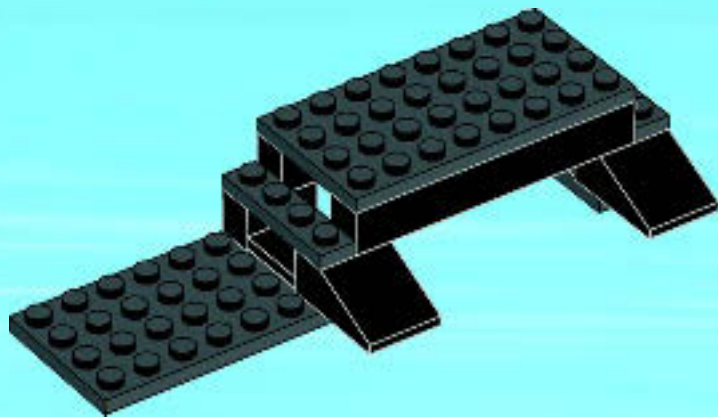



2x



1x

8

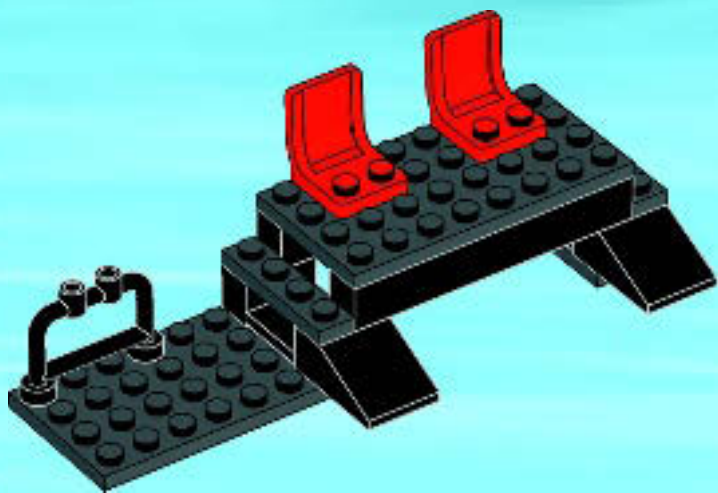

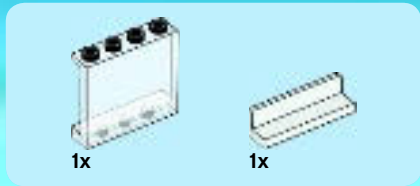

9

1



2

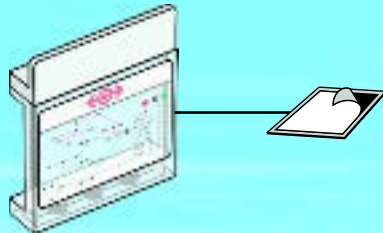

3



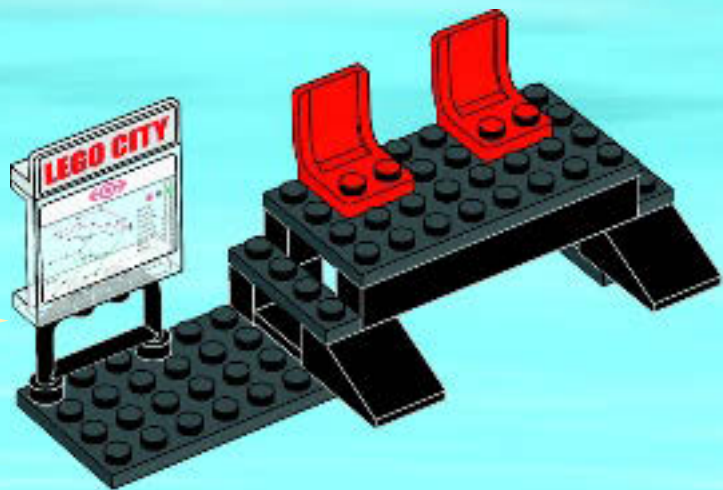

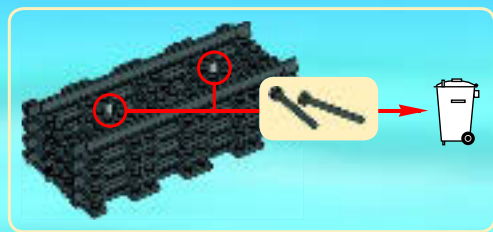
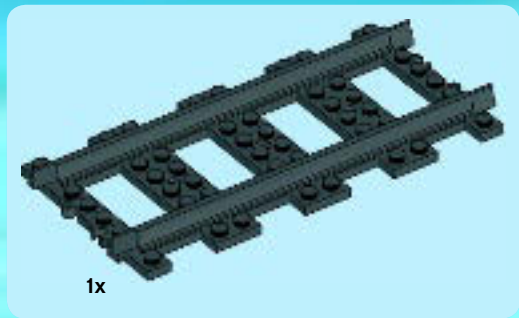

10

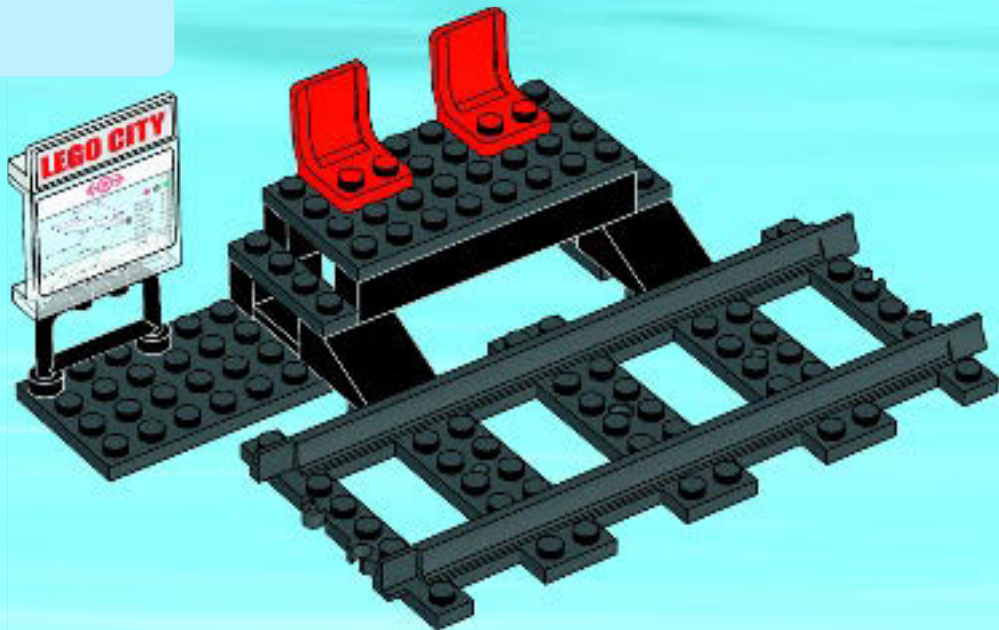

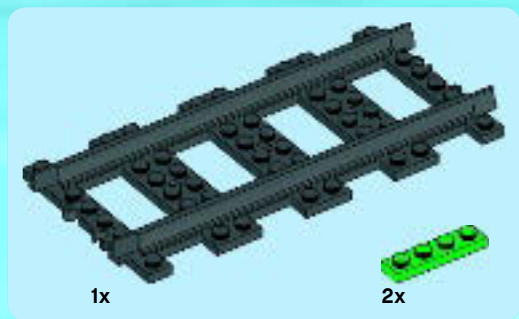
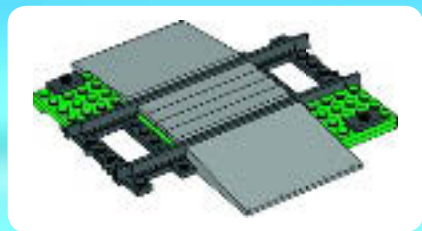

1

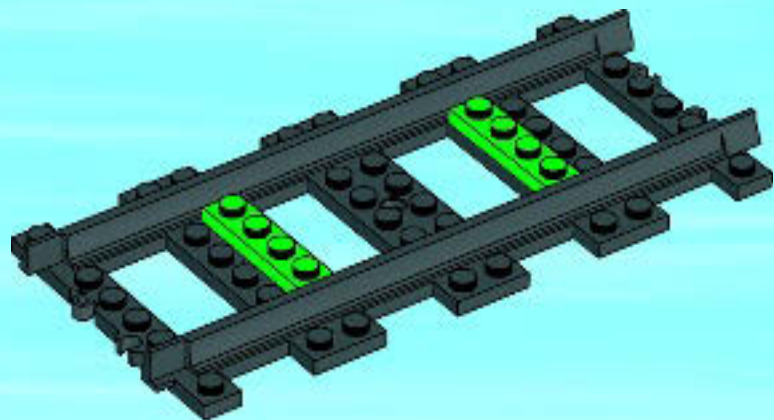

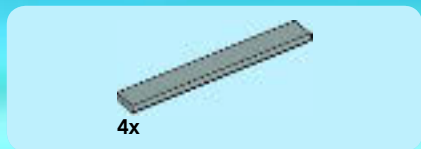

2

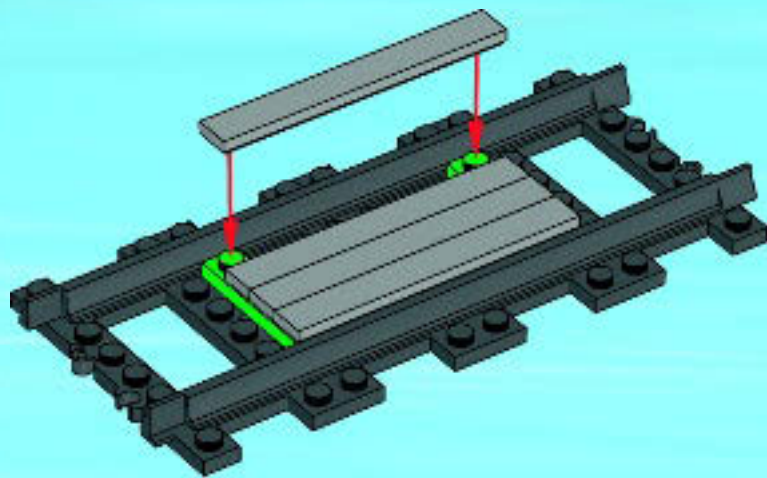

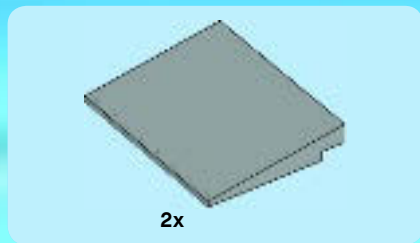

3

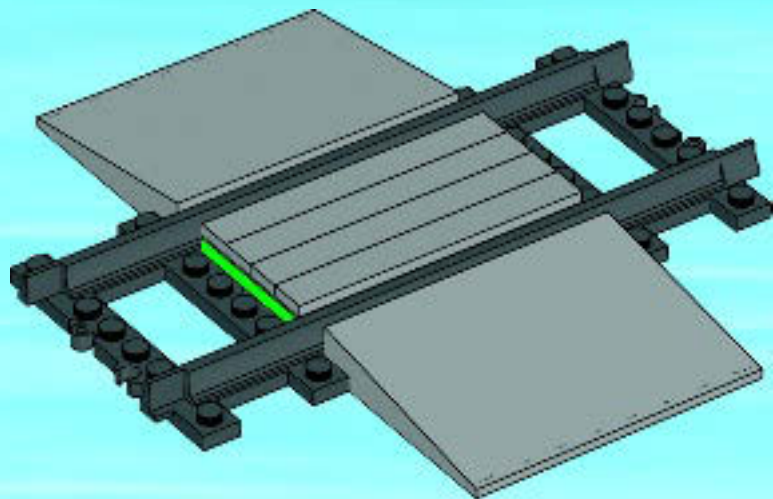

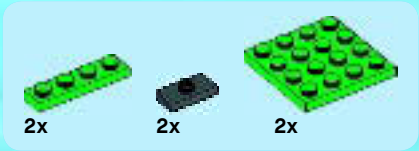

4

1



2

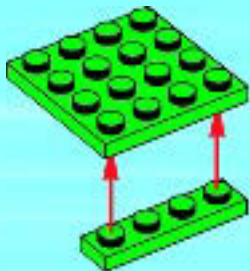

3

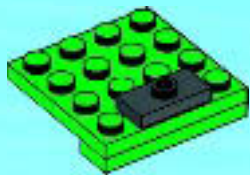

2x

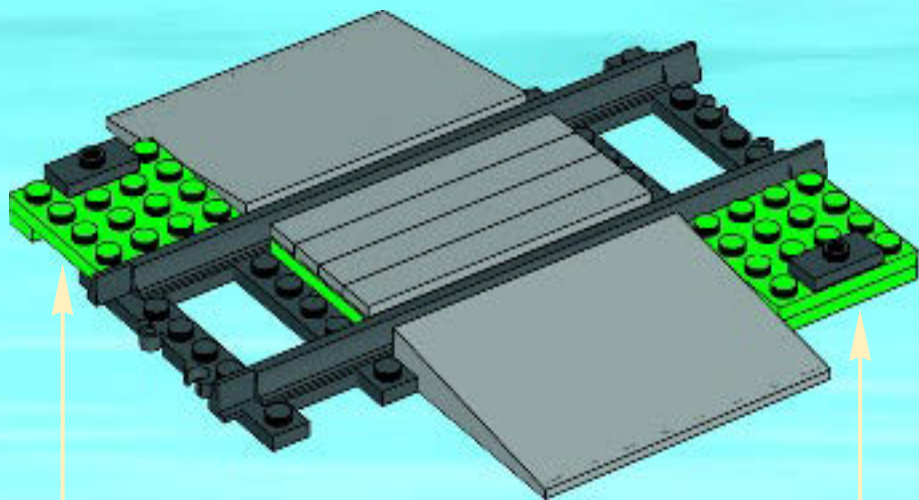



5

1



2



3

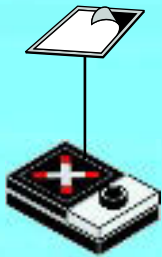

4



5



2x

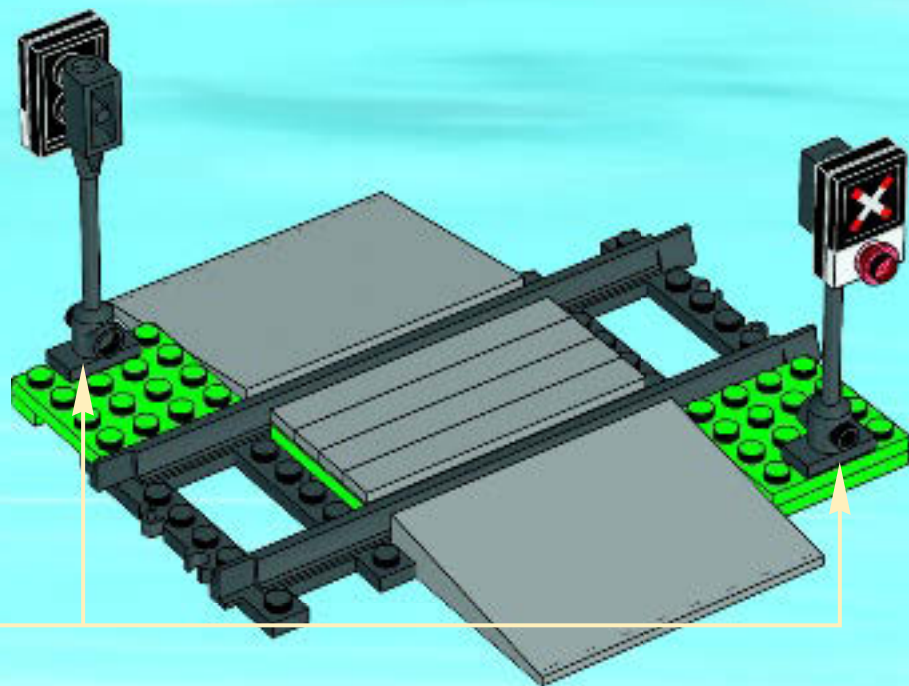

6



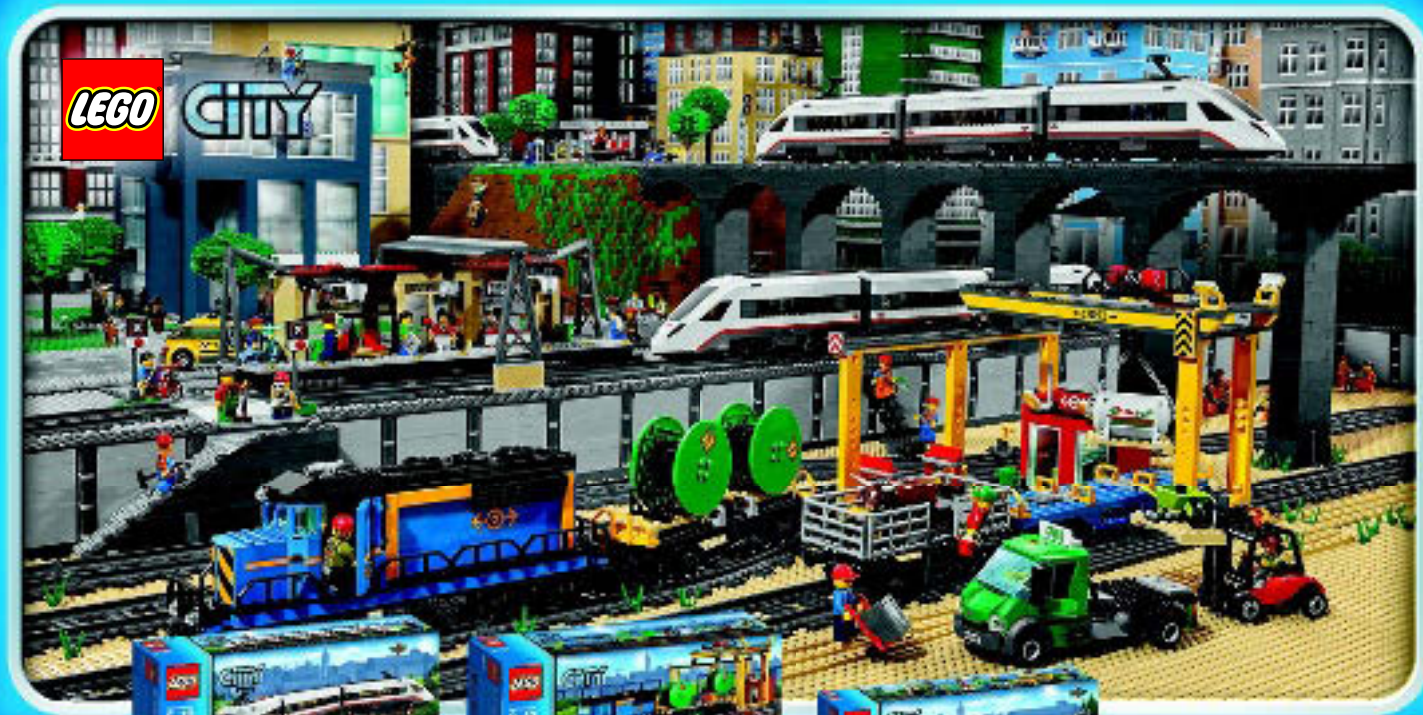

LEGO

CITY



60051



60052



60050

LEGO.COM/CITY

The background of the advertisement is a vibrant, isometric view of a LEGO City street scene. It features various colorful buildings, a fire truck, a police car, and a construction crane. In the center, the LEGO logo is prominently displayed in its signature red and white. To the right, a LEGO character wearing a blue hooded winter jacket and goggles is shown holding a grey tool. The overall scene is bright and detailed, capturing the essence of the LEGO City theme.

LEGO

CITY
MY CITY

NEW! FREE ONLINE GAME & APP!
NOUVEAU ! JEU EN LIGNE ET APPLI GRATUITS !
¡NOVEDAD! ¡JUEGO ONLINE Y APP GRATIS!



LEGO.COM/CITY

ANDROID APP ON
 Google play

Available on the
 App Store

LEGO.COM/CITY

CODE SECRET :
MYCITYBONUS

UTILISE LE CODE POUR OBTENIR DES
TENONS BONIS DANS LE JEU EN LIGNE
(EXPIRE LE 31/12/2015)

SECRET CODE:

MYCITYBONUS

USE THE CODE FOR BONUS STUDS
IN THE ONLINE GAME
(EXPIRES 12/31/2015)

CÓDIGO SECRETO:

MYCITYBONUS

USA EL CÓDIGO SECRETO PARA OBTENER
PUNTOS EXTRA EN EL JUEGO ONLINE
(HASTA EL 31/12/2015)

Apple, the Apple logo, iPad, iPhone and iPod touch are trademarks of Apple Inc., registered in the U.S. and other countries.

App Store is a service mark of Apple Inc.

Apple, le logo Apple, iPad, iPhone et iPod touch sont des marques de commerce d'Apple Inc., déposées aux États-Unis et dans d'autres pays.

App Store est une marque de service d'Apple Inc.

Apple, el logotipo de Apple, iPad, iPhone e iPod touch son marcas comerciales de Apple Inc. registradas en EE. UU. y otros países.

App Store es una marca de servicio de Apple Inc.

Google Play is a trademark of Google Inc.

Google Play est une marque de commerce de Google Inc.

Google Play es una marca comercial de Google Inc.

WIN

GO TO WWW.LEGO.COM/PRODUCTFEEDBACK AND
GIVE US YOUR SHORT **FEEDBACK** ABOUT THIS
LEGO® SET FOR A CHANCE TO WIN
A COOL LEGO PRIZE.



LEGO.com/productfeedback

GEWINNE



Erzähle uns auf
www.LEGO.com/productfeedback

etwas über die Erfahrungen, die du mit
diesem LEGO® Set gemacht hast, und
sichere dir die Chance auf einen coolen
LEGO Preis!

GAGNE



Rends-toi sur
www.LEGO.com/productfeedback

et donne-nous quelques commentaires
sur ce produit LEGO® pour avoir une
chance de gagner un prix LEGO !

GANAN



Visita
www.LEGO.com/productfeedback

y envíanos tu opinión acerca de este set
LEGO®. ¡Participarás en el sorteo de un
premio LEGO!

获取奖品



登录
www.LEGO.com/productfeedback

给出关于此乐高®套装的简短反馈，
就有机会获得炫酷乐高大奖品

LEGO and the LEGO logo are trademarks of the/son des marques de commerce de/son marcas registradas de LEGO Group. ©2014 The LEGO Group.

6092532