



# CITY

60075



 [LEGO.com/city](https://www.lego.com/city)



**WARNING: CHOKING HAZARD.**  
Small parts. Not for children under 3 years.





+

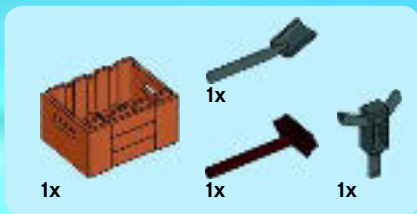

1





1x



1x



2x

# 2



**AVERTISSEMENT** : RISQUE D'ÉTOUFFEMENT.  
Contient des petites pièces. Ne convient pas aux enfants de moins de 3 ans.



**ADVERTENCIA**: PELIGRO DE ASFIXIA.  
No recomendado para niños menores de 3 años. Contiene piezas pequeñas.

## 1



## 2



## 3





1





2x

2



4x

3

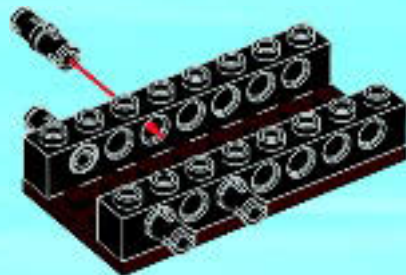



2x

4

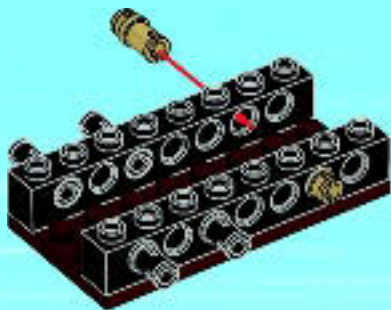

6



2x



1x

5

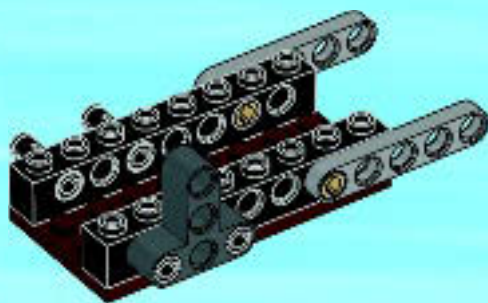

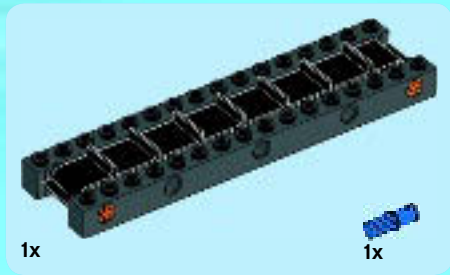

1

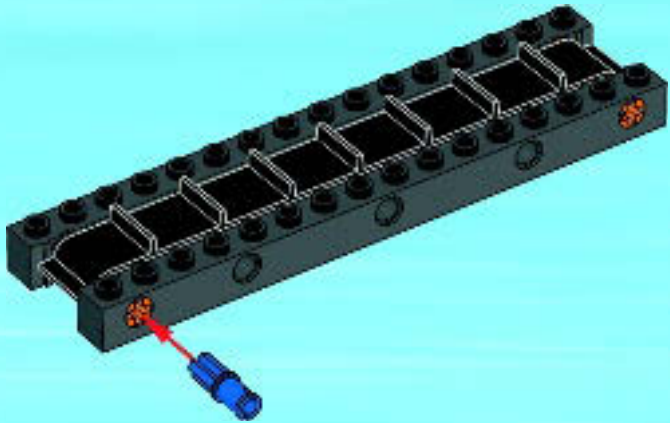





2x

2

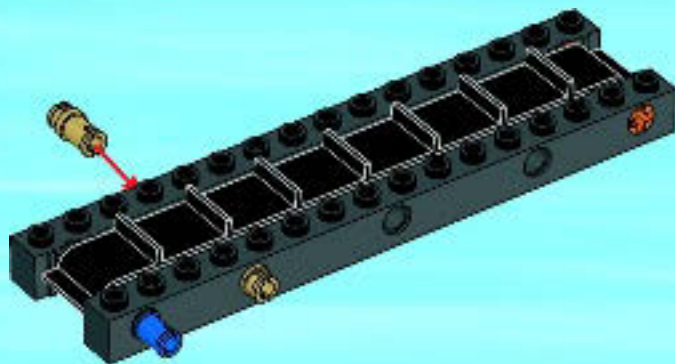



2x

3

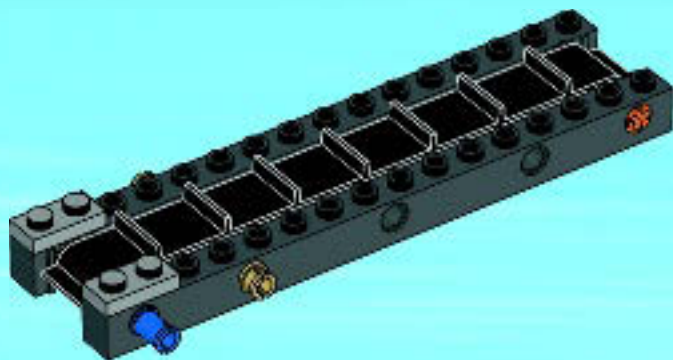





6x

5

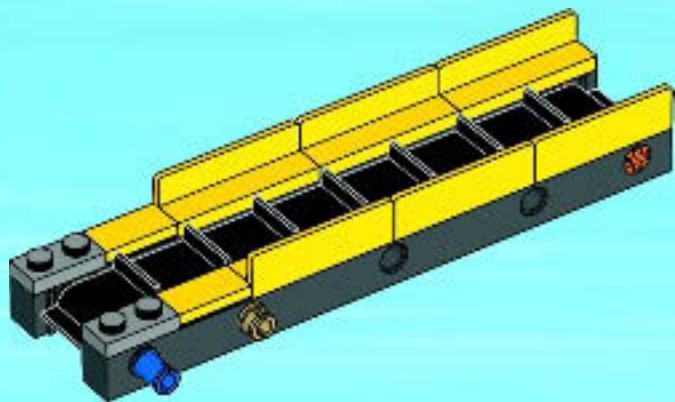

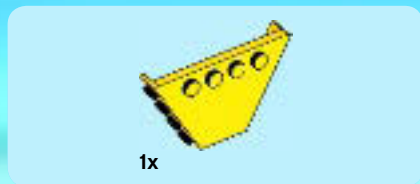

6

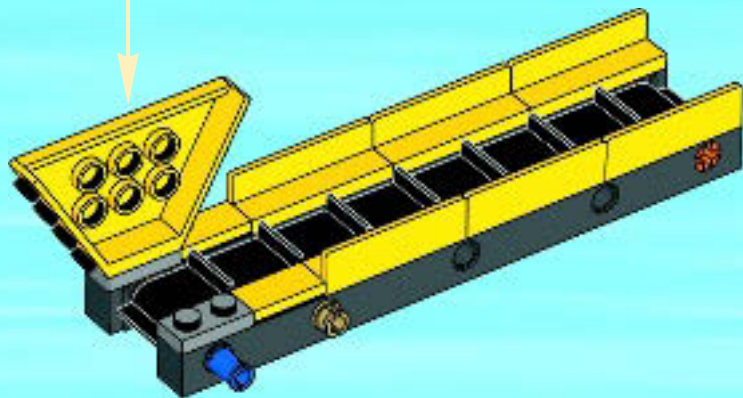
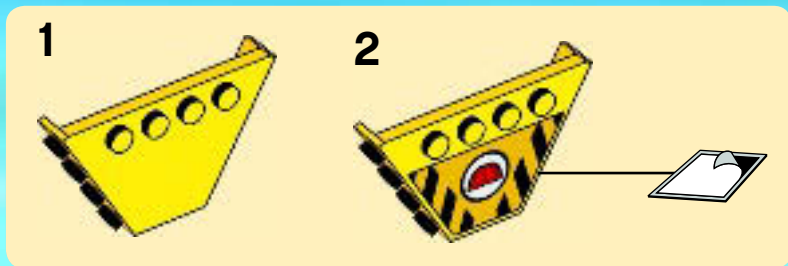

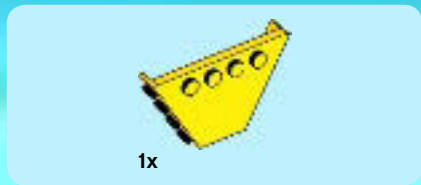

7

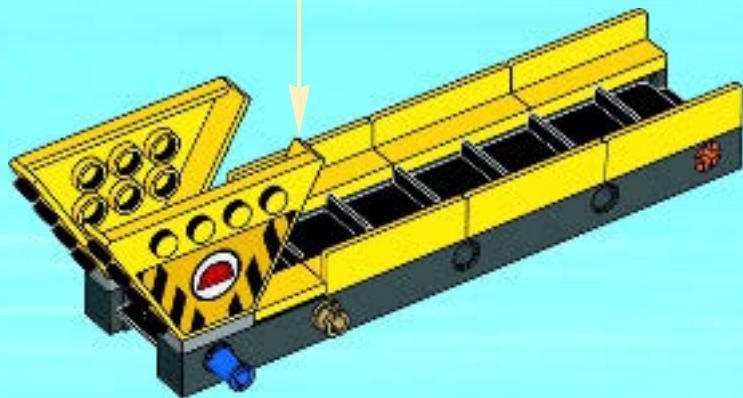



1x

8

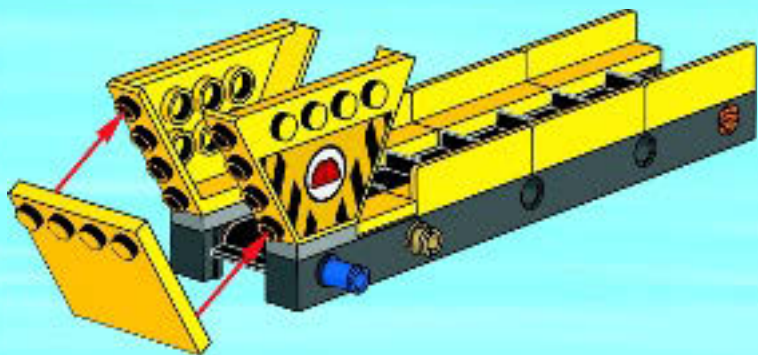



1x

9

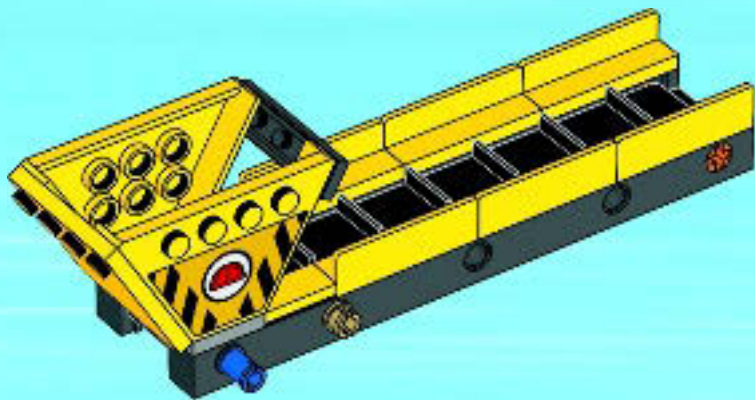



10

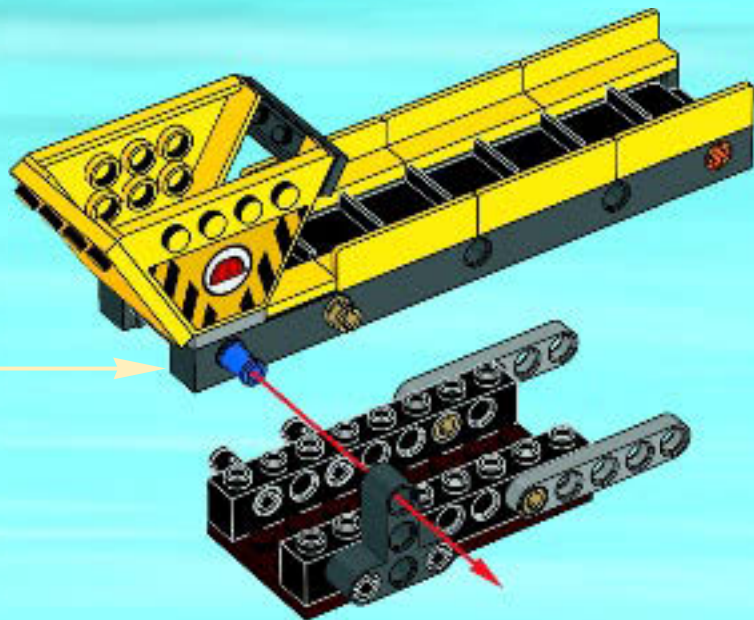



1x

11

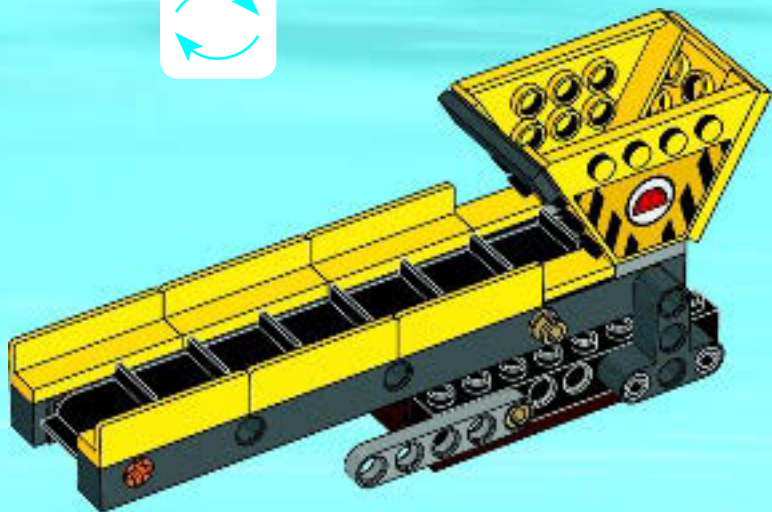



1x

12

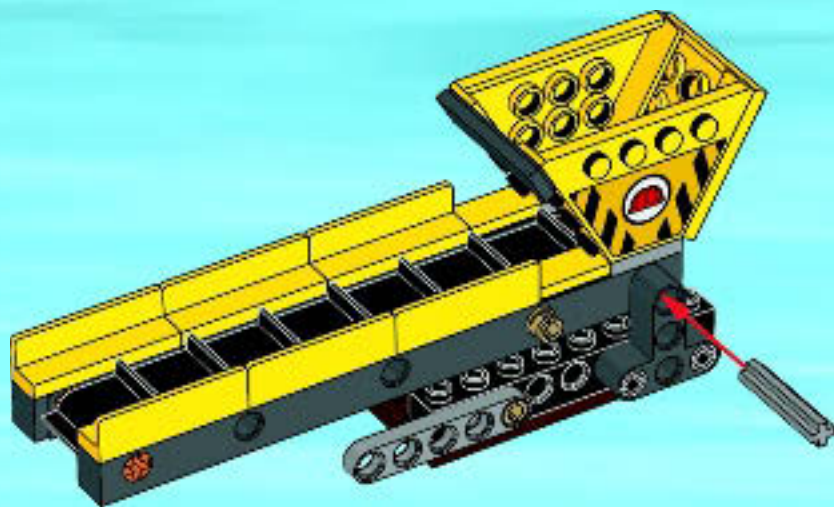



1x



1x

1



2



3



# 13

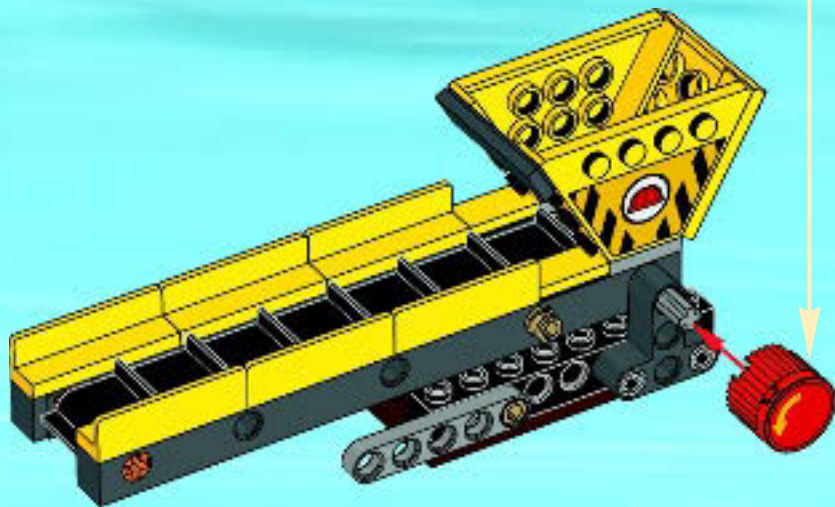

14

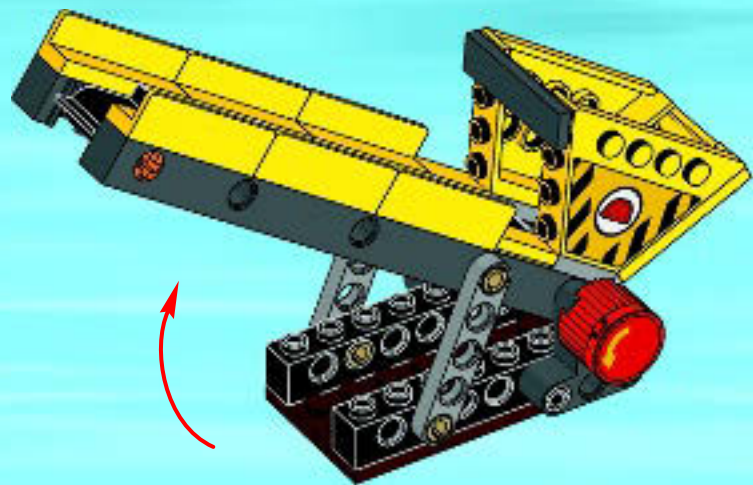



15

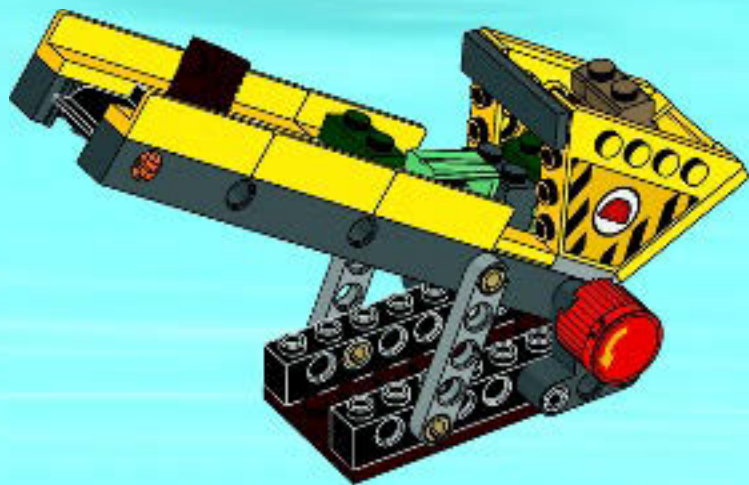

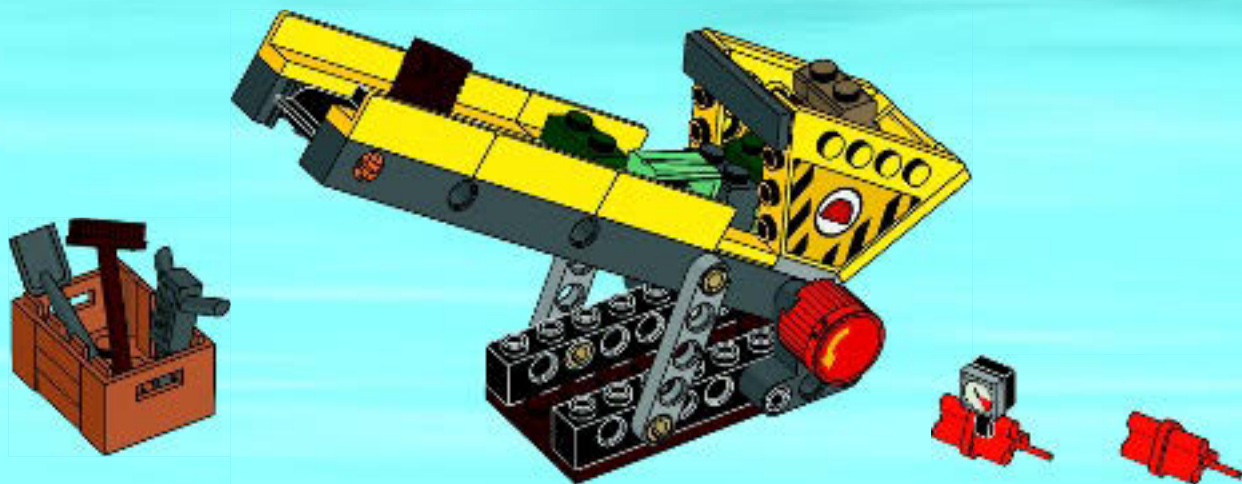



**FREE ONLINE GAME & APP!**  
**JEU EN LIGNE ET APPLI GRATUITS !**  
**¡JUEGO ONLINE Y APP GRATIS!**



LEGO and the LEGO logo are trademarks of the/  
 sont des marques de commerce de/  
 son marcas registradas de LEGO Group.  
 ©2015 The LEGO Group. 6109363

LEGO.COM/CITY

GET IT ON  
Google play

Download on the  
App Store



Apple, the Apple logo, iPad, iPhone and iPod touch are trademarks of Apple Inc., registered in the U.S. and other countries. App Store is a service mark of Apple Inc./Apple, le logo Apple, iPad, iPhone et iPod touch sont des marques de commerce d'Apple Inc., déposées aux États-Unis et dans d'autres pays. App Store est une marque de service d'Apple Inc./Apple, et logotype de Apple, iPad, iPhone et iPod touch sont des marques de commerce de Apple Inc., enregistrées en É.-U. et dans d'autres pays. App Store est une marque de service de Apple Inc. Google Play is a trademark of Google Inc./Google Play est une marque de commerce de Google Inc./Google Play est una marca comercial de Google Inc.