



6166



**WARNING: CHOKING HAZARD.**  
Small parts. Not for children under 3 years.



[www.LEGO.com](http://www.LEGO.com)

# Contents

4



6



12



16



19





Pictured models cannot be built simultaneously  
Les modèles illustrés ne peuvent pas être construits simultanément  
Los modelos mostrados no se construyen simultáneamente



**AVERTISSEMENT : RISQUE D'ÉTOUFFEMENT.**  
Contient des petites pièces. Ne convient pas aux enfants de moins de 3 ans.



**ADVERTENCIA: PELIGRO DE ASFIXIA.**  
No recomendado para niños menores de 3 años. Contiene piezas pequeñas.



1



2

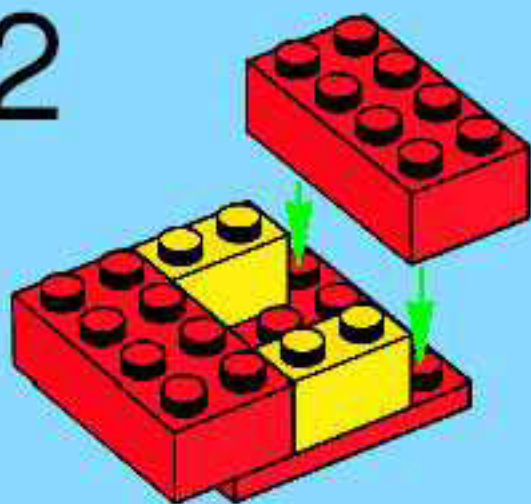

3



4



5



6



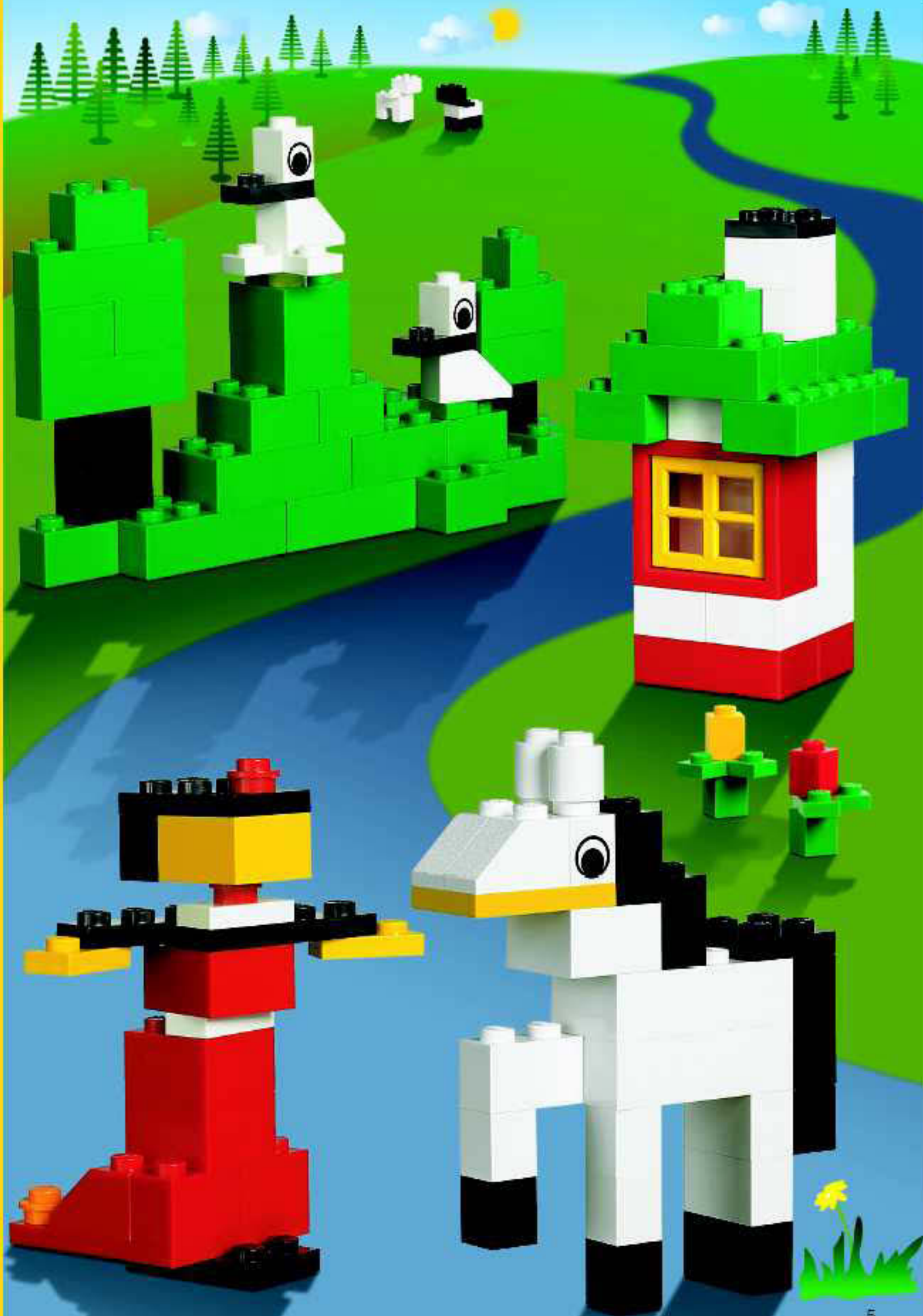

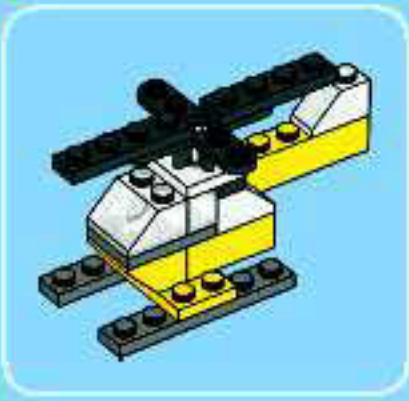

1

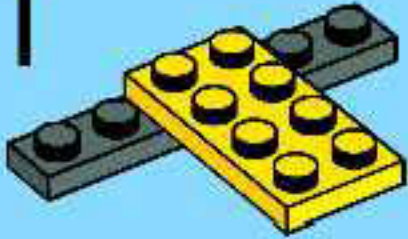

2

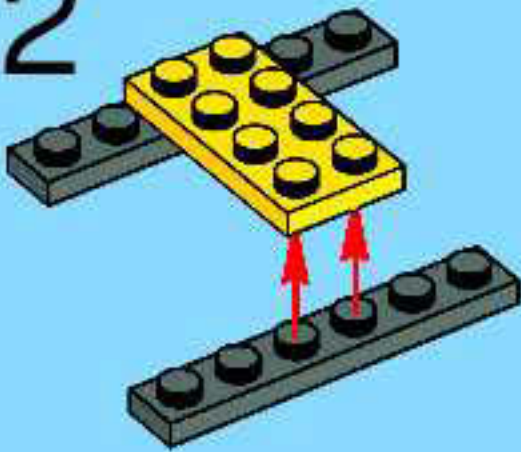

3

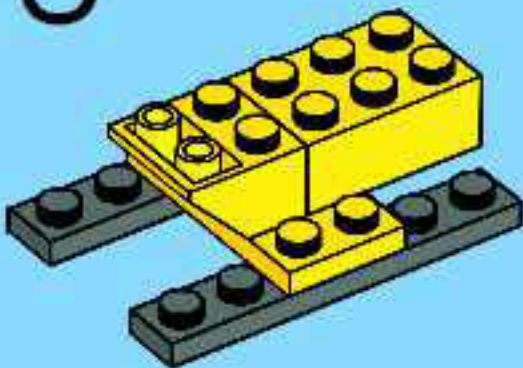

4

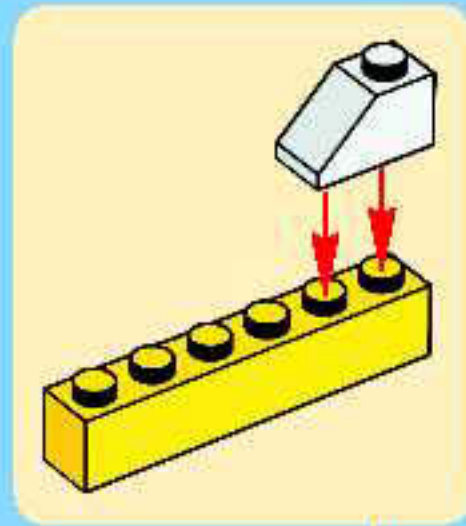
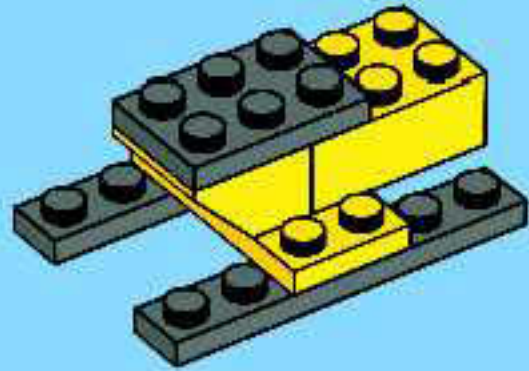

5

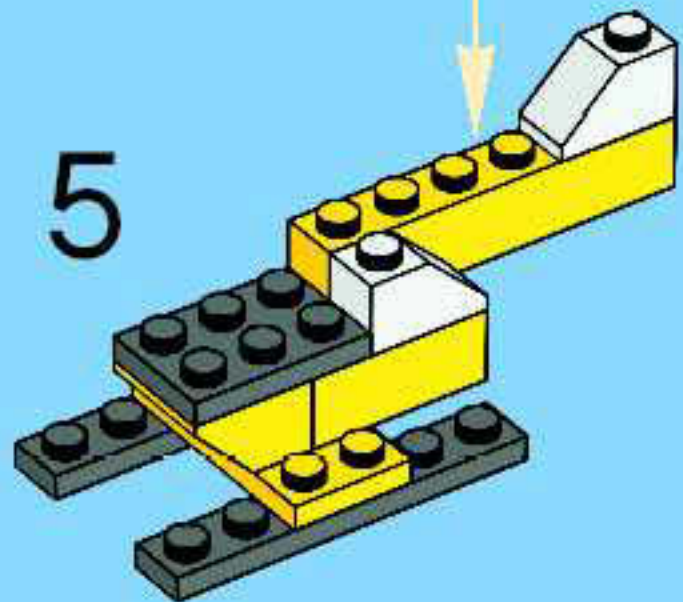

6

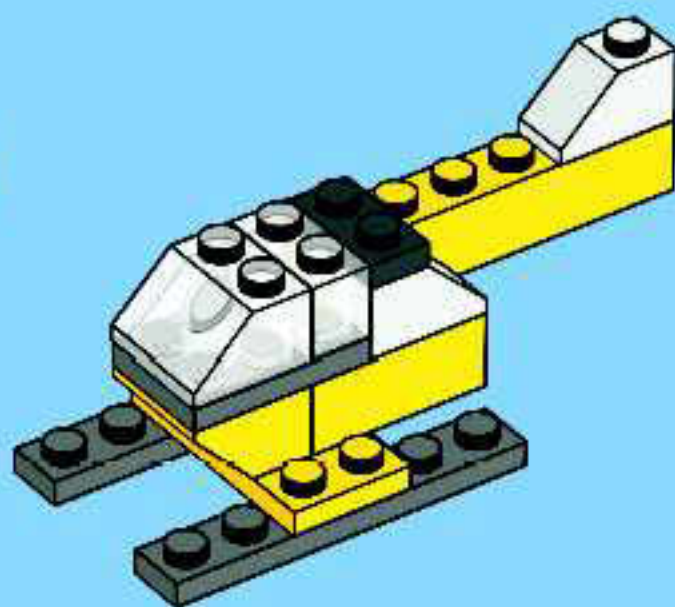

1

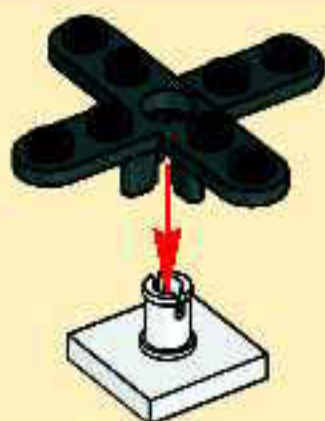

2

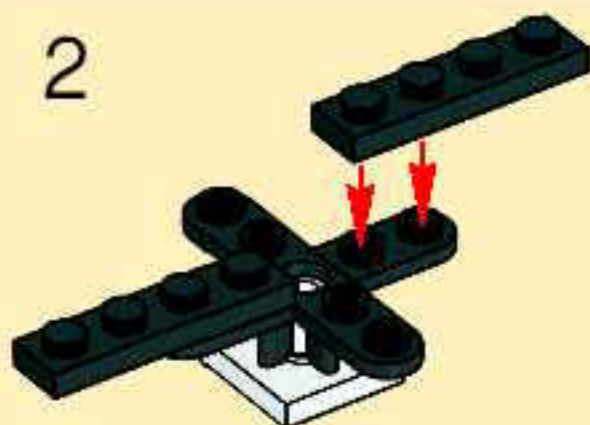

7

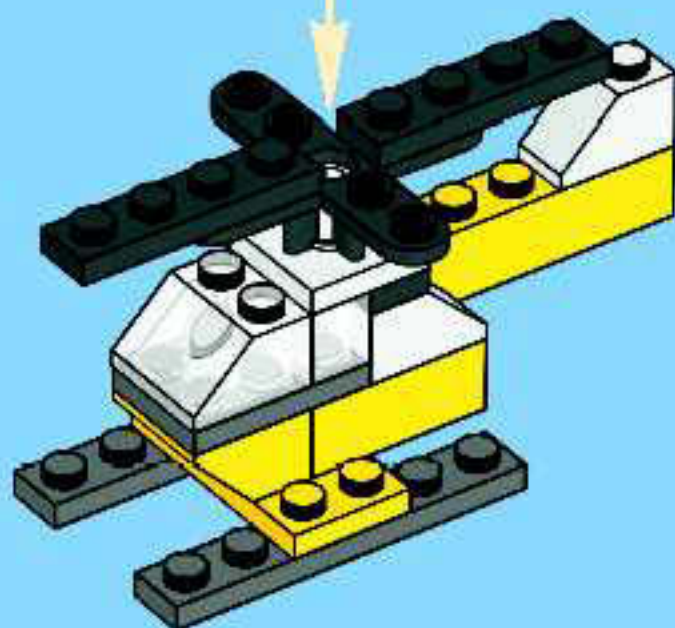







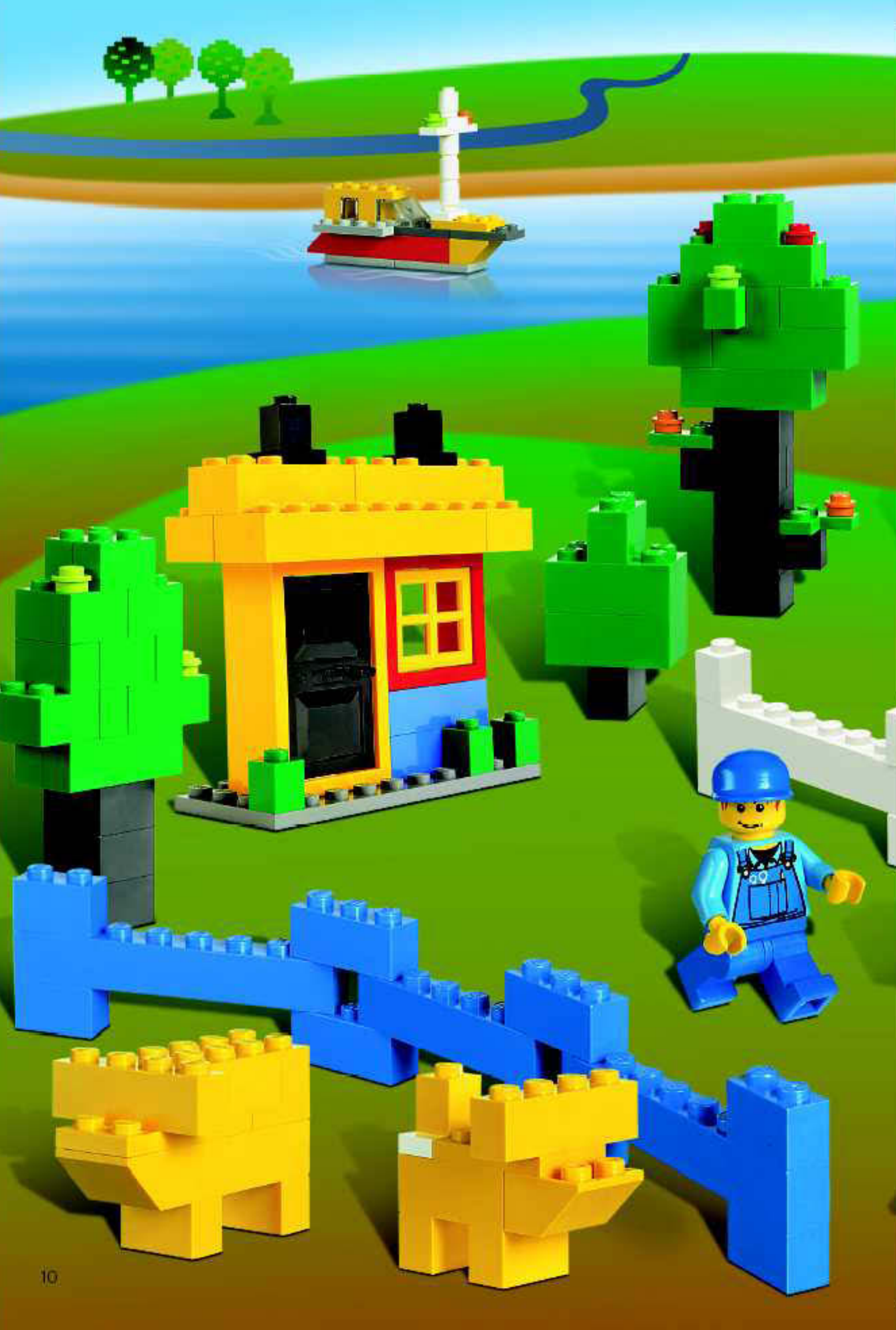

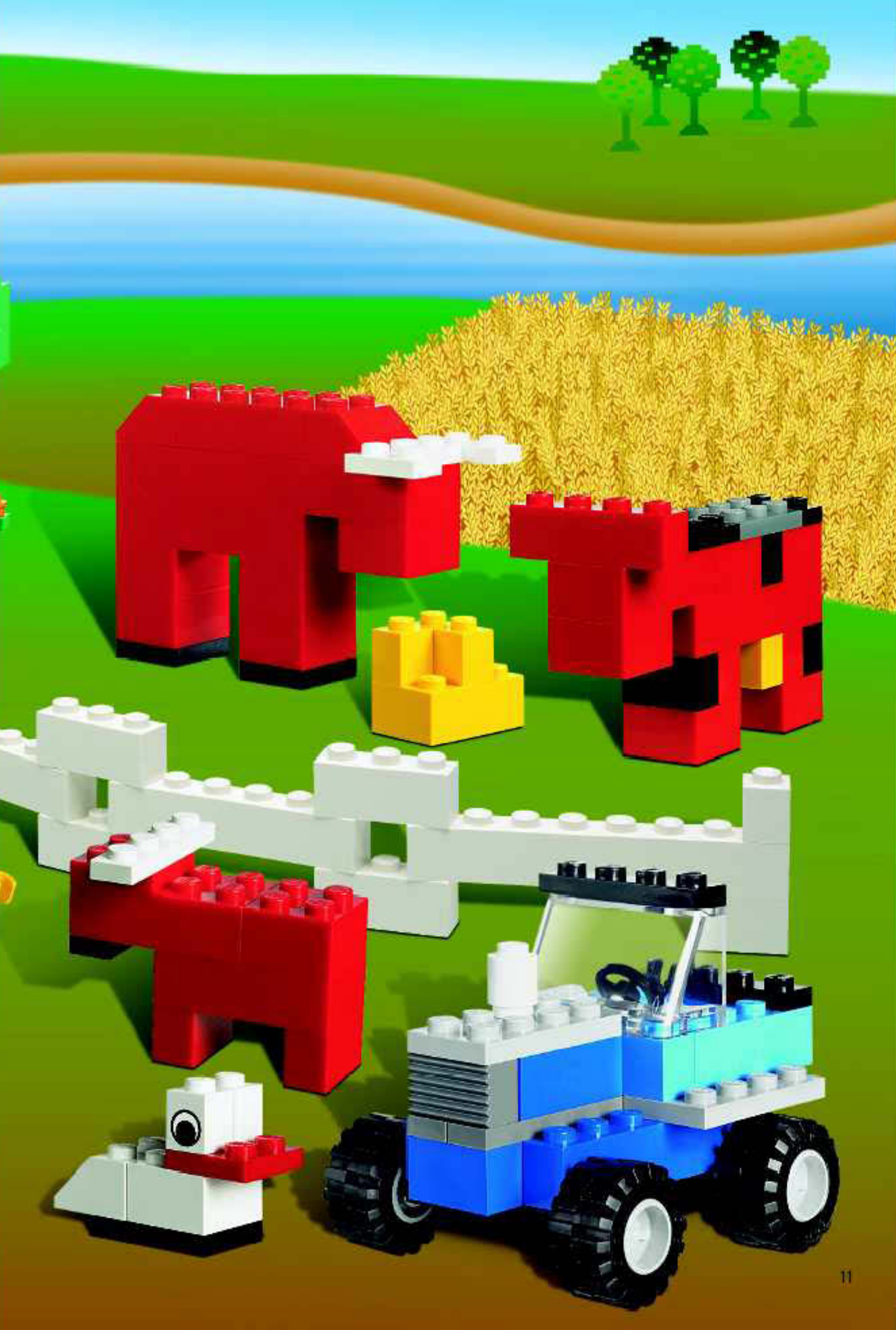



1

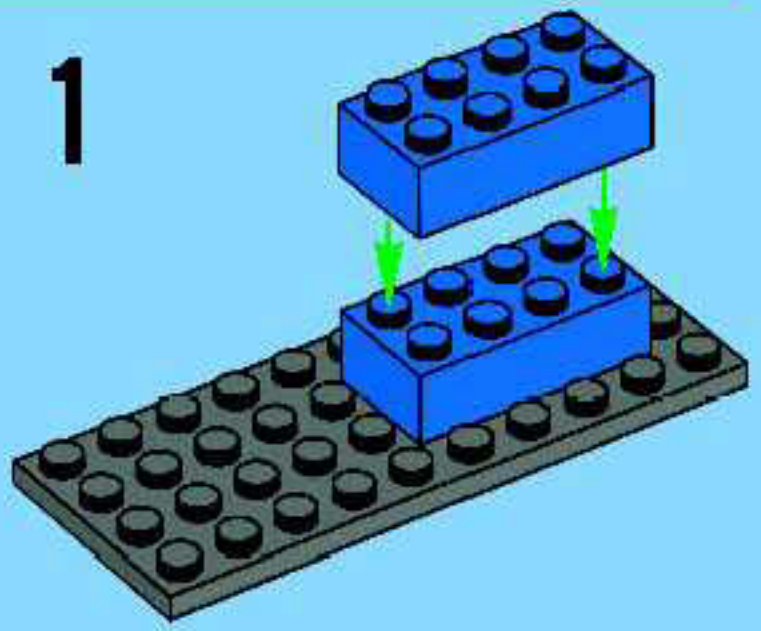

2

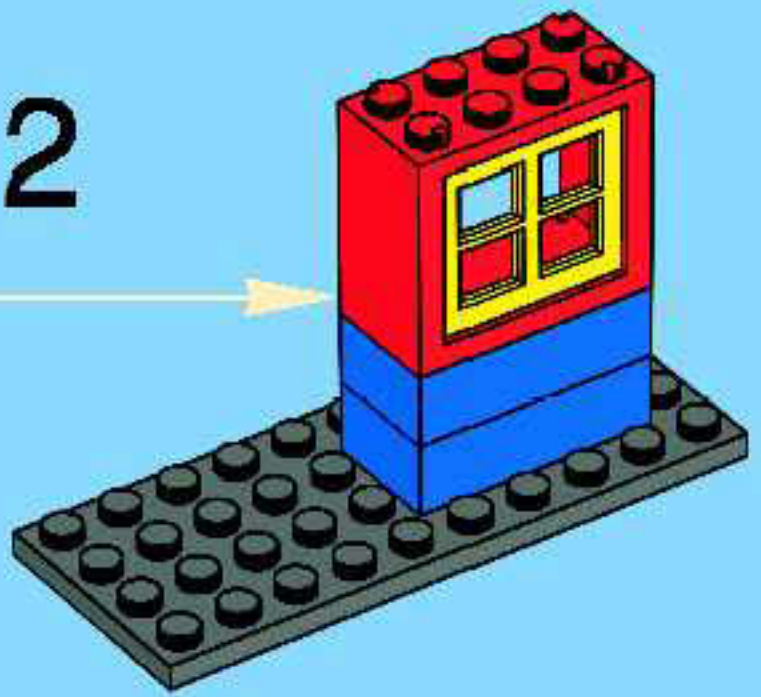
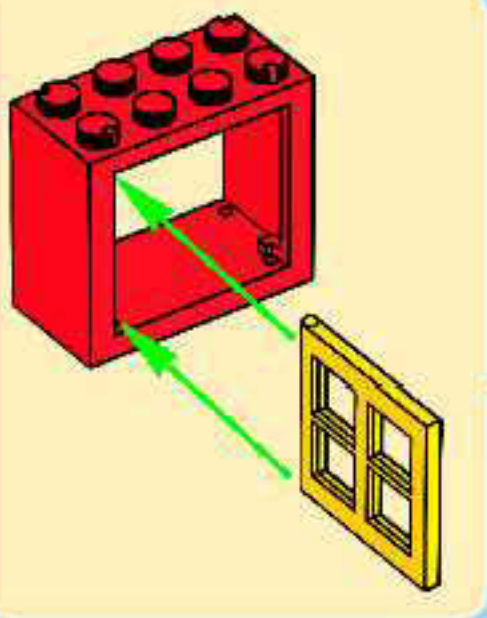

3

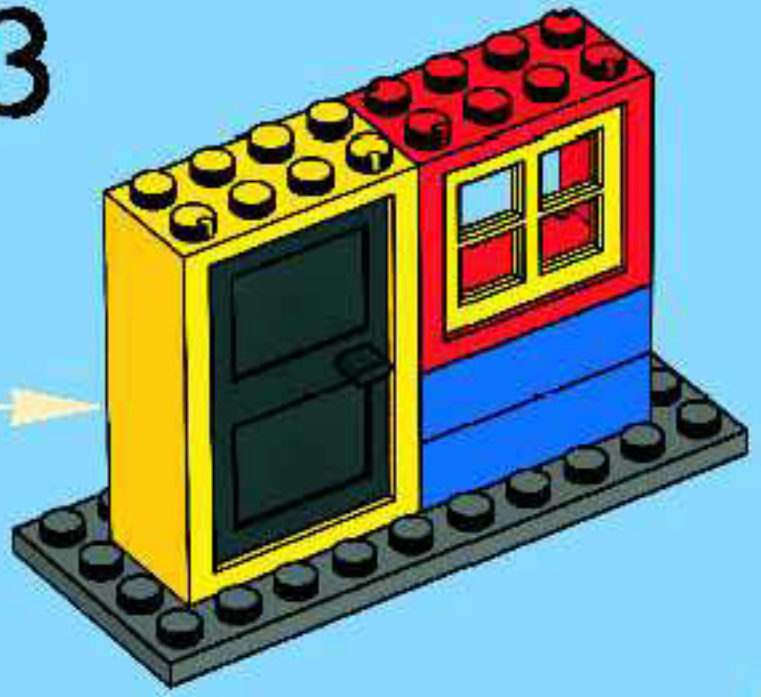
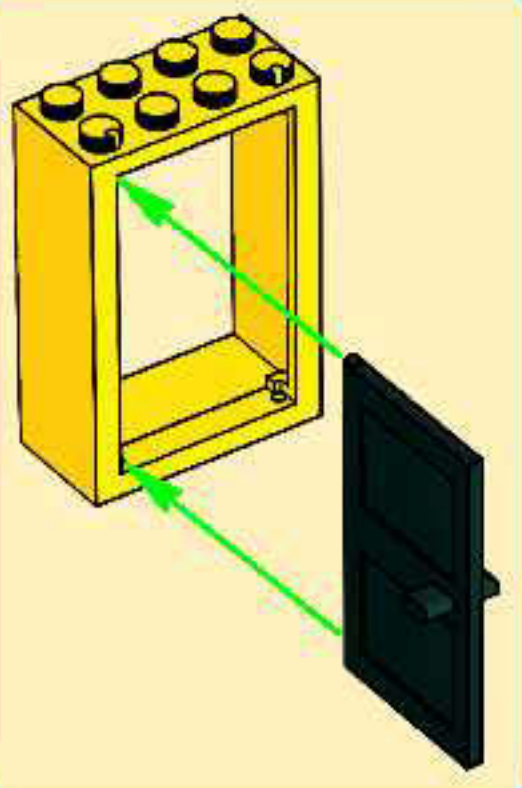

4



5

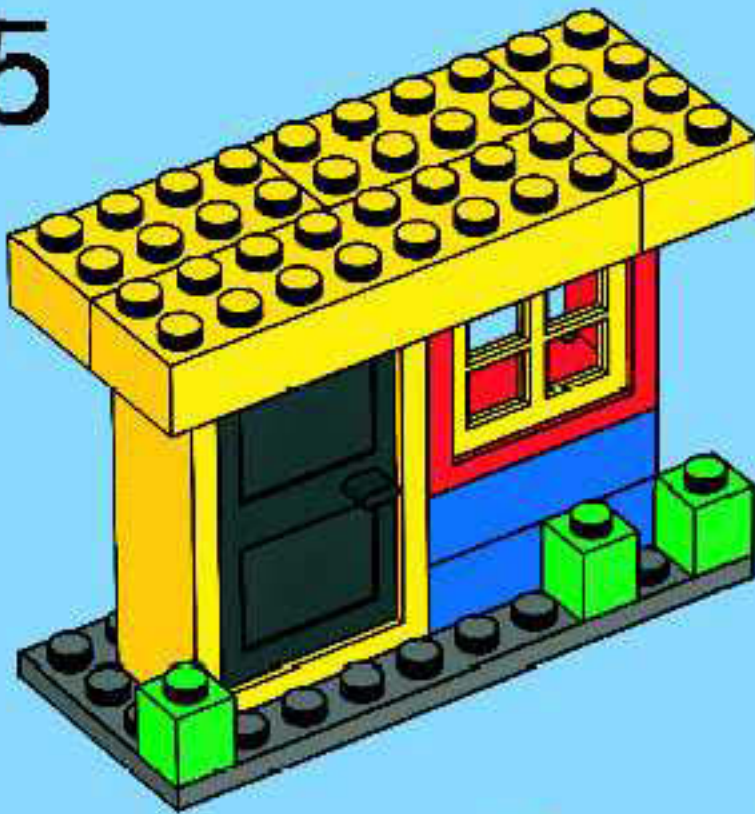

6

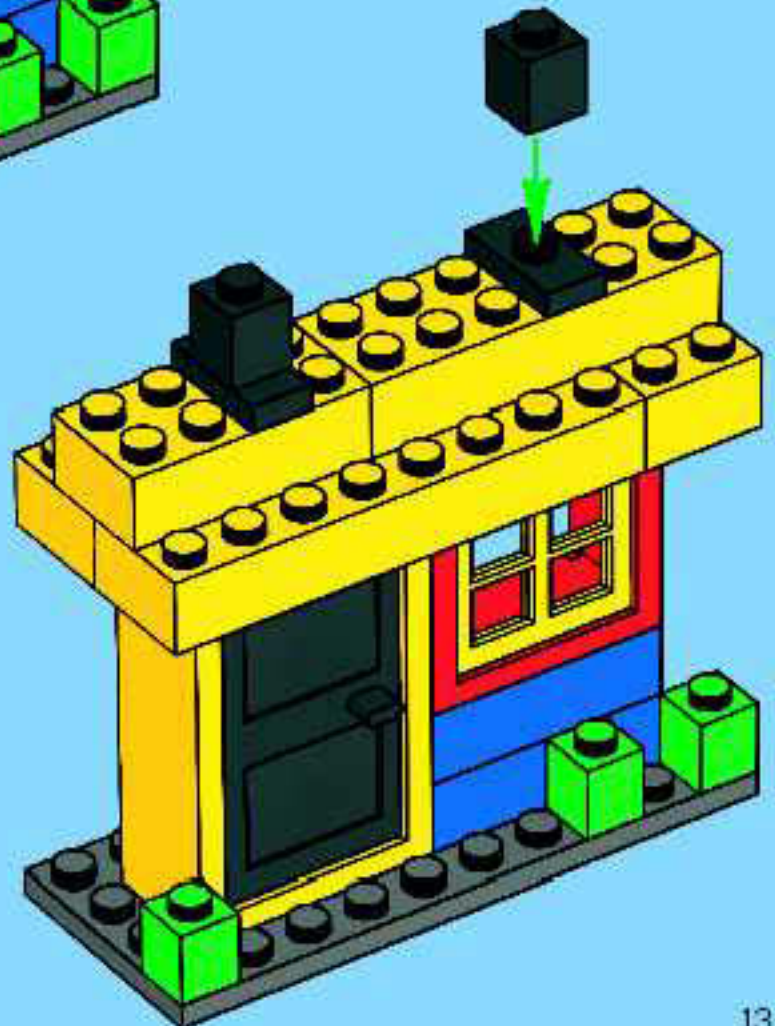

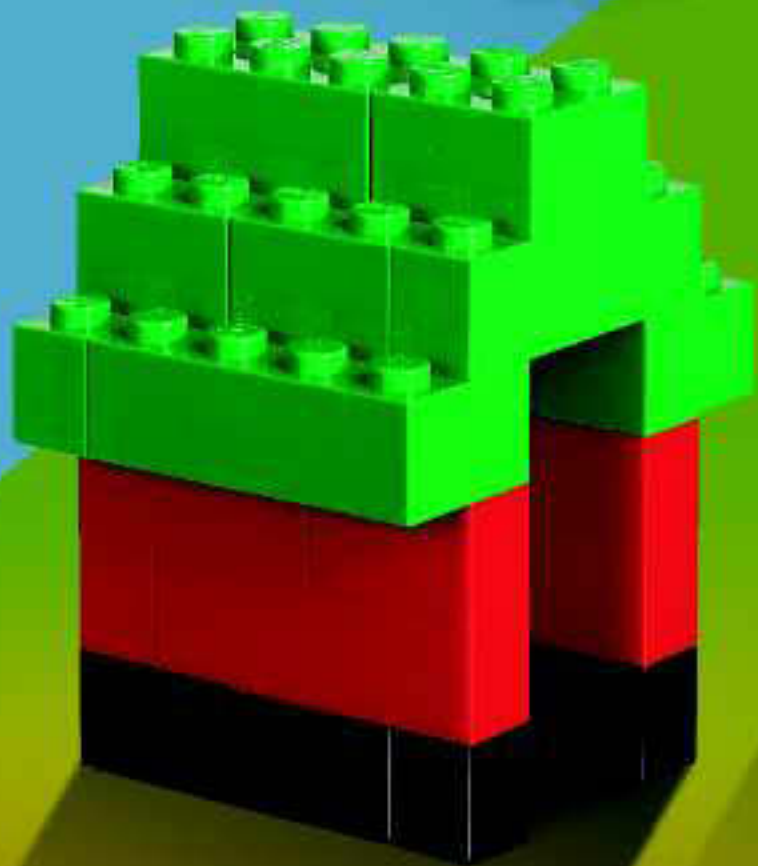
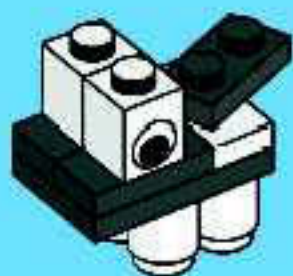
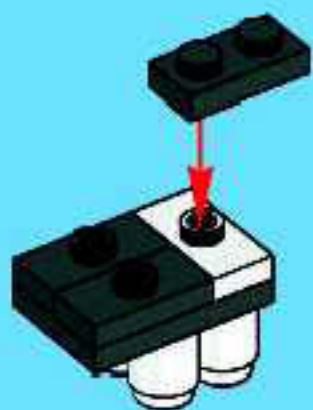





1

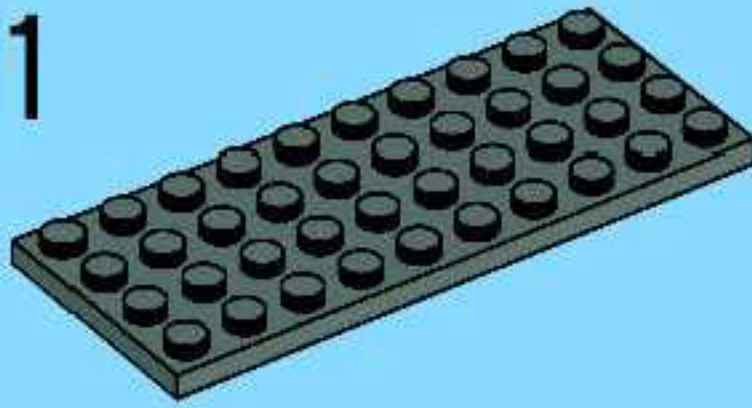

2

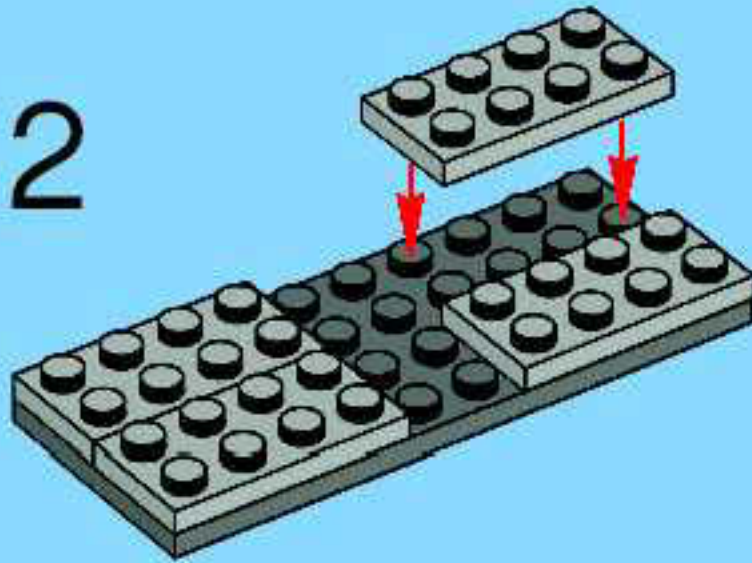

3

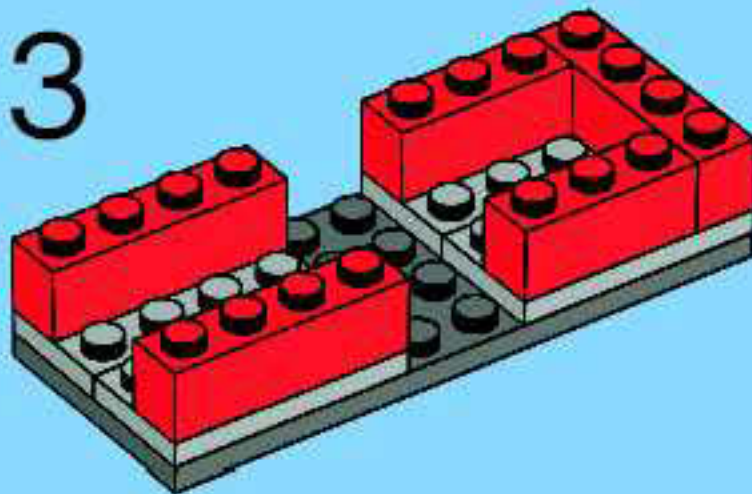



4

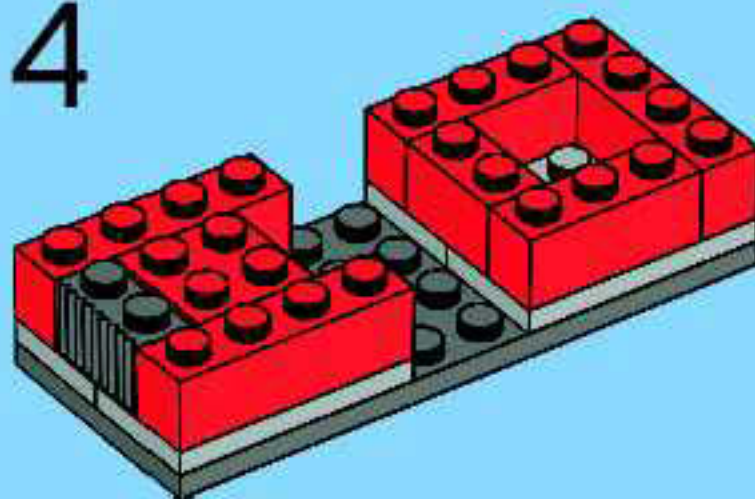

5

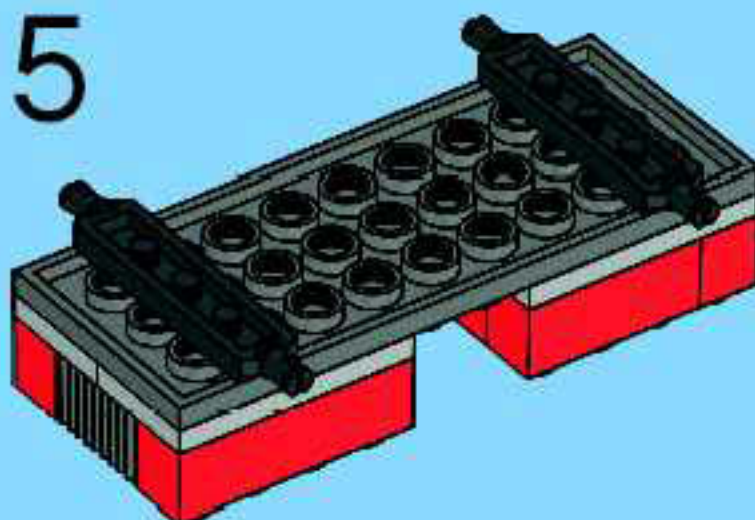

6

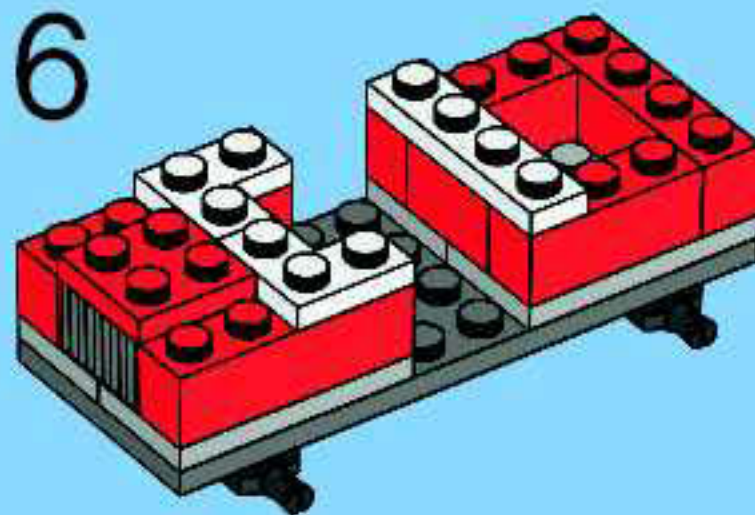

7

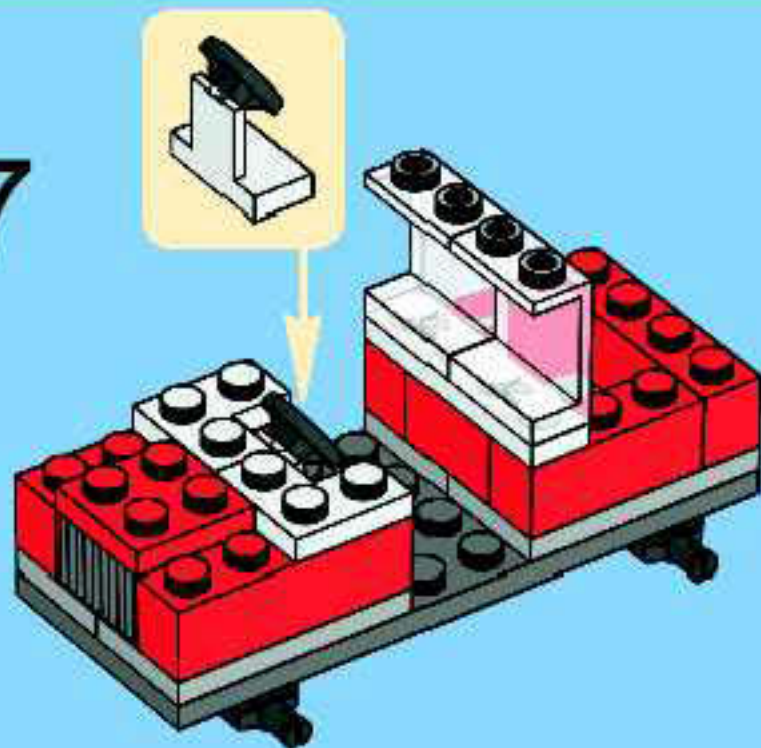

8

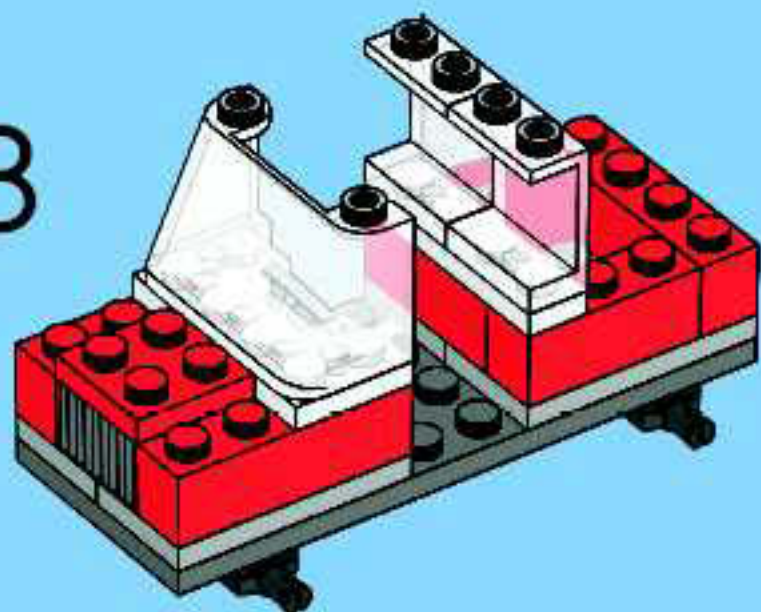

9

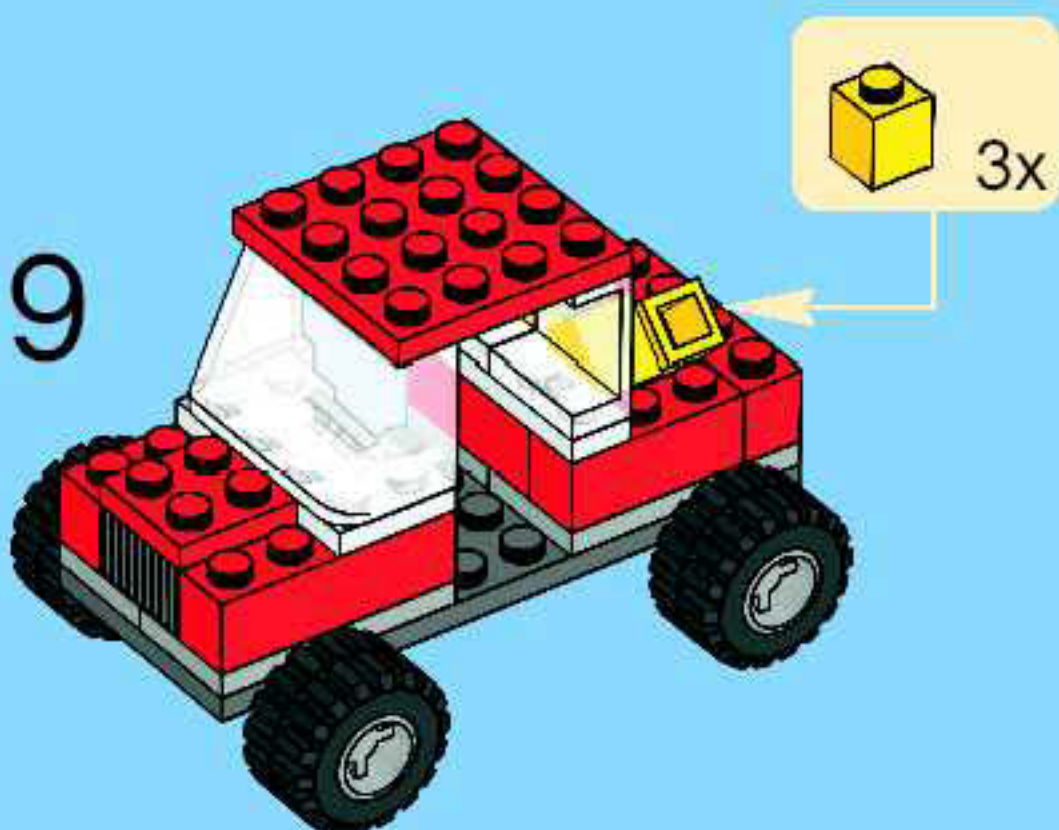



1

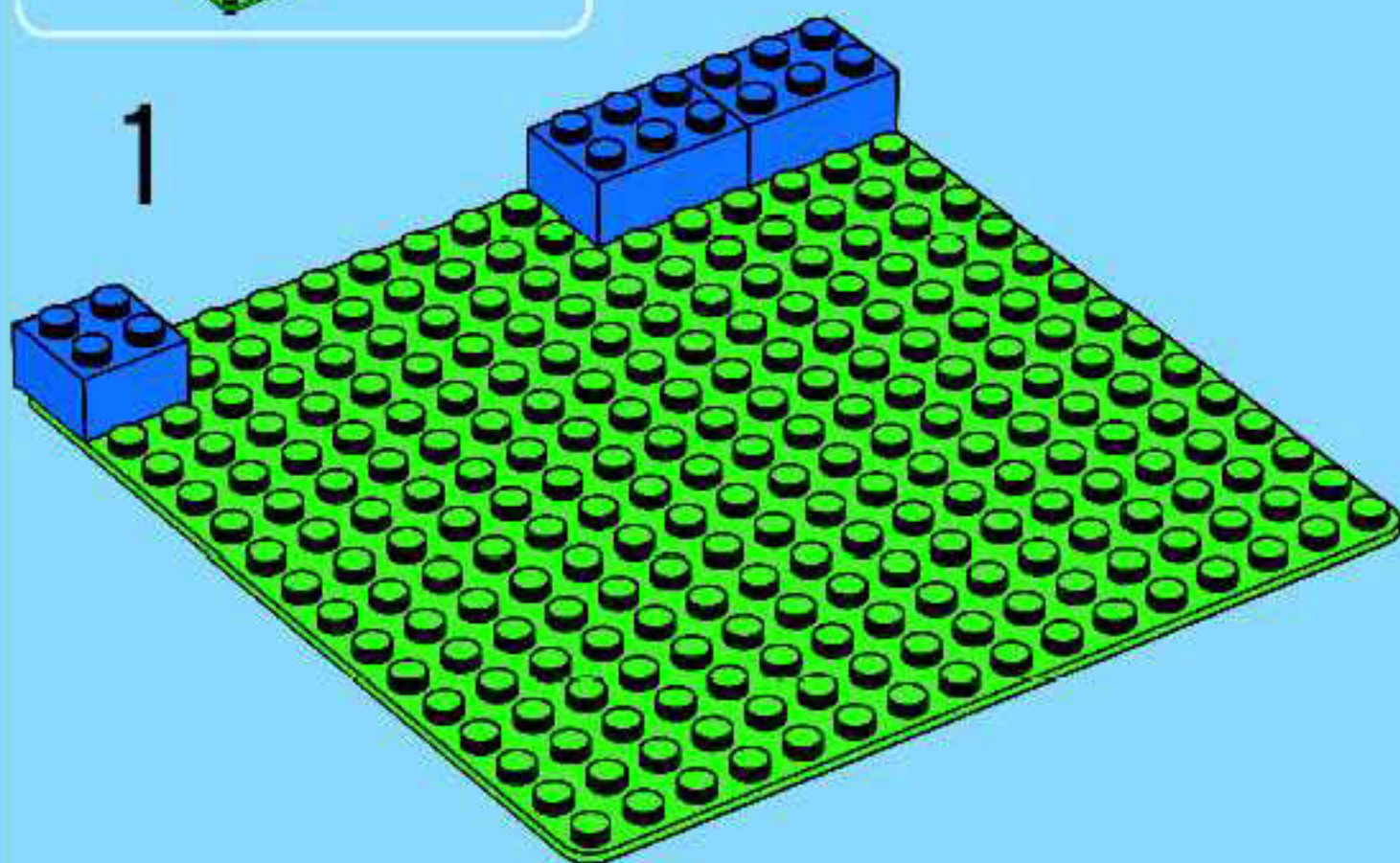

2

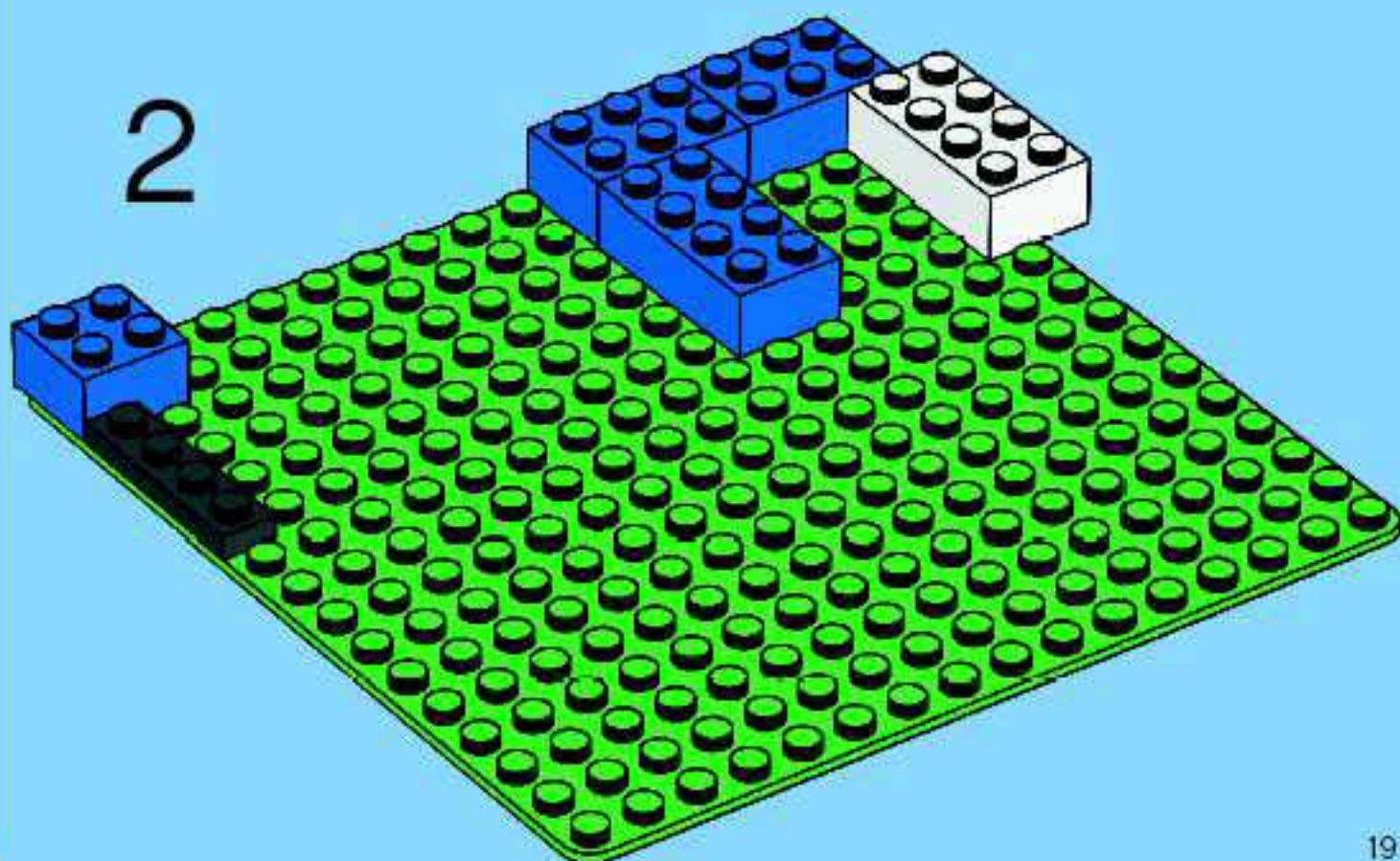

3

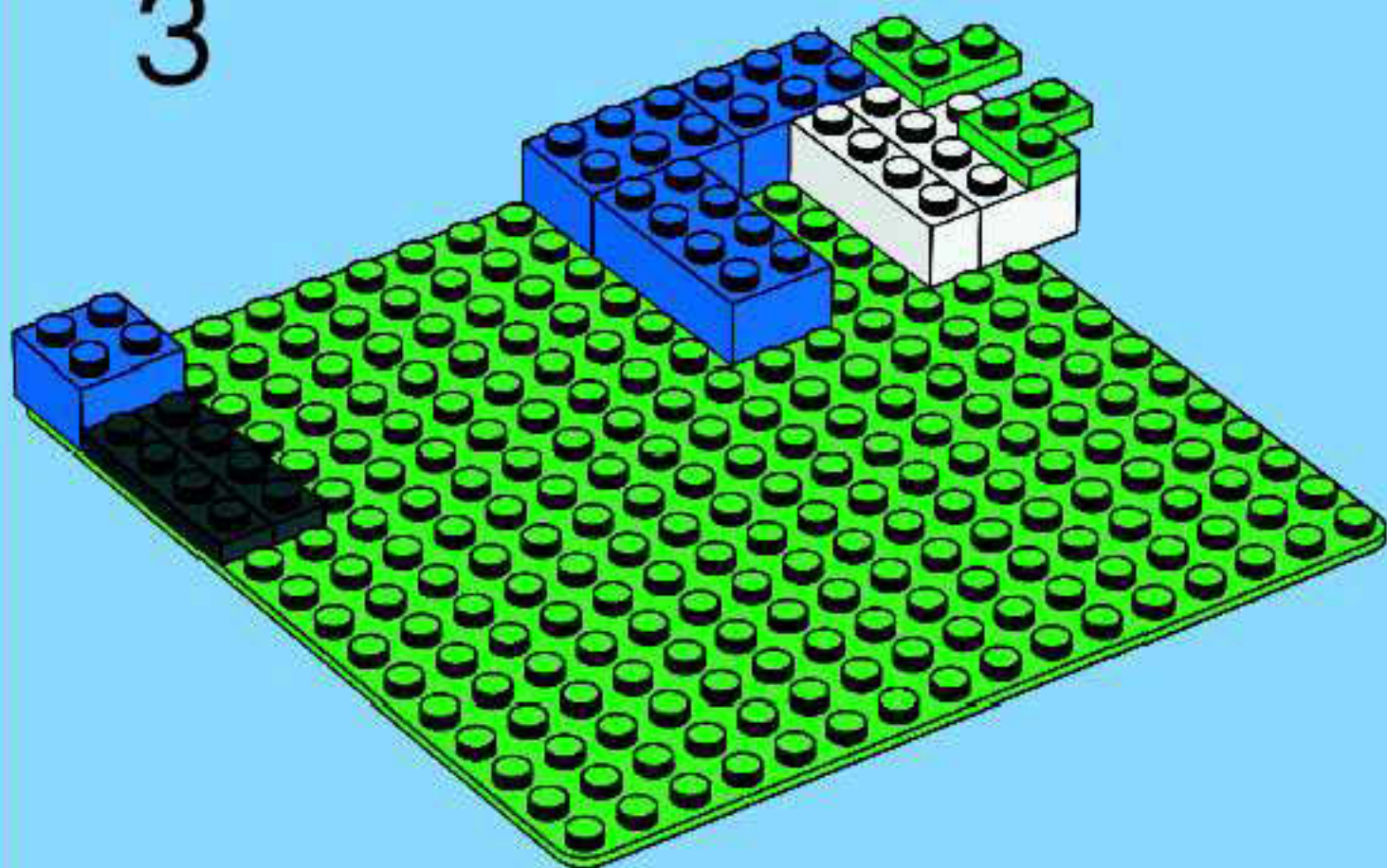

4

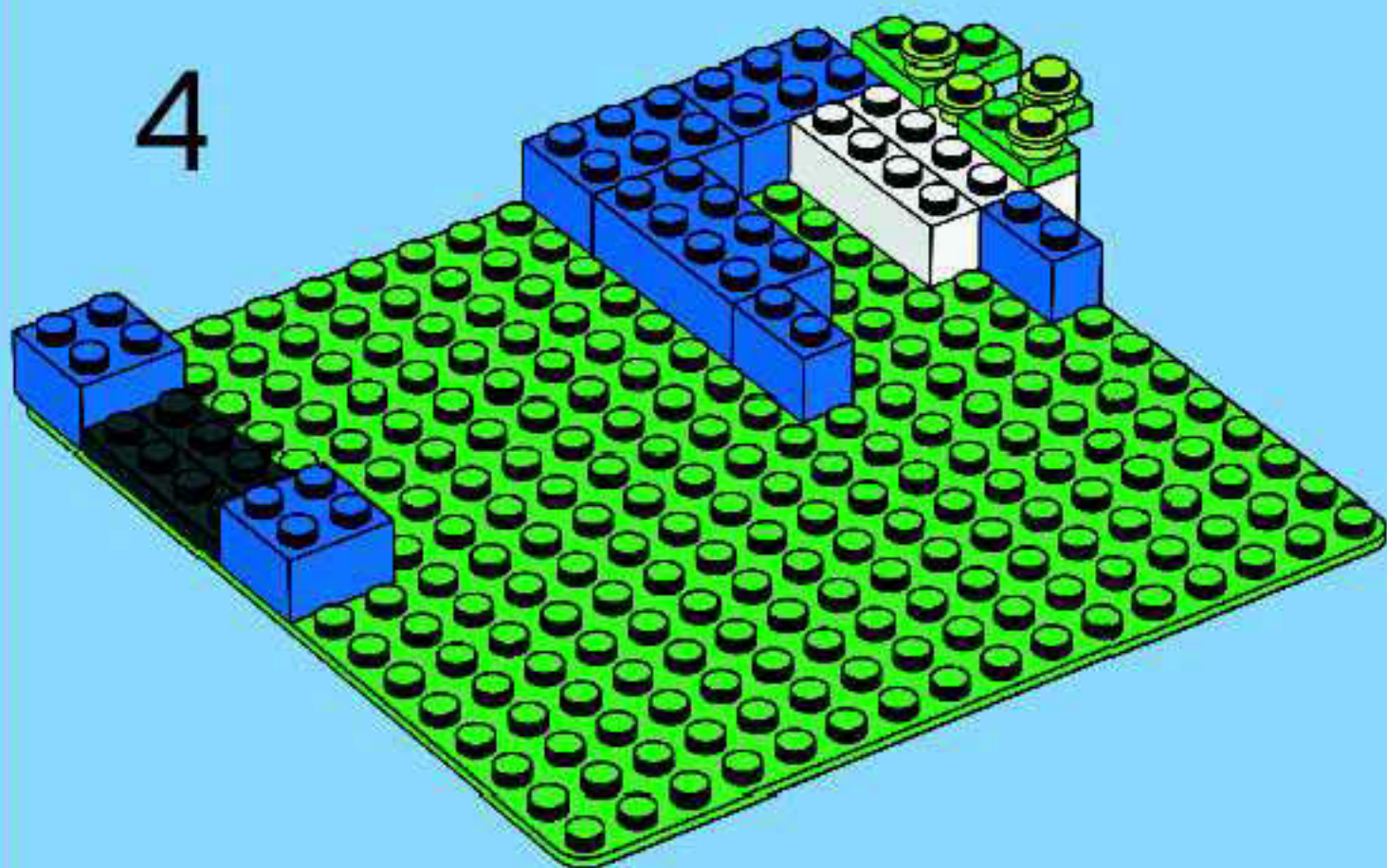

5

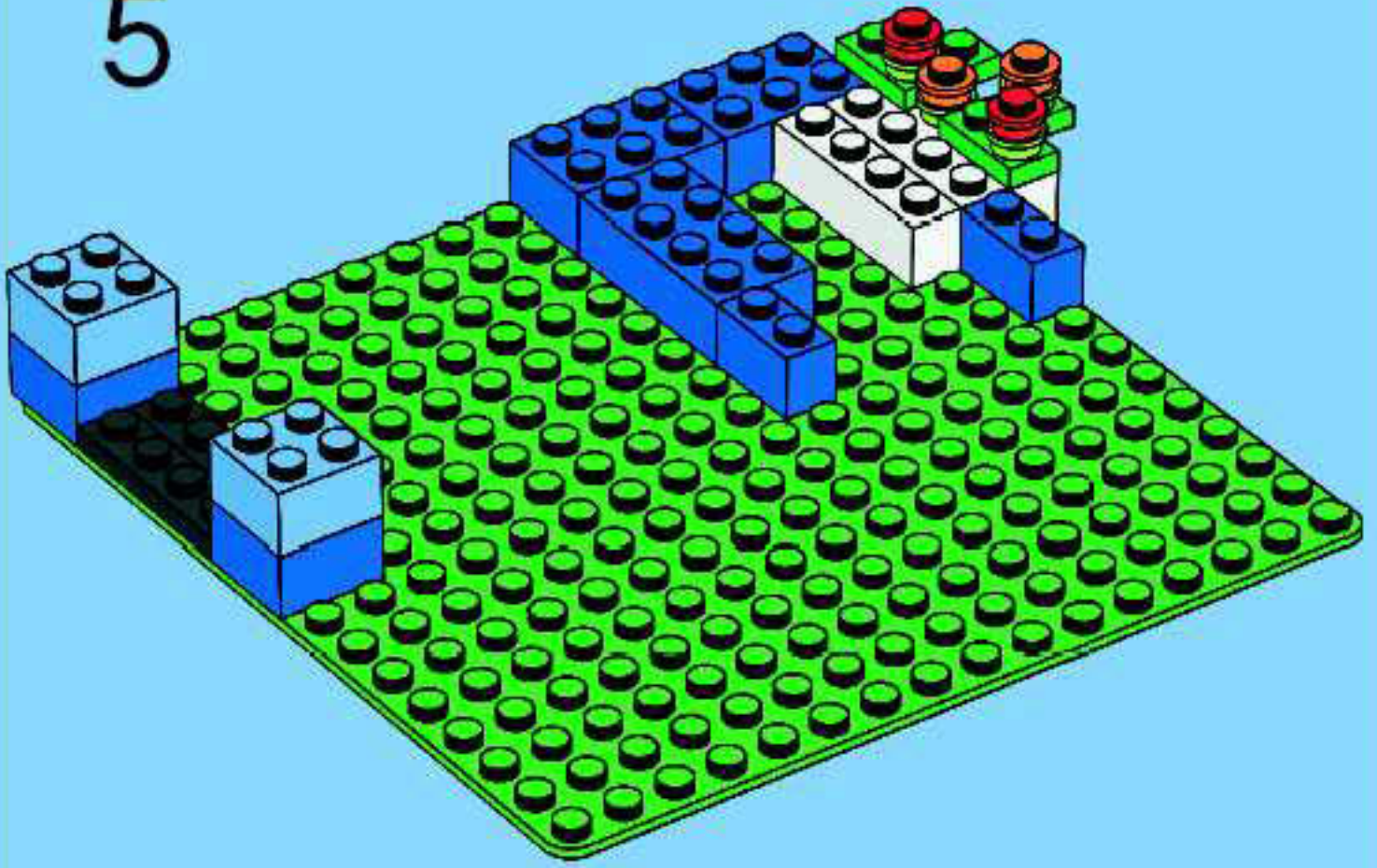

6

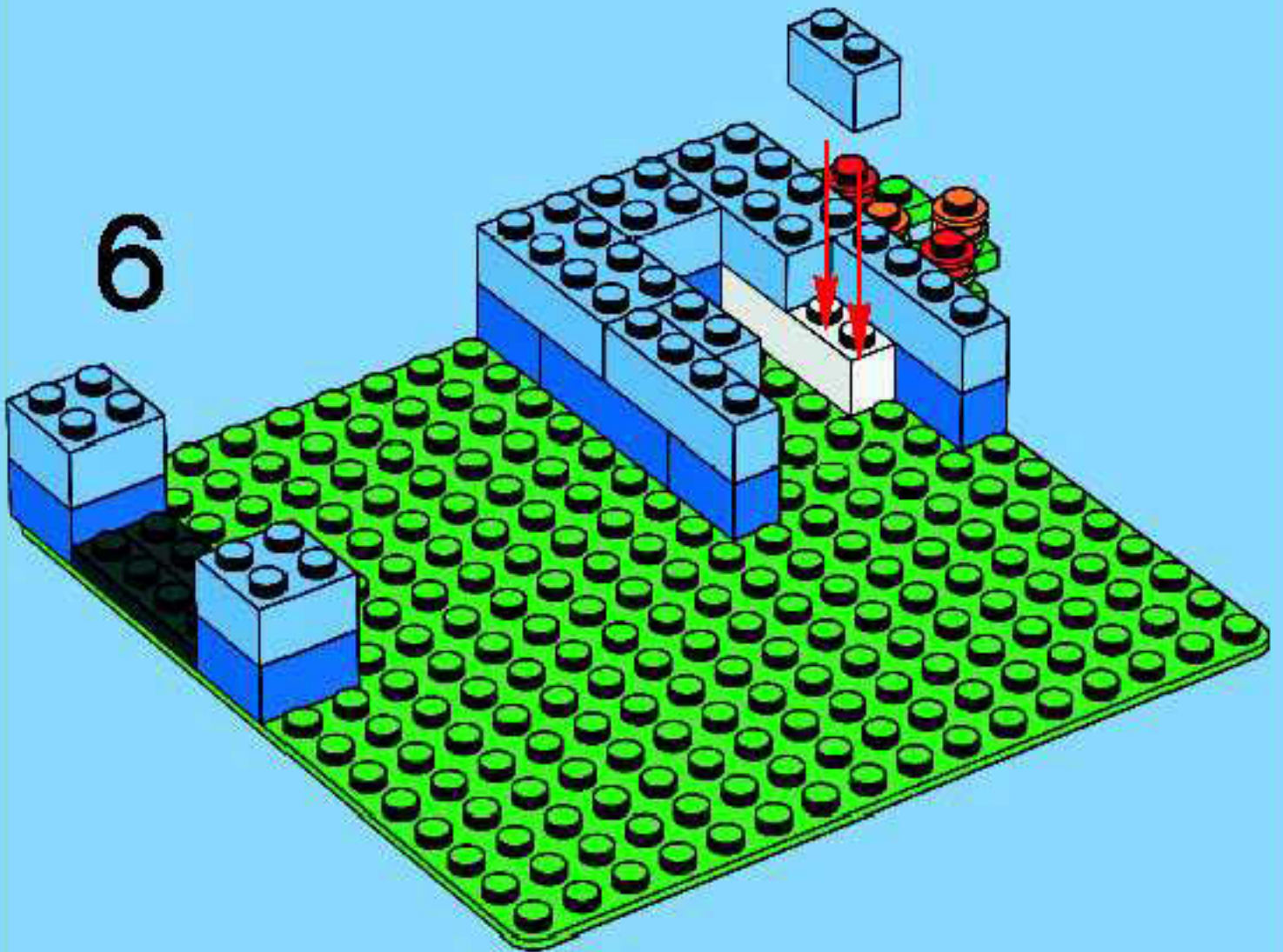

7

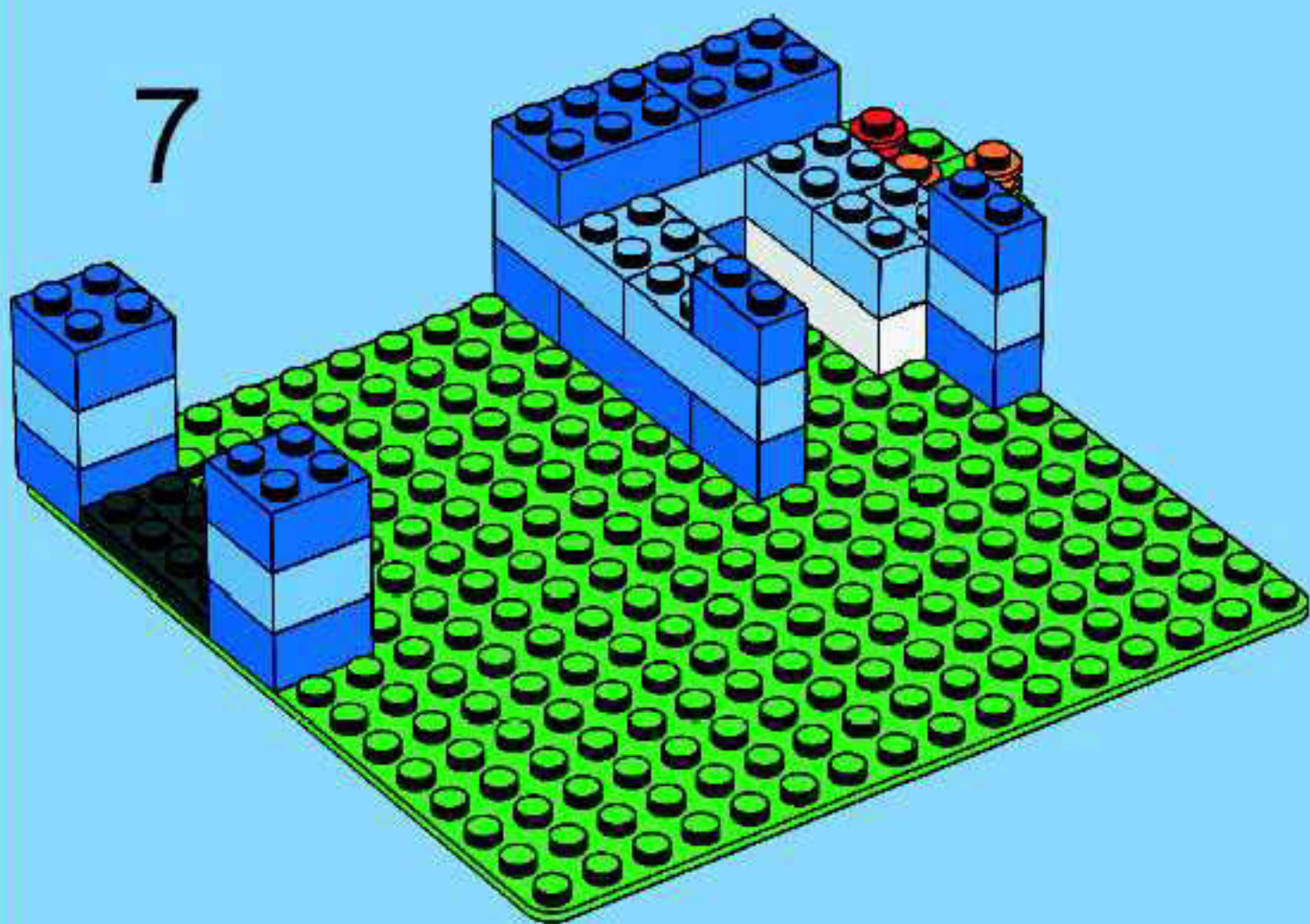

8

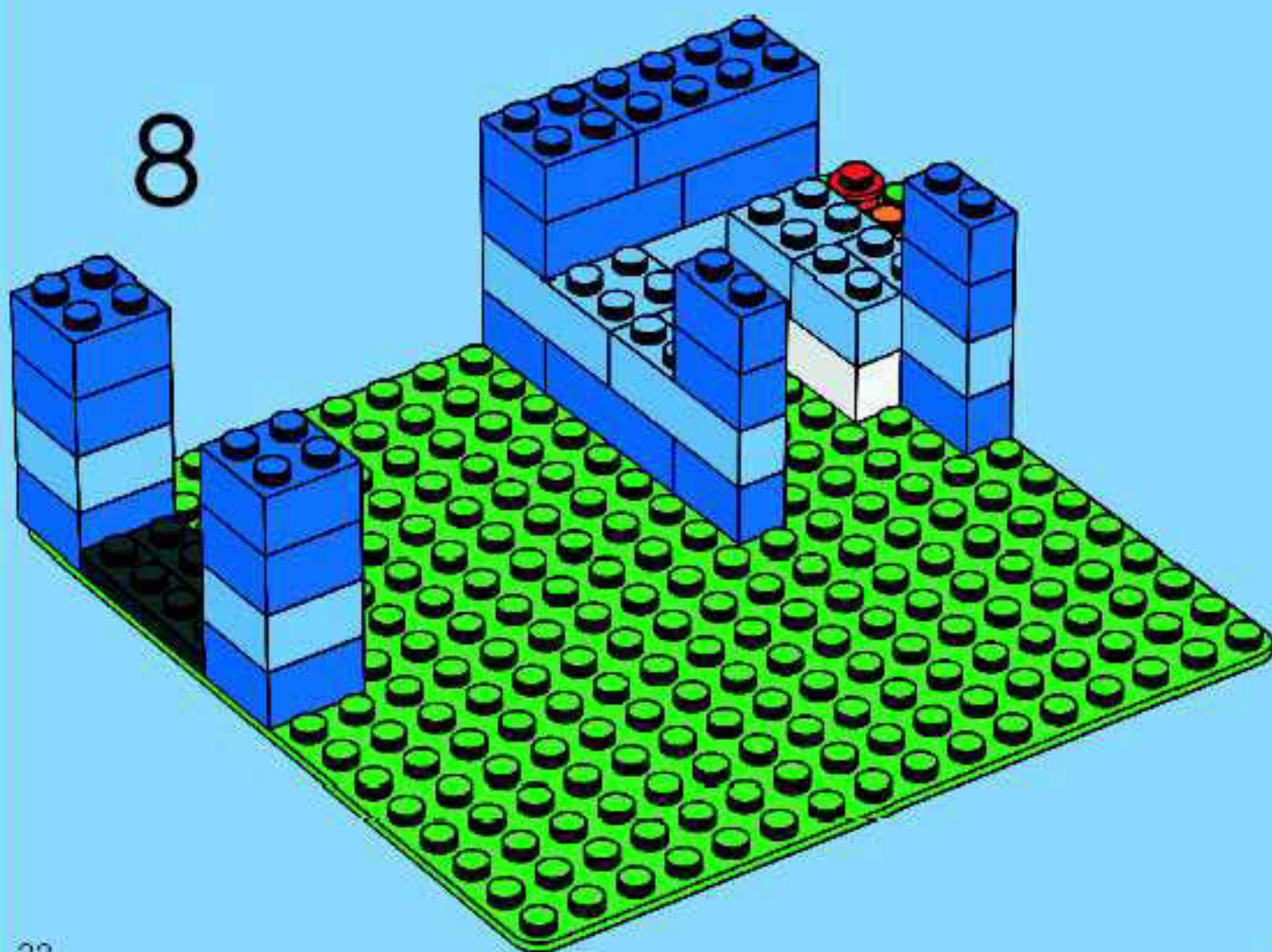

9

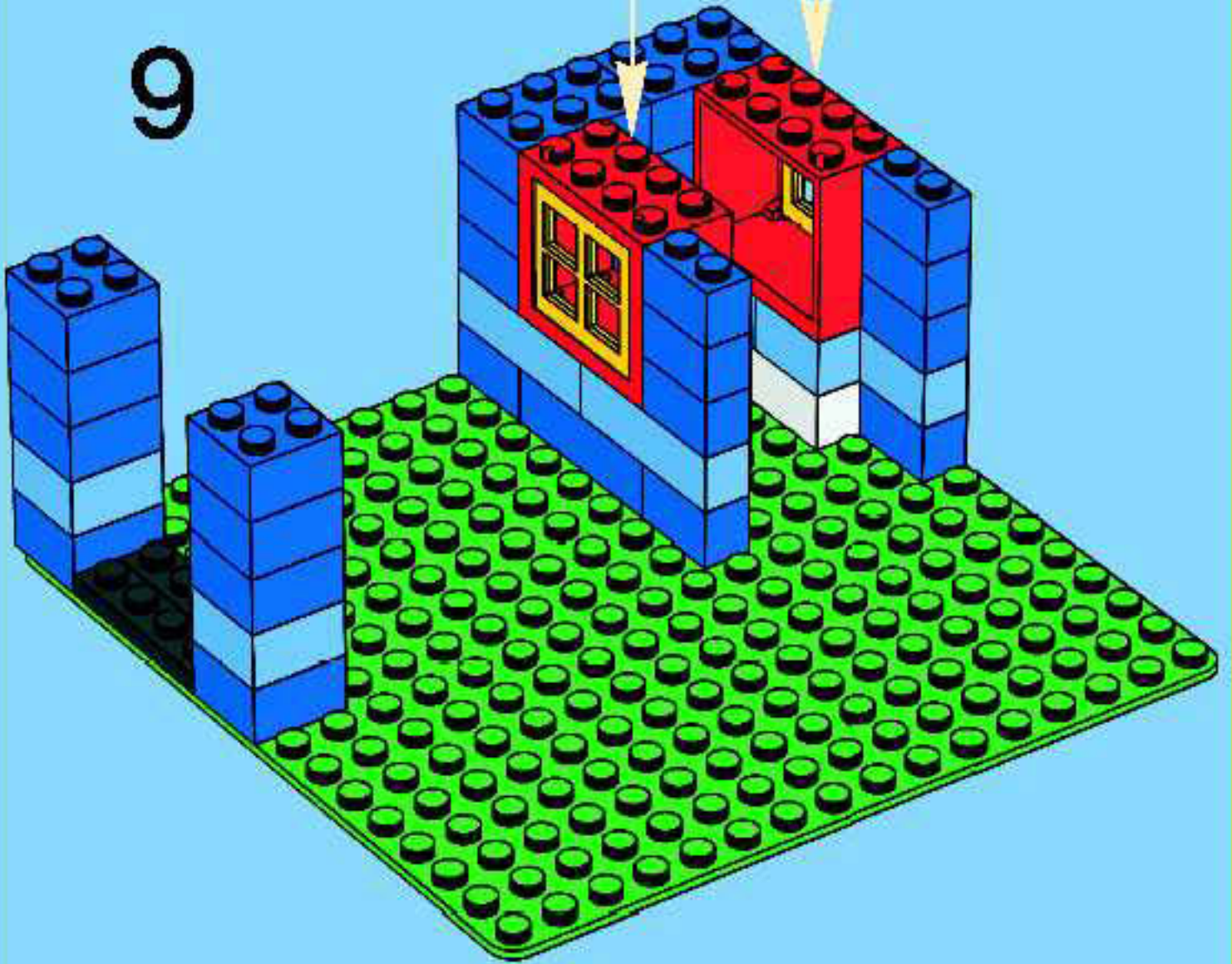
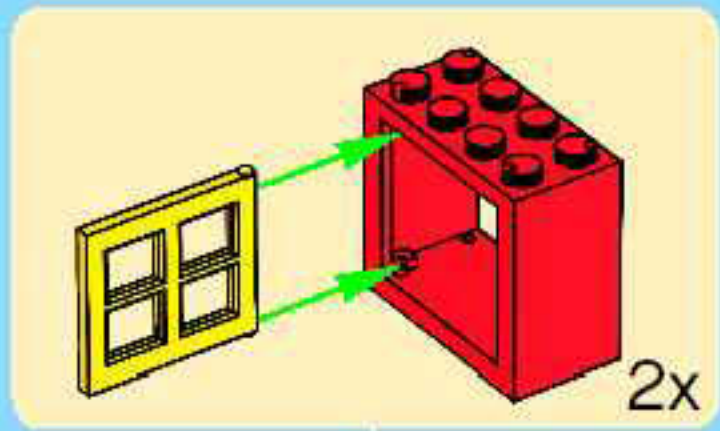

10

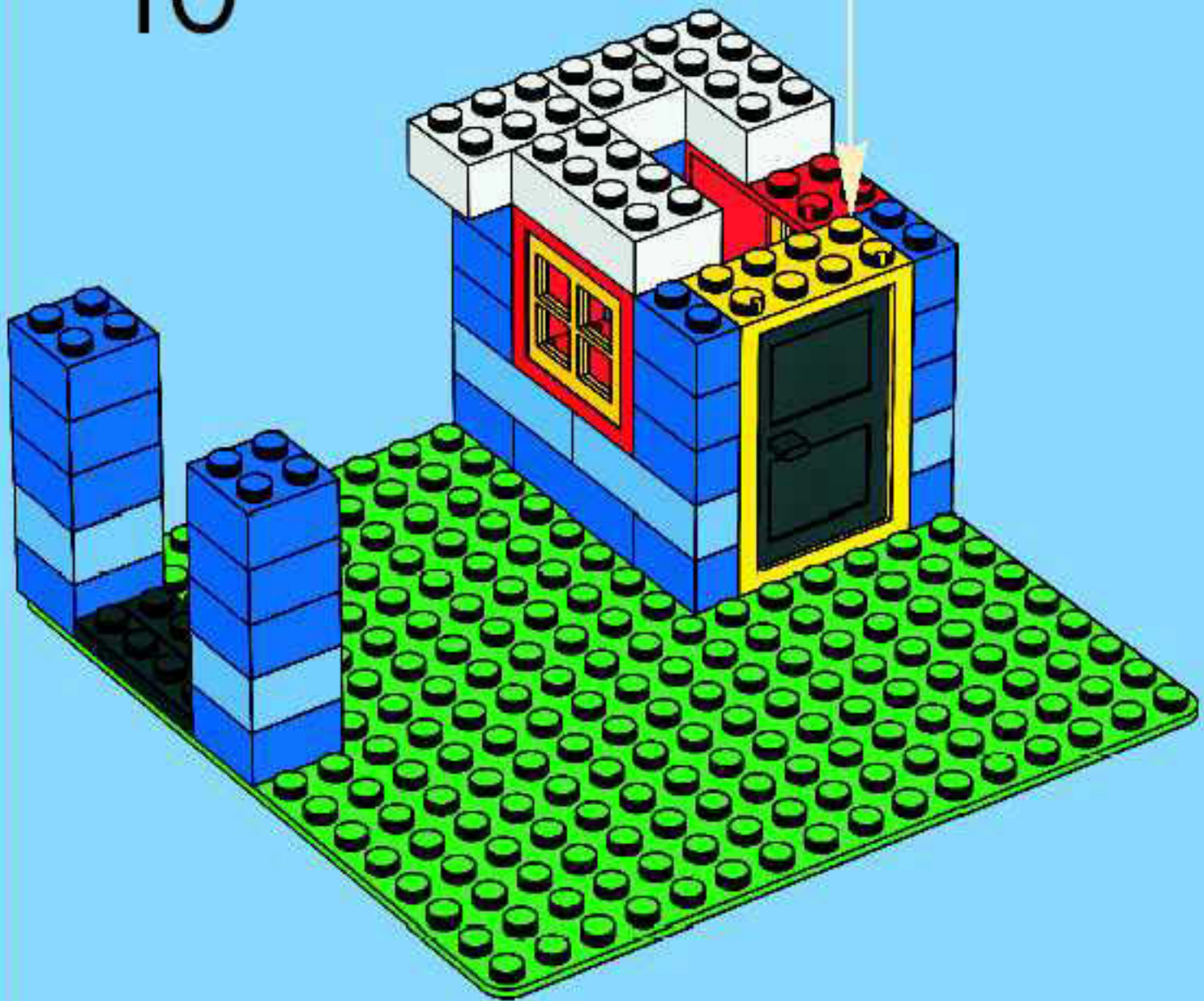
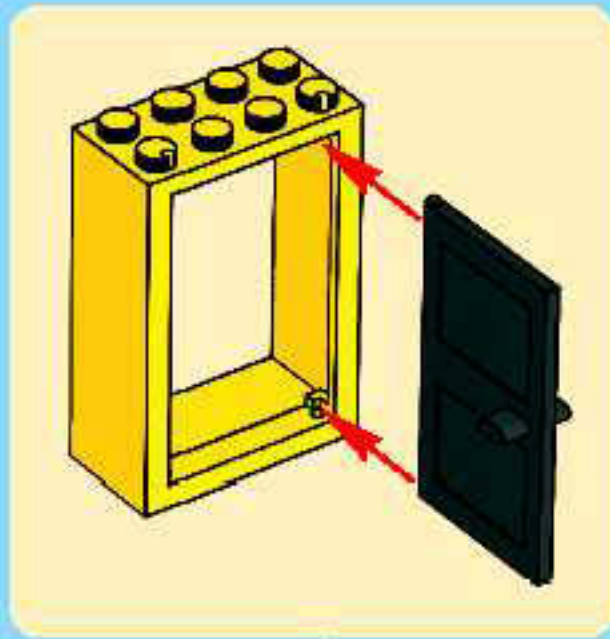



11

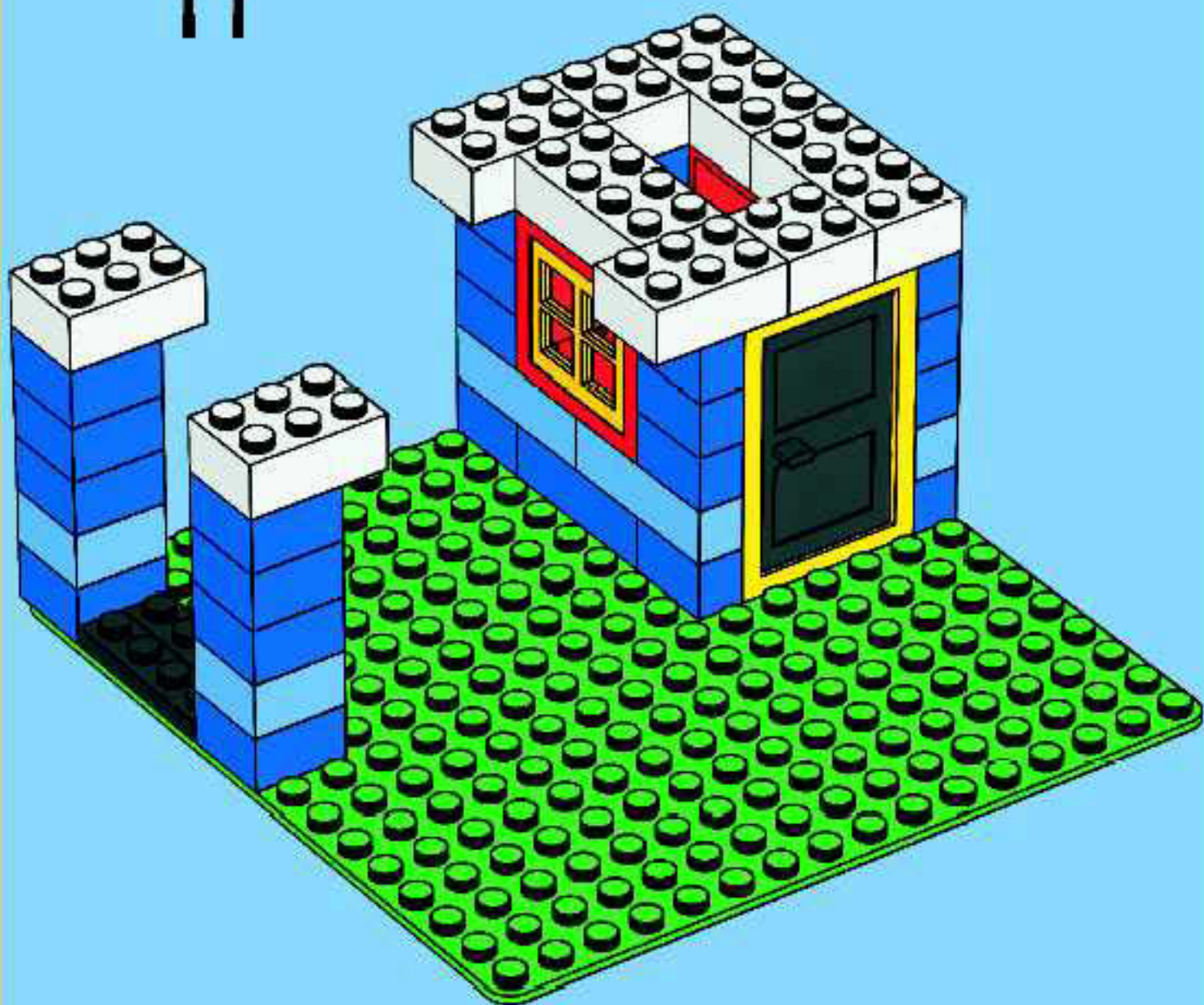

12

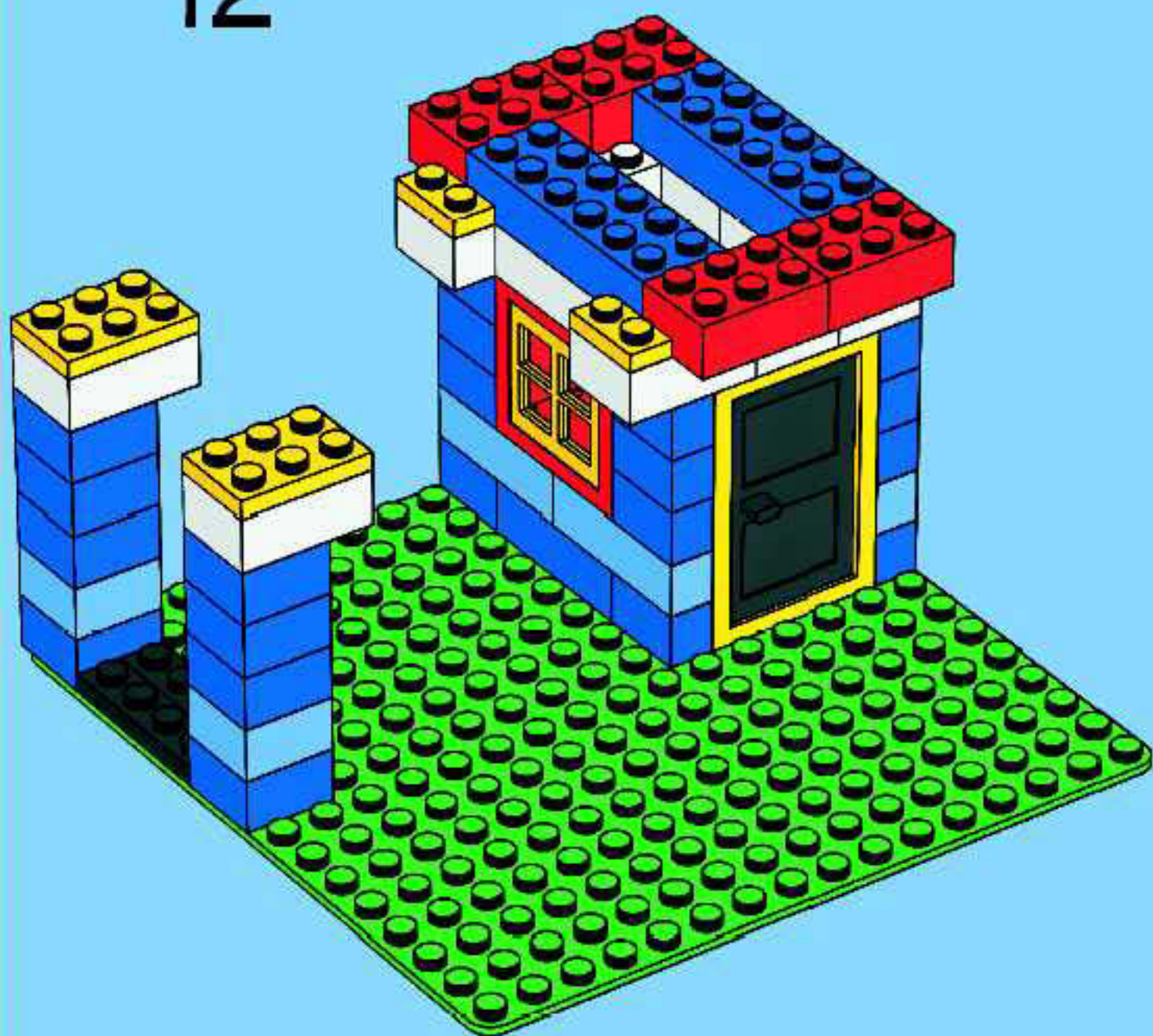

13

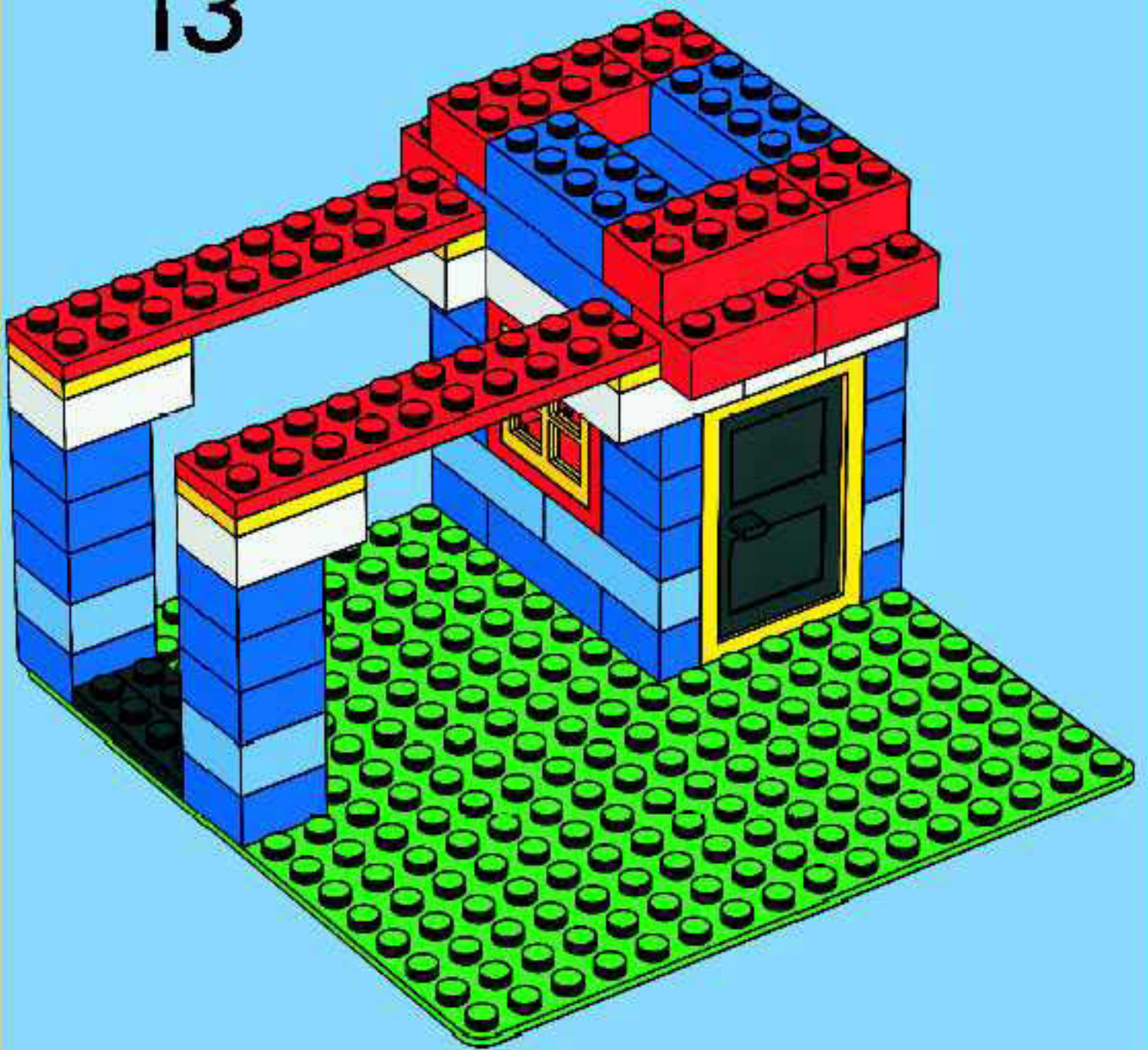

14

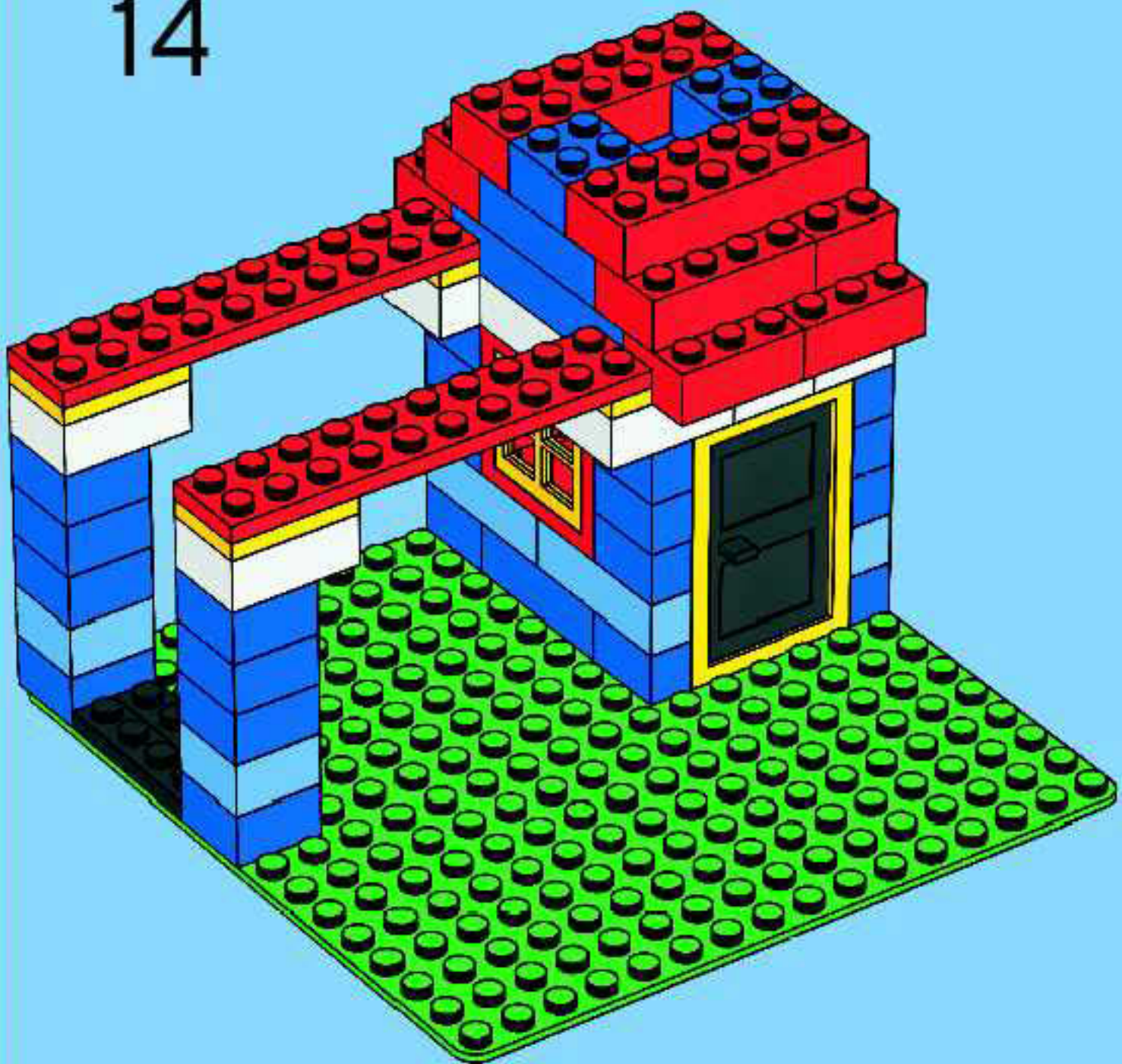

15

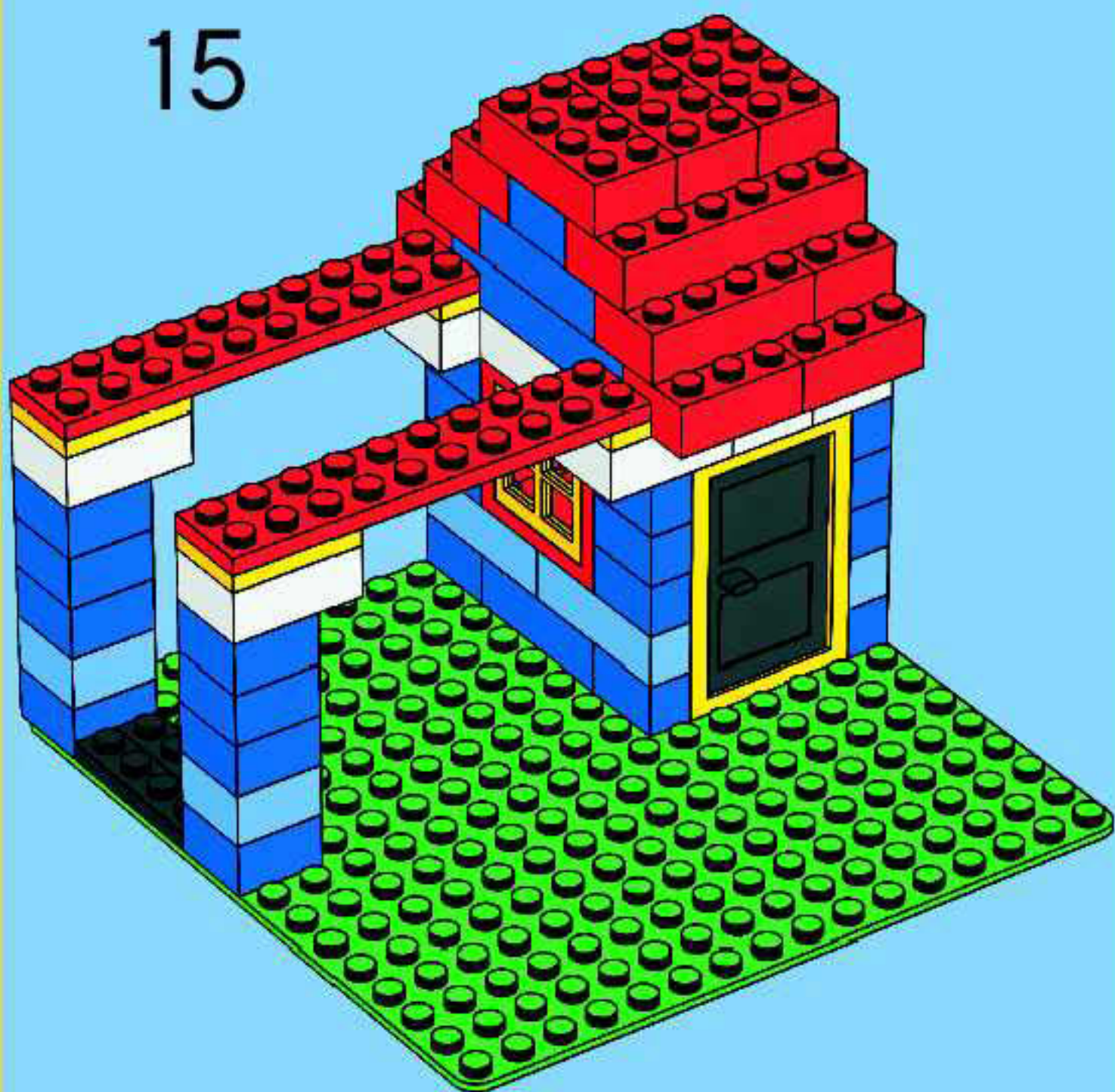

16















2x  
4140002

6x  
300101

8x  
300521

8x  
300523

2x  
4179833

8x  
300501

2x  
4181142

12x  
300421

12x  
300423

2x  
4163696

12x  
300401

1x  
300701

4x  
362221

4x  
362223

4x  
4201235

1x  
4160228

3x  
301021

3x  
301023

2x  
4205058

4x  
362201

1x  
9551

2x  
300921

3x  
300923

1x  
4288003

3x  
301001

2x  
242001

1x  
300821

2x  
300823

4x  
4183133

3x  
300901

2x  
379401

16x  
300321

16x  
300323

4x  
4211395

2x  
300801

2x  
4157103

6x  
300221

6x  
300223

4x  
4211764

16x  
300301

2x  
302221

6x  
300121

6x  
300123

2x  
4211056

6x  
300201

1x  
4243814

2x  
4181138

2x  
4181139

2x  
4211043

1x  
371001

2x  
303921

1x  
300721

1x  
300723

1x  
4210636

1x  
246001

2x  
614121

2x  
383221

1x  
9341

2x  
4121932

2x  
413221

1x  
448523

4x  
306201

1x  
4211122



8x  
300524



12x  
300424



4x  
362224



3x  
301024

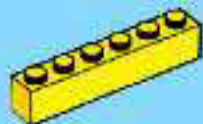

2x  
300924

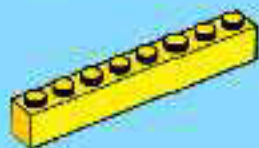

1x  
300824



16x  
300324



6x  
300224



6x  
300124



1x  
4181143

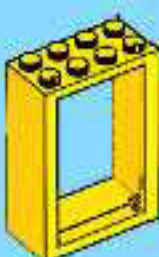

1x  
4217794

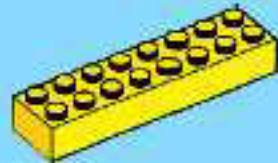

1x  
300724



1x  
408324



1x  
4168995



2x  
302324



2x  
302124



1x  
302024



2x  
366024



2x  
4113170



2x  
306540



2x  
622740



2x  
4113028



1x  
382340



4x  
300528



6x  
4107736



2x  
4109679



2x  
4112838



8x  
300328



3x  
4109674



3x  
4106356



2x  
4157120

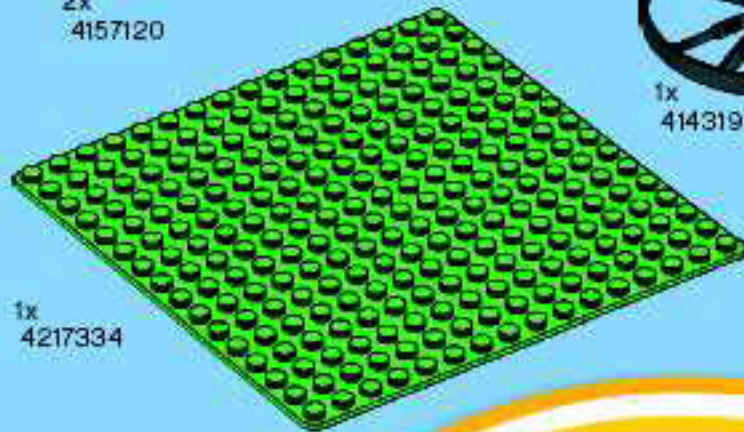

1x  
4217334



2x  
292626



4x  
300526



6x  
300426



2x  
362226



2x  
301026



8x  
300326



3x  
300226



3x  
300126



4x  
601526



1x  
4217795



2x  
302326



2x  
379426



4x  
371026



2x  
302226



1x  
302126



1x  
247926



1x  
4143199



Customer Service  
Kundenservice

Service Consommateurs  
Servicio Al Consumidor

[www.lego.com/service](http://www.lego.com/service) or dial



: 00800 5346 5555

: 1-800-422-5346



626



628



6119



6117



6177



6118



5582



6186

6187



4+

6187



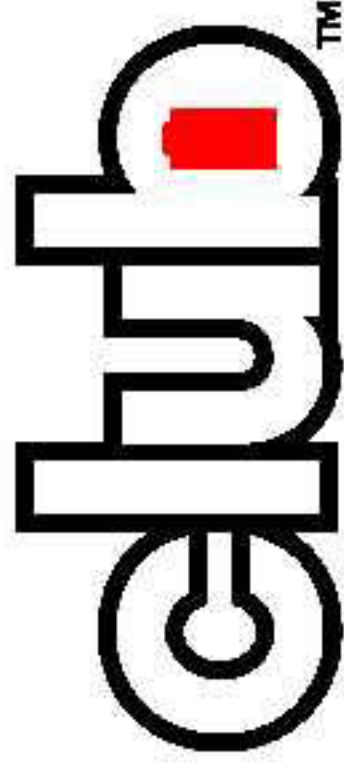

FREE LEGO Magazine • GRATUIT • GRATIS LEGO Magazin

**Join Today!**

**Abonne-toi**

**dès aujourd'hui !**

**Meld je nu aan!**

**Jetzt anmelden!**



US & Canada only

1-866-534-6258 / 1-877-518-5346  
(in France)



00800 5346 5555

**www.LEGOclub.com**



**VISIT THE WORLD'S  
BIGGEST LEGO® SHOP!  
www.LEGOshop.com**

## WIN LEGO® PRODUCTS

No purchase necessary.  
Open to residents of all countries where  
not prohibited.  
Go to [www.lego.com](http://www.lego.com) for official rules and details.

## WIN LEGO® PRODUCTEN

Kopen niet nodig.  
Open voor alle leeftijden, en in alle landen  
waar geen verbod geldt.  
Ga naar [www.lego.com](http://www.lego.com) voor officiële regels en details.

## GEWINNE LEGO® PRODUKTE

Die Teilnahme am Gewinnspiel führt zu  
keinerlei Kaufverpflichtungen.  
Sie können in allen nicht ausgeschlossenen  
Ländern teilnehmen.  
Die offiziellen Regeln und nähere Informationen  
finden Sie unter [www.lego.com](http://www.lego.com).

## GAGNE DES PRODUITS LEGO®

Aucun achat n'est nécessaire.  
Ouvert à tous les âges et aux résidents de  
tous les pays, sauf en cas d'interdiction.  
Rendez-vous sur [www.lego.com](http://www.lego.com) pour obtenir plus  
de détails et le règlement officiel.

## レゴ®製品を「当てよう」

購入は不要です  
禁止されていない限り、あらゆる  
年代およびあらゆる国の居住者の  
方々にご利用いただけます。  
公認規則および詳細につきましては、  
[www.lego.com](http://www.lego.com)をご覧ください

[www.acnielsen.aim.dk/LEGO](http://www.acnielsen.aim.dk/LEGO)

