

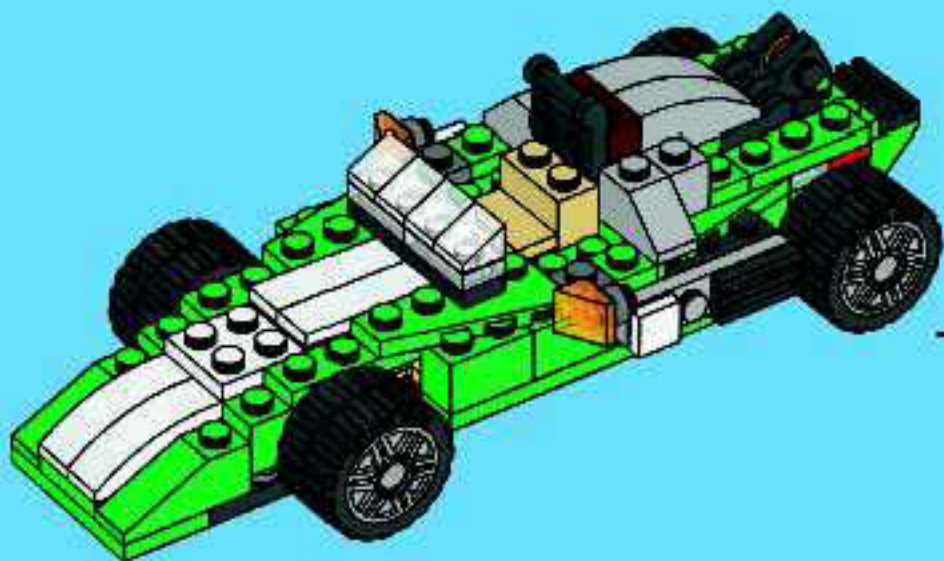

# CREATOR

6743

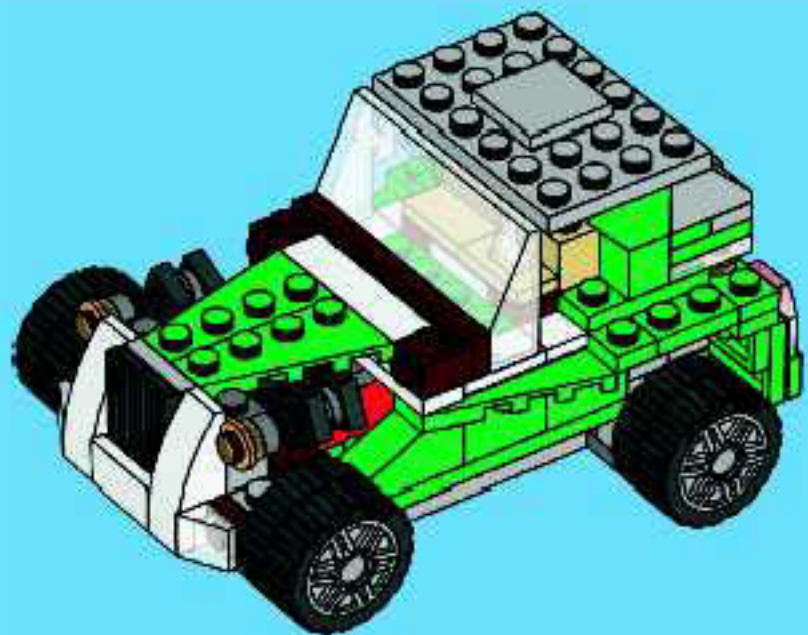





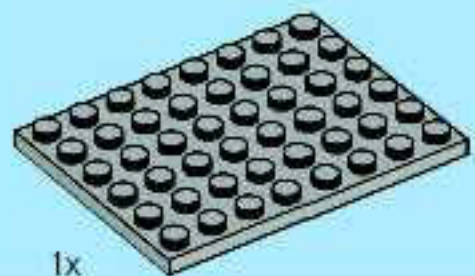

1x

1

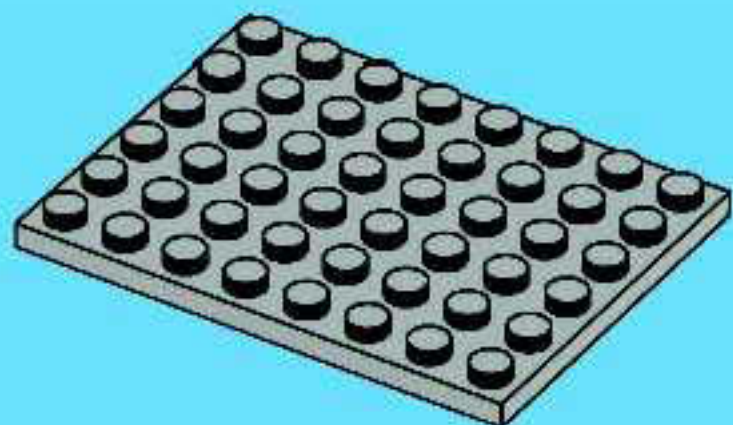

1x



2x

2

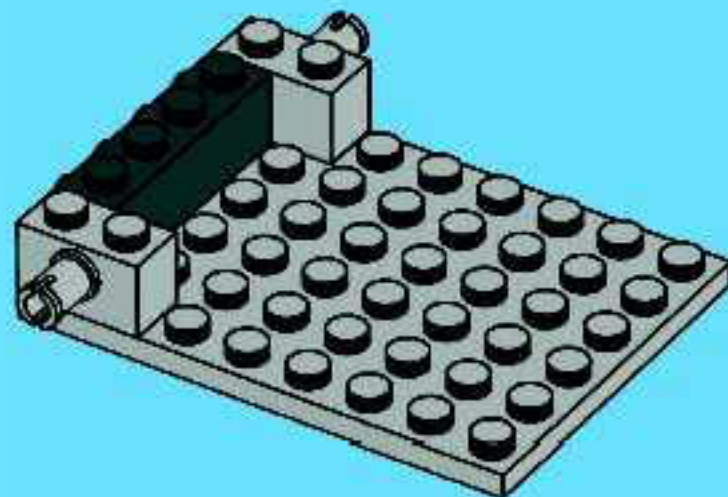



1x



1x



1x



2x

3

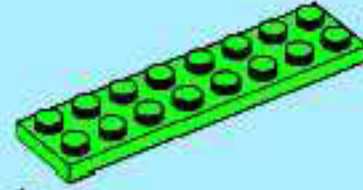
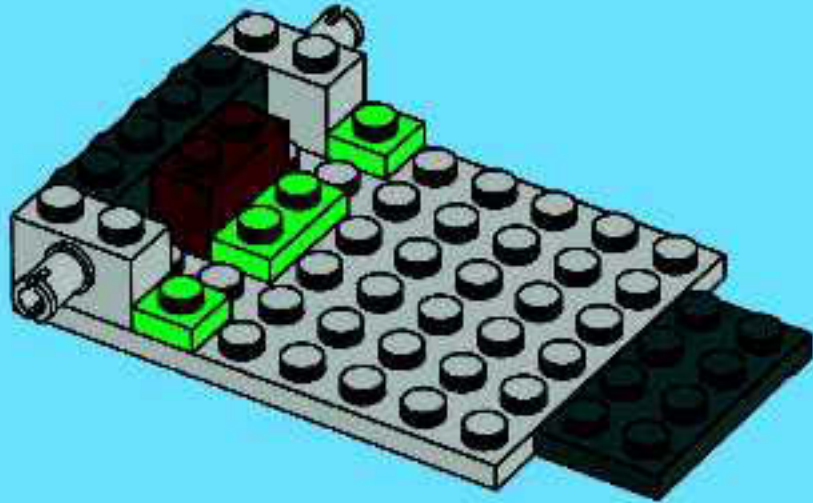

1x

4

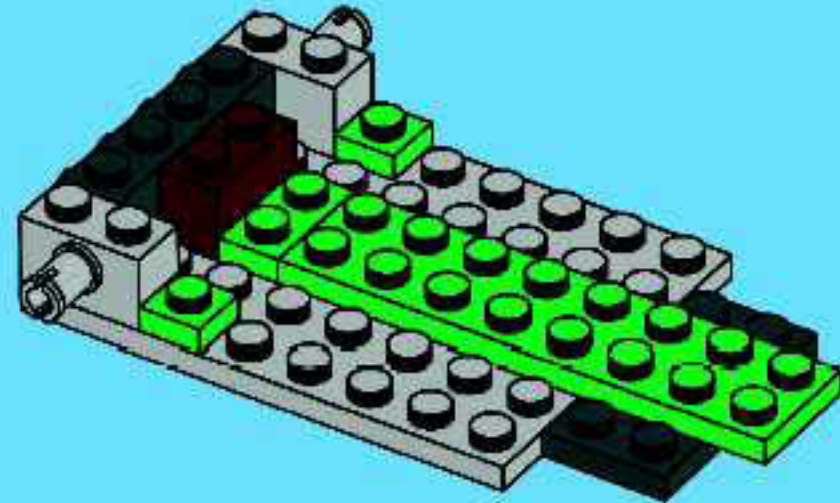

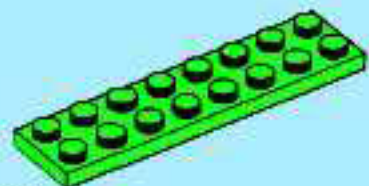

2x

5

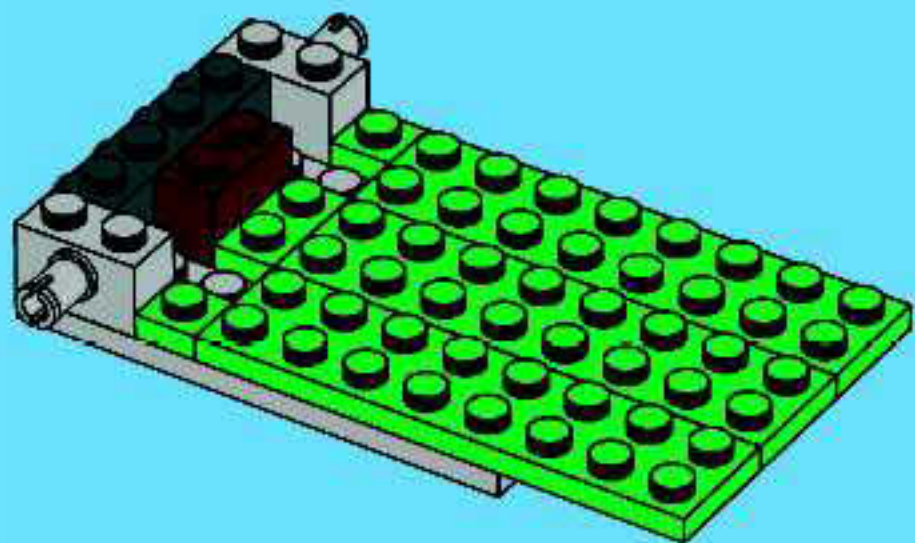

2x

6

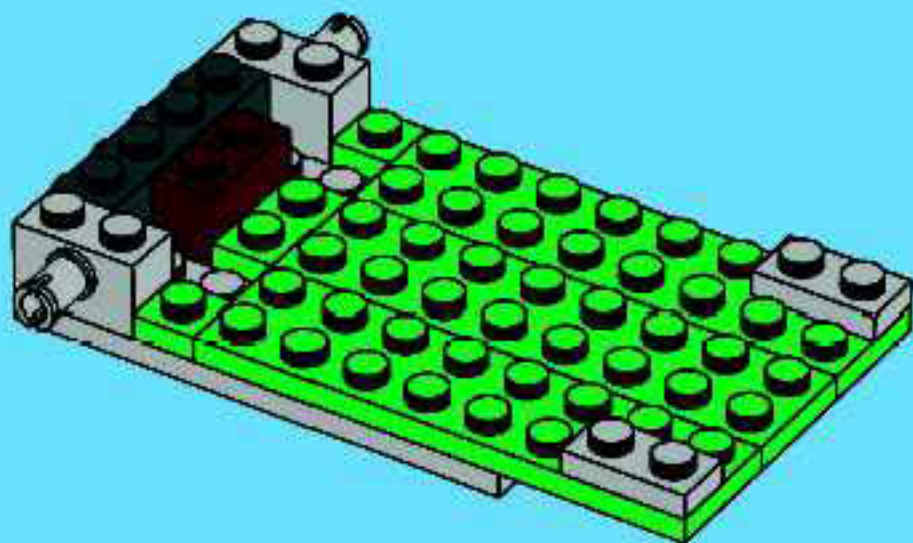





2x



2x

7

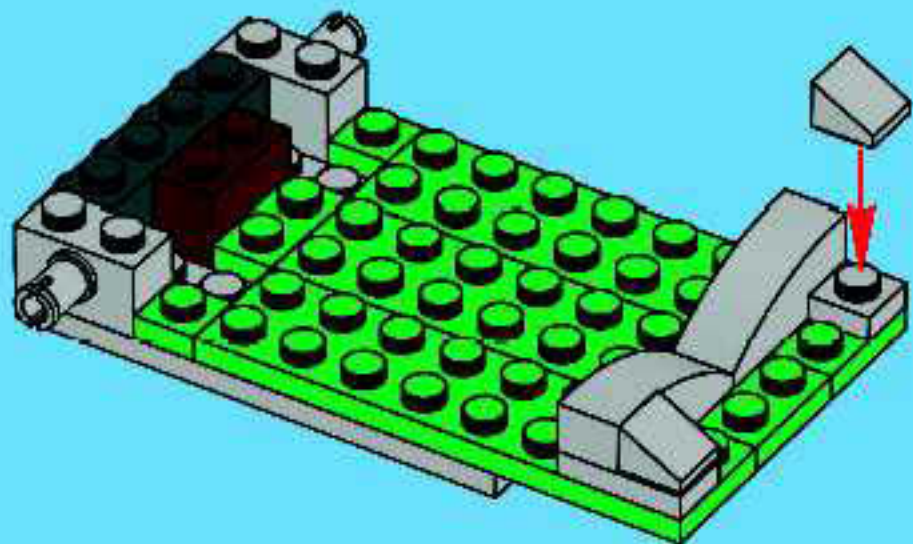

6



1x



1x

8

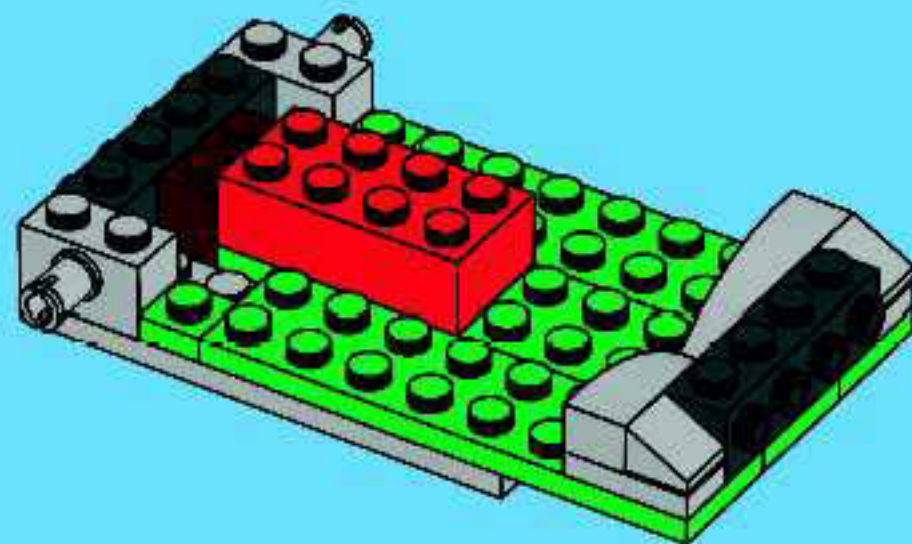

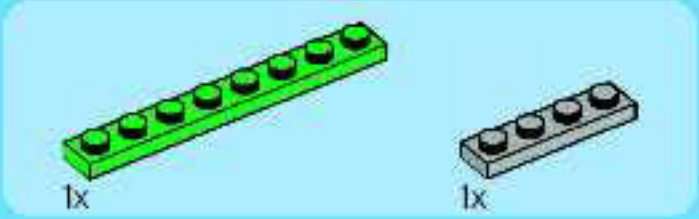

9

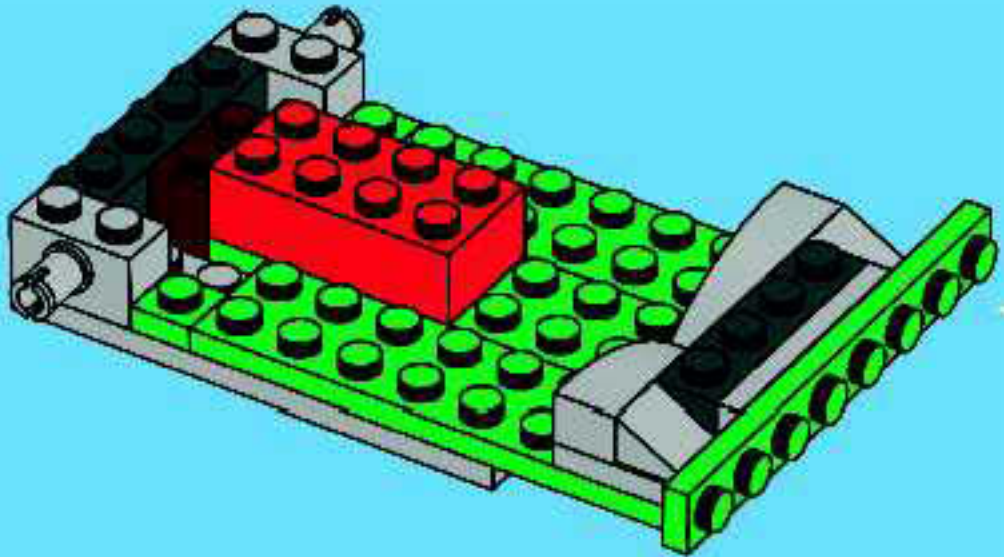
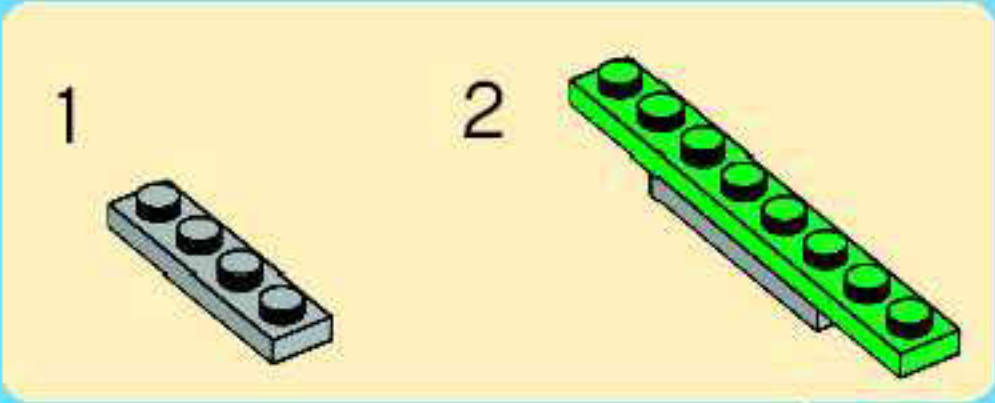

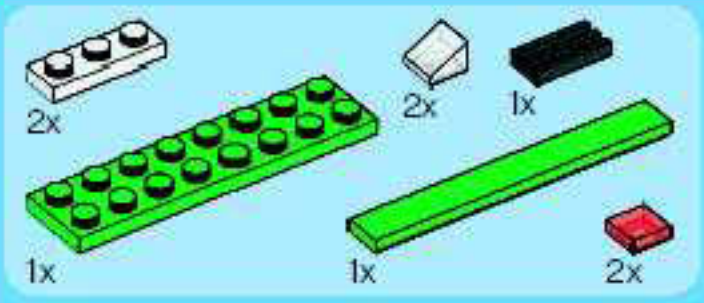

10

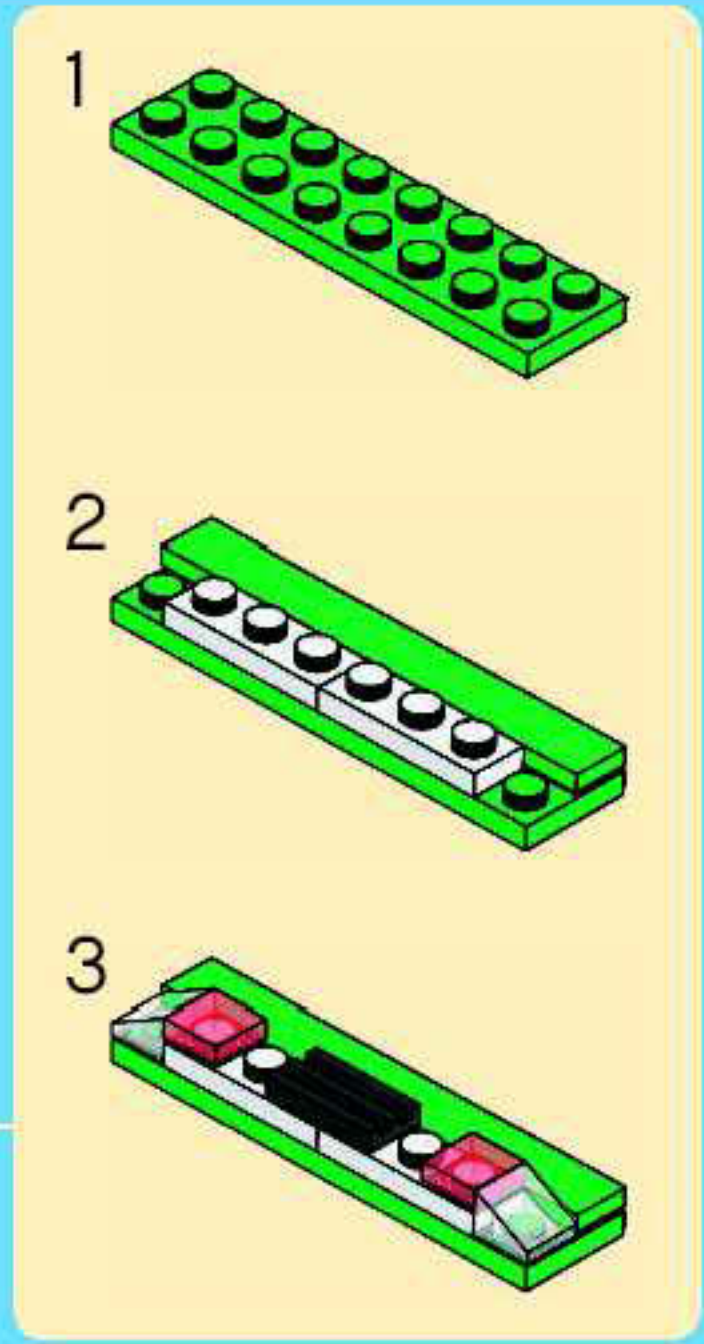
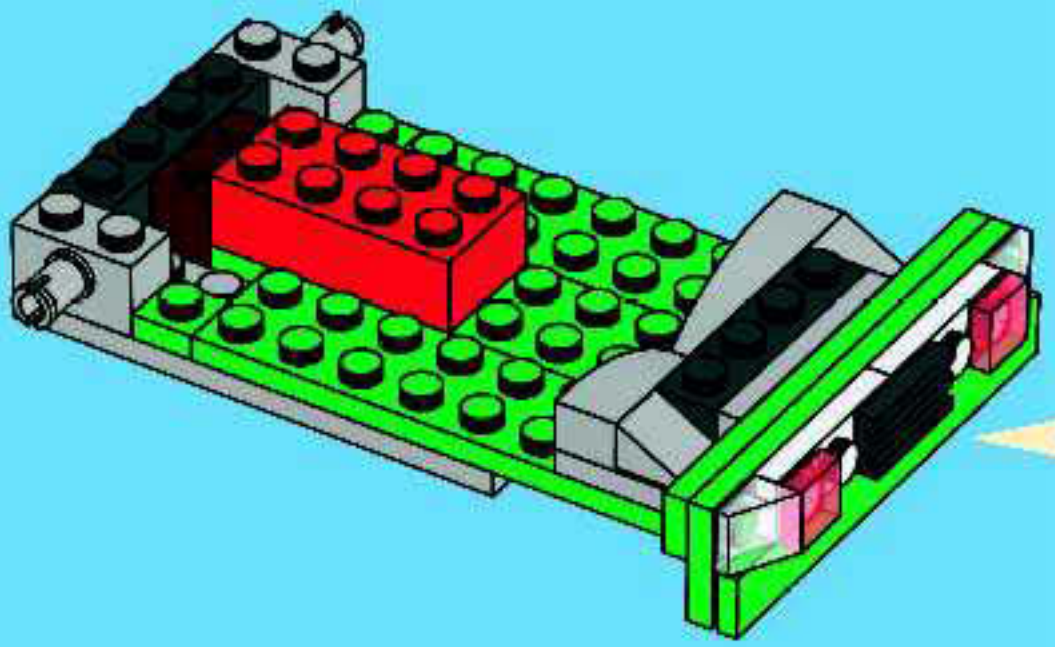





2x



2x



2x

11

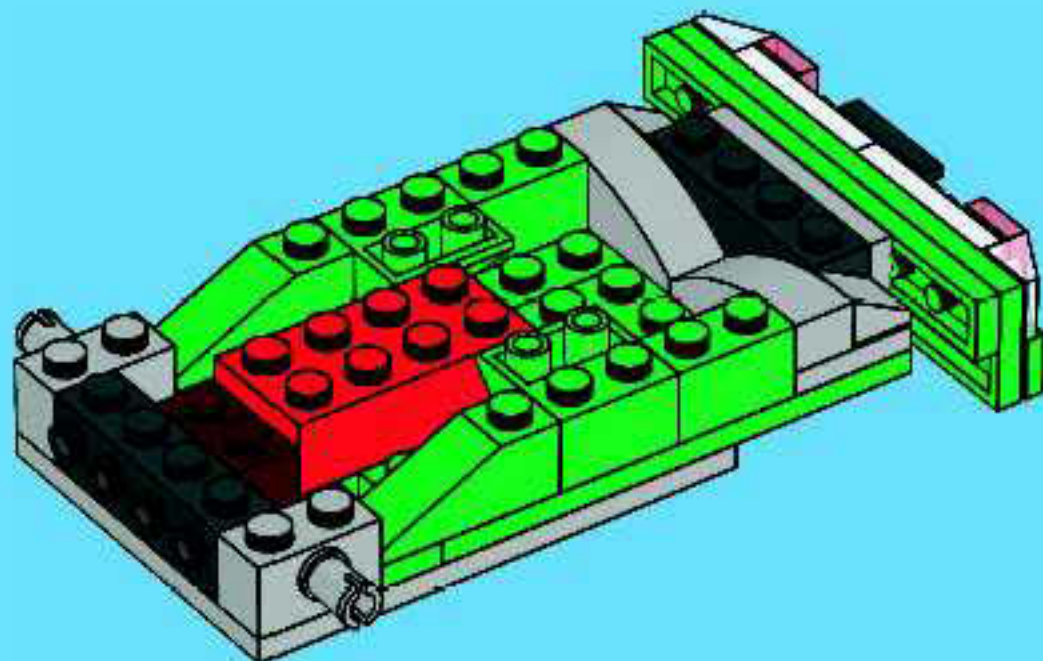



1x



1x

12

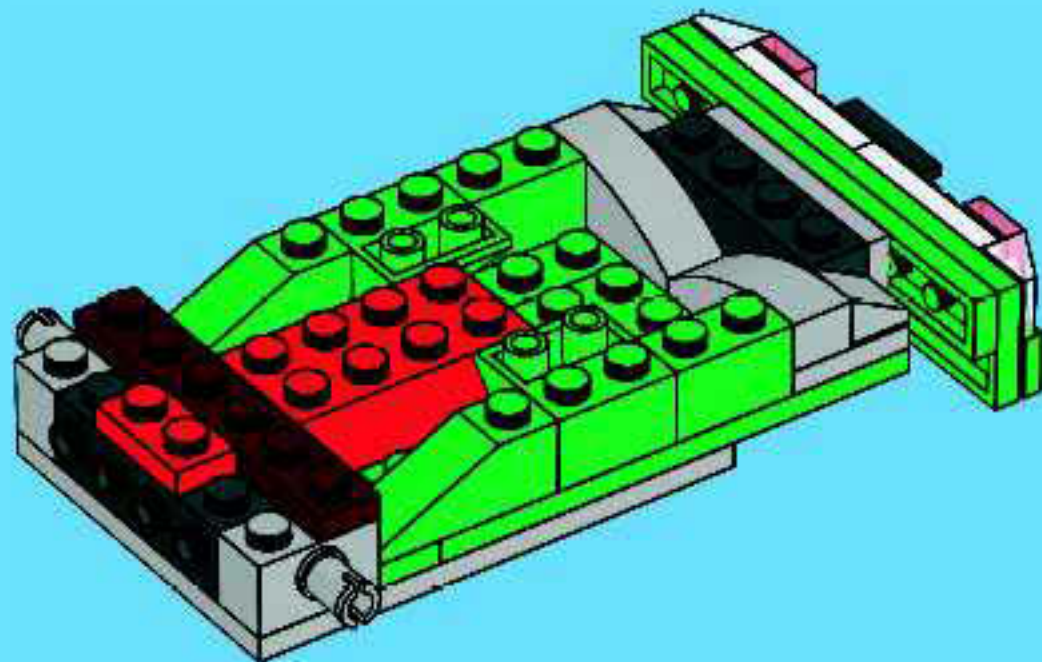

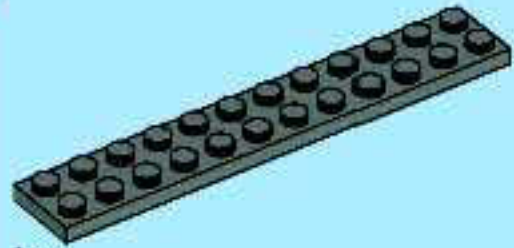

1x



2x

13

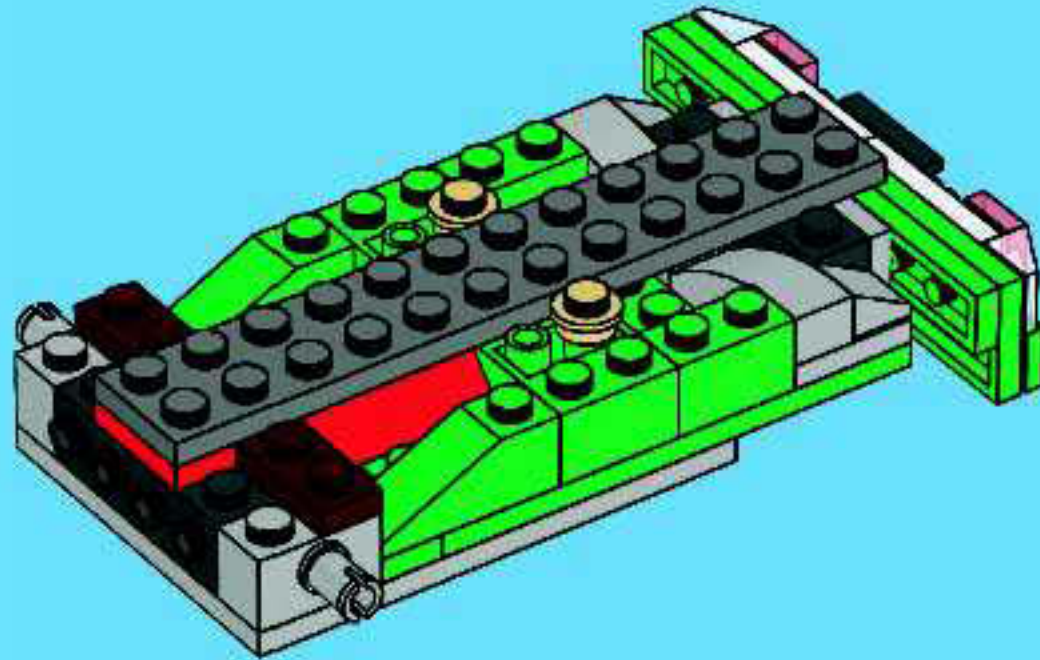



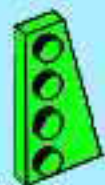

1x



1x



2x



2x

# 14

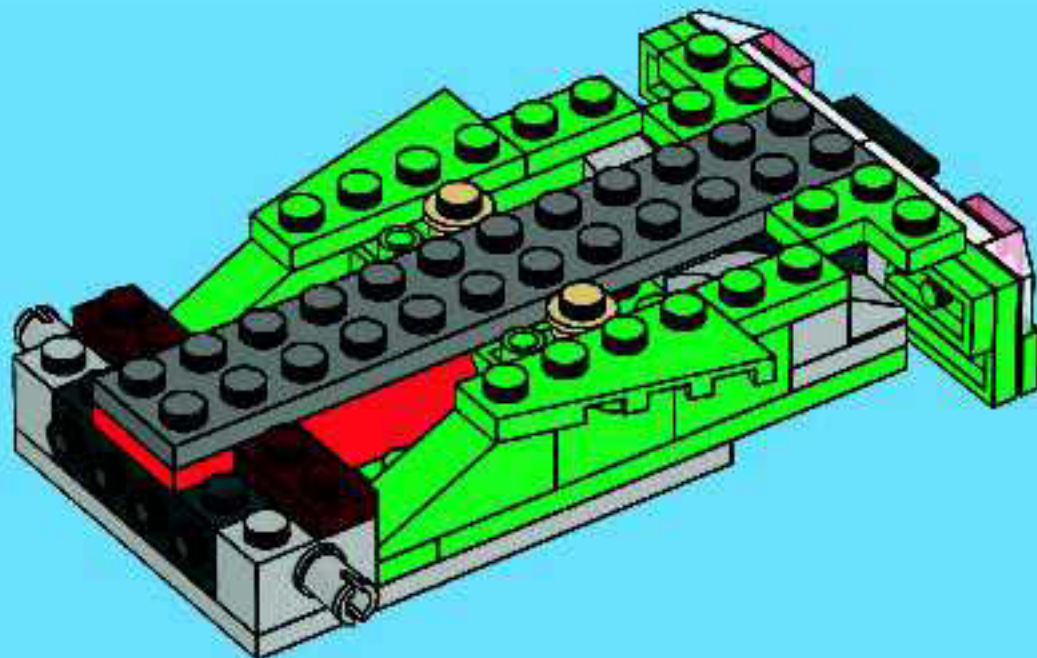

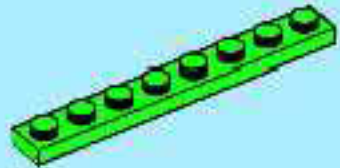

1x



2x

15

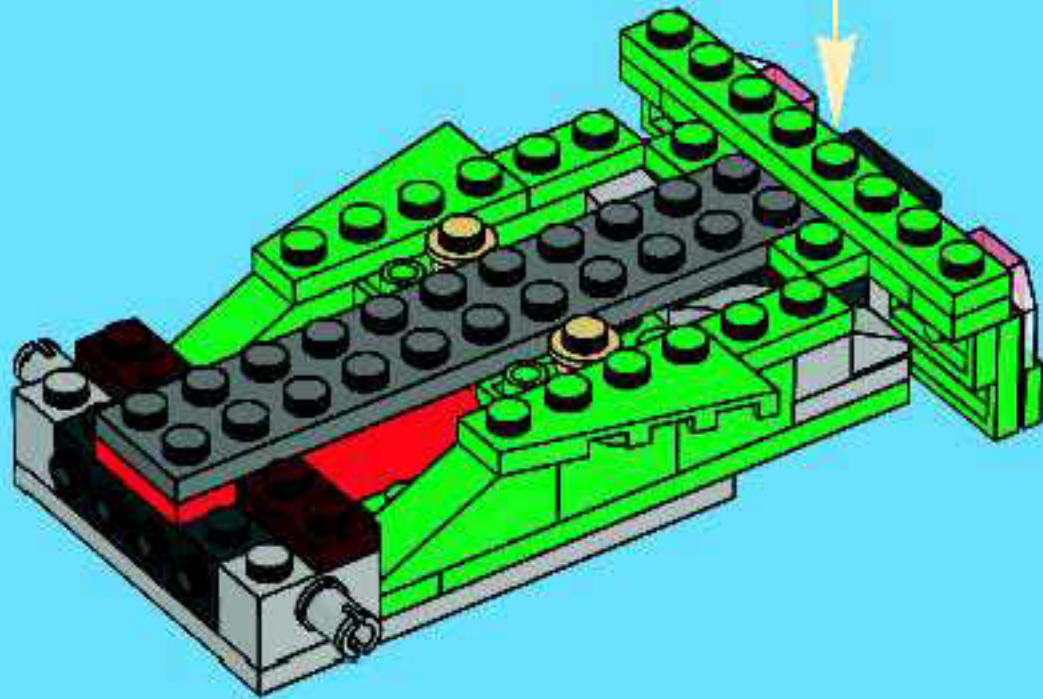
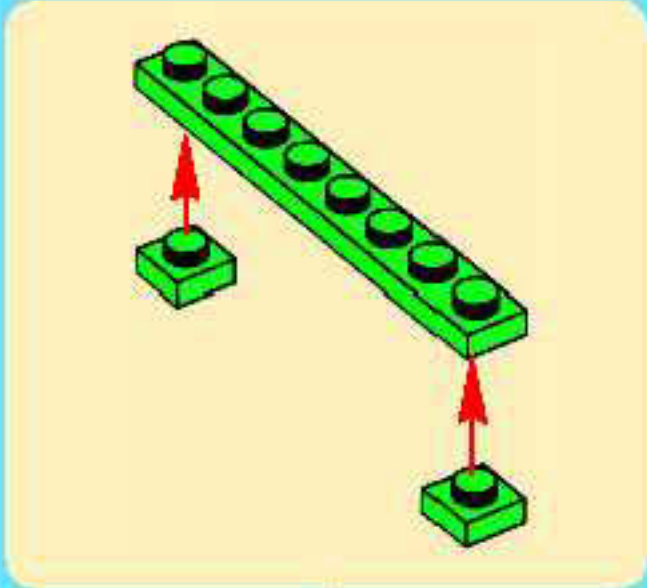

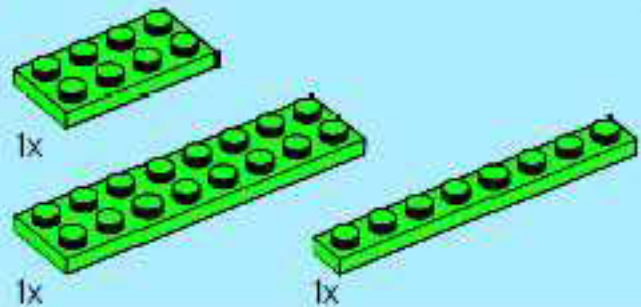

16

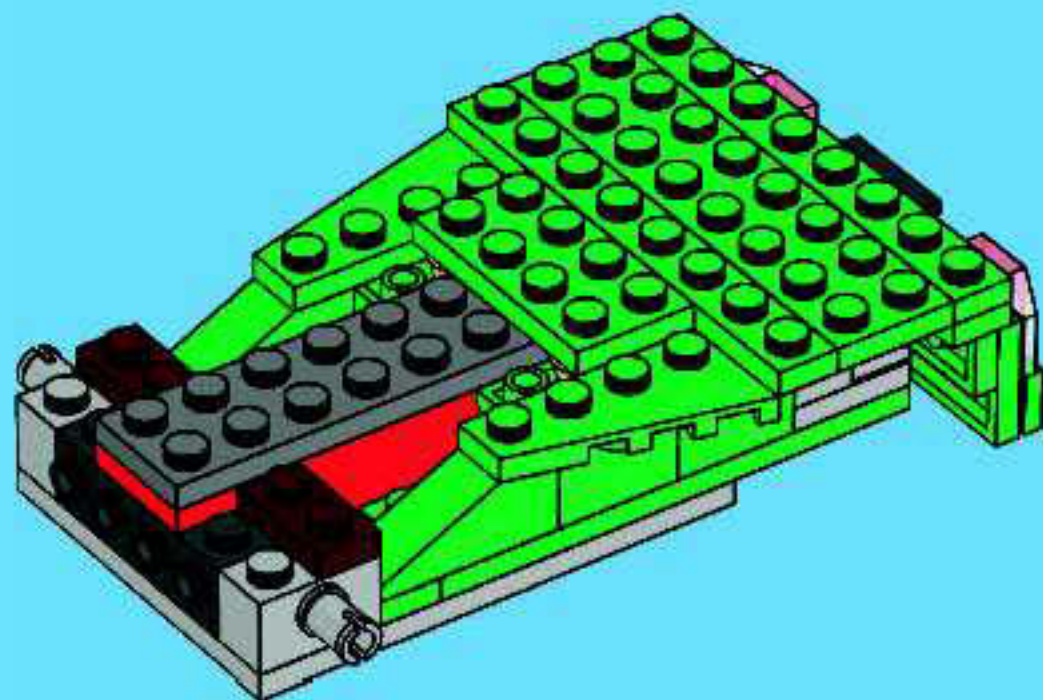



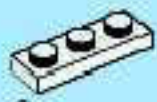

2x



2x



2x



2x

17

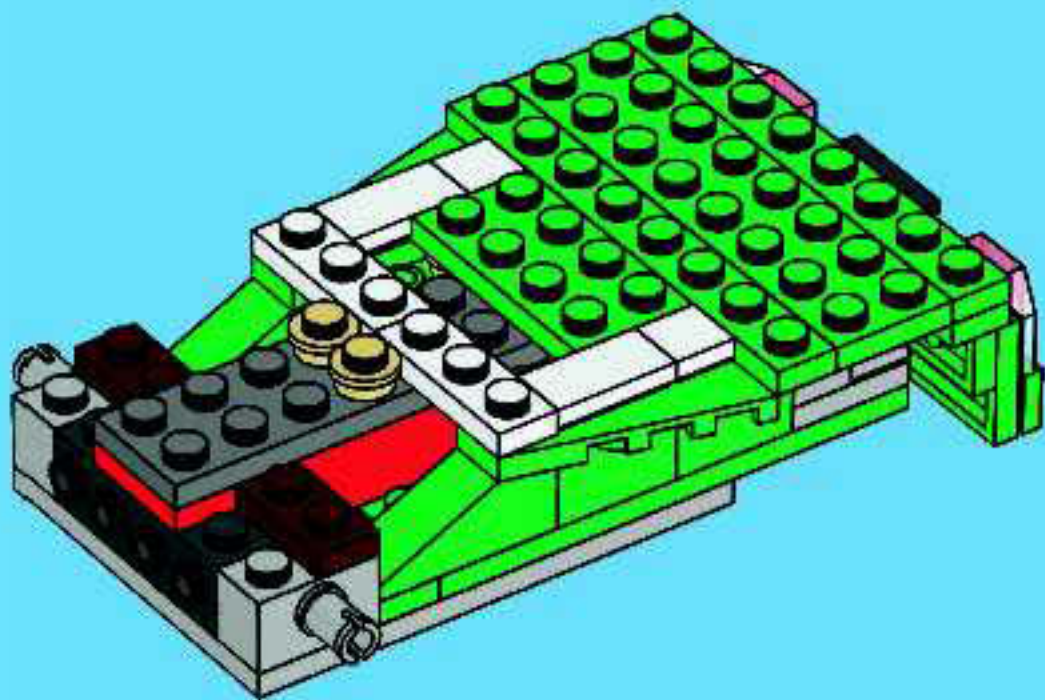



2x



1x



2x

# 18

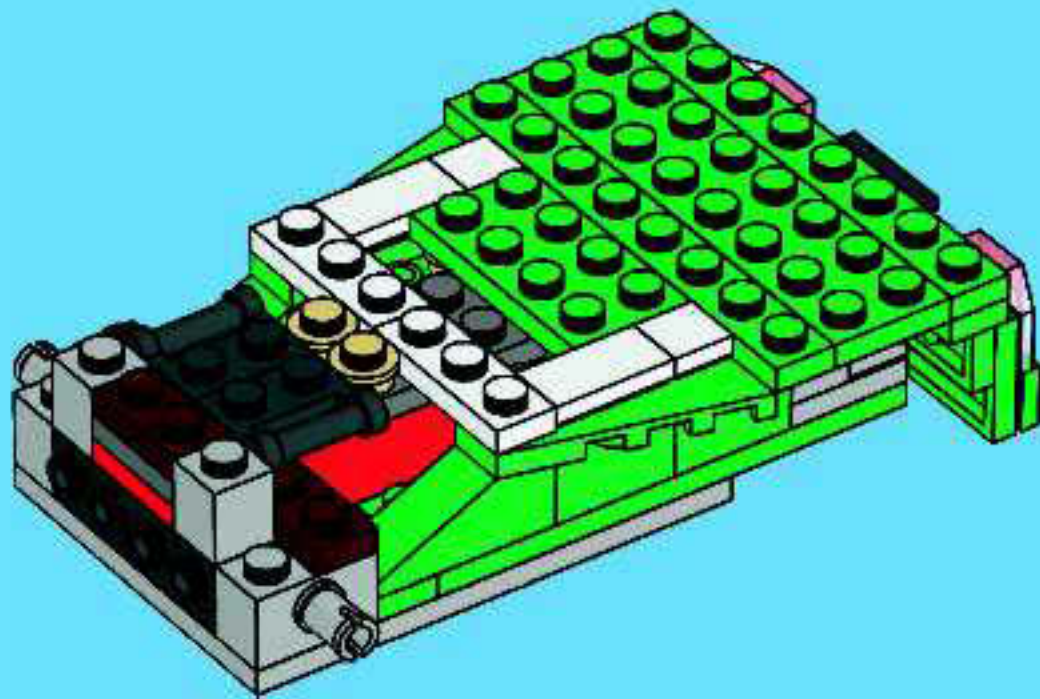



19

1

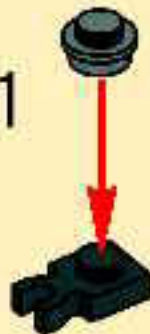

2

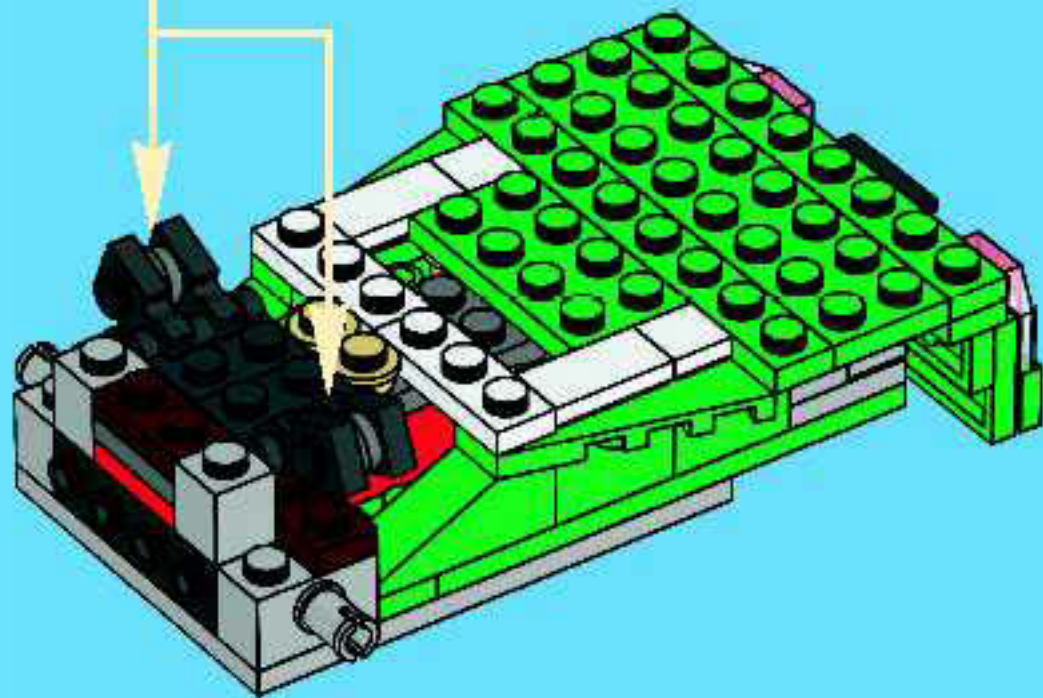





2x



2x



2x



1x

20

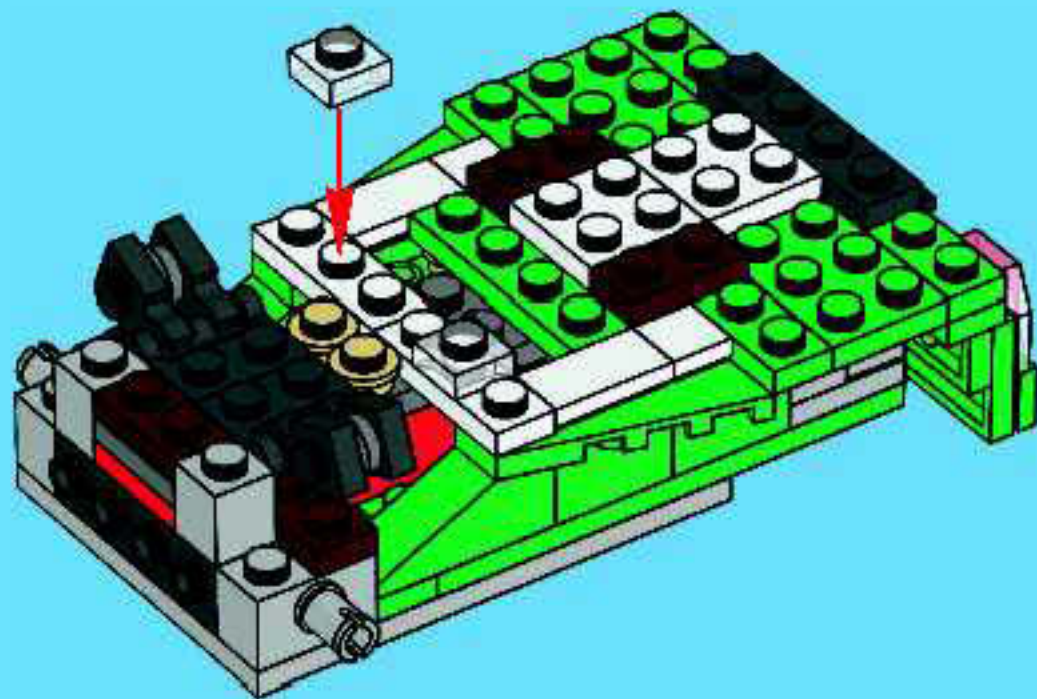



21

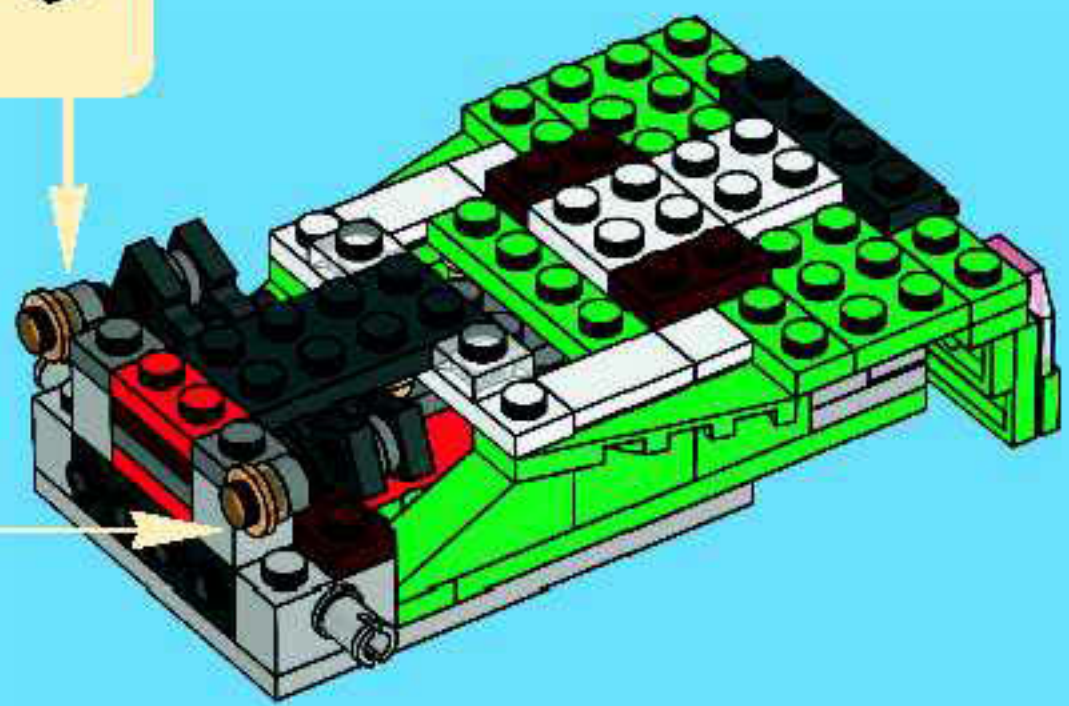
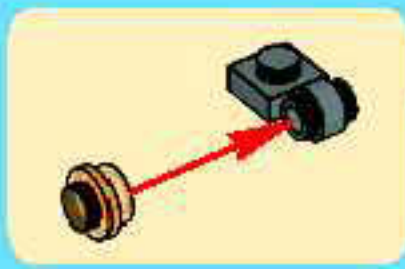
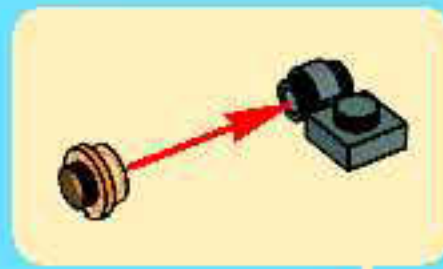

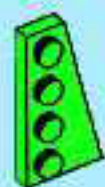

1x



1x



1x

22

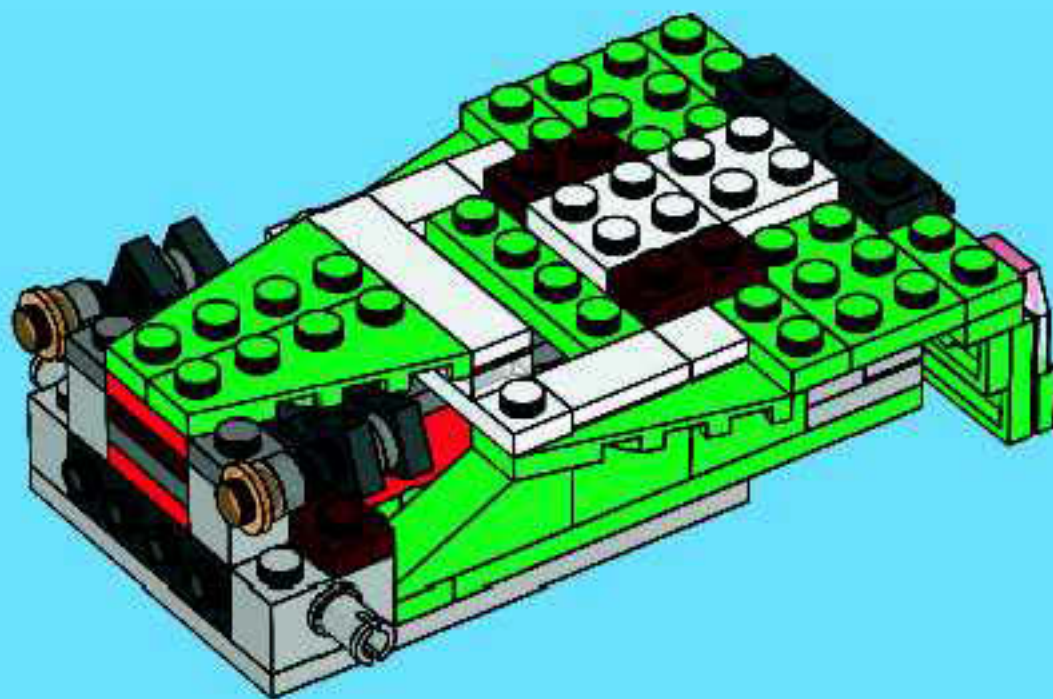





2x



2x

23

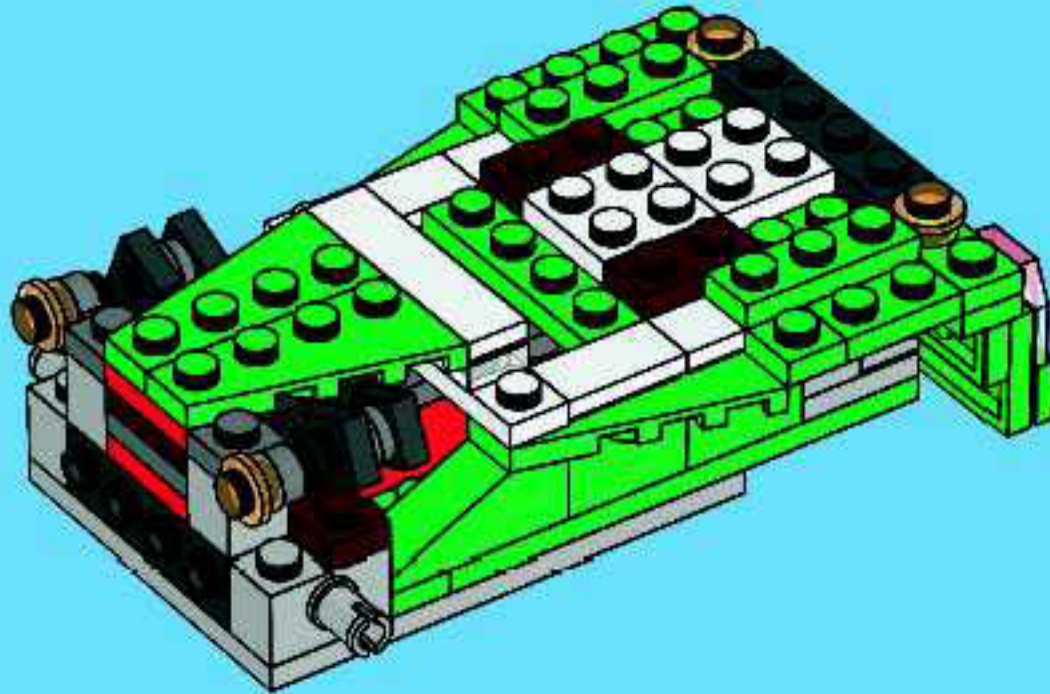



1x



2x



1x



2x

# 24

1

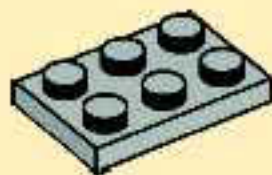

2



3

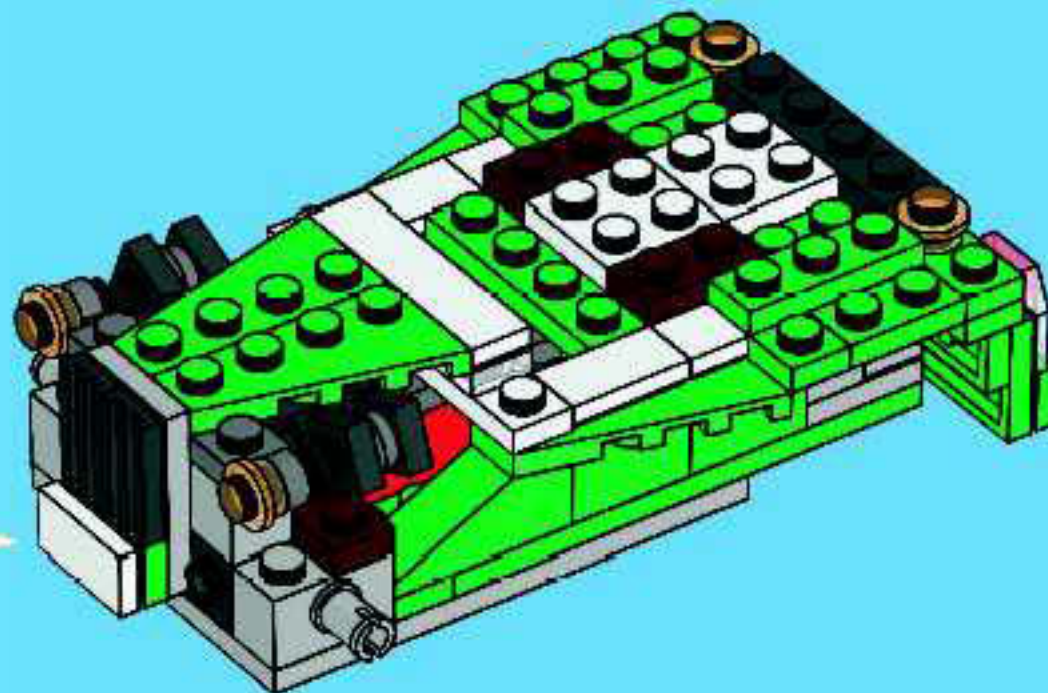



2x



2x



2x

# 25

1



2



1



2

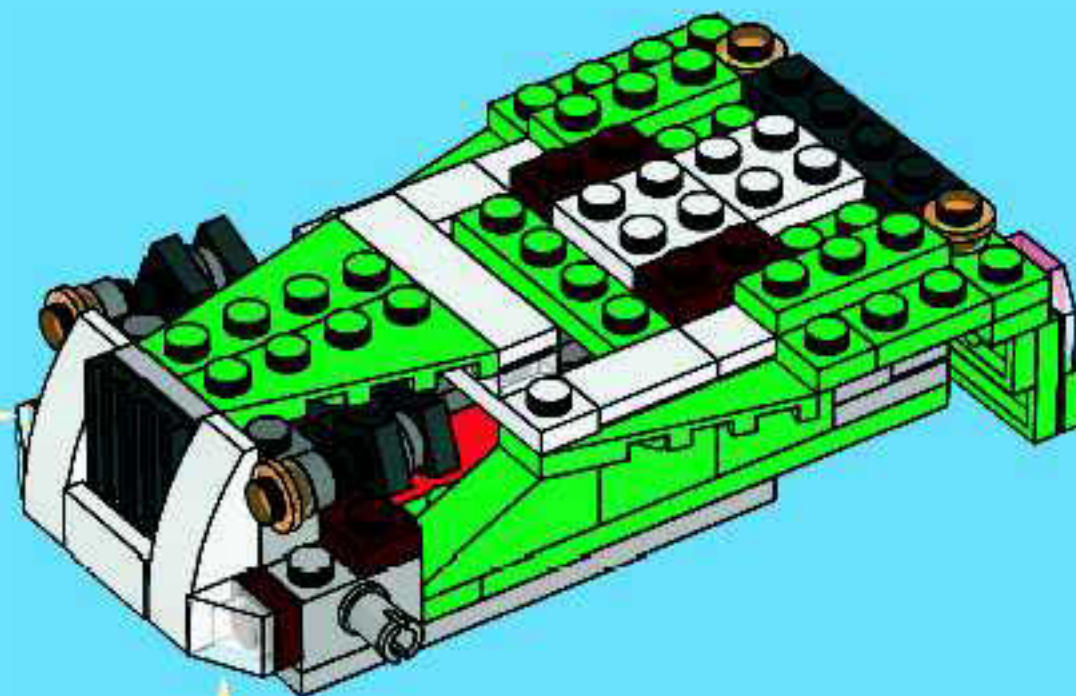





1x



2x



2x

# 26

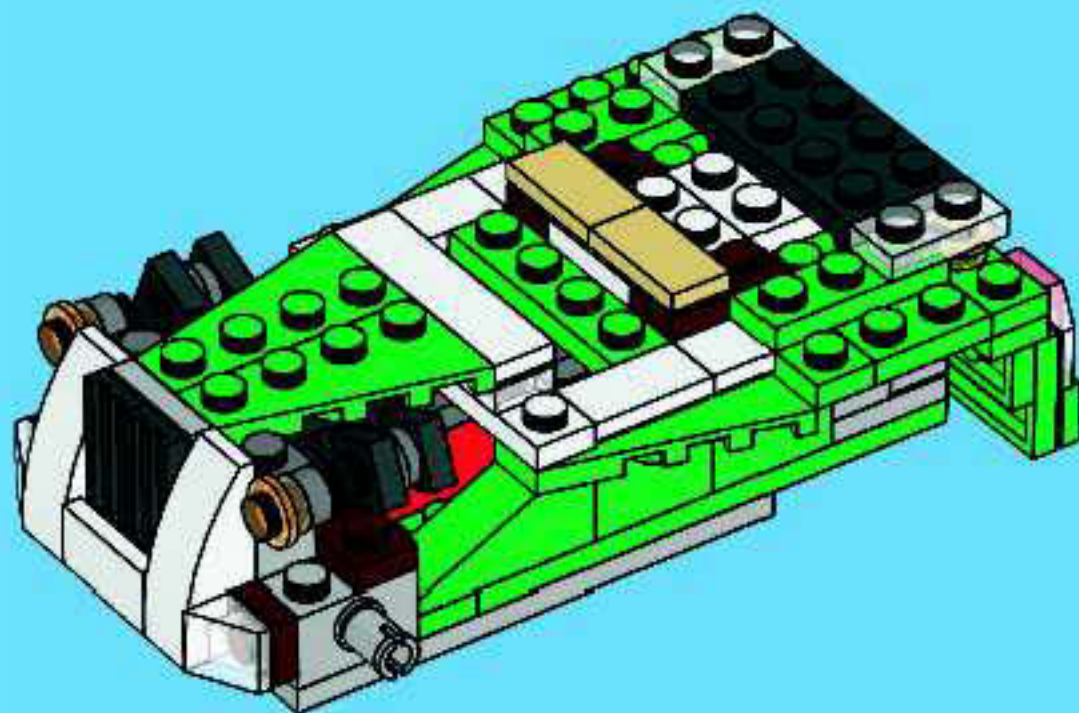

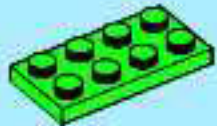

1x



2x

27

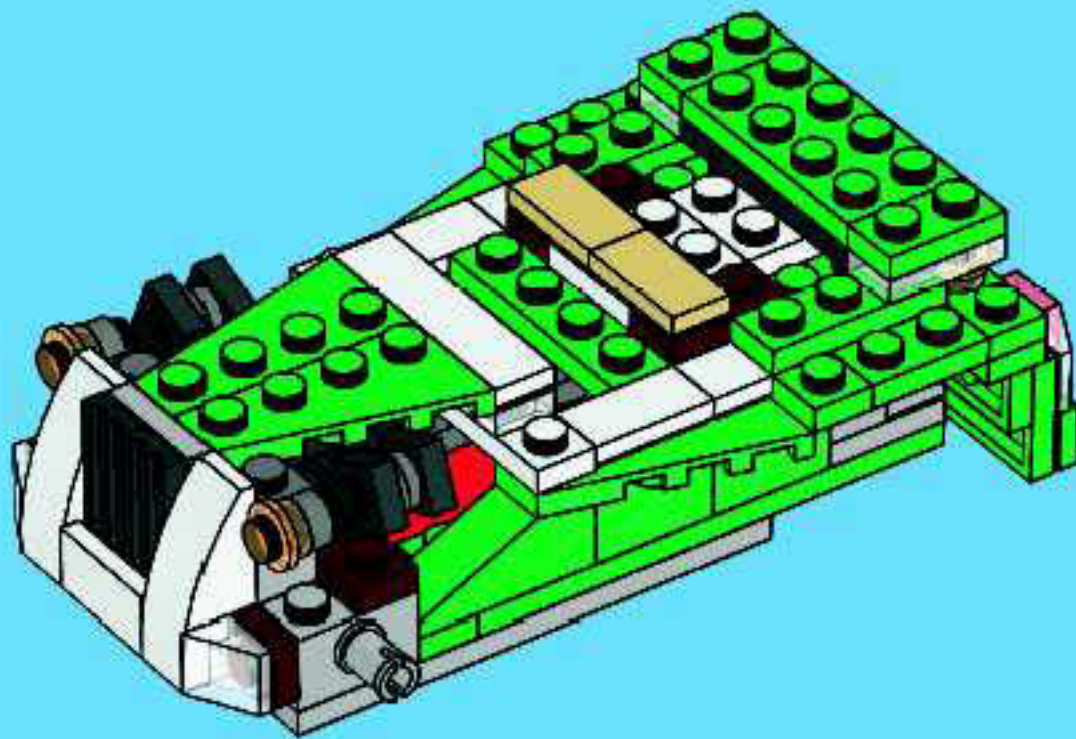



2x



2x



1x



1x



1x

# 28

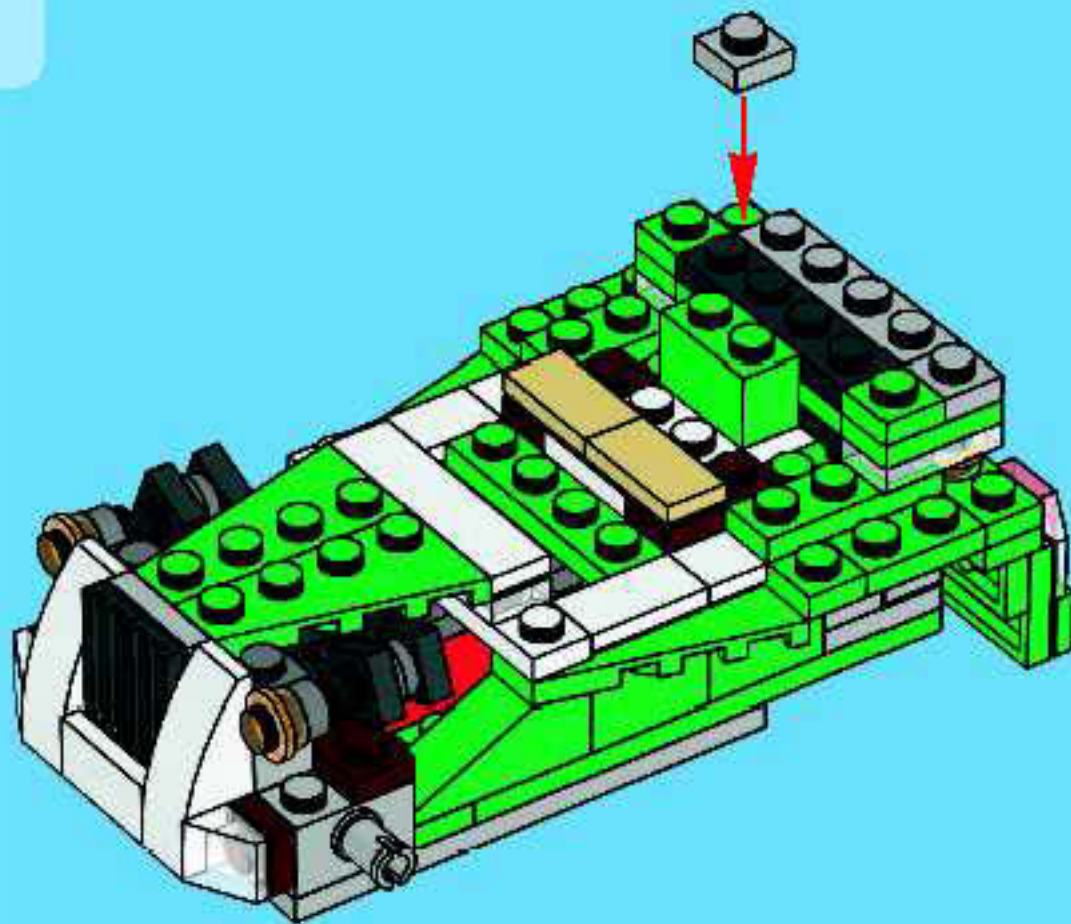





2x



2x

29

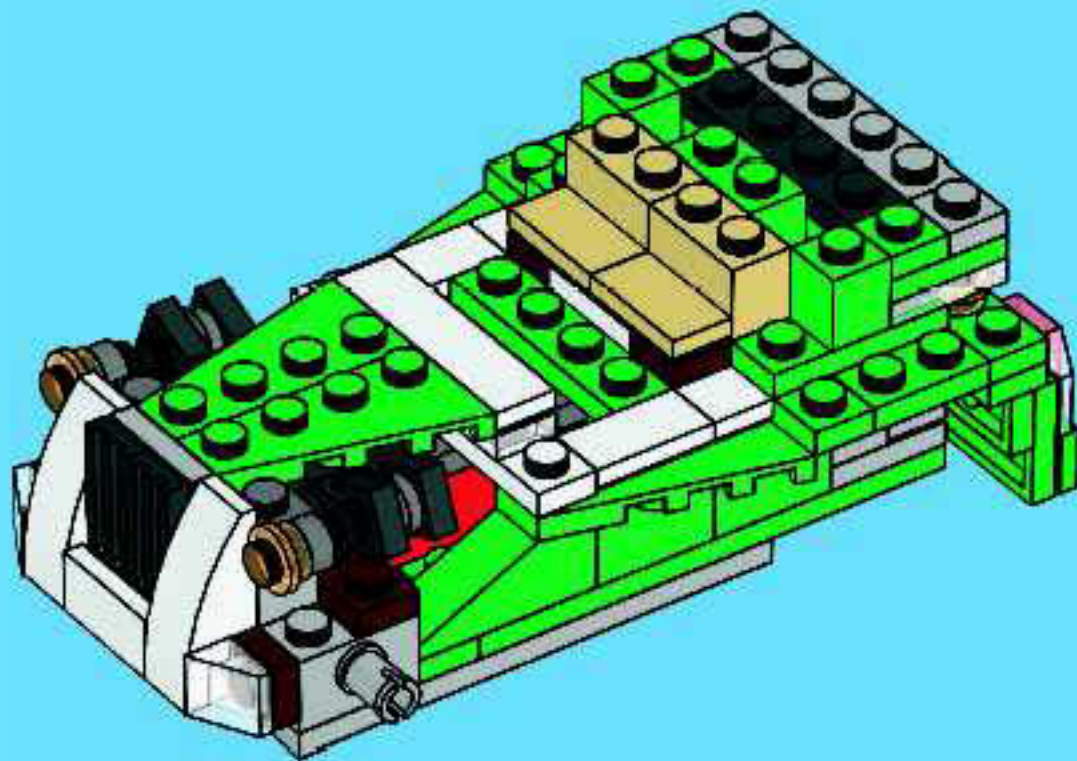



1x

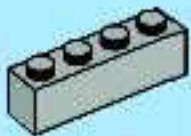

1x



2x

# 30

1

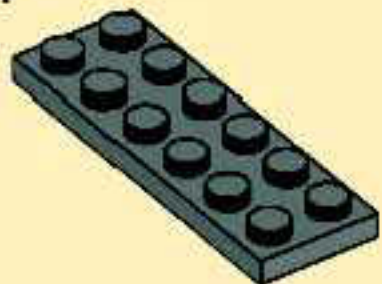

2

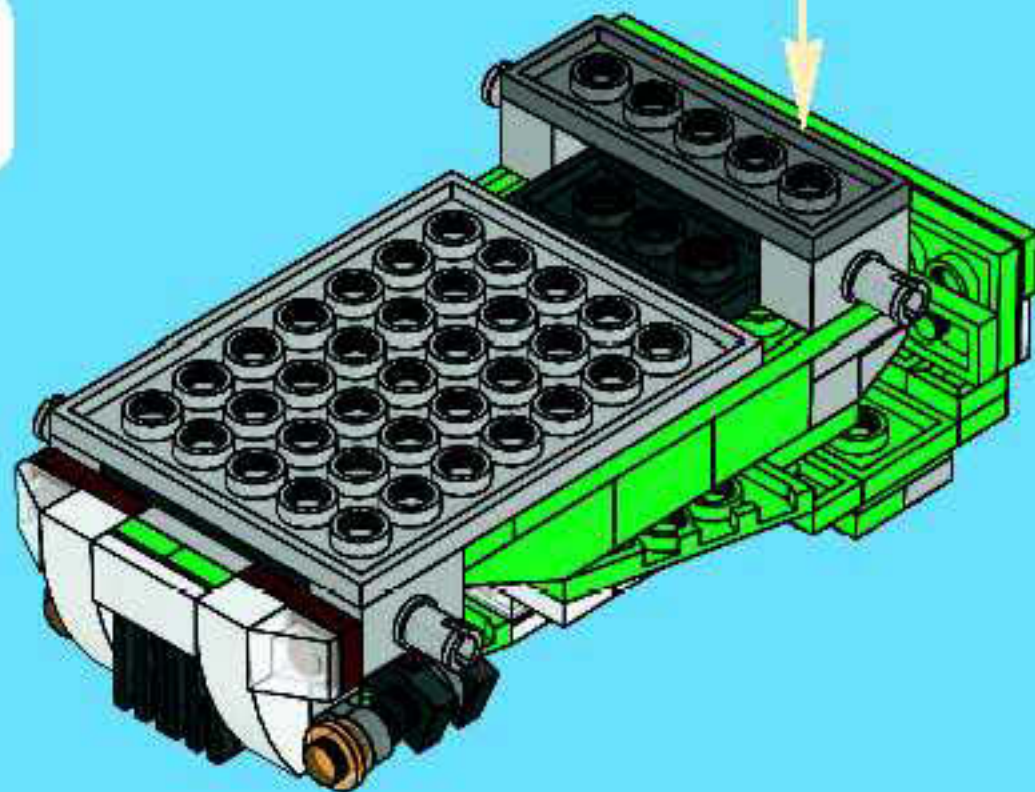
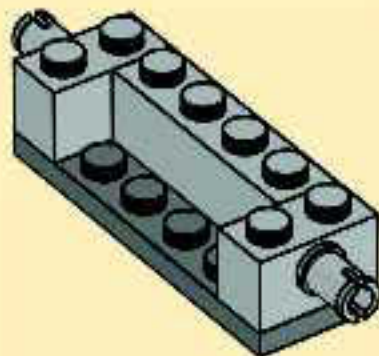

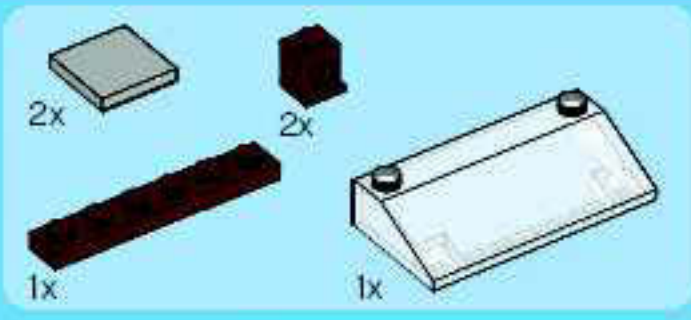

31

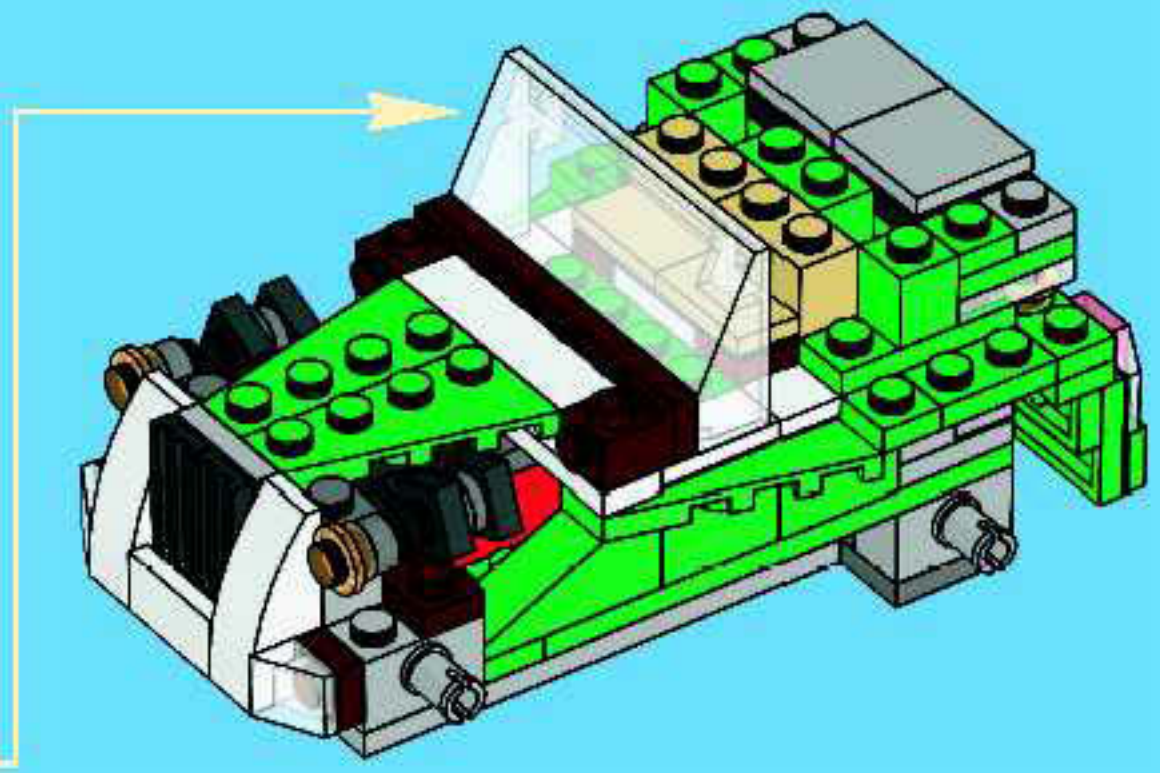
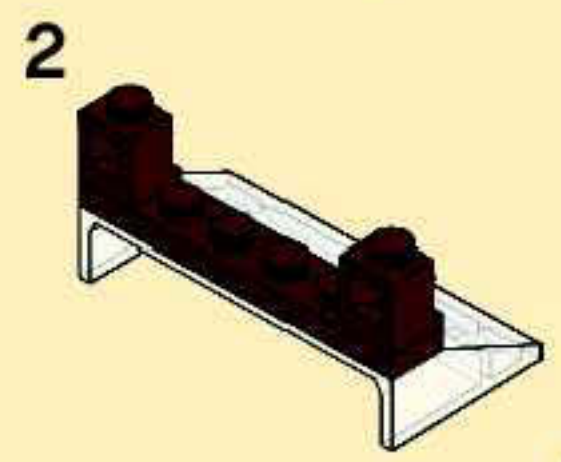
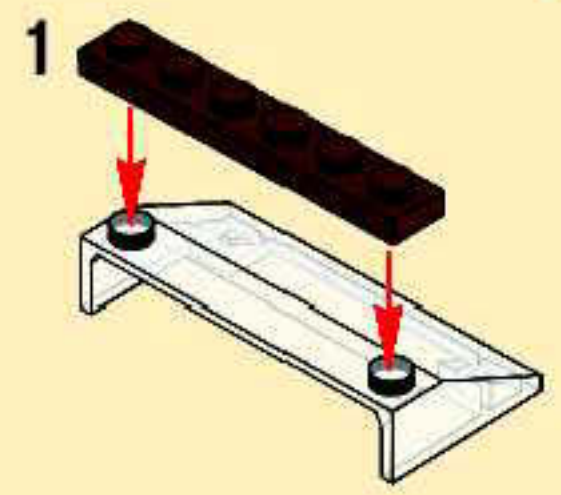





1x



2x



2x

# 32

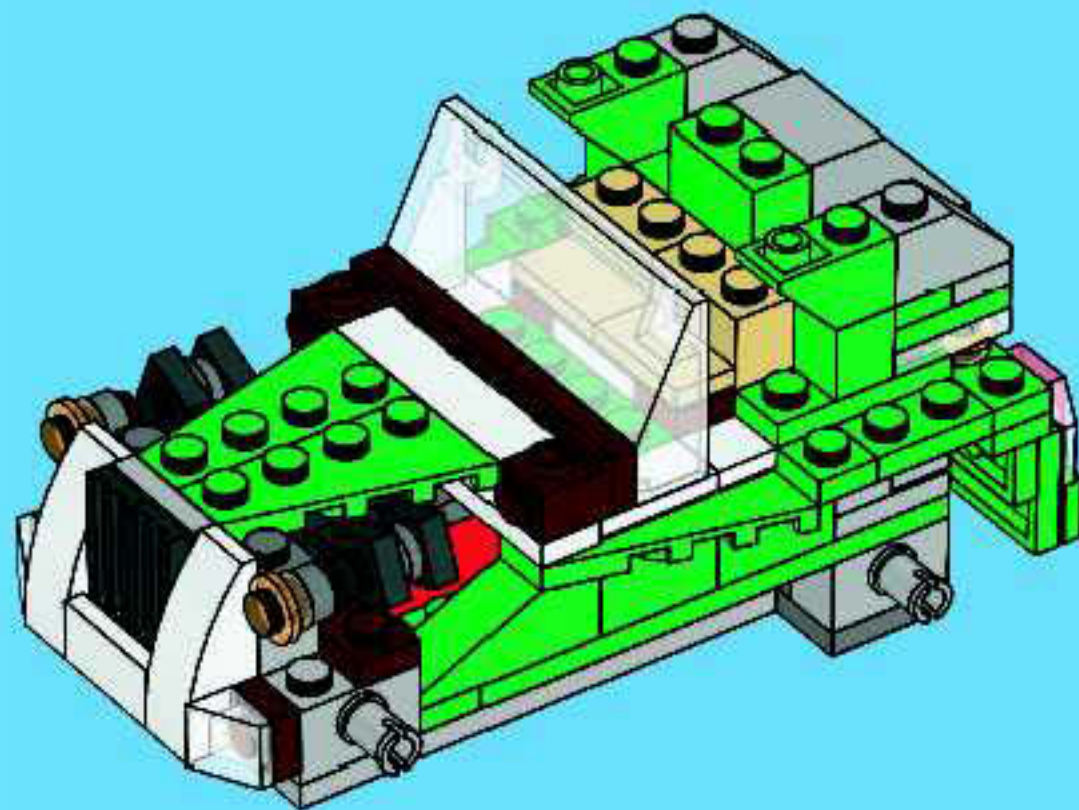

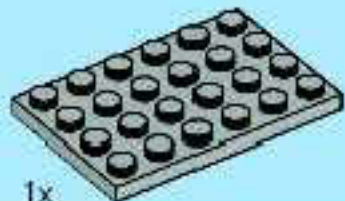

1x

33

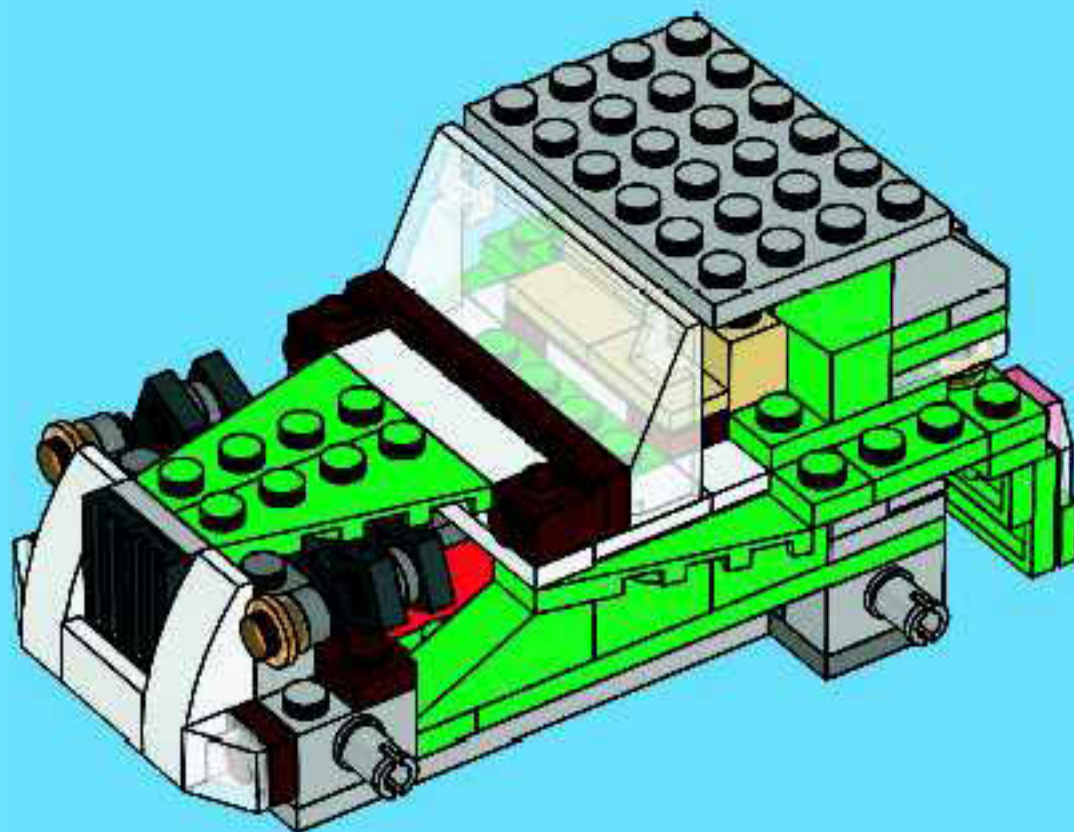



4x



4x

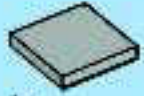

1x

# 34

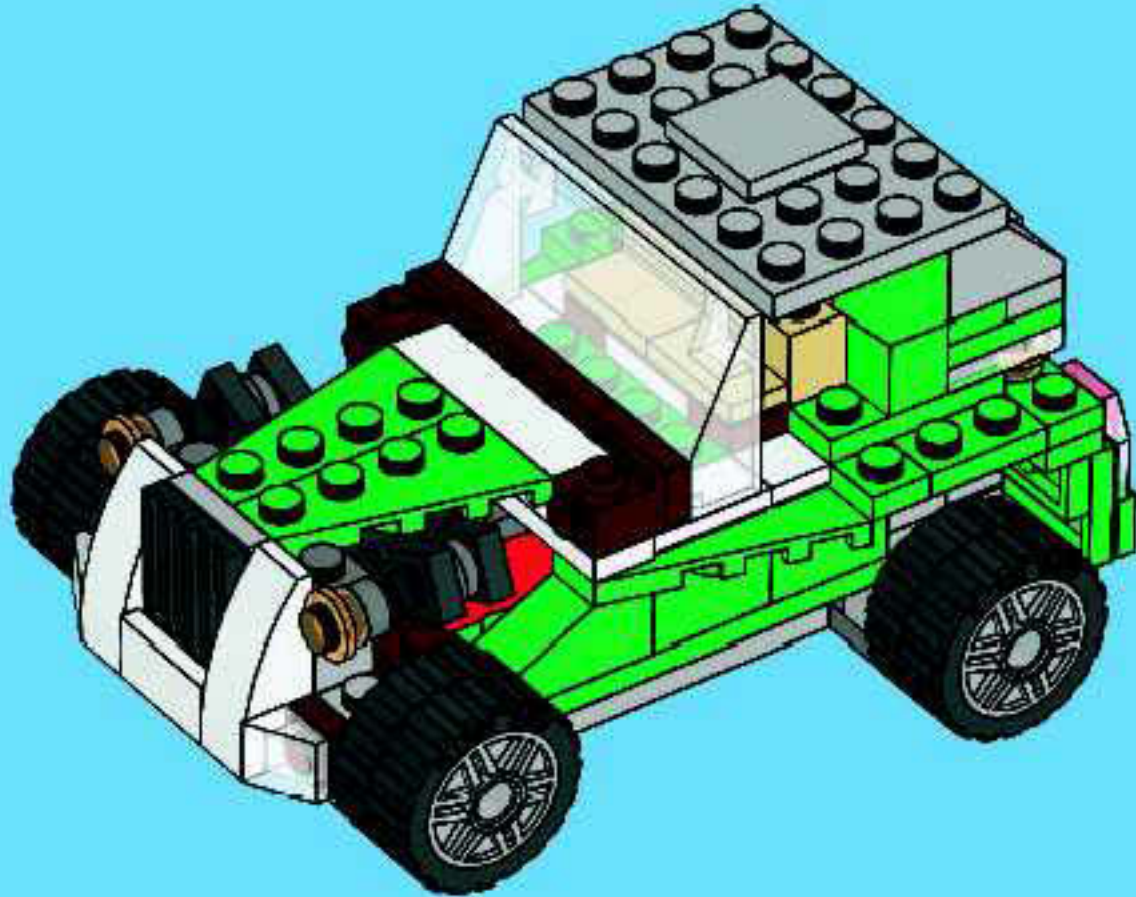



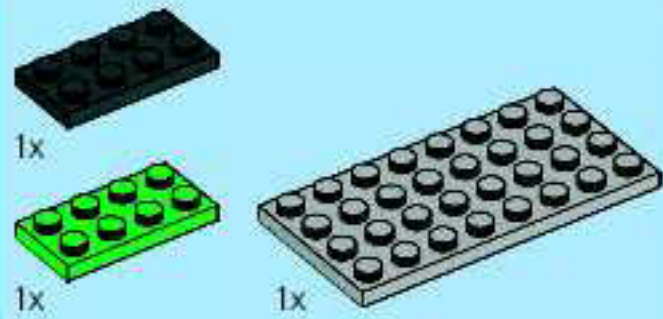
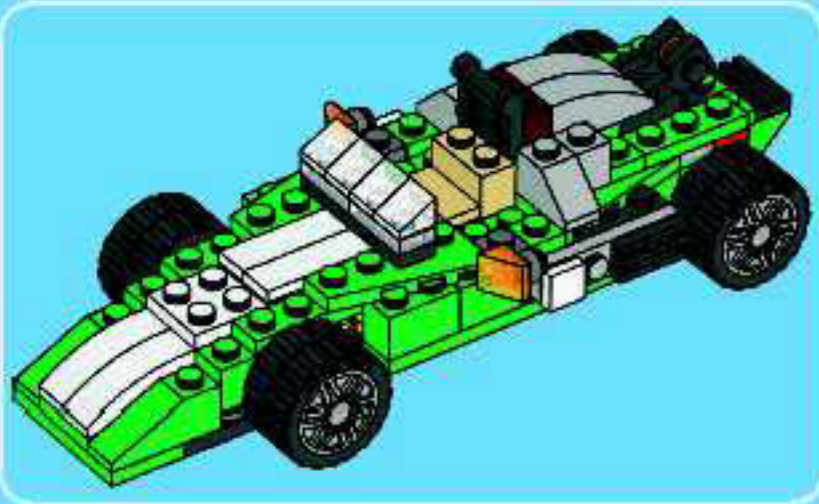

1

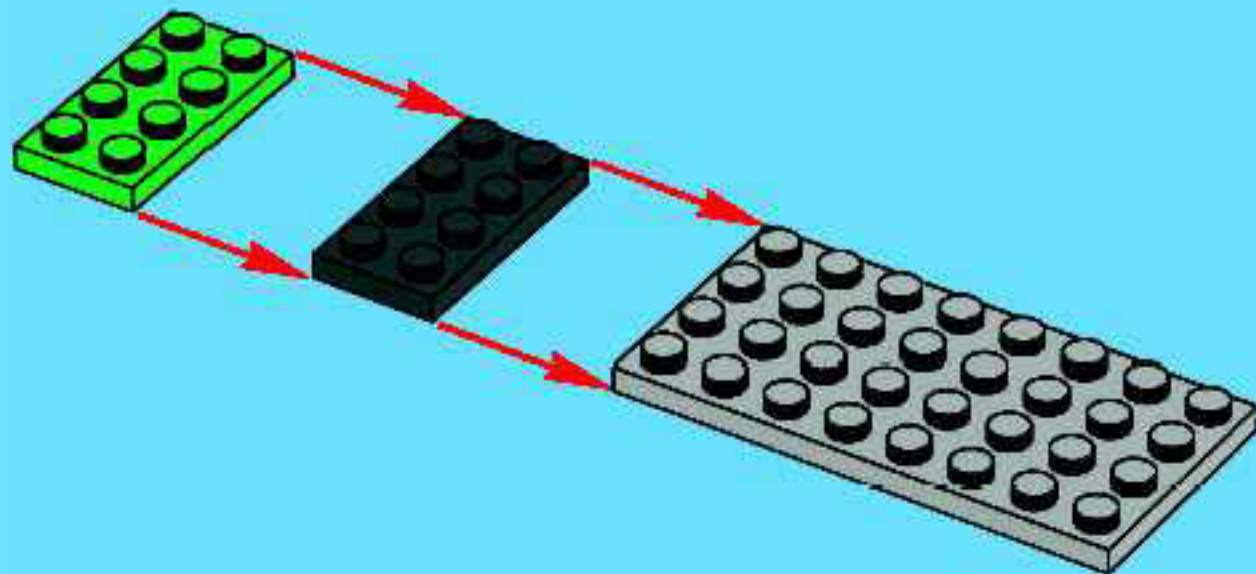

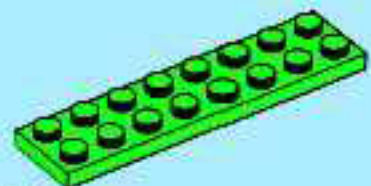

1x

2

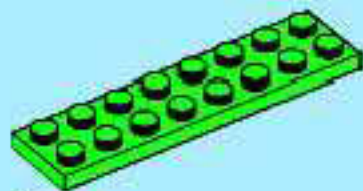
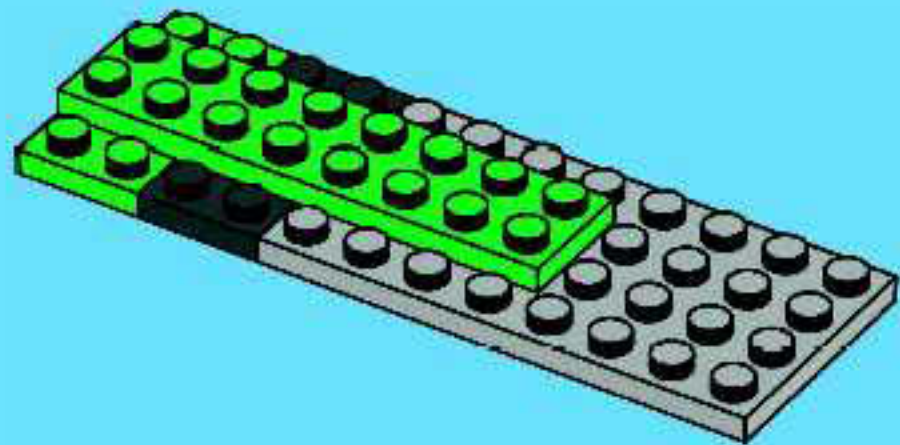

1x

3

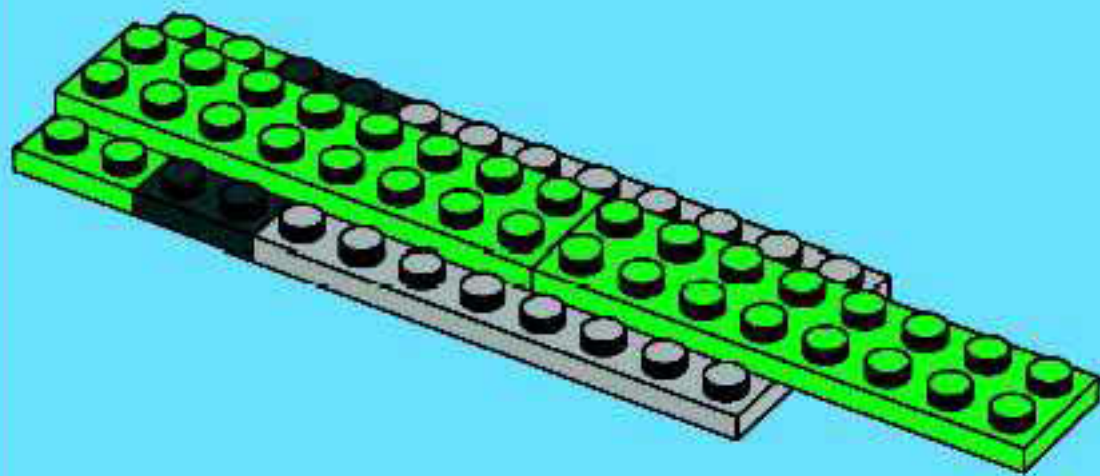

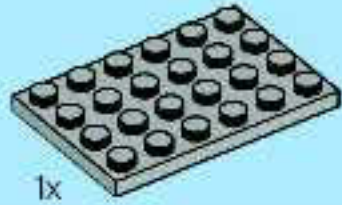

4

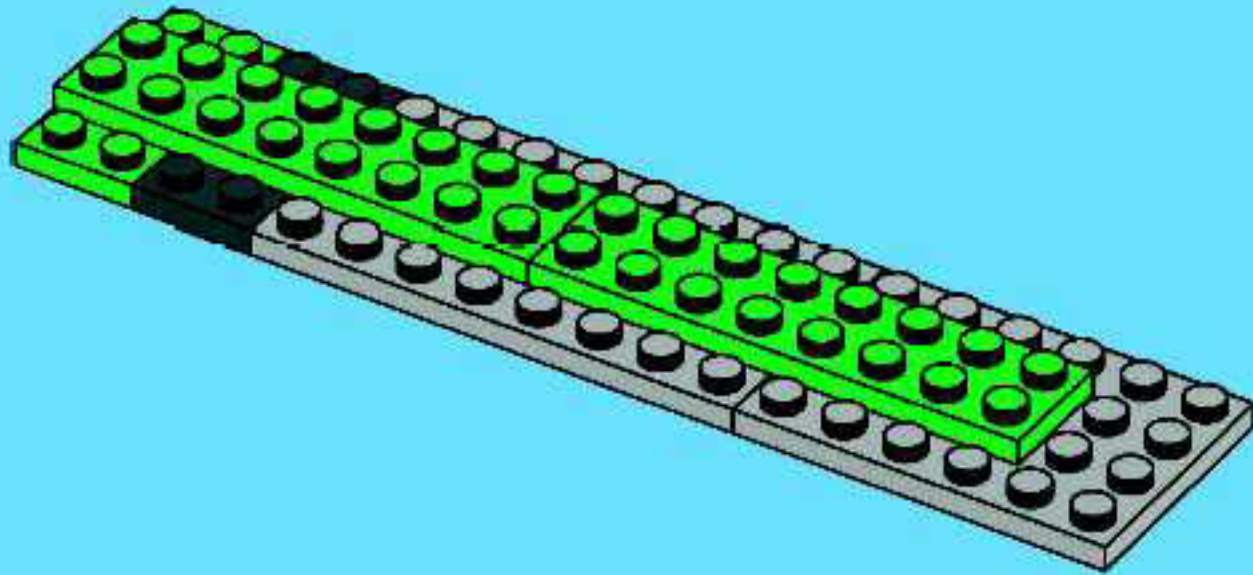





1x

5

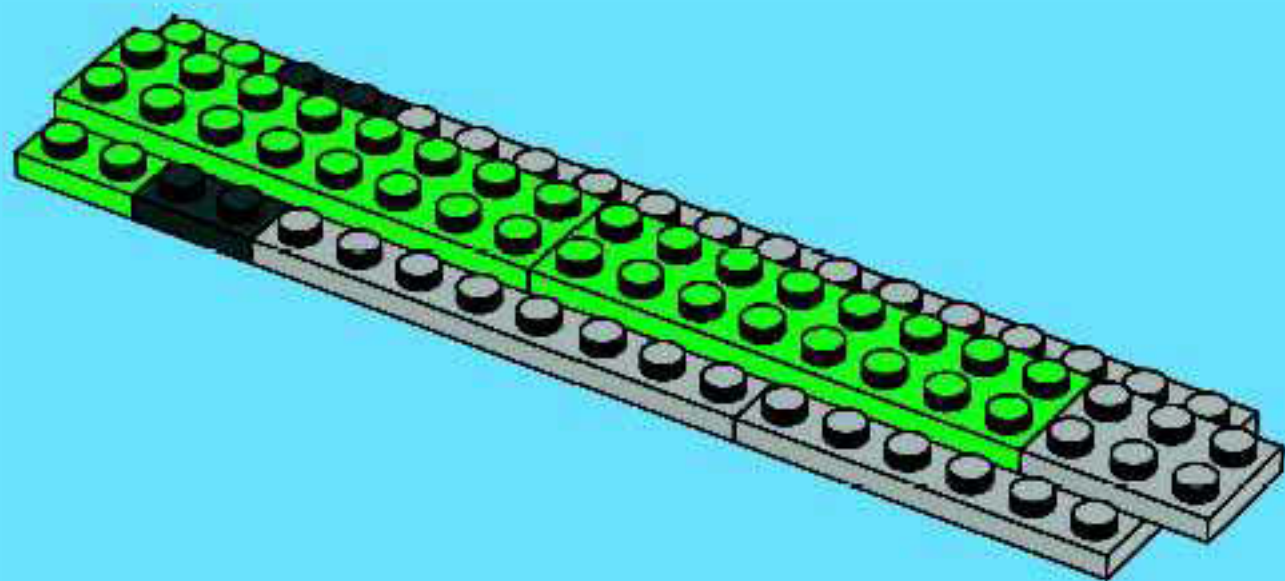



2x



2x

6

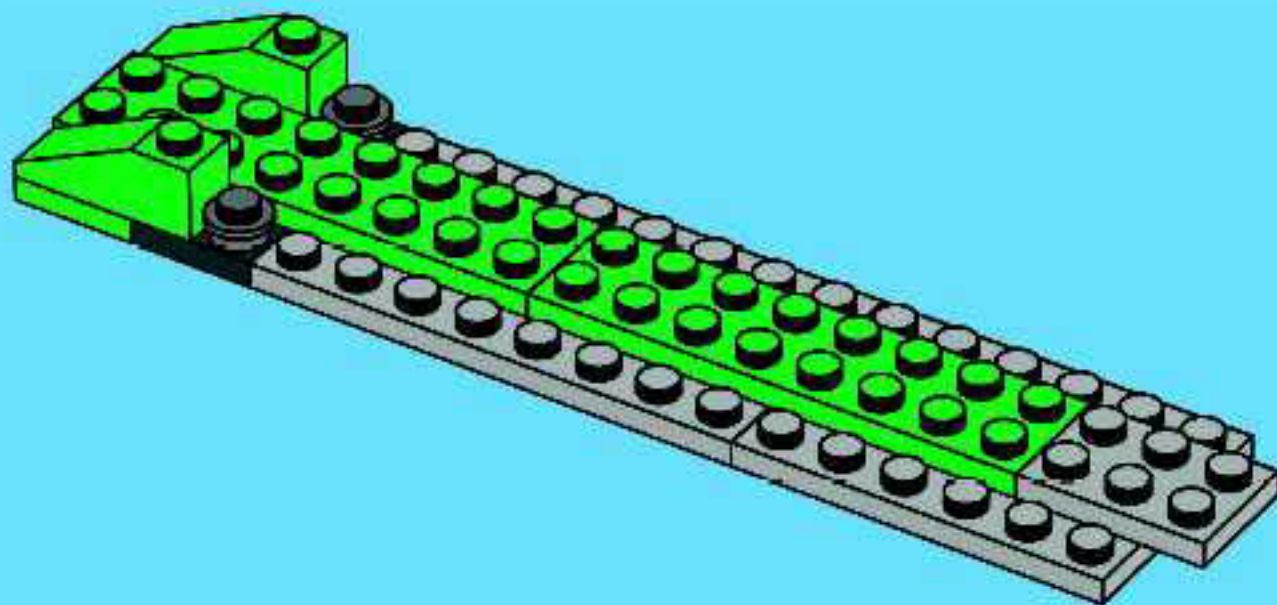



1x



2x

7

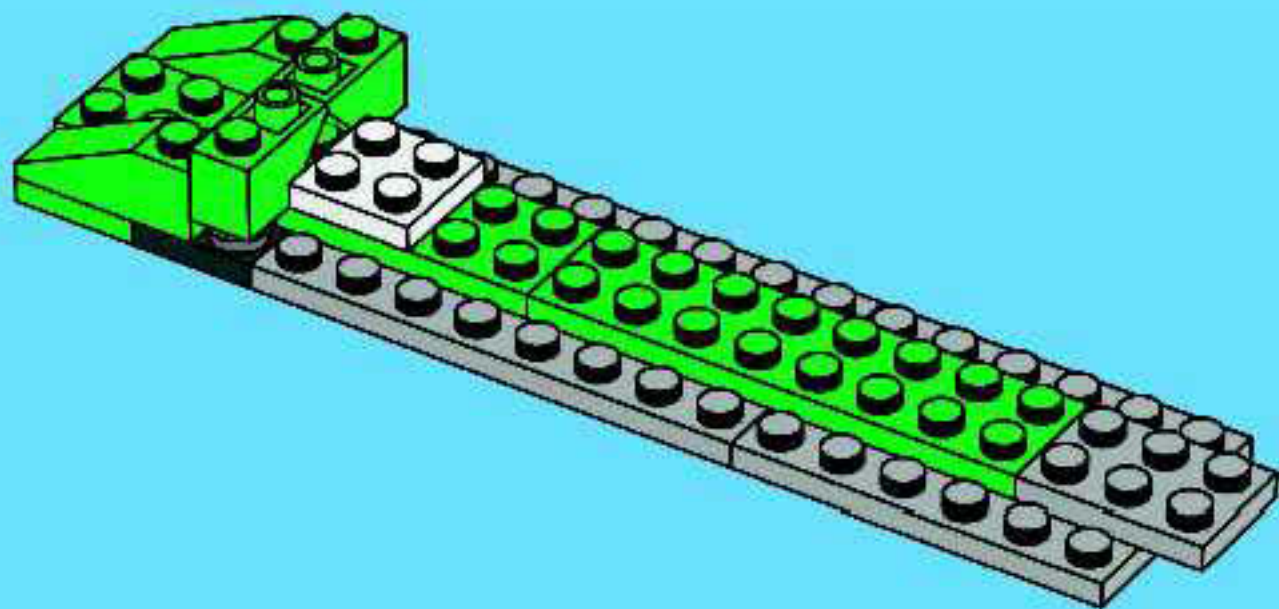



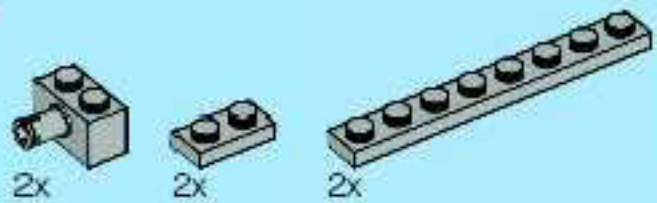

8

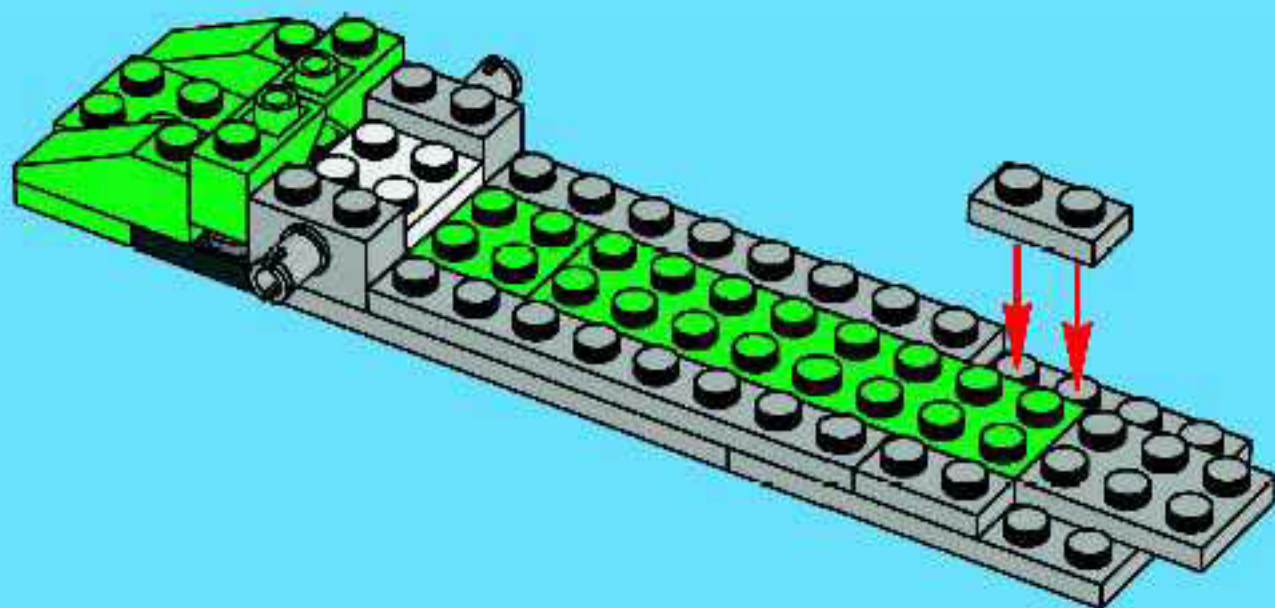



2x



2x

9

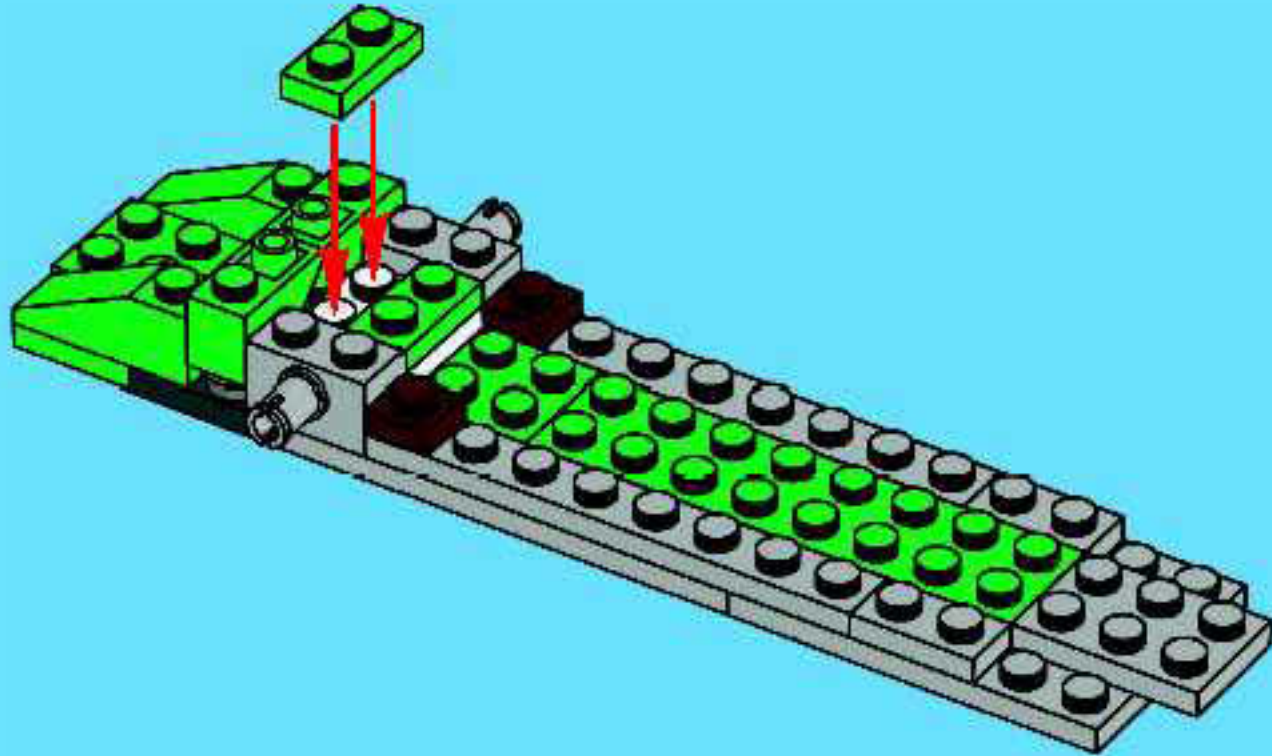



4x



1x

10



2x

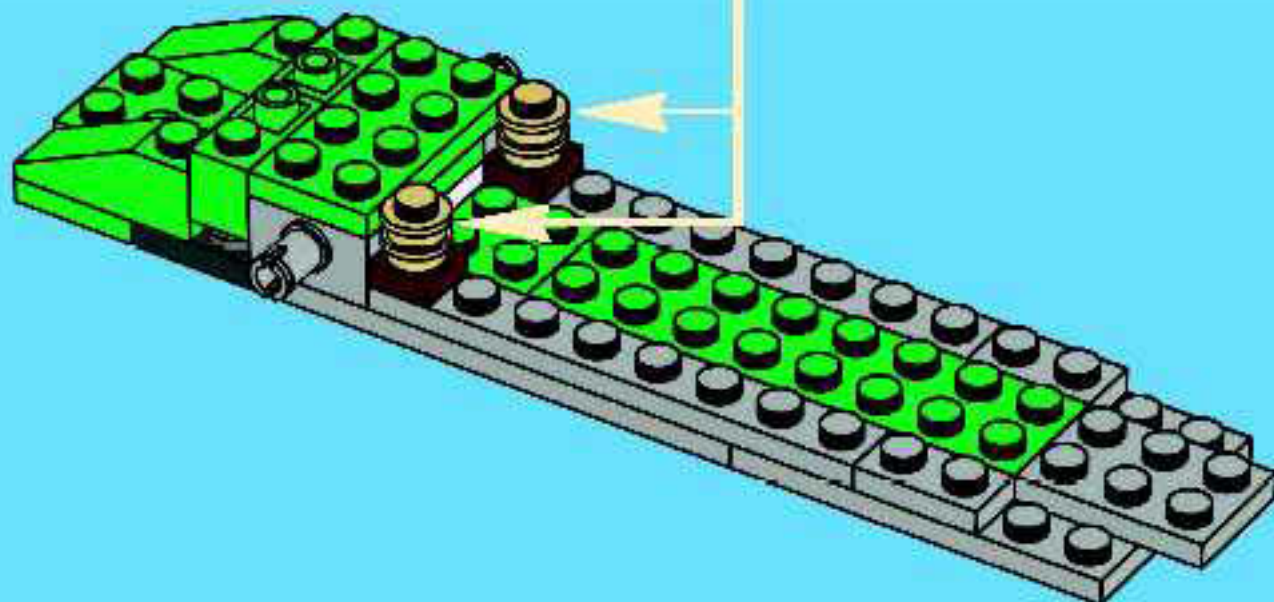





1x

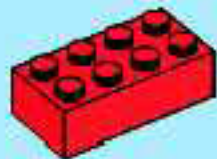

1x

11

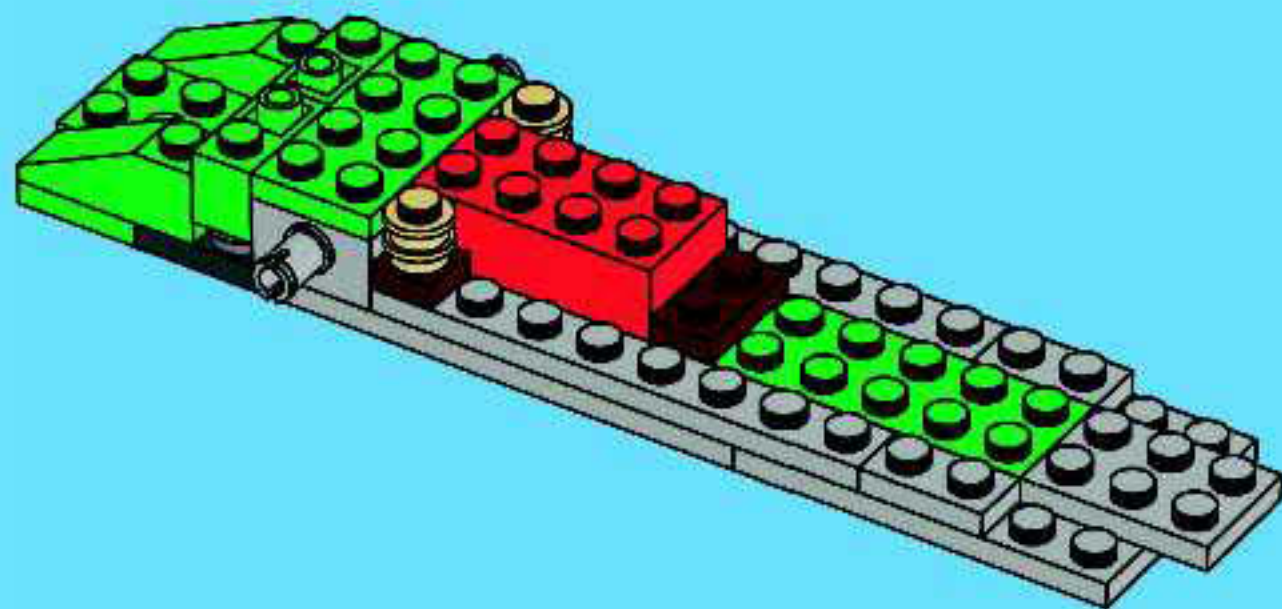



2x

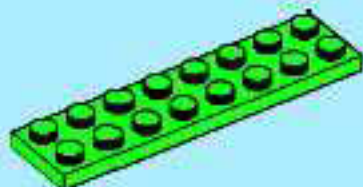

2x

12

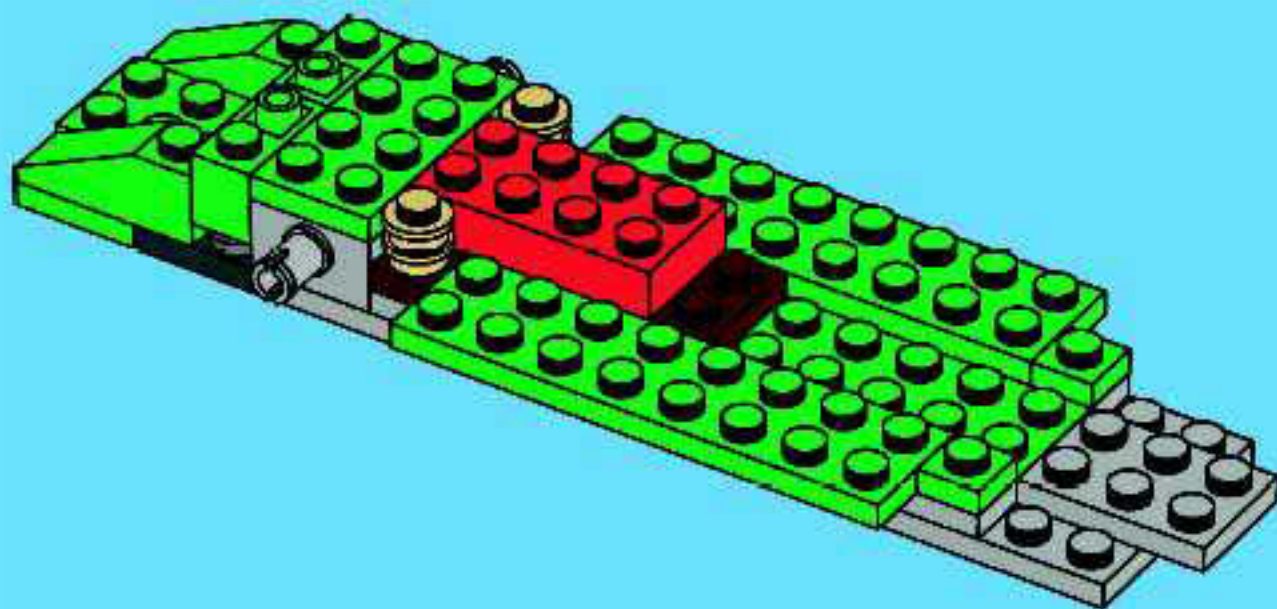





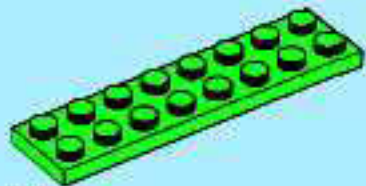

1x



2x

14

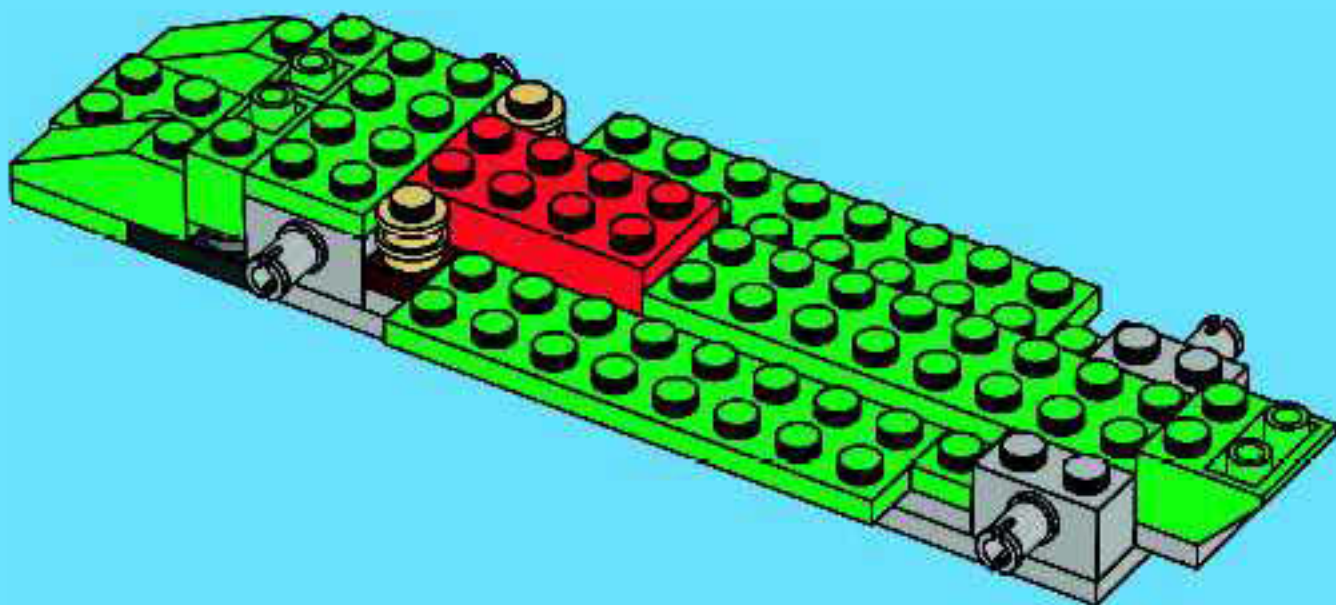



2x



1x



1x

# 15

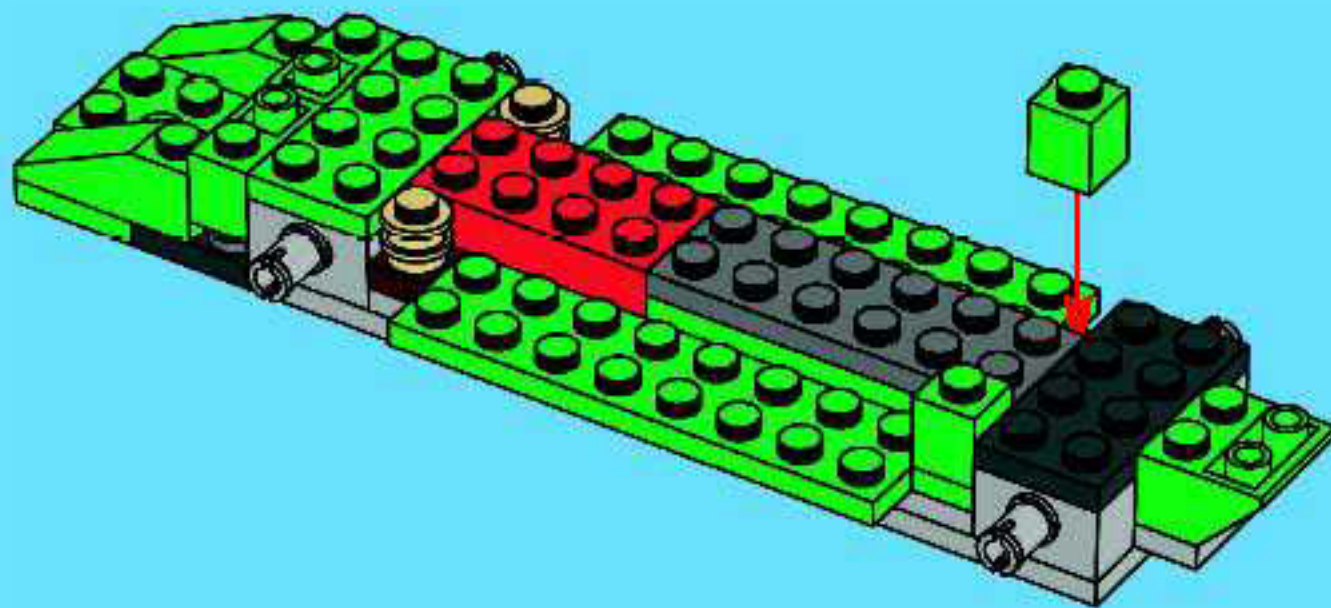



2x



2x

# 16

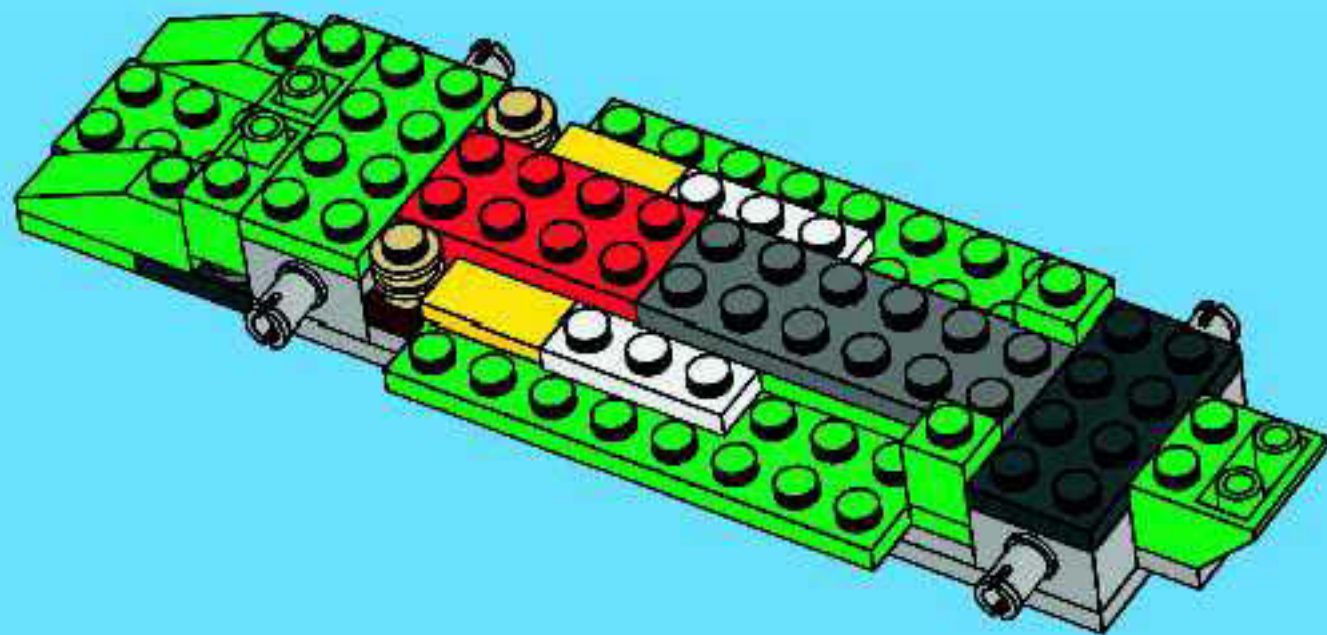





2x



2x



2x



2x

# 17

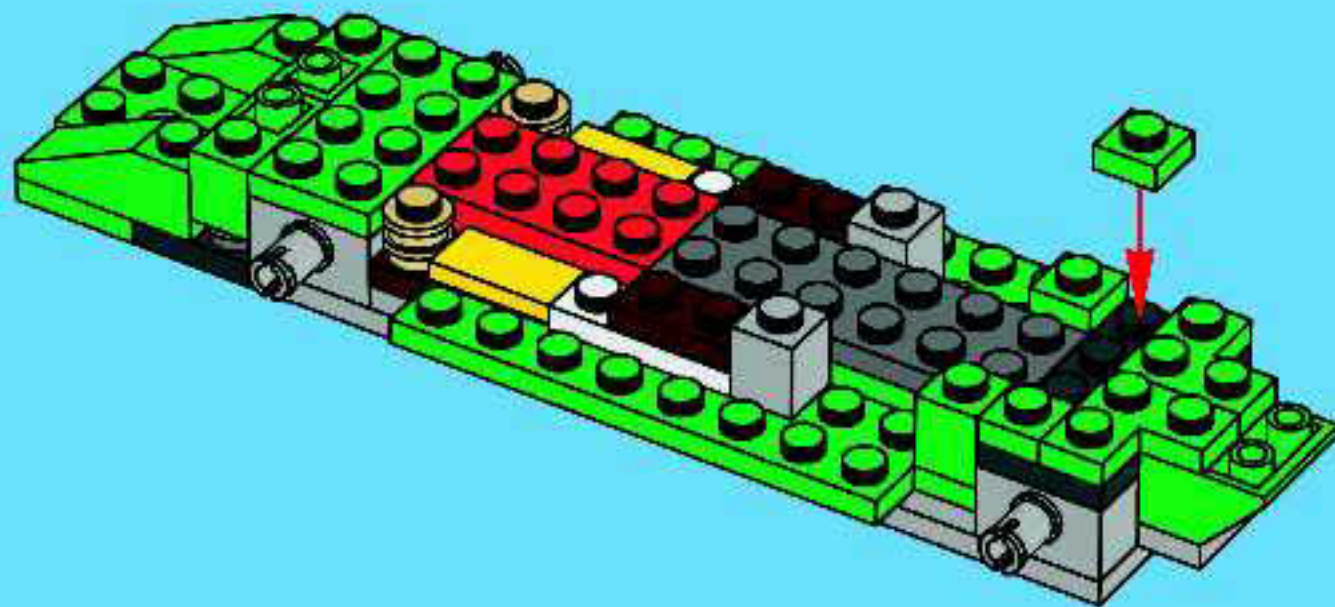

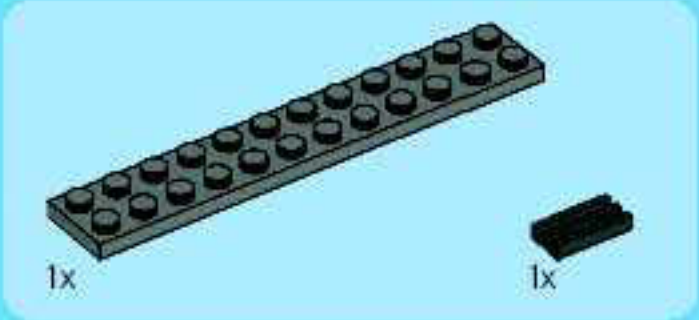

18

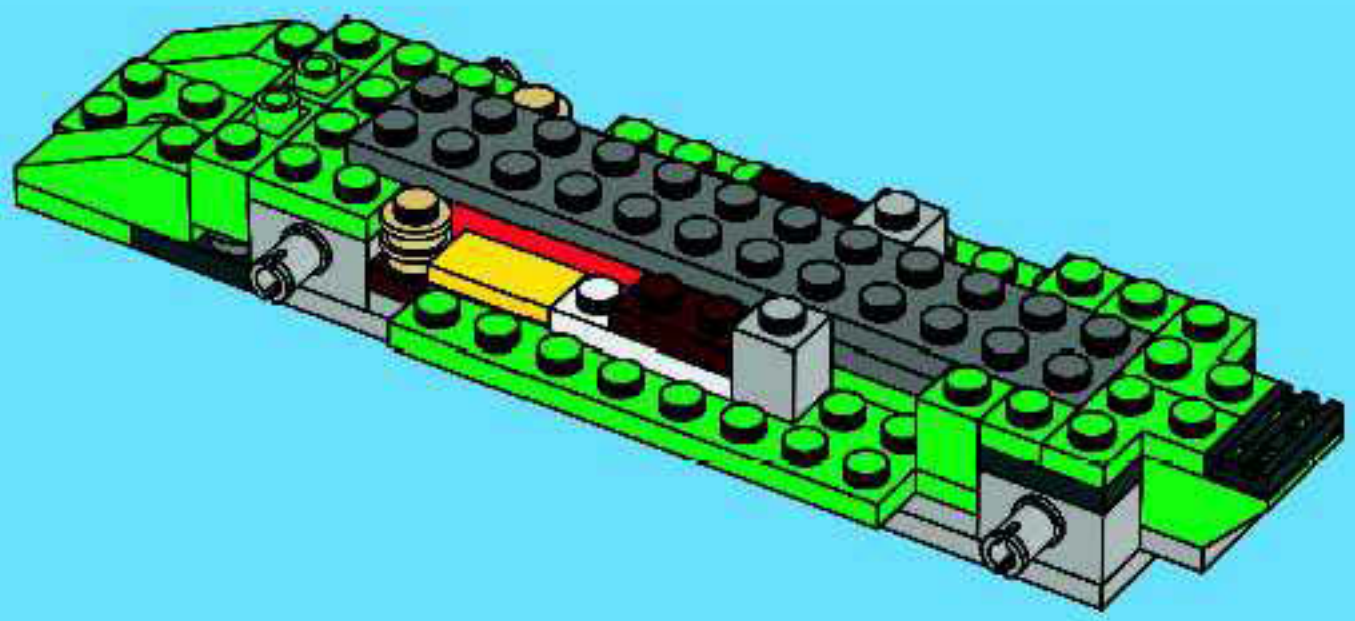



2x

19

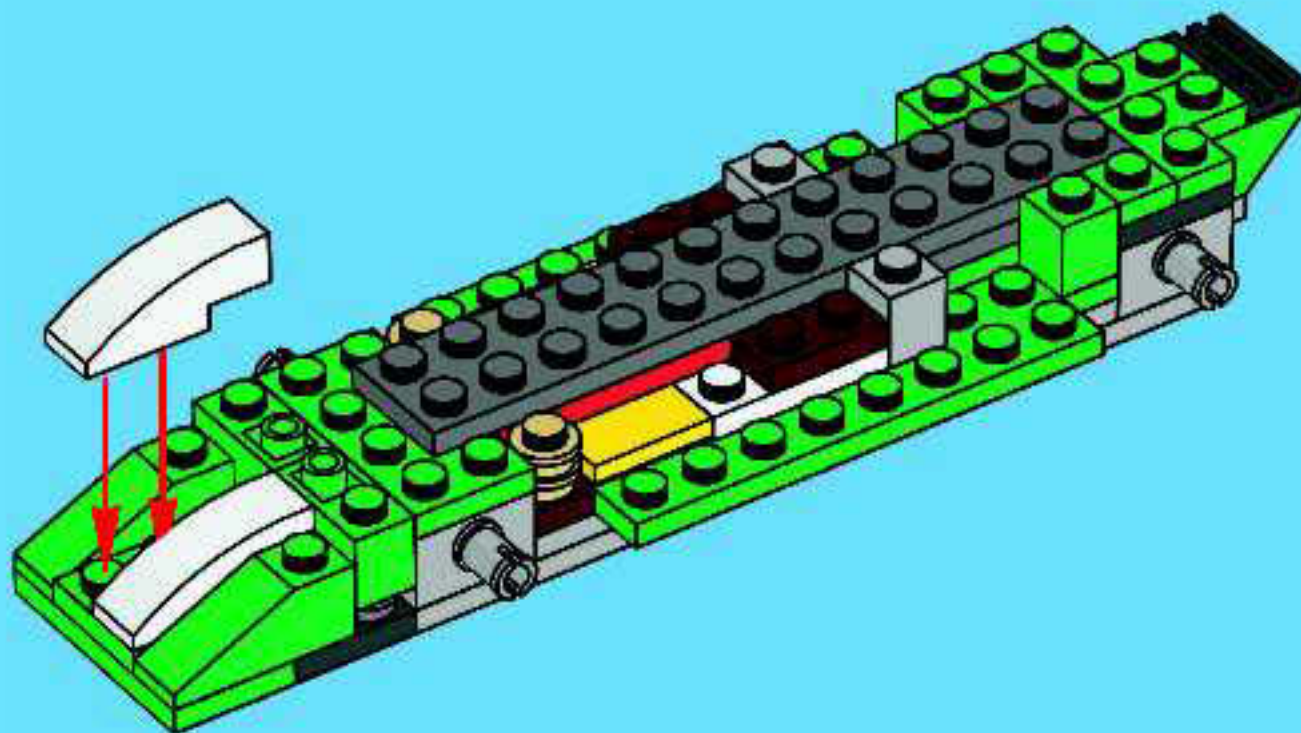





1x

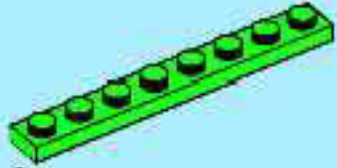

2x

20

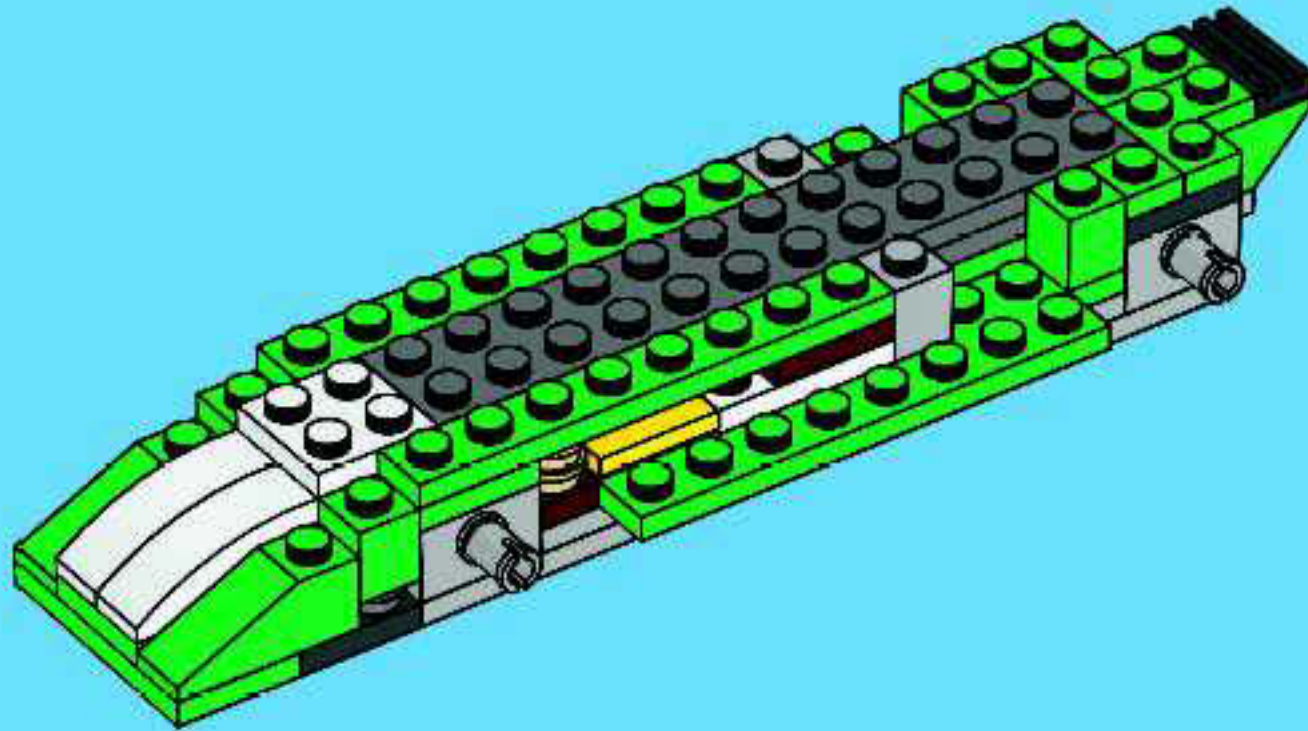

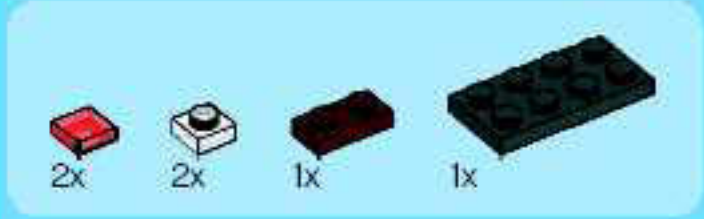

21

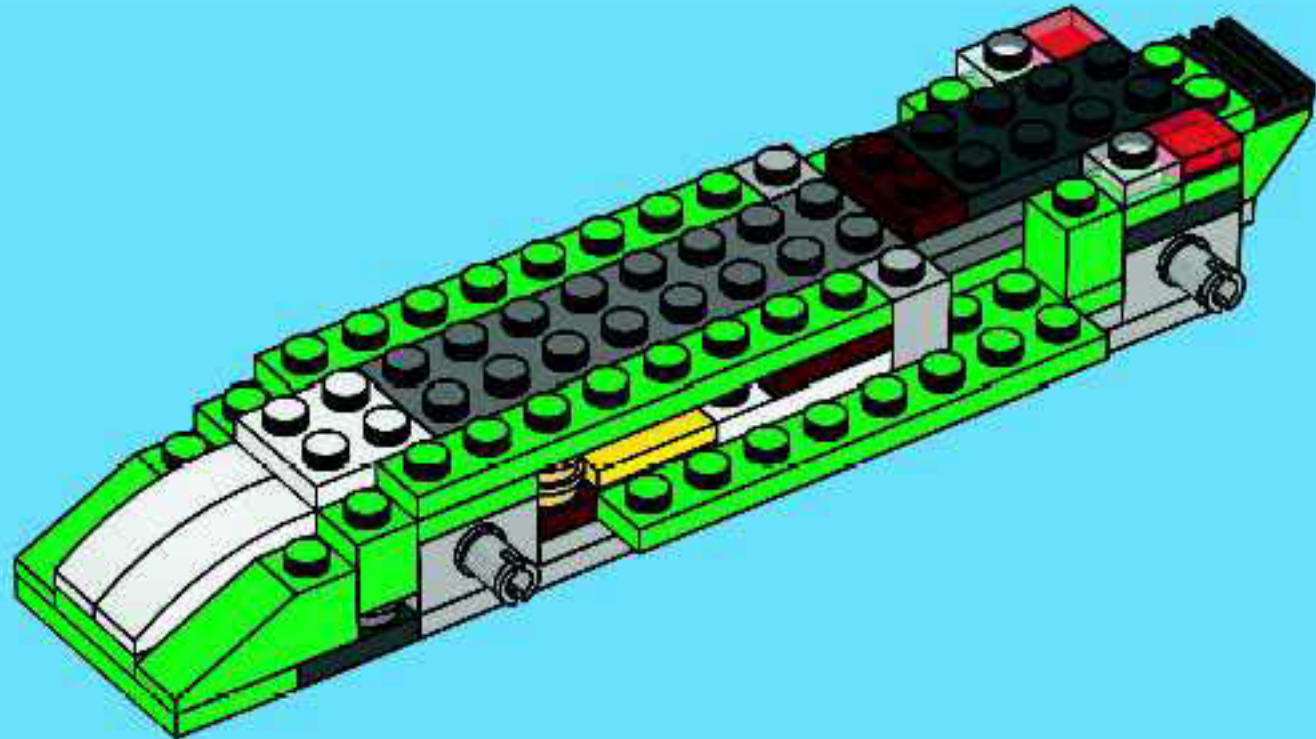



4x



2x

22

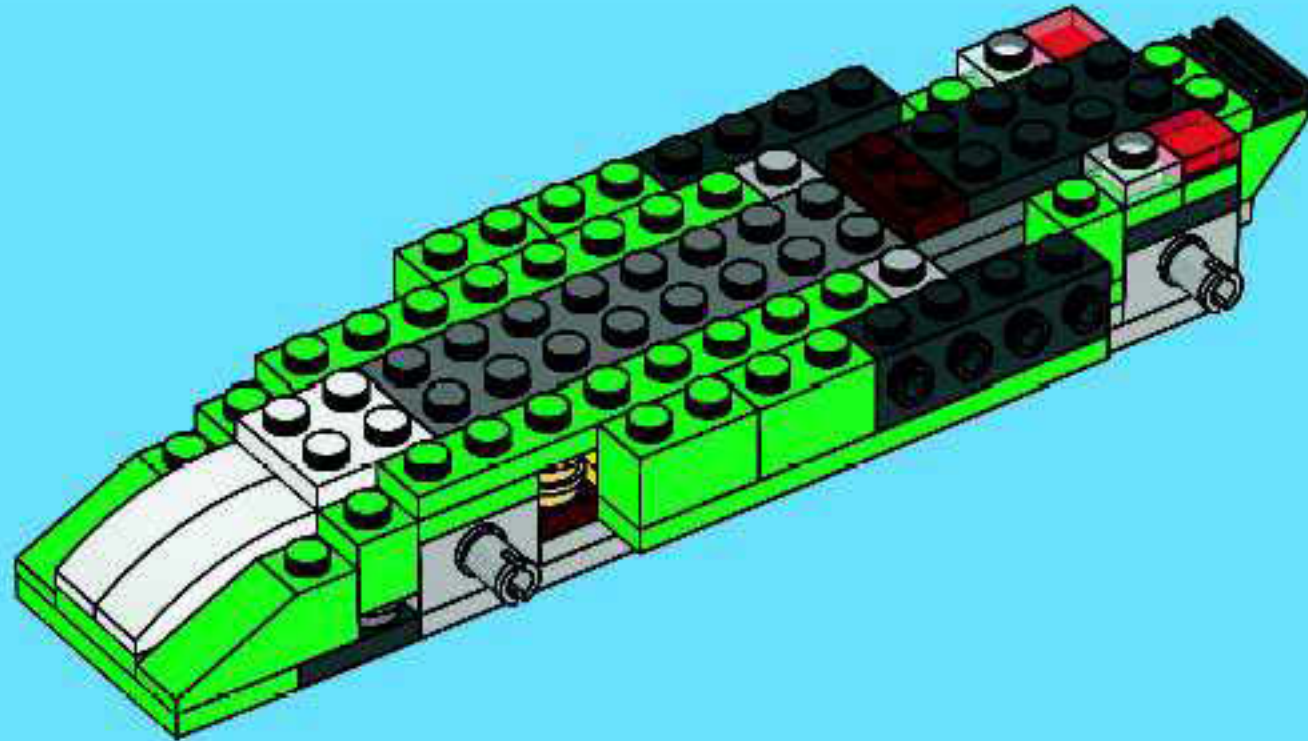



2x



2x



2x

# 23

1

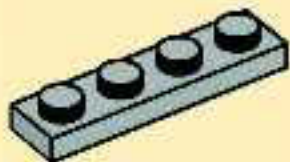

2

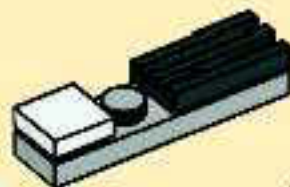

2x

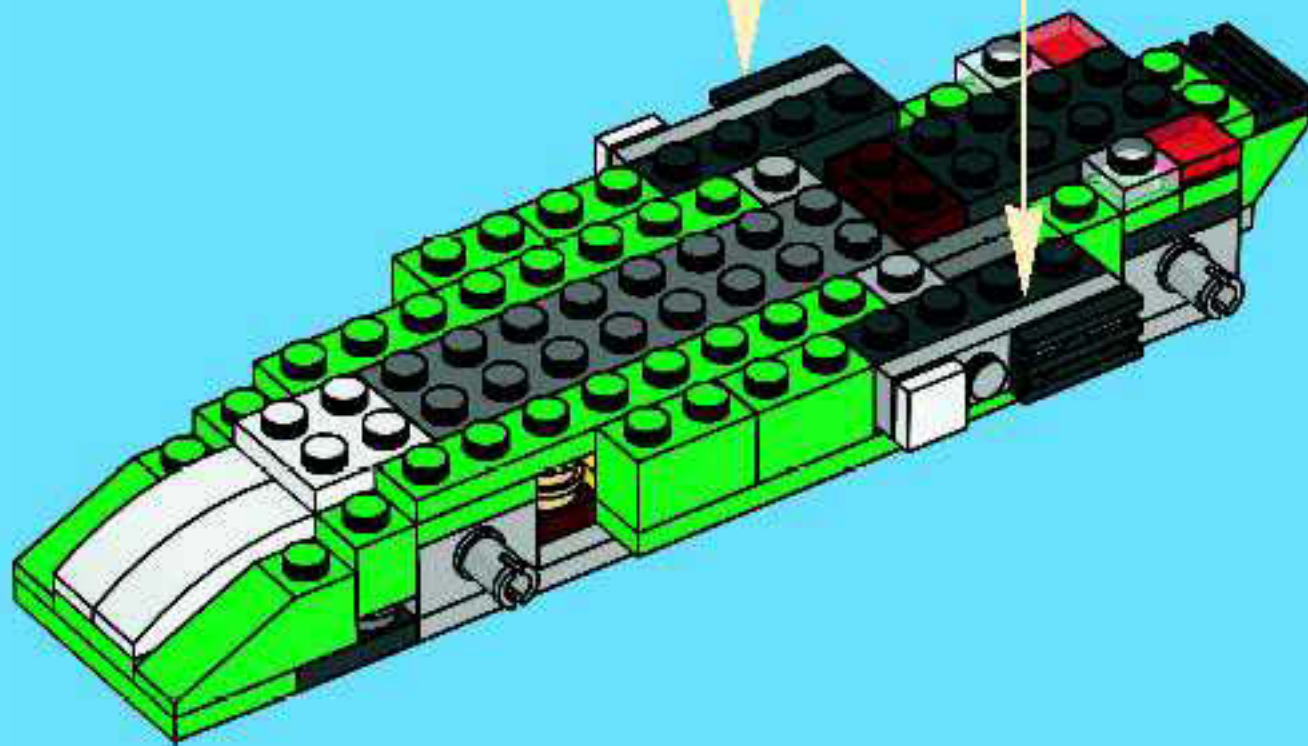



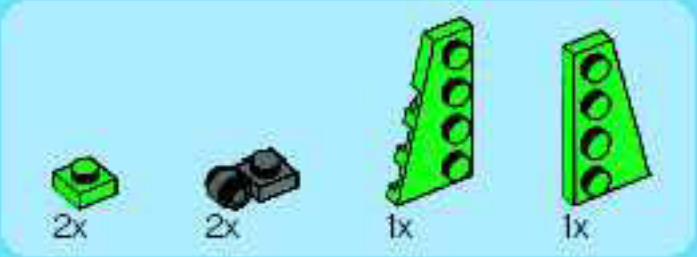

24

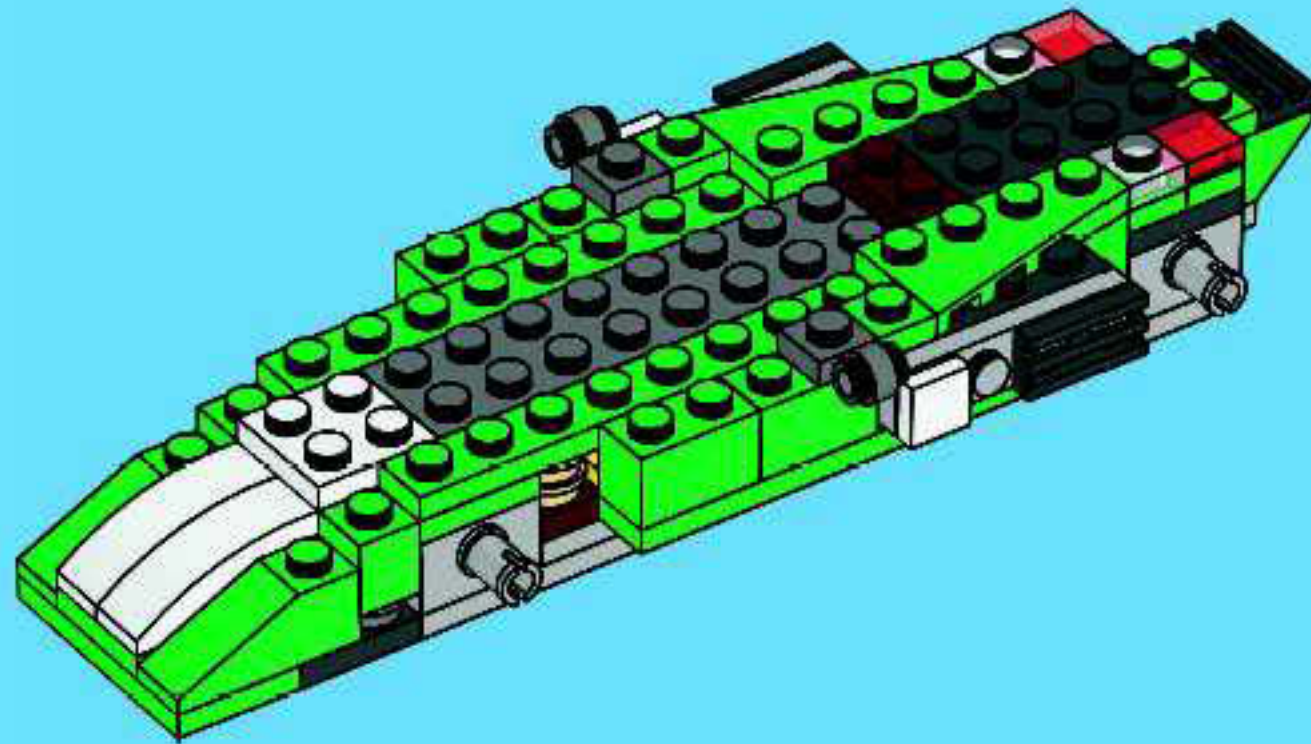



2x



1x

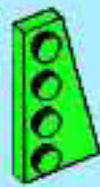

1x

# 25

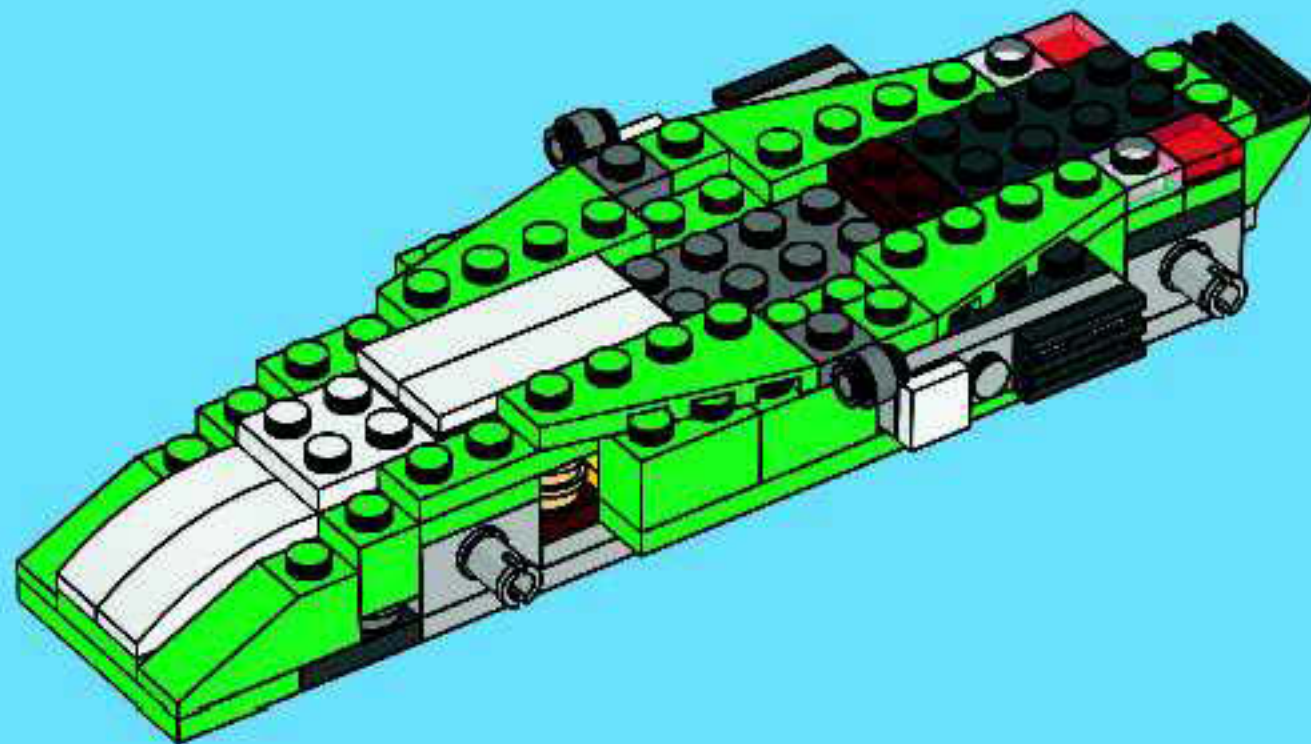



1x



2x



2x

26

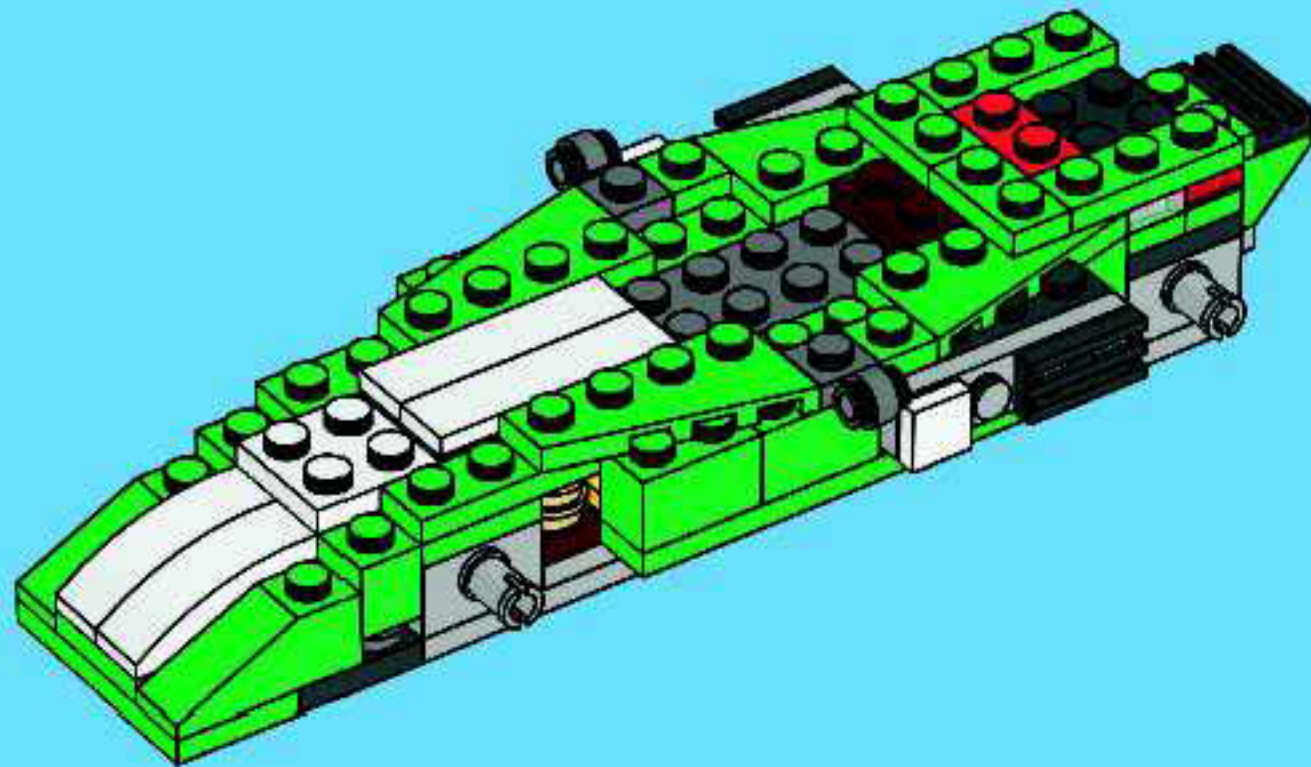





2x



1x



1x

# 27

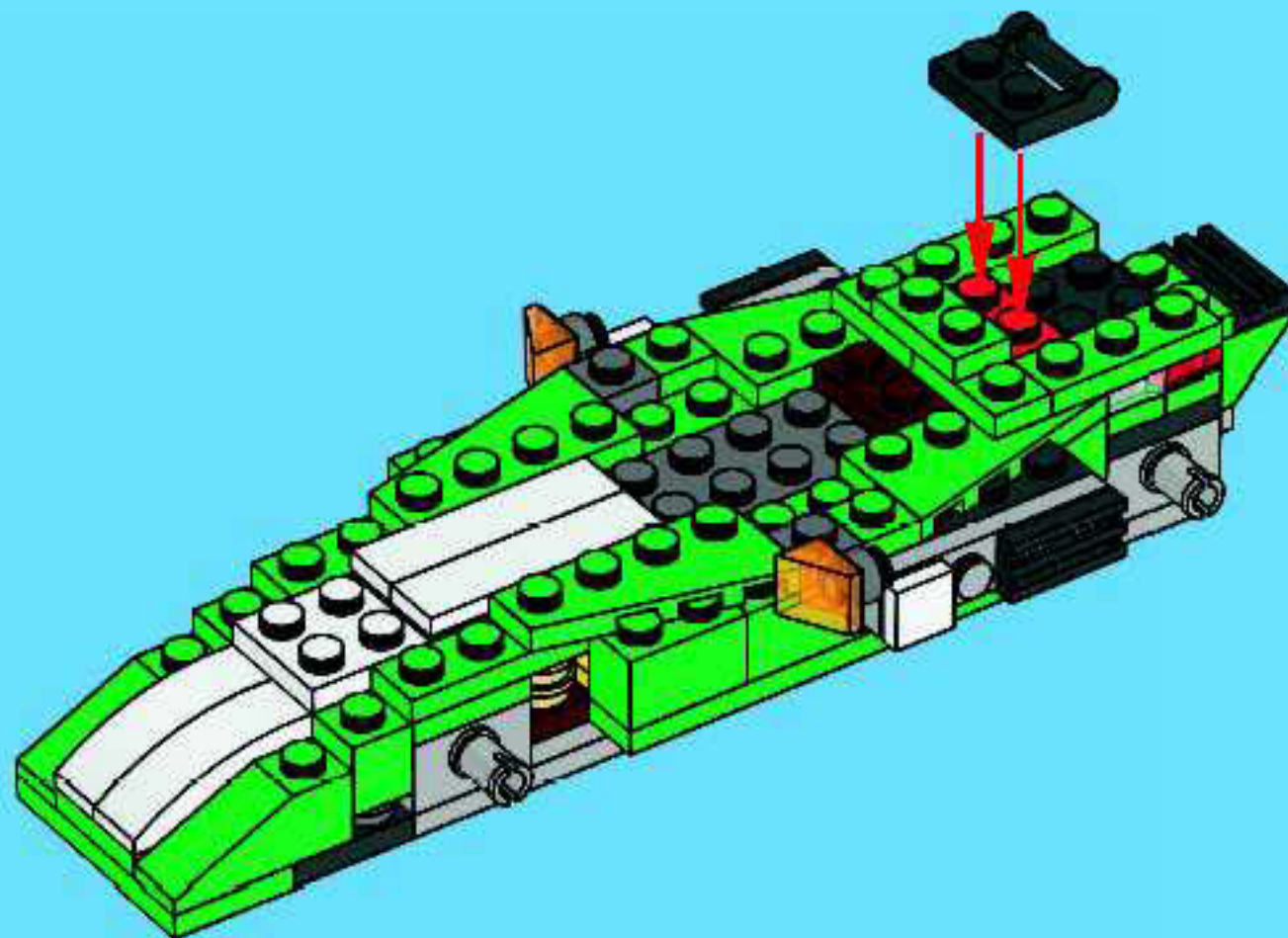





1x



1x

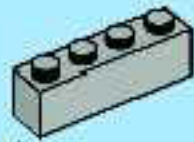

1x

# 28

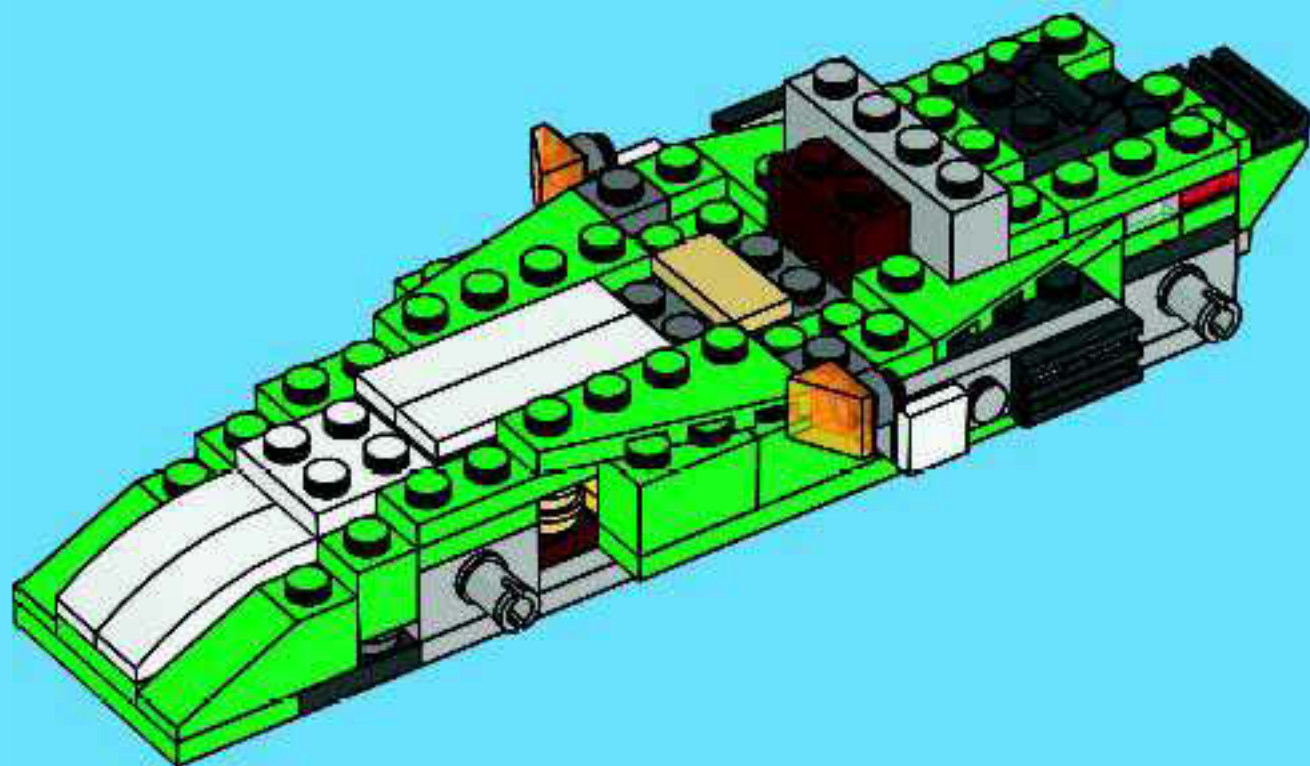



1x



2x

29

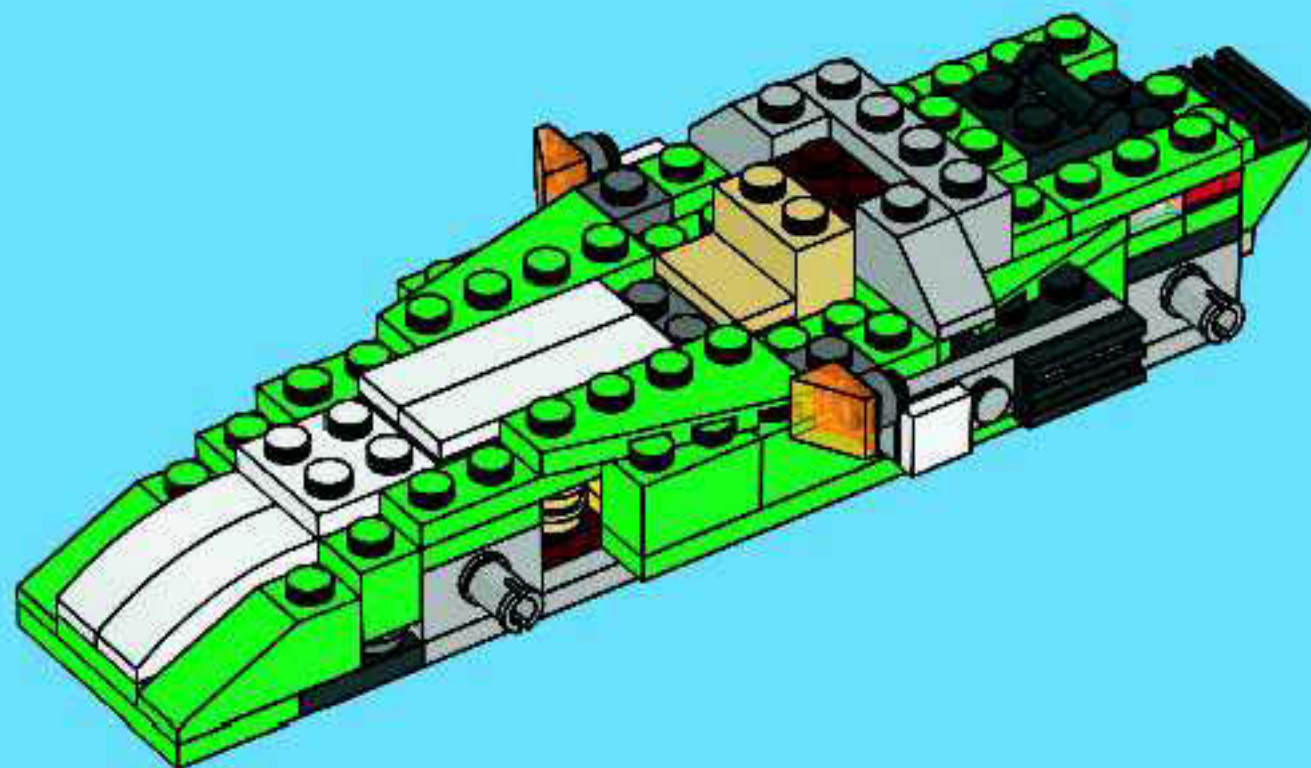



2x



2x

30

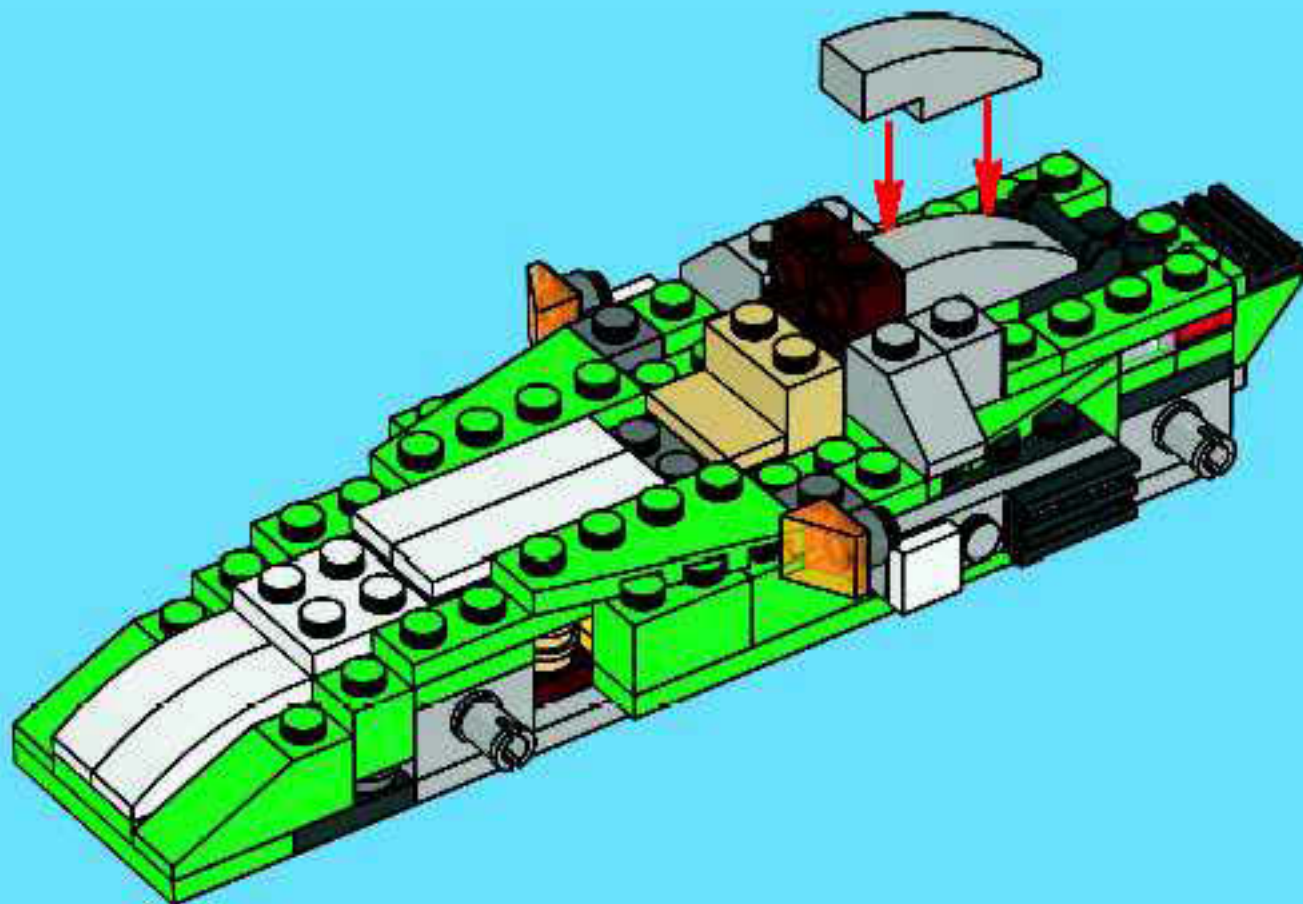





1x



2x



1x

1



2



# 31

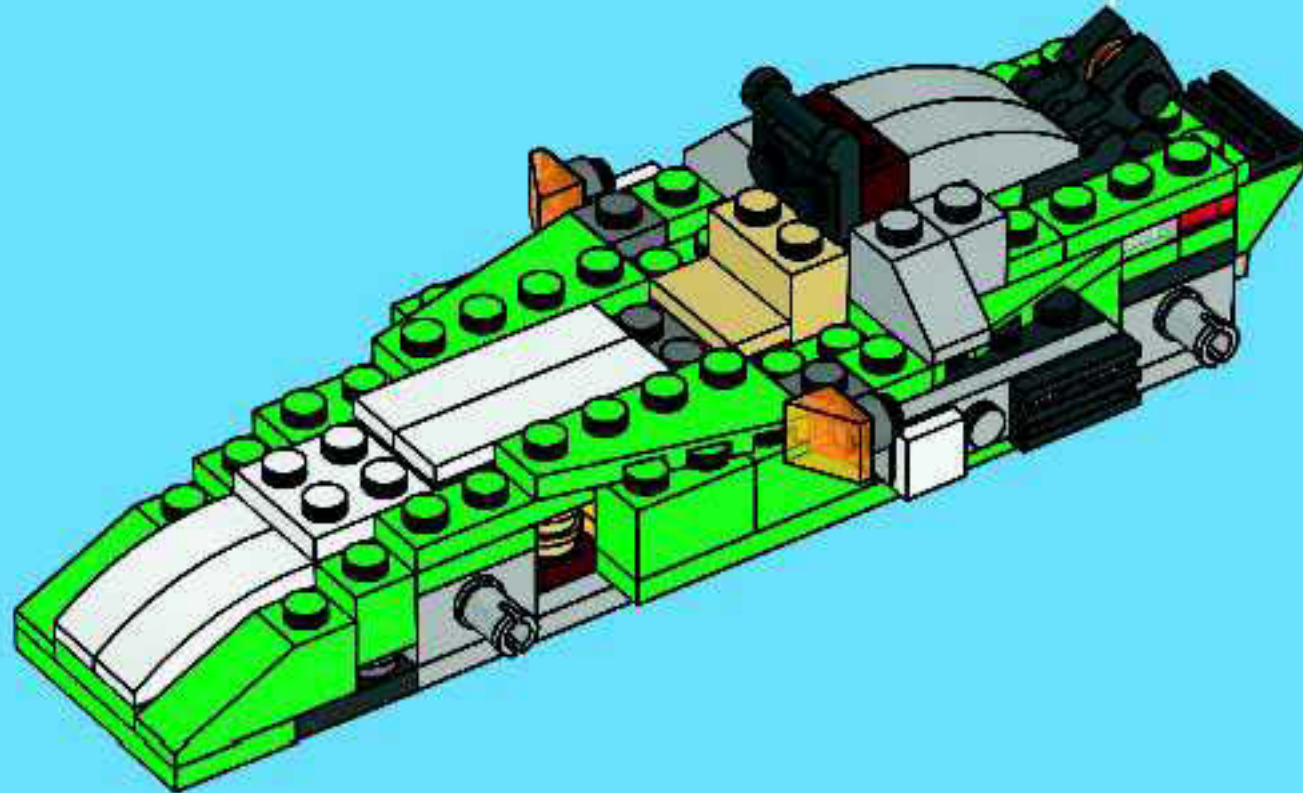





4x



2x



1x

# 32

1



2

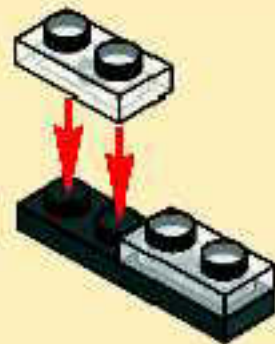

3

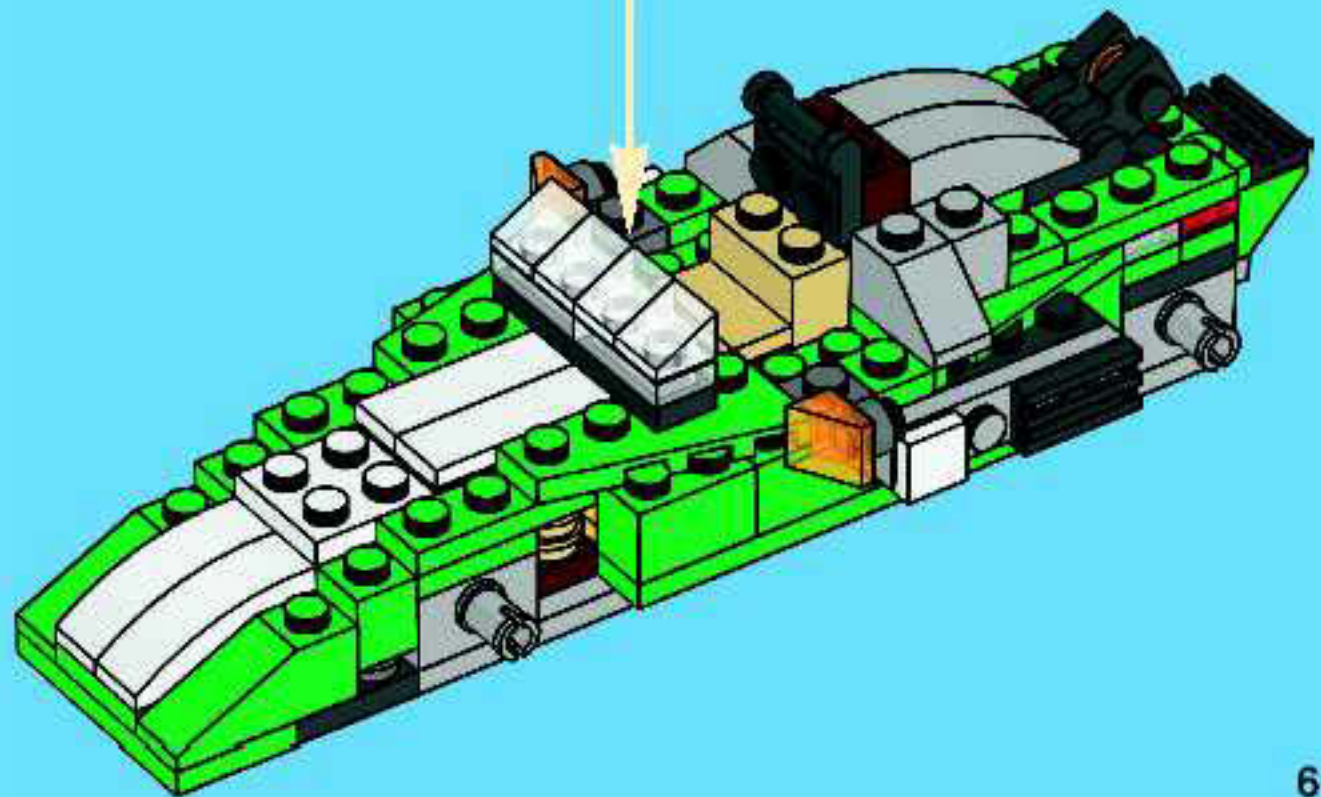
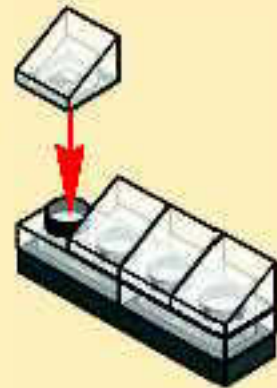



4x



4x

# 33

