



STAR WARS

75041



EN IMPORTANT: Never modify the elements or use other projectiles than provided with this toy.
DE WICHTIG: Die Elemente dürfen nicht verändert werden. Es dürfen ausschließlich die mit dem Spielzeug mitgelieferten Geschosse verwendet werden.
FR IMPORTANT : Ne jamais modifier les éléments ni utiliser d'autres projectiles que ceux fournis avec ce jouet.
IT IMPORTANTE: non modificare gli elementi o utilizzare proiettili non forniti con questo prodotto.
NL BELANGRIJK! Verander niets aan de elementen en gebruik geen andere projectielen dan de bij het speelgoed geleverde.
ES IMPORTANTE: No modificar los elementos ni utilizar otros proyectiles diferentes a los suministrados junto con este juguete.
DA VIGTIGT: Elementerne må ikke ændres, og der må ikke bruges andre projektiler end dem, der følger med legetøjet.
FI TÄRKEÄÄ: Älä koskaan tee osiin muutoksia tai käytä lelussa muita kuin sen sisältyviä ammuksia.
SV VIKTIGT: Modifiera aldrig delarna och använd aldrig andra projektiler än de som medföljer denna leksak.
PT IMPORTANTE: Nunca modifique os elementos nem utilize projecteis que não tenham sido fornecidos com este brinquedo.
EL ΣΗΜΑΝΤΙΚΟ: Ποτέ μην τροποποιείτε τα στοιχεία του παιχνιδιού και μην χρησιμοποιείτε άλλα βλήματα εκτός από αυτά που συνοδεύουν αυτό το παιχνίδι.
JA 重要：部品を改造したり、本製品に付属の発射体以外のものを使用しないようにしてください。
ZH 重要提示：切勿更改组件或使用非由本玩具附带的弹丸。
KO 중요함: 이들 부품을 수정하거나 이 완구와 함께 제공된 것이 아닌 발사체는 결코 사용하지 마십시오.
RU ВАЖНО: запрещается вносить изменения в элементы или использовать другие снаряды, отличные от тех, которые поставляются с данной игрушкой.
PL WAŻNE: Nigdy nie modyfikować elementów zabawki ani nie używać pocisków innych niż dostarczone z zabawką.
CZ UPOZORNĚNÍ: Nikdy neupravujte součástky a nepoužívejte jiné projektily než ty, které jsou dodávány s touto hračkou.
SK UPOZORNENIE: Nikdy neupravujte súčiastky a nepoužívajte iné projektily než tie, ktoré sú dodávané s touto hračkou.
HU FONTOS: Az elemeket nem szabad módosítani, és a játékhöz adott lövedékek helyett sem szabad mást használni.
UA ВАЖЛИВО: забороняється вносити зміни до елементів або використовувати інші снаряди на відміну від тих, що поставляються з цією іграшкою.
HR VAŽNO: Nemojte nikad mijenjati elemente ili koristiti druge projekte osim onih koji su bili priloženi uz ovu igračku prilikom kupnje.
SR Важно: Немојте да модификујете елементе и не користите друге пројектиле осим оних који долазе уз ову играчку.
SL POMEMBNO: Nikoli ne spreminjajte elementov in uporabljajte le izstrelke, ki so bili priloženi tej igrači.
RO IMPORTANT: Nu modificați niciodată elementele și nu utilizați alte proiectile decât cele furnizate cu această jucărie.
BG ВАЖНО: Не видоизменяйте елементите и не използвайте други снаряди освен приложените към тази играчка.
LV SVARĪGI! Nekad nepārveidojiet rotālietas elementus, vienmēr izmantojiet tikai tās komplektā iekļautās lodītes.
ET OLULINE: Mänguasja osi ei tohi teistega asendada, kasutada võib ainult kaasasolevat heitkeha.
LT DĖMESIO! Niekuomet nekeiskite elementų ir naudokite tik tuos šovinius, kurie yra pridėti prie šio žaislo.
TR ÖNEMLİ: Hiçbir zaman parçaları değiştirilmez veya bu oyuncakla sağlananlar dışında mermiler kullanılmaz.

1



2



3



4







1

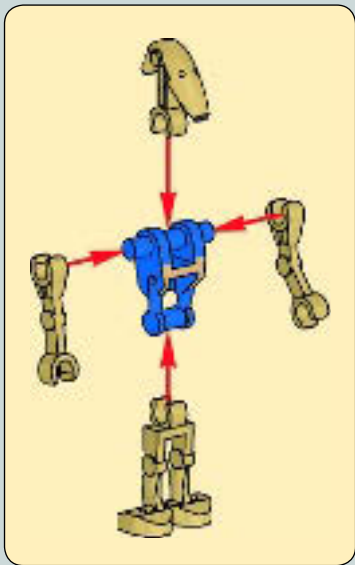



1



2





2x



1x



1x

3



1

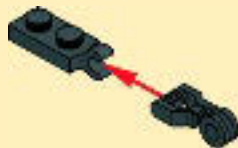

2





4



2x





1x



2x



2x

5

1

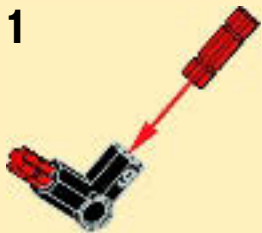

2

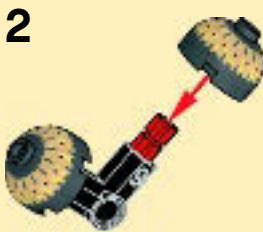

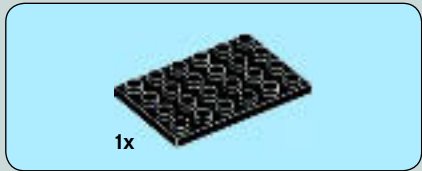

1



2





3x

3



2x



2x

4

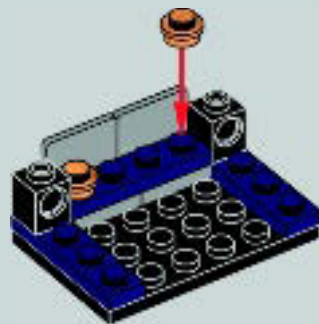



2x

5



2x

6

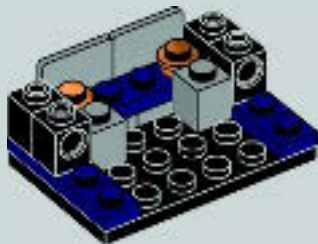

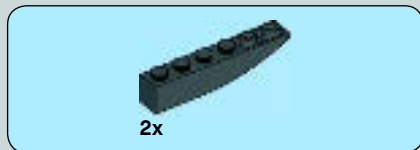

7

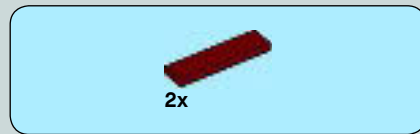
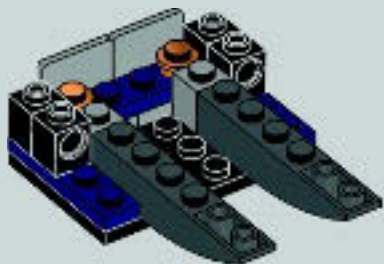

8

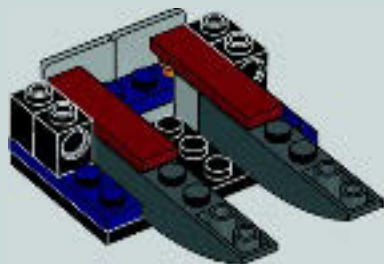



2x

9

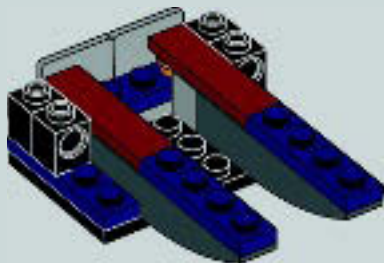

2x

10

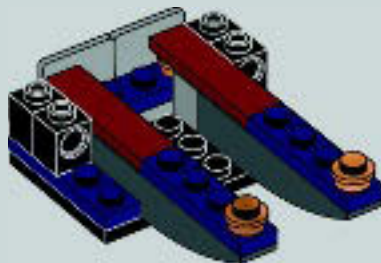



2x



11

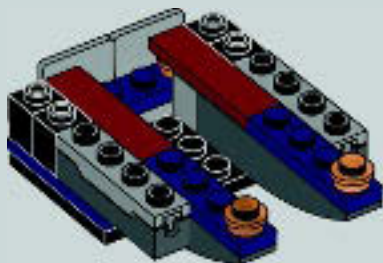

2x

12

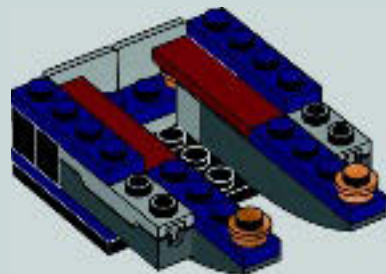

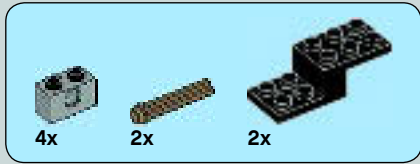

13

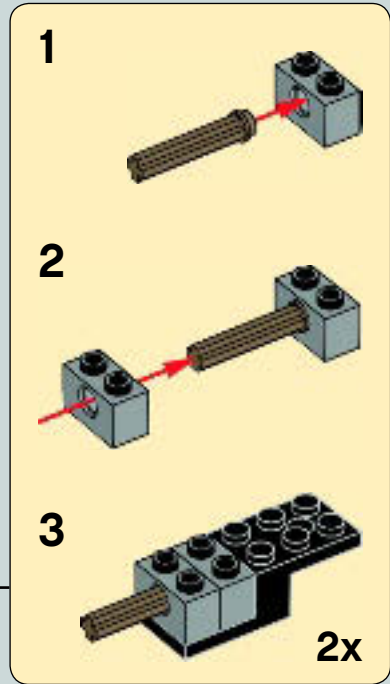
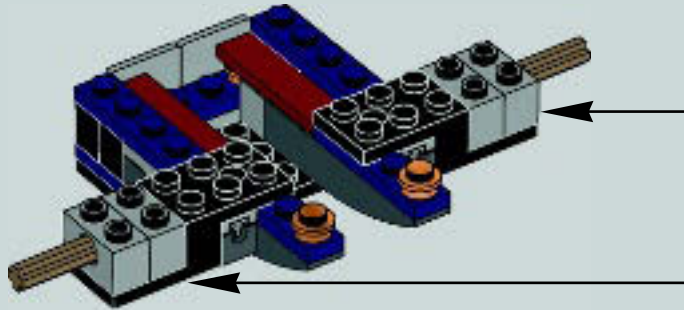



14

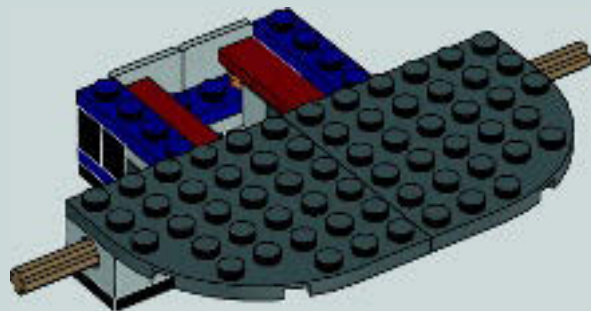

15

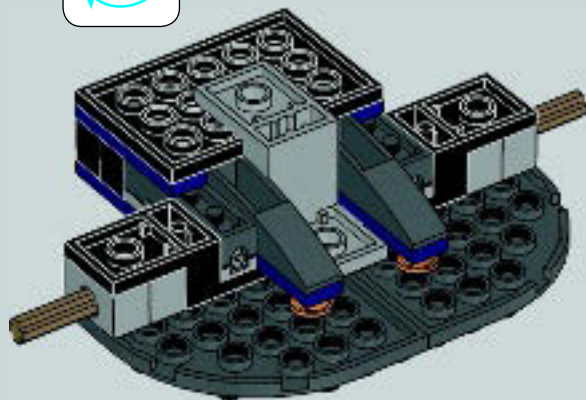
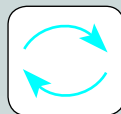



1x



1x

16

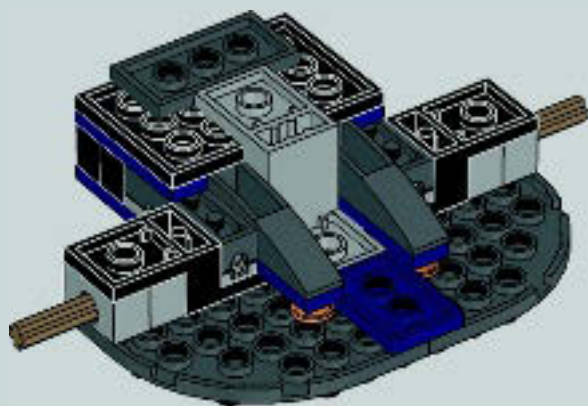



3x

17

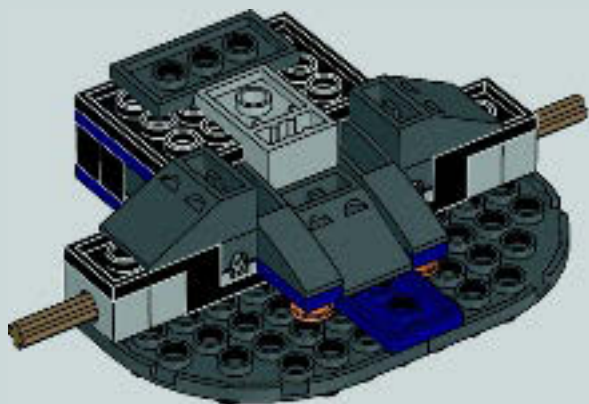

2x

18

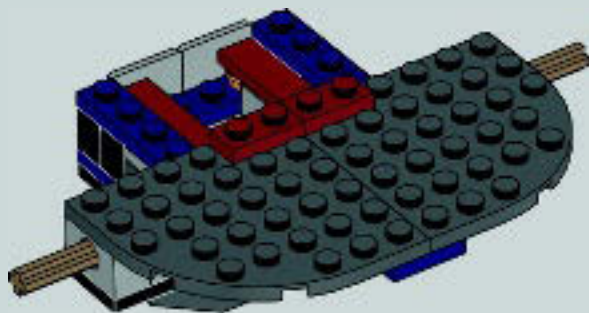
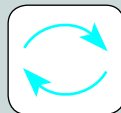



19

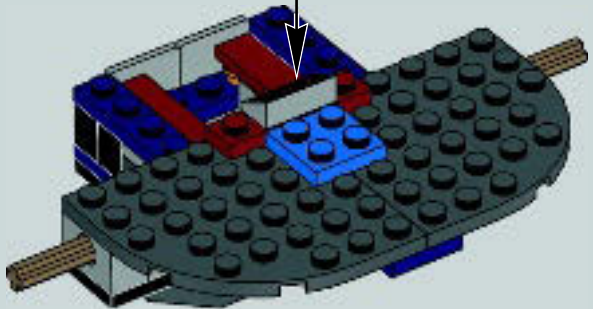
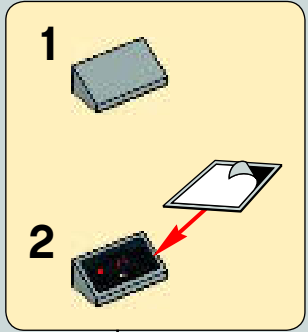



2x

20

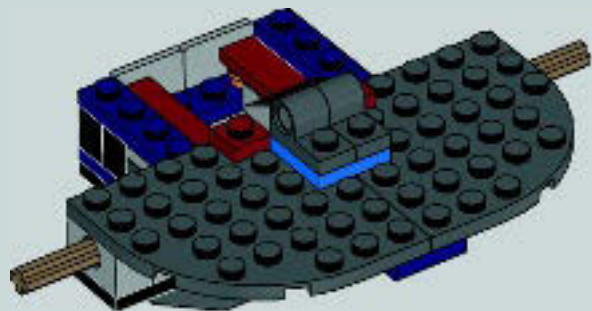

2x

21

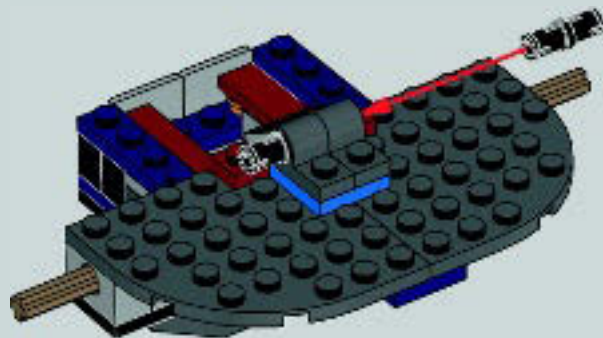



2x

22

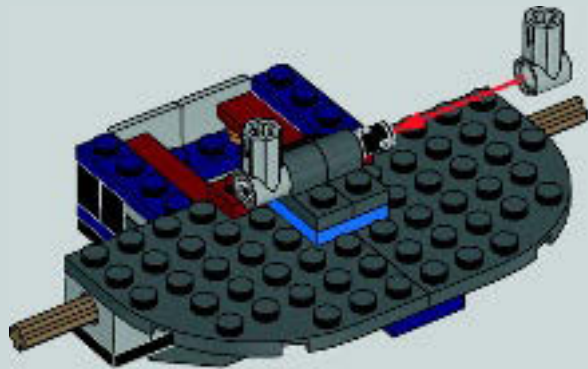



2x

23

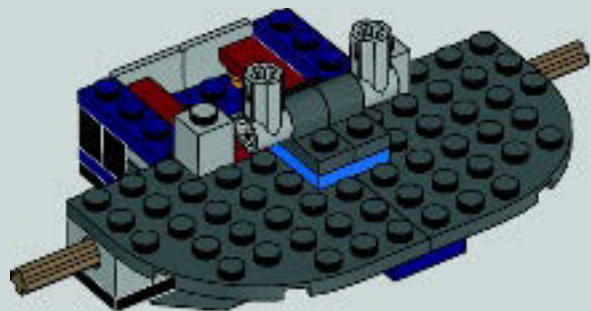

2x

24

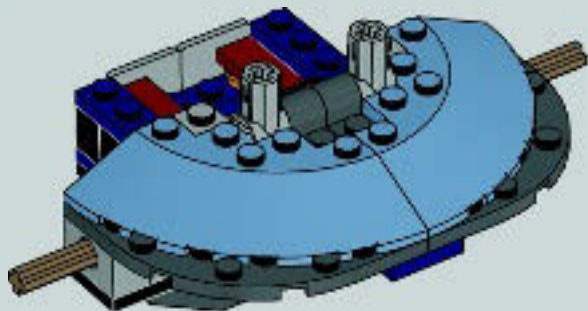



2x

25

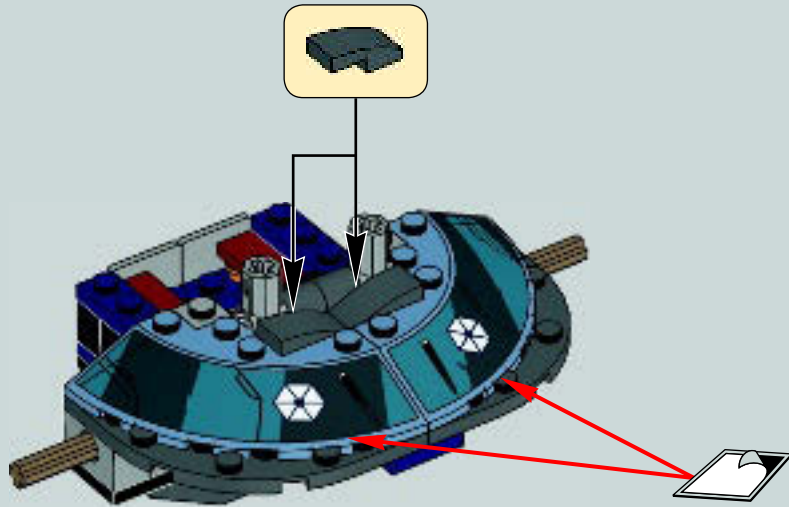

24



26

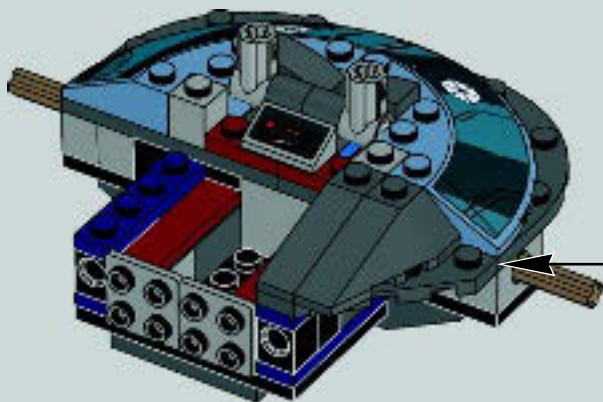
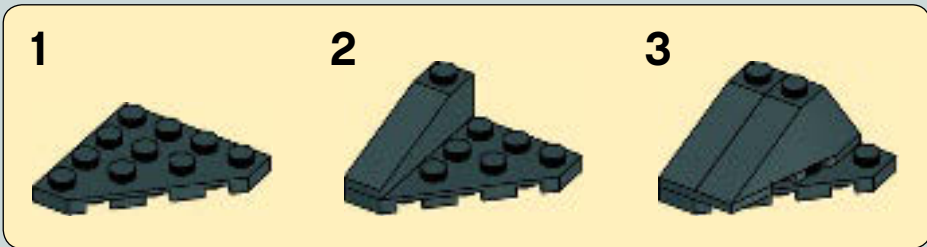
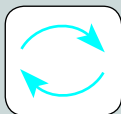

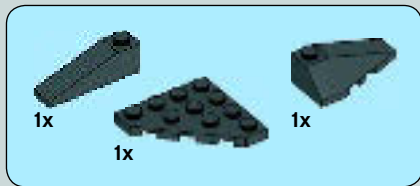

27

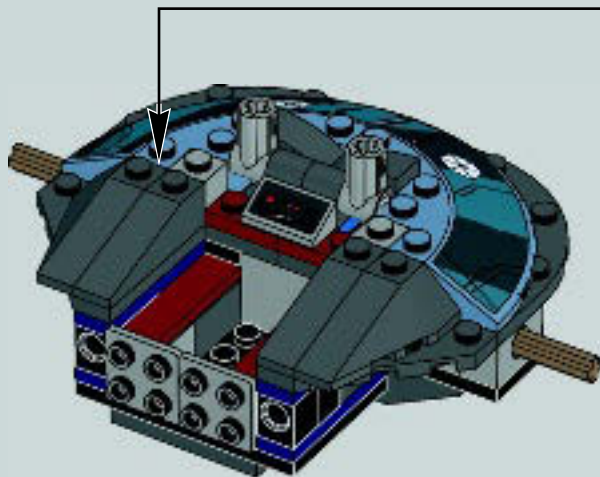
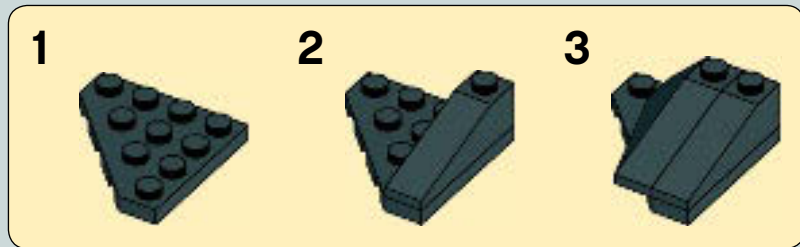



2x

28

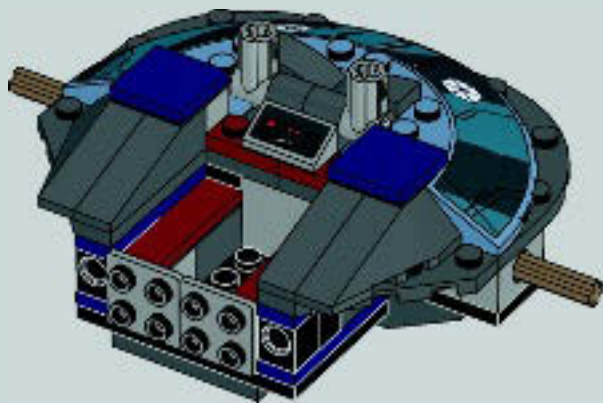

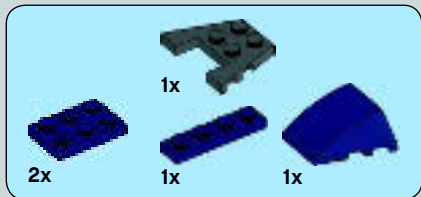

29

1



2

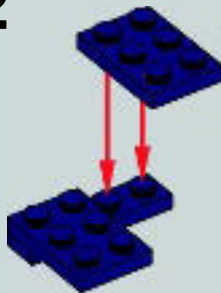

3



4

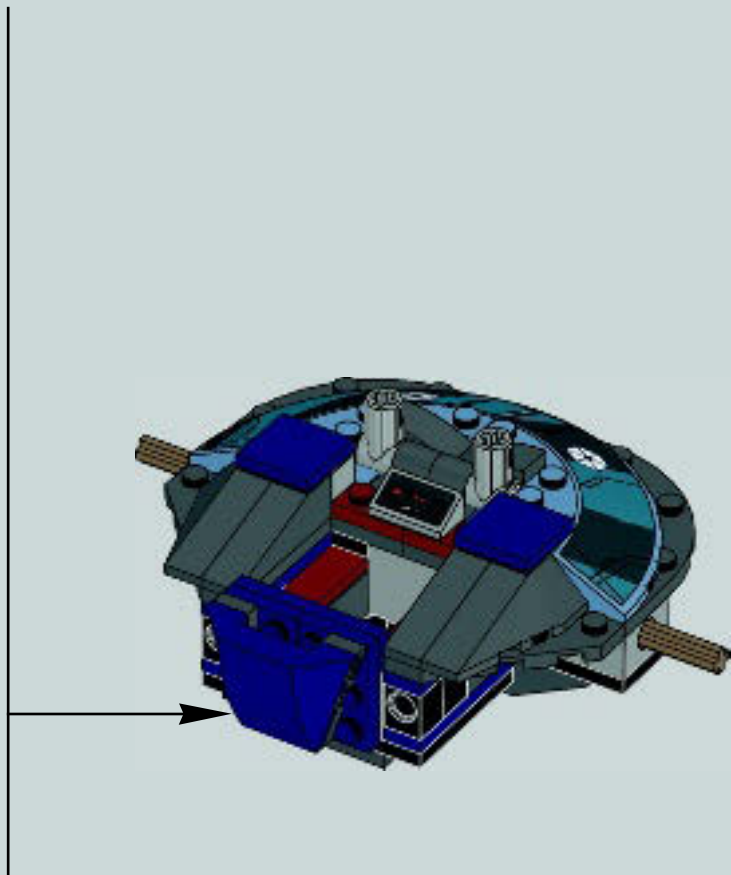



1x

1



1x



1x

2

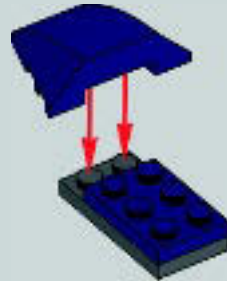



3



4

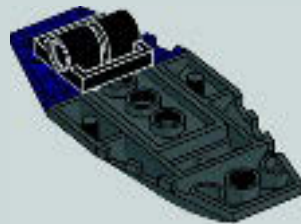
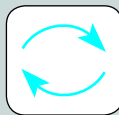



5



6

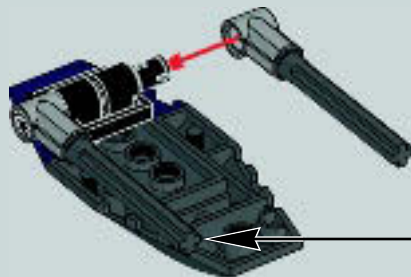

2x

7

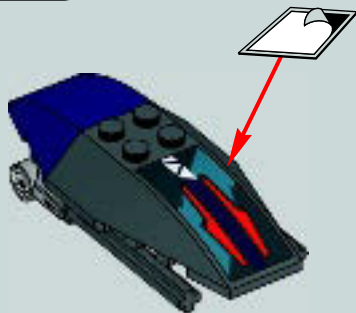
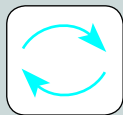

30

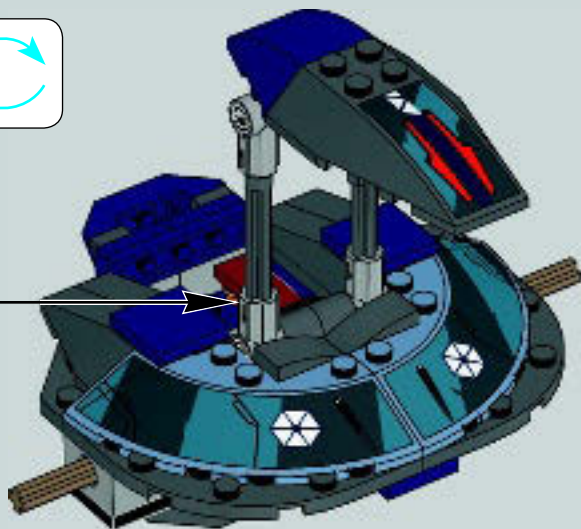
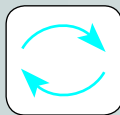

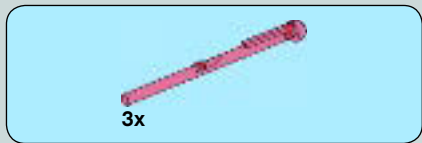

31

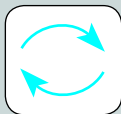

32

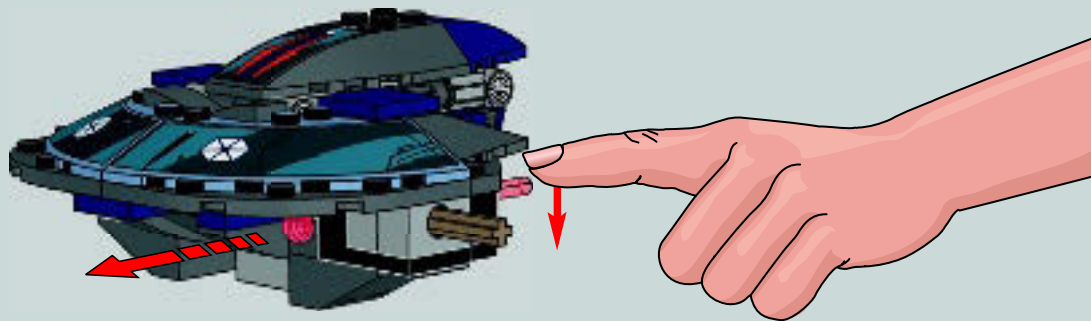

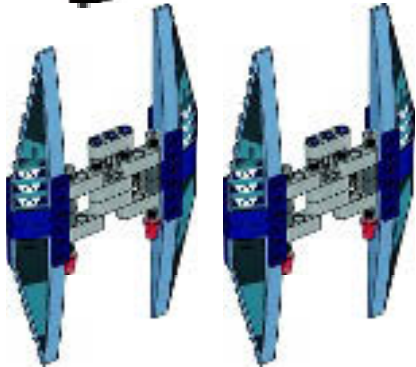

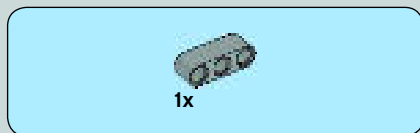
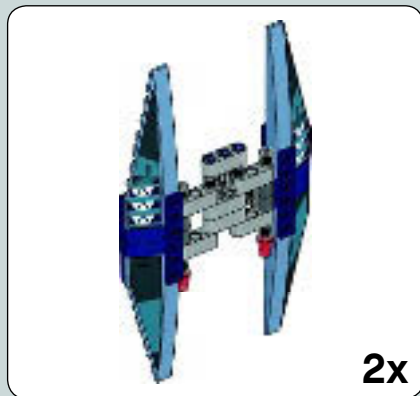

1



2

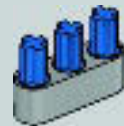



1x

3

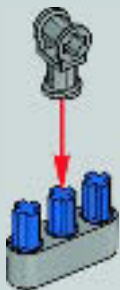

38



2x

4





2x

5

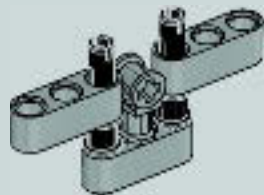

1x



1x

6

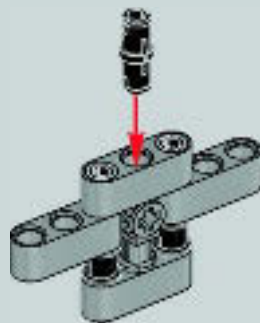

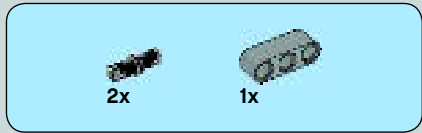

7

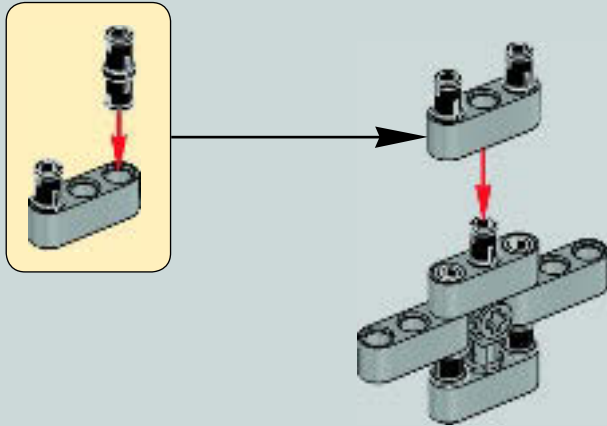



2x

8

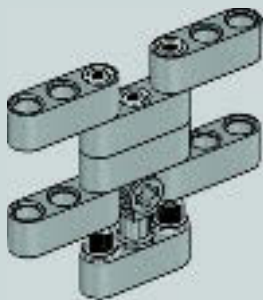

4x

9

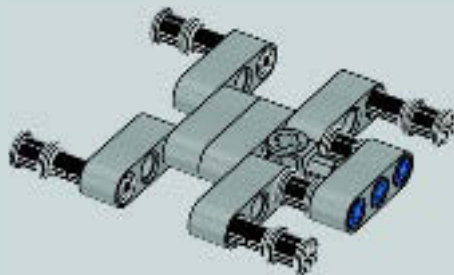
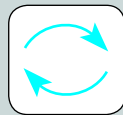

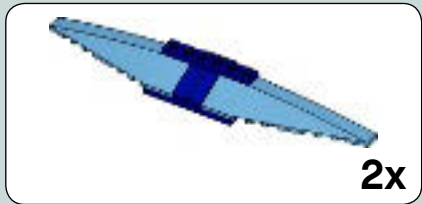

1

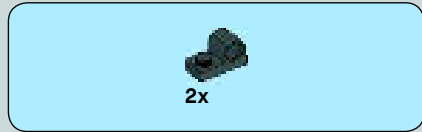

2





3

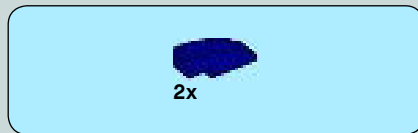

4

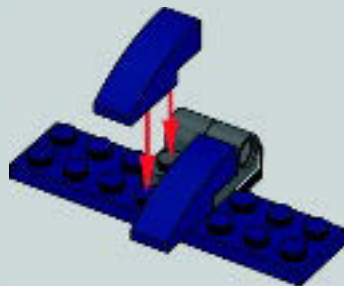

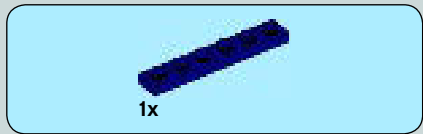

5

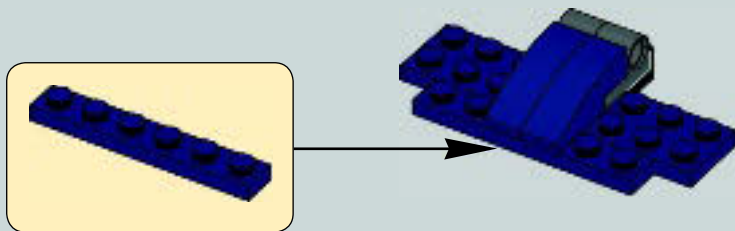

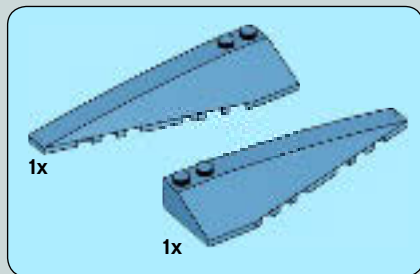

6

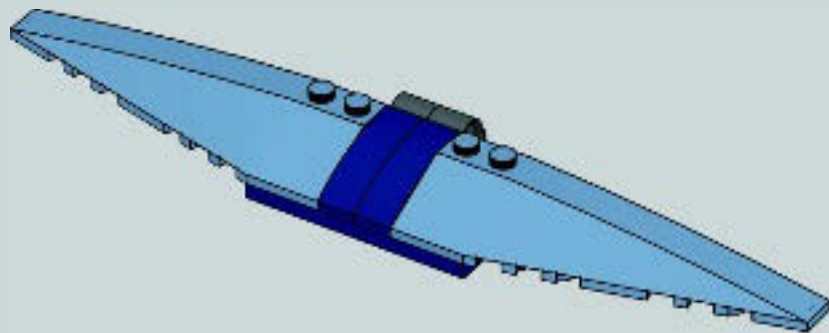

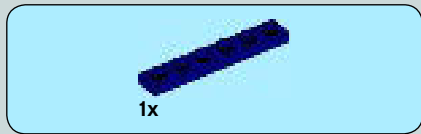

7

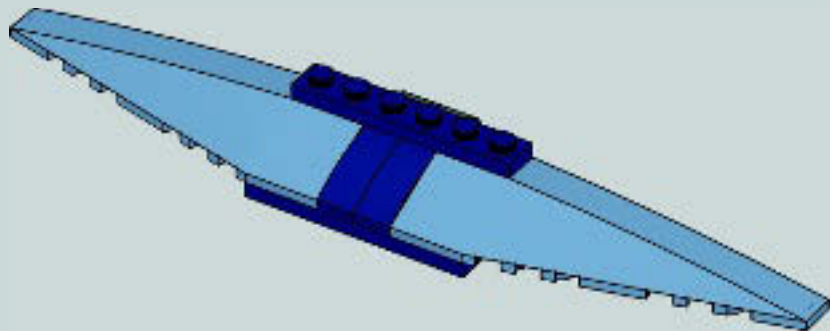

10

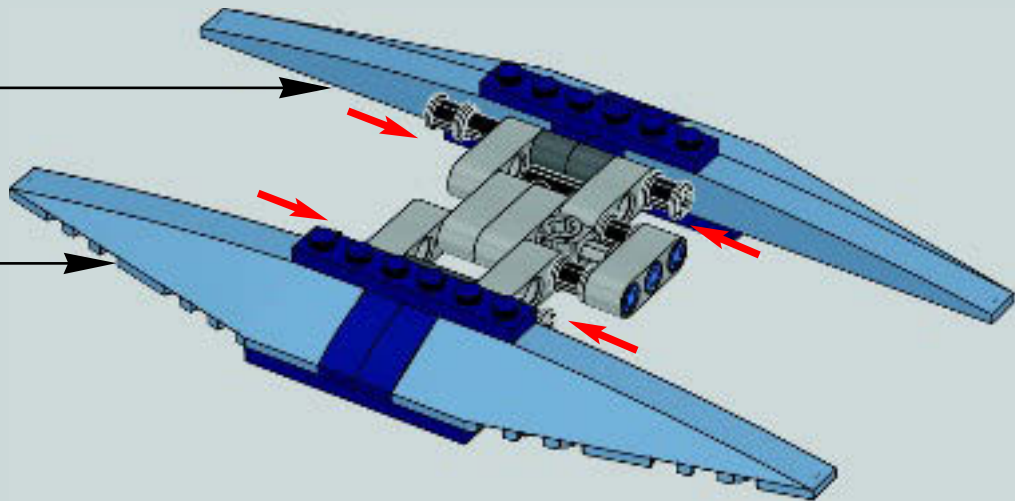



2x



2x



2x

11

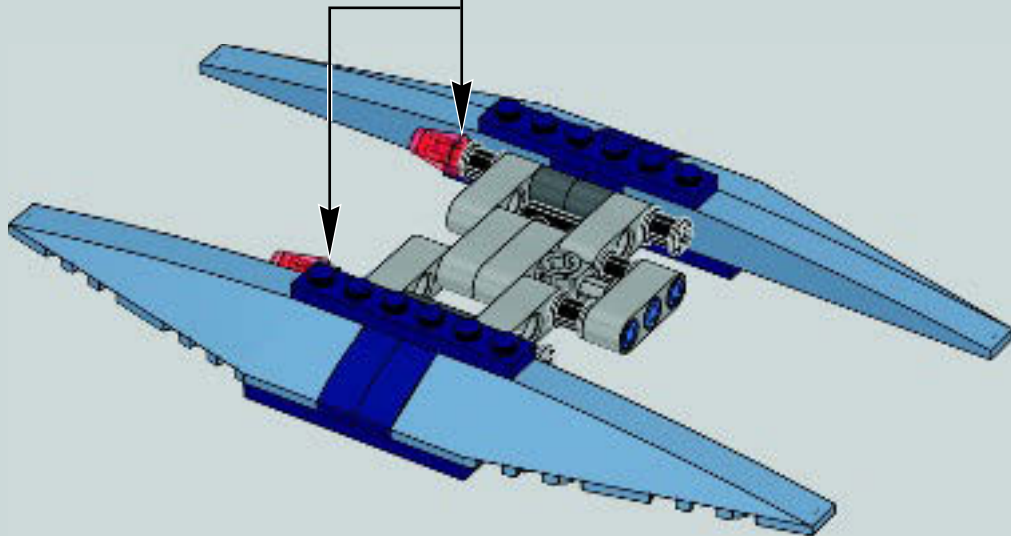

12

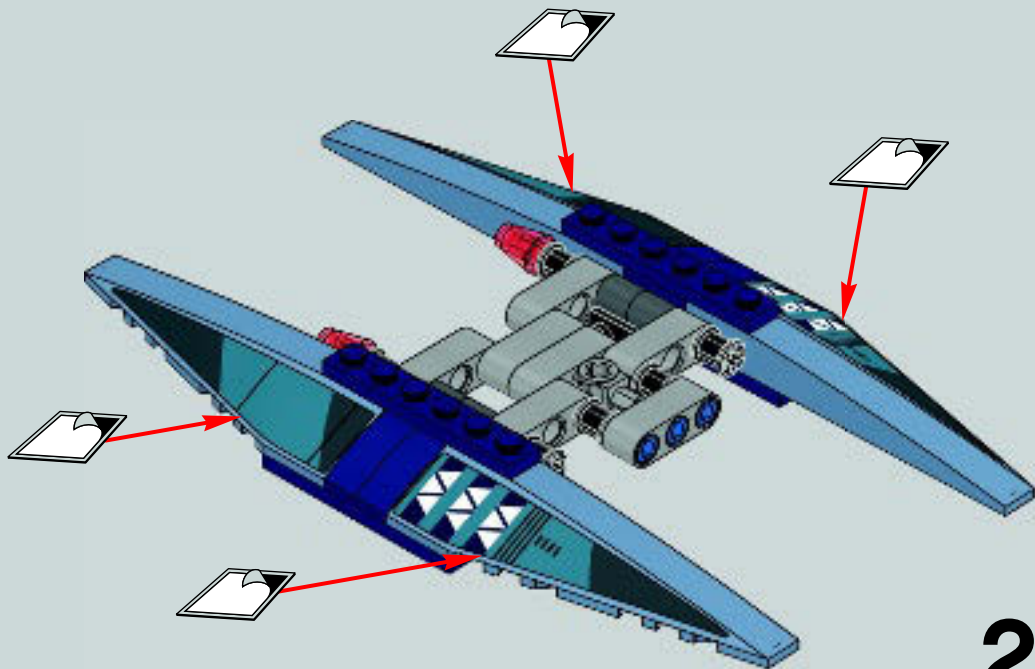

2x



4x

13

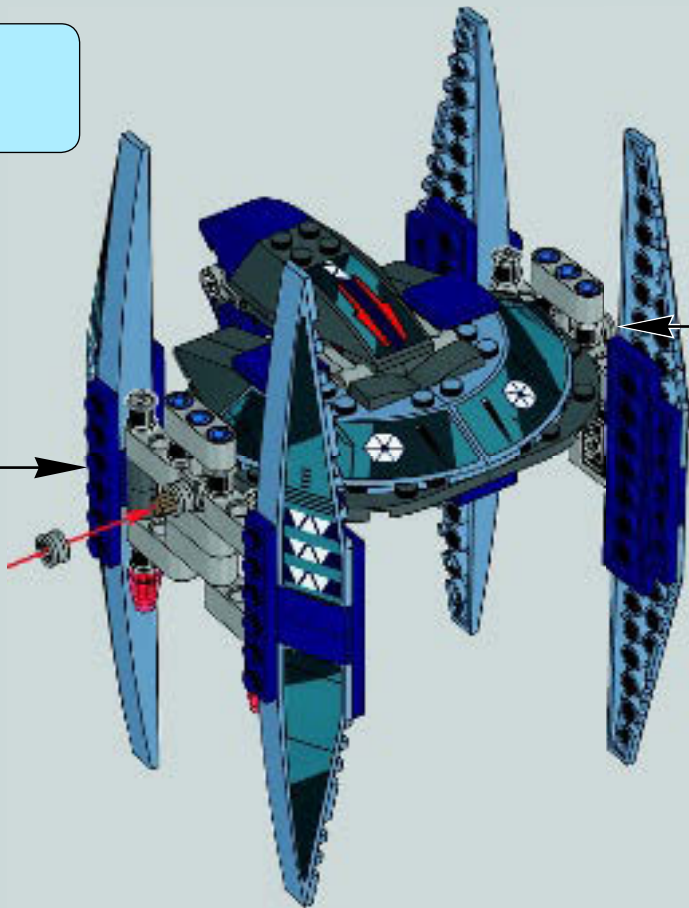

2x

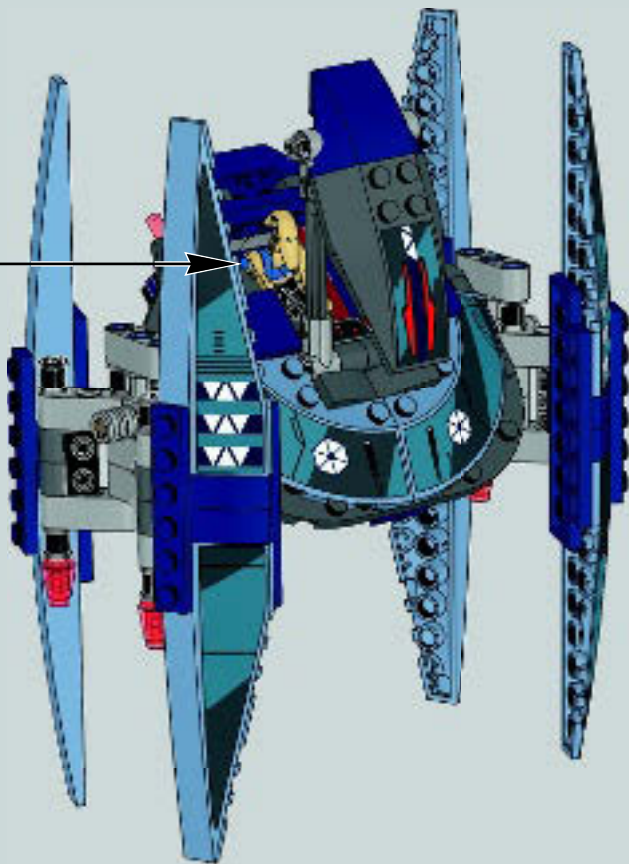

 1x 4508093	 4x 654126	 10x 4121715	 4x 4221775	 1x 4568637	 1x 302223	 2x 4539097	 1x 4211081	 2x 4508553	 2x 6048898
 1x 4545336	 4x 6020193	 12x 4140801	 14x 4211655	 2x 4654580	 1x 4614789	 2x 4539060	 2x 6029948	 2x 4535930	 1x 6064958
 1x 6029182	 1x 281726	 2x 6039194	 4x 4211573	 2x 6058942	 6x 4206482	 8x 4540280	 10x 6019987	 1x 4210867	 1x 6064955
 1x 4261885	 1x 4609050	 1x 303226	 4x 4211550	 1x 6012653	 1x 6064962	 2x 6034535	 1x 4581225	 1x 4210866	 4x 4523159
 6x 4142865	 1x 6051527	 3x 6054526	 2x 4211553	 2x 3005747	 1x 4211311	 2x 4205004	 3x 4211064	 2x 4210779	 2x 6031821
 1x 4567339	 1x 4107767	 4x 4544720	 4x 4211389	 1x 6056672	 1x 6064942	 4x 4530028	 2x 4211065	 2x 4210728	 2x 4210728
			 1x 4211511	 2x 6056672	 4x 6056669	 8x 4502089	 1x 4596895	 2x 4210728	 1x 4180486
			 4x 4211440	 4x 6056669	 4x 6056667	 8x 4508313		 1x 4180486	
				 4x 6056667		 4x 6027627		 2x 4500517	

 Customer Service

Kundenservice

Service Consommateurs

Servicio Al Consumidor

LEGO.com/service or dial



00800 5346 5555 :



1-800-422-5346 :



LEGO.com/starwars





75034



75034



75035



75035, 75042



75036



75036



75037



75037, 75042,
75043, 75044



75037, 75042, 75043



75038



75038



75039



75039



75040



75040



75041



75041



75042



75043



75043



75043



75044



75044



75045



75045



75046



75046



75046

75034



75035



75036



75037



75038



75039



75040



75041



75042



75043



LEGO.com/starwars



WIN!

Go to LEGO.com/productfeedback to fill out a survey for a chance to win a cool LEGO® Product.

No purchase necessary.
Open to all residents where not prohibited.



LEGO.com/productfeedback

GEWINNE!

Nimm an der Umfrage auf LEGO.com/productfeedback teil und hab die Chance ein cooles LEGO® Produkt zu gewinnen!

Die Teilnahme am Gewinnspiel führt zu keinerlei Kaufverpflichtungen. Teilnahme in allen nicht ausgeschlossenen Ländern möglich.

 LEGO.com

6073762

WIN!

Ga naar LEGO.com/productfeedback, vul een enquêteformulier in en maak kans op een cool LEGO® product.

Geen aankoopverplichting.
Iedereen mag deelnemen, uitgezonderd ingezetenden van landen waar een enquêteverbod geldt.

GAGNE!

Visite LEGO.com/productfeedback pour répondre à un questionnaire et avoir une chance de gagner un produit LEGO® très cool!

Aucune obligation d'achat.
Ouvert à tous les résidents des pays autorisés.

当てよう!

LEGO.com/productfeedback にアクセスして、アンケートにご記入ください。当選者にはレゴ®製品を差し上げます。

お買い上げの必要はありません。
禁止されていない限り、すべての皆様にご利用いただけます。

LEGO and the LEGO logo are trademarks of the LEGO Group. ©2014 The LEGO Group.
© 2014 Lucasfilm Ltd. & TM. All rights reserved.