



# STAR WARS™

75072



Инструкция Лего (LEGO) 75072

**SERIES 2**

# MICROFIGHTERS

# MICRO VAISSEAUX

# MICRONAVES

2<sup>E</sup> SÉRIE

SERIE 2

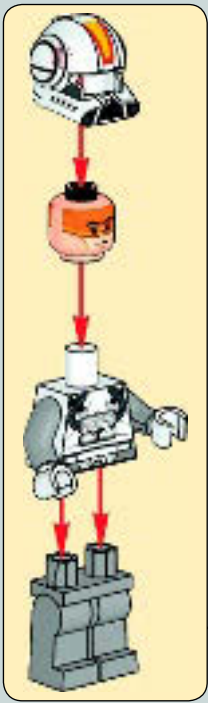

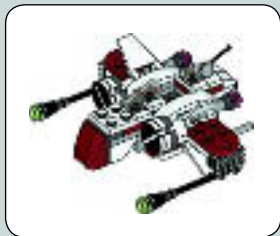

**1**

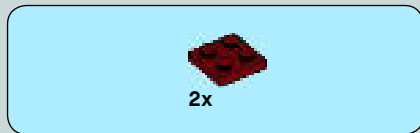
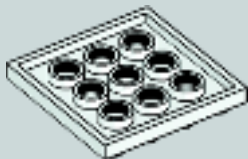

**2**

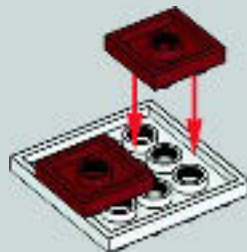

**3**



2x



2x

3

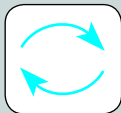

4



1x



2x

4



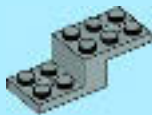

1x

5

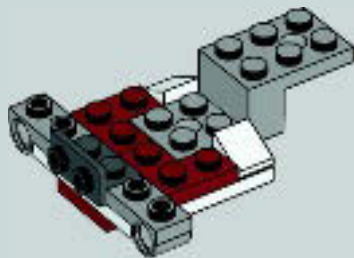



1x

6

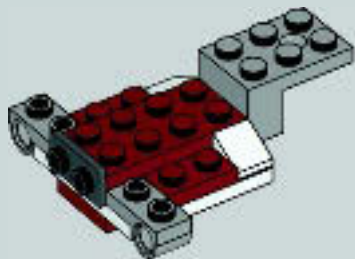



2x



2x

7

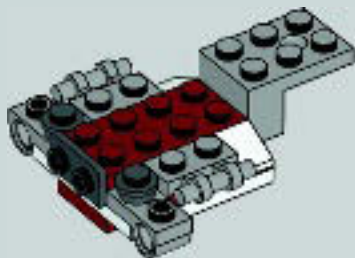



1x



2x

# 8

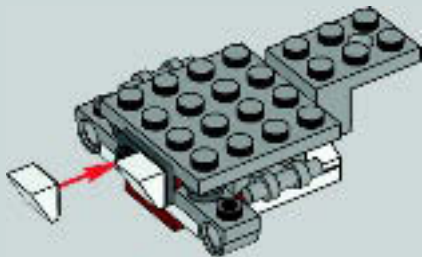





1x



2x



1x

# 9

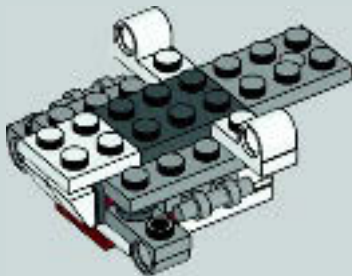



1x



1x



2x

# 10

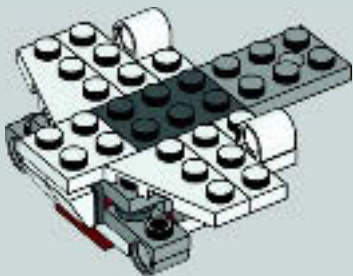

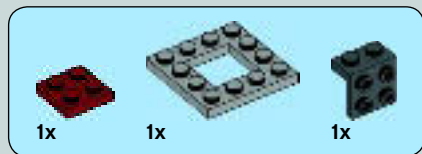

# 11

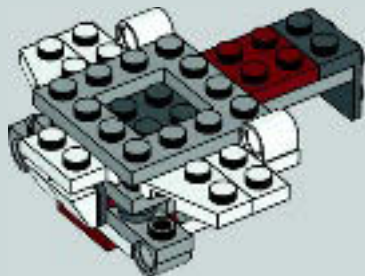



1x

# 12

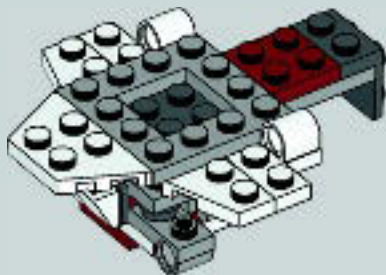



2x

# 13

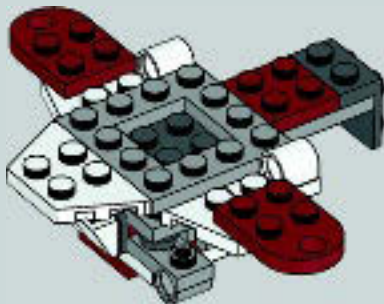



2x



2x



2x



2x

# 14

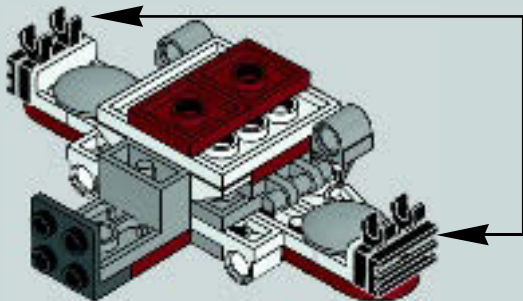
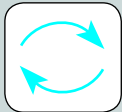

# 1



# 2



# 3

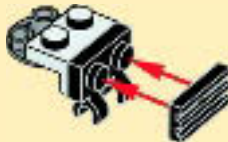

2x



# 15

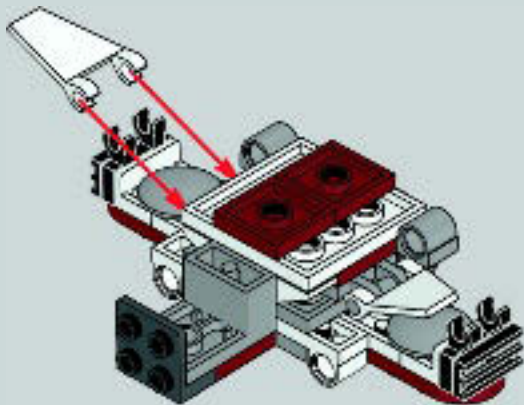



2x



2x

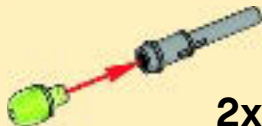

2x



# 16

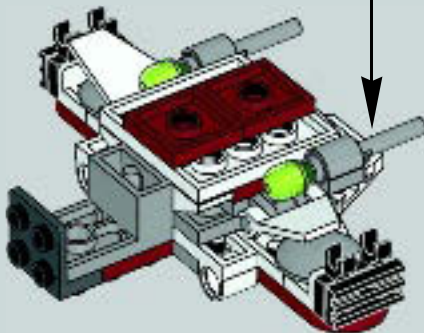





2x

# 17

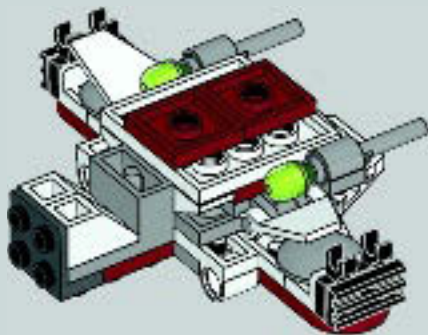



1x



1x

# 18

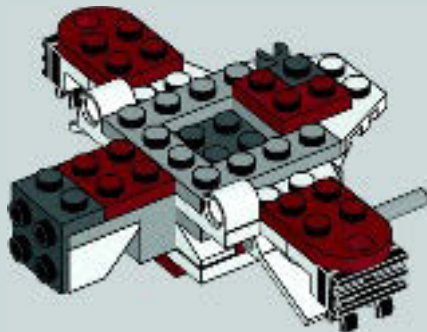
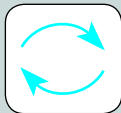



2x



2x

# 19

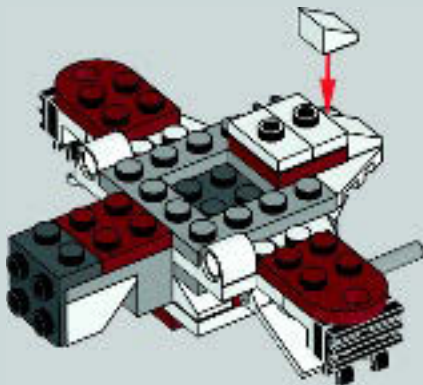



2x



1x

# 20

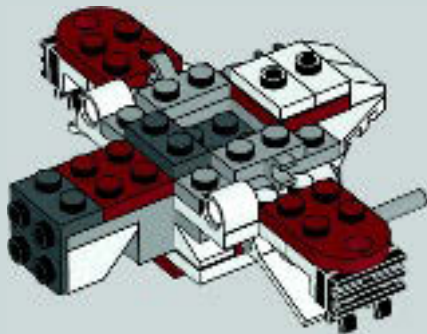



2x

# 21

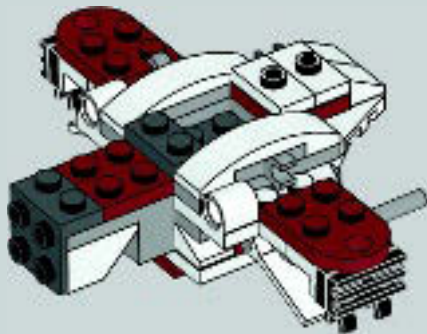



1x



2x

# 22





1x



3x

# 23





2x



1x

# 24

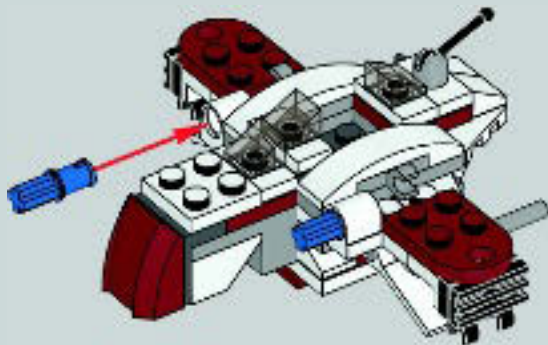





2x



2x



2x

# 25

1



2



2x

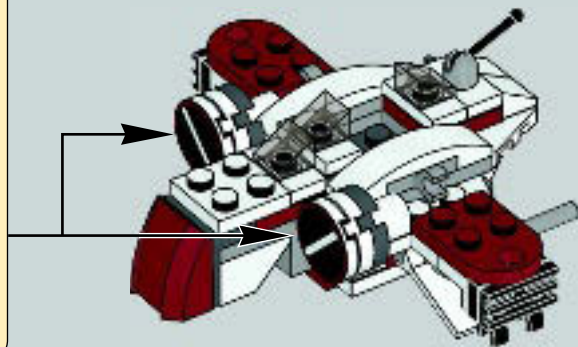



2x



2x



2x



2x

# 26

1

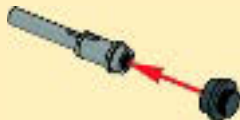

2

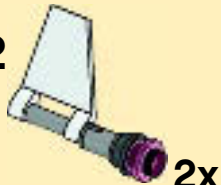

2x

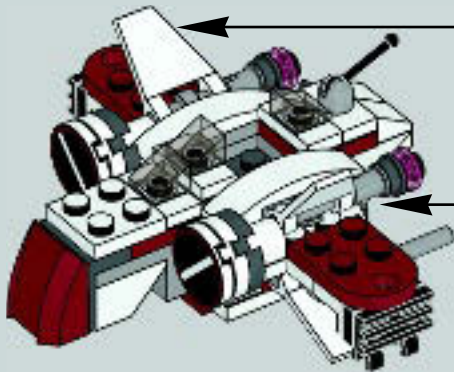



# 27

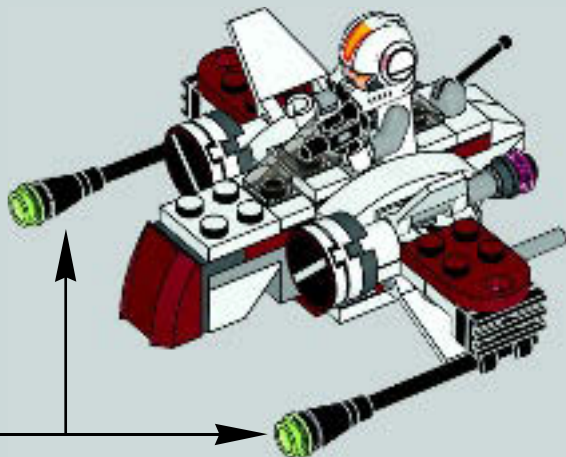

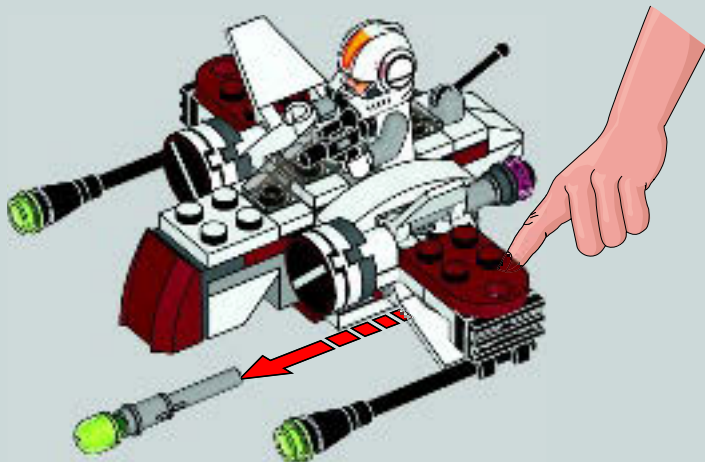

 6x 4504369	 1x 4243812	 4x 6023099	 1x 4609050	 1x 6028811	 1x 4221775	 1x 4587212	 2x 4211042
 2x 366501	 1x 4249506	 1x 6063556	 3x 4244368	 1x 6028811	 1x 4227657	 1x 4211063	 1x 6096721
 2x 6023806	 2x 6018774	 1x 6097106	 2x 4599535	 1x 4612621	 4x 4520320	 1x 6117972	 2x 6057034
 4x 6051511	 1x 4179875	 2x 4206482	 3x 4585751	 1x 4243797	 2x 6089147	 1x 6000606	 2x 4570481
 2x 302201	 1x 4179874	 2x 4529236	 3x 4585479	 2x 6028812	 1x 4211043	 4x 4210633	
 2x 362301	 2x 403201	 2x 241226	 1x 4539071	 2x 4211632			
 2x 6057414	 2x 6096585	 2x 4556158	 2x 4568753	 2x 4278273			
		 2x 6081988	 1x 6039200				



**Customer Service**  
**Kundenservice**  
**Service Consommateurs**  
**Servicio Al Consumidor**  
**LEGO.com/service or dial**



: 00800 5346 5555

: 1-800-422-5346



LEGO

# STAR WARS



## MICROFIGHTERS

Apple, the Apple logo, iPad, iPhone and iPod touch are trademarks of Apple Inc., registered in the U.S. and other countries. App Store is a service mark of Apple Inc.

Apple, le logo Apple, iPad, iPhone et iPod touch sont des marques de commerce d'Apple Inc., déposées aux États-Unis et dans d'autres pays. App Store est une marque de service d'Apple Inc.

Apple, el logotipo de Apple, iPad, iPhone e iPod touch son marcas comerciales de Apple Inc. registradas en EE. UU. y otros países. App Store es una marca de servicio de Apple Inc.

STAR WARS © & ™ 2015 Lucasfilm Ltd.  
© 2015 The LEGO Group. ™ & © WBEI.

Google Play is a trademark of Google Inc.  
Google Play est une marque de commerce de Google Inc.  
Google Play es una marca comercial de Google Inc.

# MICROFIGHTERS



# STAR WARS

Download the Microfighters App!  
Téléchargez l'appli Micro vaisseaux !  
Descarga la app de las Micronaves!



# WIN

GO TO [WWW.LEGO.COM/PRODUCTFEEDBACK](http://WWW.LEGO.COM/PRODUCTFEEDBACK) AND  
GIVE US YOUR SHORT **FEEDBACK** ABOUT THIS  
LEGO® SET FOR A CHANCE TO WIN  
A COOL LEGO PRIZE.



## [LEGO.com/productfeedback](http://LEGO.com/productfeedback)

### GEWINNE



Erzähle uns auf  
[www.LEGO.com/productfeedback](http://www.LEGO.com/productfeedback)

etwas über die Erfahrungen, die  
du mit diesem LEGO® Set gemacht  
hast, und sichere dir die Chance auf  
einen coolen LEGO Preis!

### GAGNE



Rends-toi sur  
[www.LEGO.com/productfeedback](http://www.LEGO.com/productfeedback)

et donne-nous quelques commen-  
taires sur ce produit LEGO® pour  
avoir une chance de gagner un  
prix LEGO !

### GANA



Visita  
[www.LEGO.com/productfeedback](http://www.LEGO.com/productfeedback)

y envíanos tu opinión acerca de este  
set LEGO®. ¡Participarás en el sorteo  
de un premio LEGO!

### 获取奖品



登录  
[www.LEGO.com/productfeedback](http://www.LEGO.com/productfeedback)

给出关于此乐高®套装的简短反馈，  
就有机会获得炫酷乐高奖品

LEGO and the LEGO logo are trademarks of the/son des marques de commerce du/  
son marcas registradas de LEGO Group. ©2015 The LEGO Group.  
© & ™ Lucasfilm Ltd.

6127058