



# CITY

7741



 **WARNING:** CHOKING HAZARD.  
Small parts. Not for children under 3 years.

1

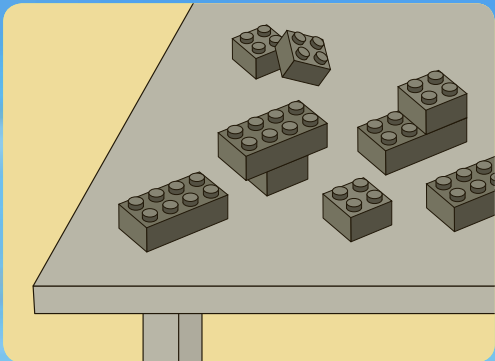
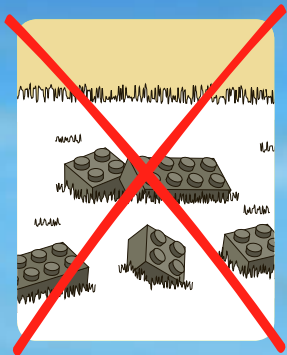

2

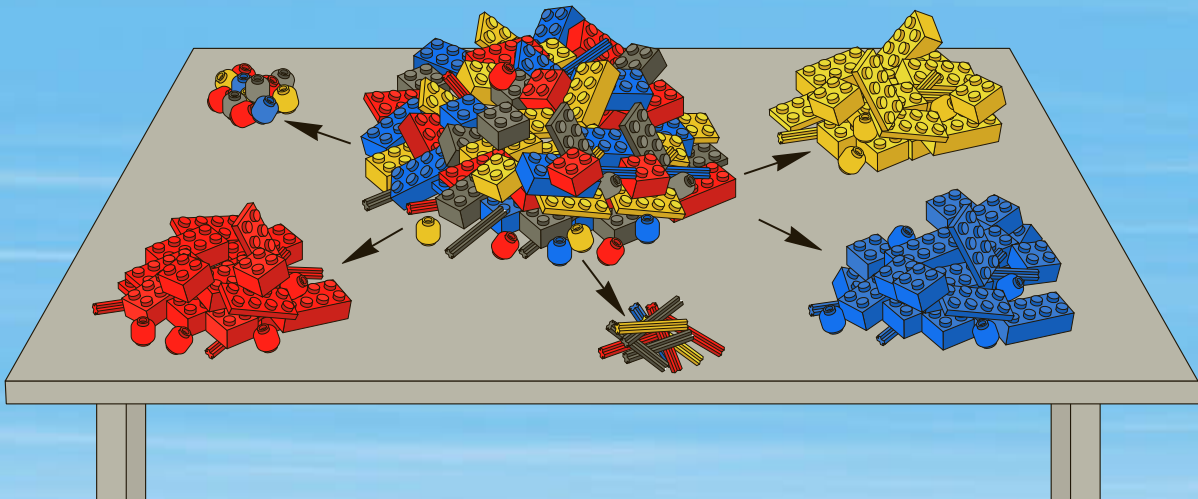

2

# 3



**AVERTISSEMENT : RISQUE D'ÉTOUFFEMENT.**  
Contient des petites pièces. Ne convient pas aux enfants de moins de 3 ans.



**ADVERTENCIA: PELIGRO DE ASFIXIA.**  
No recomendado para niños menores de 3 años. Contiene piezas pequeñas.



1

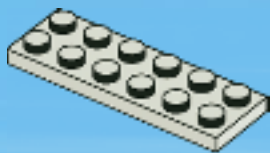

2

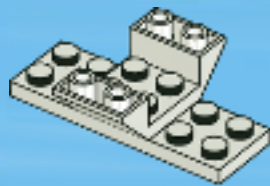

3

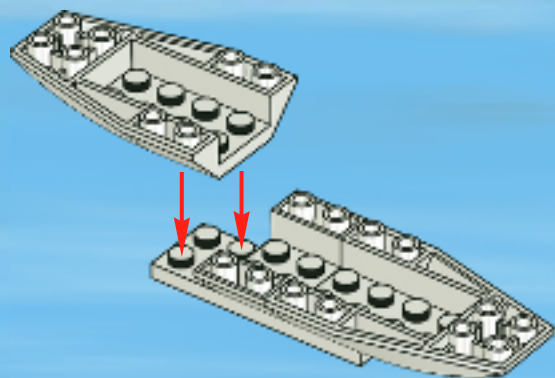

4

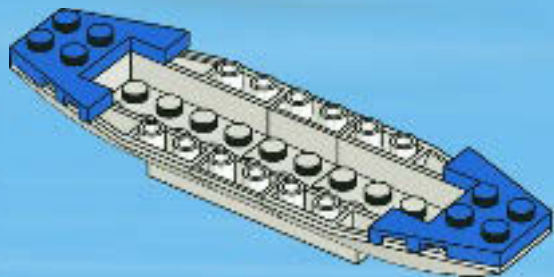

5

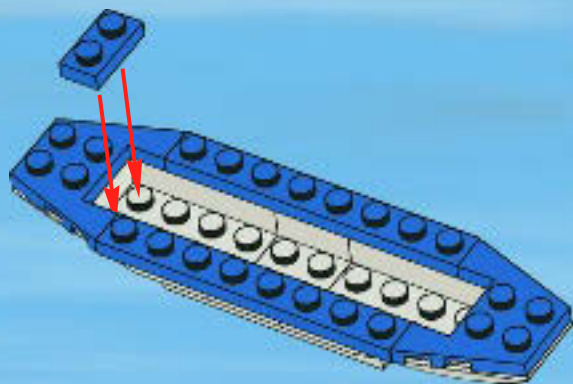

6

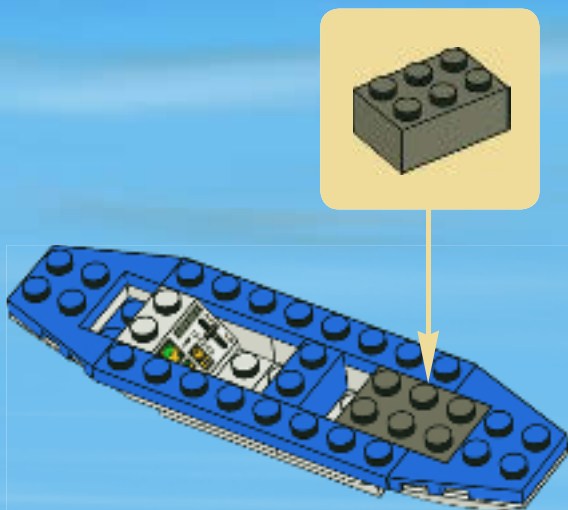



7

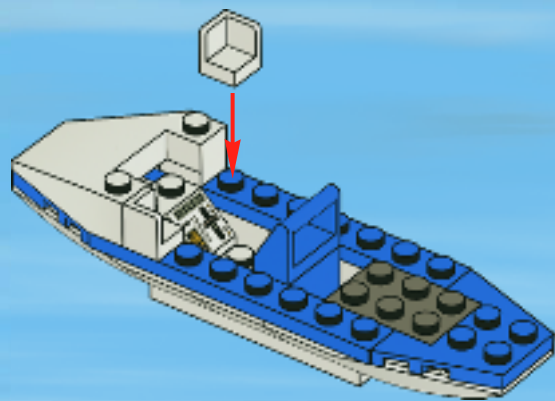

8

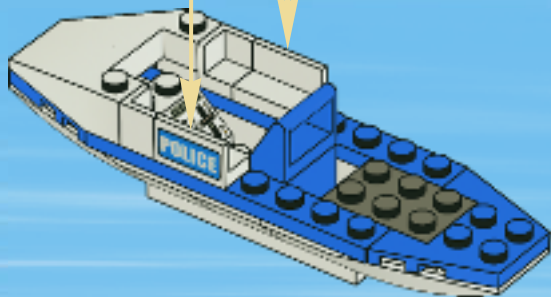
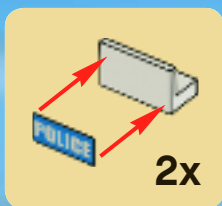

9

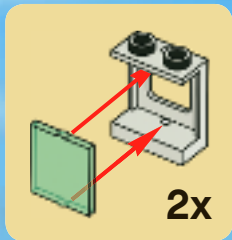
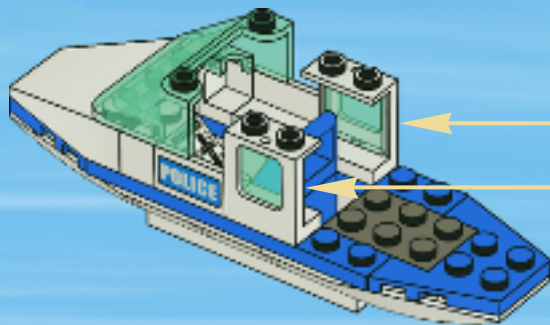

10

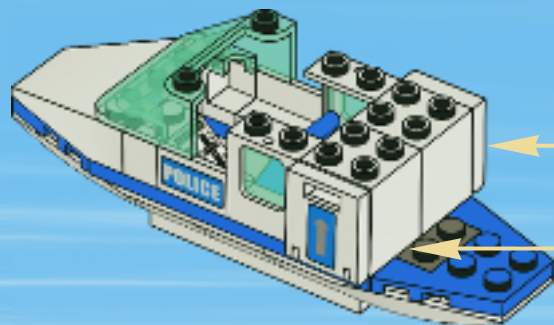
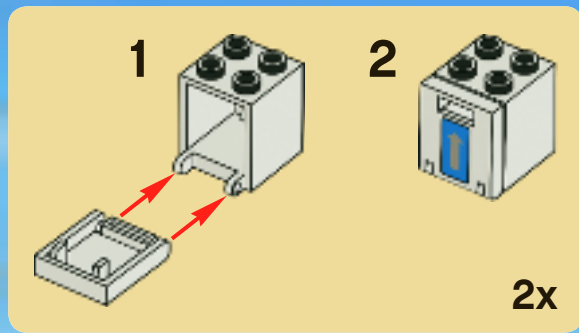

11

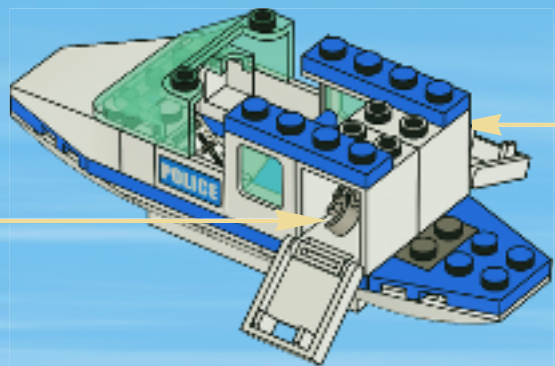

12

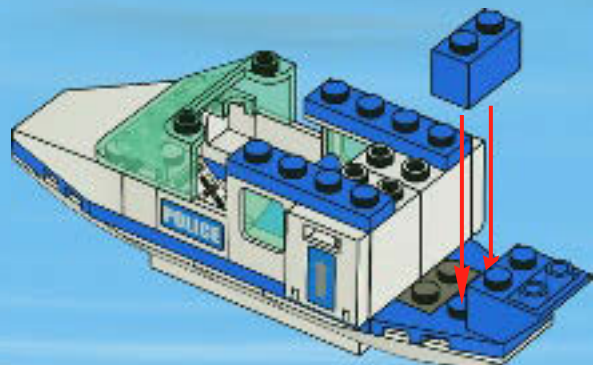



1



2

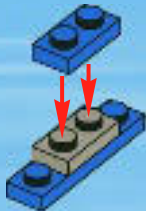

3

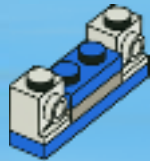

4

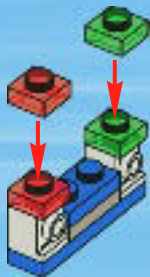

5



13

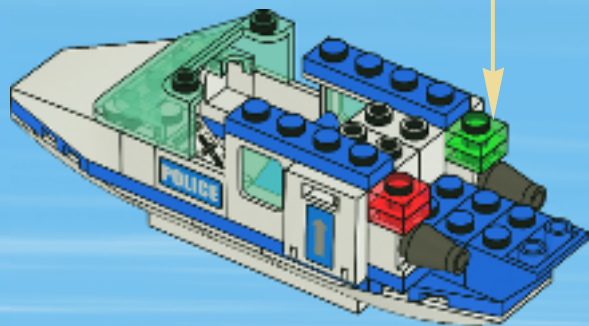



14

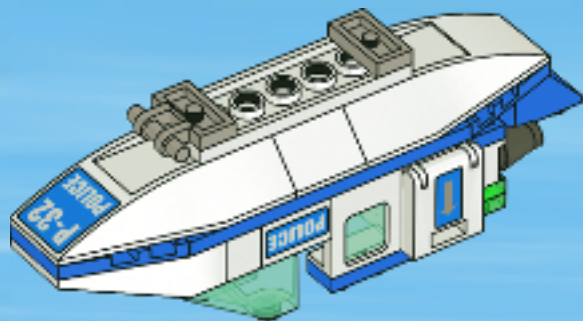

15

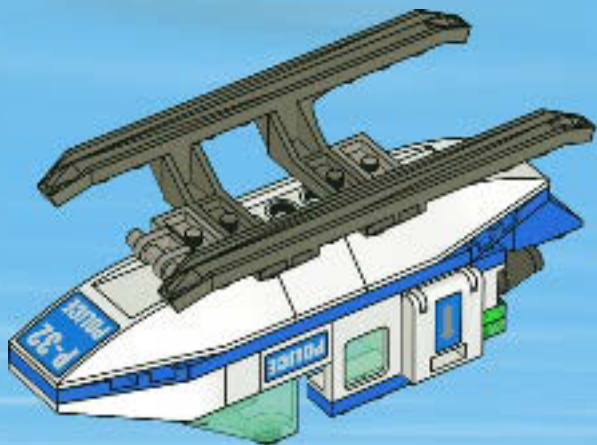

16

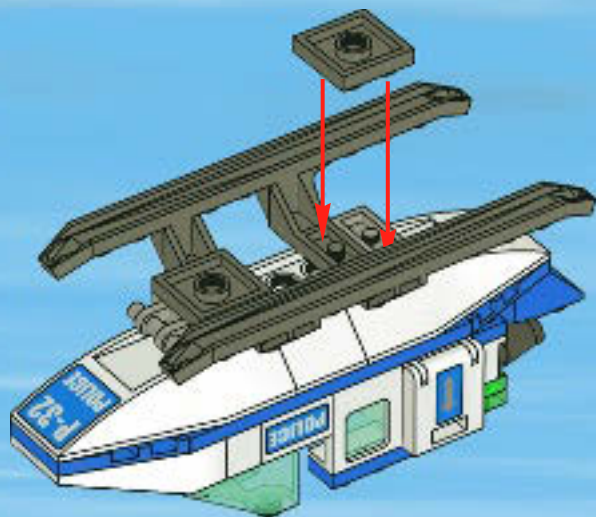

17

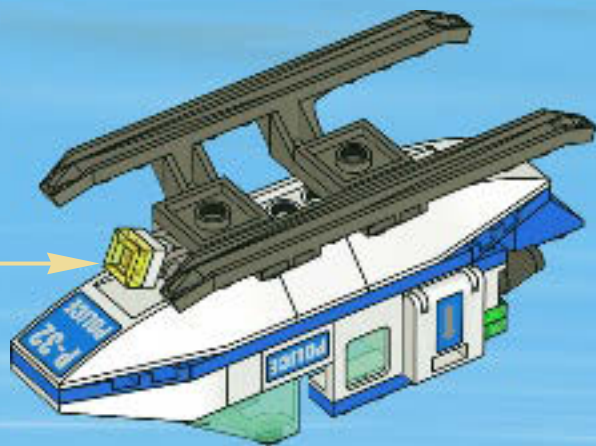
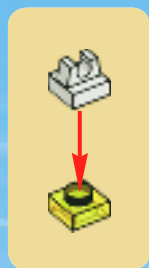



**1**

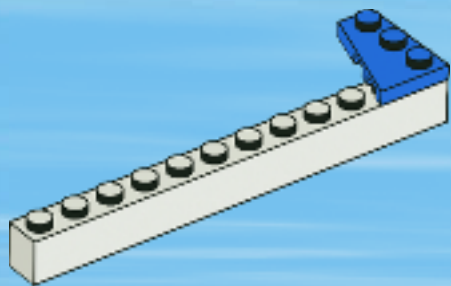

**2**

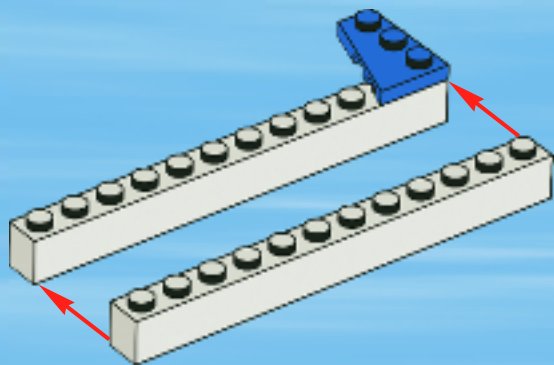

3

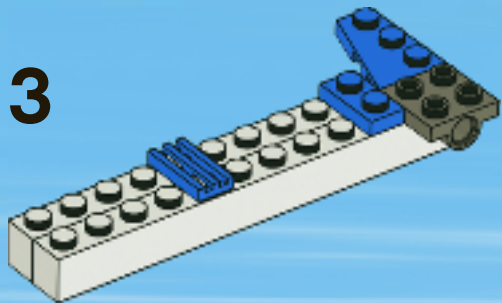

4

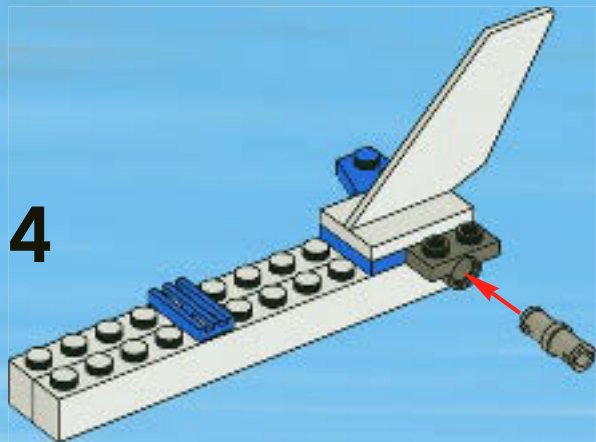

5

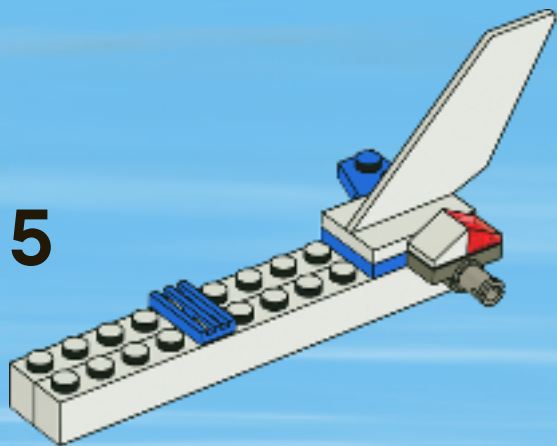

6

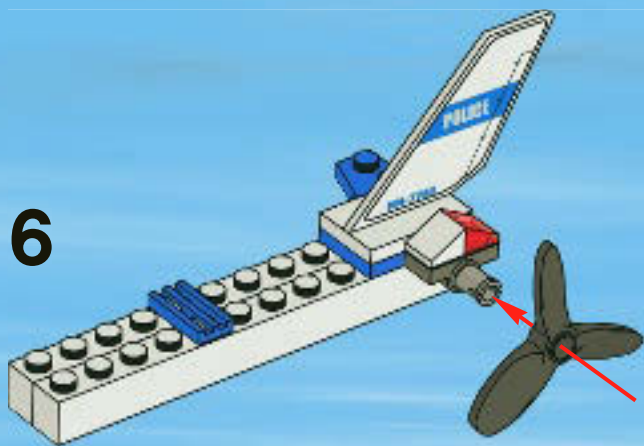

18

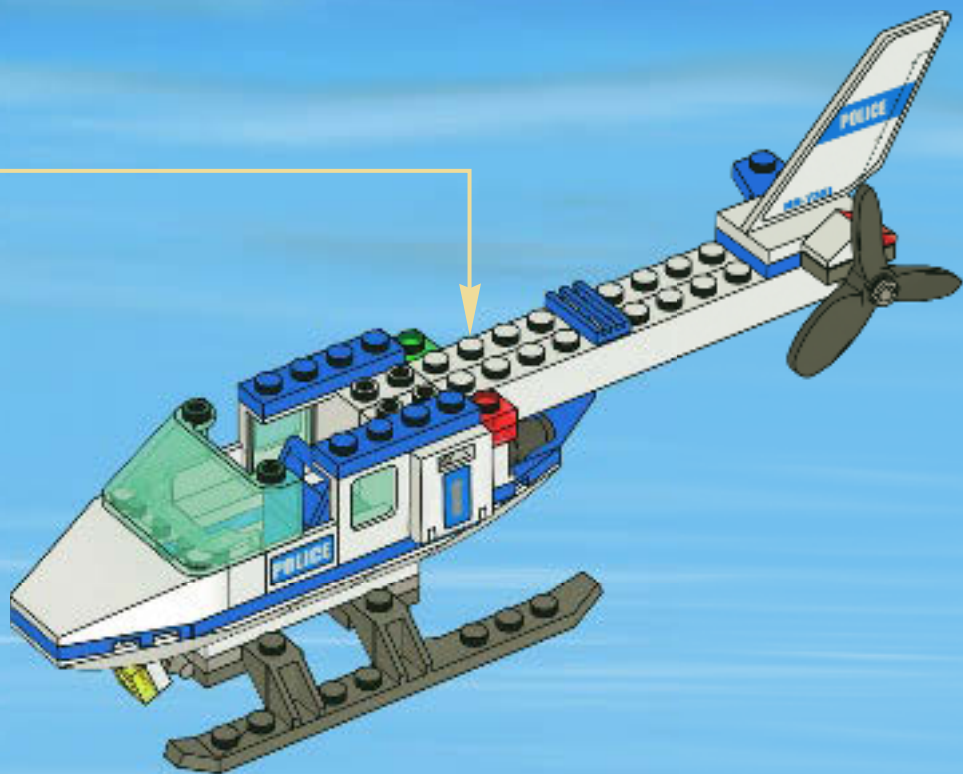



19

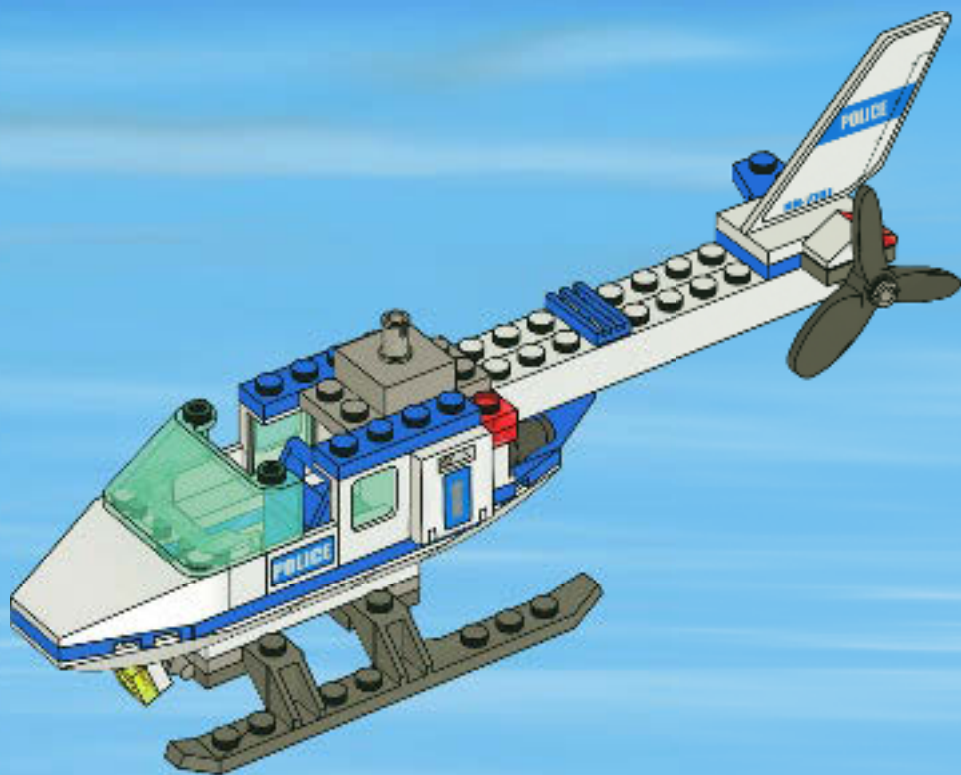

20



1

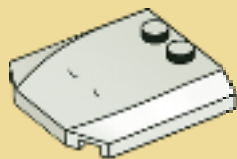

2

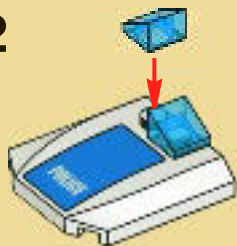

21

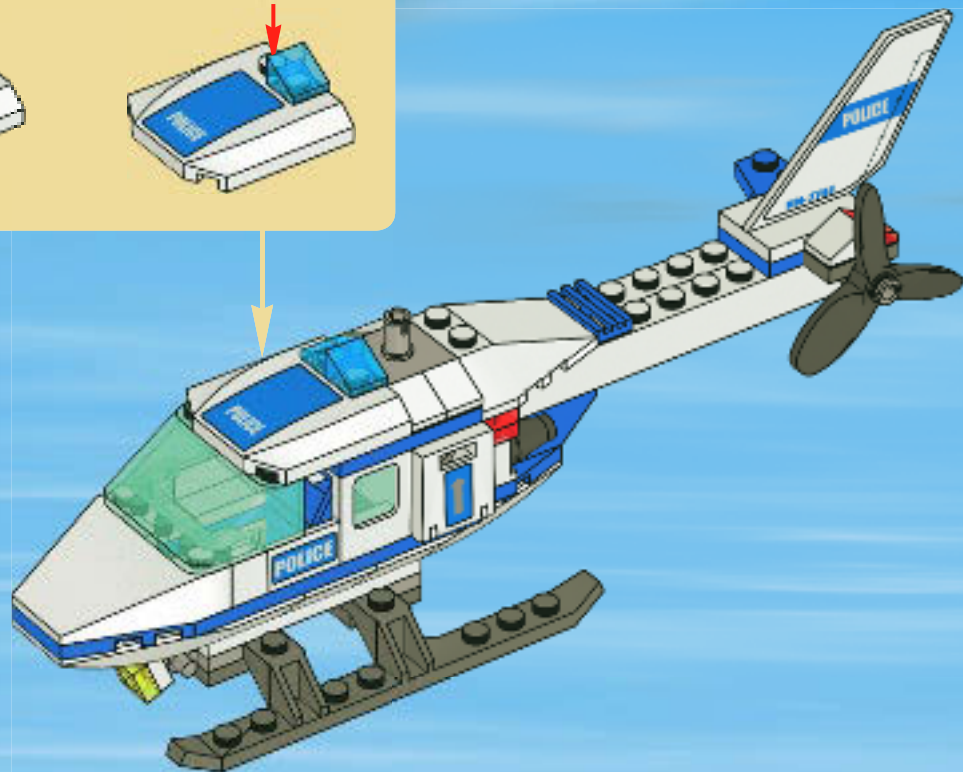

1



2



3

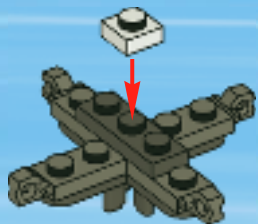

4

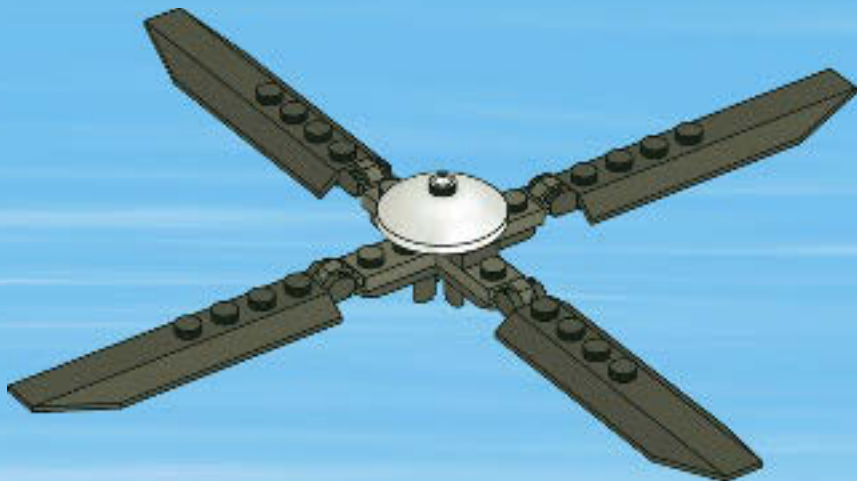

22

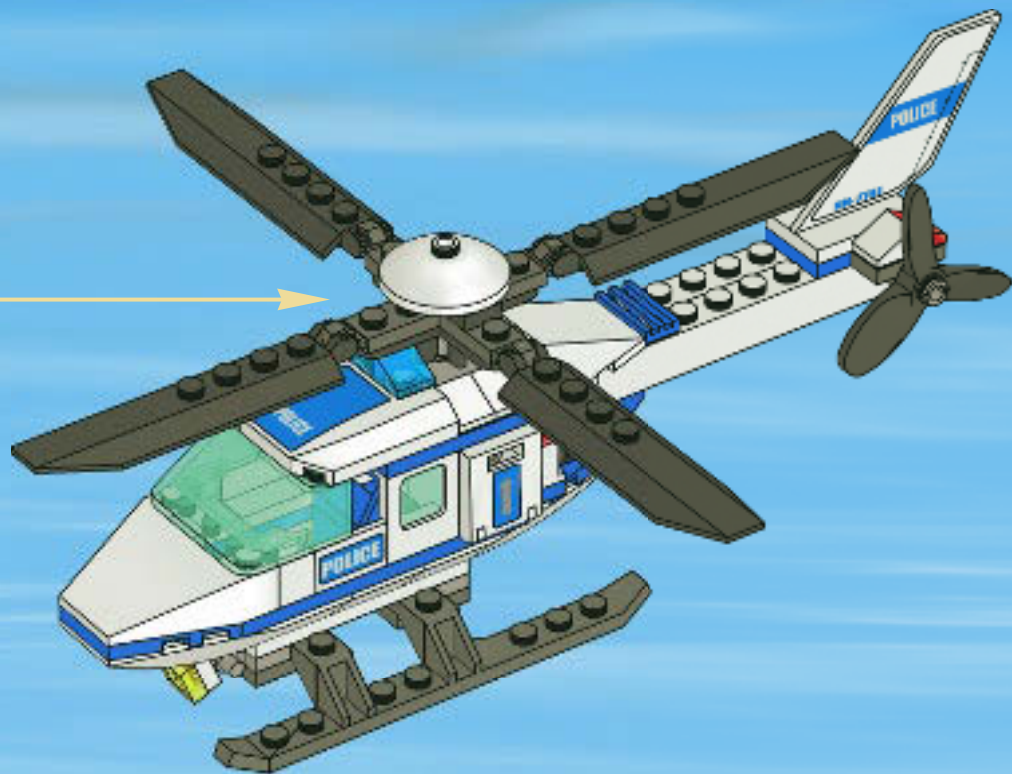

1



2



3

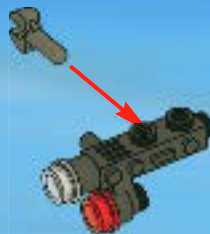

4



23









2x  
407001

1x  
255501

5x  
4504369

1x  
4288083

2x  
434501

2x  
434601

1x  
4298609

1x  
4179580

1x  
302401

2x  
611201

1x  
623901

1x  
4193068

2x  
4261693

1x  
4264026

1x  
4173943

1x  
485801

1x  
379501

2x  
623101

2x  
486501

2x  
4507685

1x  
4163306

2x  
3000841

1x  
4244363

1x  
3005741

1x  
4194017

1x  
3000844

1x  
243223

3x  
302323

3x  
371023

2x  
346023

1x  
4498156

2x  
4240005

1x  
241223

1x  
366023

2x  
300423

2x  
458926

1x  
362326

1x  
436026

1x  
461726

1x  
247926

1x  
4519999

1x  
9339

4x  
4192456

1x  
4255445

1x  
4498374

2x  
4519613

1x  
4211807

1x  
4518282

2x  
4211398

2x  
4211632

1x  
4211666

1x  
4211105

4x  
4210883

2x  
4211094

1x  
4211051

1x  
4289542

1x  
4196768

2x  
4244366

2x  
4217436

1x  
3005740



# CITY



34

7279



7285



7286



7287



7288



7498

**LEGO**

**CITY**



3177



3178



3179



3180



3181



3182



# CITY



7942



7239



7207



7208



# CITY

## EXPLORE LOTS OF MOVIES, GAMES AND FUN DOWNLOADS

- Vede filme și alege între Filme, Game și Downloads
- Descoperă de noi filme, jocuri și descărcări amuzante
- Găsește informații cu privire la filme, jocuri și descărcări
- Alege să vezi filme, să joci jocuri și să descarci
- Pentru mai multe informații, accesează adresa: [www.lego.com](http://www.lego.com)



[www.LEGO.com](http://www.LEGO.com)



**LEGO** club™

**FREE! GRATIS! GRATUIT!**

**SIGN UP ONLINE!**

**www.LEGOclub.com**



**00800 5346 5555\***



**1-866-534-6258 • 1-877-518-5346**

US & Canada only

Outside only

- \* Freephone. Mobile charges may apply.
- \* Numéro sans frais. Des frais peuvent s'appliquer avec les téléphones cellulaires.
- \* Gebührenfrei, Kosten für Anrufe aus Mobilfunknetzen können abweichen.
- \* Gratis telefonnummer vanaf vaste lijn.
- \* Det er et gratis nummer, når du ringer fra fasttelefon.
- \* Det är gratis, när du ringer från en fast telefon.
- \* Numéro sans frais. Des frais peuvent s'appliquer avec les téléphones portables.



# WIN!

Go to [www.LEGOsurvey.com/product](http://www.LEGOsurvey.com/product) to fill out a survey for a chance to win a cool LEGO® Product.

No purchase necessary.

Open to all residents where not prohibited.

## [www.LEGOsurvey.com/product](http://www.LEGOsurvey.com/product)

### GEWINNE!

Nimm an der Umfrage auf [www.LEGOsurvey.com/product](http://www.LEGOsurvey.com/product) teil und hab die Chance ein cooles LEGO® Produkt zu gewinnen!

Die Teilnahme am Gewinnspiel führt zu keinerlei Kaufverpflichtungen. Teilnahme in allen nicht ausgeschlossenen Ländern möglich.

4639191

### WIN!

Ga naar [www.LEGOsurvey.com/product](http://www.LEGOsurvey.com/product), vul een enquêteformulier in en maak kans op een cool LEGO® product.

Geen aankoopverplichting. Iedereen mag deelnemen, uitgezonderd ingezetenden van landen waar een enquêteverbod geldt.

### GAGNE!

Visite [www.LEGOsurvey.com/product](http://www.LEGOsurvey.com/product) pour répondre à un questionnaire et avoir une chance de gagner un produit LEGO® très cool!

Aucune obligation d'achat. Ouvert à tous les résidents des pays autorisés.

LEGO and the LEGO logo are trademarks of the LEGO Group. ©2011 The LEGO Group.

### 当てよう!

[www.LEGOsurvey.com/product](http://www.LEGOsurvey.com/product) にアクセスして、アンケートにご記入ください。当選者にはレゴ®製品を差し上げます。

お買い上げの必要はありません。禁止されていない限り、すべての皆様にご利用いただけます。