



# STAR WARS™

7929



**WARNING:** CHOKING HAZARD.  
Toy contains small parts and a small ball.  
Not for children under 3 years.

1

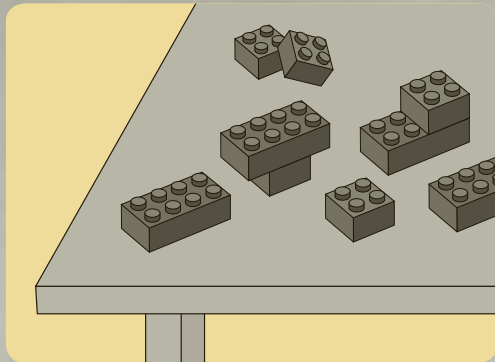
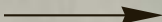
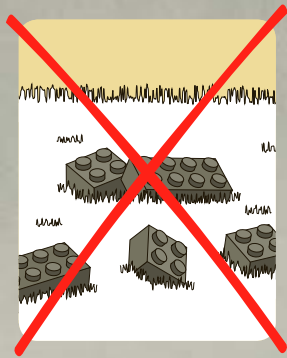

2

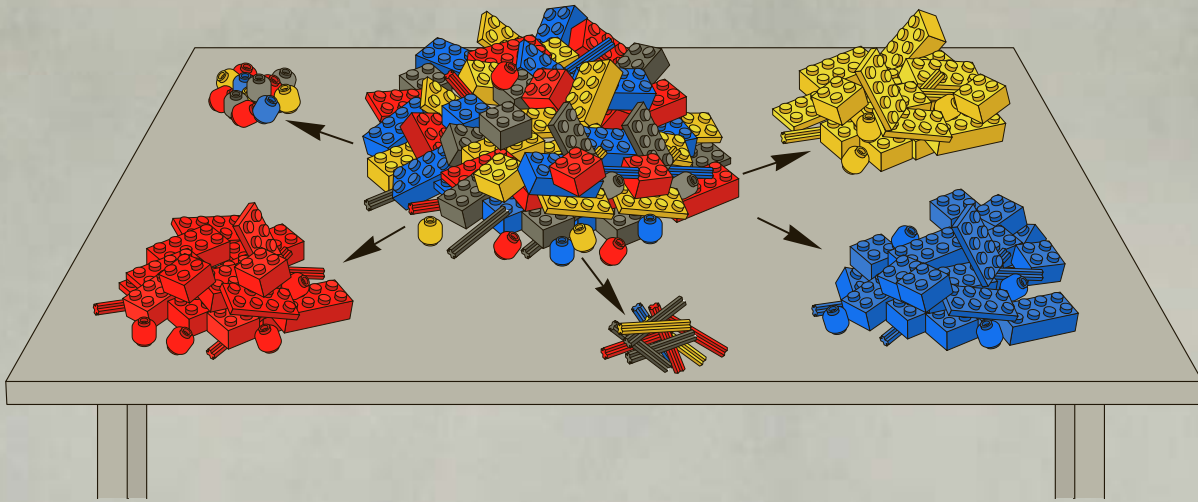

# 3

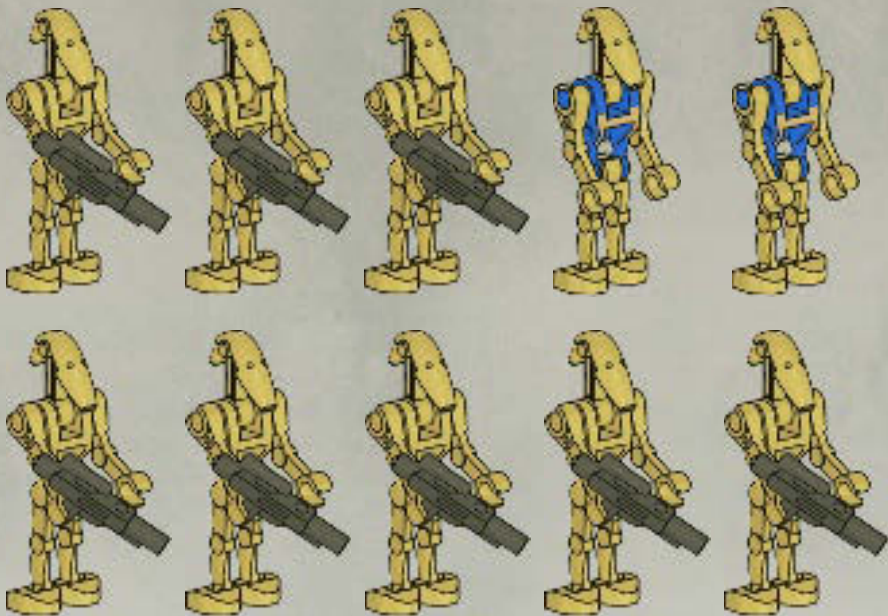
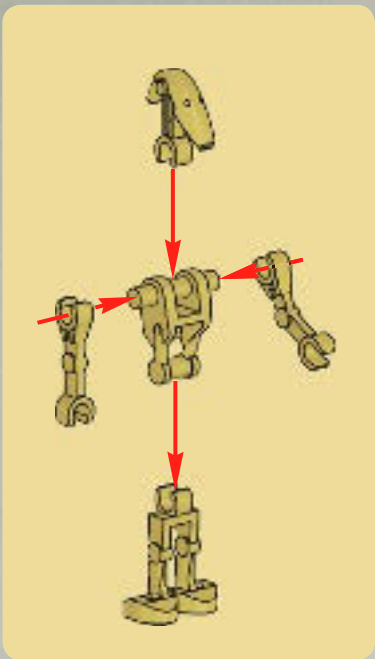

**AVERTISSEMENT : RISQUE D'ÉTOUFFEMENT.**  
Le jouet contient des petites pièces ainsi qu'une petite boule.  
Il ne convient pas aux enfants de moins de 3 ans.



**ADVERTENCIA: PELIGRO DE ASFIXIA.**  
Juguete que contiene partes pequeñas y una pelota pequeña.  
No recomendado para niños menores de 3 años.

4

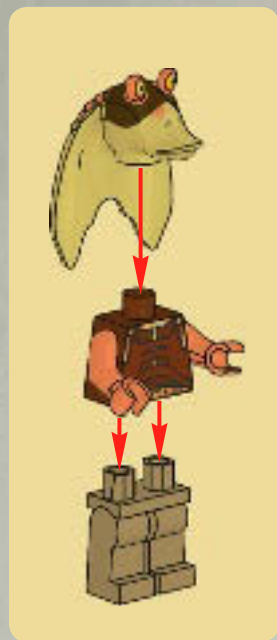



1x

1



2x

2

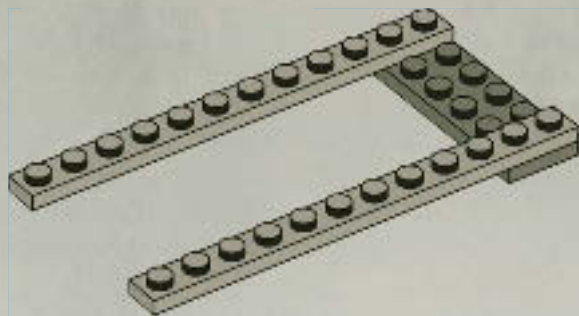



1x

3

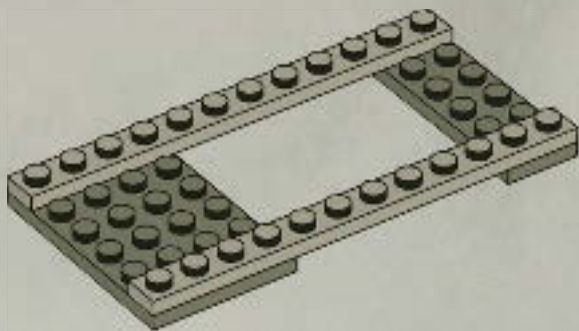

6



2x

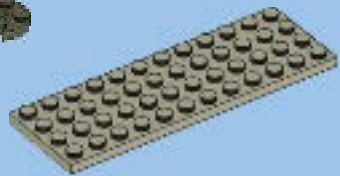

1x

4

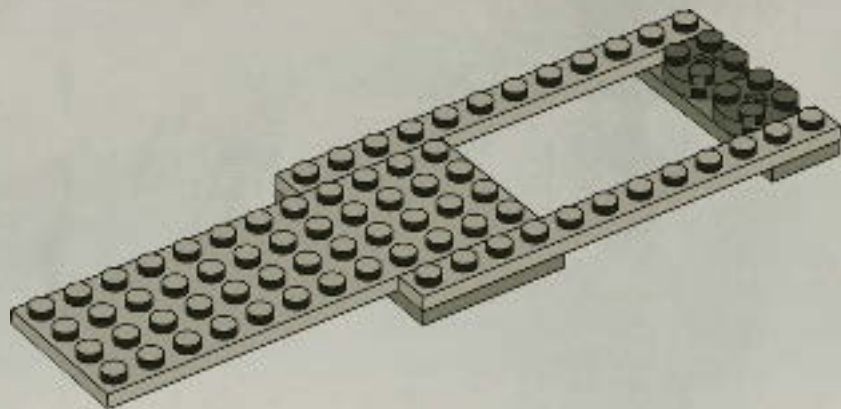



5

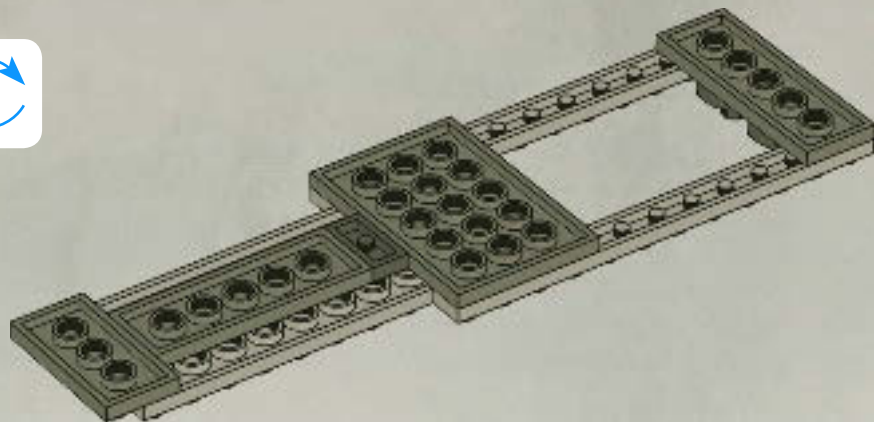



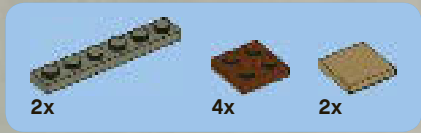

6

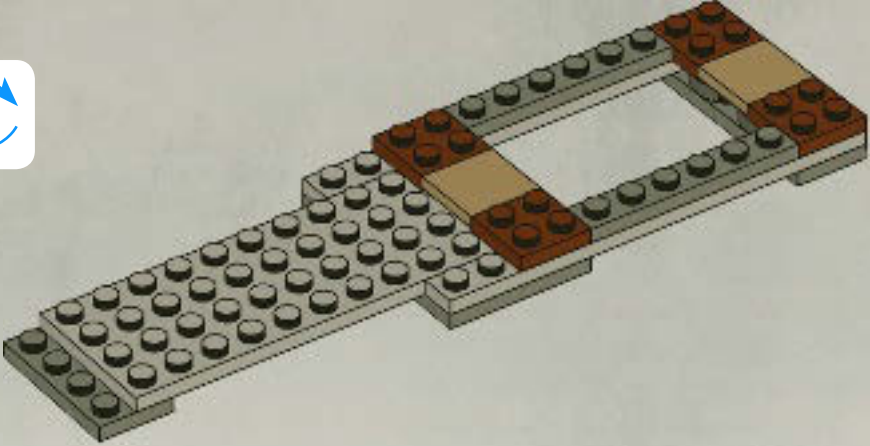

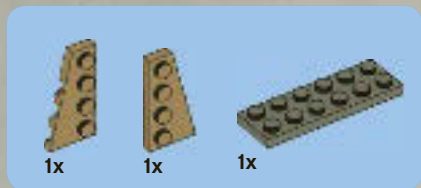

7

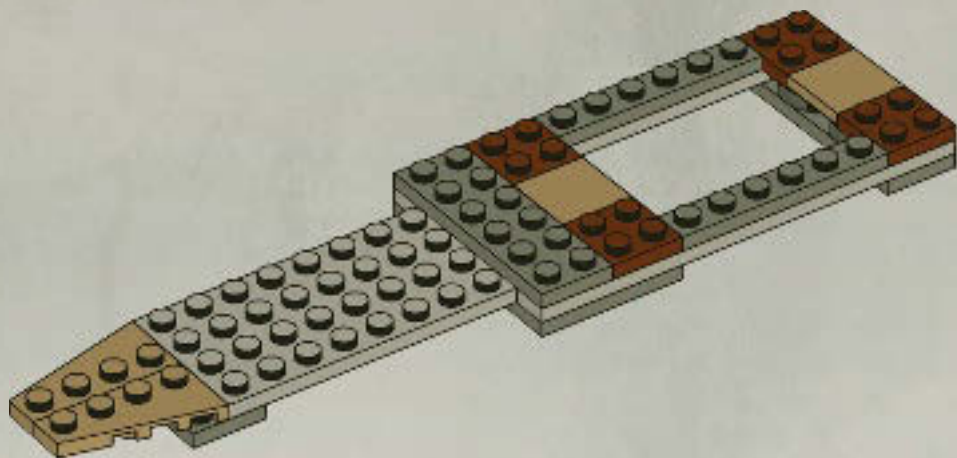

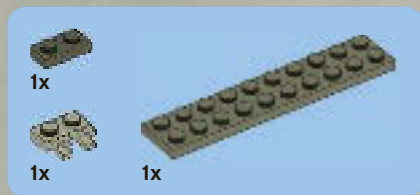

8

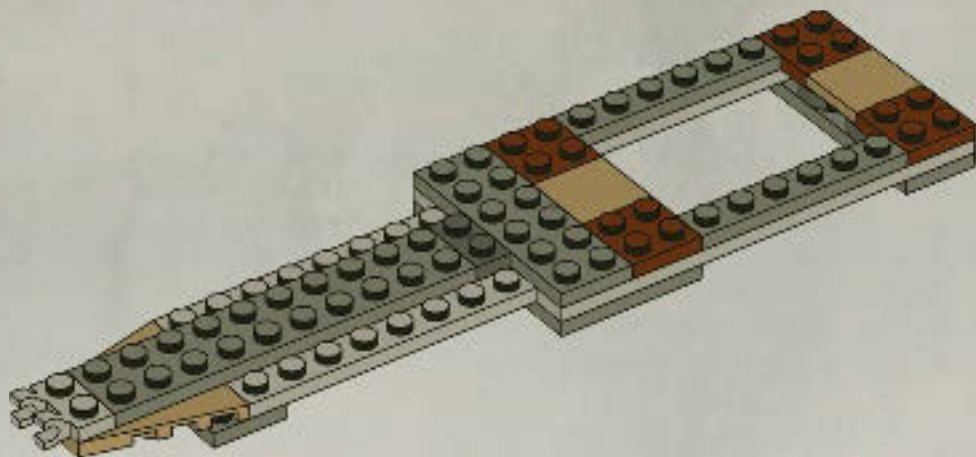



2x



1x

9

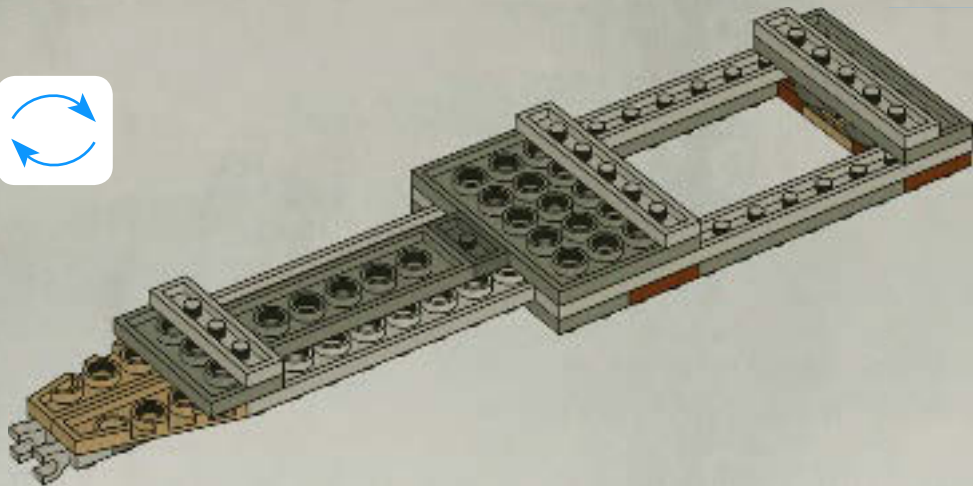



6x

10

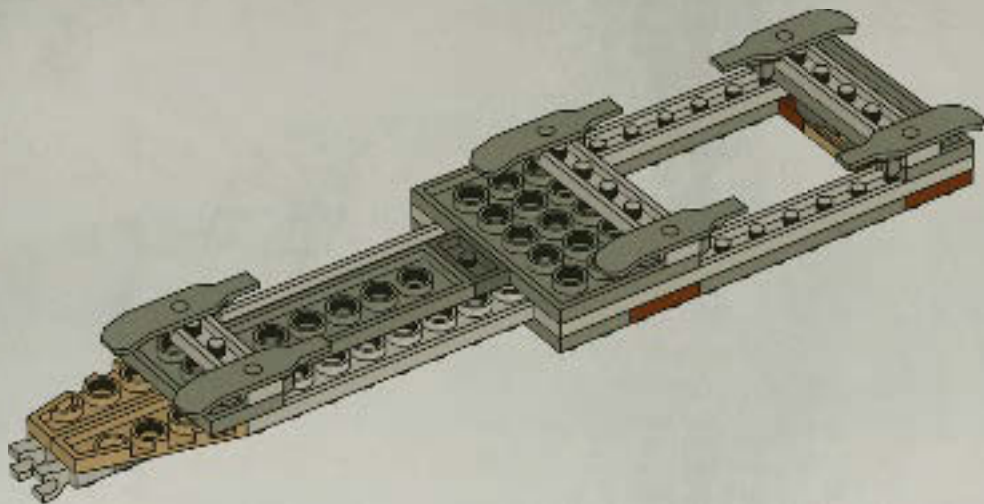



2x



1x



1x



2x

# 11

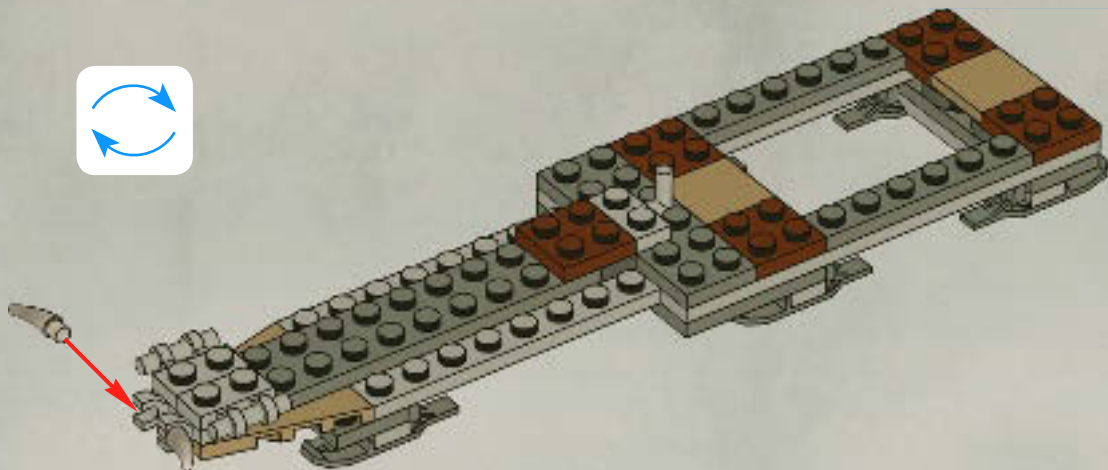



2x



4x



2x



2x

# 12

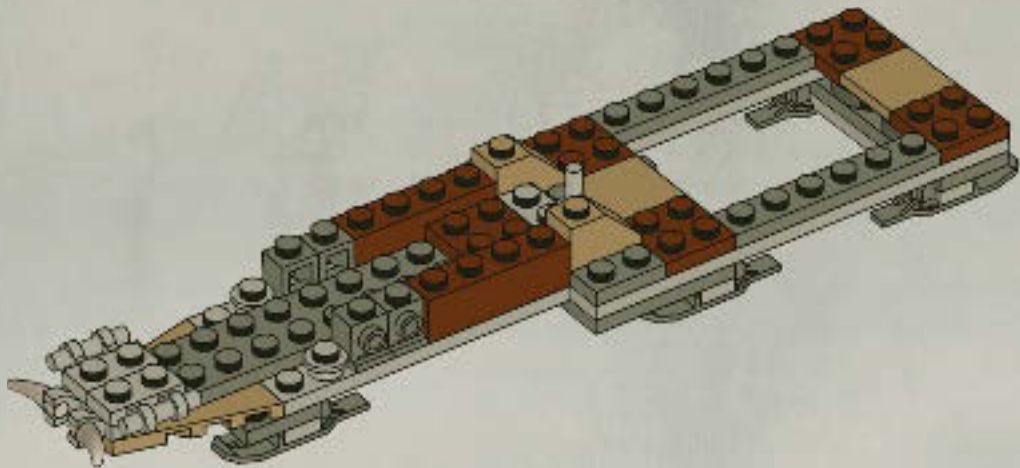



2x



1x

# 13

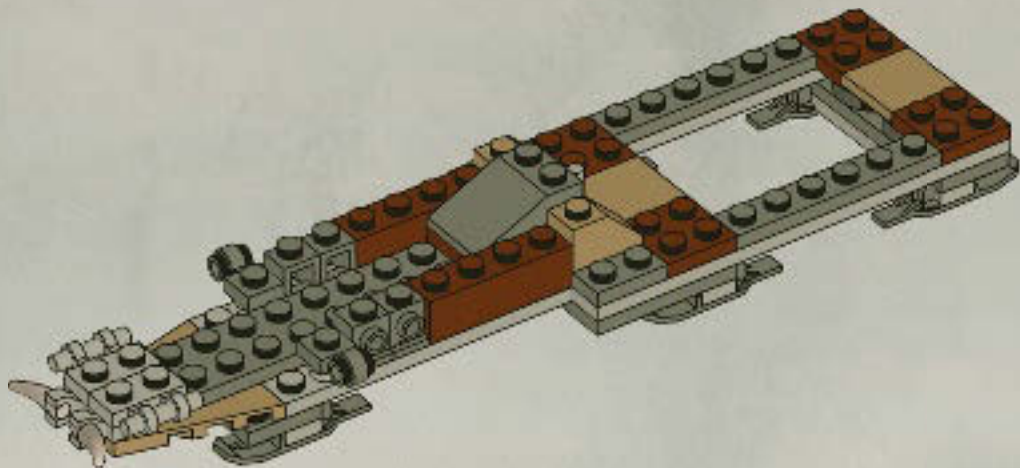





4x



1x



2x

# 14

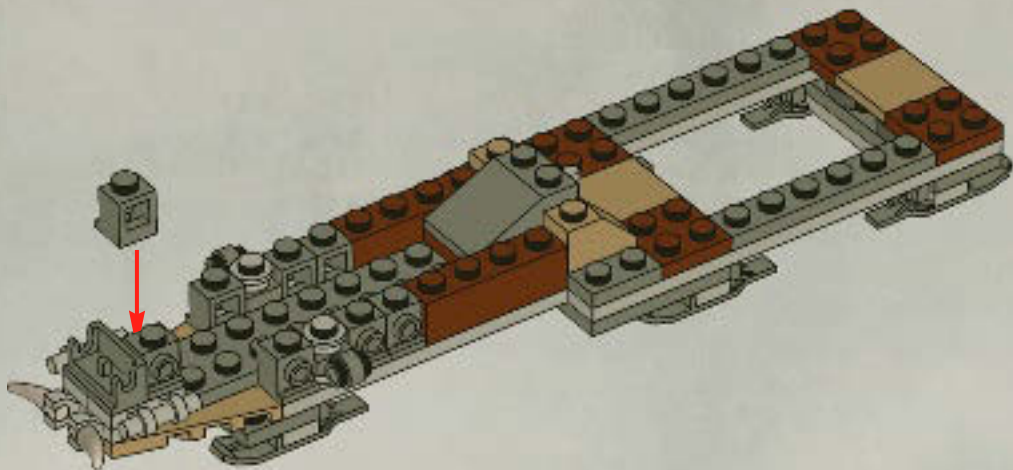



4x

15

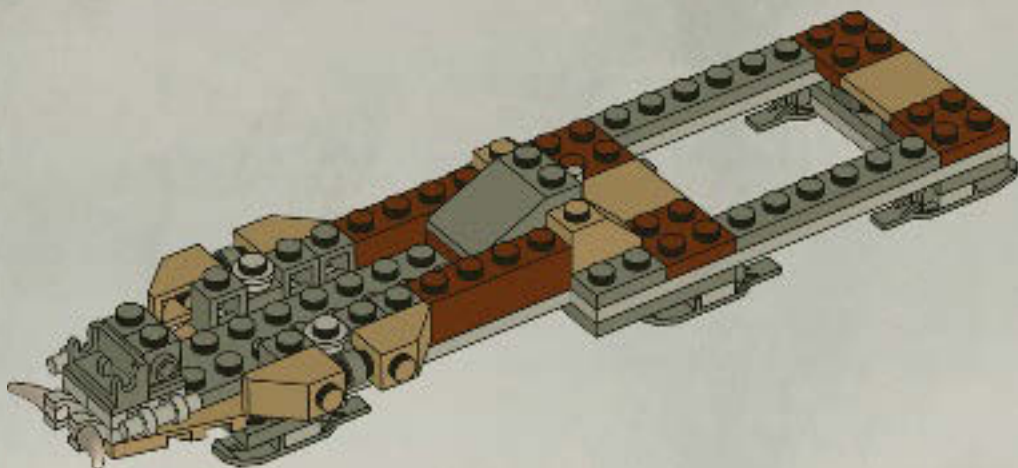



2x



1x

# 16

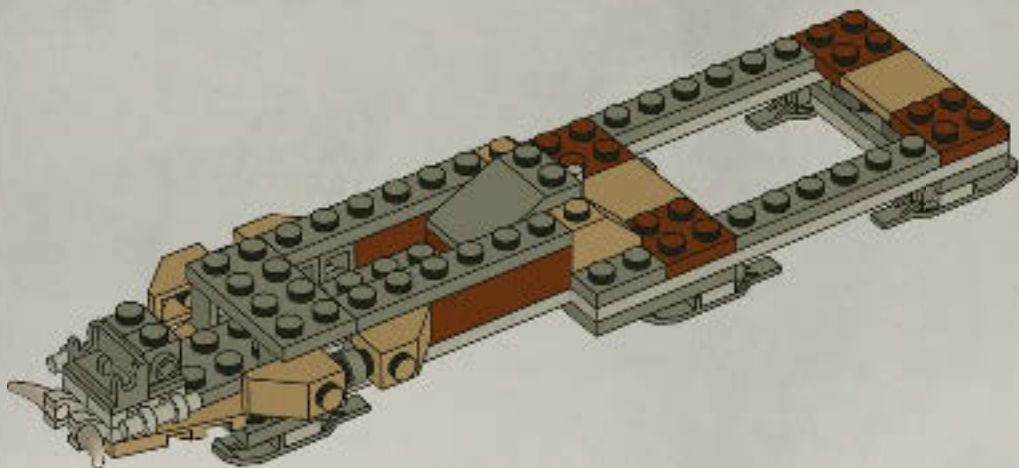



1x



1x

# 17

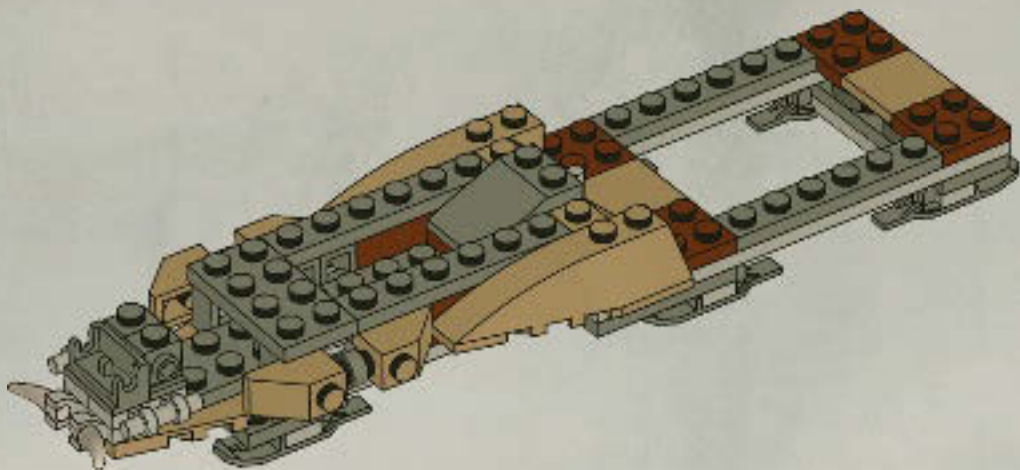



4x



6x

# 18

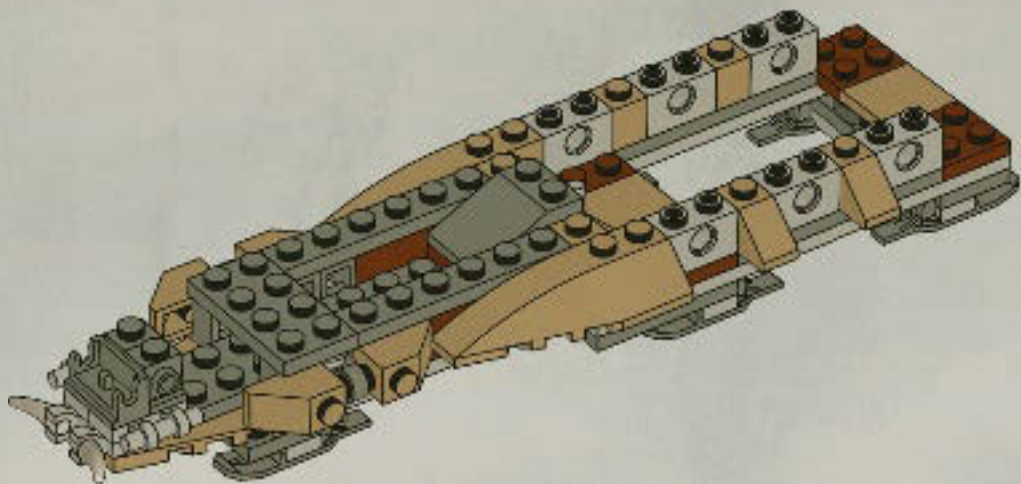



1x



1x

# 19

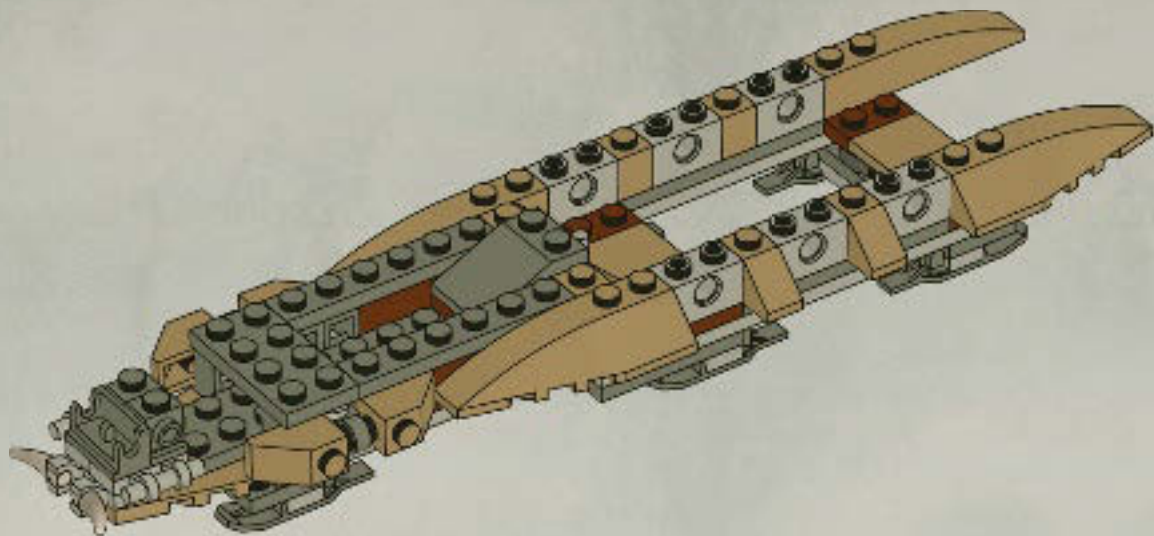



2x



2x



2x

# 20

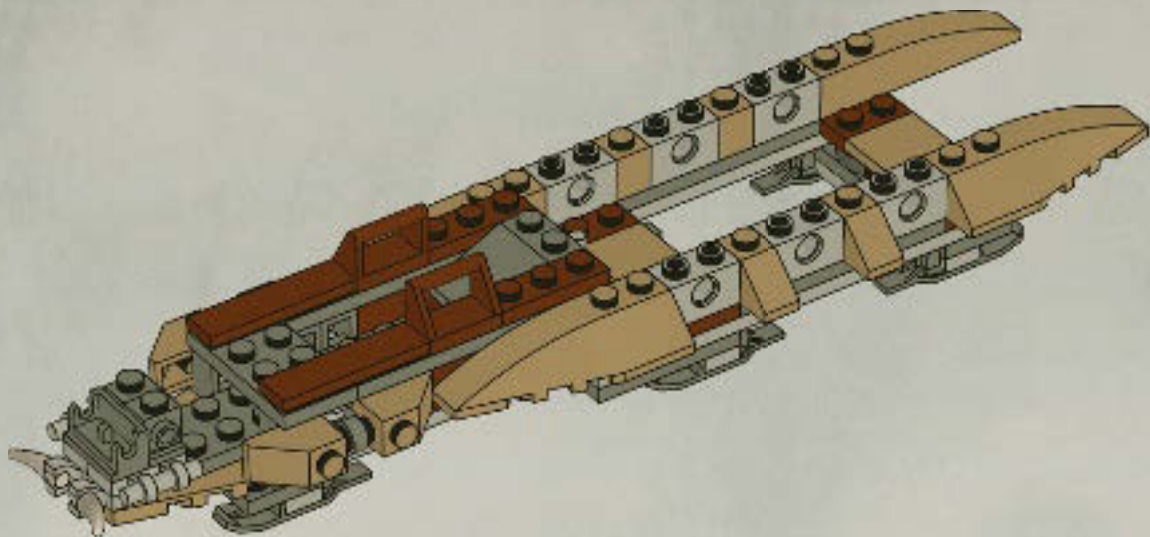



21

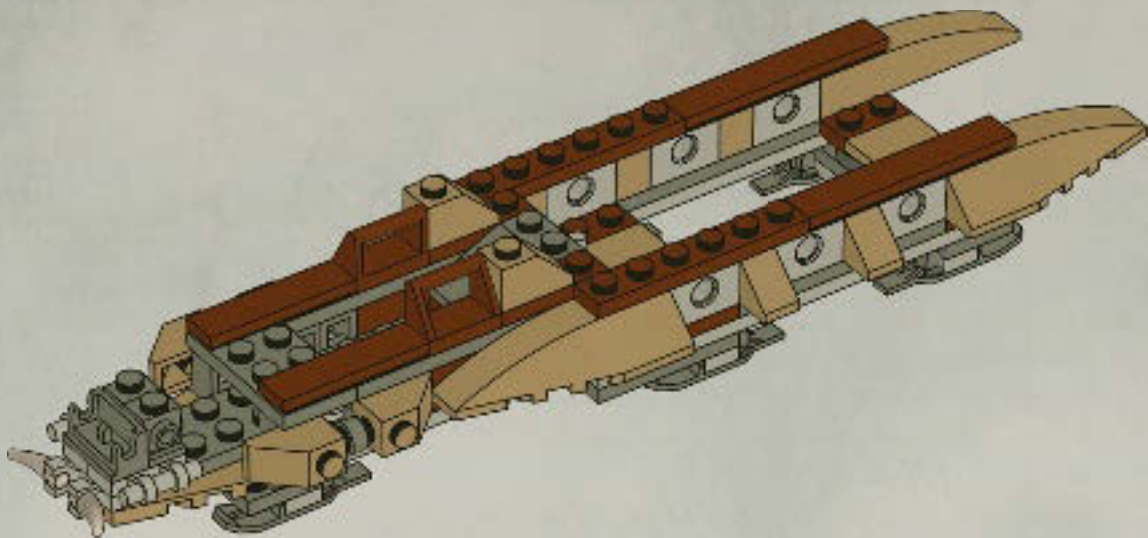





22

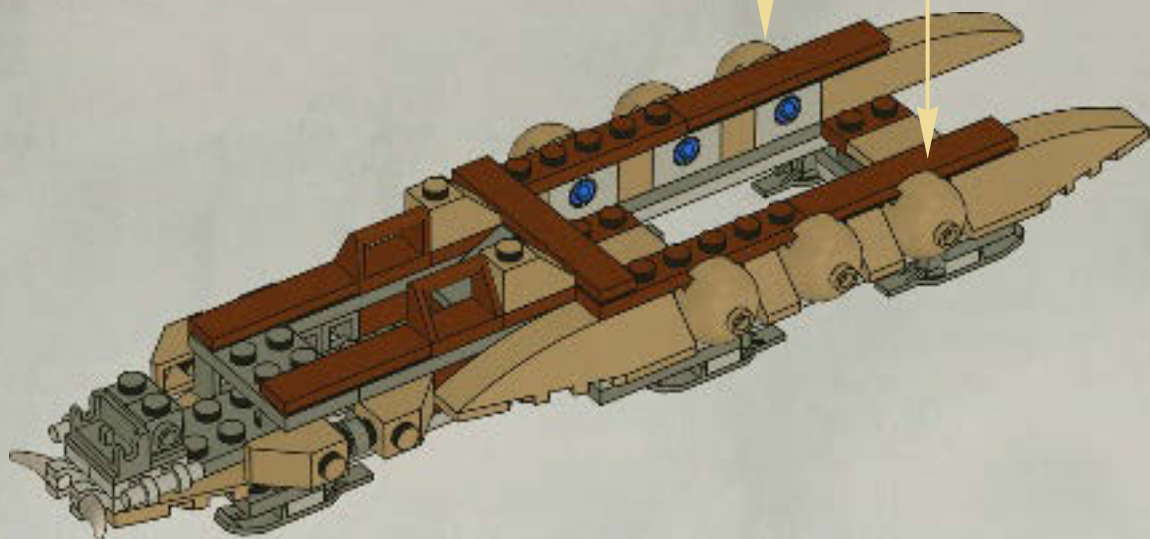
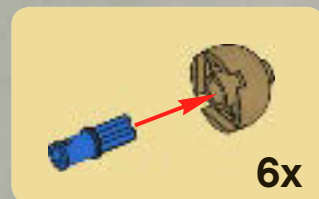



1x



2x



2x

# 23

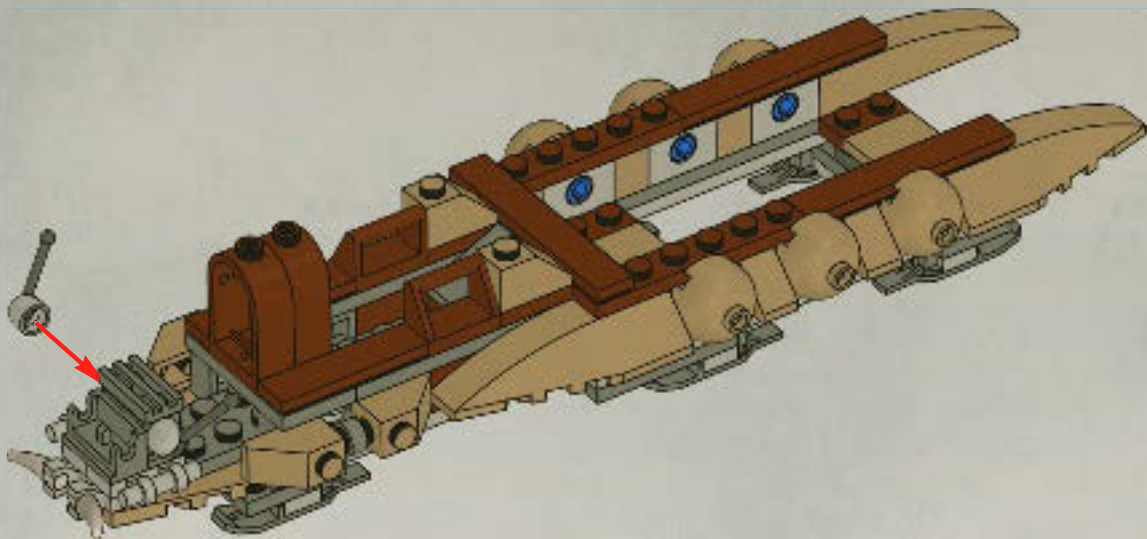



1x



1x



1x



1x

**1**



**2**



**3**



23

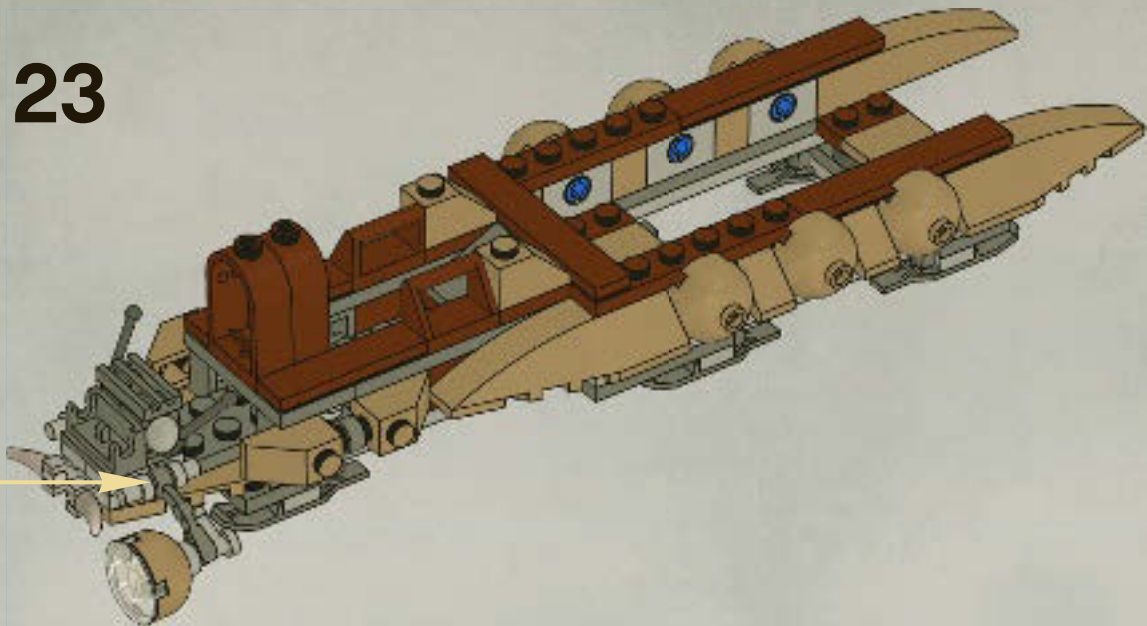

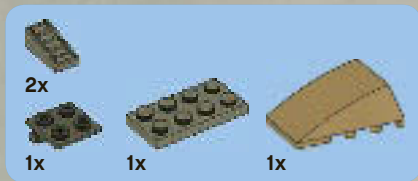

# 24

1



2



3

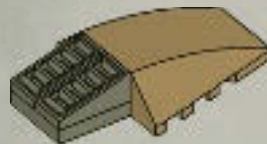

4



5

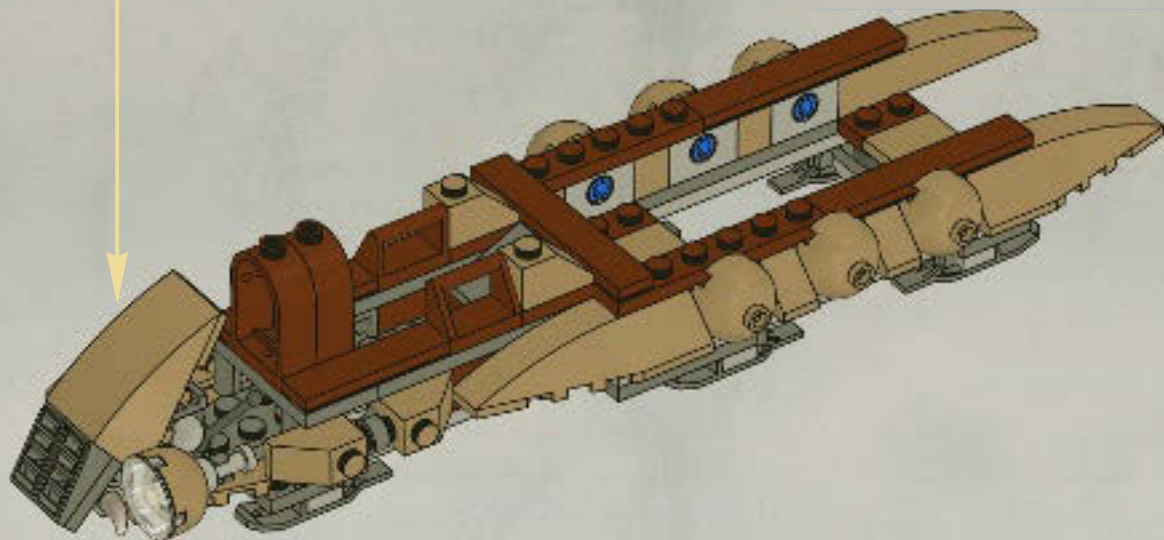
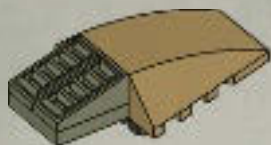



1x

1



2x

2

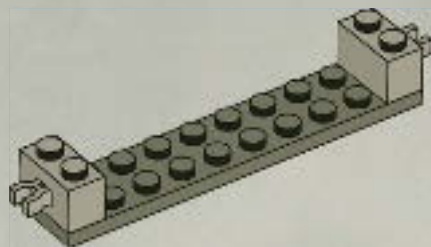



4x

3

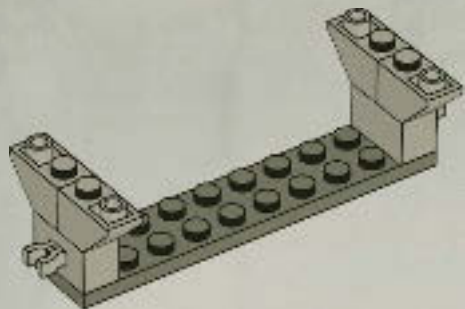

2x

4

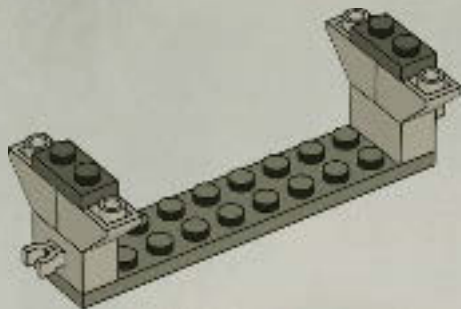





2x

5

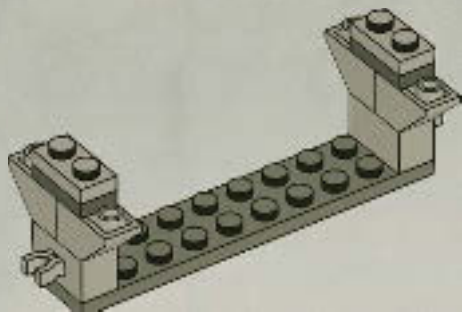

2x



4x

6

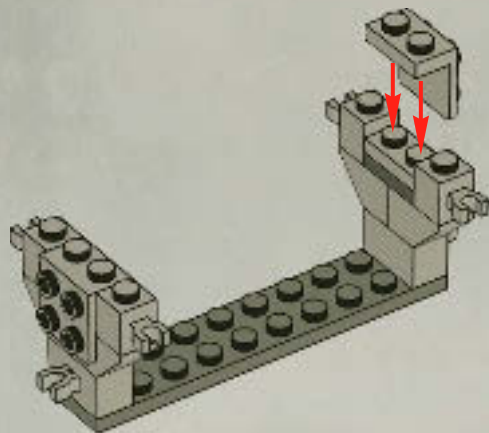



2x



4x

7

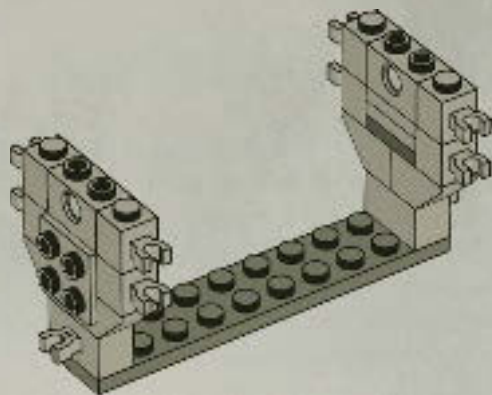



1x

8

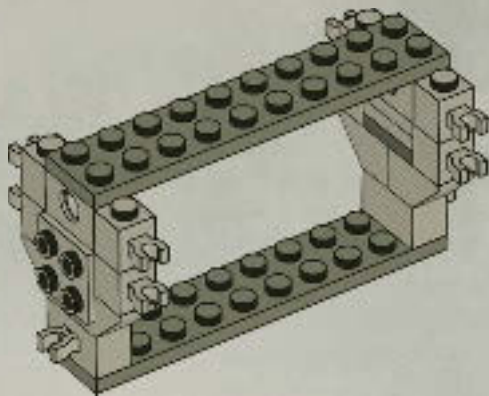



2x

9

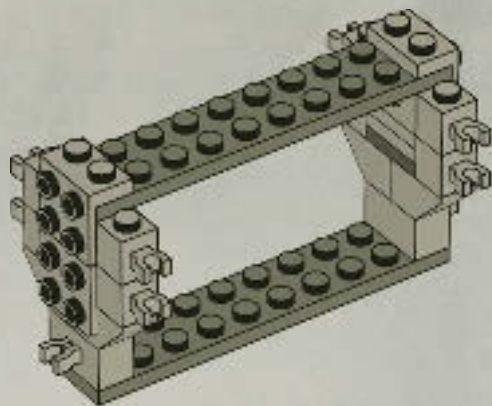



4x

10

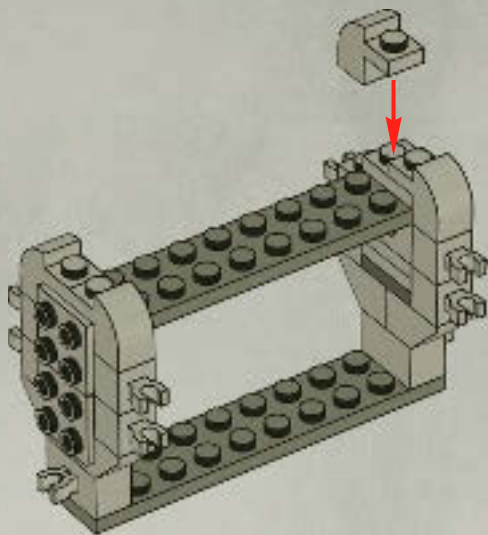



4x



2x



2x

# 11

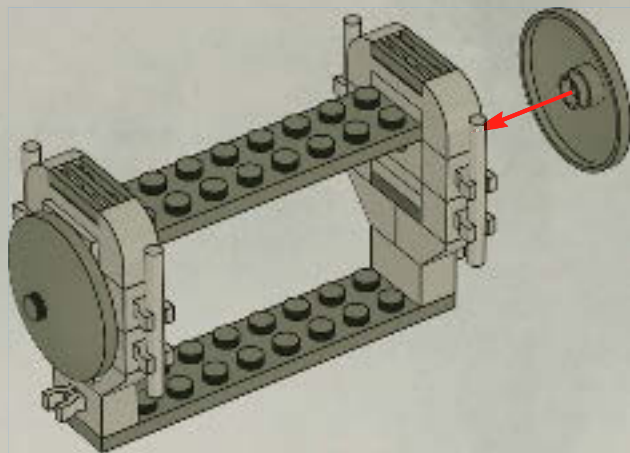



2x



4x



8x



2x

1

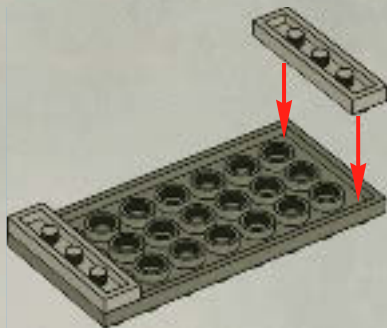

2

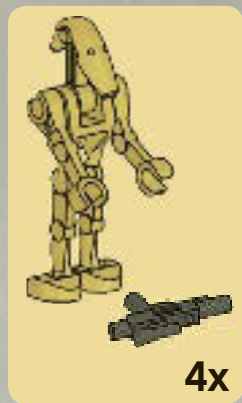
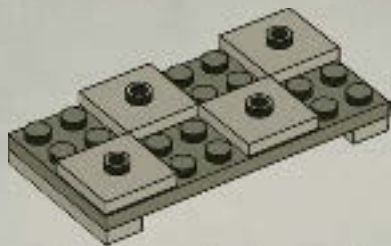

4x

4

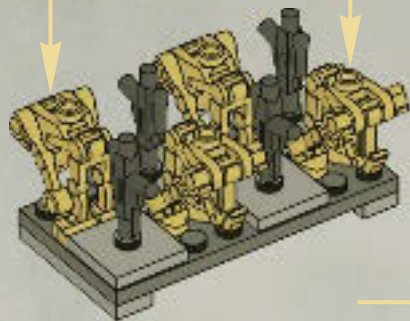

2x



12

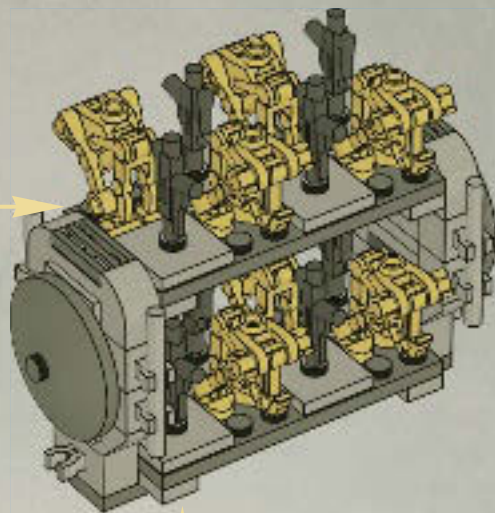

25

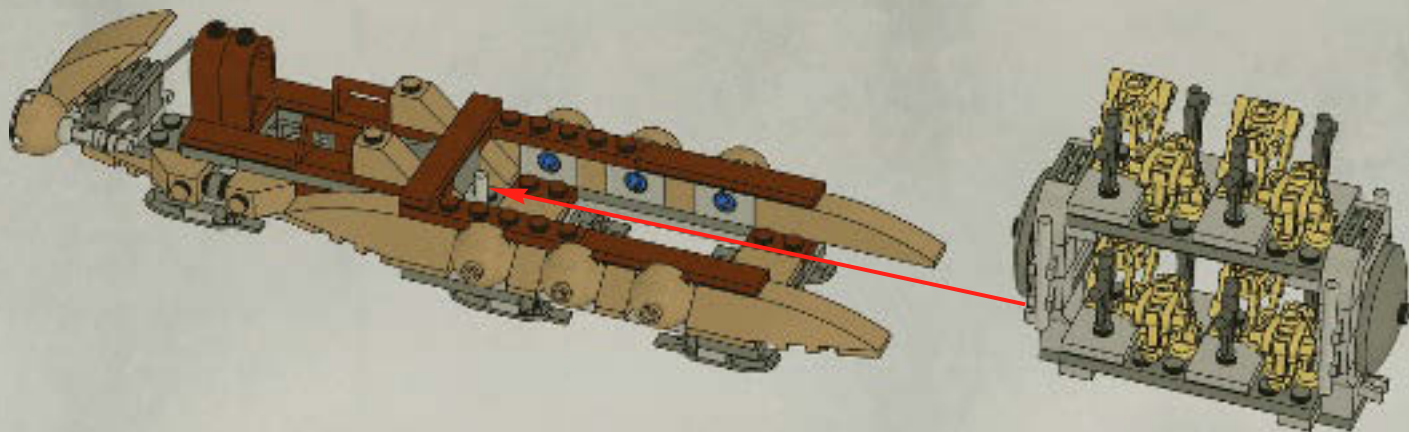

26

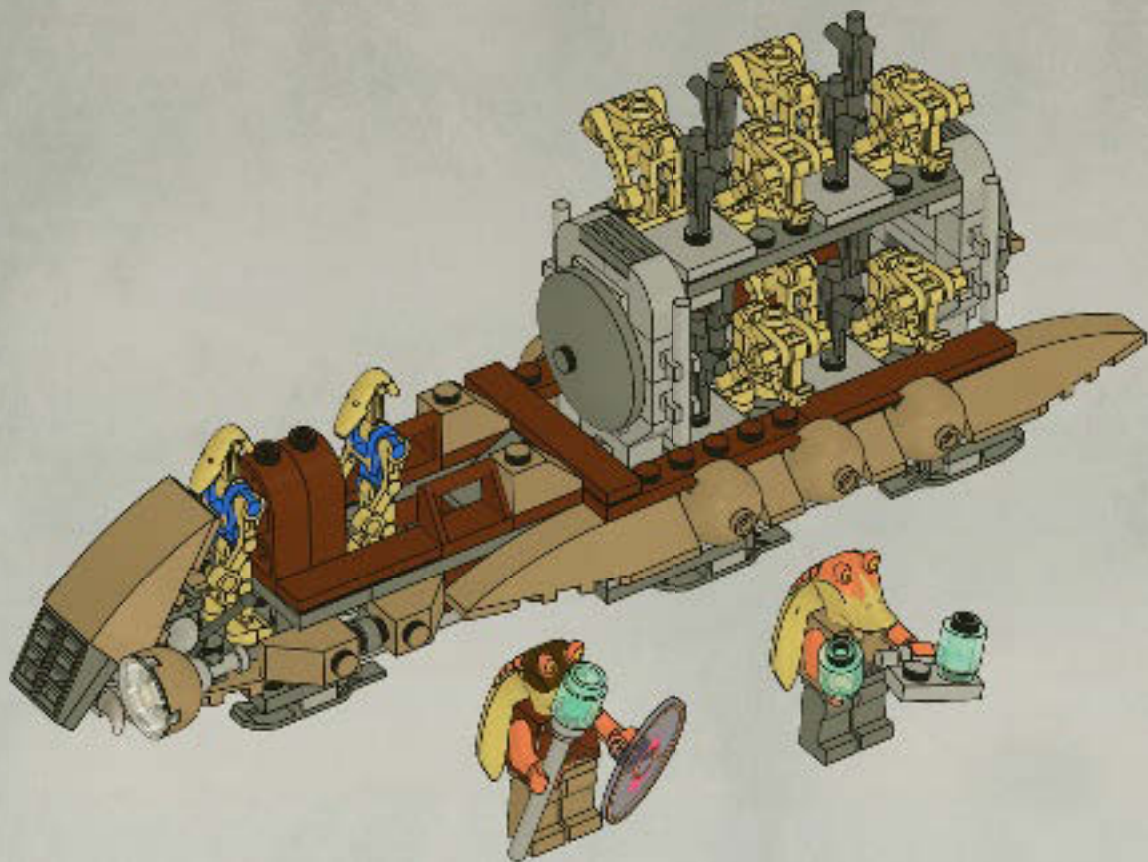



**Customer Service**

**Kundenservice**

**Service Consommateurs**

**Servicio Al Consumidor**

[www.lego.com/service](http://www.lego.com/service) or dial

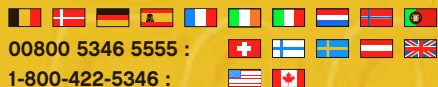



# STAR WARS™





7913



7914



7915



7929



7868



7869



7930



7931



www.LEGOclub.com



LEGO® Club Email



LEGO® Club Magazine

**LEGO** club™

**FREE! GRATIS! GRATUIT!**

**SIGN UP ONLINE!**

**www.LEGOclub.com**



**00800 5346 5555\***



**1-866-534-6258 • 1-877-518-5346**

US & Canada only

Outside continental

- \* Freephone. Mobile charges may apply.
- \* Numéro sans frais. Des frais peuvent s'appliquer avec les téléphones cellulaires.
- \* Gebührenfrei, Kosten für Anrufe aus Mobilfunknetzen können abweichen.
- \* Gratis telefonnummer vanaf vaste lijn.
- \* Det er et gratis nummer, når du ringer fra fasttelefon.
- \* Det är gratis, när du ringer från en fast telefon.
- \* Numéro sans frais. Des frais peuvent s'appliquer avec les téléphones portables.



# WIN!

Go to [www.LEGOsurvey.com/product](http://www.LEGOsurvey.com/product) to fill out a survey for a chance to win a cool LEGO® Product.

No purchase necessary.

Open to all residents where not prohibited.



[www.LEGO.com](http://www.LEGO.com)

## [www.LEGOsurvey.com/product](http://www.LEGOsurvey.com/product)

### GEWINNE!

Nimm an der Umfrage auf [www.LEGOsurvey.com/product](http://www.LEGOsurvey.com/product) teil und hab die Chance ein cooles LEGO® Produkt zu gewinnen!

Die Teilnahme am Gewinnspiel führt zu keinerlei Kaufverpflichtungen. Teilnahme in allen nicht ausgeschlossenen Ländern möglich.

### WIN!

Ga naar [www.LEGOsurvey.com/product](http://www.LEGOsurvey.com/product), vul een enquêteformulier in en maak kans op een cool LEGO® product.

Geen aankoopverplichting. Iedereen mag deelnemen, uitgezonderd ingezetenden van landen waar een enquêteverbod geldt.

### GAGNE!

Visite [www.LEGOsurvey.com/product](http://www.LEGOsurvey.com/product) pour répondre à un questionnaire et avoir une chance de gagner un produit LEGO® très cool!

Aucune obligation d'achat. Ouvert à tous les résidents des pays autorisés.

### 当てよう!

[www.LEGOsurvey.com/product](http://www.LEGOsurvey.com/product) にアクセスして、アンケートにご記入ください。当選者にはレゴ®製品を差し上げます。

お買い上げの必要はありません。禁止されていない限り、すべての皆様にご利用いただけます。