

# TECHNIC

9397



4x

5

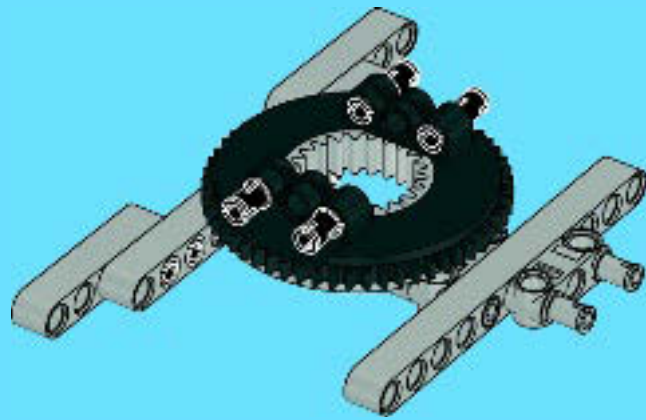

121

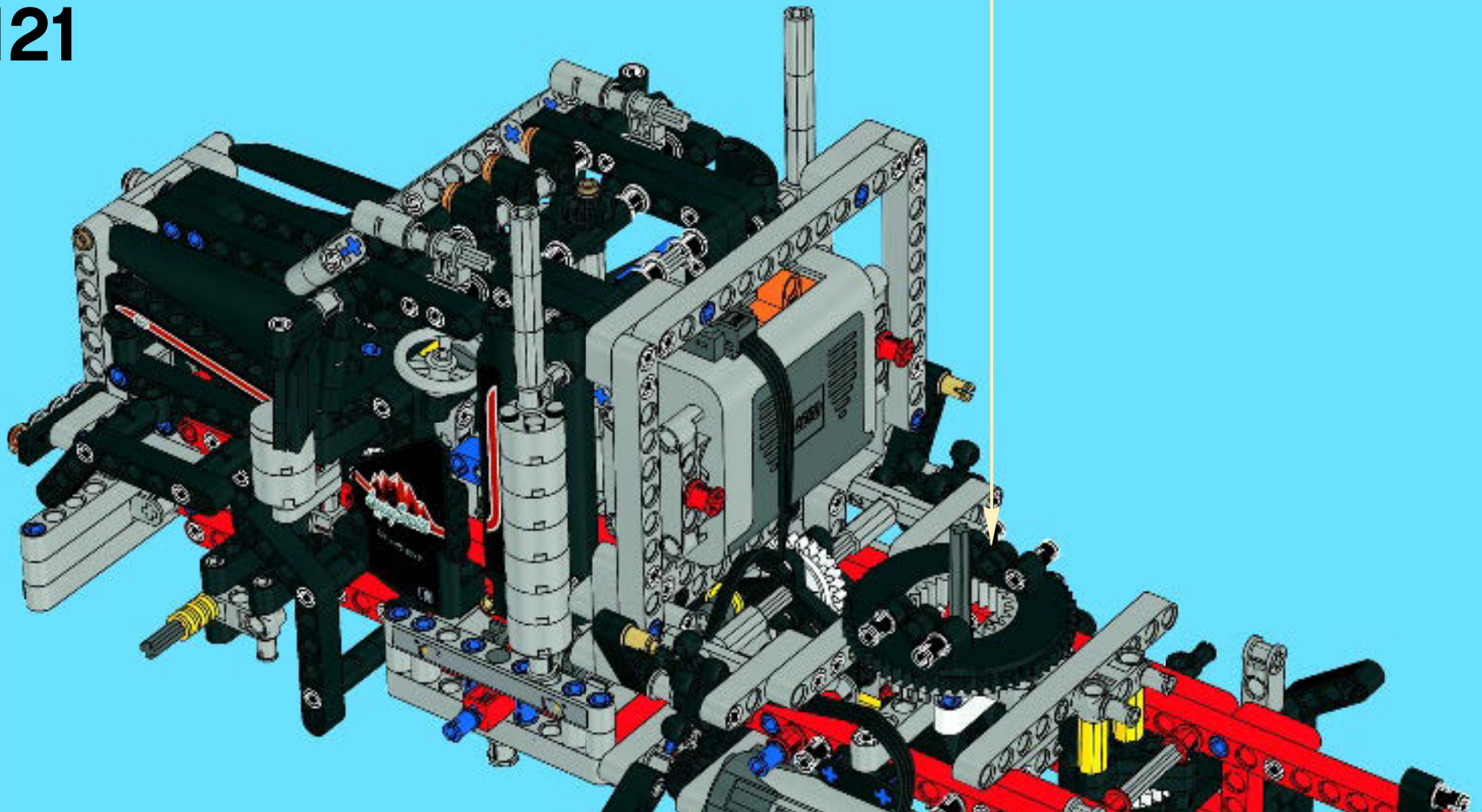

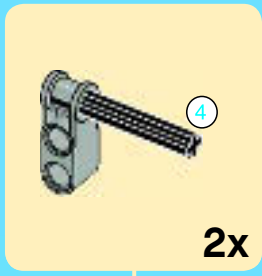
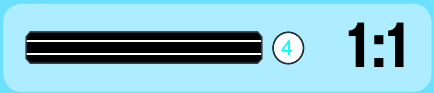
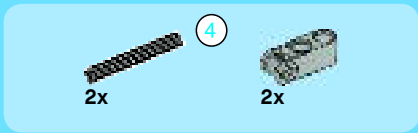

# 122

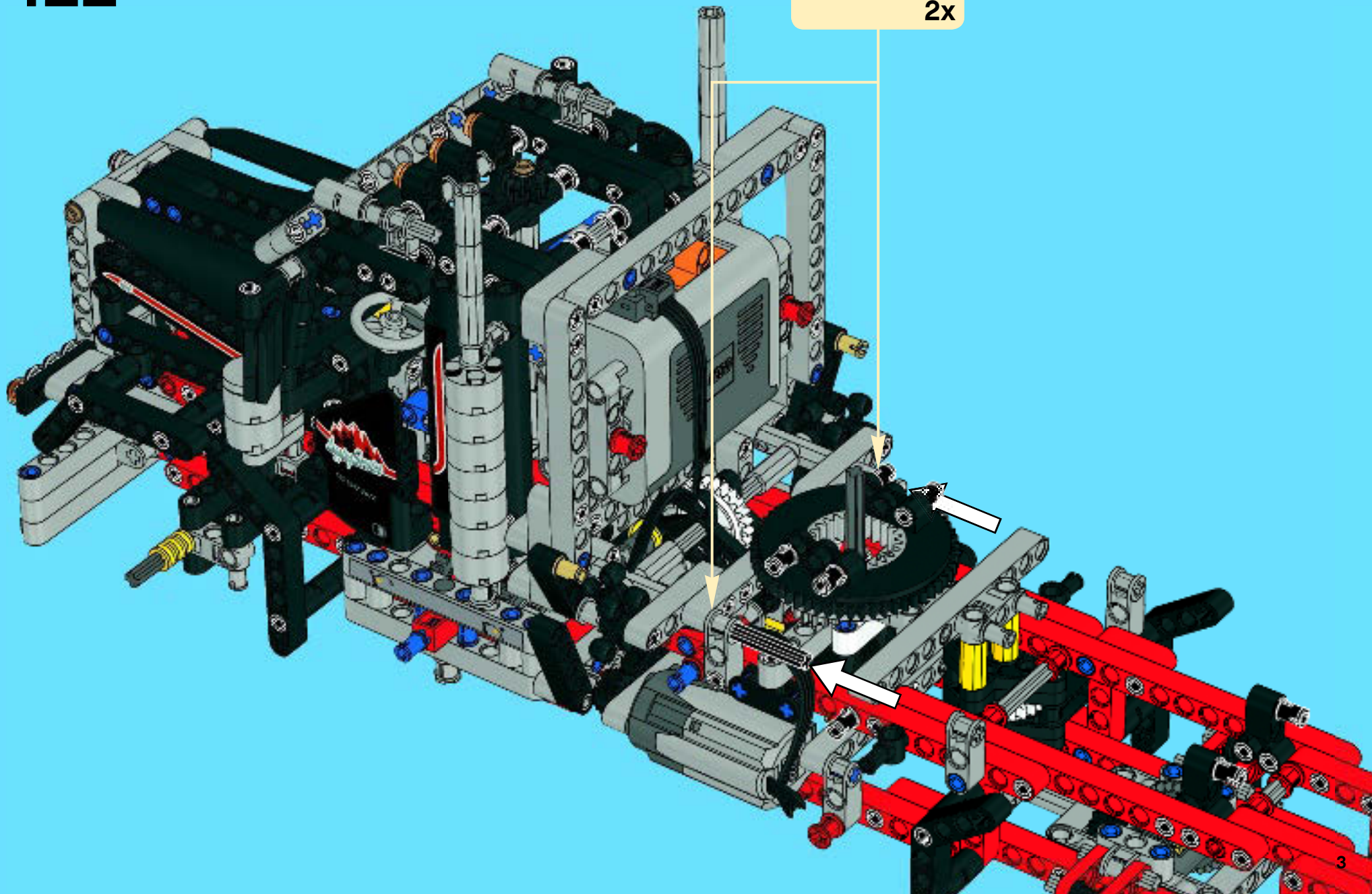

2x

2x

2x

# 123

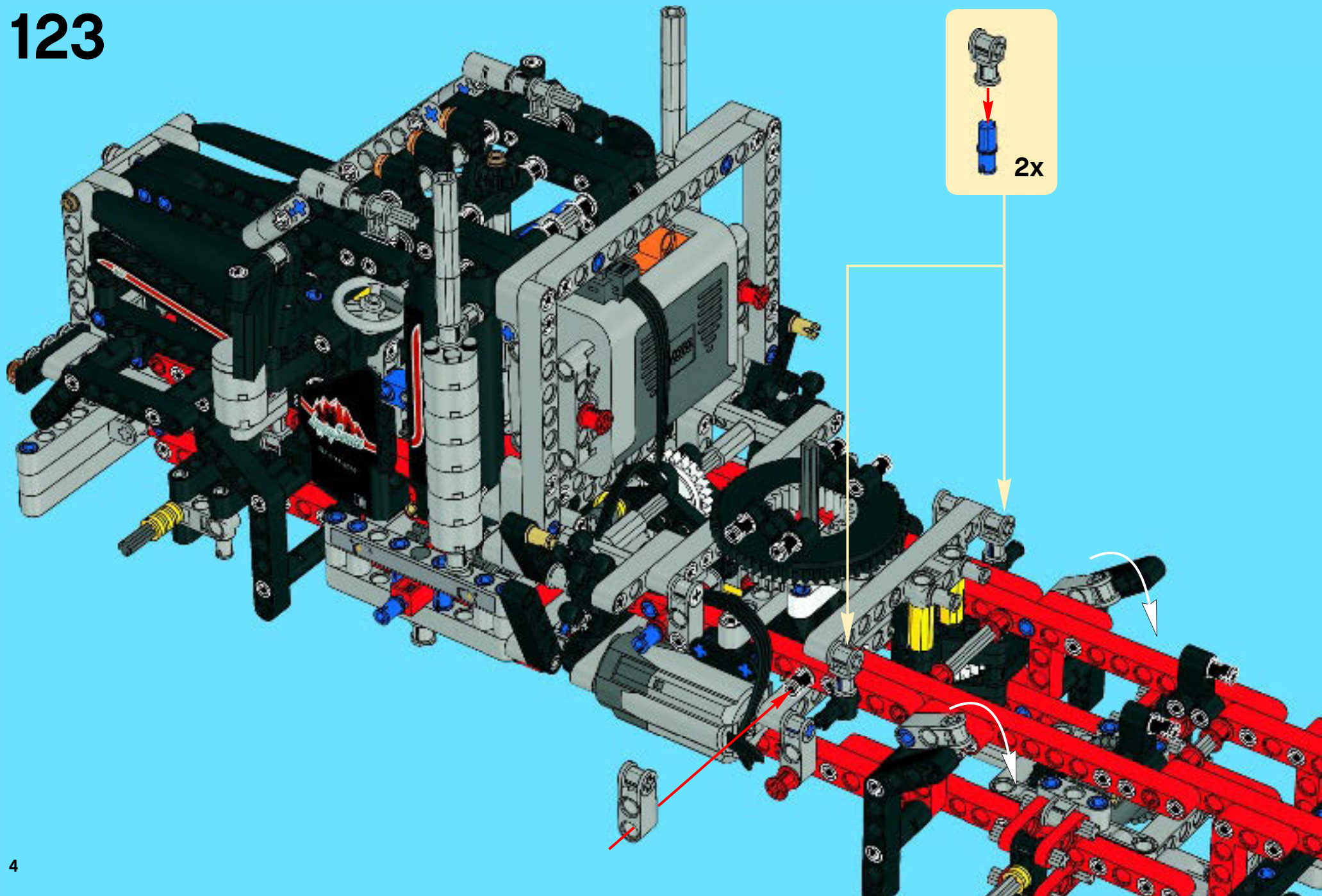

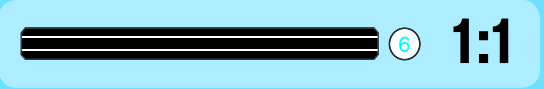

124

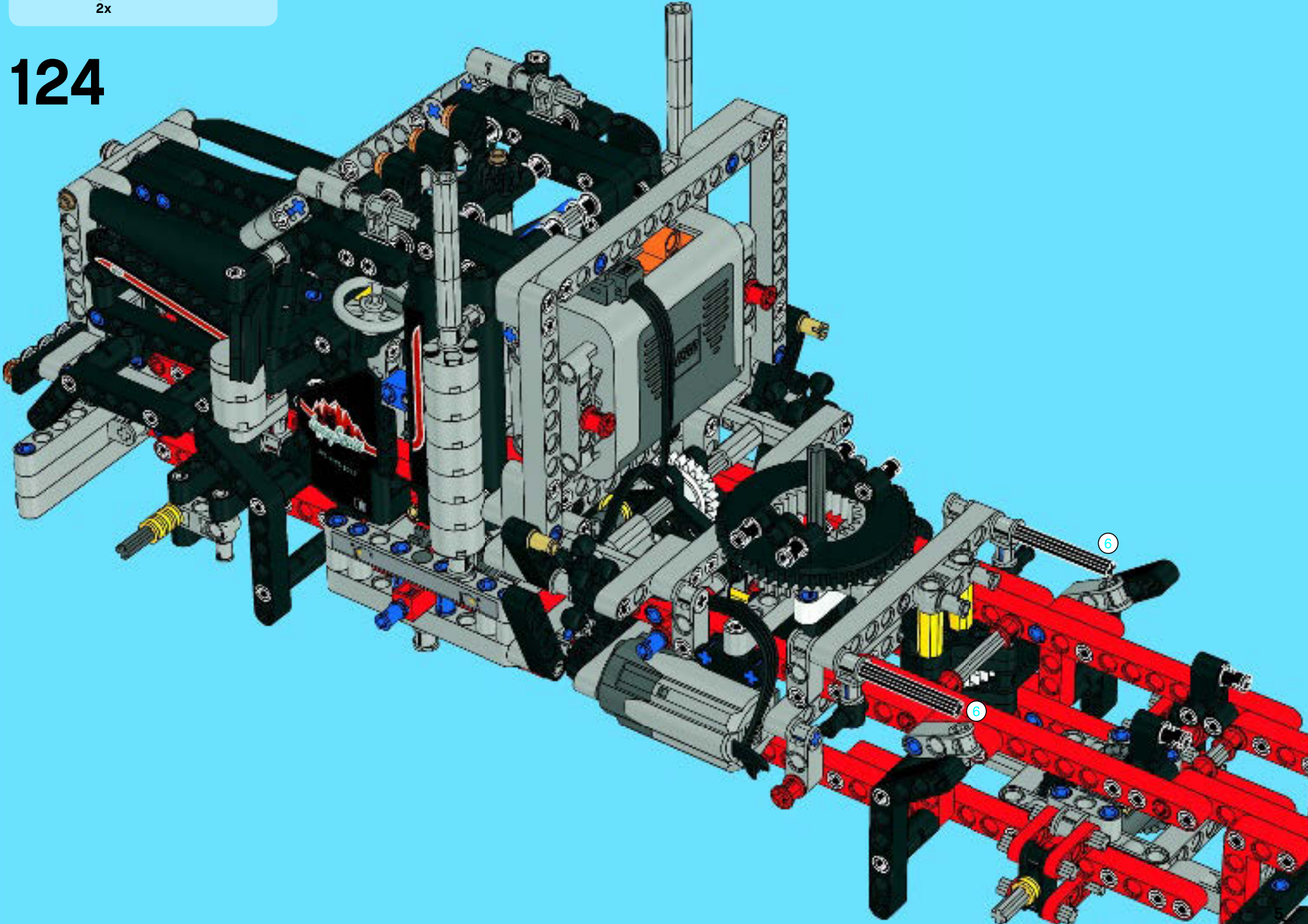

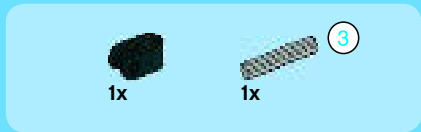

1

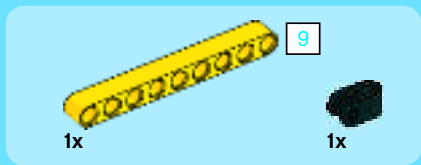

2



6

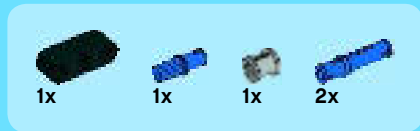

3

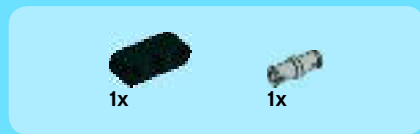
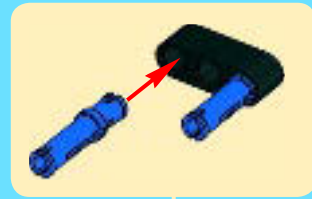
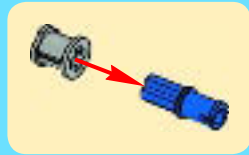

4

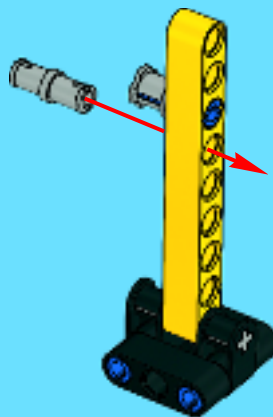

2x

125

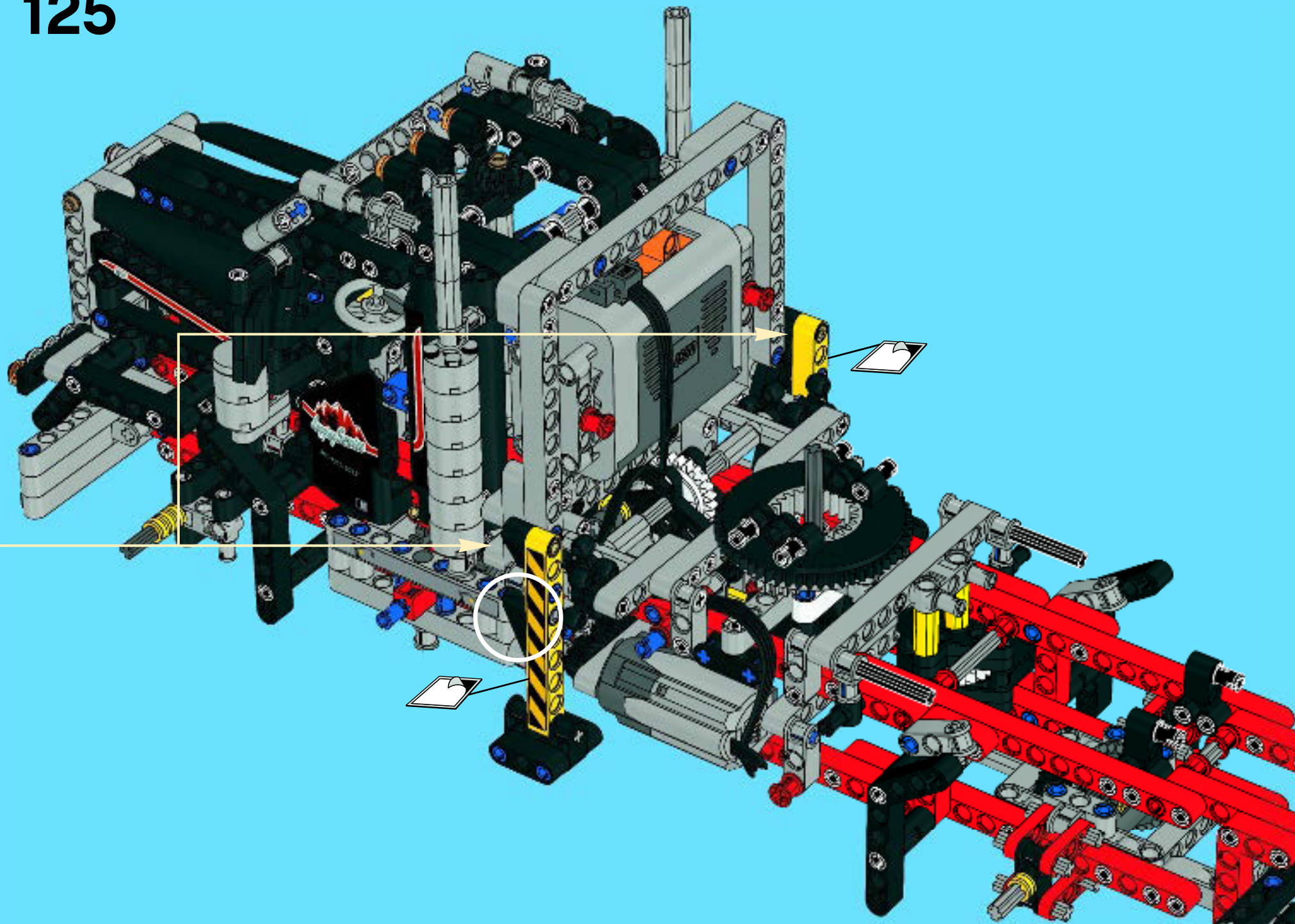



# 126

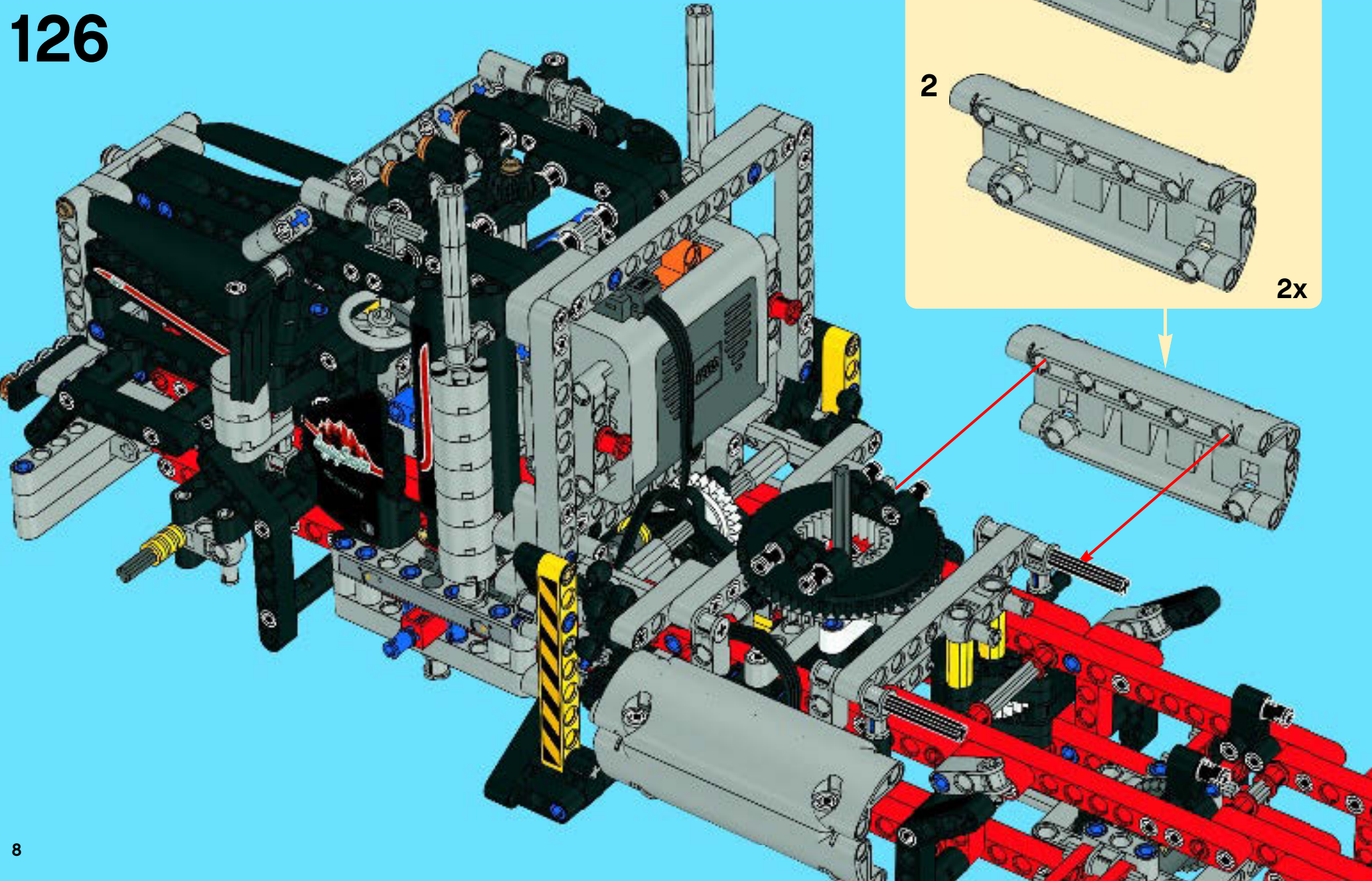
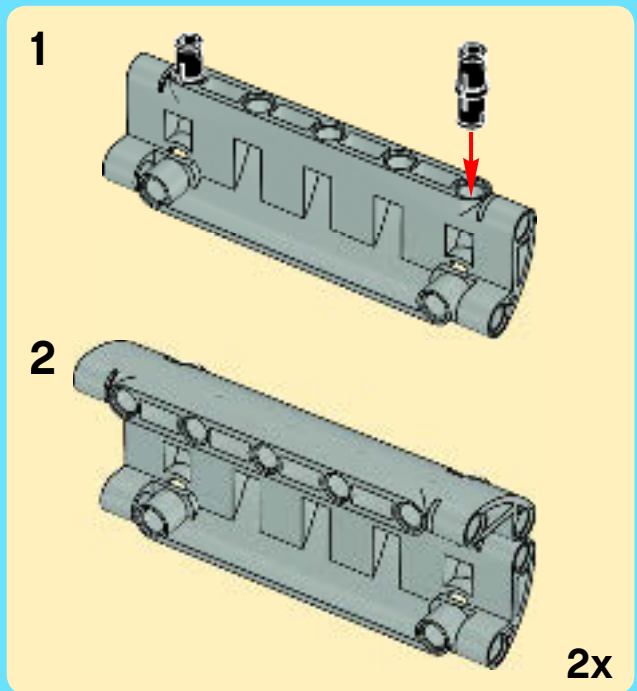





2x



1x

# 127

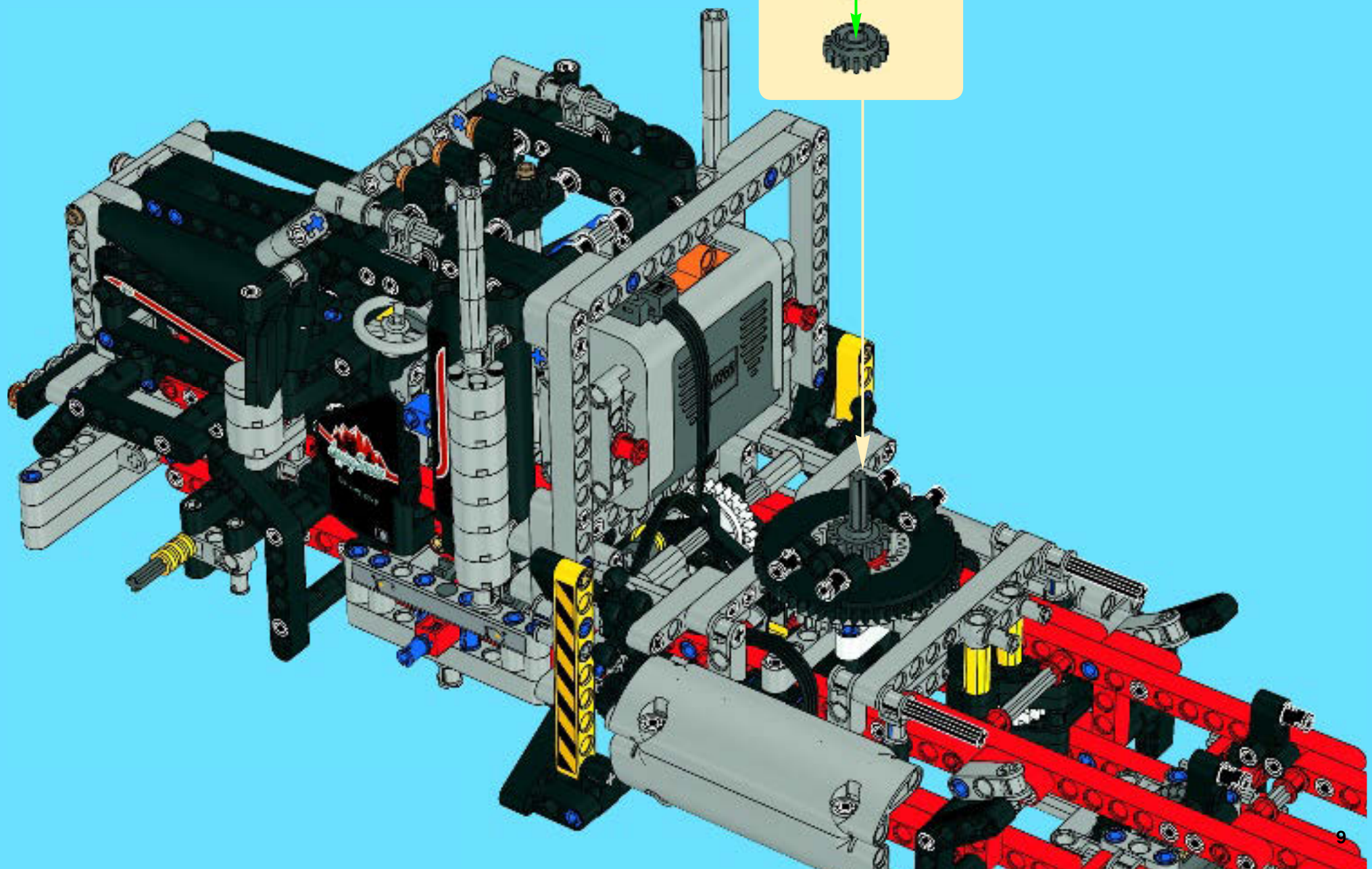
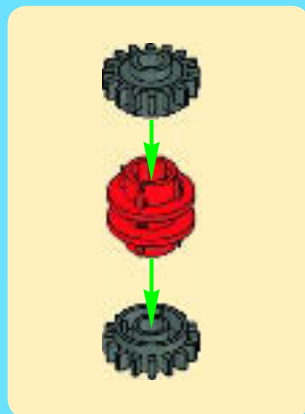

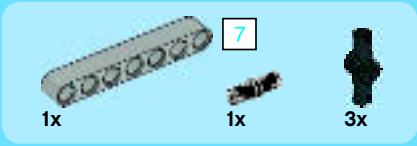

1

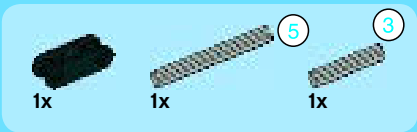
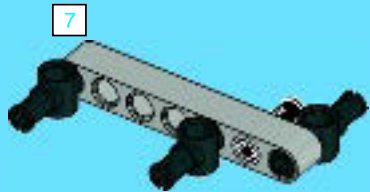

2

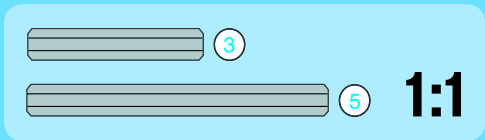
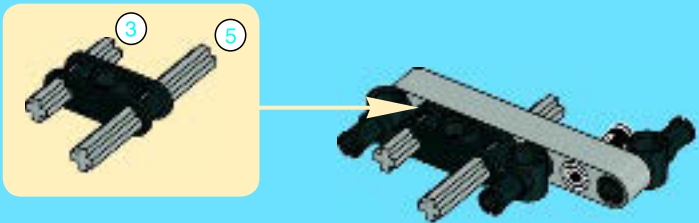

3

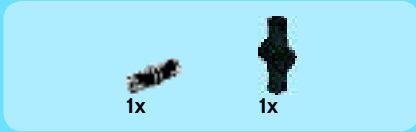
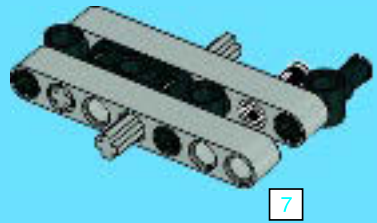

4



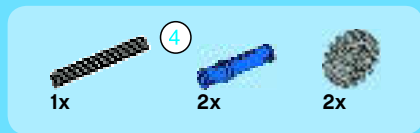

5

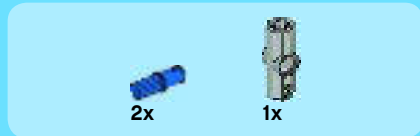
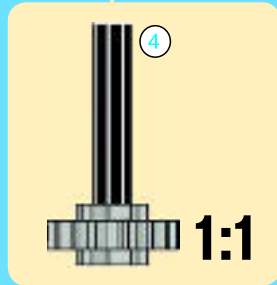
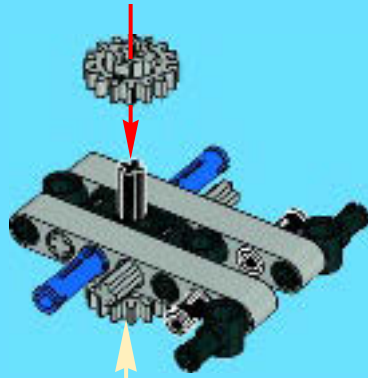
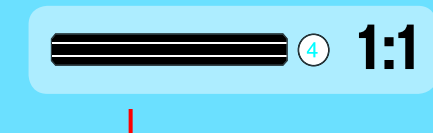

6

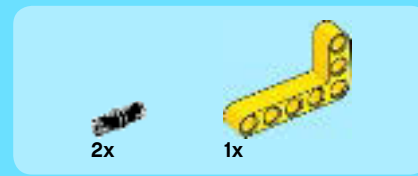
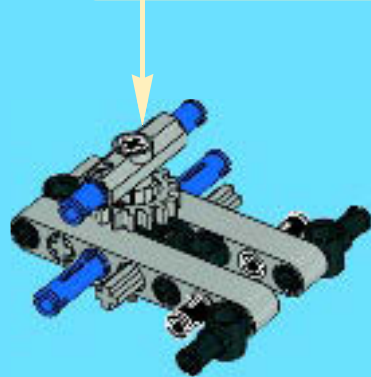
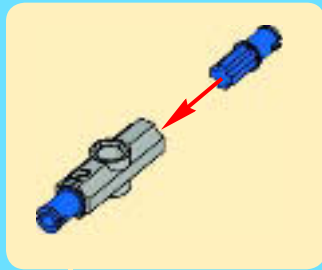

7

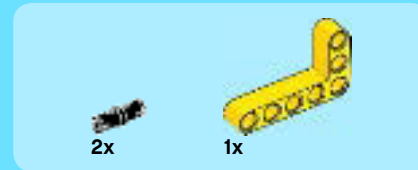
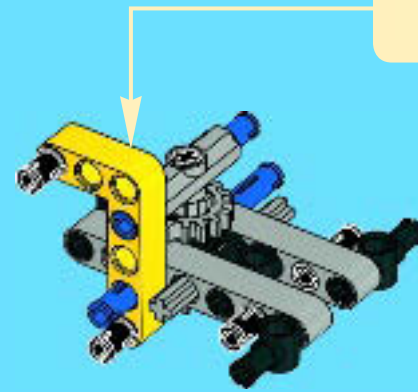
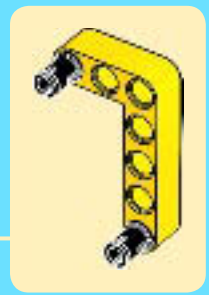

8

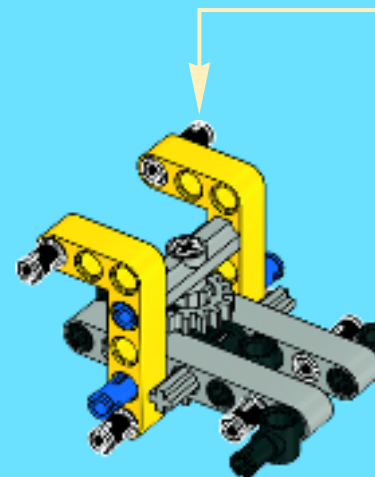
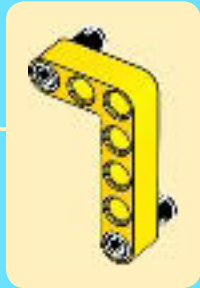



9

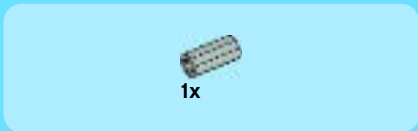
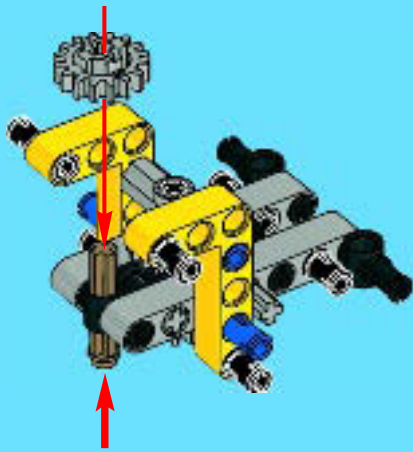

10

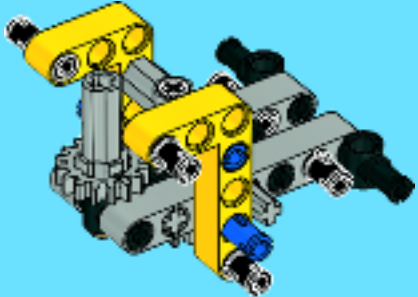

128

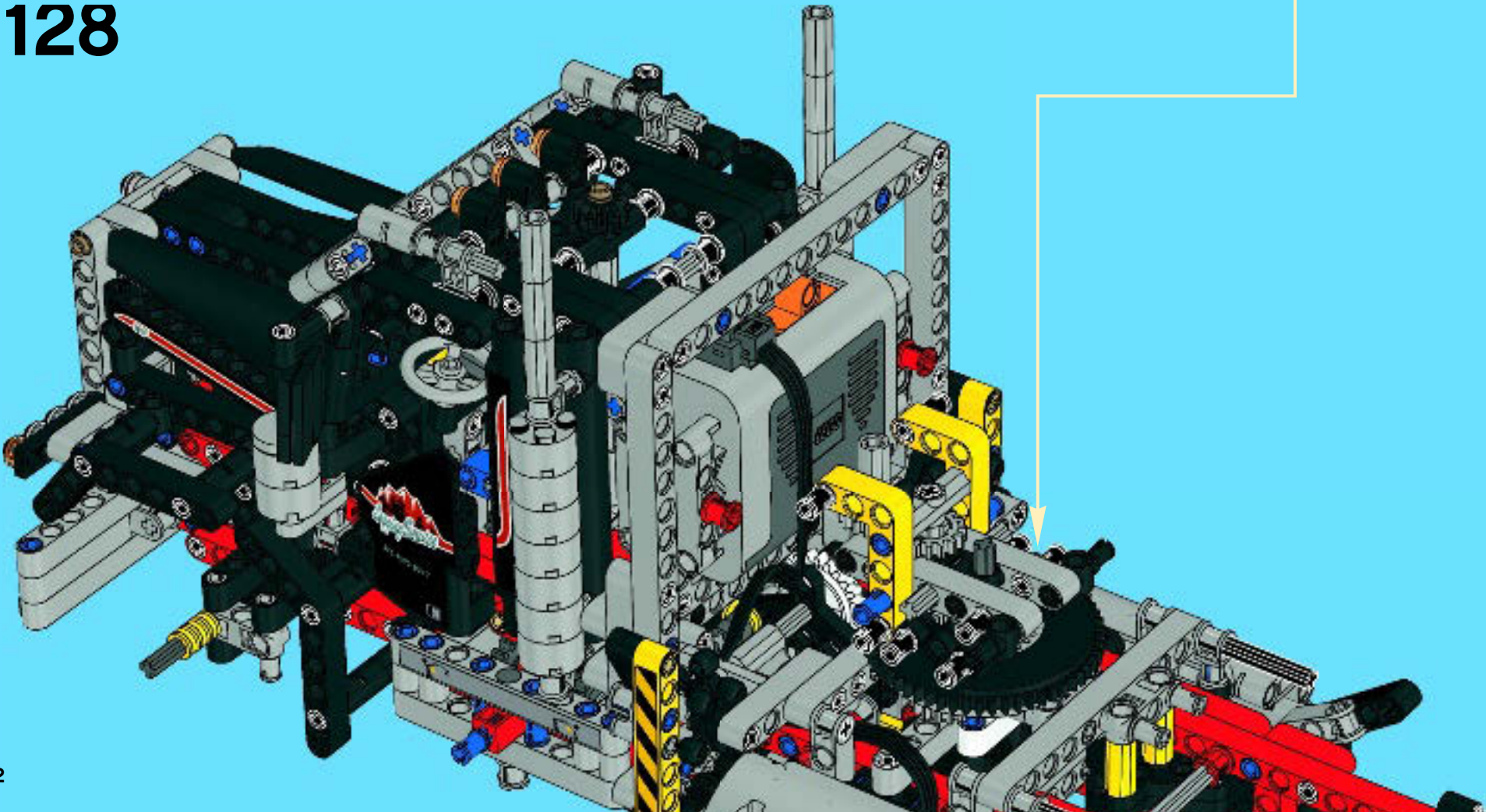



1x

# 129

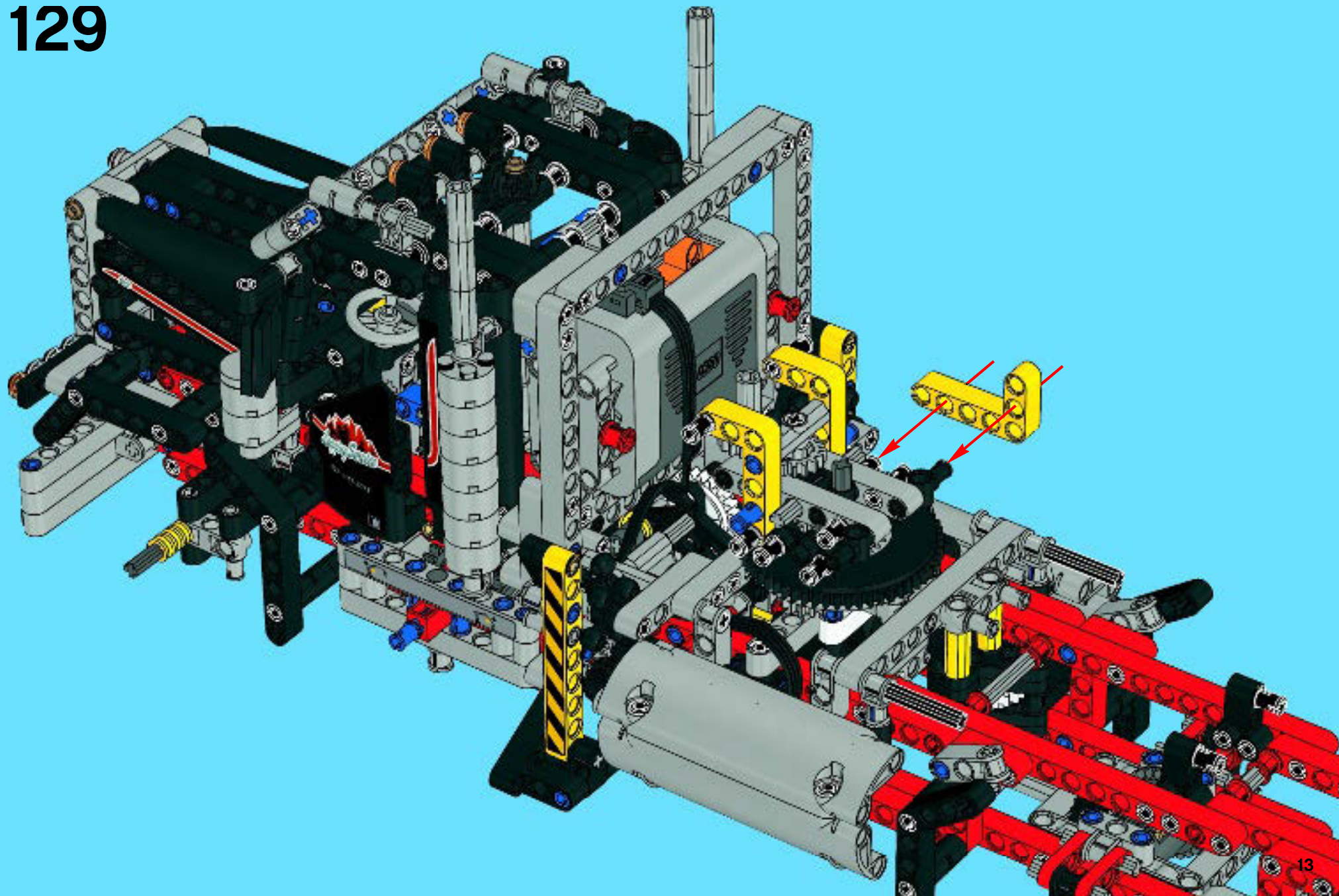

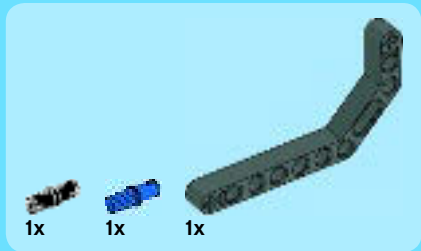

1

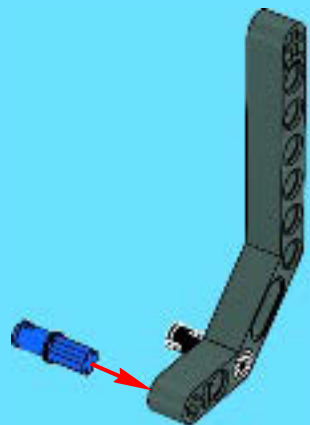

2

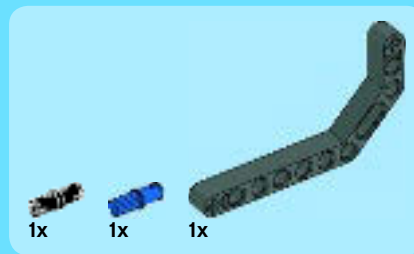
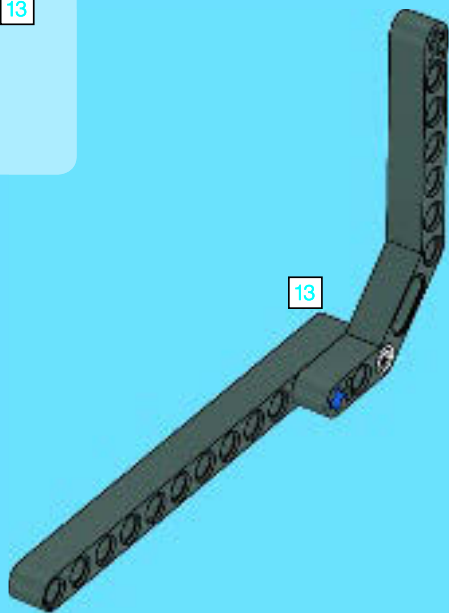

3

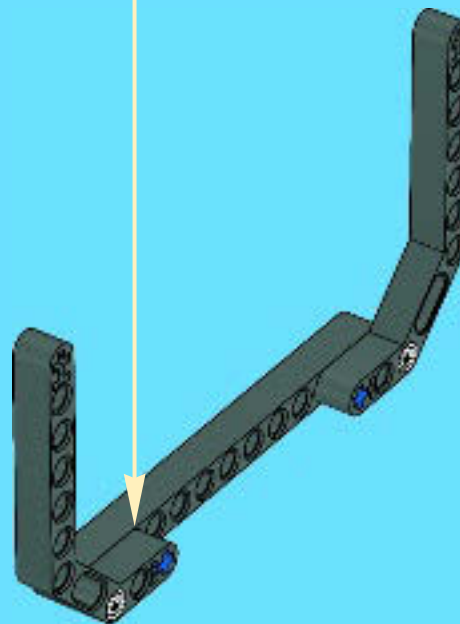
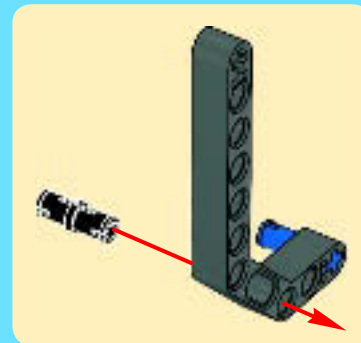

130

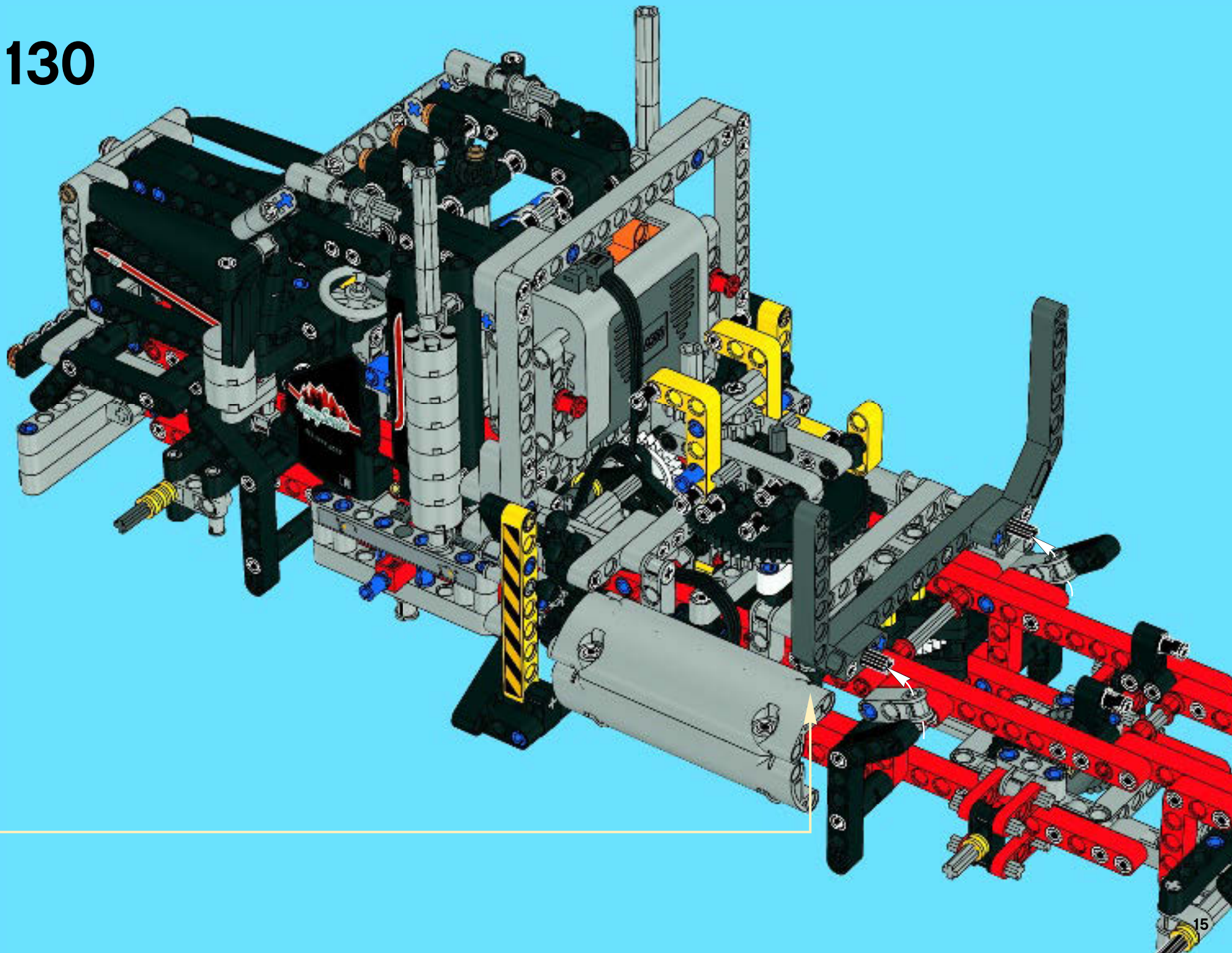

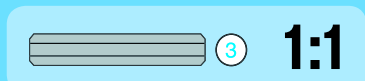
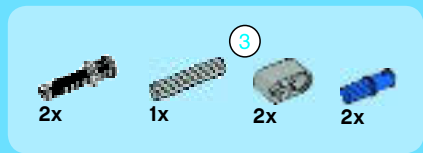

131

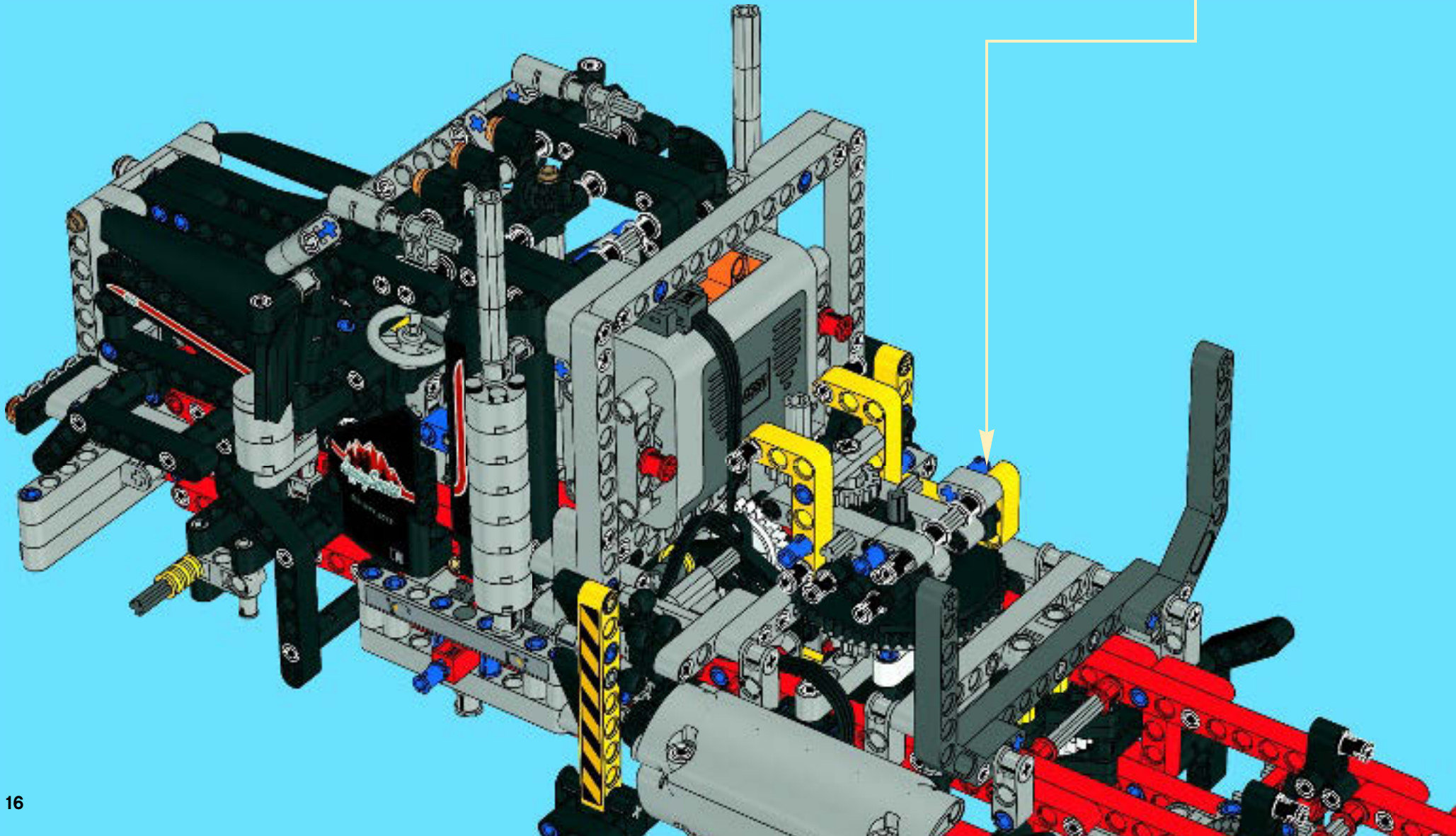
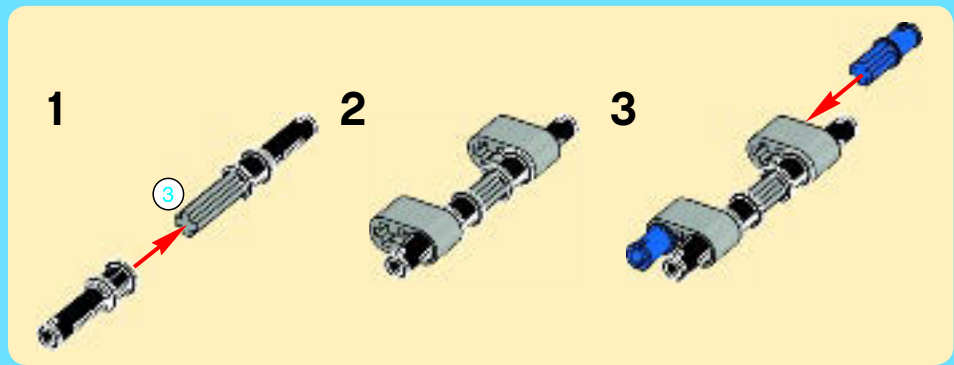





1x

# 132

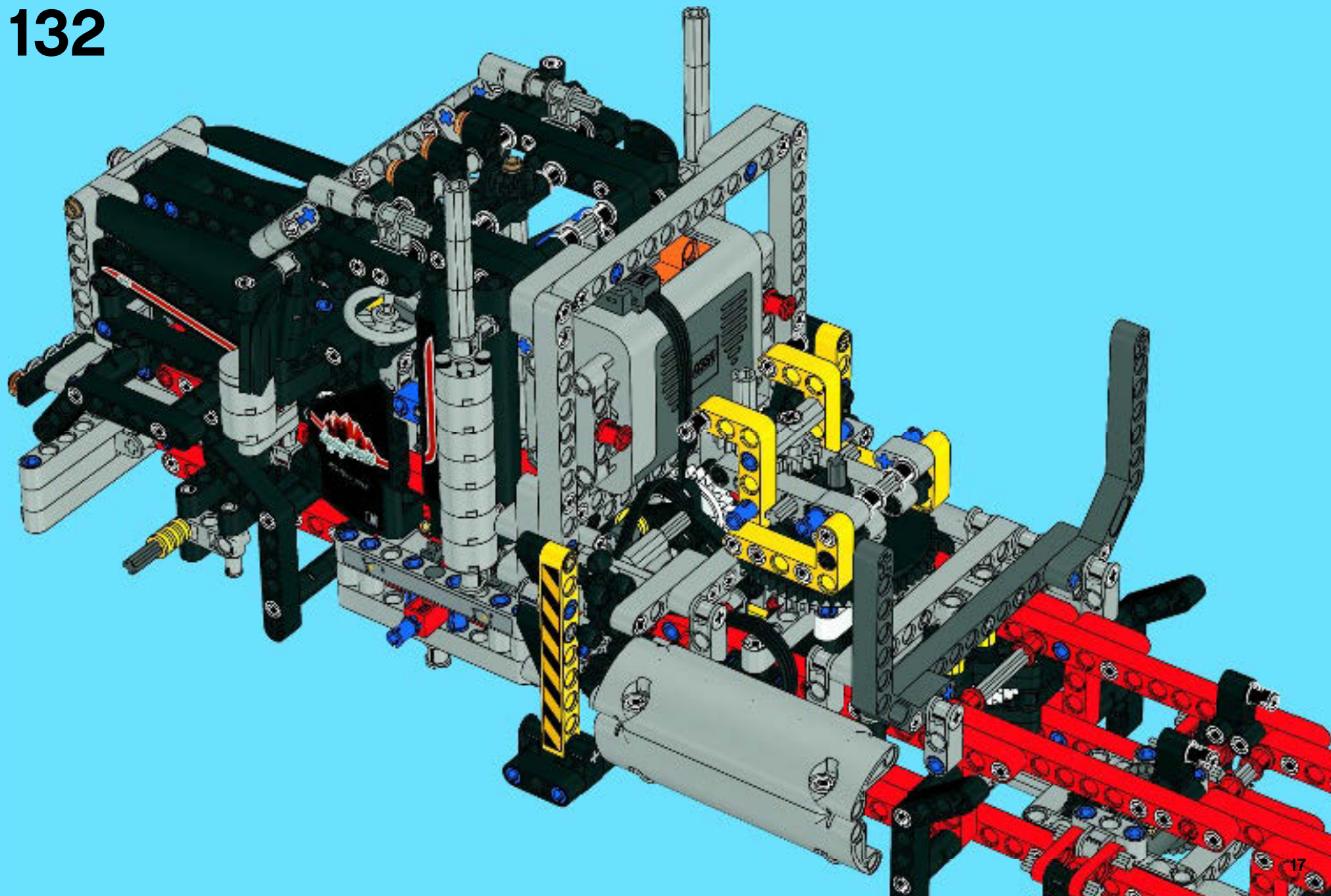

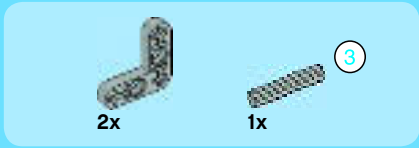

1

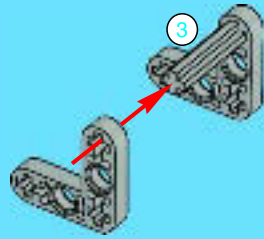

2

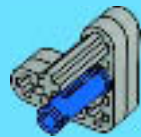

3

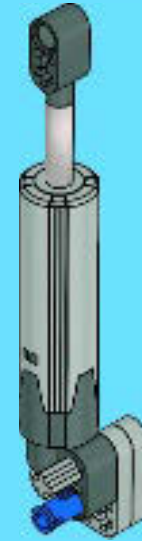

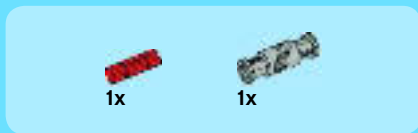

4

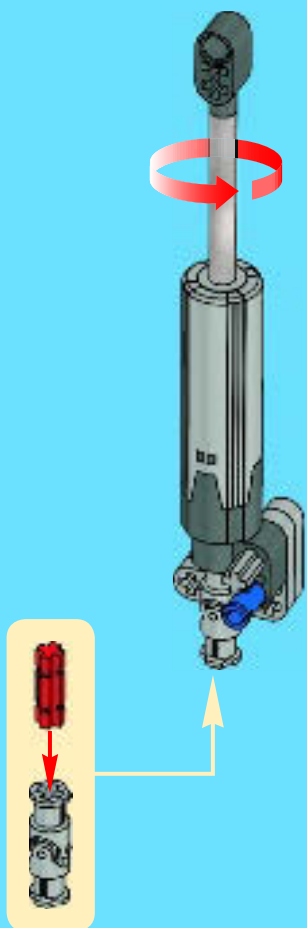

5

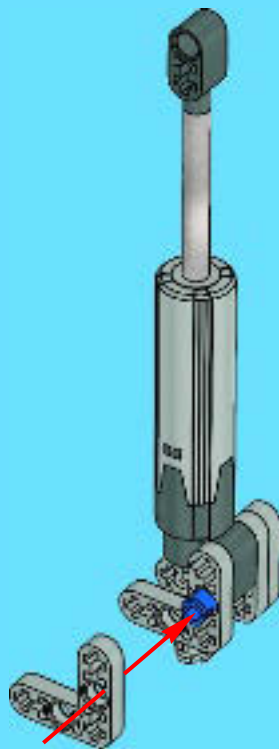

6

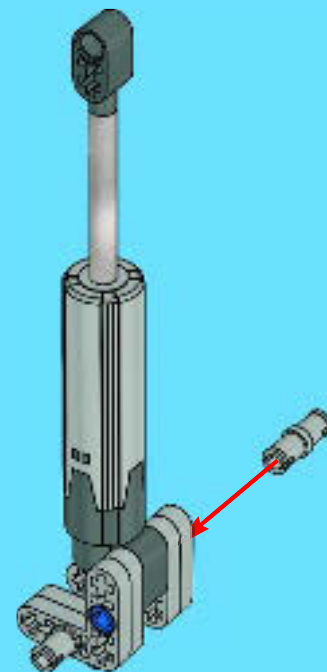

133

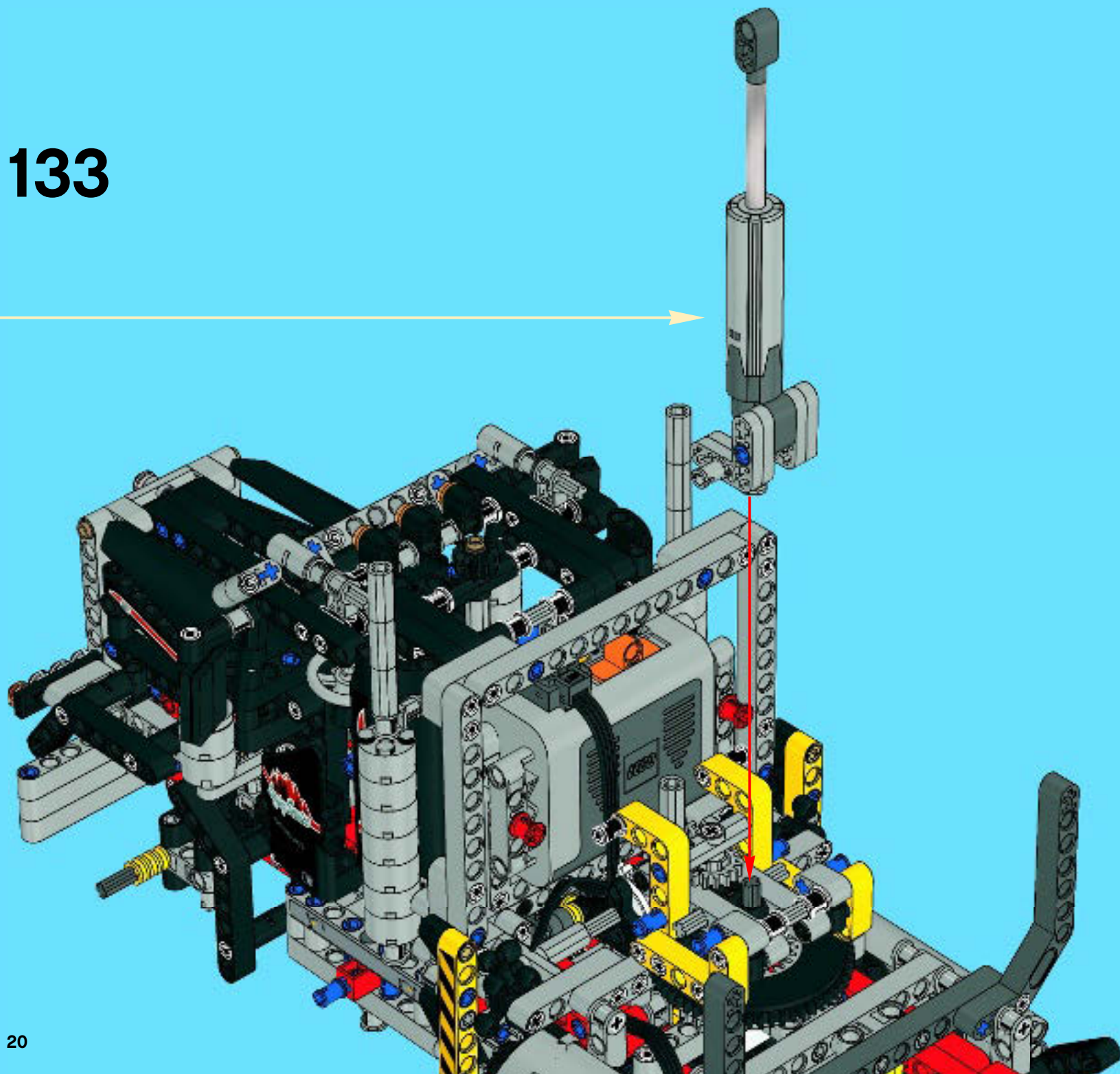



2x

# 134

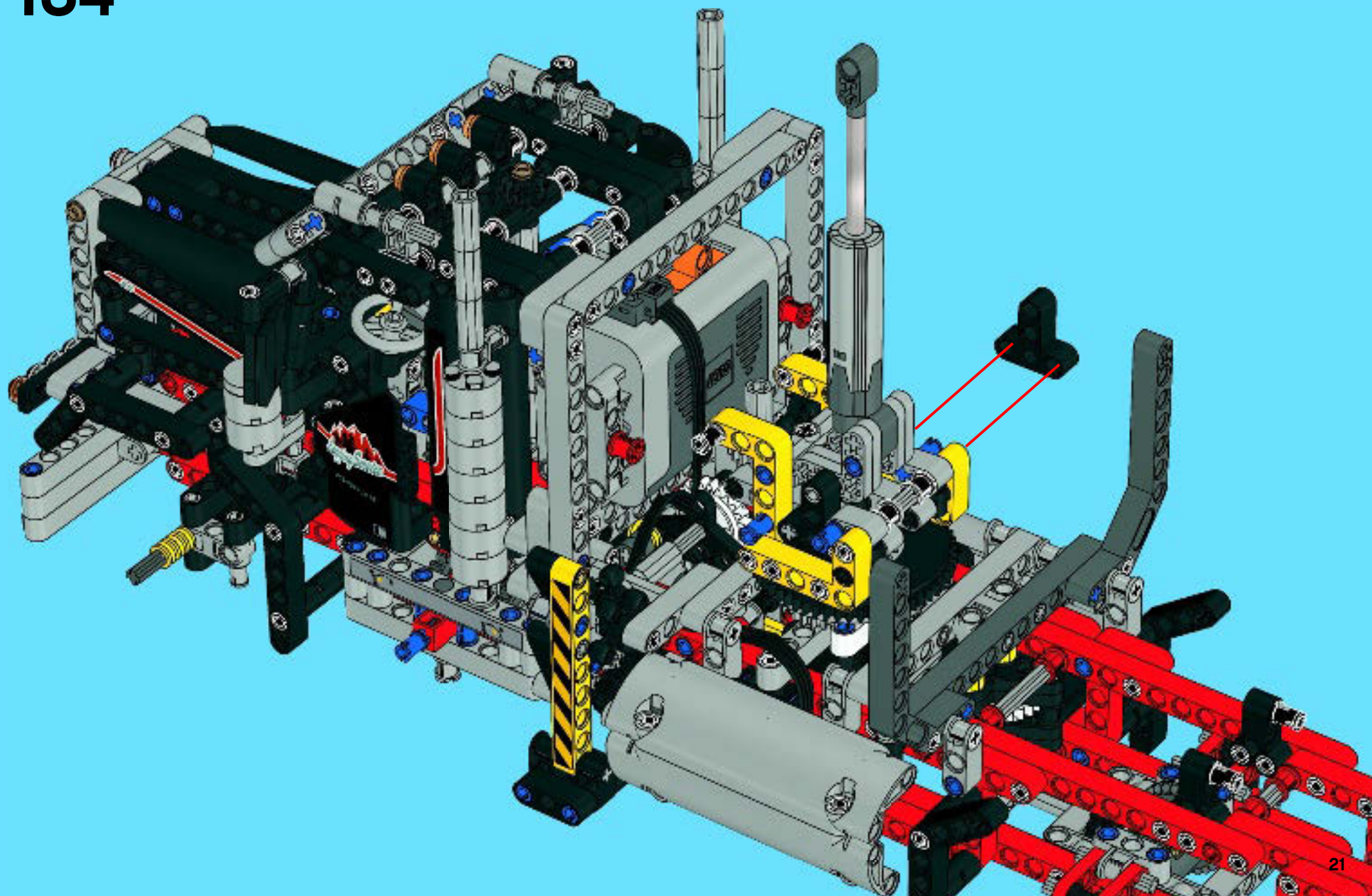

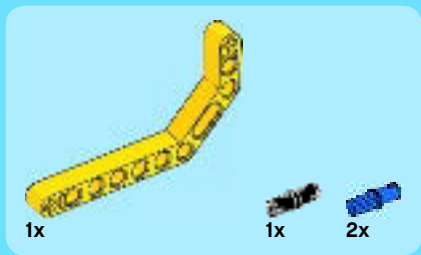

135

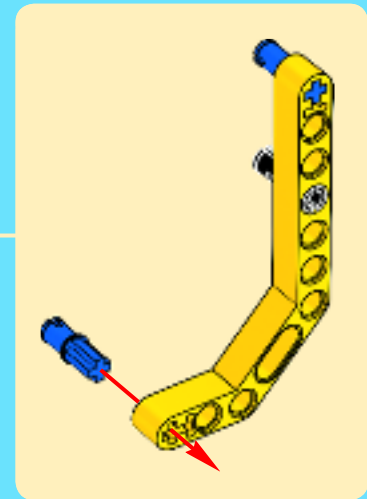
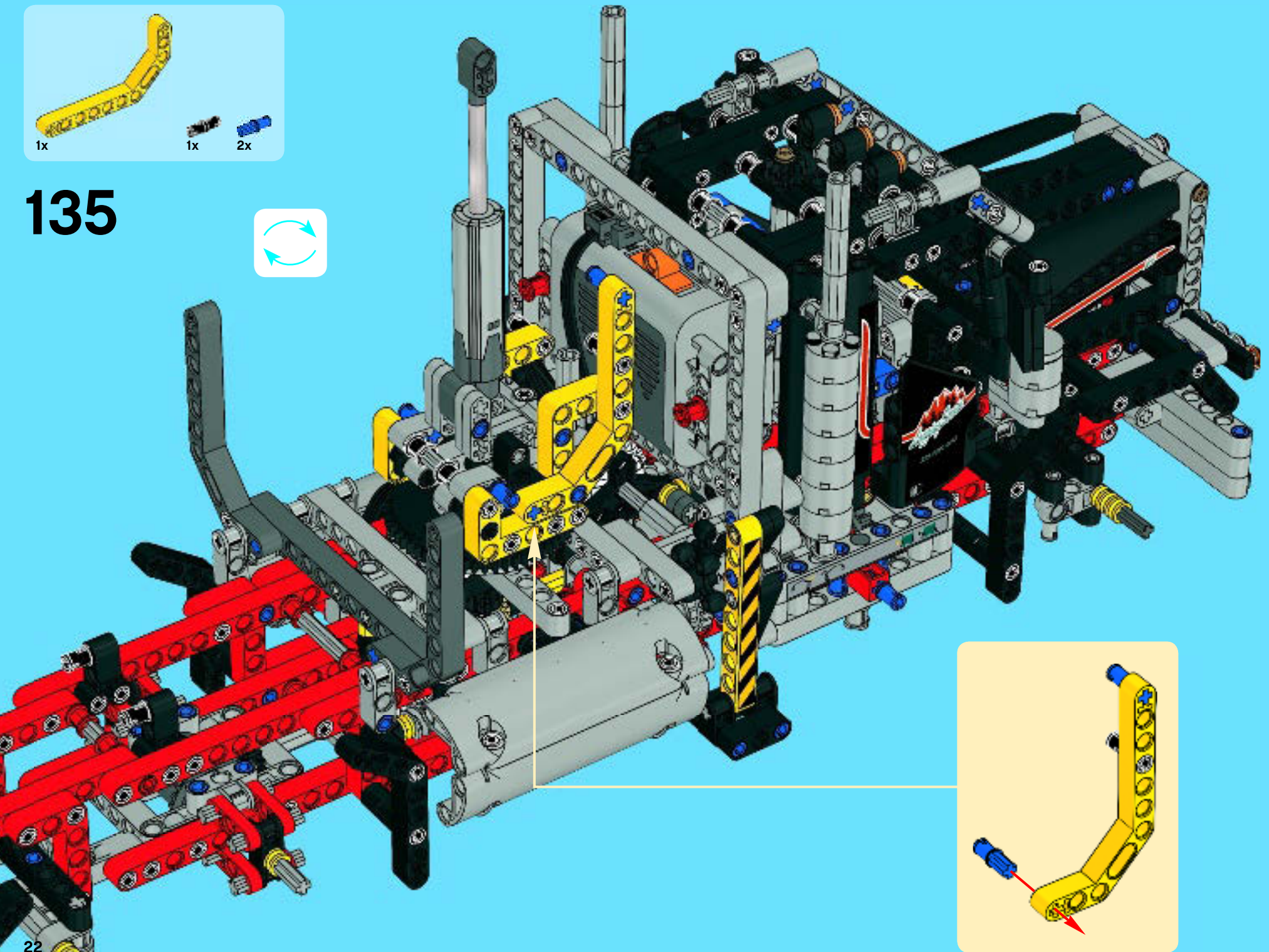

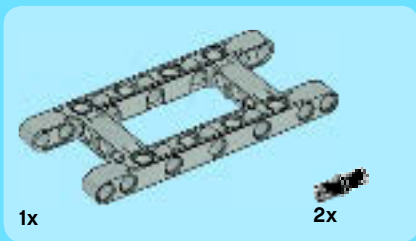

# 136

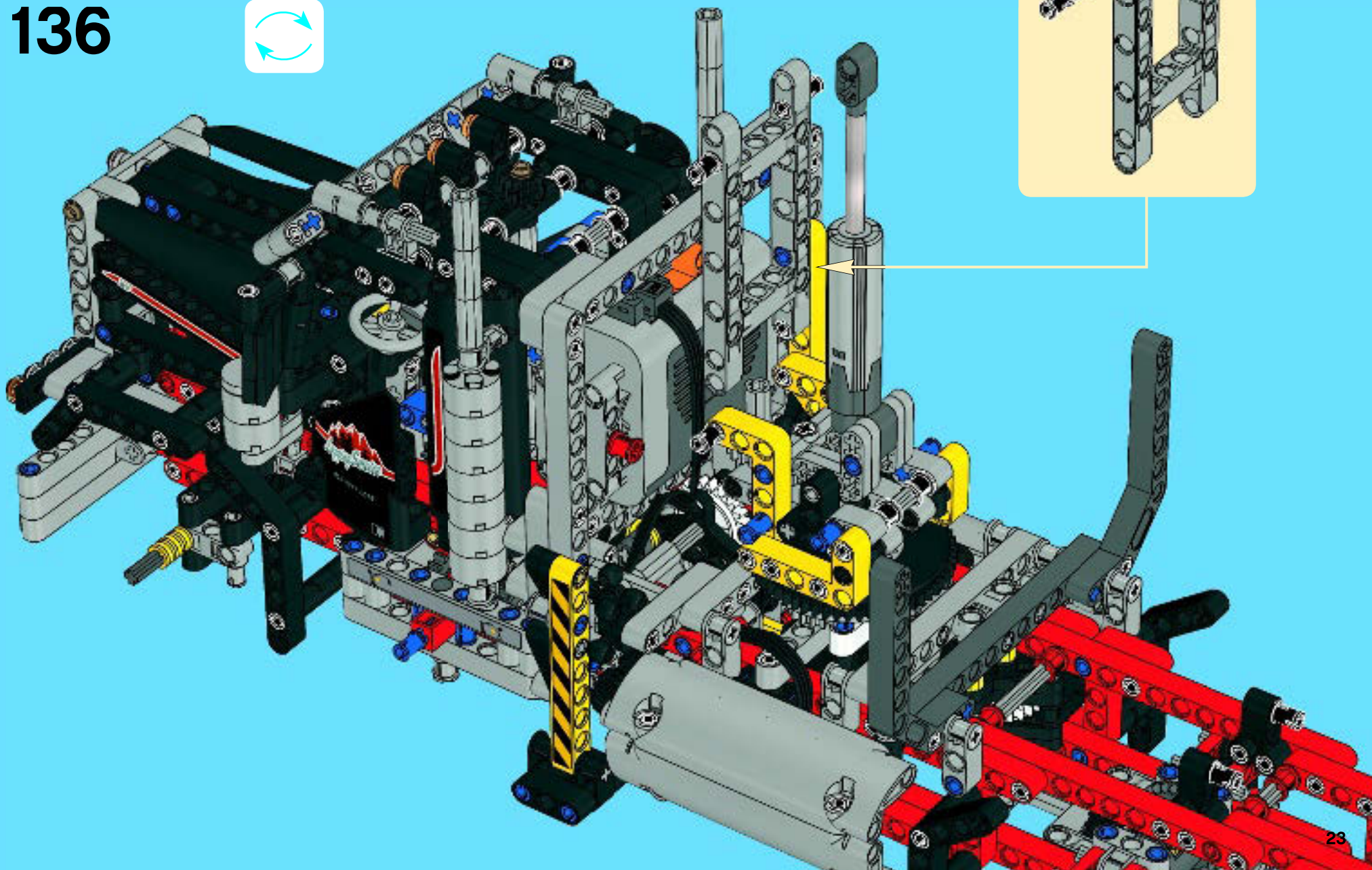
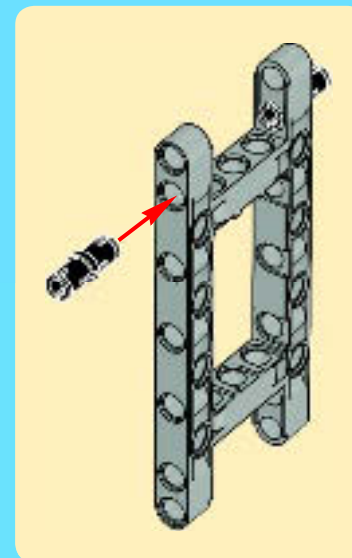

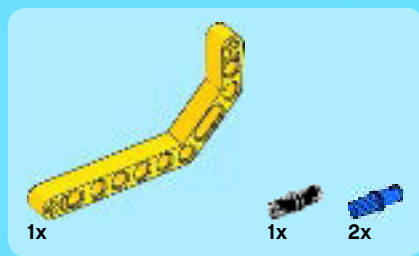

137

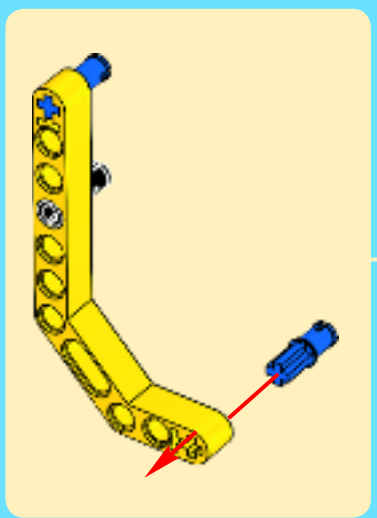
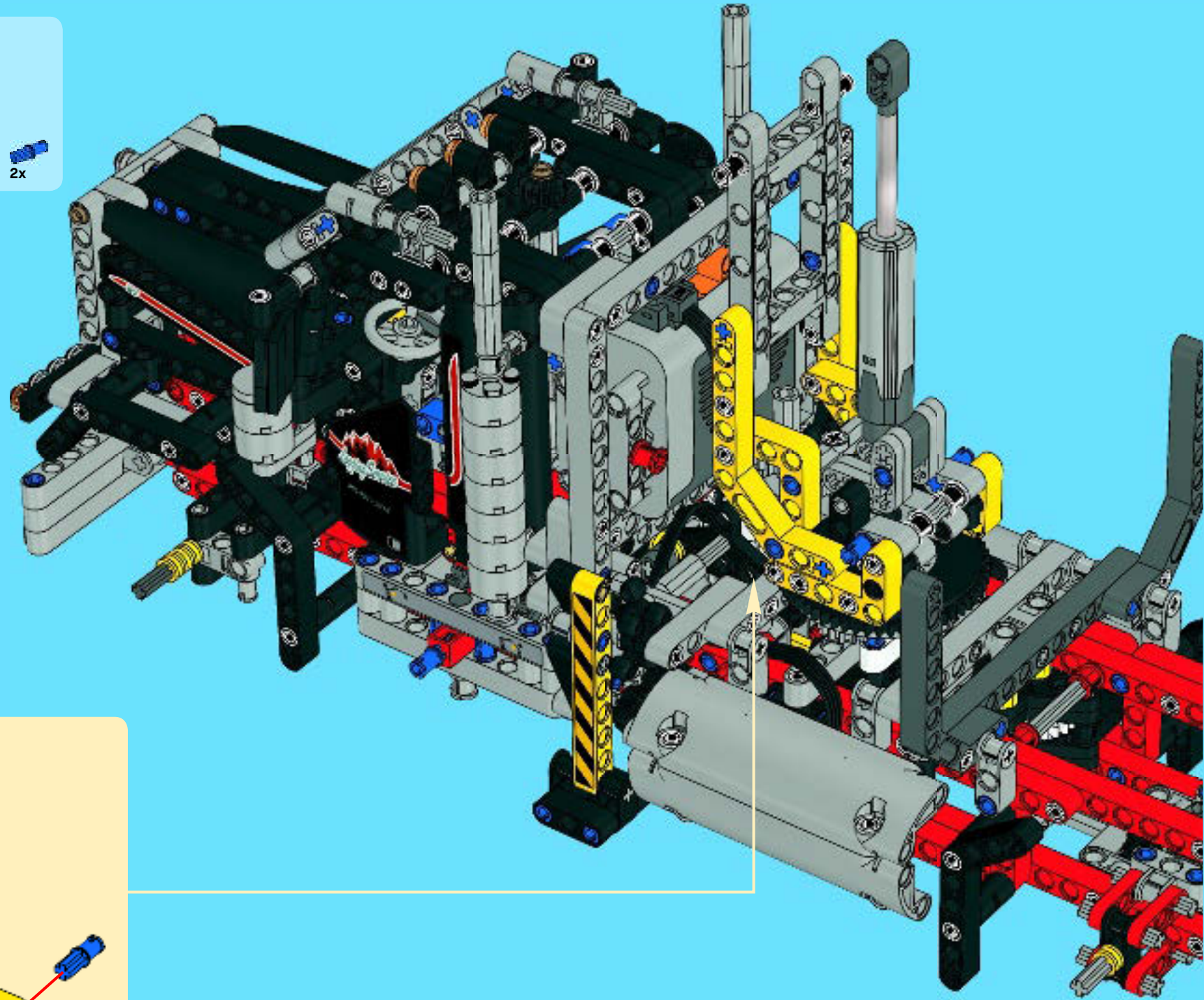





# 138

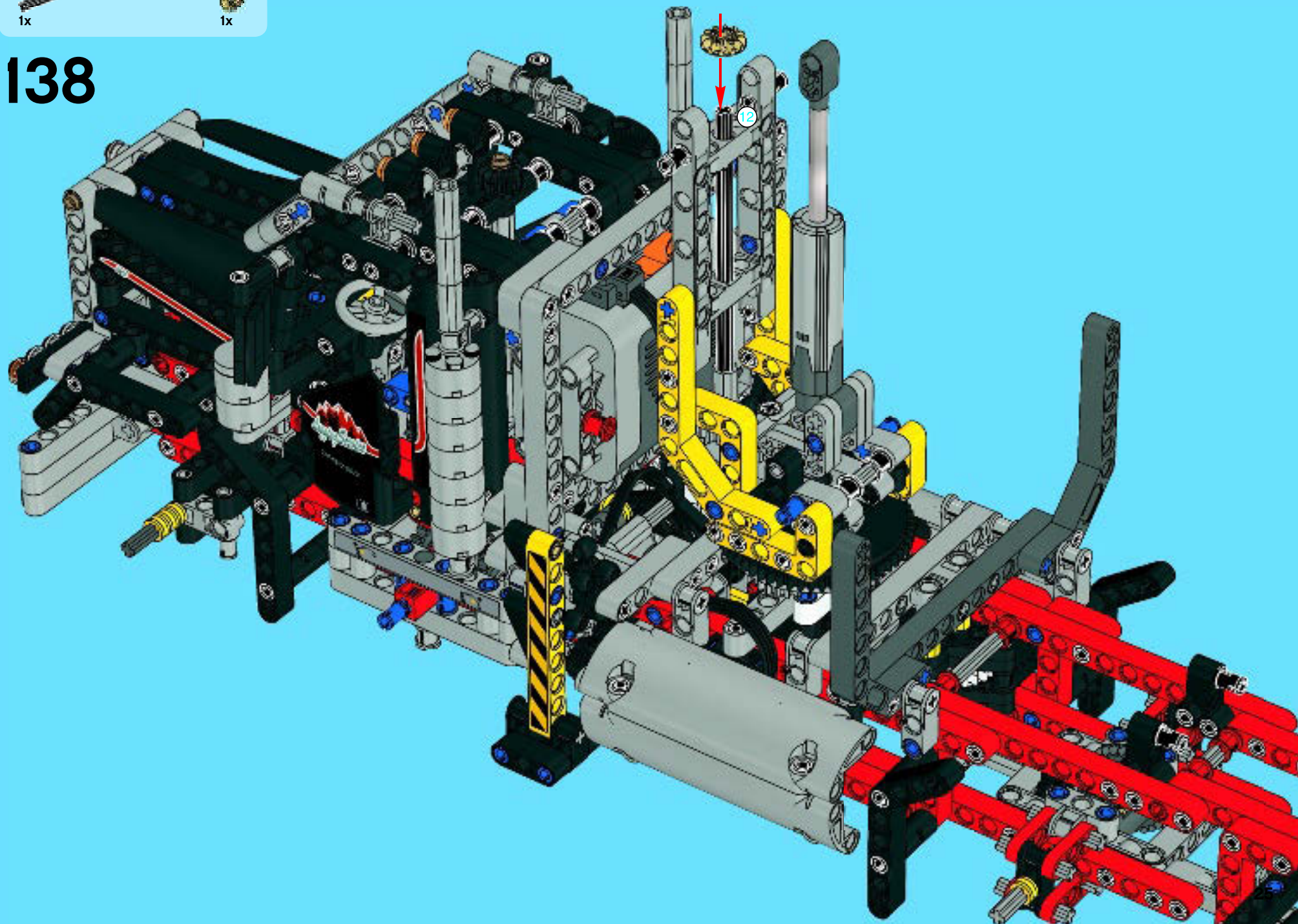

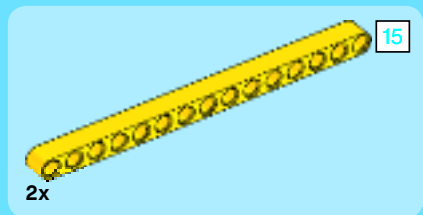

139

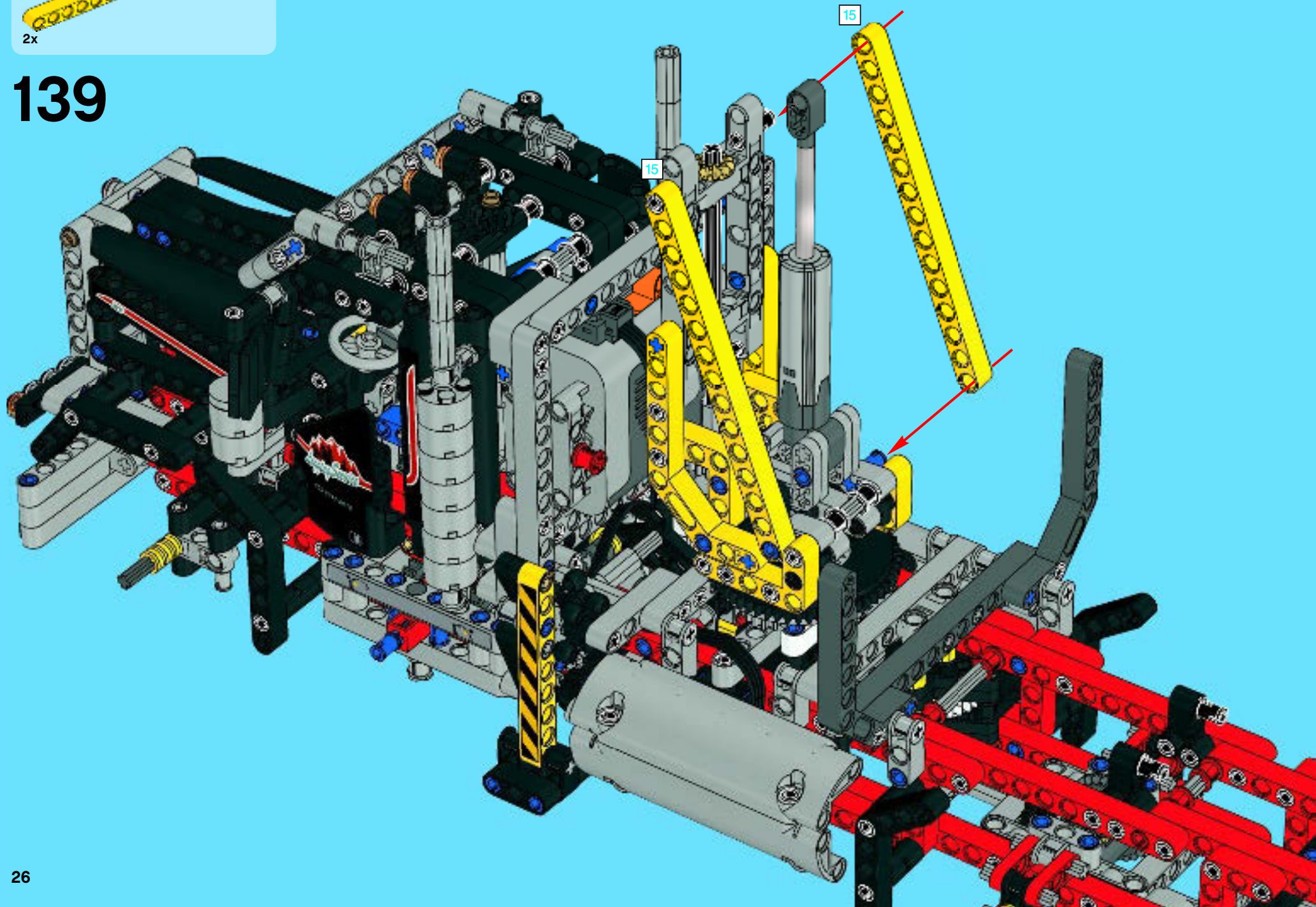

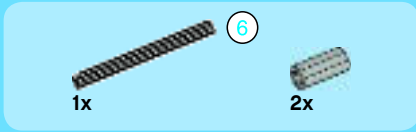
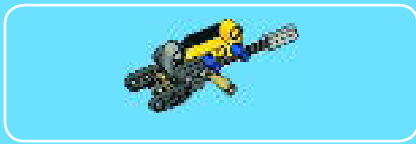

1

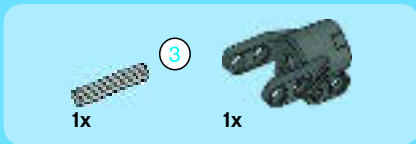
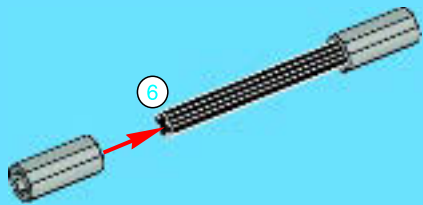

2

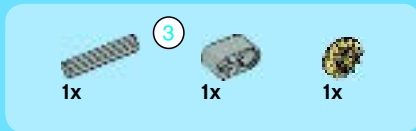
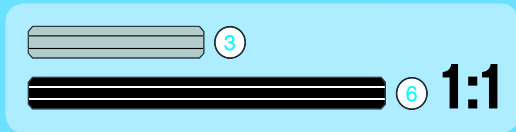
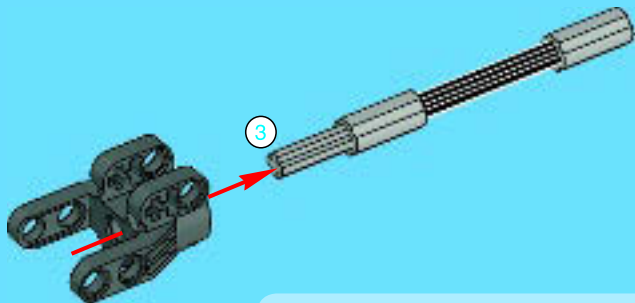

3

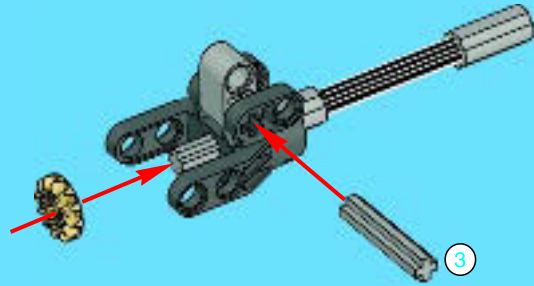

4

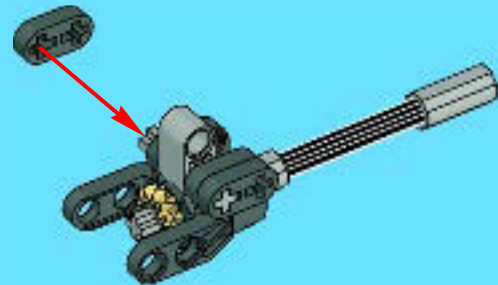

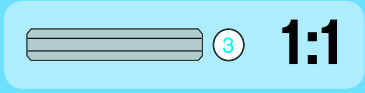

5

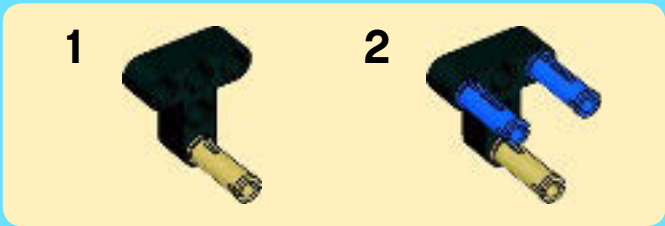
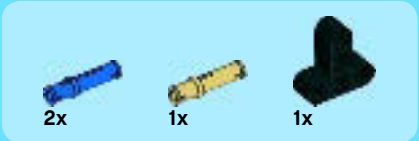
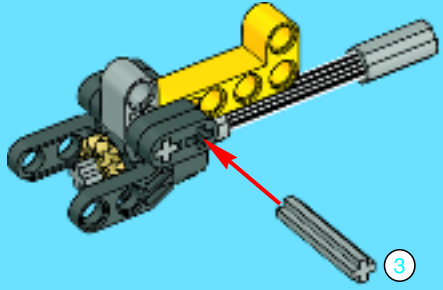

6

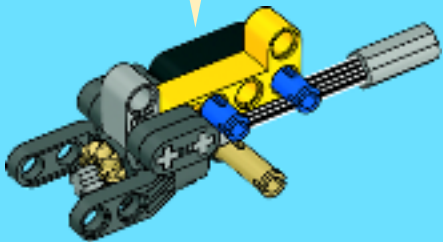

140

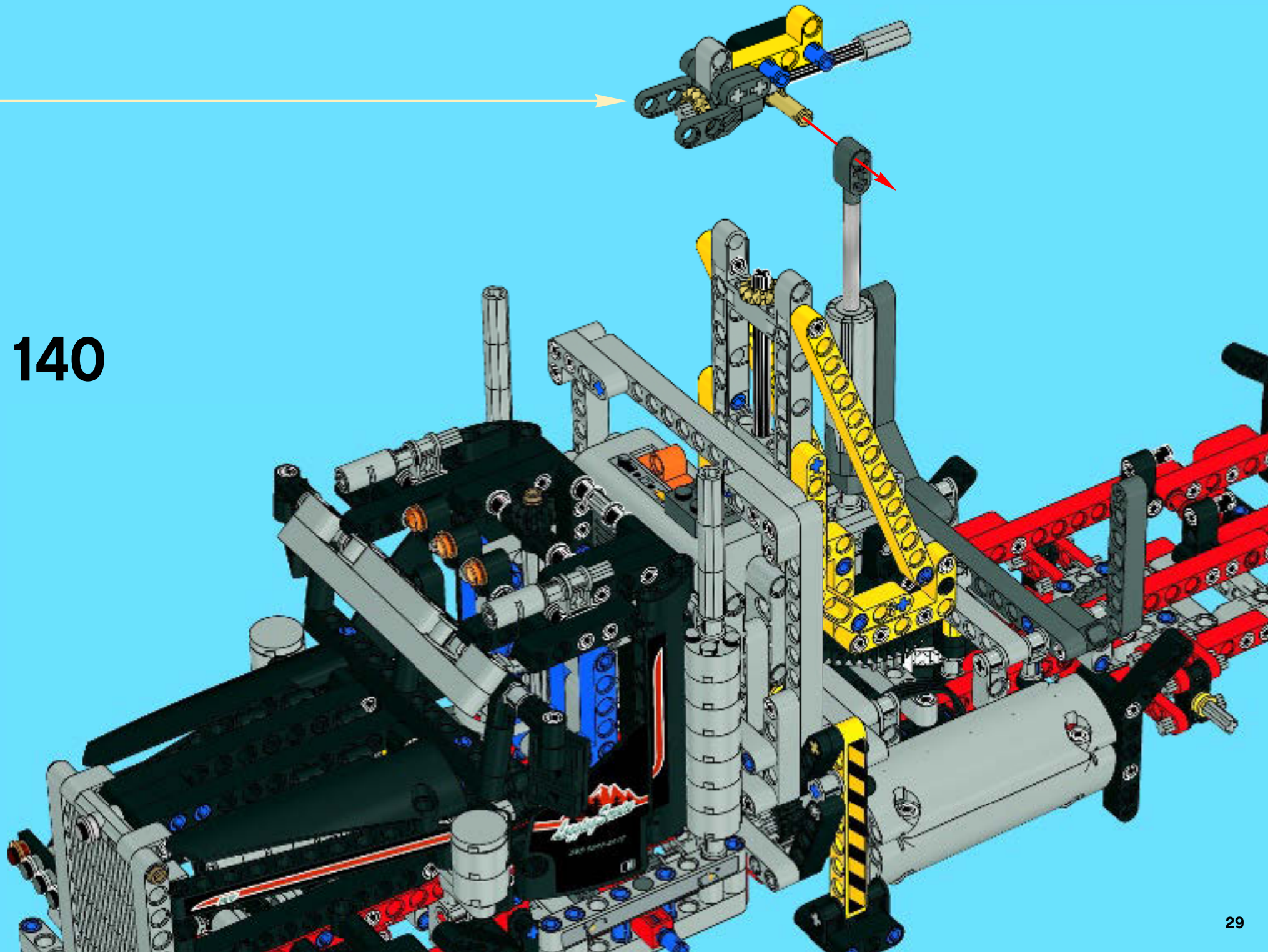



1x

# 141

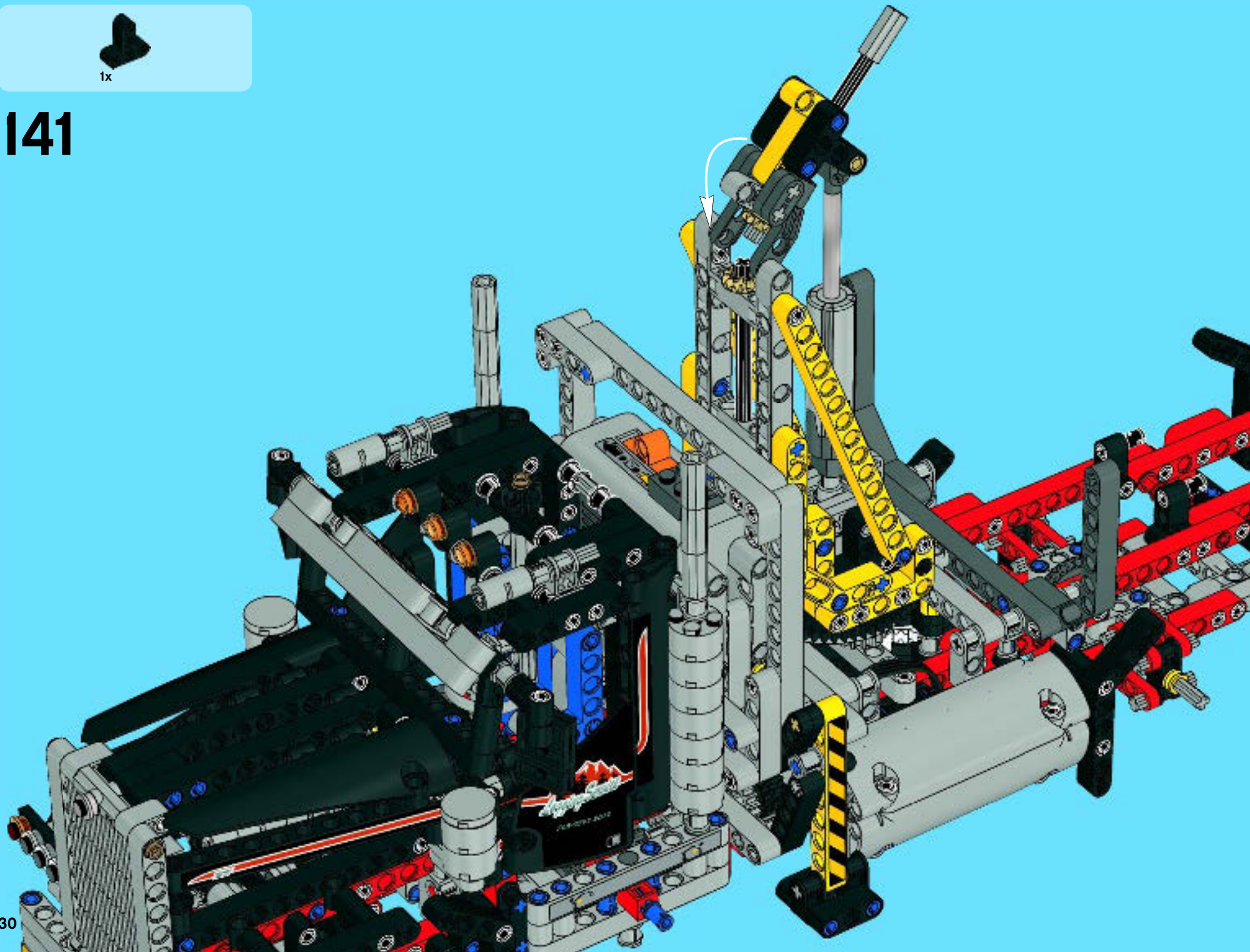



142

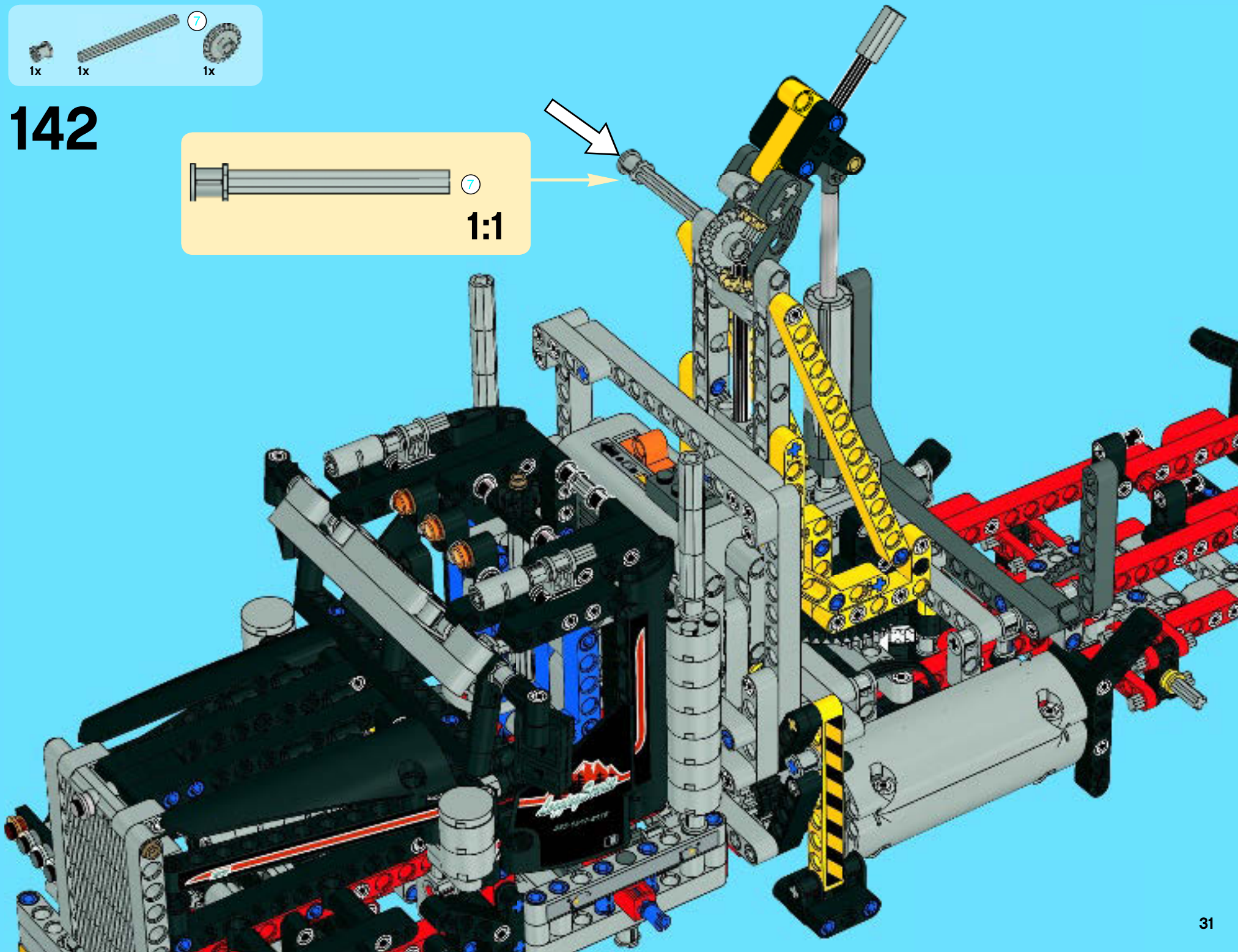
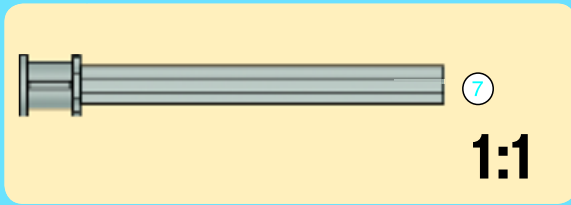



2x



2x

# 143

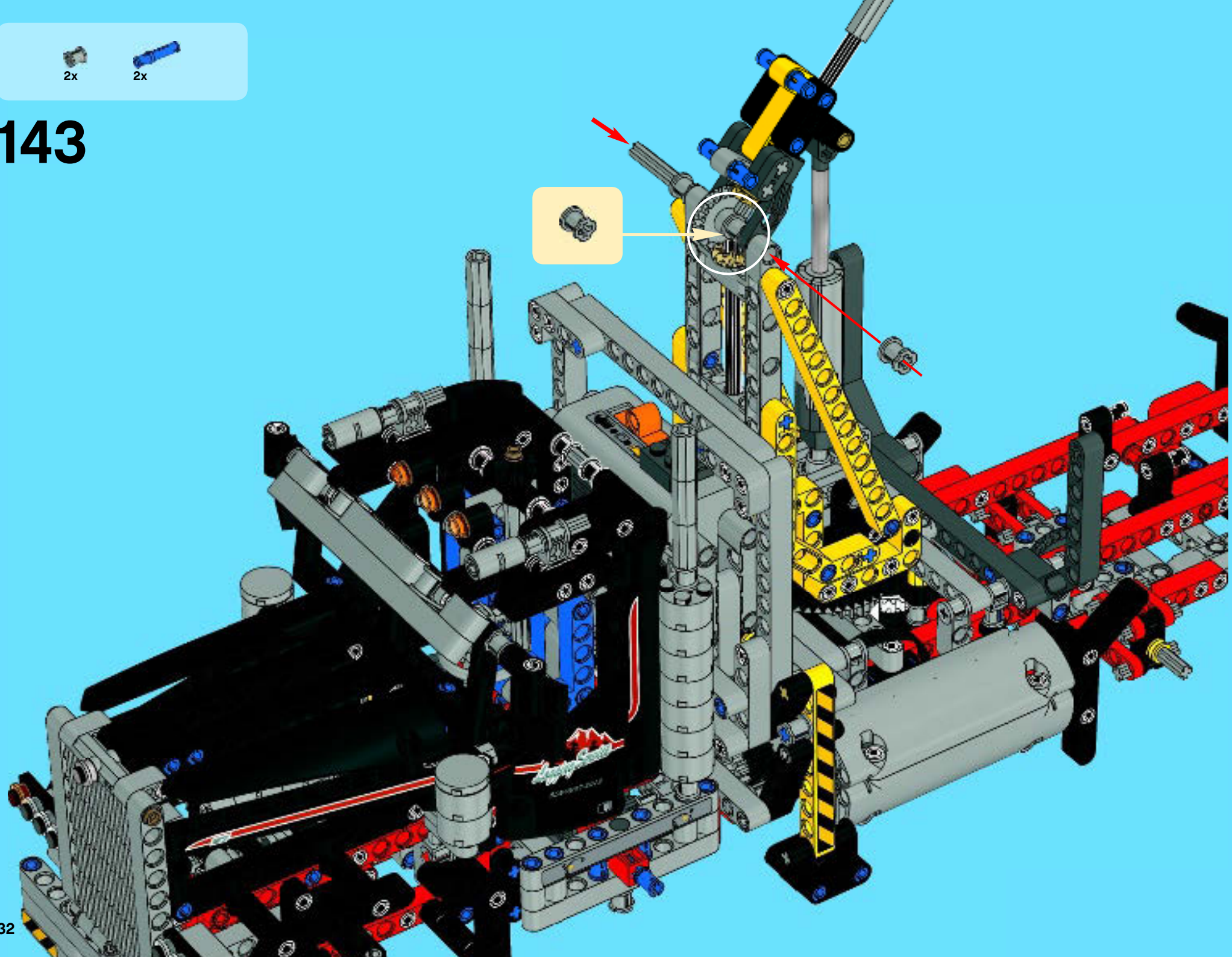



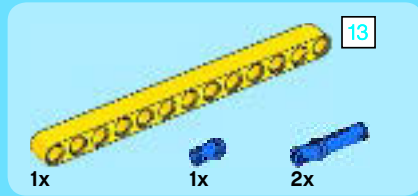
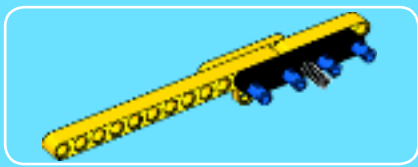

1

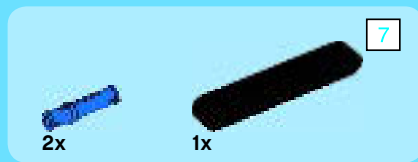
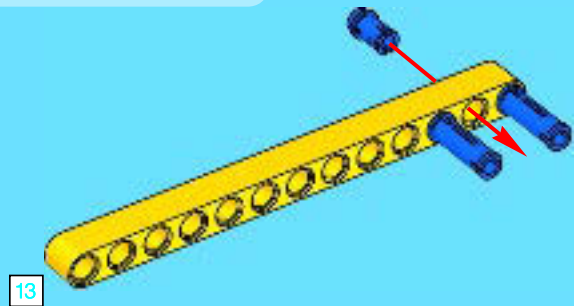

2

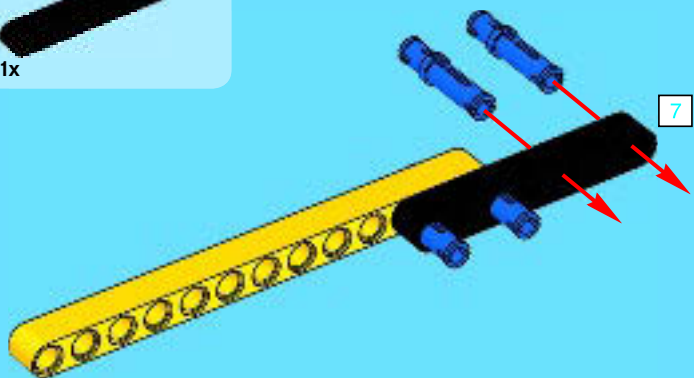

1:1

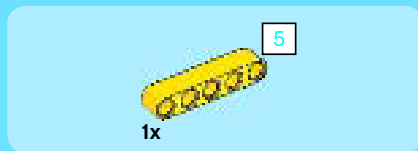

3

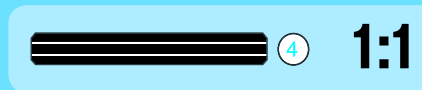
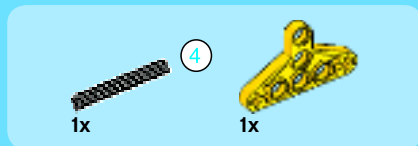
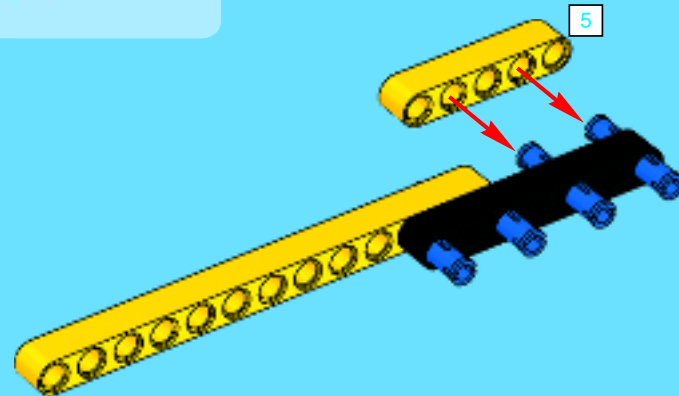

4

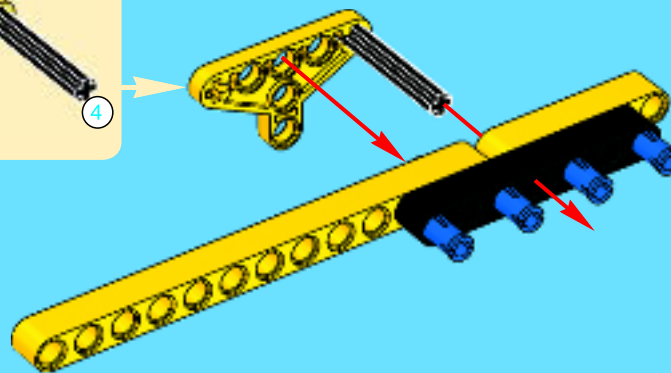
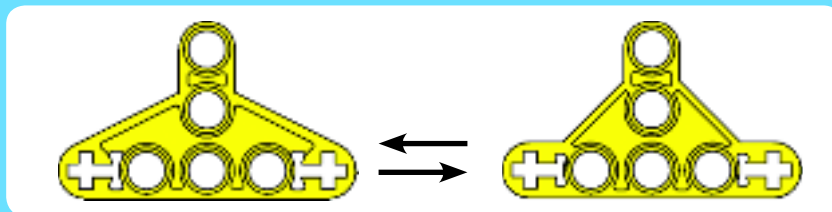

144

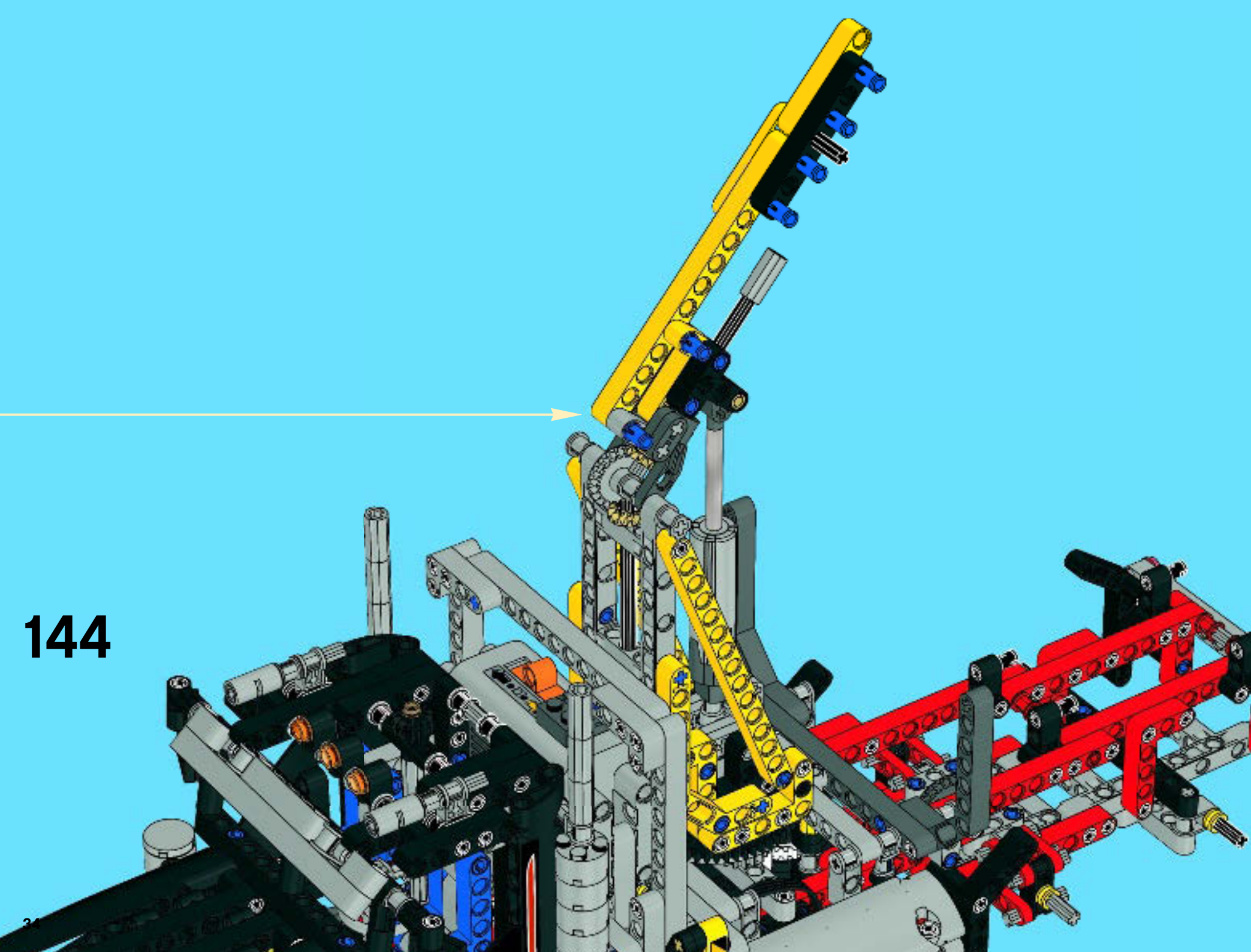

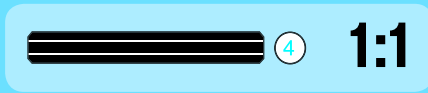
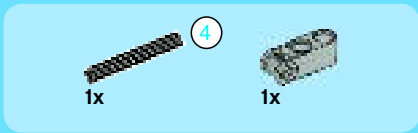

# 145

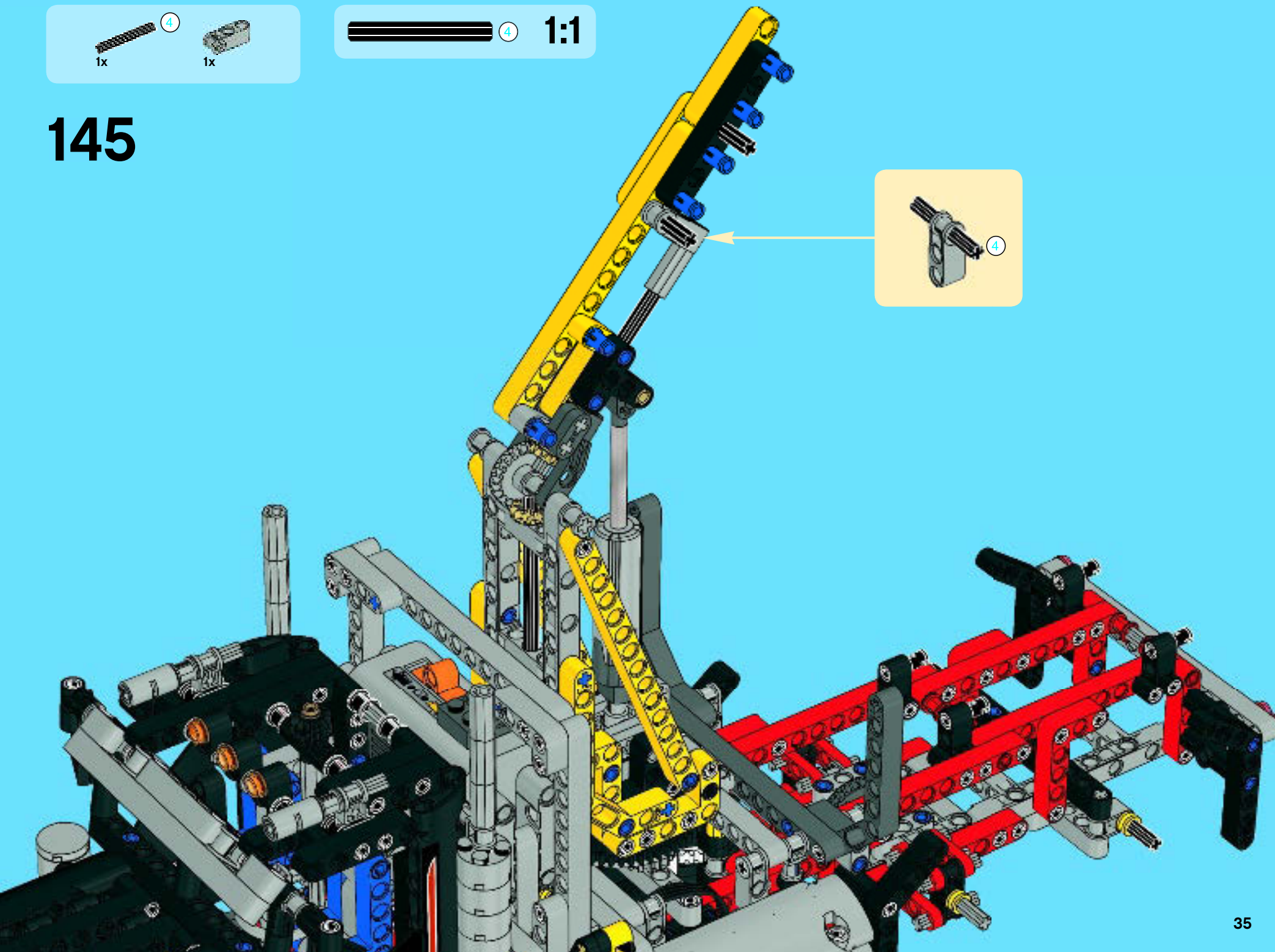
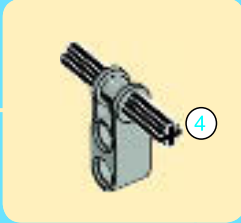

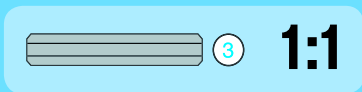
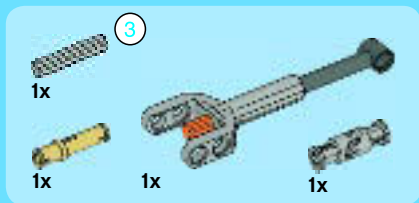

# 146

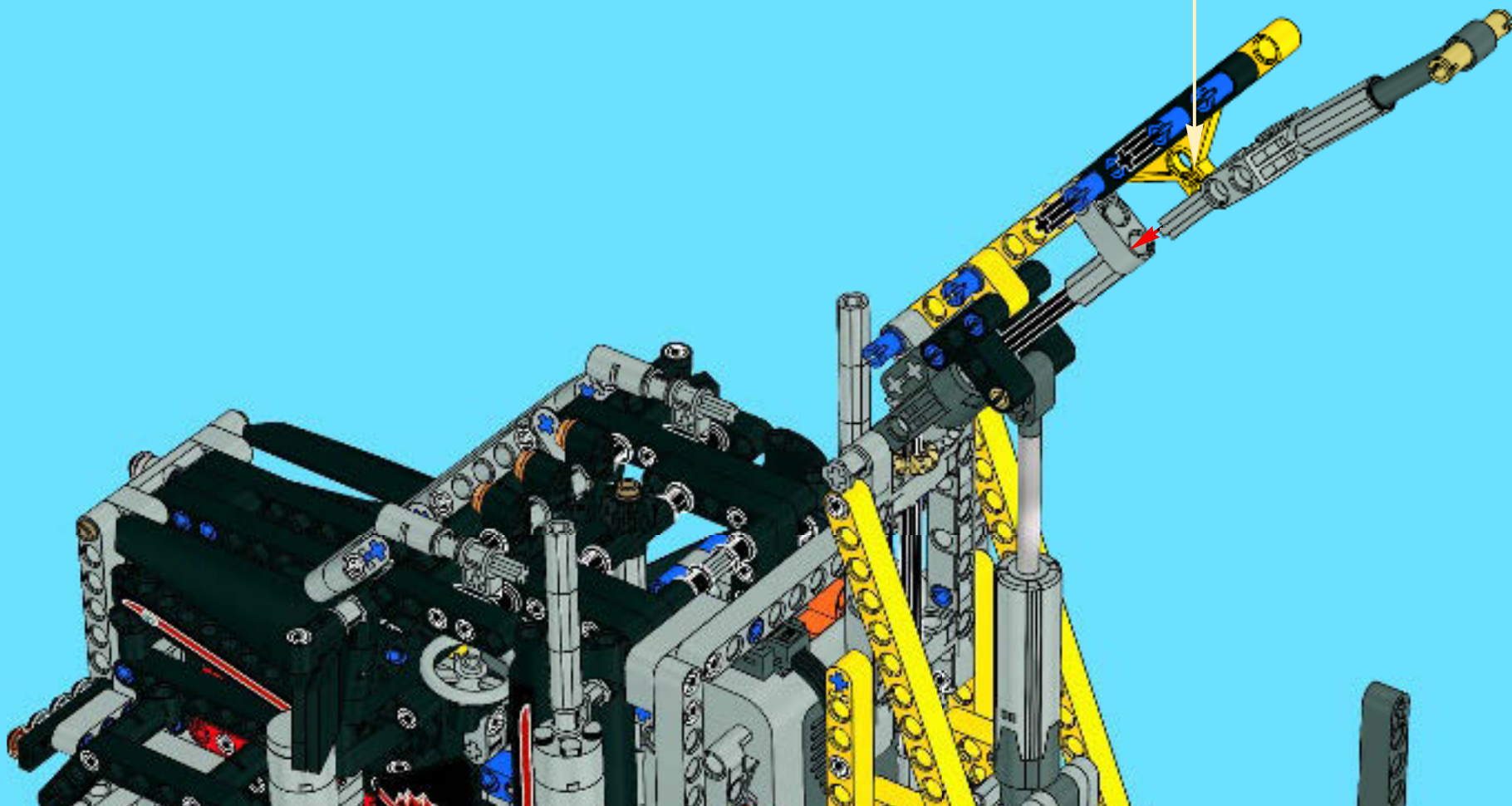
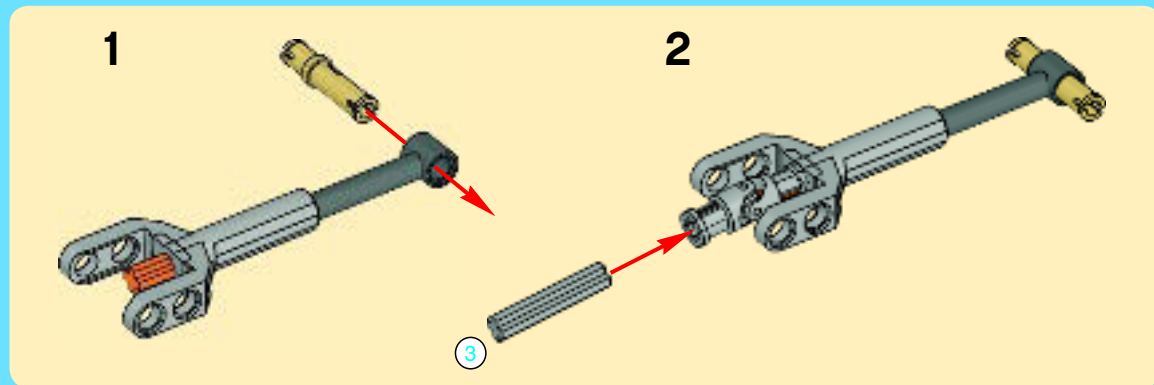

1x

147

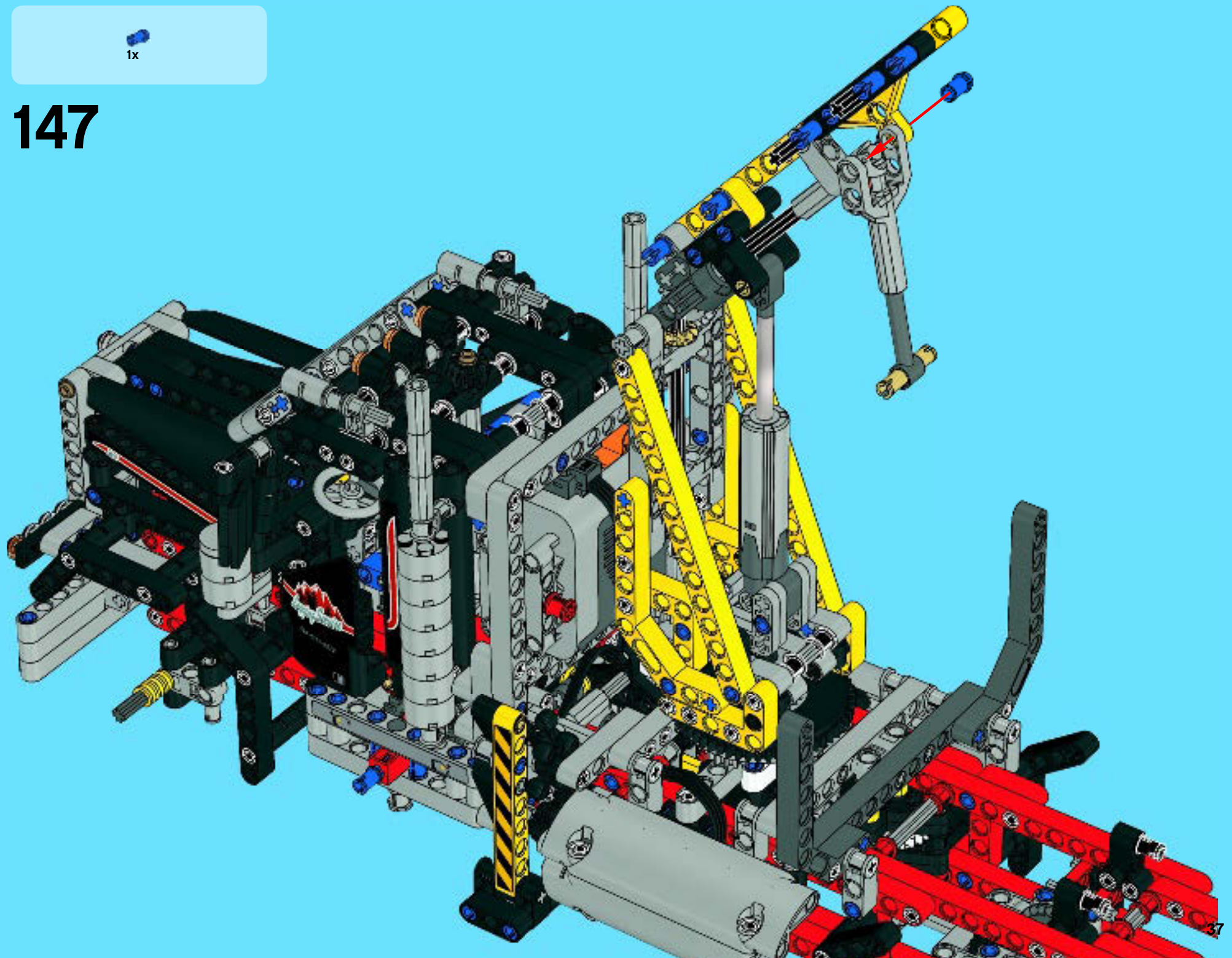

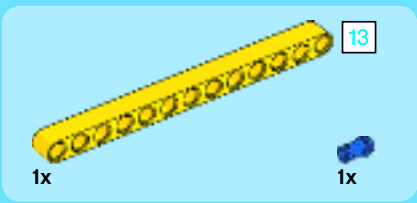

# 148

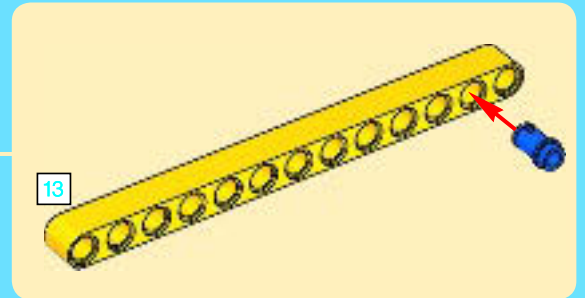
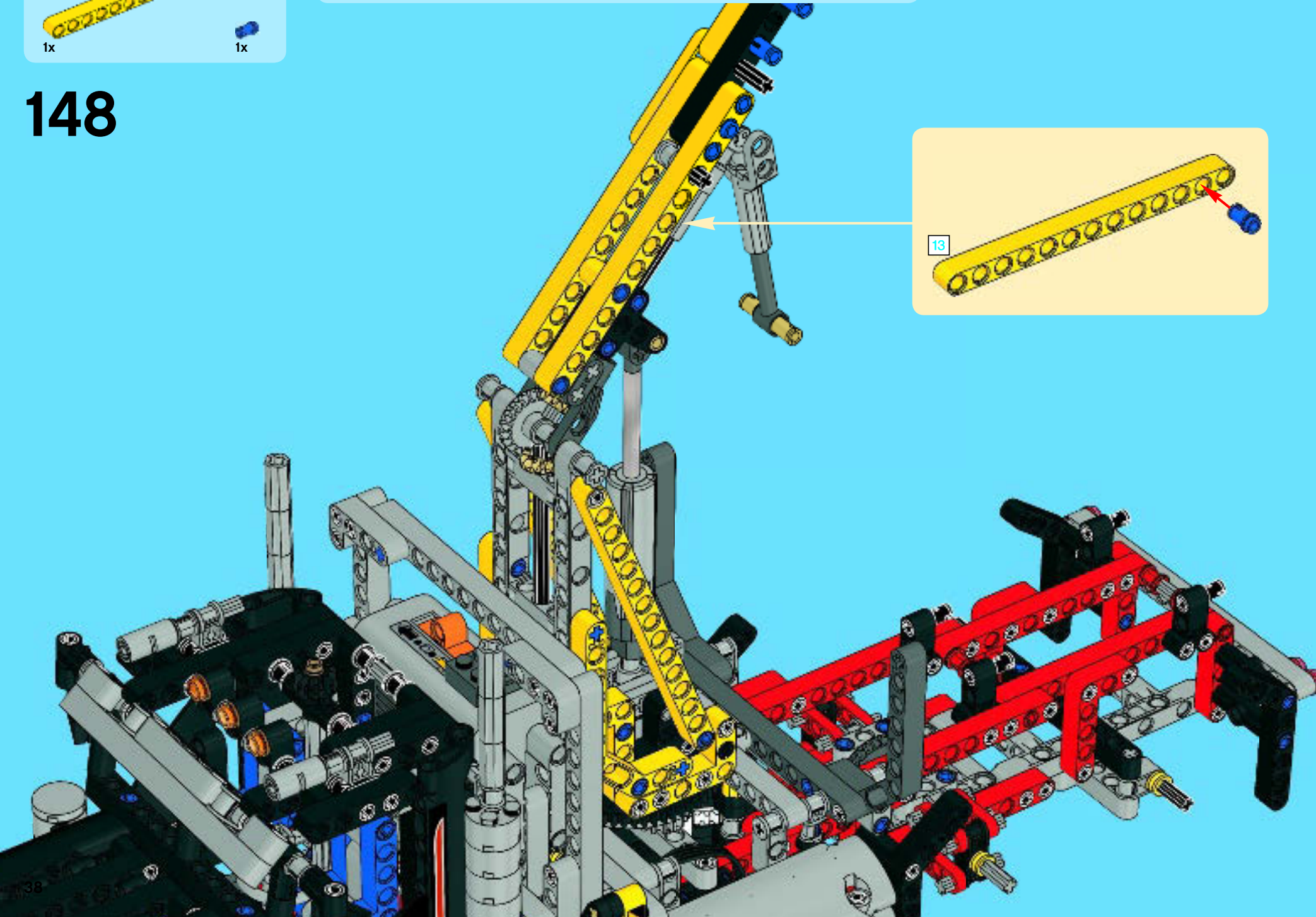



1

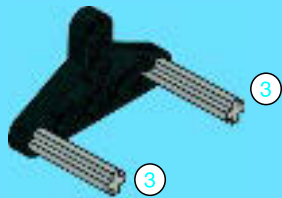

2

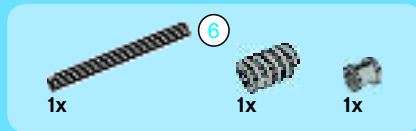
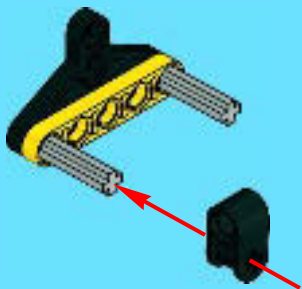

3

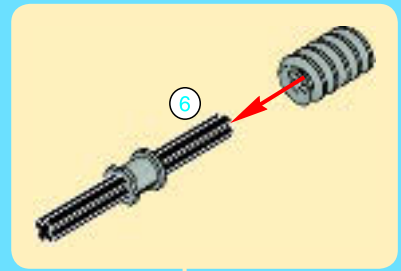

4

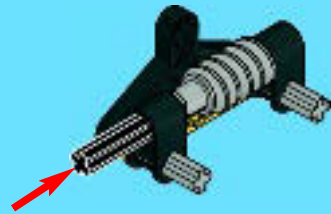

5

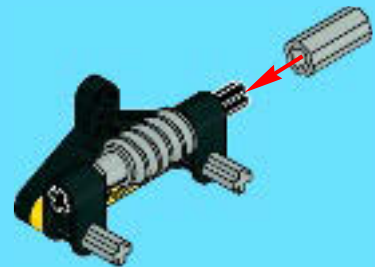

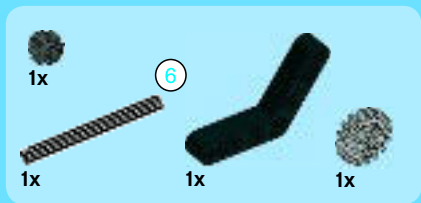

6

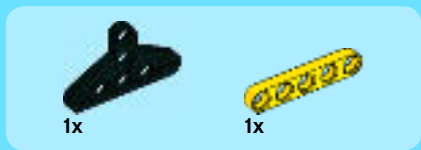
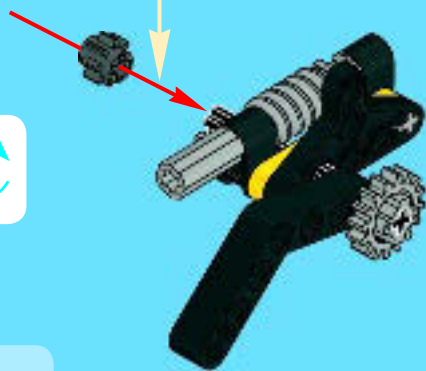
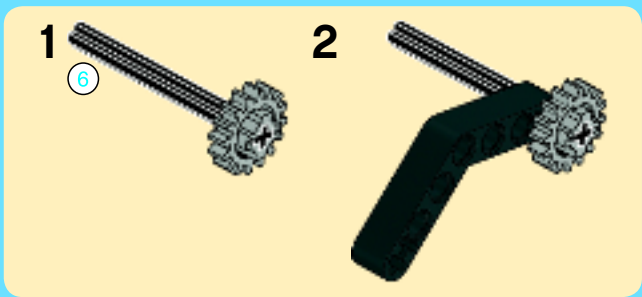

7

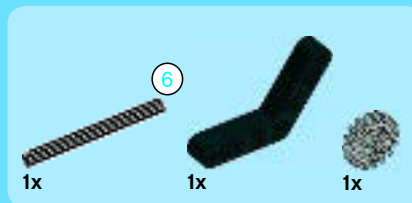
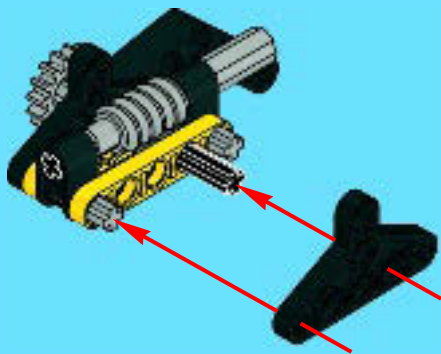

8

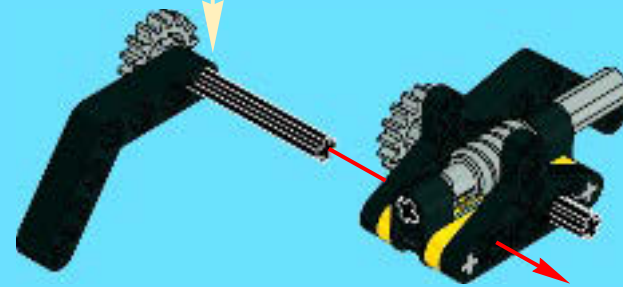
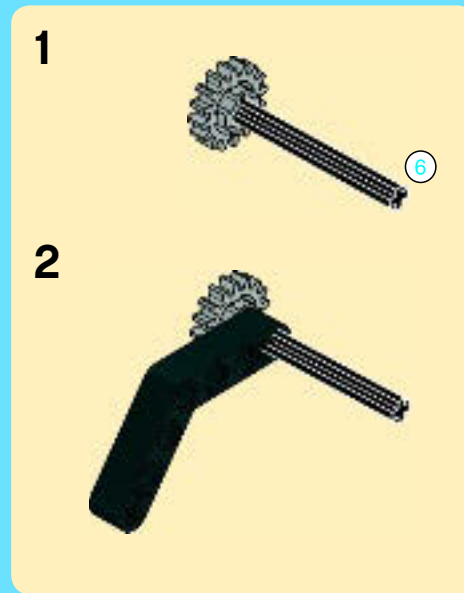





9

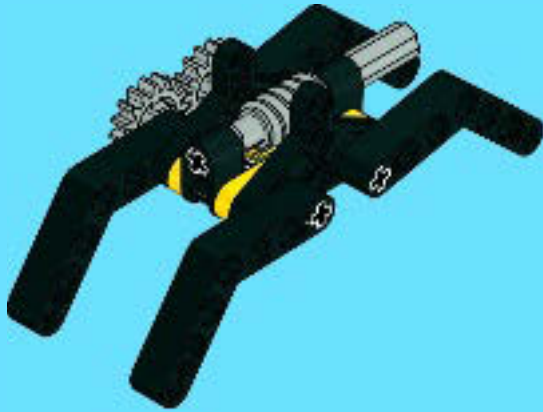

10

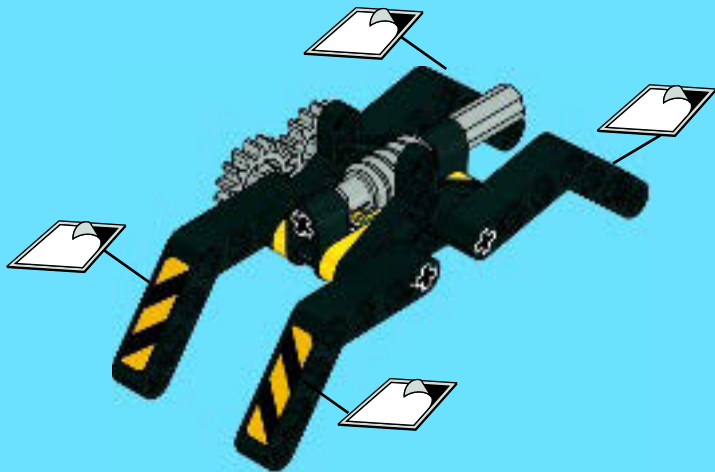

11

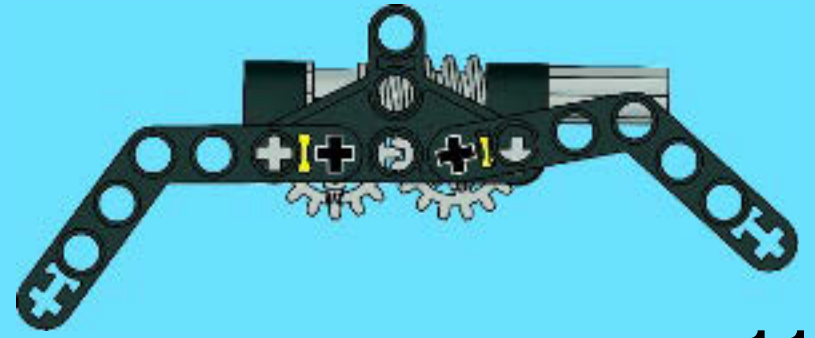

1:1

12

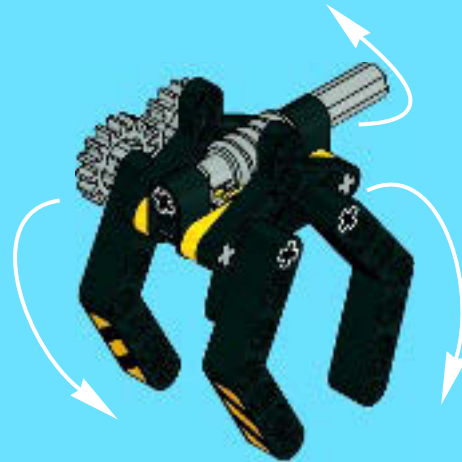



1

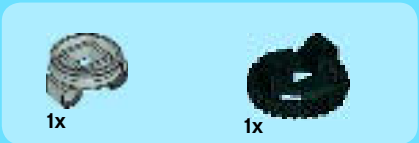

2

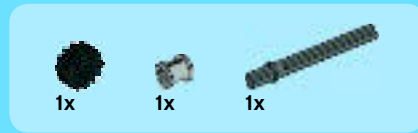
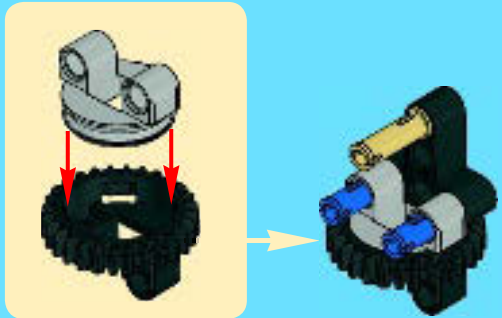

3

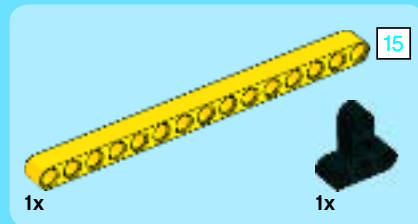
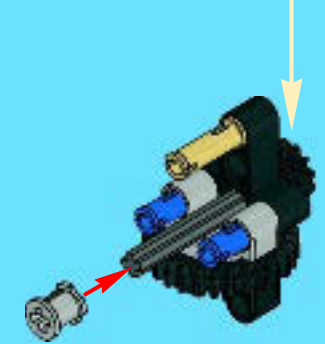
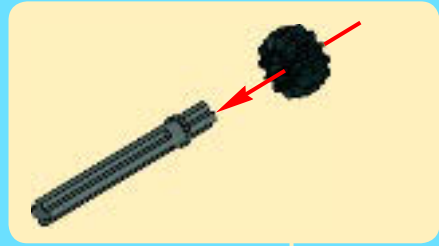

4

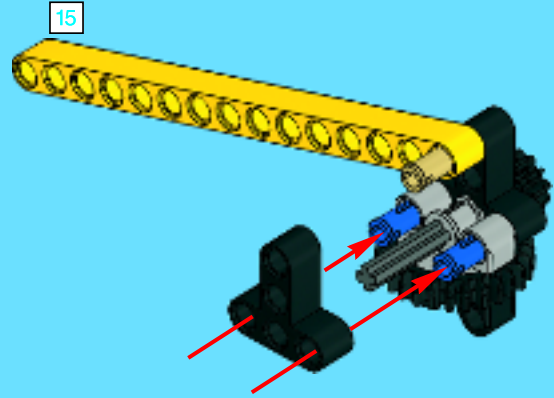

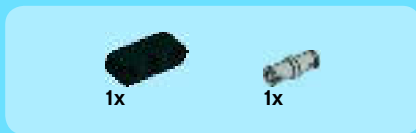
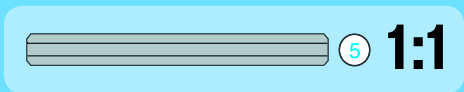
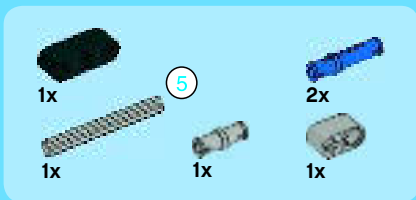

5

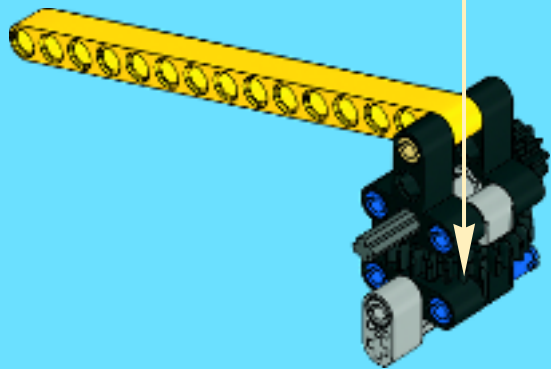
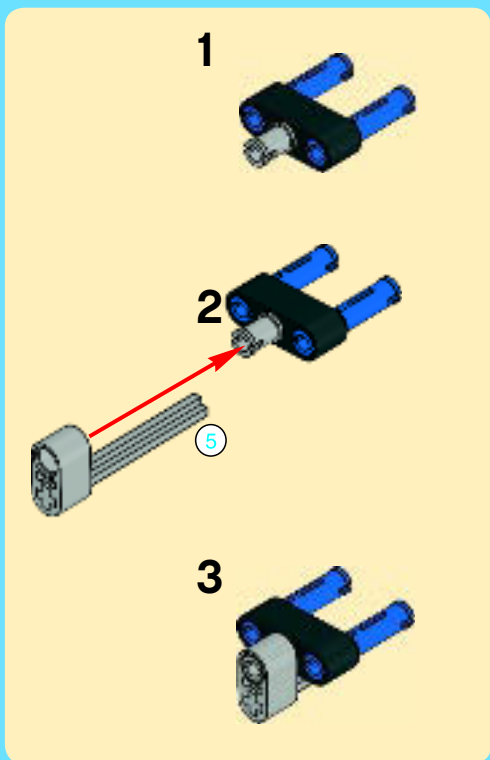

6

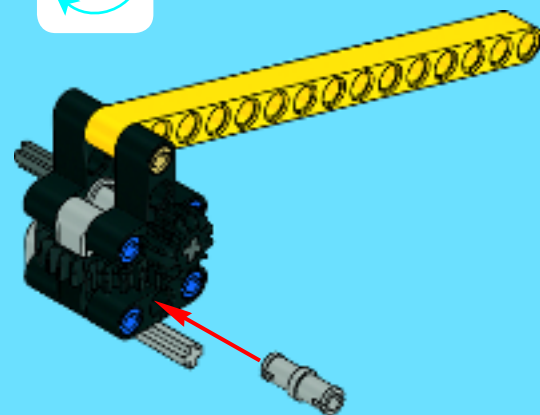



1x

7

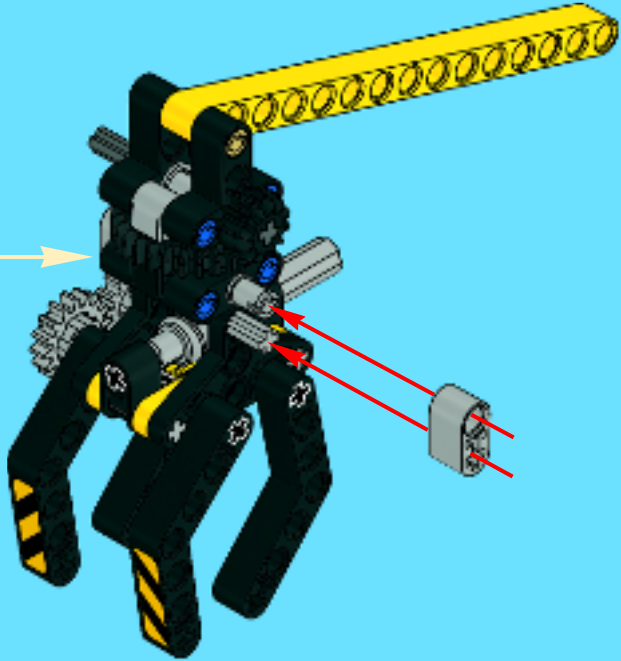

1x



1x



1x

8

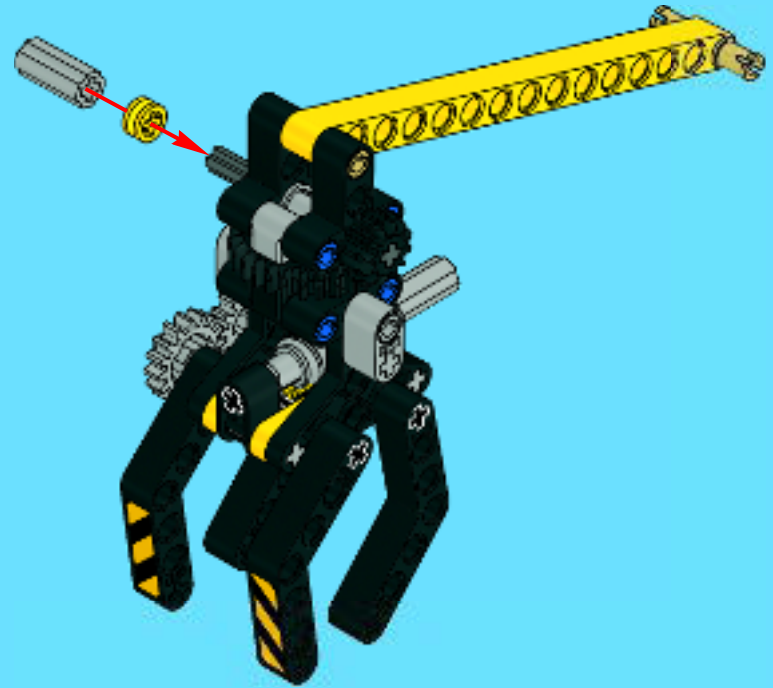

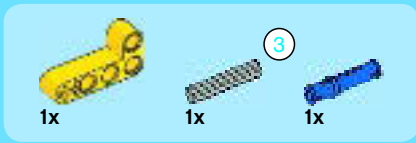

9

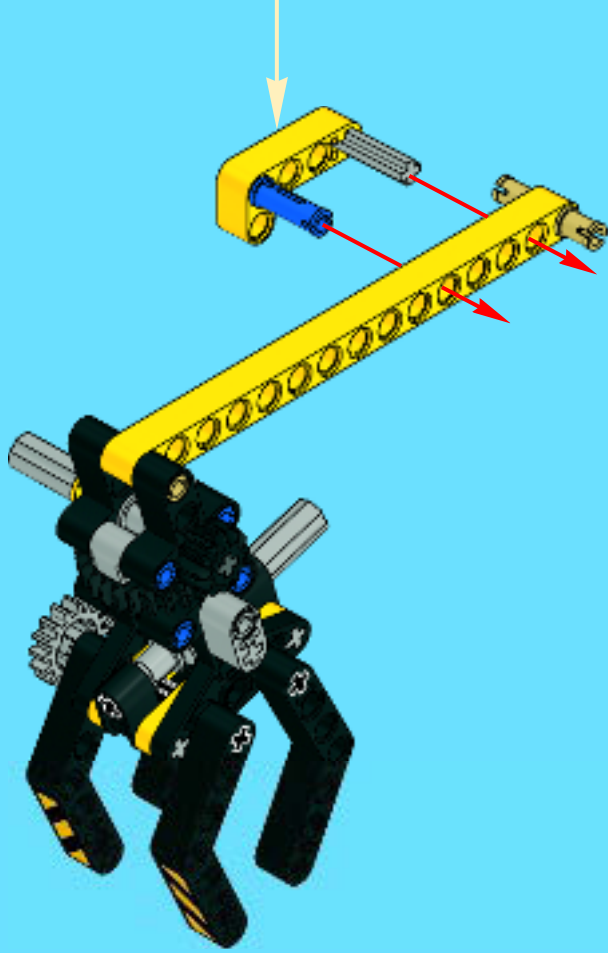
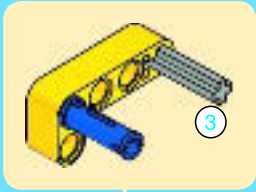

10

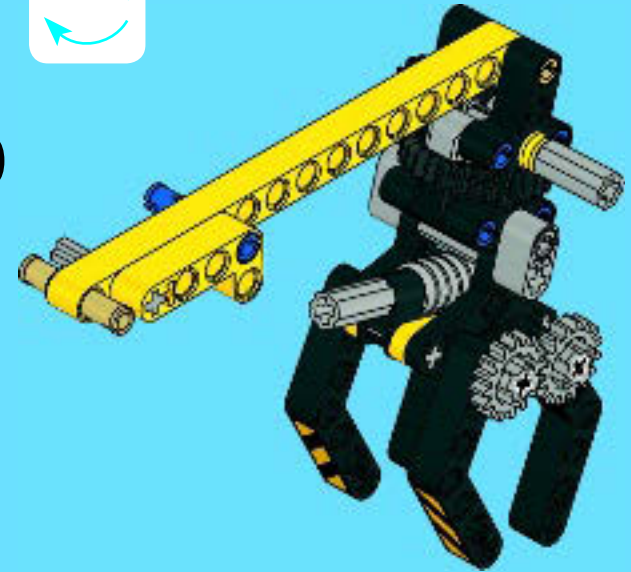

148

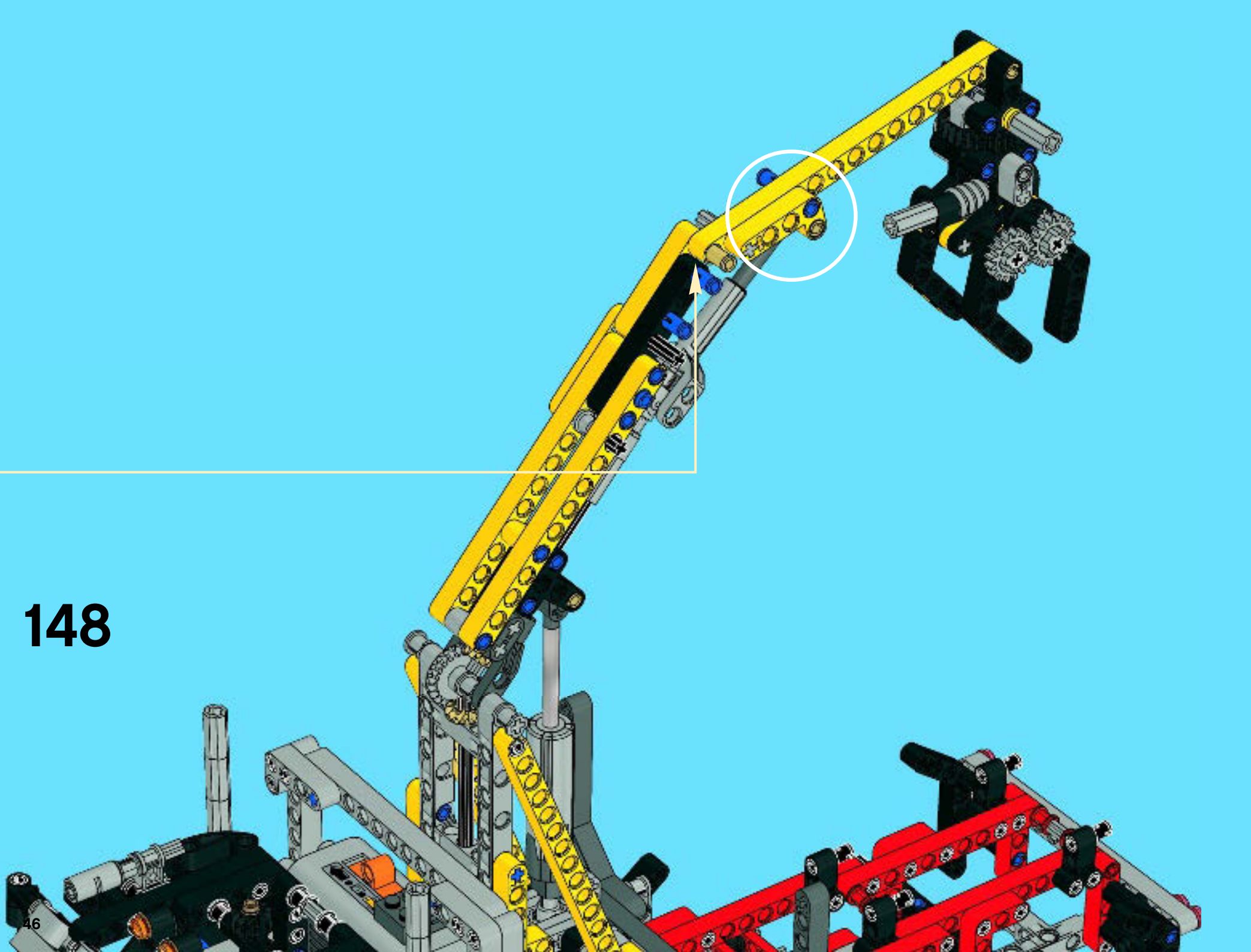



1x

# 149



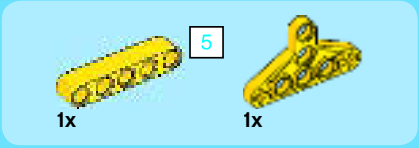

150

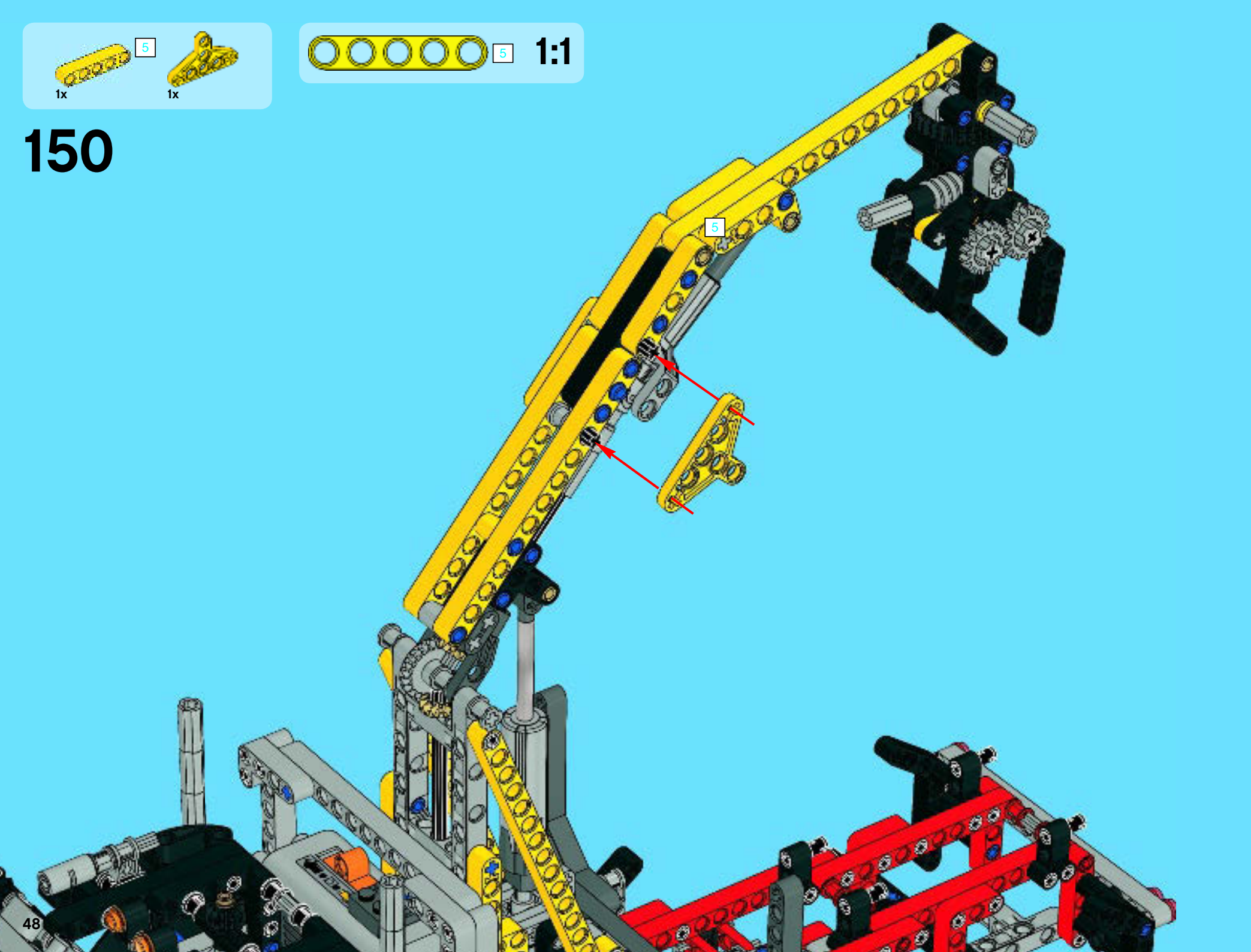





1x

# 151

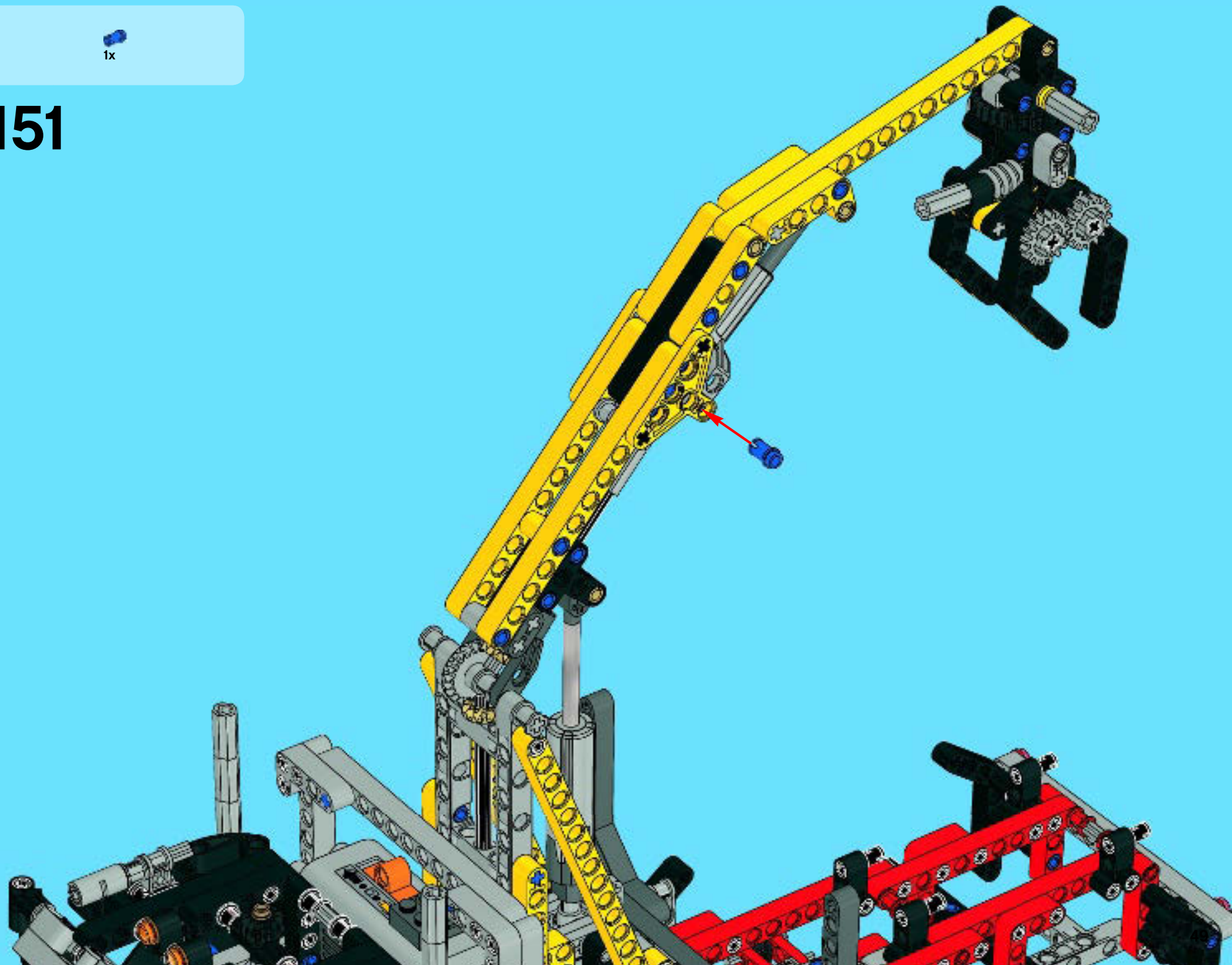

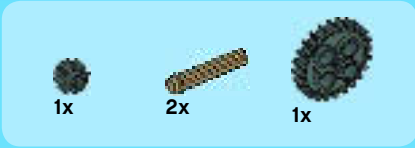

152

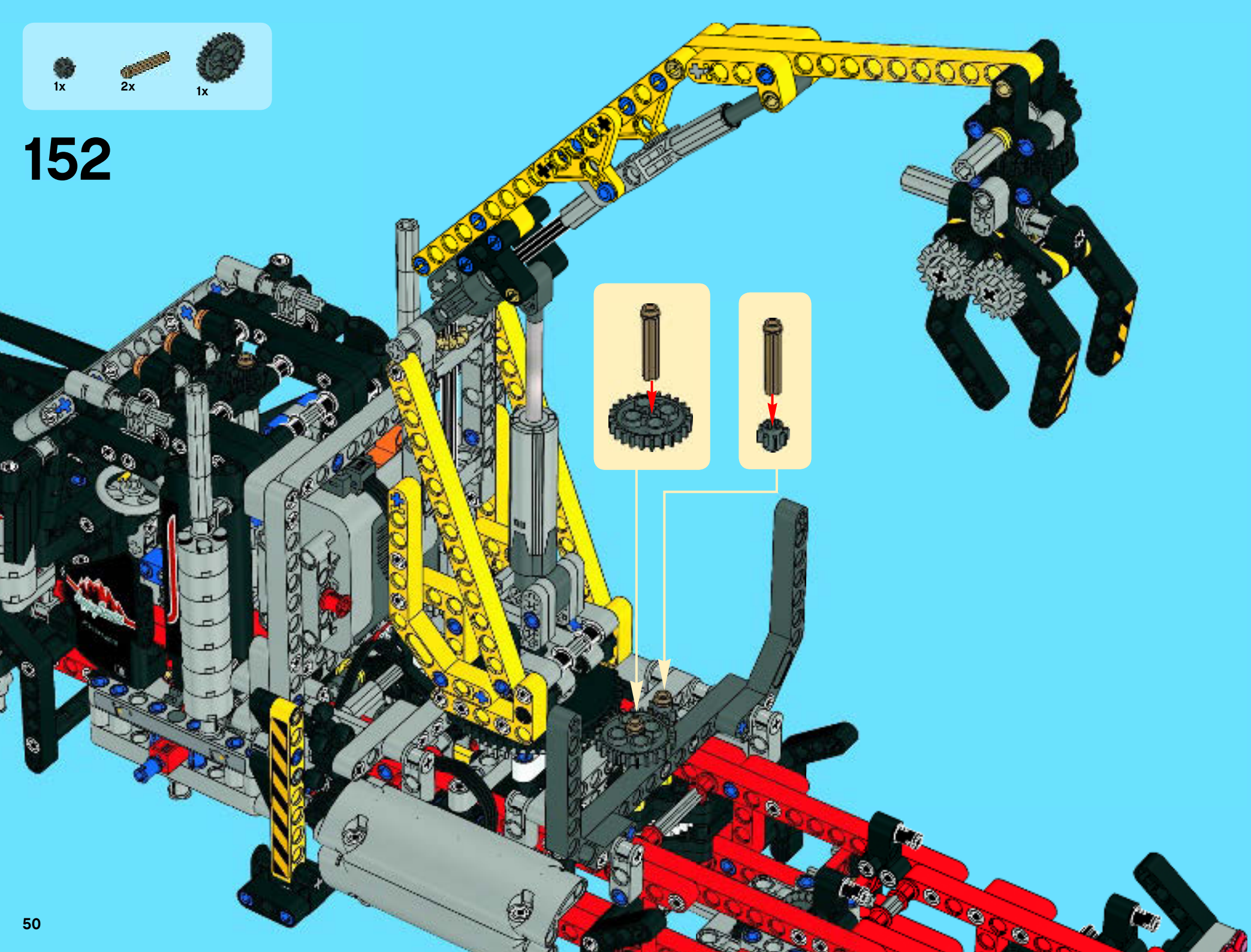

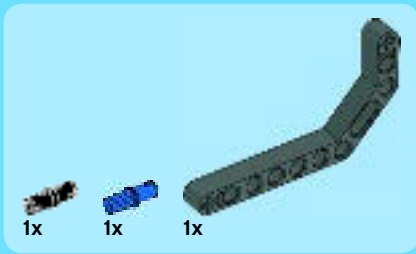
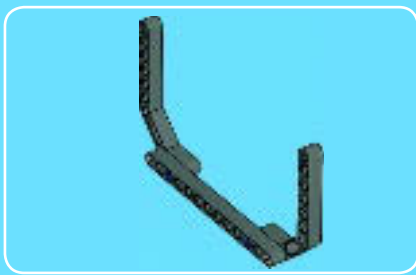

1

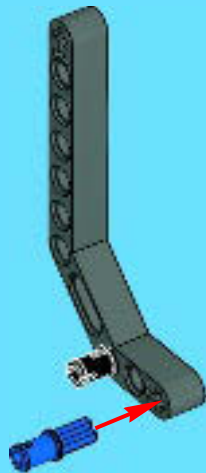

2

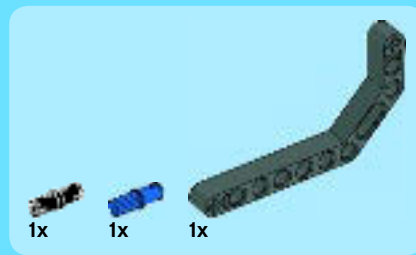
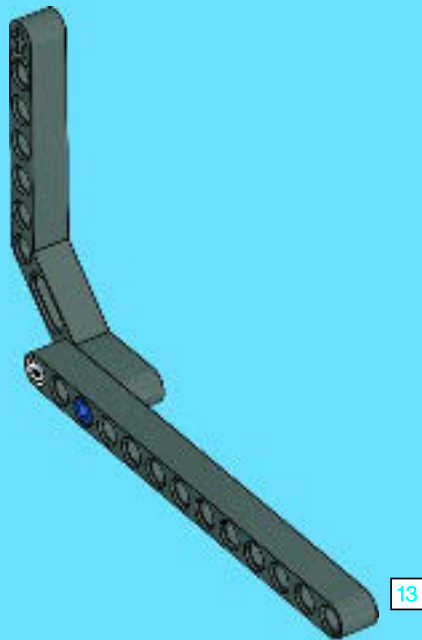

3

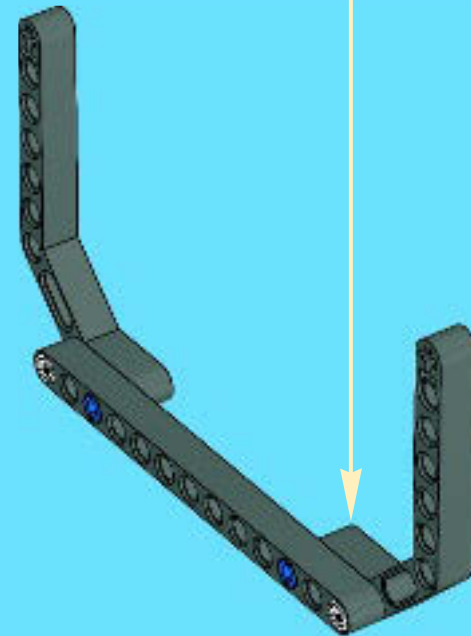
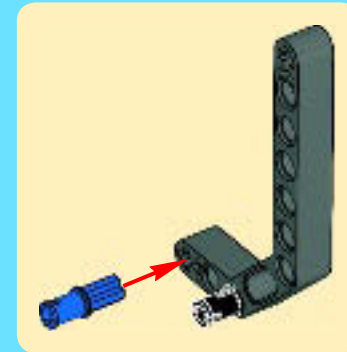

2x



1:1

153

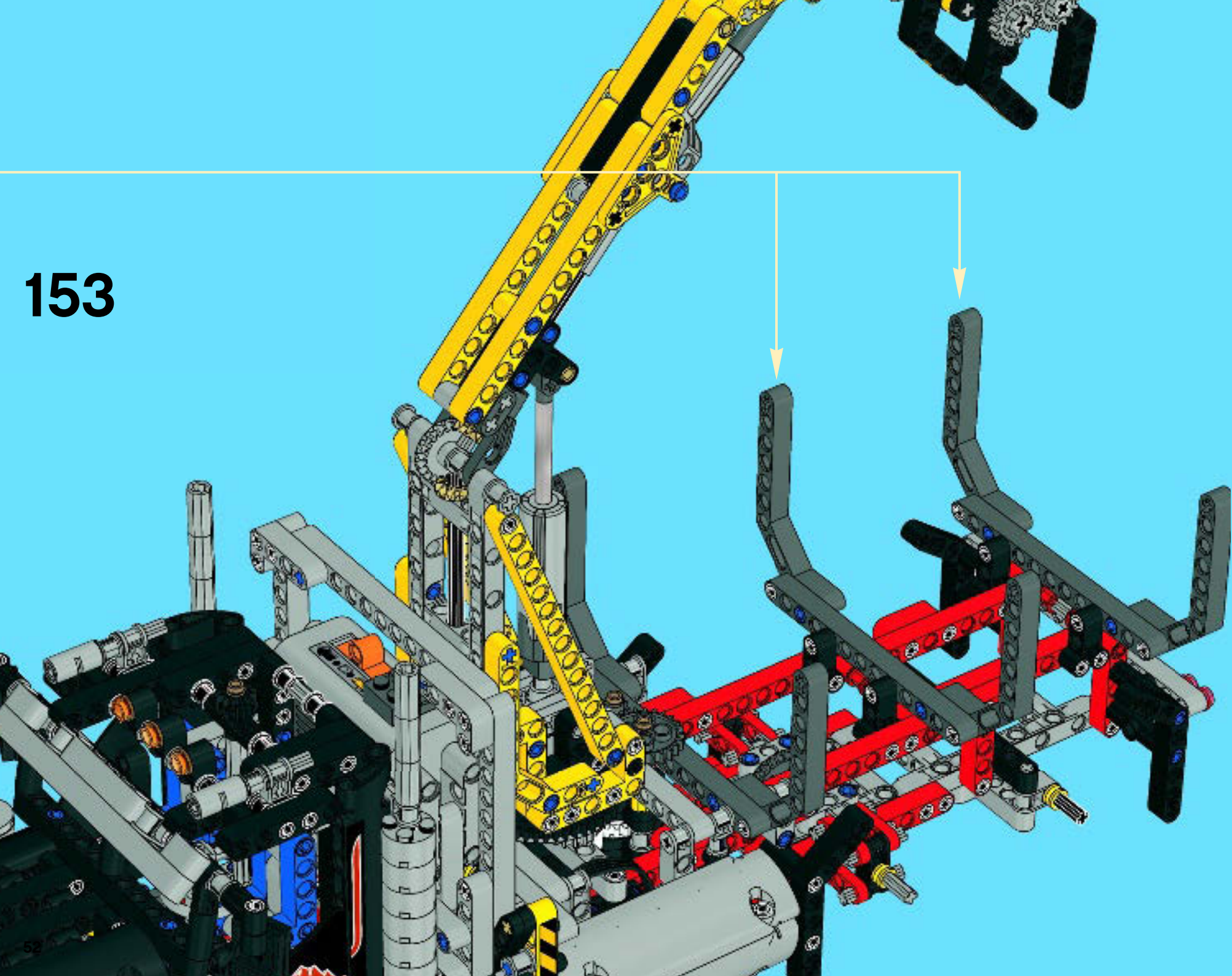



154

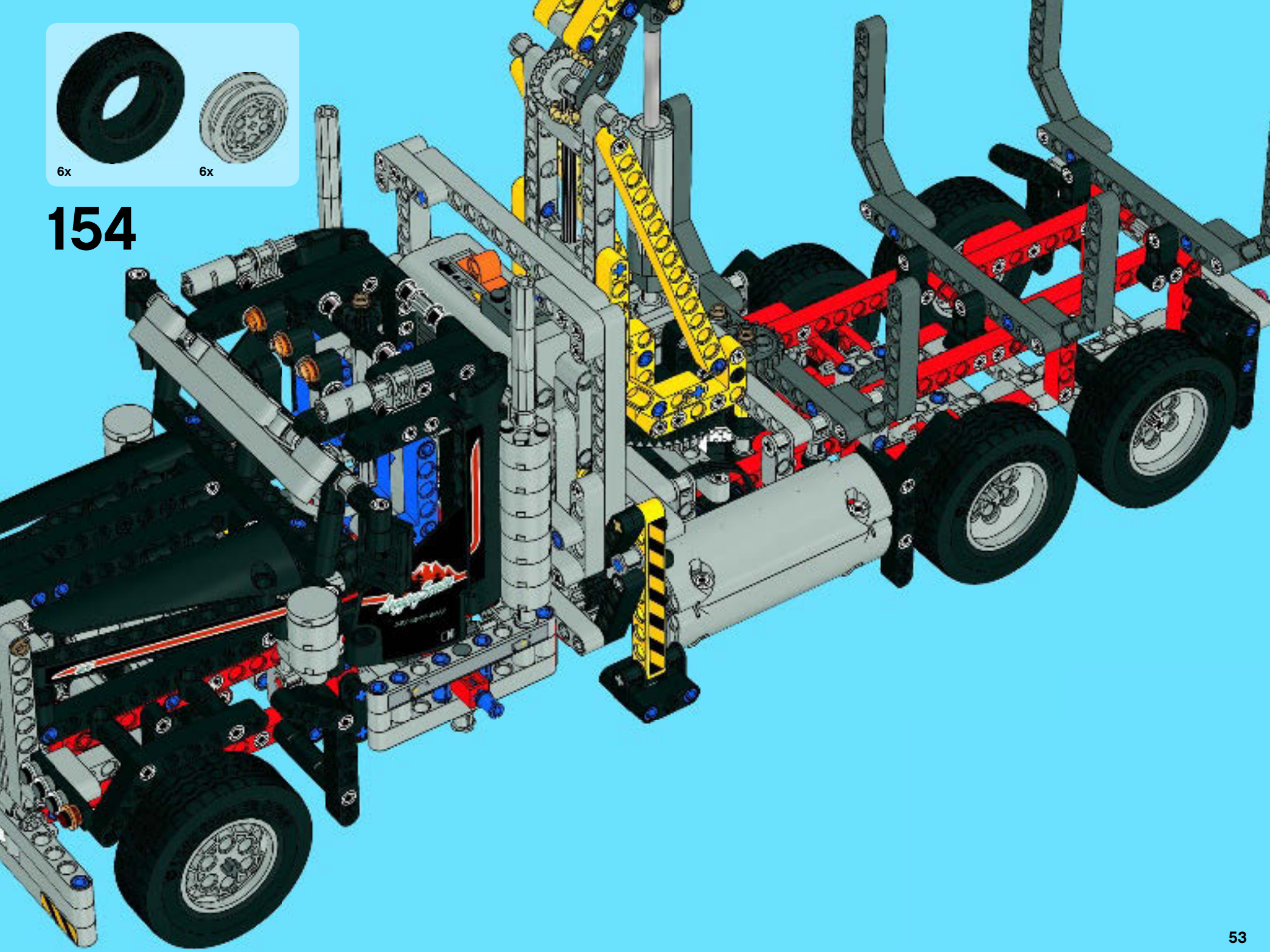

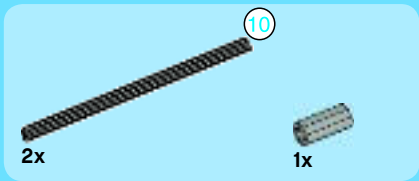

1

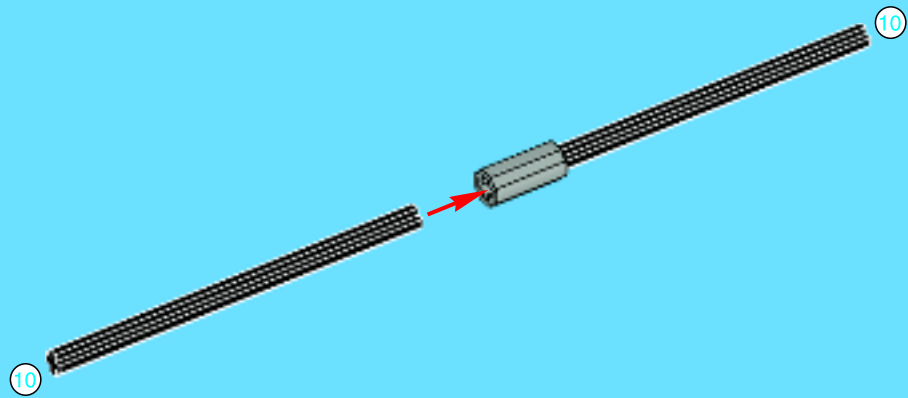

2

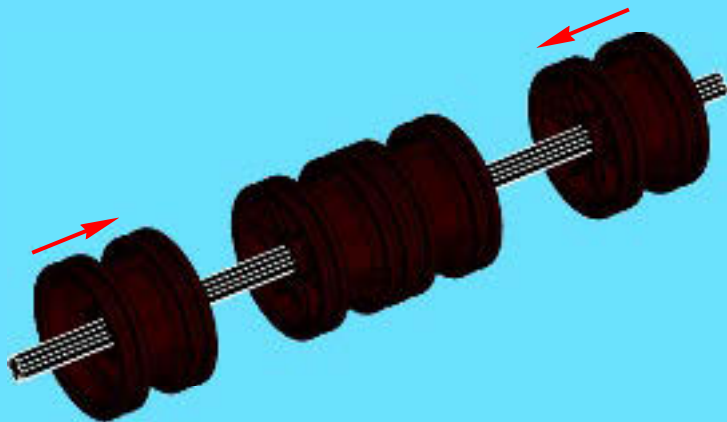

3

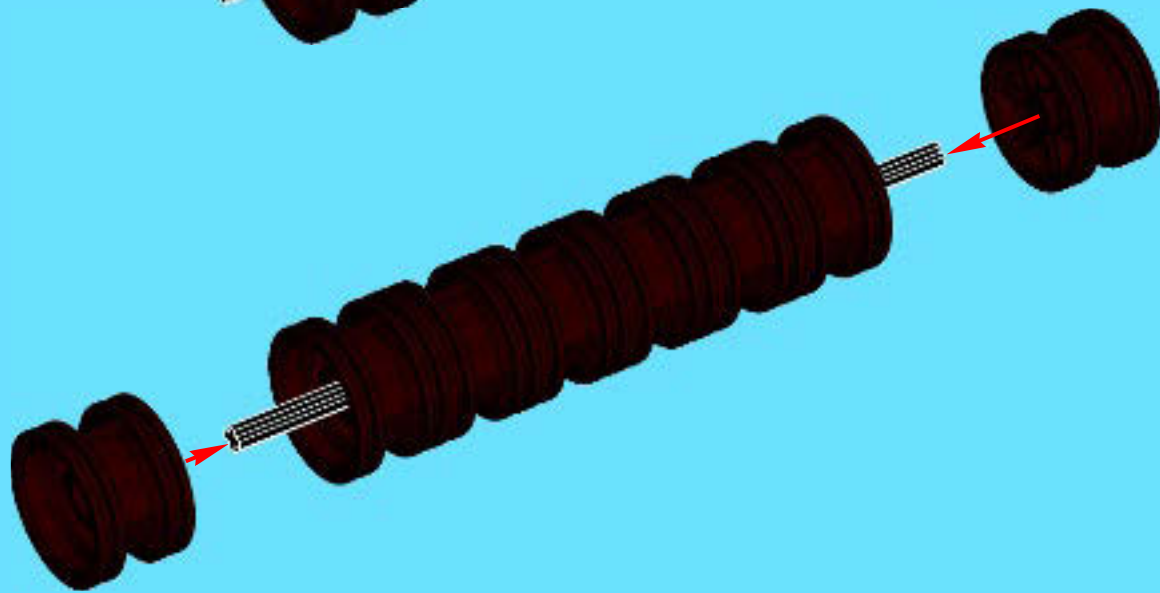

155

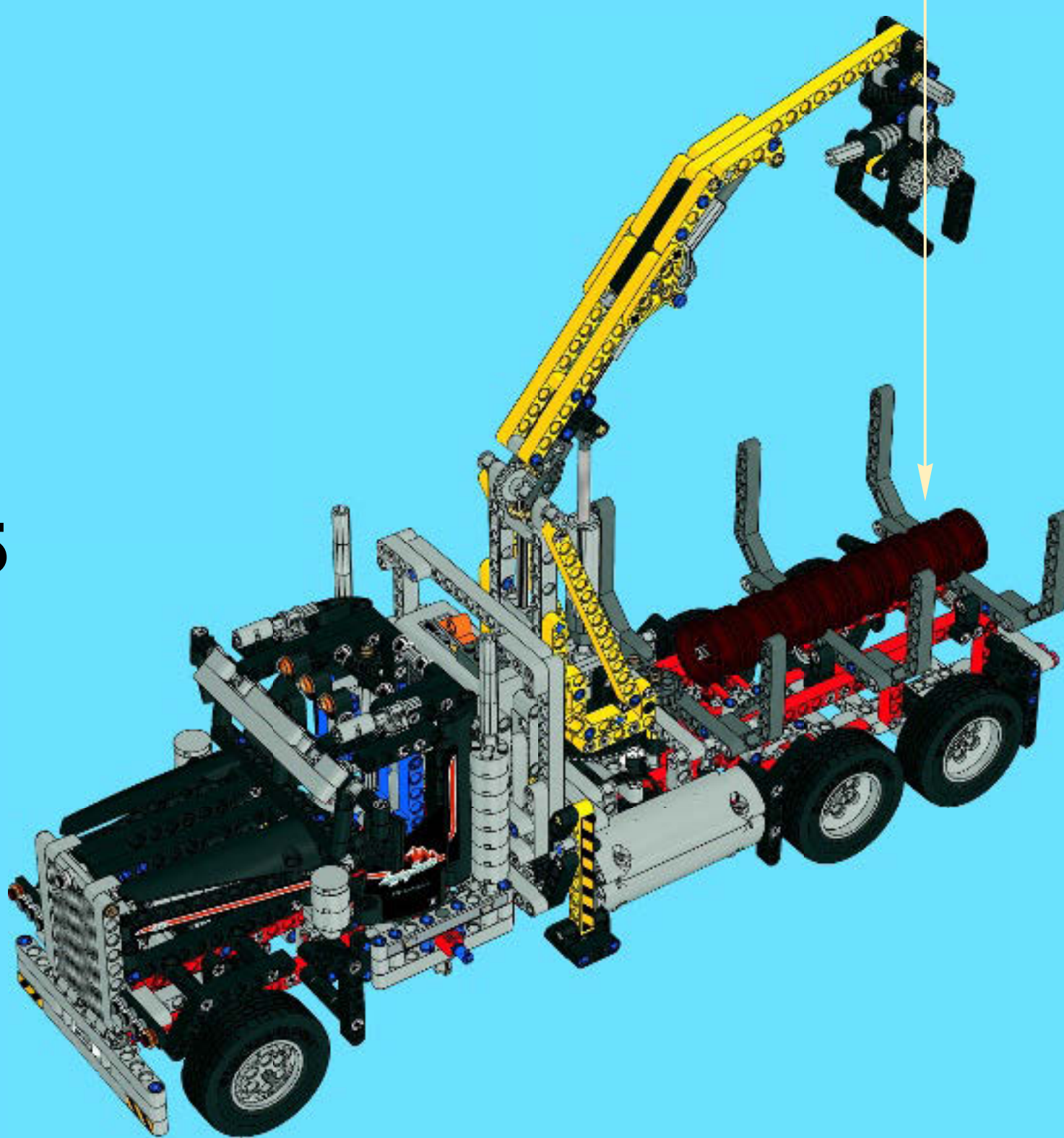

2x  
4208160



2x  
4540381



6x  
4666579



6x  
4514554



2x  
4207456



7x  
4565452



4x  
4158923



11x  
4143005



84x  
4206482



91x  
4514553



6x  
3005740



4x  
3005741



5x  
4222960

1x  
4187122



3x  
4141628



4x  
4144022

5



2x  
4142133

9



2x  
4187136

13



2x  
4522935

15

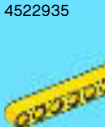

3x  
4542579



2x  
4111996



2x  
4503425



2x  
6010863



4x  
4112203



2x  
4119474



26x  
4239601



6x  
4519010

9x  
4566927



8x  
4618633



6x  
4248204



2x  
302326



2x  
371026



1x  
346026



1x  
303526



2x  
244426



2x  
4114670



5x  
4107783



14x  
4107085



2x  
4107767



19x  
4526982

14x  
4121667



4x  
4142236



4x  
4558170



13x  
4173668



7x  
4552347



10x  
4142822



4x  
4128593



3x  
4142823



8x  
4112282

5



4x  
4142135

7



5x  
4495935

9



2x  
4645732

11



12x  
4156150

13



3x  
4522933



2x  
4530578

6



1x  
4558731



5

1x  
4558774

14



1x  
4558740

13



1x  
4558775



8x  
6010864



2x  
4558692

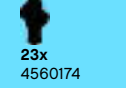

23x  
4560174

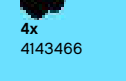

4x  
4143466

7x  
4177431



3x  
4177430



1x  
4652236



1x  
4562009



6x  
4547373



1x  
4624645



191x  
4121715



2x  
4119589



18x  
4140801

4



8x  
370526

6



10x  
370626

10



3x  
373726

12



5x  
370826



- 14x 4211775
- 4x 4652234
- 6x 4211610
- 4x 4211713
- 5x 4211651
- 8x 4495930
- 7x 4211866
- 7x 4611705
- 2x 4522934
- 7x 4542577
- 1x 4638507
- 1x 6012286

- 7x 4225033
- 4x 4211566
- 4x 4211574
- 6x 4551421
- 4x 6000018
- 1x 4580510
- 4x 4234251
- 13x 4211567
- 22x 4211622
- 24x 6004888
- 11x 4211779
- 6x 4538007

- 63x 4211815
- 12x 4211639
- 7x 4211805
- 4x 4535768
- 1x 4539880
- 2x 4540797
- 4x 4566253
- 18x 4211526
- 4x 4211541
- 2x 4211480
- 20x 4211350
- 1x 4652235

- 8x 4211807
- 10x 4211553
- 26x 4512360
- 3x 4526985
- 1x 4502595
- 2x 4525904
- 6x 4211865
- 2x 4211536
- 1x 4558690
- 1x 4278756
- 15x 4640536
- 3x 4211510
- 1x 4612100
- 1x 4506078

- 4x 4141270
- 14x 4143154
- 4x 4142132
- 2x 4562805
- 16x 4542575
- 25x 4140806
- 2x 4270473
- 3x 4278957
- 2x 4128594
- 10x 4107824
- 26x 4142865
- 1x 4514558
- 1x 4525184

- 6x 4210668
- 3x 4522937
- 8x 4210980
- 1x 4528038
- 3x 6007058
- 1x 4508553
- 10x 4560177
- 3x 4499858
- 2x 4514559
- 13x 4237267
- 1x 4249039

Customer Service  
Kundenservice  
Service Consommateurs  
Servicio Al Consumidor

[www.lego.com/service](http://www.lego.com/service) or dial

: 00800 5346 5555  
 : 1-800-422-5346

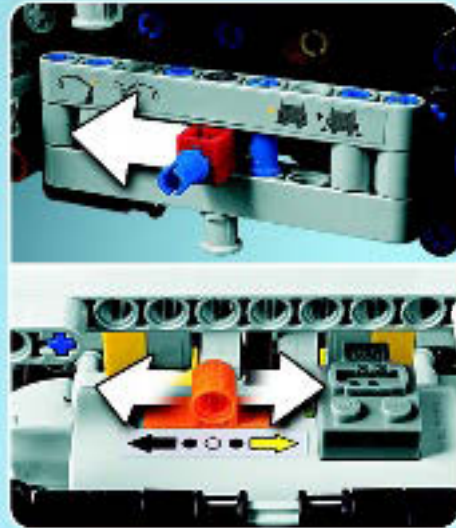
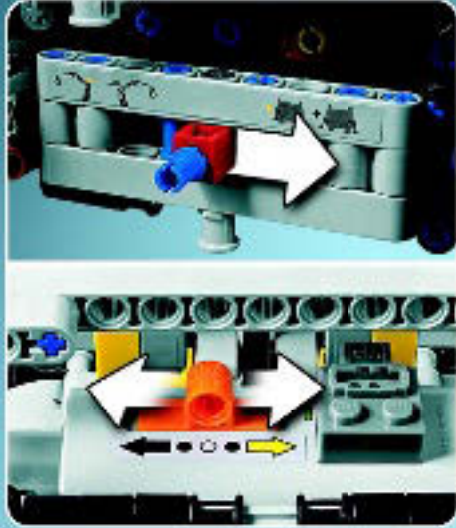

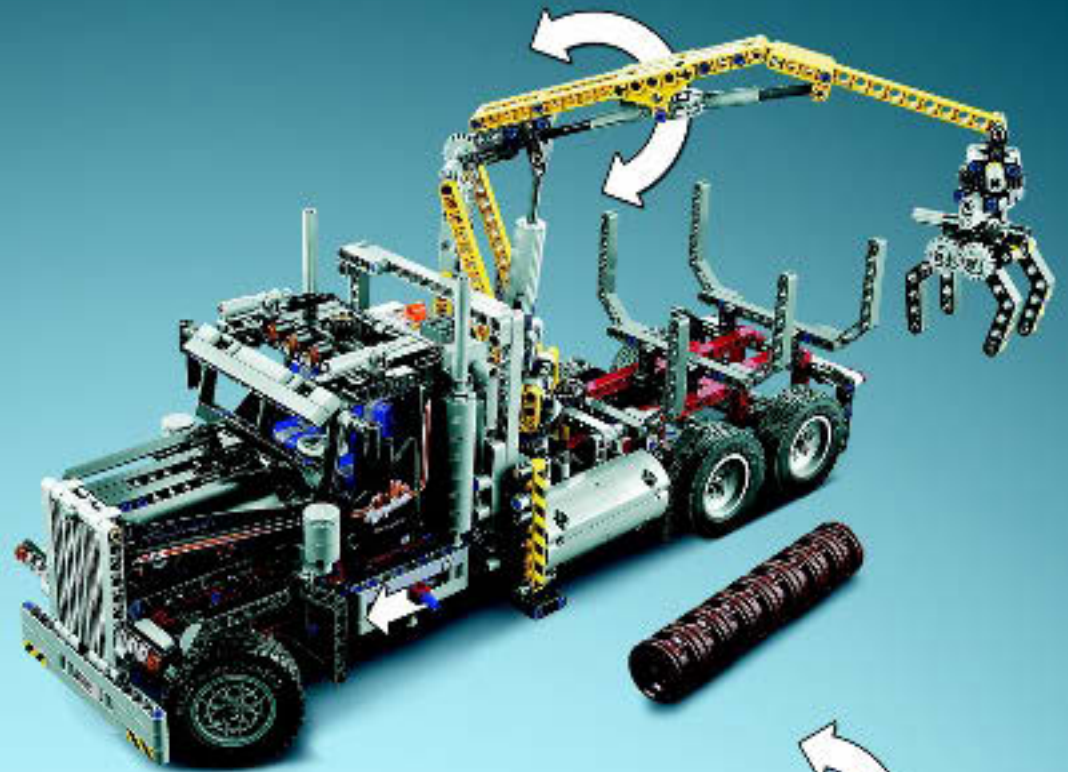
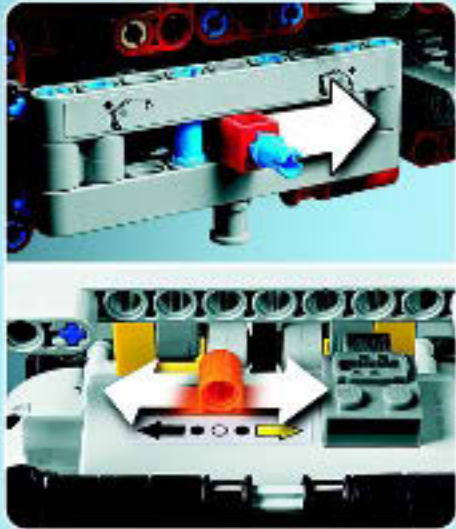
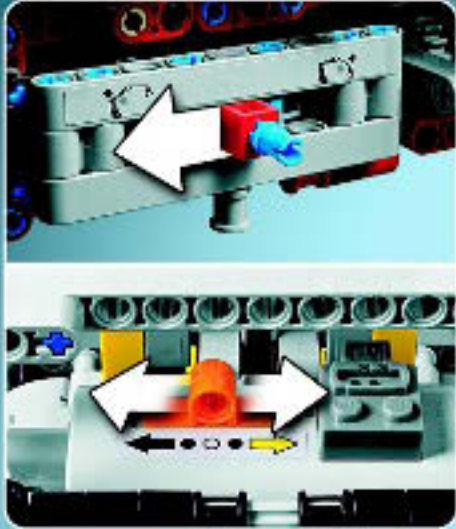



Alternative model building instructions only available for download from:  
Bauanleitungen für alternative Modelle stehen ausschließlich als Download zur Verfügung unter:  
Les instructions de montage du modèle alternatif sont uniquement disponibles sur Internet dans la rubrique « Montage » du site :  
Las instrucciones de construcción del modelo alternativo sólo pueden obtenerse a través de:  
Instruções de construção do modelo alternativo disponíveis para descarregar apenas em:  
Másféle modellépítési útmutatókat csak az alábbi helyről tölthetsz le:

[Technic.LEGO.com](http://Technic.LEGO.com)

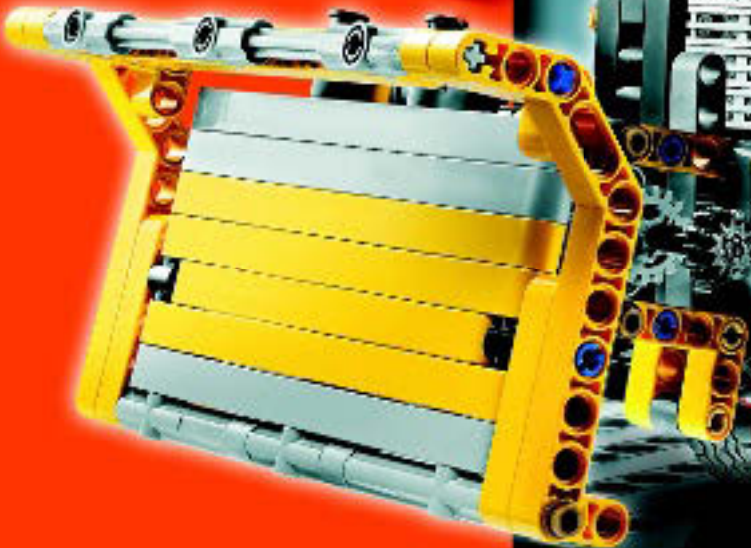



# TECHNIC

## 8110



Mercedes-Benz and the design of the enclosed product are subject to intellectual property protection owned by Daimler AG. They are used by LEGO System A/S under license.  
 Mercedes-Benz et le design du produit inclus sont sujets à la protection de la propriété intellectuelle dont Daimler AG en est le propriétaire. Ils sont utilisés par LEGO System A/S sous licence.  
 Mercedes-Benz y el diseño del producto incluido están sujetos a la protección de la propiedad intelectual de Daimler AG. Son utilizados por LEGO System A/S bajo licencia.



Mercedes-Benz



www.LEGOclub.com

# LEGO club

**FREE! GRATIS! GRATUIT!**



LEGO Club Magazine



LEGO Club Email



**YES!** I want to join the LEGO® Club FREE! **OUI!** Je veux m'abonner au LEGO® Club GRATUITEMENT!  
**Ja!** Ich möchte Mitglied im kostenlosen LEGO® Club werden. **Ja!** Ik wil graag GRATIS lid worden van de LEGO® Club.  
**Ja!** Jeg ønsker å melde meg inn i LEGO® Club gratis! **Ja!** Jag vill gå med i LEGO® Club GRATIS!

First name · Prénom  
 Vorname · Voornaam  
 Fornavn · Förnamn

Last name · Nom de famille  
 Name · Achternaam  
 Etternavn · Eftermann

Date of Birth · Date de naissance  
 Geburtstag · Geboortedatum  
 Fødselsdato · Födelsedatum

Boy · Garçon · Junge ·  
 Jongen Gutt · Pojke  Girl · Fille Mädchen ·  
 Meisje Jente · Flicka

Street · Adresse  
 Straße, Hausnr.  
 Straat, huisnr.  
 Adress

City · Ville  
 Ort · Woonplaats  
 Poststed · Postort

State  
 Prov. County

Zip/Postcode · Code  
 Postal · PLZ · Postcode ·  
 Postnummer

Country  
 Pays · Land

Email · Courriel ·  
 E-Mail · E-post

- Fill in your email address and we will send you a membership confirmation and monthly email newsletters. If you do not wish to receive the newsletters please tick here. Remplis ton adresse e-mail et nous t'enverrons une confirmation d'adhésion ainsi que le bulletin e-mail mensuel. Si tu ne désires pas recevoir le bulletin, coche cette case. Vul je e-mailadres in en we sturen je een bevestiging van je lidmaatschap en maandelijke e-mail nieuwsbrieven. Als je geen e-mail wilt ontvangen, kruis dan dit vakje aan.
- Ich möchte per E-Mail den monatlichen LEGO Club Newsletter erhalten. Ønsker du at vi skal sende en liten hilsen til barnet ditt for å bekrefte medlemskapet, ber vi deg krysse av i feltet, samt oppgi e-postadressen som hilsenen skal sendes til. Om du vill att vi ska skicka en bekräftelse på ditt barns medlemskap, ber vi dig sätta ett kryss i rutan och skriva den e-post adress som bekräftelsen ska skickas till.
- If you do not wish to receive additional mailings from the LEGO Club please tick here. Si tu ne désires pas recevoir de courrier supplémentaire du Club LEGO, coche cette case. Als je geen verdere post van de LEGO Club wilt ontvangen, kruis dan dit vakje aan.
- Dersom du ønsker å motta annen informasjon fra LEGO Gruppen, setter du et kryss her.

**Mail to: / Poster à:** **LEGO® Club**  
 P.O. Box 1157  
 Enfield, CT USA  
 06083-1157

**Per Post an:** **LEGO® Club**  
 Postfach 14 15  
 D-36243 Niederaula

**Stuur op naar:** **LEGO® Club**  
 Postbus 40250  
 3504 AB Utrecht

**Poster à:** **LEGO® Club**  
 21 rue de la banque  
 75 002 PARIS  
 FRANCE

**Send til:** **LEGO® Club Norge**  
 Postboks 58  
 1314 Vøyenenga

**Skickas till:** **LEGO® Club Sverige**  
 Ubox 841  
 202 29 Malmö

The English language version of the magazine can only be mailed to addresses in the US, Canada, the UK, and Republic of Ireland. Your club membership is valid for two years and includes free copies of the LEGO Club Magazine and e-mail newsletters. In the US and Canada please allow up to 6 weeks for delivery of your first magazine. In the UK and Republic of Ireland please allow six to 14 weeks for delivery of your first magazine. By signing this form you consent the LEGO Club to use your child's data for LEGO mailings. The data will only be used for LEGO mailings and will not be sold, rented or otherwise disclosed to any company outside the LEGO Company except for disclosure to companies acting as our agents to help us provide services requested by the child. This coupon is valid for one free membership per person, group or organization. Photocopied coupons are accepted. La version française du magazine peut être postée uniquement au Canada. L'abonnement est valide pour 2 ans et inclut des exemplaires gratuits du Magazine LEGO. Aux E.-U. et au Canada, allouer 6 semaines pour la livraison initiale. En remplissant ce formulaire, vous consentez à ce que LEGO utilise les informations de votre enfant pour des envois postaux de LEGO. L'information sera utilisée uniquement pour des envois postaux par LEGO et ne sera en aucun cas, vendue, louée, échangée ou divulguée à d'autres compagnies autres que la compagnie LEGO, à l'exception des compagnies affiliées qui nous procurent des services auxquels l'enfant a fait la demande. Formulaires photocopiés acceptés. Mit der folgenden Unterschrift erkläre ich, für mein Kind den Beitritt als Mitglied zum kostenlosen LEGO Club, der von der LEGO GmbH, D-85627 Grasbrunn, betrieben wird. Die Mitgliedschaft beinhaltet die Zusendung des LEGO Club Magazins und kann beiderseits jederzeit beendet werden. Mit der Mitgliedschaft im LEGO Club sind keinerlei Verpflichtungen verbunden. Das deutschsprachige LEGO Club Magazin wird nur an Adressen in Deutschland, Österreich und der Schweiz versendet. Eine Anmeldebestätigung kann nur per E-Mail geschickt werden. Das Magazin erscheint fünfmal jährlich. Daher kann die Zustellung des ersten Heftes bis zu drei Monate dauern. Die Mitgliedschaft ist beidseitig jederzeit kündbar, ohne dass Ihnen Kosten entstehen. Sie können der werblichen Nutzung Ihrer Daten jederzeit widersprechen. Kündigung und Widerspruch können Sie telefonisch erklären (00800 / 5346 5555, Anruf gebührenfrei, Kosten für Anrufe aus dem Mobilfunknetz können abweichen) oder an die LEGO GmbH senden. Het Nederlansde LEGO Club Magazine kan alleen worden gestuurd naar adressen in Nederland. Het lidmaatschap is 2 jaar geldig en geeft recht op toezending van het gratis LEGO Club Magazine en LEGO Club e-mails. Het eerste magazine zal binnen 12 tot 14 weken toegestuurd worden. Het lidmaatschap kan op ieder moment opgezegd worden en kan na 2 jaar gratis worden verlengd, tenzij LEGO met deze activiteit stopt. Uw gegevens worden uitsluitend gebruikt voor mailings van LEGO en zullen niet worden verkocht, verhuurd of op welke wijze dan ook verstrekt aan derden buiten de LEGO Group, uitgezonderd de organisaties die namens ons optreden om de informatie te sturen waarvoor toestemming is verleend. Den norske utgaven av magasinet sendes kun til adresser i Norge. Medlemskap i klubben gjelder i 2 år og inkluderer gratisutgaver av LEGO Club Magazine. Påregnet minimum oppsett seks uker leveringstid for første magasin. Ved å undertegne dette skjemaet, gir du ditt samtykke til at LEGO Club kan bruke opplysningene om barnet ditt i LEGO forsendelser. Dataene vil utelukkende bli brukt i LEGO forsendelser og vil ikke bli solgt, utleid eller på annen måte gjøres tilgjengelig for selskaper utenfor LEGO gruppen, unntatt selskaper som er våre agenter og som hjelper oss å tilby tjenestene barnet ettersper. Dette skjemaet gjelder for ett gratis medlemskap per person, gruppe eller organisasjon. Den svenska versionen av tidingen kan endast skickas till adresser i Sverige. Club-medlemskapet är giltigt i 2 år och innefattar gratis exemplar av LEGO Club Magazine. Villigena räkna med minimum 6 veckor för leverans av din första tidning. Genom att skicka in det här formuläret godkänner du att LEGO Club använder barnets uppgifter för LEGO utskick. Uppgifterna kommer bara att användas för LEGO utskick och kommer inte att säljas, hyras ut eller vidarebefordras till något företag som inte tillhör LEGO Gruppen, med undantag av företag som agerar som våra ombud för att tillhandahålla tjänster som barnet har begärt. Den här kupongen gäller för ett gratis medlemskap per person, grupp eller organisation. En complétant ce bulletin d'adhésion, vous acceptez que LEGO Club utilise les données relatives à votre enfant pour l'envoi de courriers concernant LEGO. Ces données seront uniquement utilisées pour l'envoi d'information concernant LEGO et ne seront ni vendues, ni louées, ni utilisées par d'autres sociétés que le groupe LEGO, à l'exception des sociétés agissant pour le compte de LEGO en tant que sous-traitant de services divers. L'abonnement au LEGO Club est valable pour une période de 2 ans. Il inclut l'envoi par courrier du magazine LEGO Club et par email des newsletters. Un délai de 6 à 14 semaines est à prévoir pour la réception de votre premier magazine. Ce bulletin d'adhésion gratuit est valable pour l'inscription d'une seule personne. Les photocopies sont acceptées. ATTENTION! Le bulletin d'adhésion doit être rempli et signé par un parent ou un tuteur.

CALL THE NUMBERS  
 00800 5346 5555  
 www.LEGOclub.com

00800 5346 5555 **1-866-534-6258 • 1-877-518-5346**



\* Freephone. Mobile charges may apply. \* Numéro sans frais. Des frais peuvent s'appliquer avec les téléphones cellulaires. \* Gebührenerfrei, Kosten für Anrufe aus Mobilfunknetzen können abweichen. \* Gratis telefonnummer vanaf vaste lijn. \* Det er et gratis nummer, når du ringer fra fasttelefon. \* Det är gratis, när du ringer från en fast telefon. \* Numéro sans frais. Des frais peuvent s'appliquer avec les téléphones portables.

Parent's signature · Signature d'un parent ou d'un tuteur  
 • Unterschrift Erziehungsberechtigter · Handtekening ouders  
 • Foreldres/foresattes underskrift · Förälders /förmyndares underskrift

Date  
 Datum  
 Date

# Technic.LEGO.com



Mercedes-Benz and the design of the enclosed product are subject to intellectual property protection owned by Daimler AG. They are used by LEGO System A/S under license. Mercedes-Benz et le design du produit inclus sont sujets à la protection de la propriété intellectuelle dont Daimler AG en est le propriétaire. Ils sont utilisés par LEGO System A/S sous licence. Mercedes-Benz y el diseño del producto incluido están sujetos a la protección de la propiedad intelectual de Daimler AG. Son utilizados por LEGO System A/S bajo licencia.



# WIN!

Go to [www.LEGOsurvey.com/product](http://www.LEGOsurvey.com/product) to fill out a survey for a chance to win a cool LEGO® Product.

No purchase necessary.

Open to all residents where not prohibited.



[www.LEGO.com](http://www.LEGO.com)



## [www.LEGOsurvey.com/product](http://www.LEGOsurvey.com/product)

### GEWINNE!

Nimm an der Umfrage auf [www.LEGOsurvey.com/product](http://www.LEGOsurvey.com/product) teil und hab die Chance ein cooles LEGO® Produkt zu gewinnen!

Die Teilnahme am Gewinnspiel führt zu keinerlei Kaufverpflichtungen. Teilnahme in allen nicht ausgeschlossenen Ländern möglich.

### WIN!

Ga naar [www.LEGOsurvey.com/product](http://www.LEGOsurvey.com/product), vul een enquêteformulier in en maak kans op een cool LEGO® product.

Geen aankoopverplichting. Iedereen mag deelnemen, uitgezonderd ingezetenden van landen waar een enquêteverbod geldt.

### GAGNE!

Visite [www.LEGOsurvey.com/product](http://www.LEGOsurvey.com/product) pour répondre à un questionnaire et avoir une chance de gagner un produit LEGO® très cool!

Aucune obligation d'achat. Ouvert à tous les résidents des pays autorisés.

### 当てよう!

[www.LEGOsurvey.com/product](http://www.LEGOsurvey.com/product) にアクセスして、アンケートにご記入ください。当選者にはレゴ®製品を差し上げます。

お買い上げの必要はありません。禁止されていない限り、すべての皆様にご利用いただけます。