



# NINJAGO

Masters of Spinjitzu



9443



**FANG-SUEI  
INCLUDED**



1

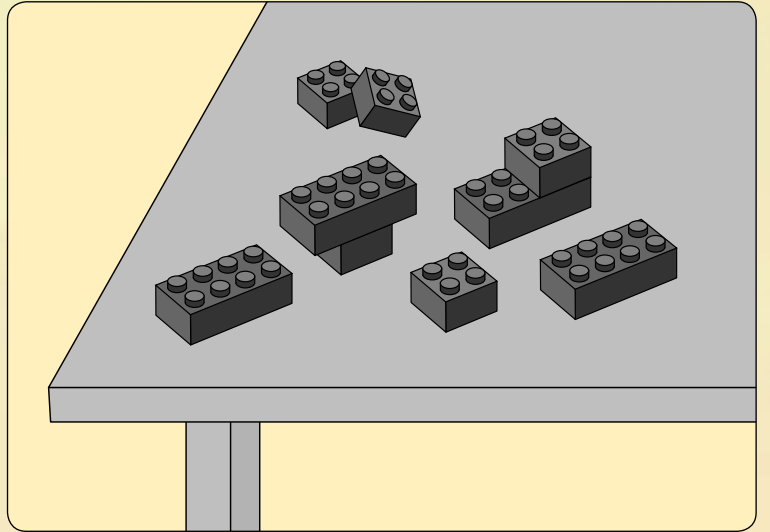
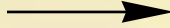
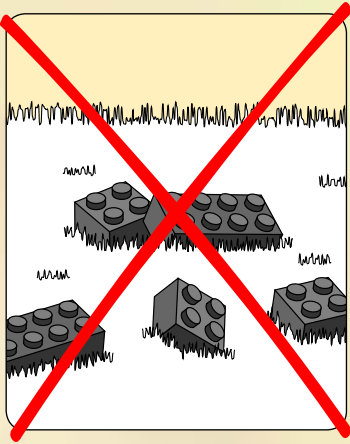

2

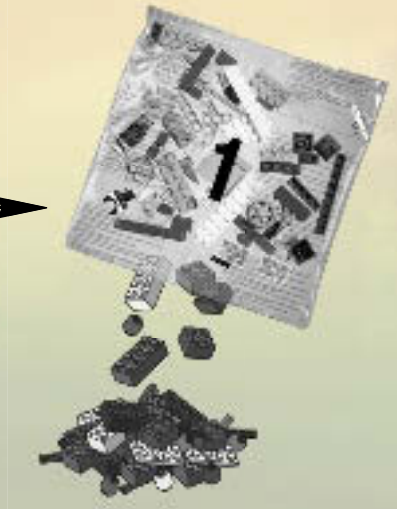



FANG SUEI INCLUDED  
FANG SUEI INCLUS  
INCLUYE A FANG SUEI

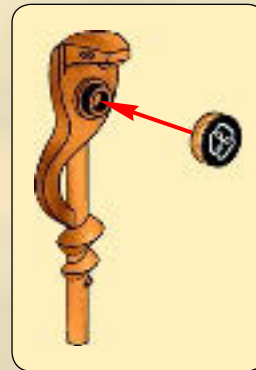
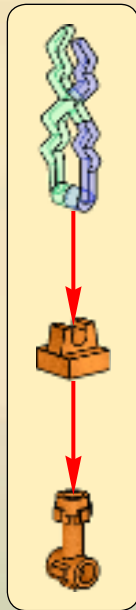
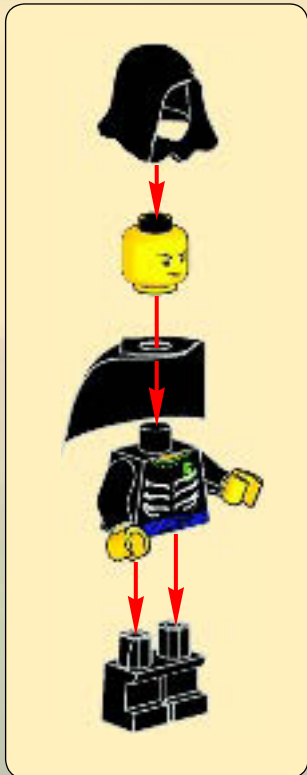



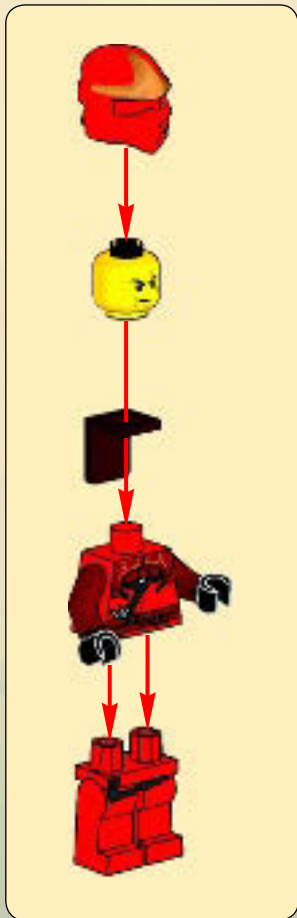

1

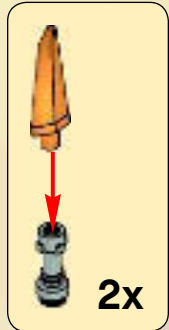

2x



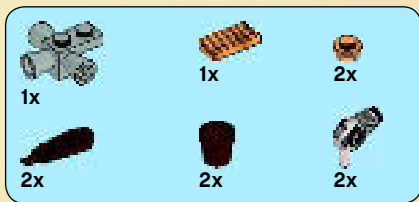

# 2

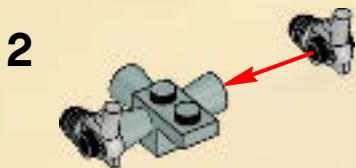

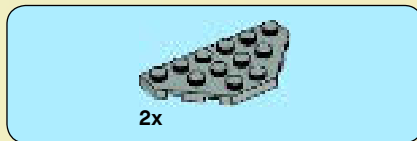

1

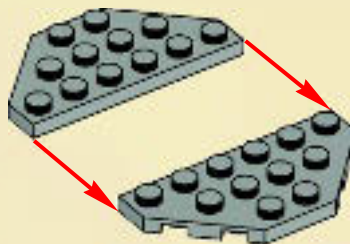

2





1x



2x

3



1x

4



1x

5

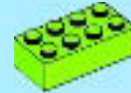

1x

6

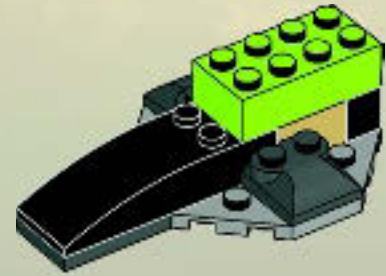





2x

7

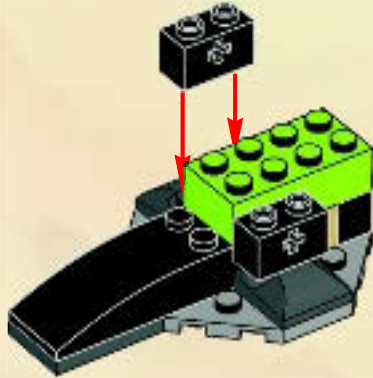

2x

8

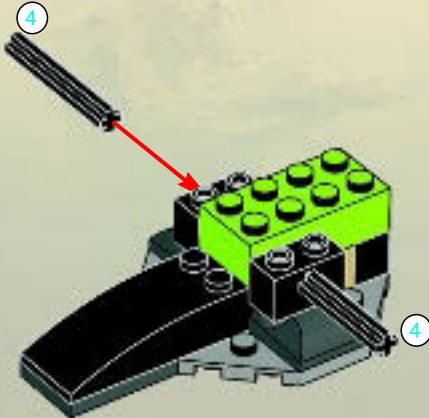

2x

9

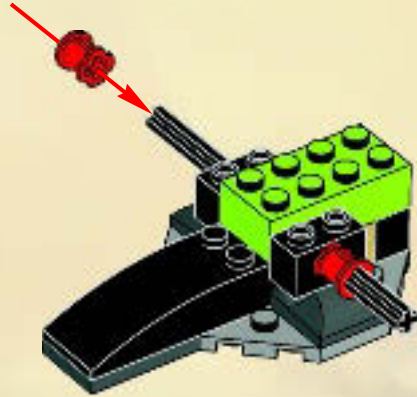

4

1:1



2x

# 10

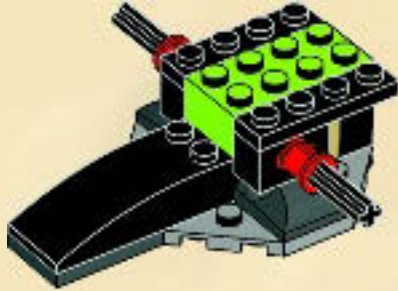

1x



1x

# 11

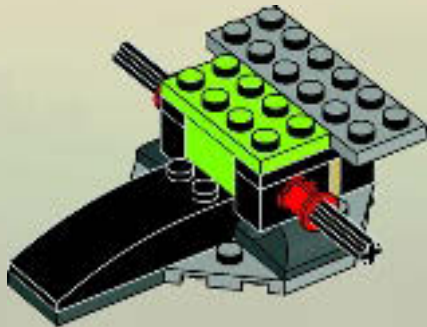

1x



2x

# 12

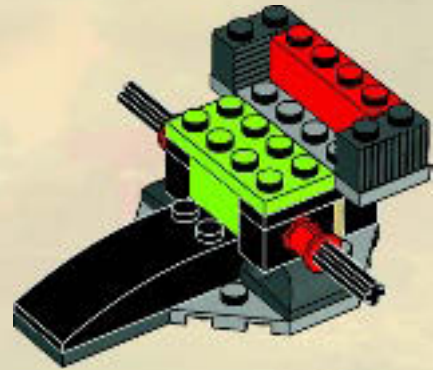



13

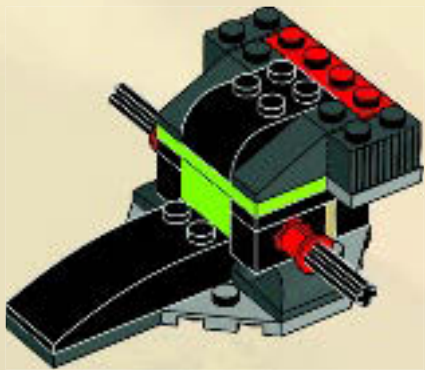

14

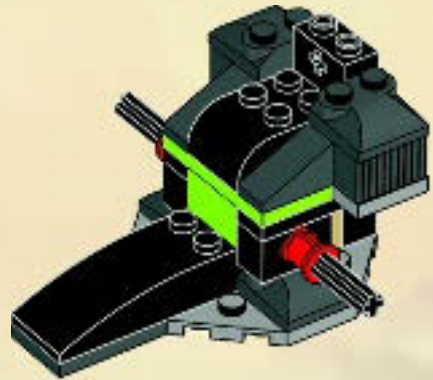





1x

# 15

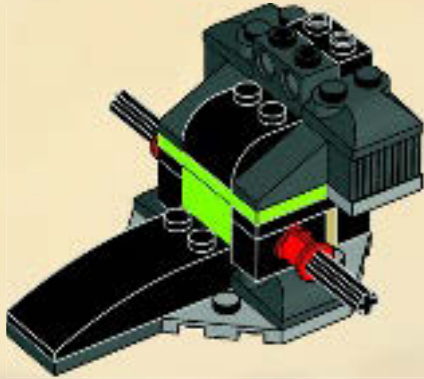

1x



1x

# 16

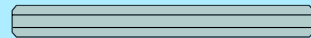
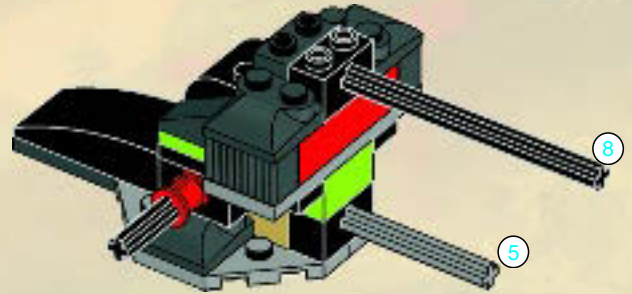

5



8

# 1:1



2x

# 17

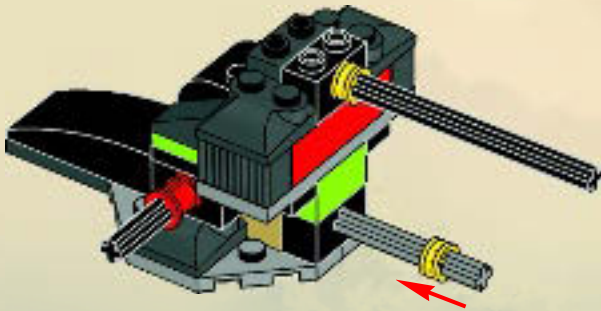

2x

# 18

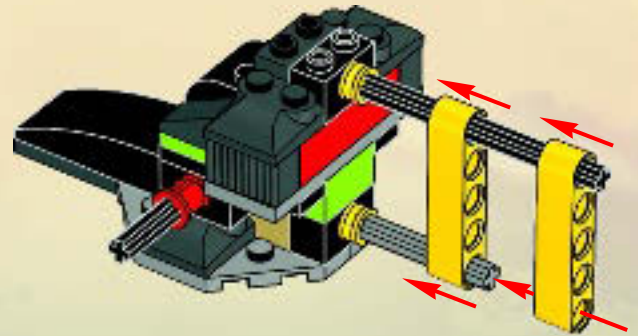



1x

# 19

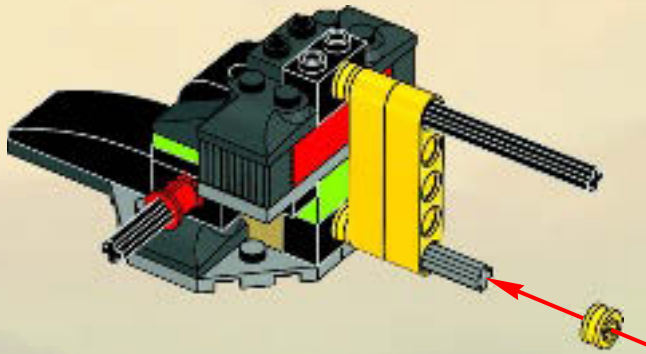

1x



1x



1x

# 20

1

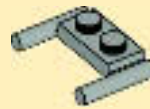

2

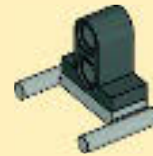

3

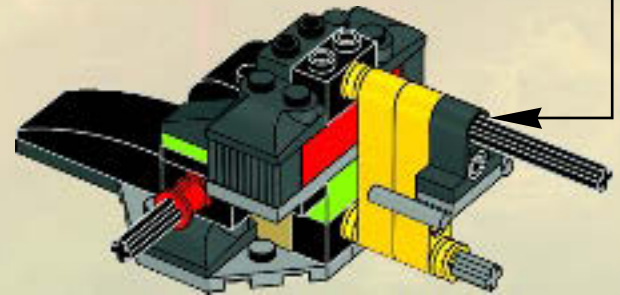



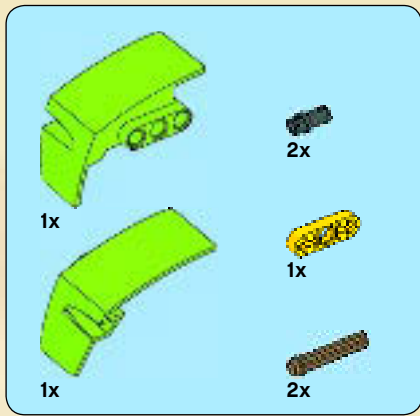

# 21

1

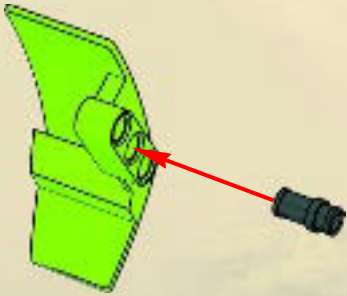

2

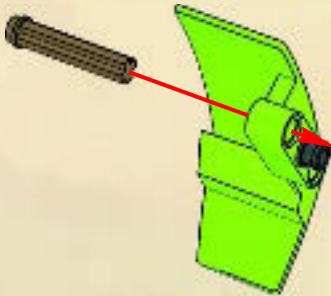

3

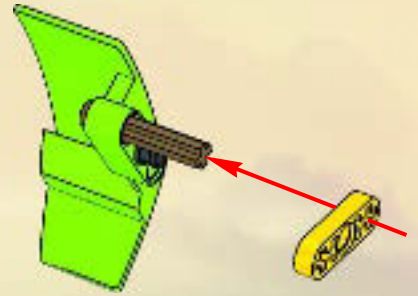

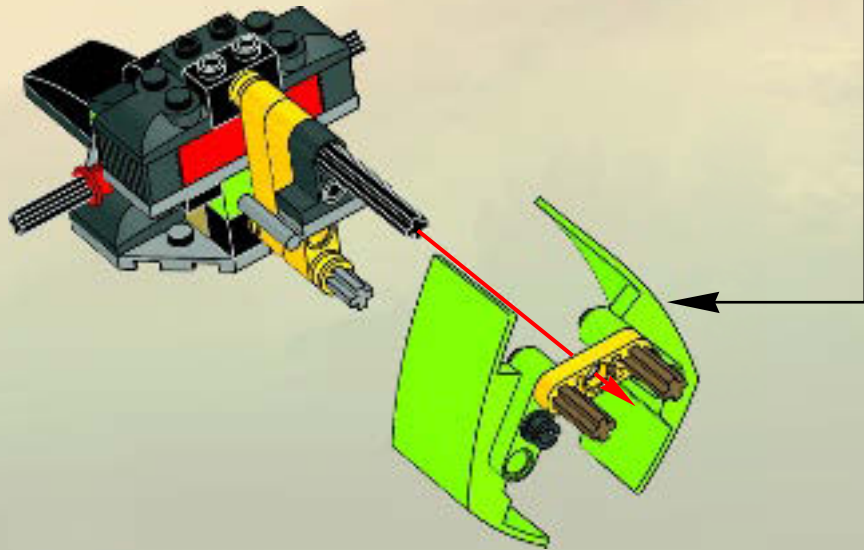
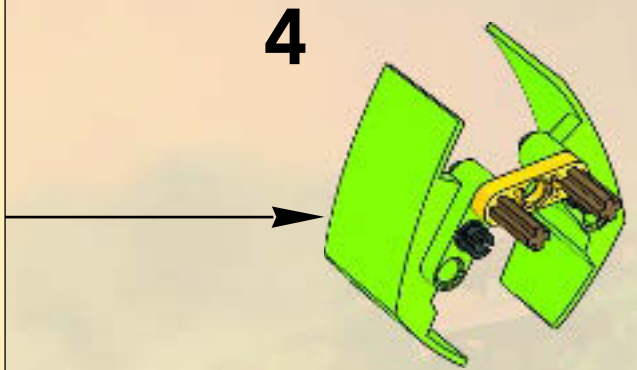
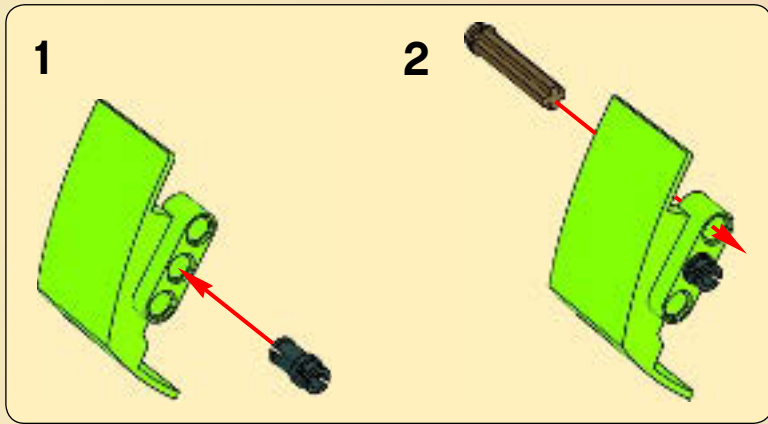



1x

22

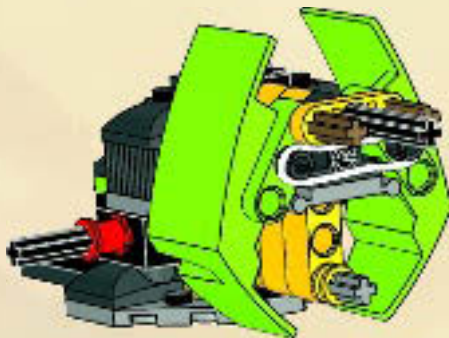

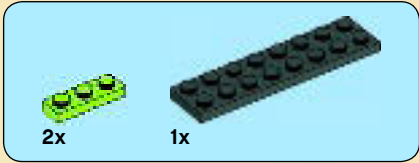

1

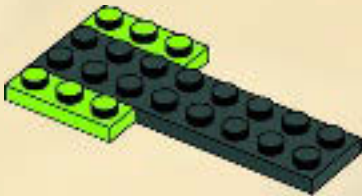

2

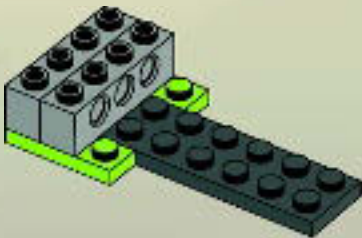

3

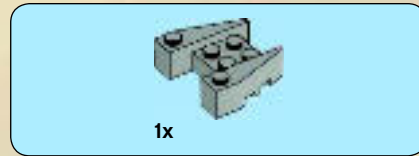
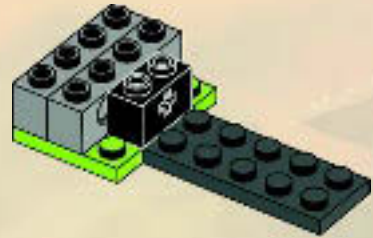

4

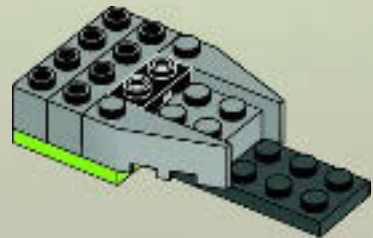

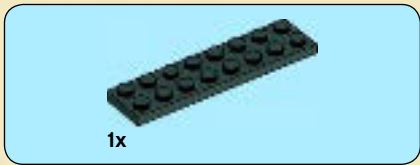

5

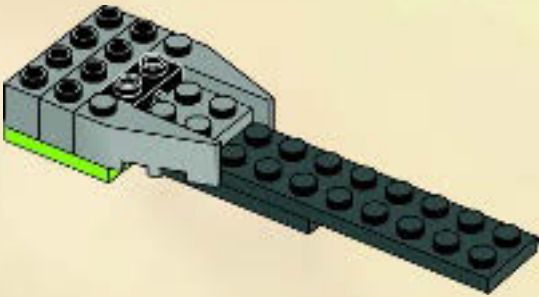

6

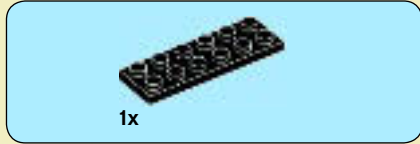
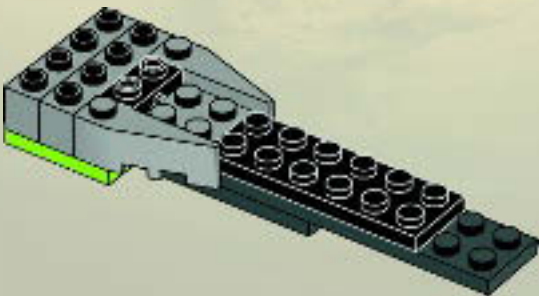

7

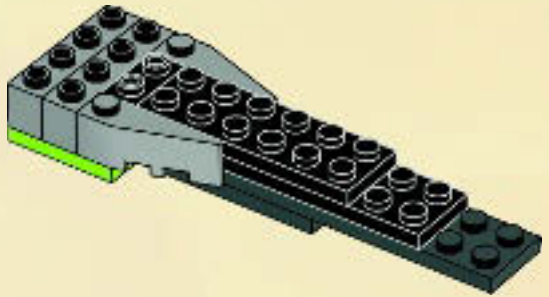

8

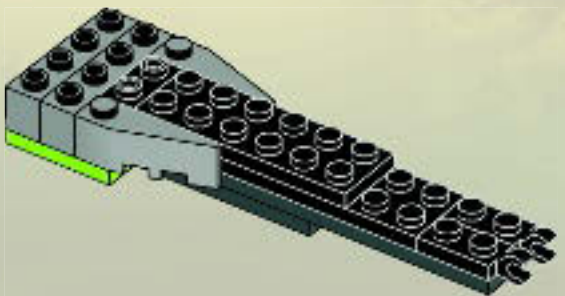





9

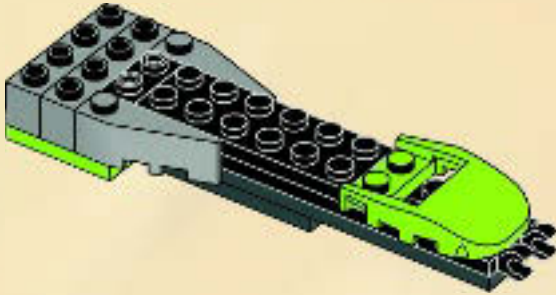

10

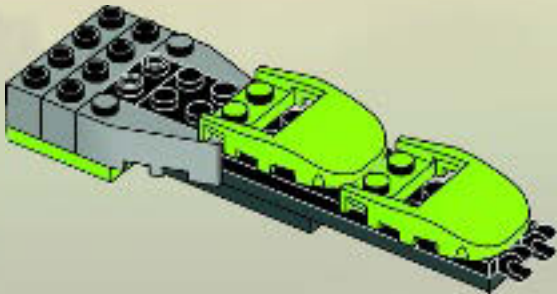

11

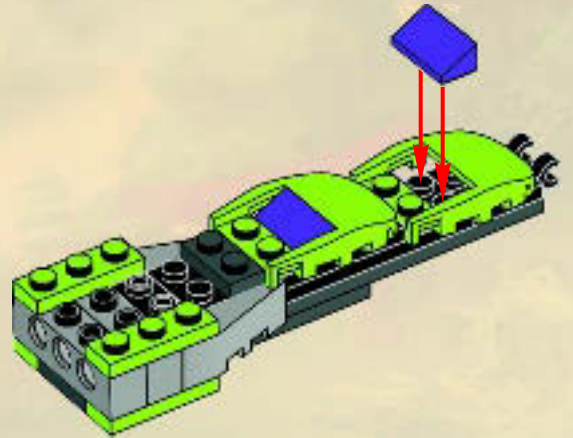

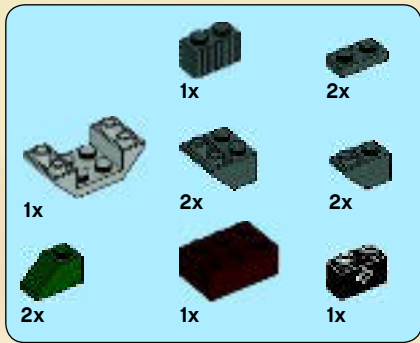

# 12

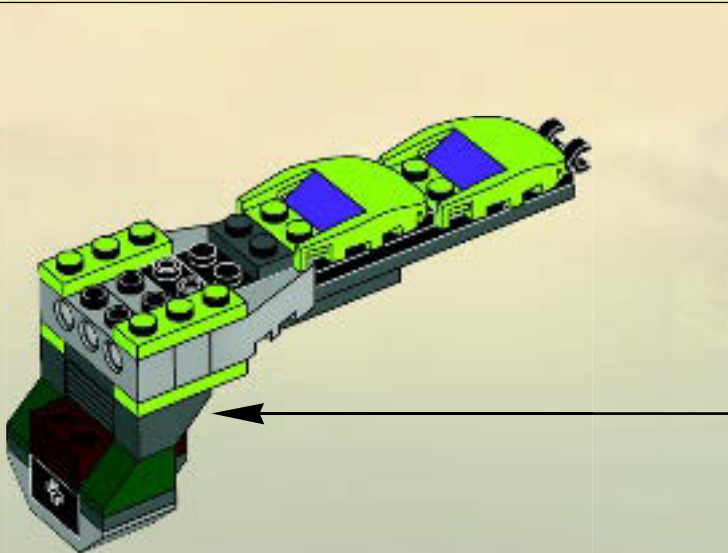
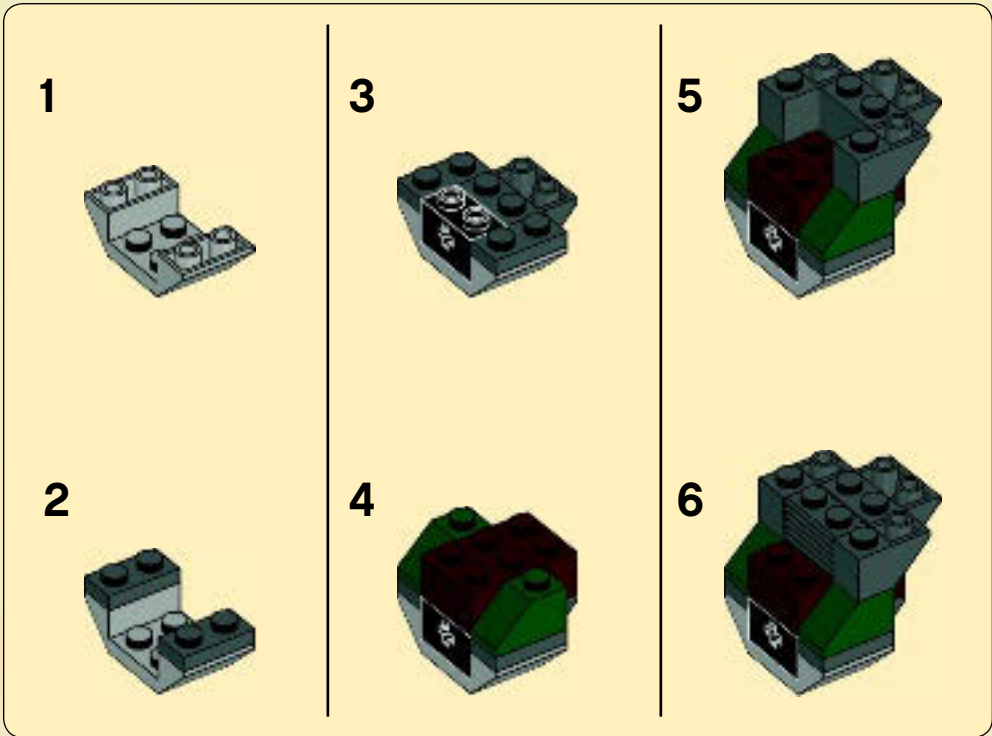

13

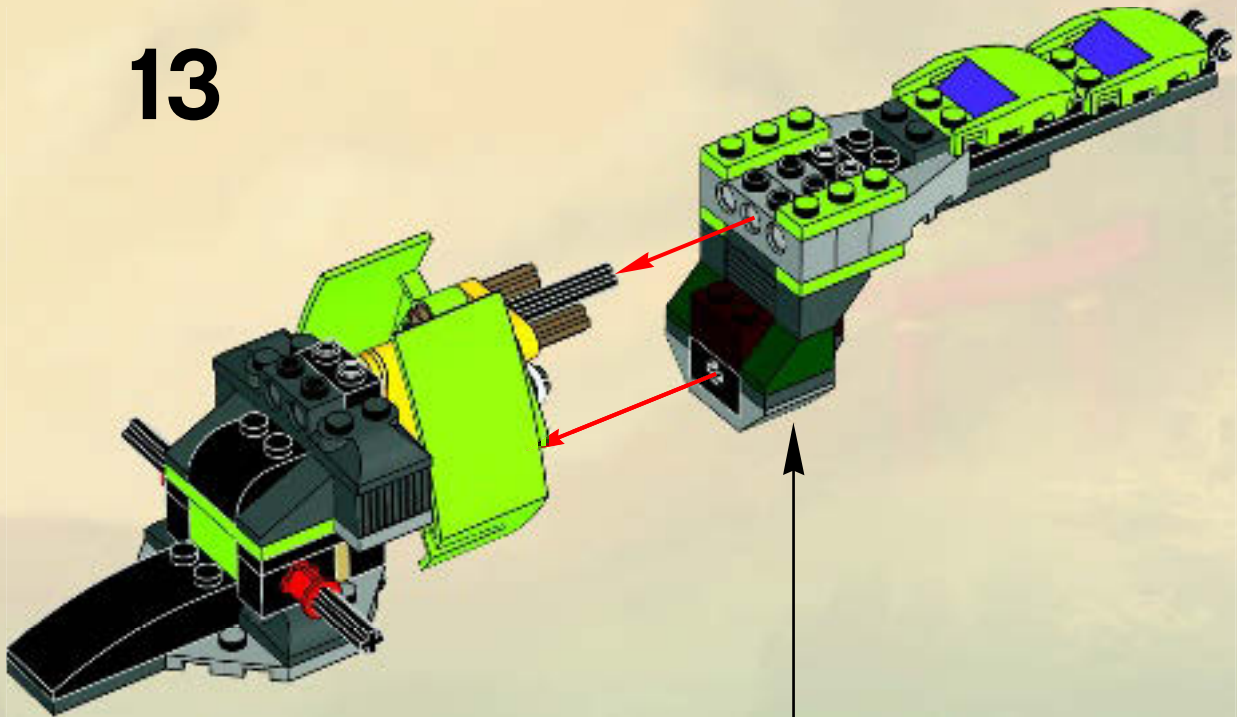

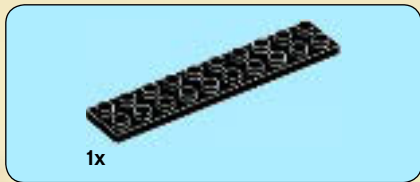

14

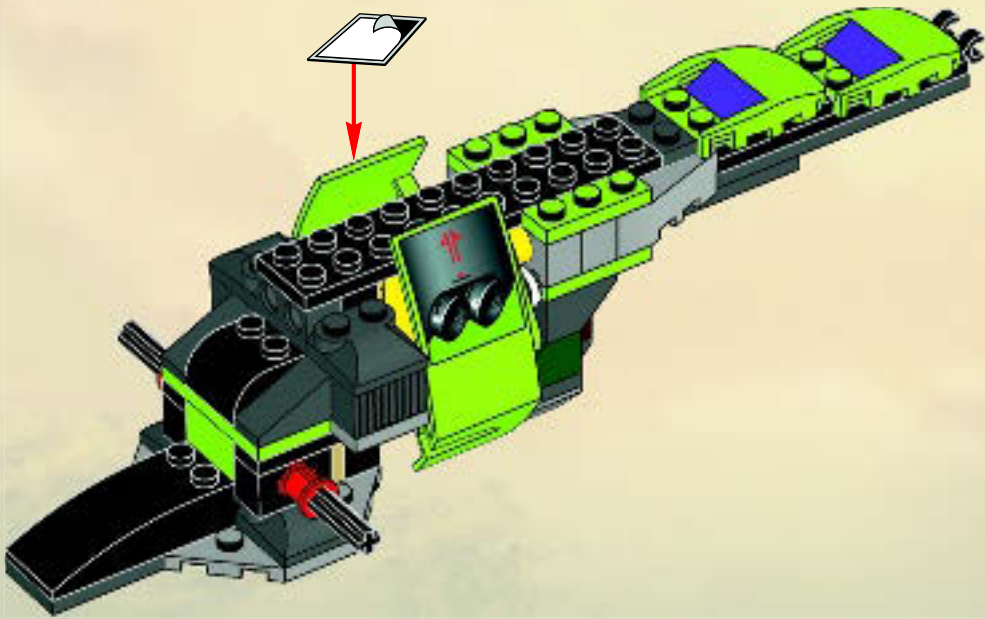

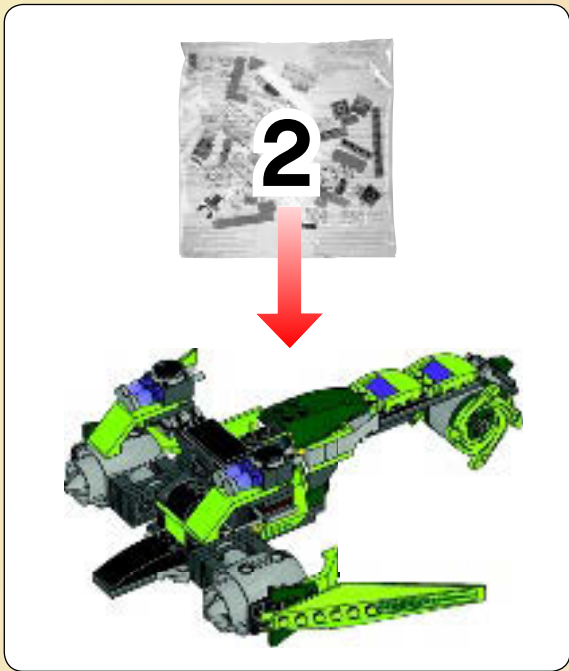

1



2

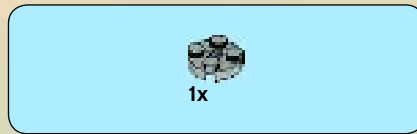

3

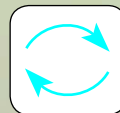



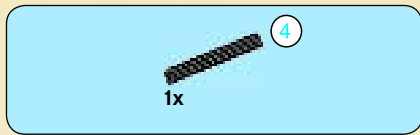

4

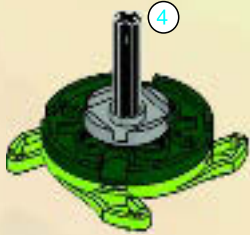

5



6

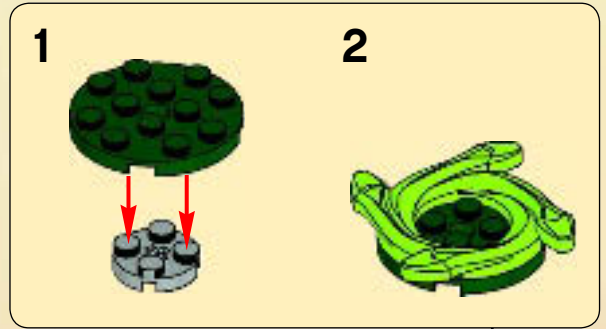

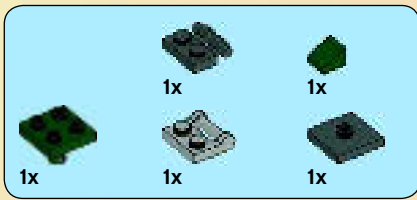

7

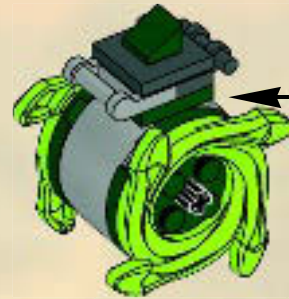

15

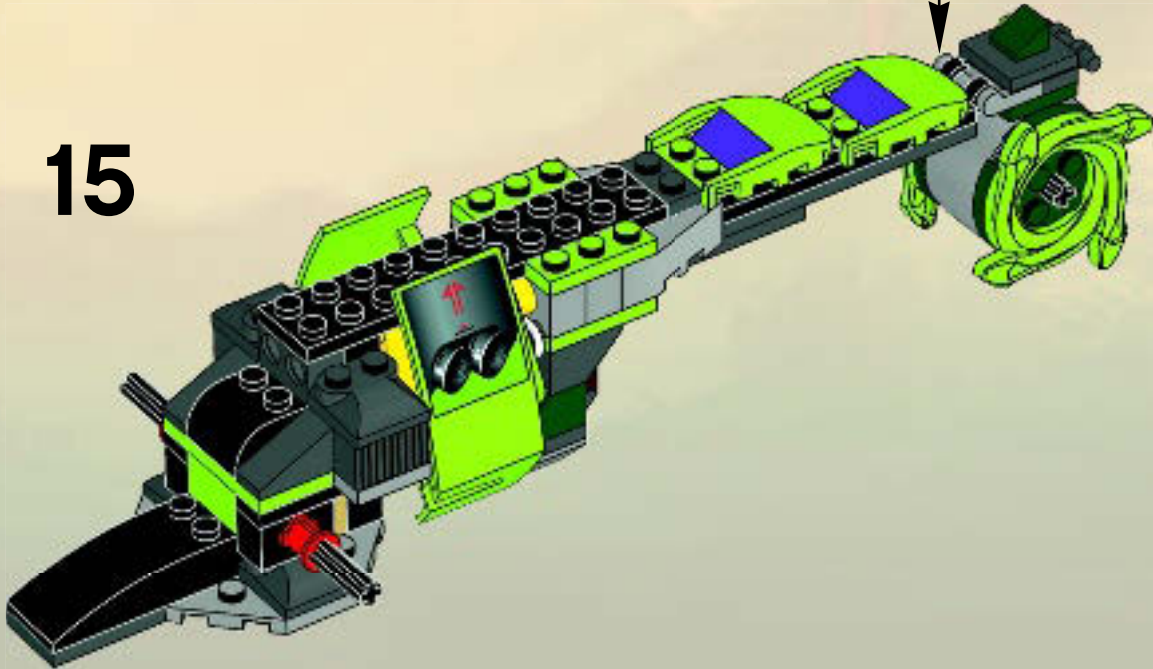



16

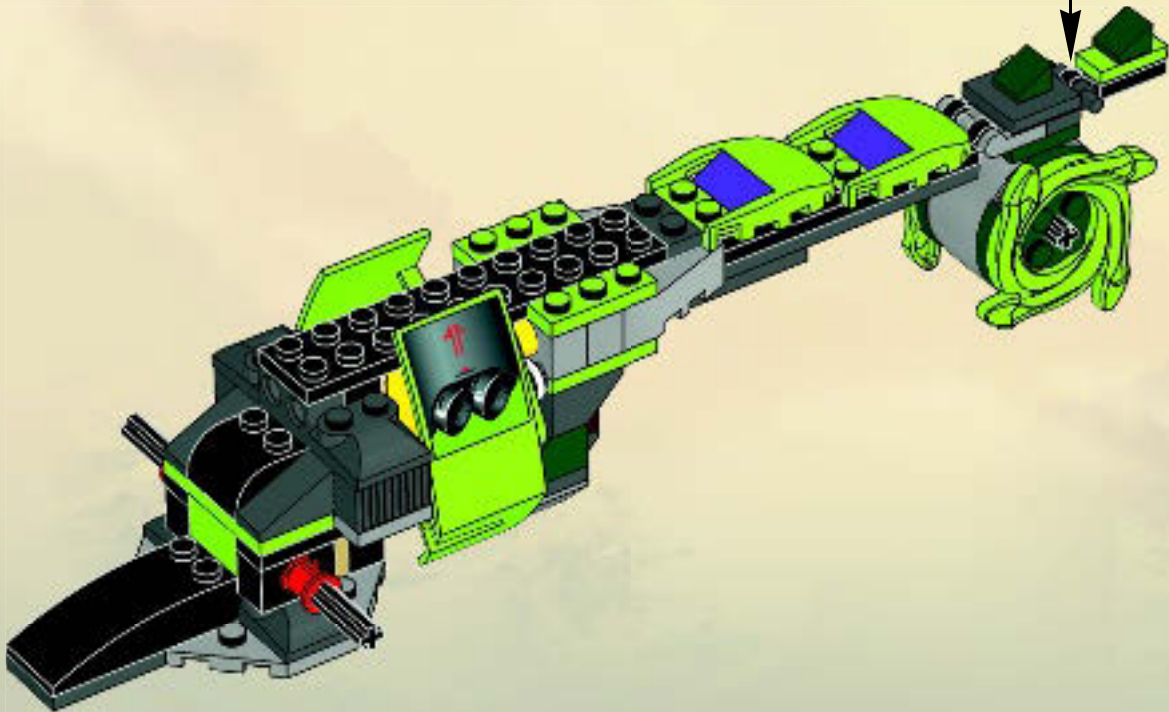
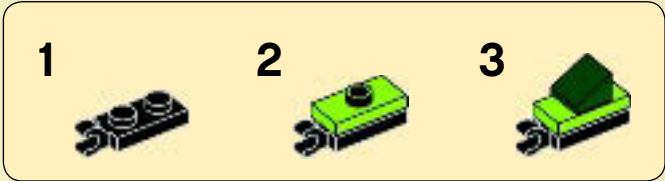

17

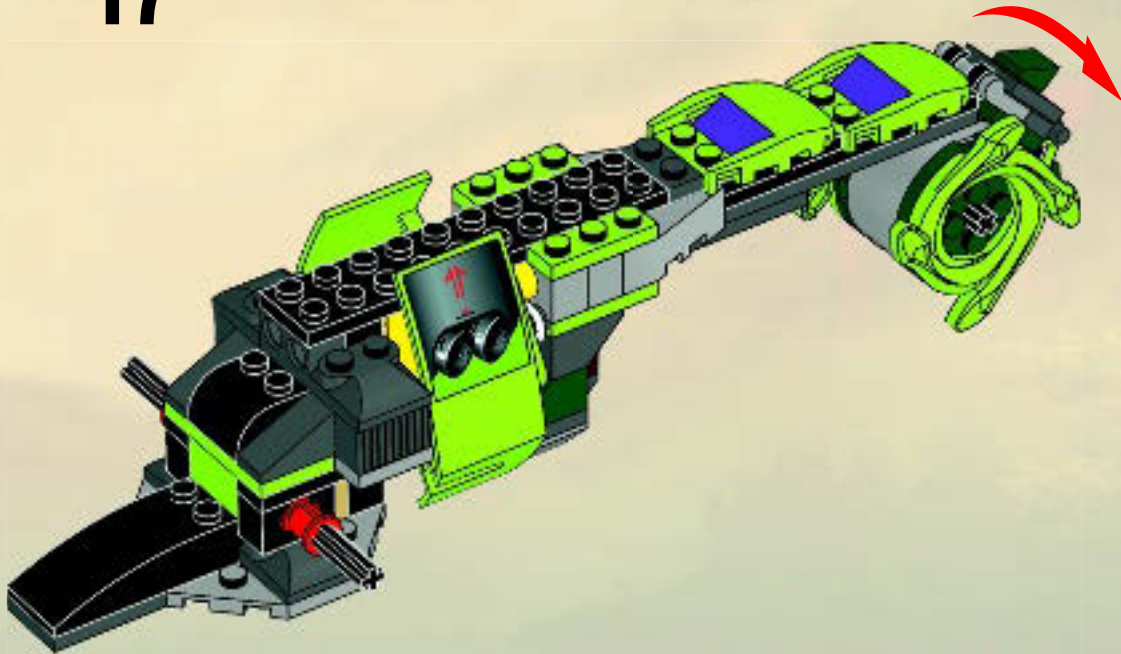



2x

# 18

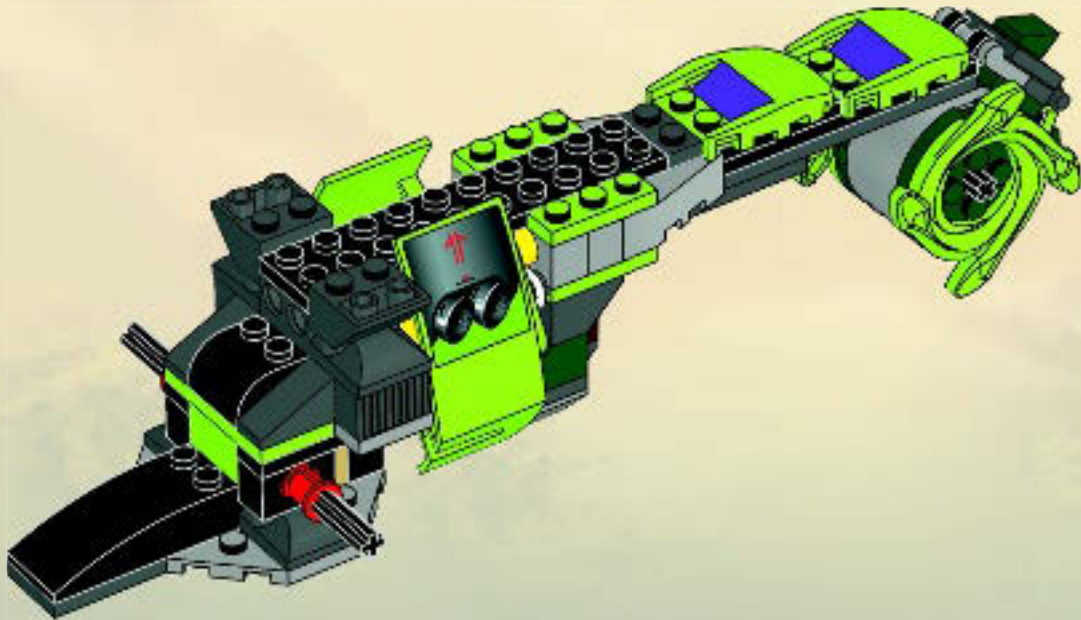





2x

# 19



2x

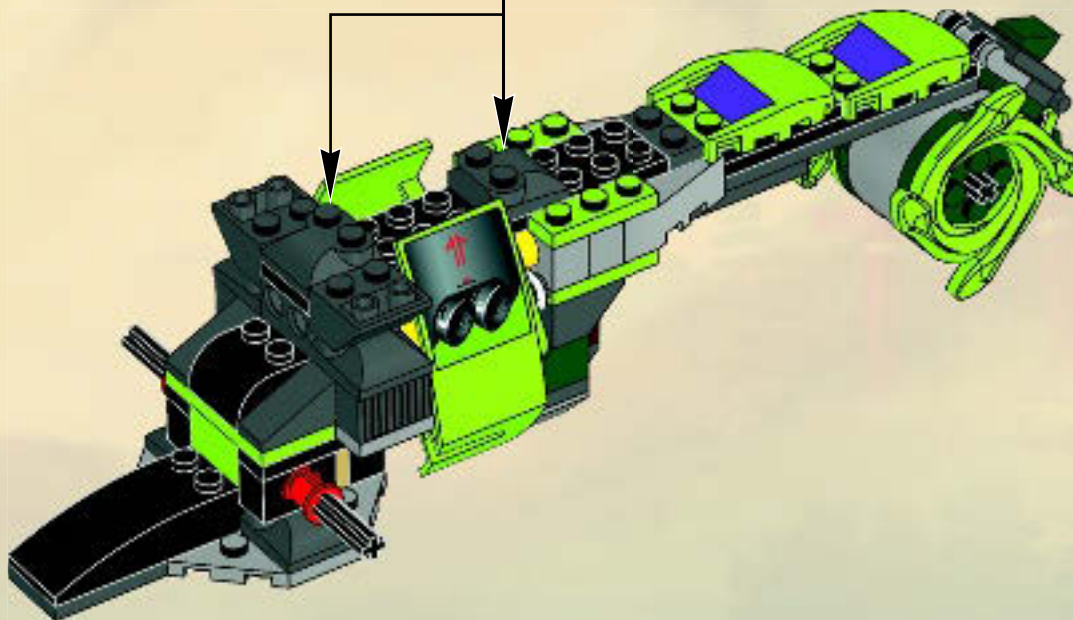



4x

# 20

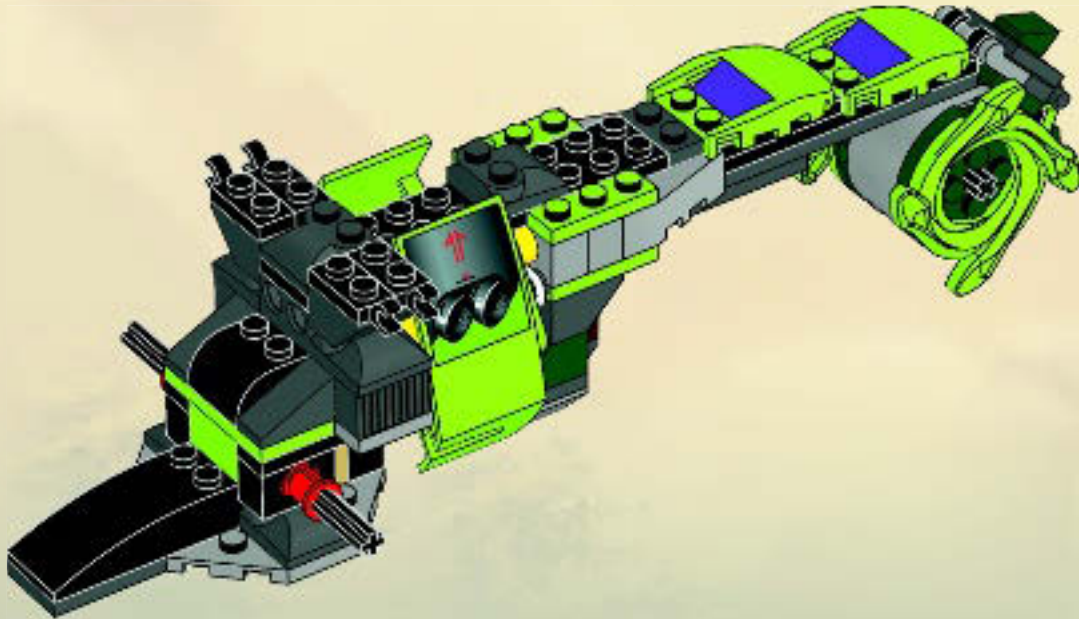

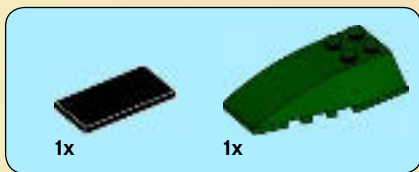

# 21

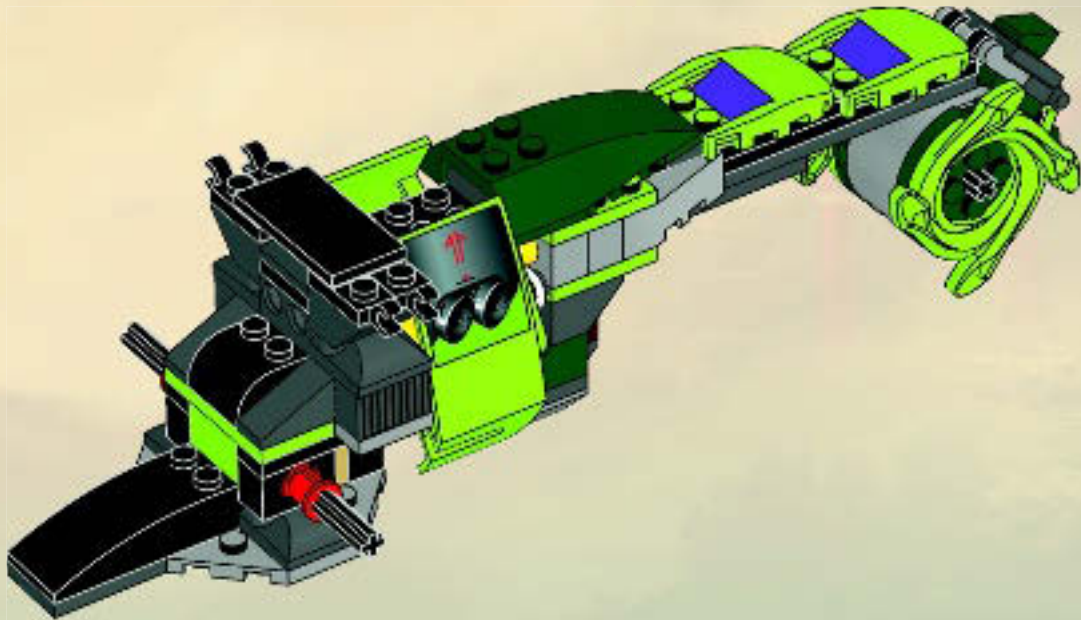

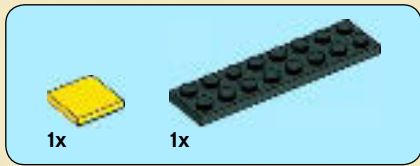

# 22

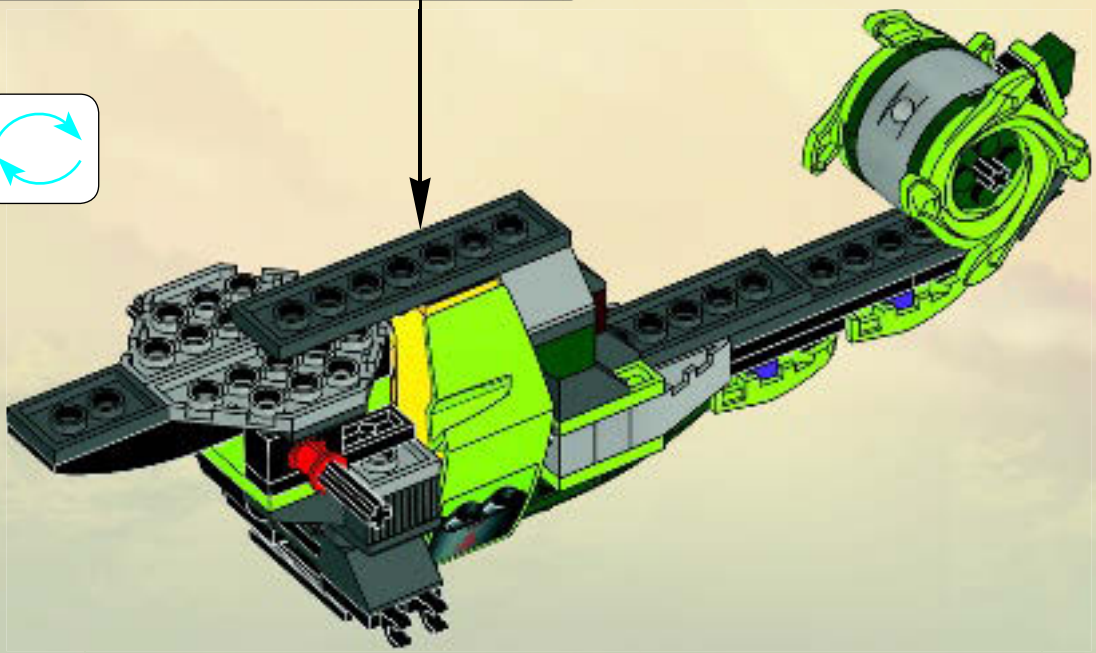
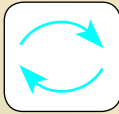
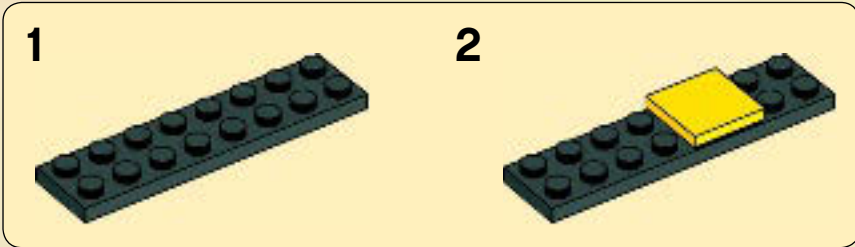



2x

1

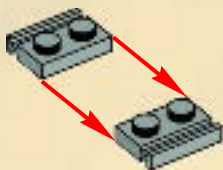

1x

2

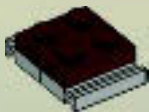

1x



1x

3



1x

4





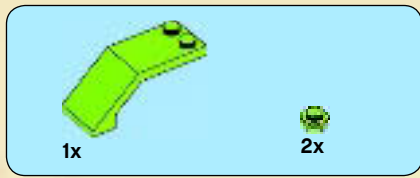

5

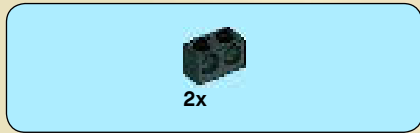
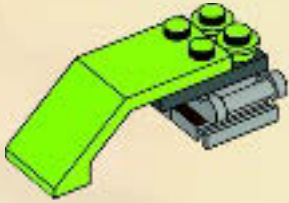

6

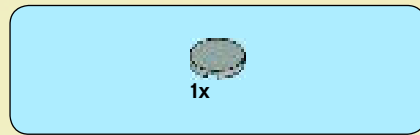
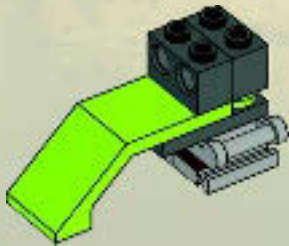

7

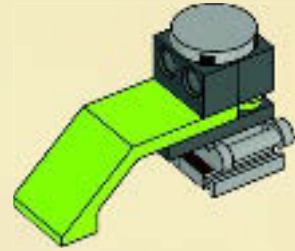

8

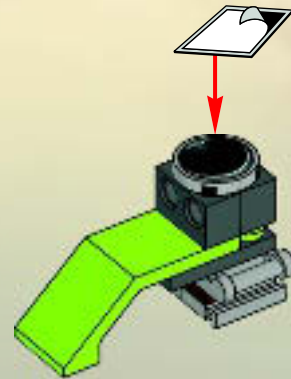



9

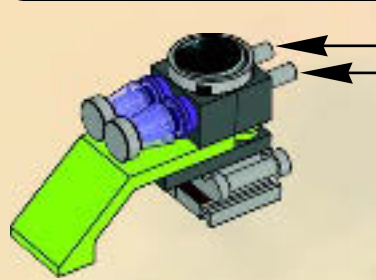
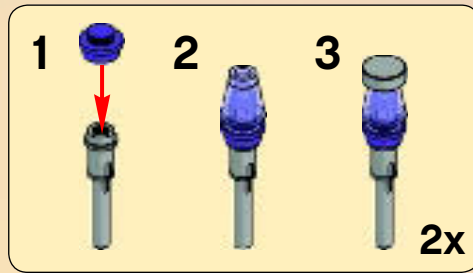

10

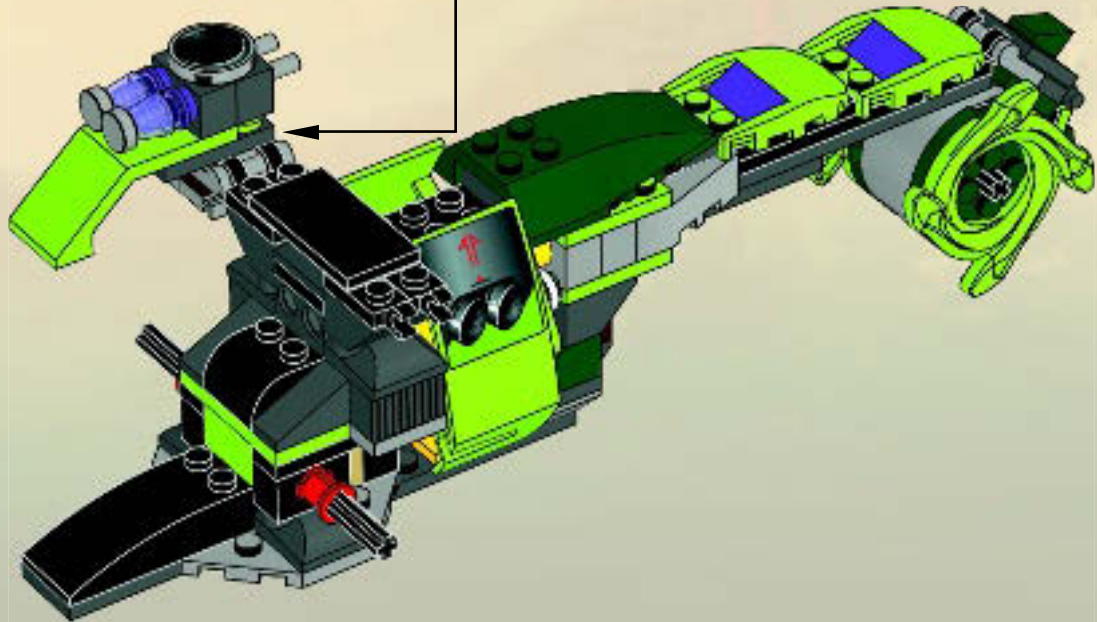



2x

1

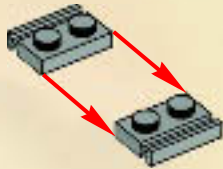

1x

2

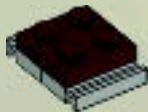

1x



1x

3



1x

4

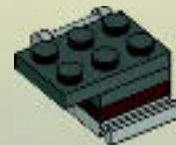

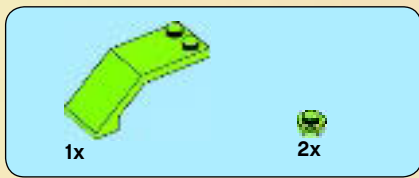

5

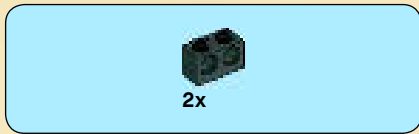
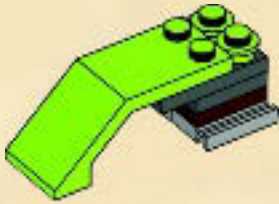

6

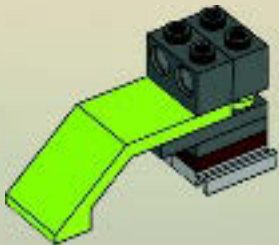

7

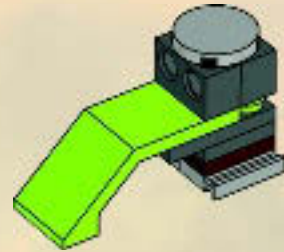

8

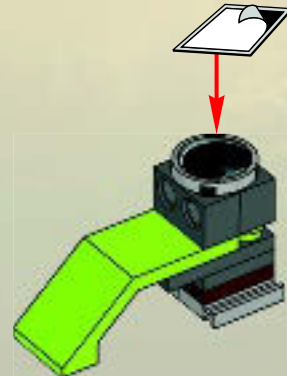



9

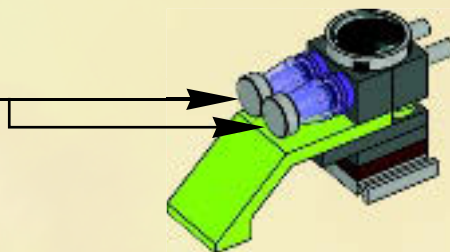
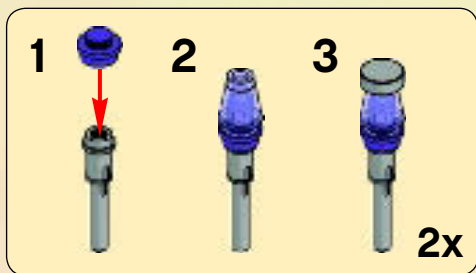

10

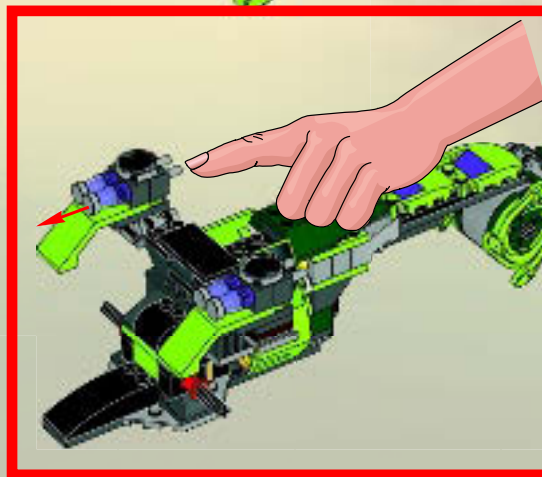
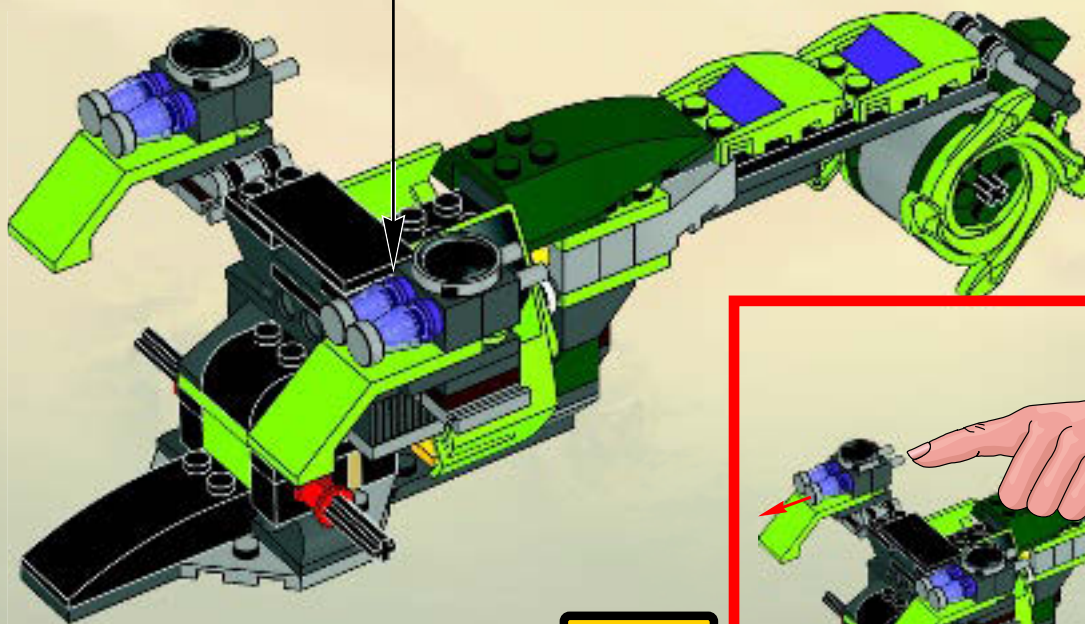



1

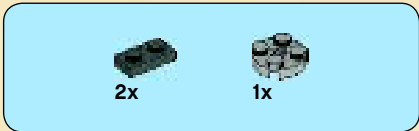

2

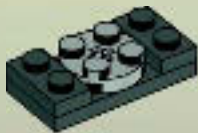

3

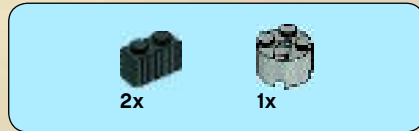

4







5

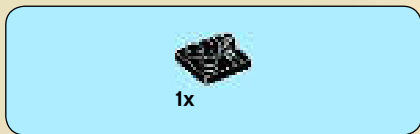

6

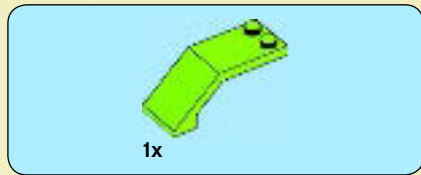

7

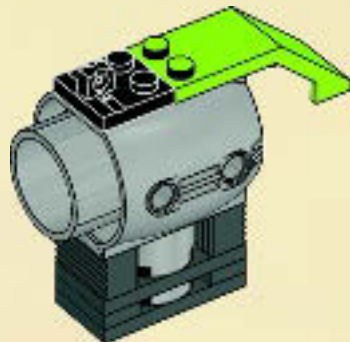

8

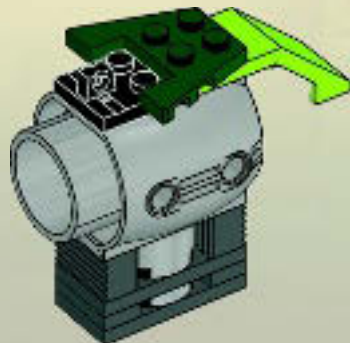



# NINJAGO

Masters of Spinjitzu



NINJAGO.COM





9445

9442

9443

9446

9567  
9552

9564

9563

9561

9552

9566

9566

9441  
9558  
9579



9444

9441  
9558

9441  
9444  
9446

9579

9562  
9440

9444  
9566

9551

9440  
9445  
9446  
9553  
9558

9562

9558

9563  
9567

9564





9551



9443



9446



9446



9443



9446



9552



9444  
9579



9561  
9553



9442  
9558



9579  
9558



9562



9564



9443



9442  
9445



9446



9446  
9551  
9558  
9561



9558  
9579



9579



9567



9553



9440



9445





# NINJAGO

Masters of Spinjitzu



9446



9445



9444



9443



9442



9441



9440





9

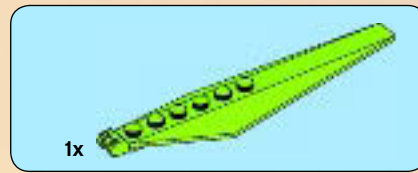
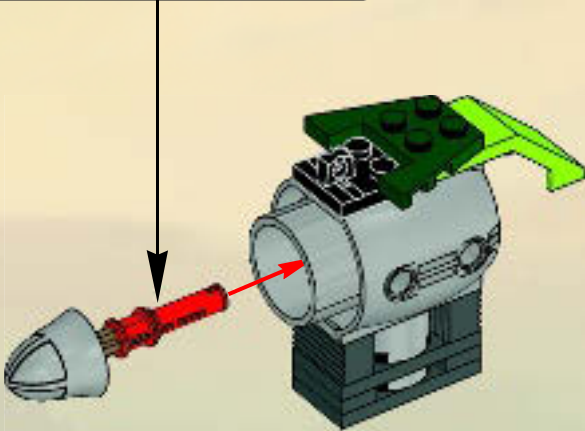
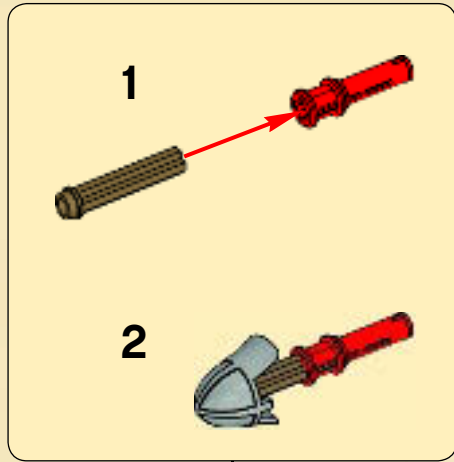

10

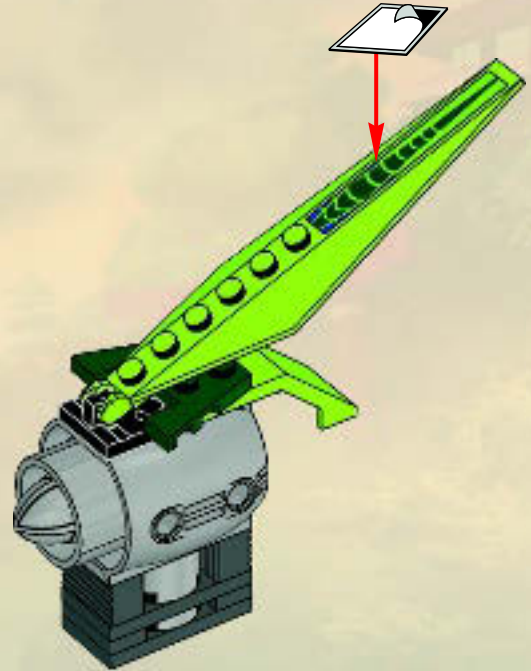



11

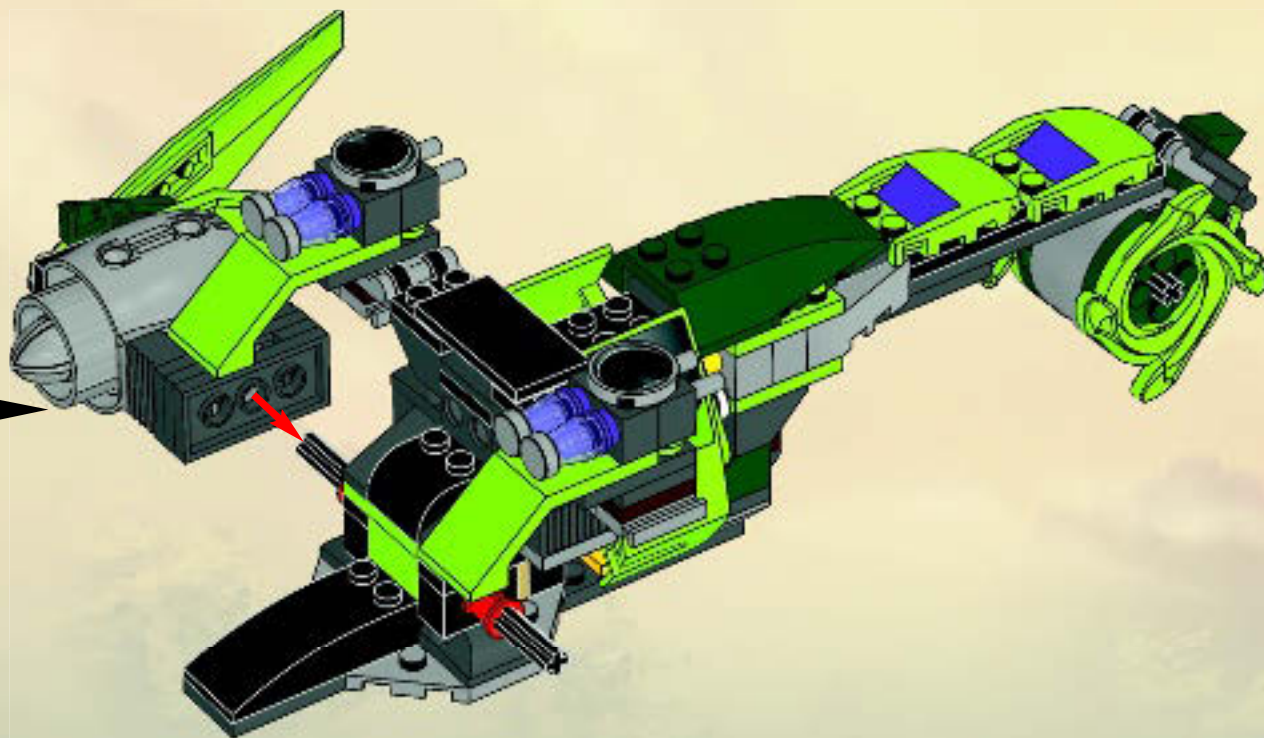



**1**



**2**



**3**



**4**





5



6

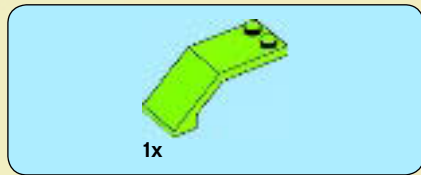

7

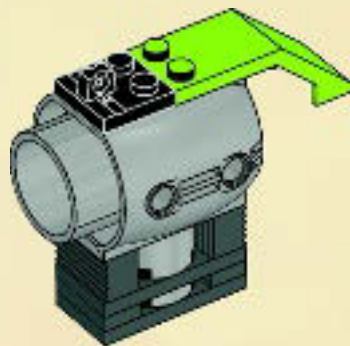

8

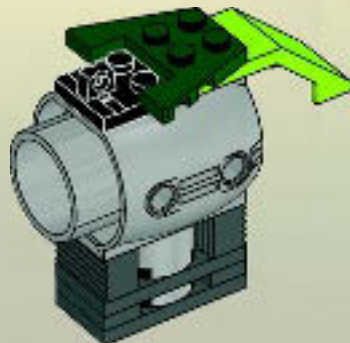



9

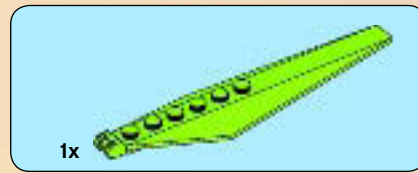
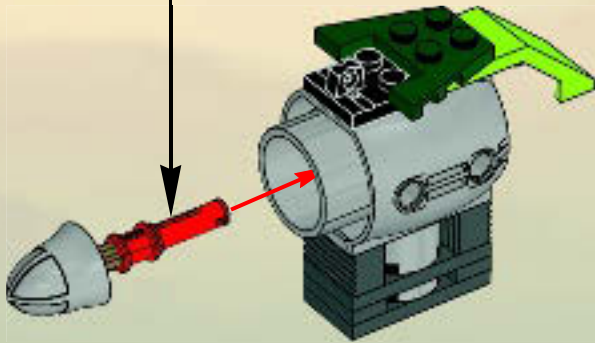
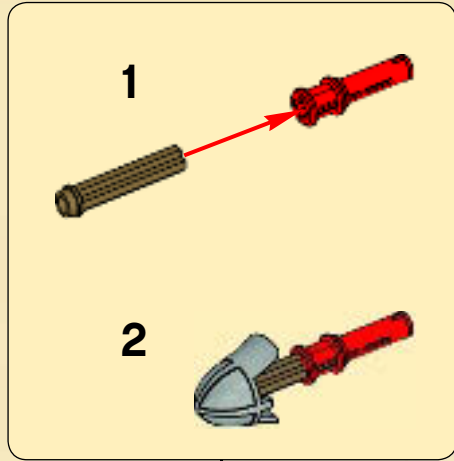

10

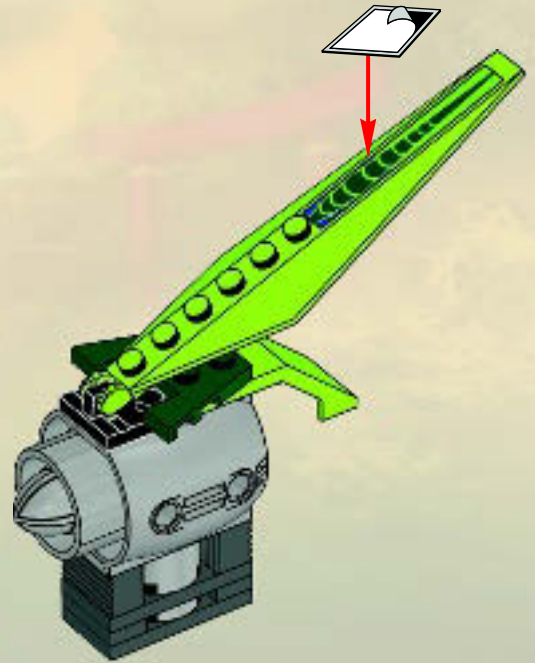

11

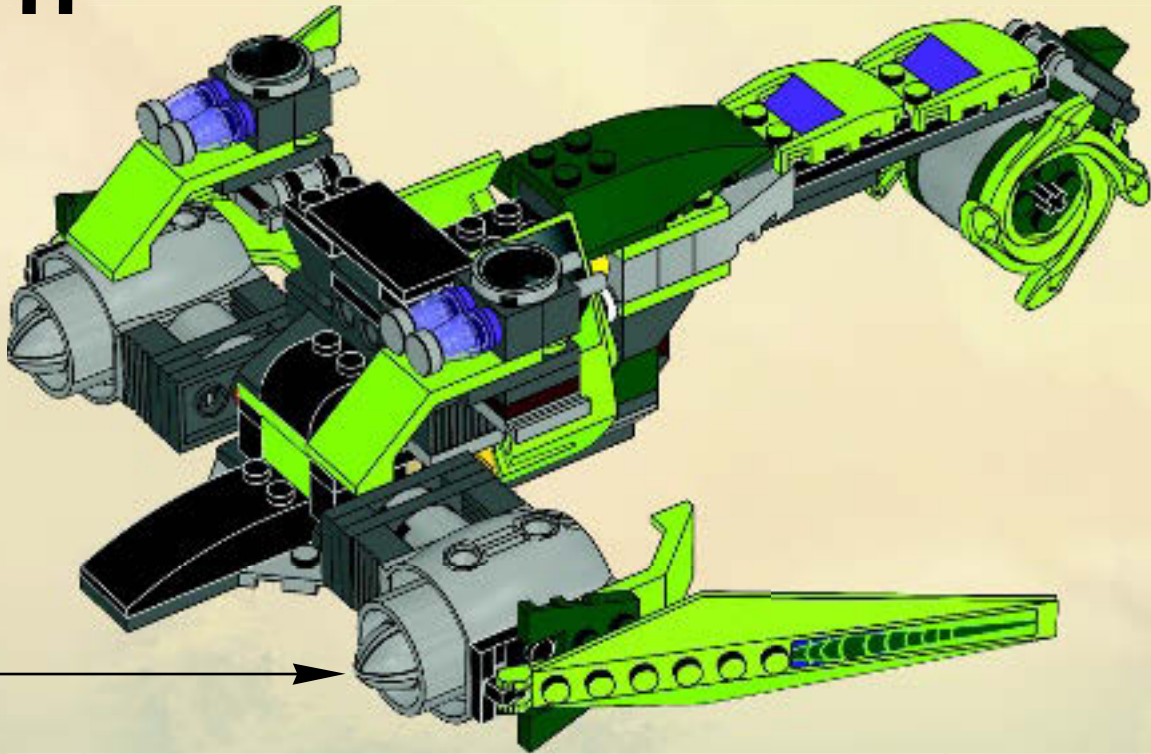



3



1x

1



1x



1x

2







1x

3



1x

4



1x

5





2x



2x

# 6

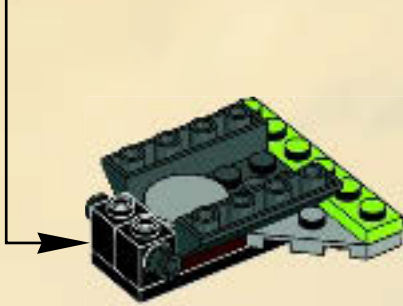
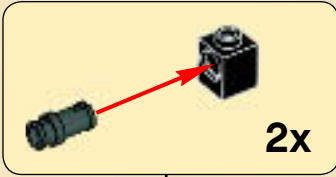

1x

# 7



4x



1x

# 8

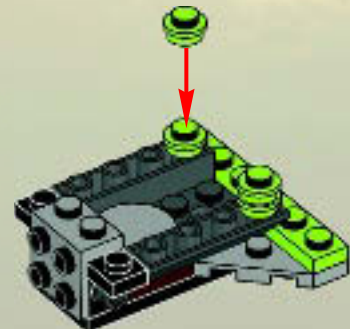



2x



1x

# 9

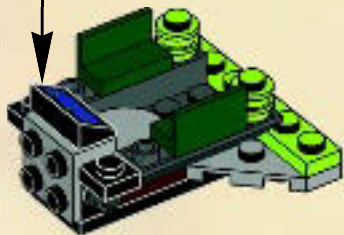
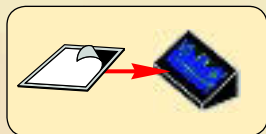

2x



1x

# 10

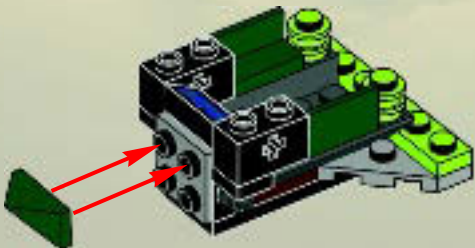

2x



2x

# 11

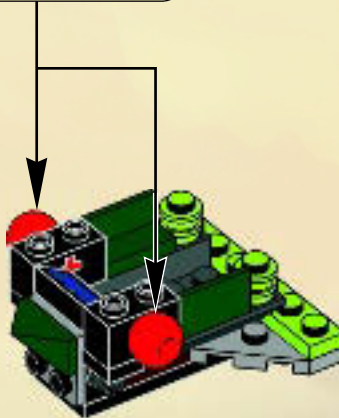
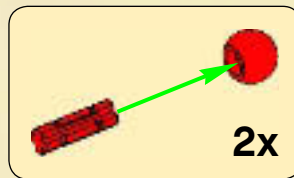

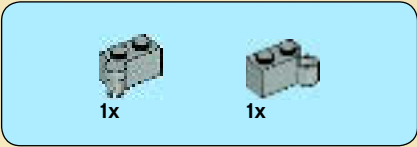

1

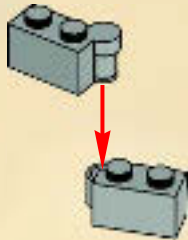

2

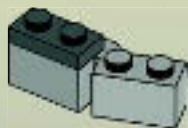

3

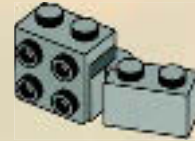

4

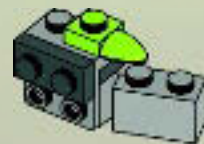



1x

5

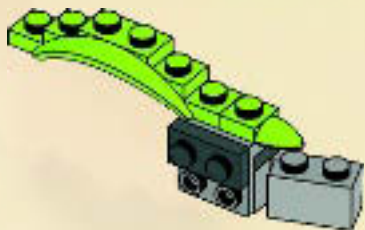

1x

6

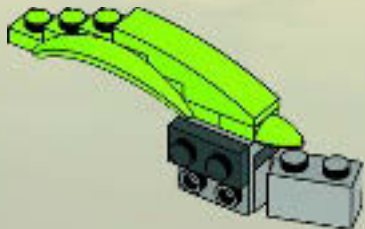

1x



1x

7

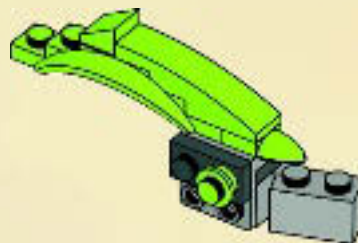

1x

8

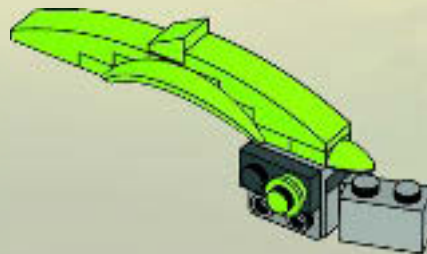

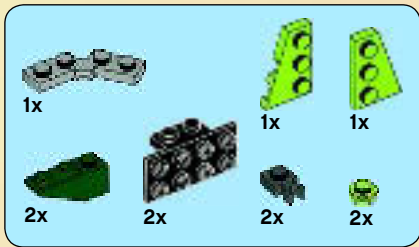

9

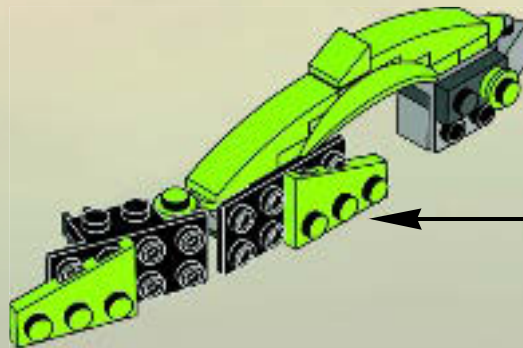
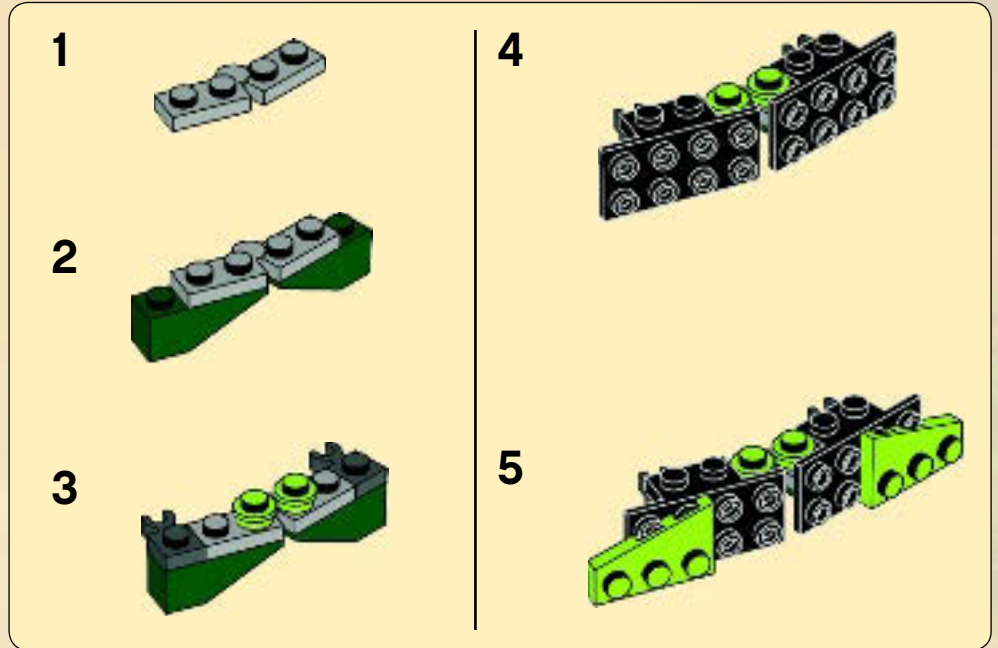



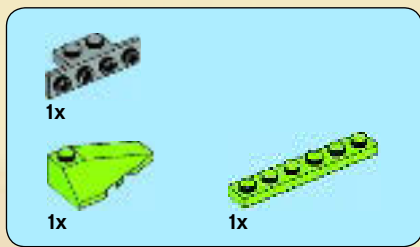

# 10

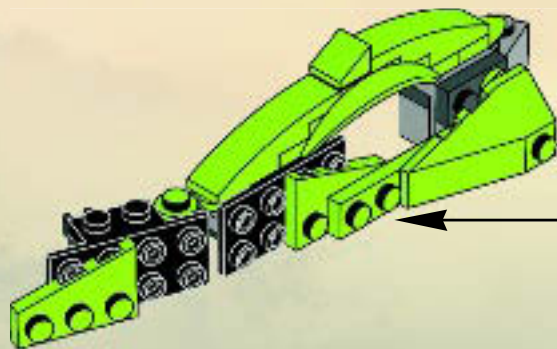
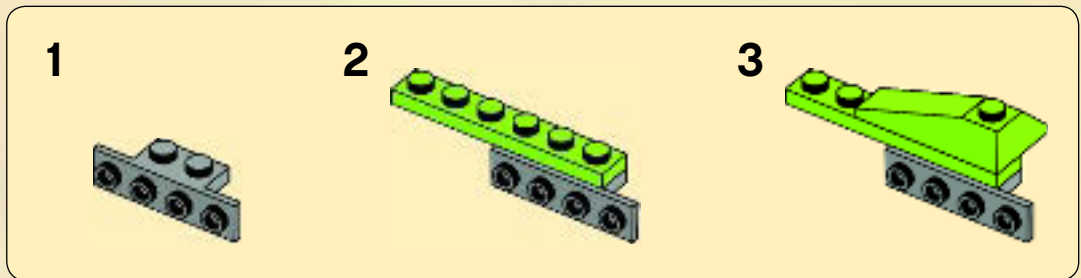

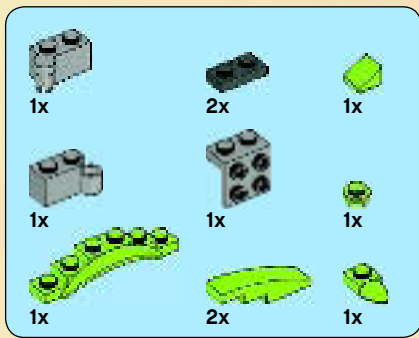

# 11

1

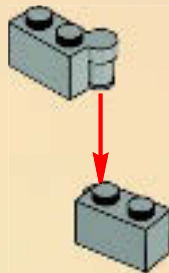

2

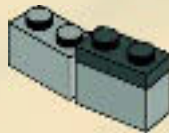

3

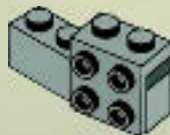

4

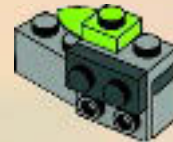

5

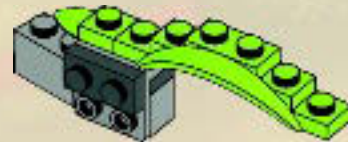

6

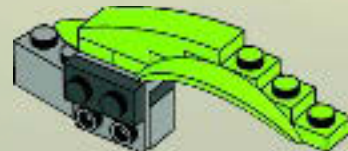

7

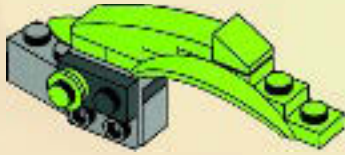

8

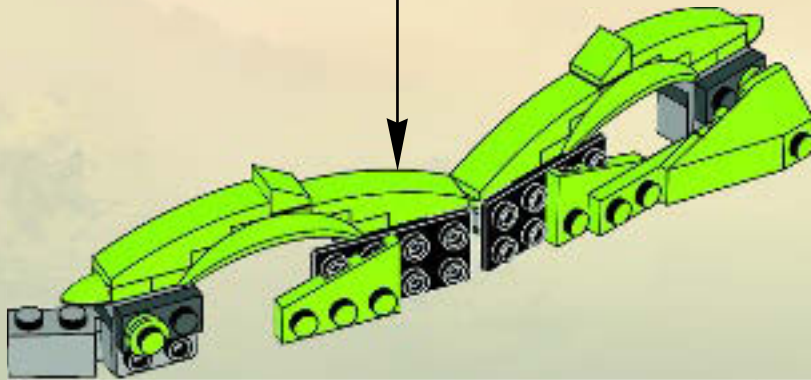
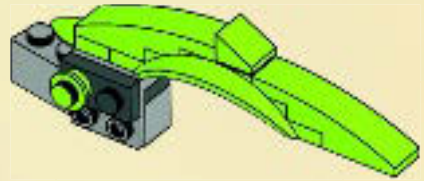

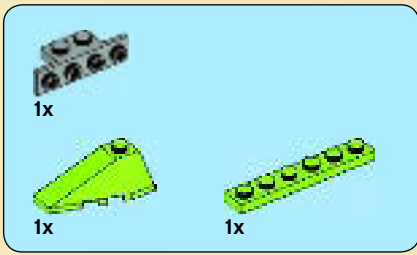

# 12

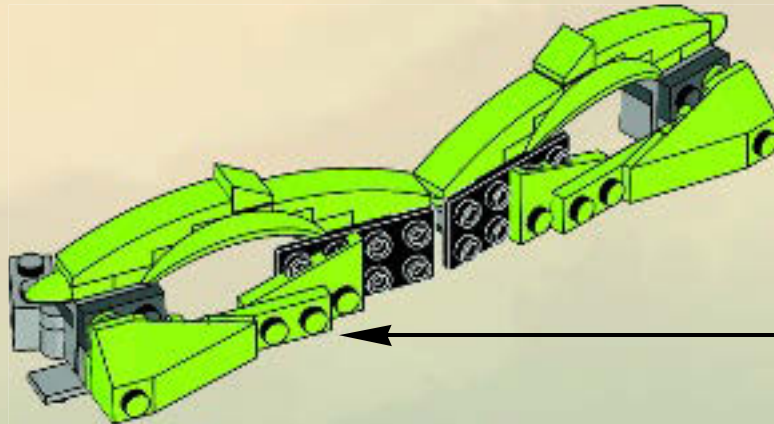
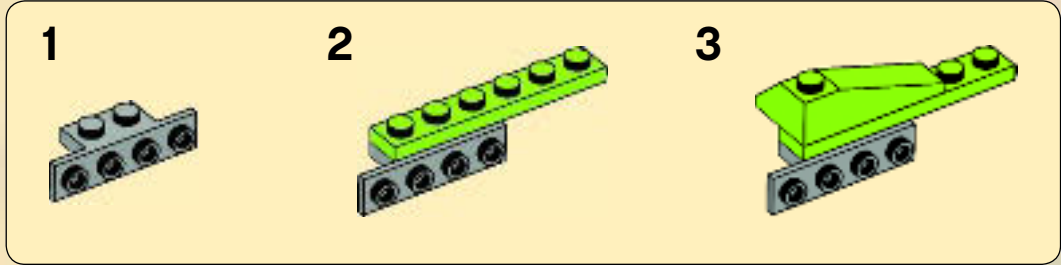

13

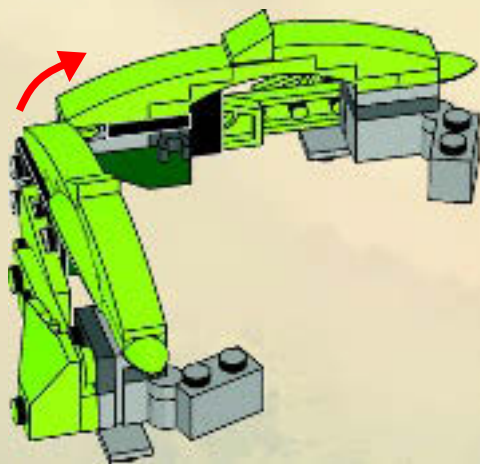

14

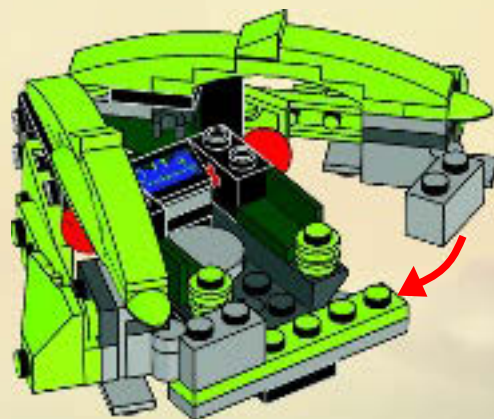



1

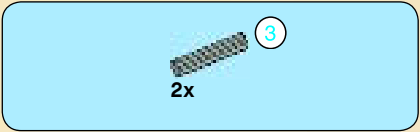

2

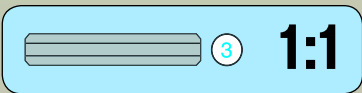
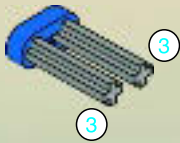

3

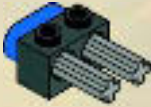

4

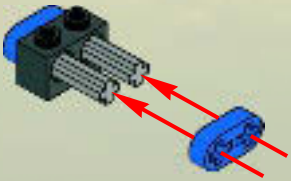





2x

5



1x



2x

6

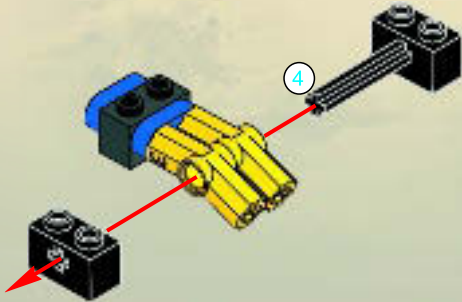

1:1



1x

7



2x

8

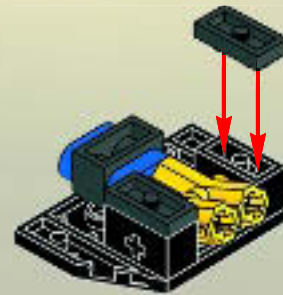
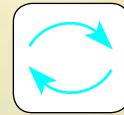



2x

9

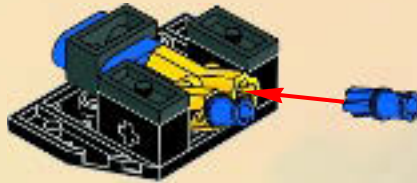

10

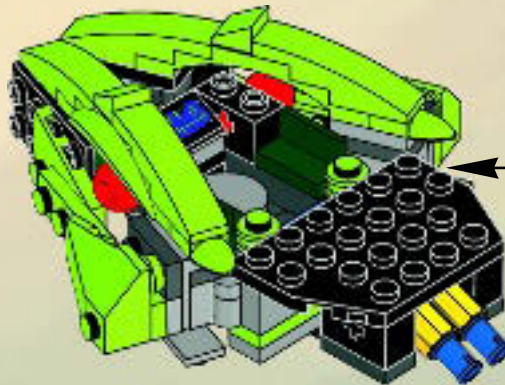



2x

# 11

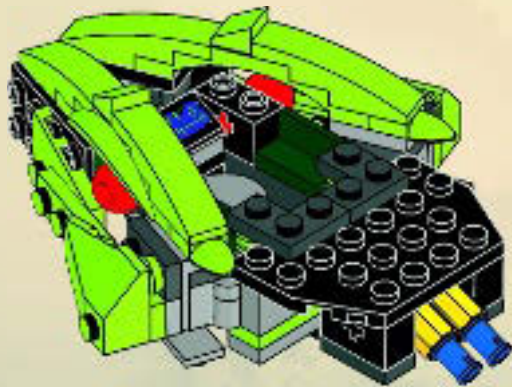

1x



1x



2x

# 12

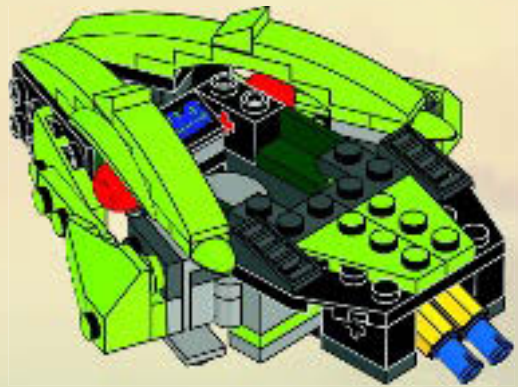



1x

# 13

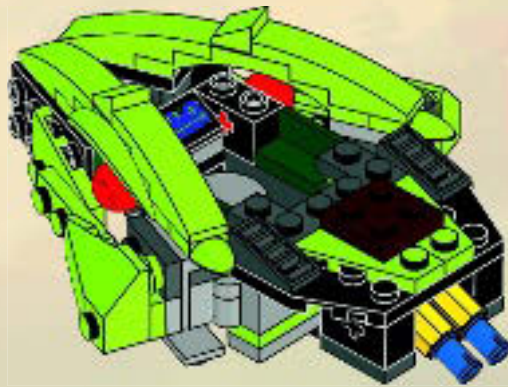

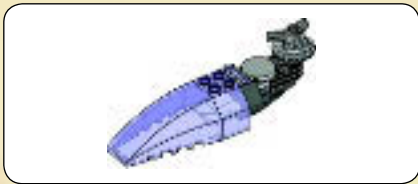

1x

1

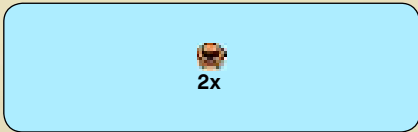

2x

2

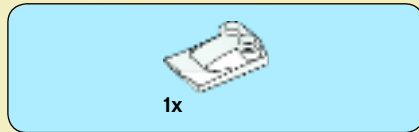

1x

3



1x

1x

4







2x

5



1x



2x

6

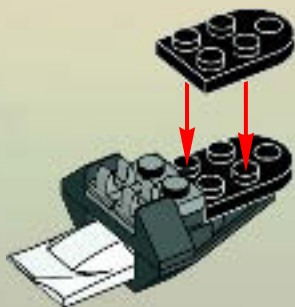

1x

7



1x



1x



1x

8

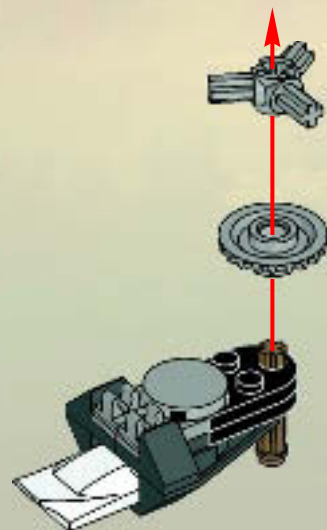

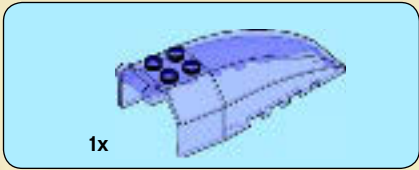

9

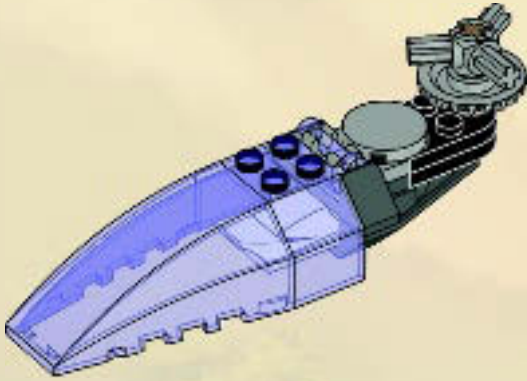

10

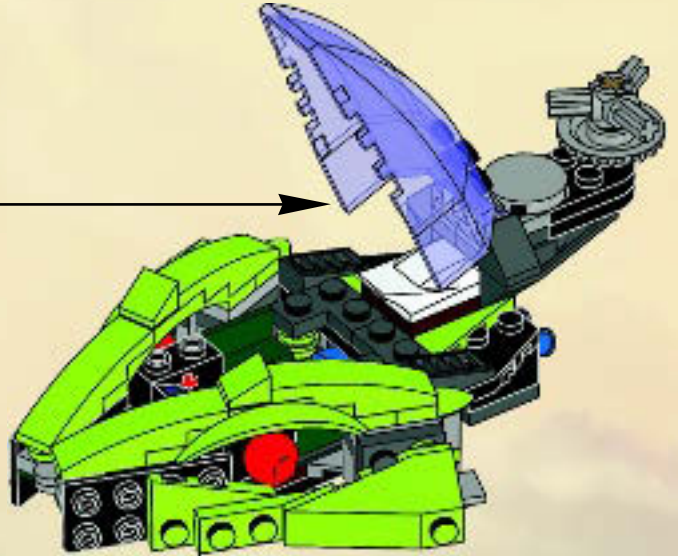

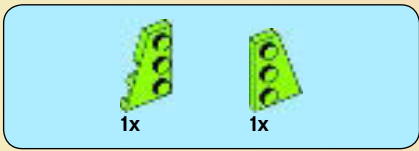

# 11

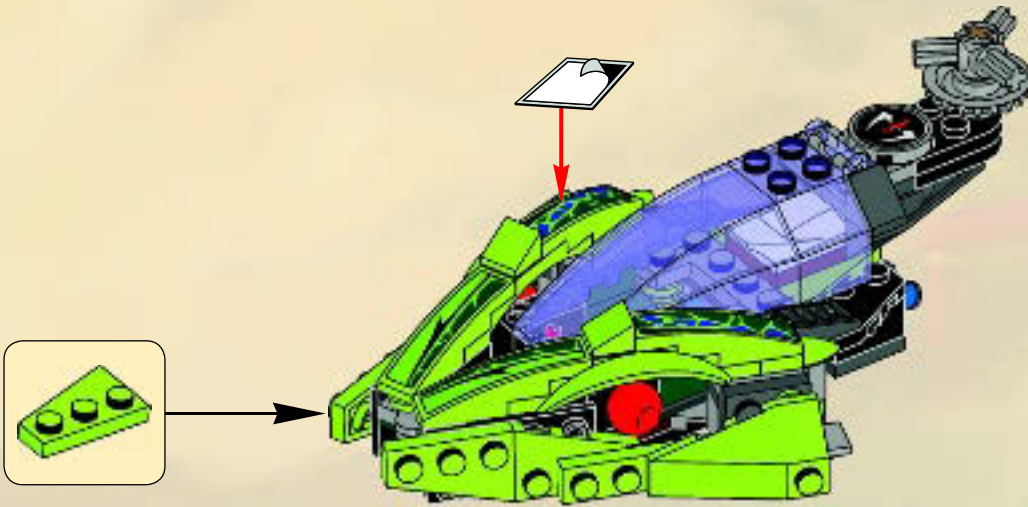

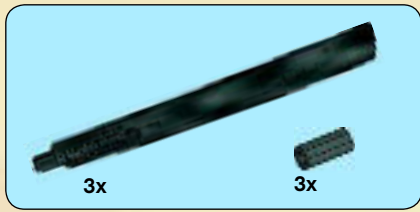

12

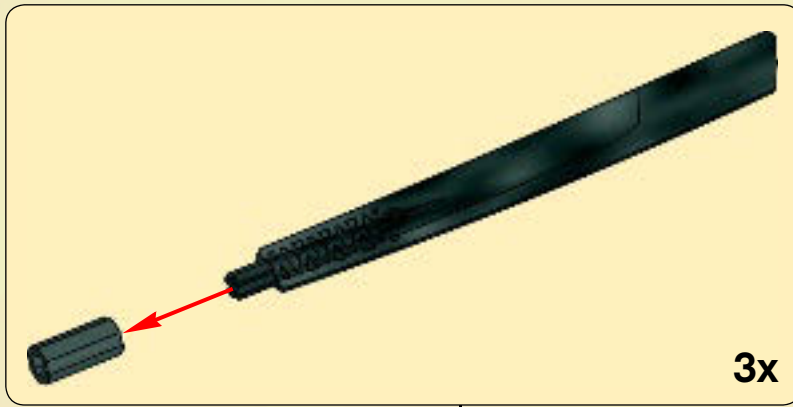

13







2x

14



15

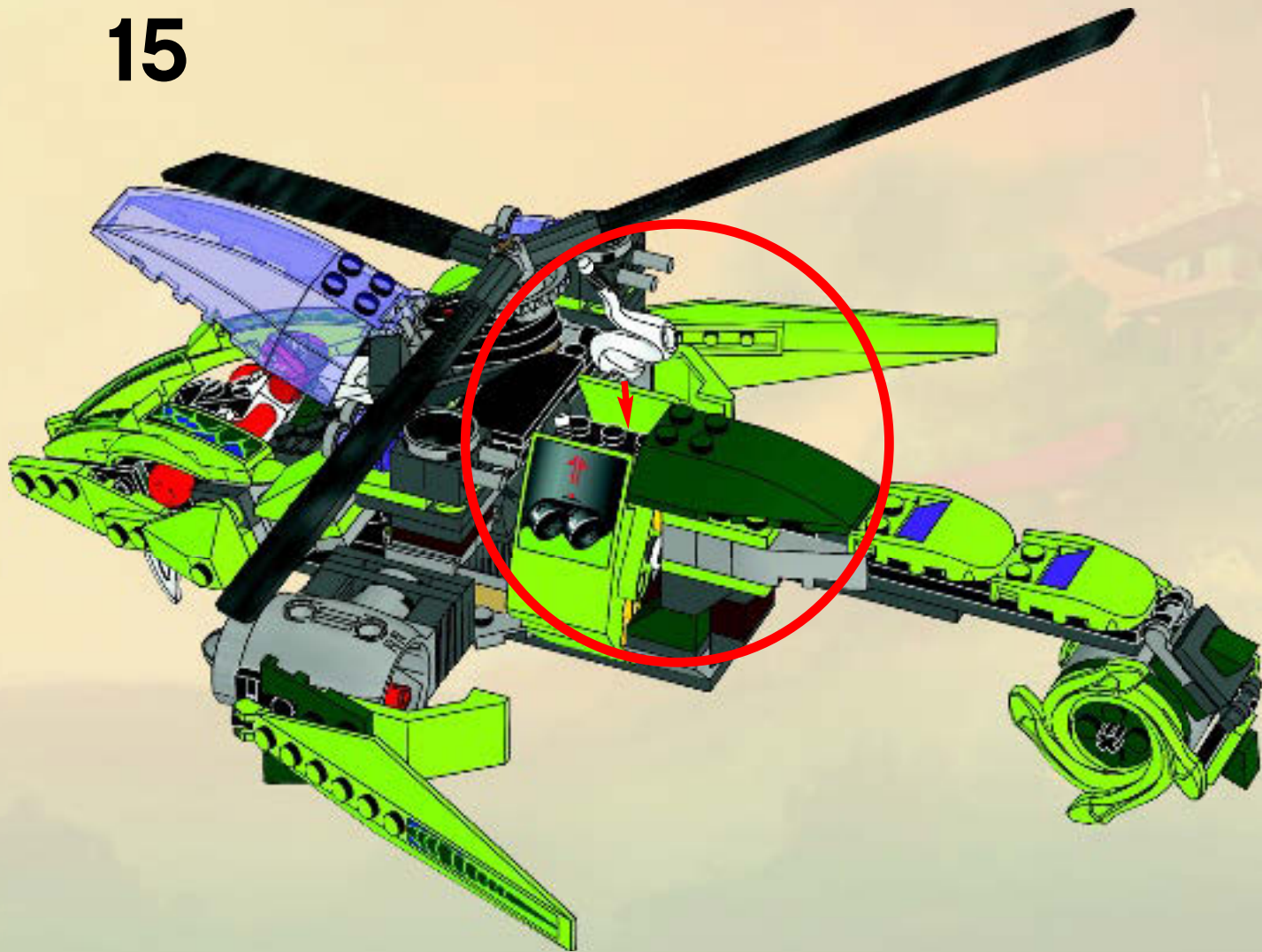

16

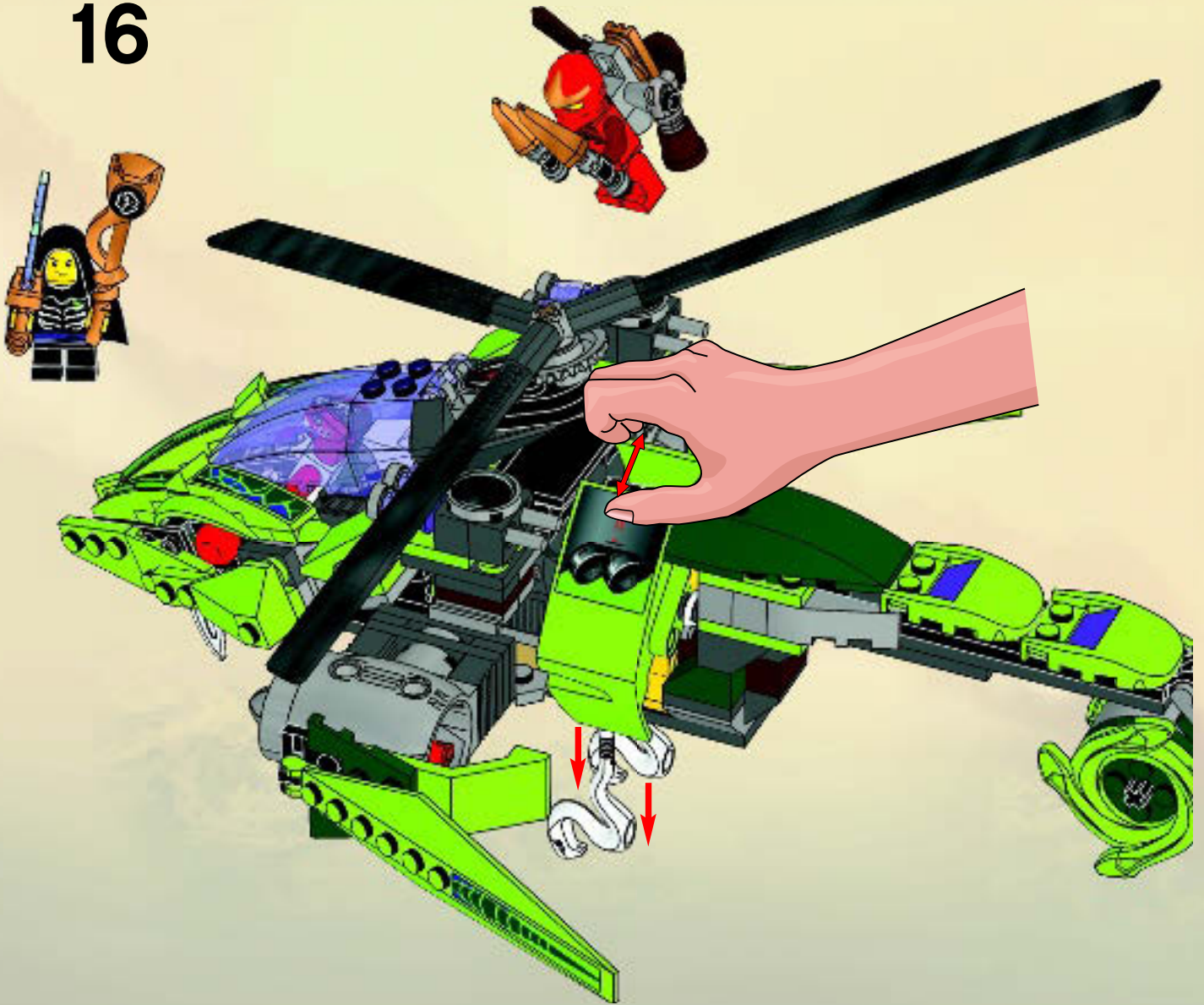



1x 4648338	2x 4290714	2x 654126	1x 4596914	1x 4537936	1x 4518814	1x 4612735			
1x 4647445	2x 4227155	1x 4548180	1x 4646676	3x 4529160	1x 4518814	2x 4649051			
2x 4646642	2x 4142865	1x 4227682	1x 4277668	1x 4500069	1x 4518816	2x 4612728			
1x 4610897	2x 4186834	1x 4180548	1x 4651017	12x 4183133	1x 4518816	2x 4612728			
1x 4544140	2x 4206482	3x 371026	1x 4121715	3x 4539907	4x 4567340	2x 4528713			
2x 4656205	1x 306824	3x 379526	4x 370526	3x 4539908	1x 4514700	1x 4653399			
1x 4114306	1x 4611424	1x 383226	1x 370726	4x 4567886	5x 4566927	1x 4216668			
1x 414306	1x 4647015	7x 4535739	4x 370526	4x 4567886	2x 4504375	4x 4216695			
1x 301021	1x 4647015	2x 4613759	1x 4165967	2x 4610474	1x 4266666	2x 4626196			
1x 4650487	2x 4142133	2x 317626	2x 4504372	2x 4611784	2x 4255624	2x 4626199			
1x 4650128	1x 4107823	2x 4616245	1x 4568655	2x 4567882	2x 4583837				
1x 4648363	3x 4239601	2x 4616245	1x 4568654	2x 4647108					
1x 4650117	1x 4235186	1x 4560182	1x 4568654	2x 4647108					
1x 4650117	10x 4233487	1x 4129572	4x 4537927	4x 4210210					

Customer Service  
Kundenservice  
Service Consommateurs  
Servicio Al Consumidor

[www.lego.com/service](http://www.lego.com/service) or dial



: 00800 5346 5555  
: 1-800-422-5346

1x  
4611100

2x  
4211526

1x  
4285771

2x  
4211441

1x  
4211517

1x  
4211452

4x  
4211480

2x  
4598526

3x  
4277927

4x  
4211568

3x  
4244627

2x  
4282740

1x  
4211464

1x  
4219256

4x  
4211475

4x  
4650260

3x  
4211352

2x  
4211827

2x  
4539481

1x  
4223363

1x  
4507052

2x  
4211767

2x  
4211460

2x  
4211461

4x  
4520320

1x  
4502595

2x  
4211815

1x  
4211639

1x  
4558690

7x  
4210636

6x  
4210762

2x  
4211096

2x  
4621917

4x  
4211000

2x  
4211045

1x  
4658974

1x  
4210906

16x  
4211063

1x  
4565322

2x  
4210635

3x  
4211043

5

3x  
4210997

2x  
4587212

1x  
4210763

1x  
4210660

4x  
4227398

2x  
4540386

6x  
4218696

4x  
4211050

3x  
4516546

2x  
4566607

4x  
4566522

1x  
4600525

1x  
4490599

4x  
4523159

1x  
4640843

1x  
4646828

2x  
4614710

2x  
4625812

3x  
4651532

2x  
4656148

1x  
4651579

1x  
4652932



**CUSTOMIZE YOUR SPINNERS**  
PERSONNALISE TES TOUPIES · PERSONALIZA TUS SPINNERS

**RATTLA**

**COLE ZX**

**9579**

**ARENA INCLUDED**  
**ARÈNE INCLUSE**  
**ARENA INCLUIDA**

**+**

**9551**

**9552**

**9553**

**CUSTOMIZE WITH BOOSTER PACKS**

**PERSONNALISE GRÂCE AUX BOOSTERS**

**PERSONALÍZALO CON PACKS DE REFUERZO**

**NINJAGO.COM**

**COLE ZX VS RATTLA**

**LASHA**

**KENDO ZANE**

**SNARPA**

**SAMIRAT X**

**HAI ZX**

**FANG-SUI**

**9579**

**9562**

**9563**

**9564**

**9566**

**9561**

**9567**





**KENDO ZANE**  
9563 - 9446



**KENDO KAI**  
9558



**KENDO COLE**  
9551



**COLE ZX**  
9579 - 9444



**ZANE ZX**  
9440  
9445



**JAY ZX**  
9553  
9442  
9445



**SAMURAI X**  
9566



**LLOYD GARMADON**  
9552 - 9443



**FANG-SUEI**  
9567 - 9443



**FANGDAM**  
9445



**LASHA**  
9562



**RATTLA**  
9579 - 9441



**SNAPPA**  
9564 - 9442









# NINJAGO

Masters of Spinjitzu



NINJAGO.COM

**LEGO club**  
FREE! GRATIS! GRATUIT!



www.LEGOclub.com



LEGO® Club Magazine



LEGO® Club Email

VISIT THE WORLD'S  
BIGGEST LEGO® SHOP!

www.LEGOshop.com

00800 5346 5555

1-866-534-6258 • 1-877-518-5346

© 2008 LEGO Group

Alle Rechte vorbehalten



- \* Freephone. Mobile charges may apply.
- \* Numéro sans frais. Des frais peuvent s'appliquer avec les téléphones cellulaires.
- \* Gebührenfrei, Kosten für Anrufe aus Mobilfunknetzen können abweichen.
- \* Gratis telefonnummer vanaf vaste lijn.
- \* Det er et gratis nummer, når du ringer fra fasttelefon.
- \* Det är gratis, när du ringer från en fast telefon.
- \* Numéro sans frais. Des frais peuvent s'appliquer avec les téléphones portables.

BI115

**YES!** I want to join the LEGO® Club FREE! **OUI!** Je veux m'abonner au LEGO® Club GRATUITEMENT !

**Ja!** Ich möchte Mitglied im kostenlosen LEGO® Club werden. **Ja!** Ik wil graag GRATIS lid worden van de LEGO® Club. **Ja!** Jeg ønsker å melde meg inn i LEGO® Club gratis! **Ja!** Jag vill gå med i LEGO® Club GRATIS!

First name • Prénom  
Vorname • Voornaam  
Fornavn • Förnamn

Last name • Nom de famille  
Name • Achternaam  
Etternavn • Efternamn

Date of Birth • Date de naissance  
Geburtsdag • Geboortedatum  
Fødselsdato • Födelsedatum

Boy • Garçon  
Junge • Jongen  
Gutt • Pojk

Girl • Fille  
Mädchen • Meisje  
Jente • Flicka

Street • Adresse  
Straße, Hausnr.  
Straat, huisnr. • Adress

City • Ville  
Ort • Woonplaats  
Poststed • Postort

State  
Prov. • County

Zip/Postcode  
Code Postal • PLZ  
Postcode  
Postnummer

Country  
Pays  
Land

Email • Courriel  
E-Mail • E-post

- Fill in your email address and we will send you a membership confirmation and monthly email newsletters. If you do not wish to receive the newsletters please tick here. Remplis ton adresse e-mail et nous t'enverrons une confirmation d'adhésion ainsi que le bulletin e-mail mensuel. Si tu ne désires pas recevoir le bulletin, coche cette case. Vul je e-mailadres in en we sturen je een bevestiging van je lidmaatschap en maandelijke e-mail nieuwsbrieven. Als je geen e-mail wilt ontvangen, kruis dan dit vakje aan.
- Ich möchte per E-Mail den monatlichen LEGO Club Newsletter erhalten. Ønsker du at vi skal sende en liten hilsen til barnet ditt for å bekrefte medlemskapet, ber vi deg krysse av i feltet, samt oppgi e-postadressen som hilsenen skal sendes til. Om du vill att vi ska skicka en bekräftelse på ditt barns medlemskap, ber vi dig sätta ett kryss i rutan och skriva den e-post adress som bekräftelsen ska skickas till.
- If you do not wish to receive additional mailings from the LEGO Club please tick here. Si tu ne désires pas recevoir de courrier supplémentaire du Club LEGO, coche cette case. Als je geen verdere post van de LEGO Club wilt ontvangen, kruis dan dit vakje aan.
- Dersom du ønsker å motta annen informasjon fra LEGO Gruppen, setter du et kryss her.

Mail to: / Poster à:



LEGO® Club  
P.O. Box 1157  
Enfield, CT USA  
06083-1157

Per Post an:



LEGO® Club  
Postfach 14 15  
D-36243 Niederaula

Send til:



LEGO® Club Norge  
Postboks 58  
1314 Vøyenenga

Mail to:



LEGO® Club  
33 Bath Road  
Slough SL1 3UF  
United Kingdom

Stuur na naar:



LEGO® Club  
Postbus 40250  
3504 AB Utrecht

Skickas till:



LEGO® Club Sverige  
Ubox 841  
202 29 Malmö

Poster à:



LEGO® Club  
21 rue de la banque  
75 002 PARIS  
FRANCE

The English language version of the magazine can only be mailed to addresses in the US, Canada, the UK, and Republic of Ireland. Club membership is valid for two years and includes free copies of the LEGO Club Magazine and e-mail newsletters in the US and Canada please allow up to 6 weeks for delivery of your first magazine. In the UK and Republic of Ireland please allow six to 14 weeks for delivery of your first magazine. By signing this form you consent the LEGO Club to use your child's data for LEGO mailings. The data will only be used for LEGO mailings and will not be sold, rented or otherwise disclosed to any company outside the LEGO Company except for disclosure to companies acting as our agents to help us provide services requested by the child. This coupon is valid for one free membership per person, group or organization. Photocopied coupons are accepted.  La version française du magazine peut être postée uniquement au Canada. L'abonnement est valide pour 2 ans et inclut des exemplaires gratuits du Magazine LEGO Aux É.U. et au Canada, allouer 6 semaines pour la livraison initiale. En remplissant ce formulaire, vous consentez à ce que LEGO utilise les informations de votre enfant pour des envois postaux de LEGO. L'information sera utilisée uniquement pour des envois postaux par LEGO et ne sera en aucun cas, vendue, louée, échangée ou divulguée à d'autres compagnies autres que la compagnie LEGO, à l'exception des compagnies aïeées qui nous procurent des services auxquels l'enfant en a fait la demande. Formulaire photocopiés acceptés.  Mit der folgenden Unterschrift erkläre ich, für mein Kind den Beitritt als Mitglied zum kostenlosen LEGO Club, der von der LEGO GmbH, D-85628 Grasbrunn, betrieben wird. Die Mitgliedschaft beinhaltet die Zusendung des LEGO Club Magazines und kann beiderseits jederzeit beendet werden. Mit der Mitgliedschaft im LEGO Club sind keinerlei Verpflichtungen verbunden. Das deutschsprachige LEGO Club Magazin wird nur an Adressen in Deutschland, Österreich und der Schweiz versendet. Eine Anmeldebestätigung kann nur per E-Mail geschickt werden. Das Magazin erscheint fünfmal jährlich. Daher kann die Zustellung des ersten Heftes bis zu drei Monate dauern. Die Mitgliedschaft ist beidseitig jederzeit kündbar, ohne dass Ihnen Kosten entstehen. Sie können der werblichen Nutzung Ihrer Daten jederzeit widersprechen. Kündigung und Widerspruch können Sie telefonisch erklären (00800 / 5346 5555, Anruf gebührenfrei, Kosten für Anrufe aus dem Mobilfunknetz können abweichen) oder an die LEGO GmbH senden.  Het Nederlandse LEGO Club Magazine kan alleen worden gestuurd naar adressen in Nederland. Het lidmaatschap is 2 jaar geldig en geeft recht op toezending van het gratis LEGO Club Magazine en LEGO Club e-mails. Het eerste magazine zal binnen 12 tot 14 weken toezestuurd worden. Het lidmaatschap kan op ieder moment opgezegd worden en kan na 2 jaar gratis worden verlengd, tenzij LEGO met deze activiteit stopt. Uw gegevens worden uitsluitend gebruikt voor mailings van LEGO en zullen niet worden verkocht, verhuurd of op welke wijze dan ook verstrekt aan derden buiten de LEGO Groep, uitgezonderd de organisaties die namens ons optreden om de informatie te sturen waarvoor toestemming is verleend.  Den norske utgaven av magasinet sendes kun til adresser i Norge. Medlemskap i klubben gjelder 12 år og inkluderer gratisutgaver av LEGO Club Magazine. Prøven minimum opplikkes seks uker leveringstid for første magasin. Ved å undertegne dette skjemaet, gir du ditt samtykke til at LEGO Club kan bruke opplysningene om barnet ditt i LEGO foresendelser. Dataene vil utelukkende bli brukt i LEGO foresendelser og vil ikke bli solgt, utleid eller på annen måte gjøres tilgjengelig for selskaper utenfor LEGO gruppen, unntatt selskaper som er våre agenter og som hjelper oss å tilby tjenestene barnet etterseer. Dette skjemaet gjelder for ett gratis medlemskap per person, gruppe eller organisasjon.  Den svenska versionen av tidningen kan endast skickas till adresser i Sverige. LEGO medlemskapet är g giltigt 12 år och innefattar gratis exemplar av LEGO Club Magazine. Vänligen räkna med minimum 6 veckor för leverans av den första tidningen. Genom att skicka in det här formuläret godkänner du att LEGO Club använder barnets uppgifter för LEGO utskick. Uppgifterna kommer bara att användas för LEGO utskick och kommer inte att säljas, hyras ut eller vidarebefordras till något företag som inte tillhör LEGO Gruppen, med undantag av företag som agerar som våra ombud för att tillhandahålla tjänster som barnet har begärt. Den här kupongen gäller för ett gratis medlemskap per person, grupp eller organisation.  En complétant ce bulletin d'adhésion, vous acceptez que LEGO Club utilise les données relatives à votre enfant pour l'envoi de courriers concernant LEGO. Ces données seront uniquement utilisées pour l'envoi d'information concernant LEGO et ne seront ni vendues, ni louées, ni utilisées par d'autres sociétés que le groupe LEGO, à l'exception des sociétés agissant pour le compte de LEGO en tant que sous-traitant de services divers. L'abonnement au LEGO Club est valable pour une période de 2 ans. Il inclut l'envoi par courrier du magazine LEGO Club et par email des newsletters. Un délai de 6 à 14 semaines est à prévoir pour la réception de votre premier magazine. Ce bulletin d'adhésion gratuit est valable pour l'inscription d'une seule personne. Les photocopies sont acceptées. ATTENTION! Le bulletin d'adhésion doit être rempli et signé par un parent ou un tuteur.

Parent's signature • Signature d'un parent ou d'un tuteur •  
Unterschrift Erziehungsberechtigter • Handtekening ouders •  
Foreldres/foresattes underskrift • Föräldras/förmyndares underskrift

Date  
Datum  
Date



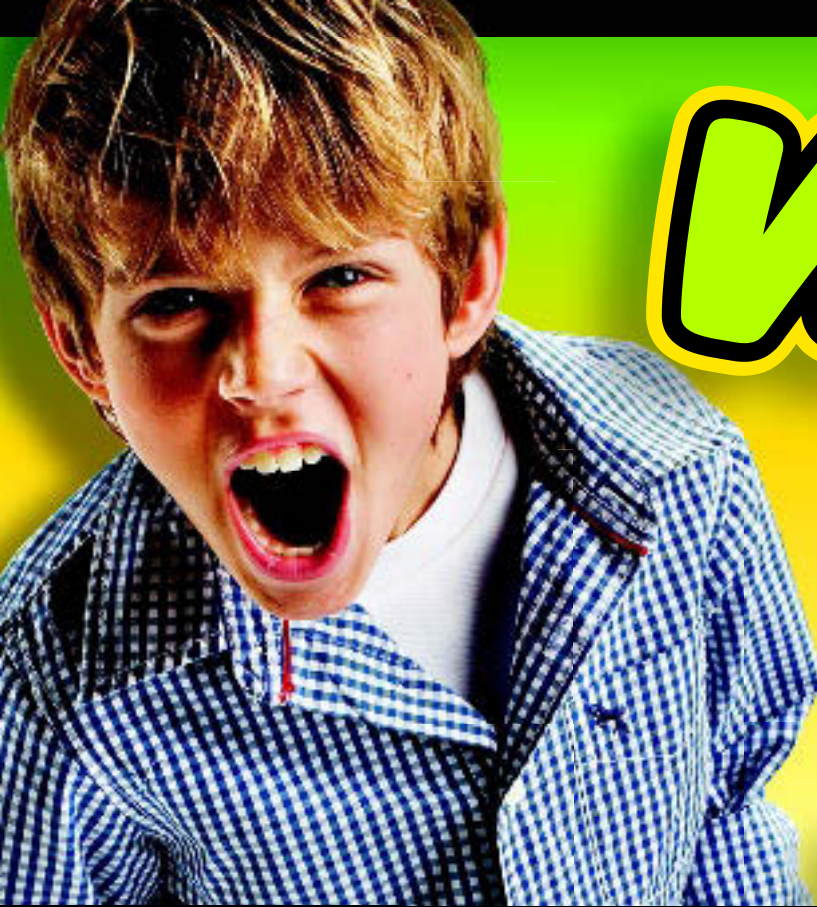

# WIN!

Go to [www.LEGOsurvey.com/product](http://www.LEGOsurvey.com/product)  
to fill out a survey for a chance  
to win a cool LEGO® Product.

No purchase necessary.

Open to all residents where not prohibited.



[www.LEGO.com](http://www.LEGO.com)



## [www.LEGOsurvey.com/product](http://www.LEGOsurvey.com/product)

### GEWINNE! WIN!

Nimm an der Umfrage auf  
[www.LEGOsurvey.com/product](http://www.LEGOsurvey.com/product)  
teil und hab die Chance ein cooles  
LEGO® Produkt zu gewinnen!

Die Teilnahme am Gewinnspiel führt zu keinerlei  
Kaufverpflichtungen. Teilnahme in allen nicht  
ausgeschlossenen Ländern möglich.

Ga naar [www.LEGOsurvey.com/product](http://www.LEGOsurvey.com/product),  
vul een enquêteformulier  
in en maak kans op een  
cool LEGO® product.

Geen aankoopverplichting.  
Iedereen mag deelnemen, uitzonderend  
ingezetenden van landen waar een  
enquêteverbod geldt.

### GAGNE! 当てよう!

Visite [www.LEGOsurvey.com/product](http://www.LEGOsurvey.com/product)  
pour répondre à un  
questionnaire et avoir une chance de  
gagner un produit LEGO® très cool!

Aucune obligation d'achat.  
Ouvert à tous les résidents des pays  
autorisés.

[www.LEGOsurvey.com/product](http://www.LEGOsurvey.com/product) にアクセスして、  
アンケートにご記入ください。当選者にはレゴ®  
製品を差し上げます。

お買い上げの必要はありません。

禁止されていない限り、すべての皆様にご利用いただけます。