



# NINJAGO

Mas



9446



CONVERTS

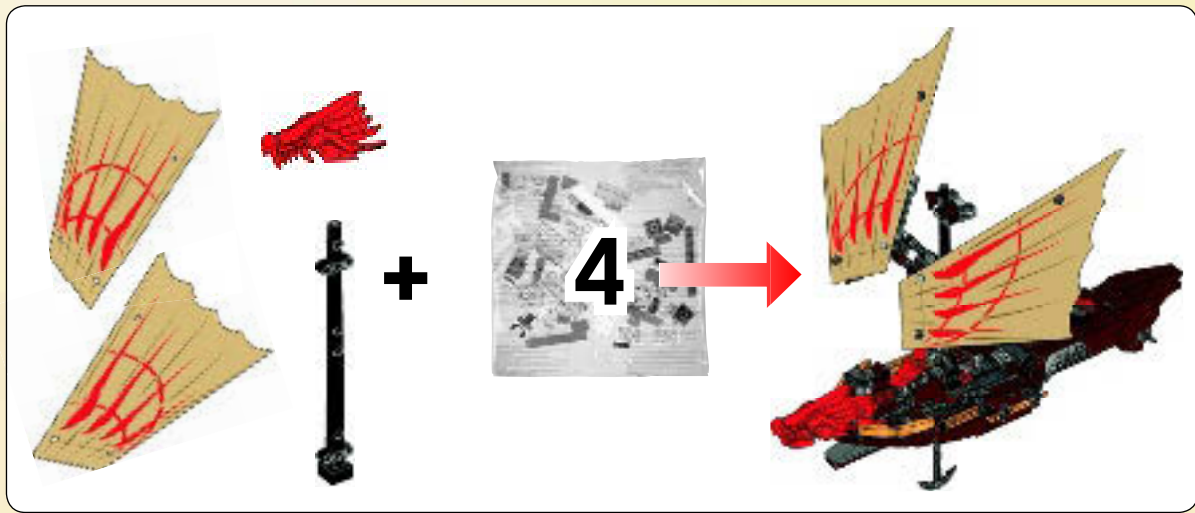

**CONVERTS  
SE TRANSFORME  
SE CONVIERTE**

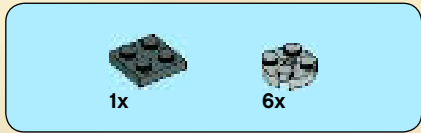

**55**

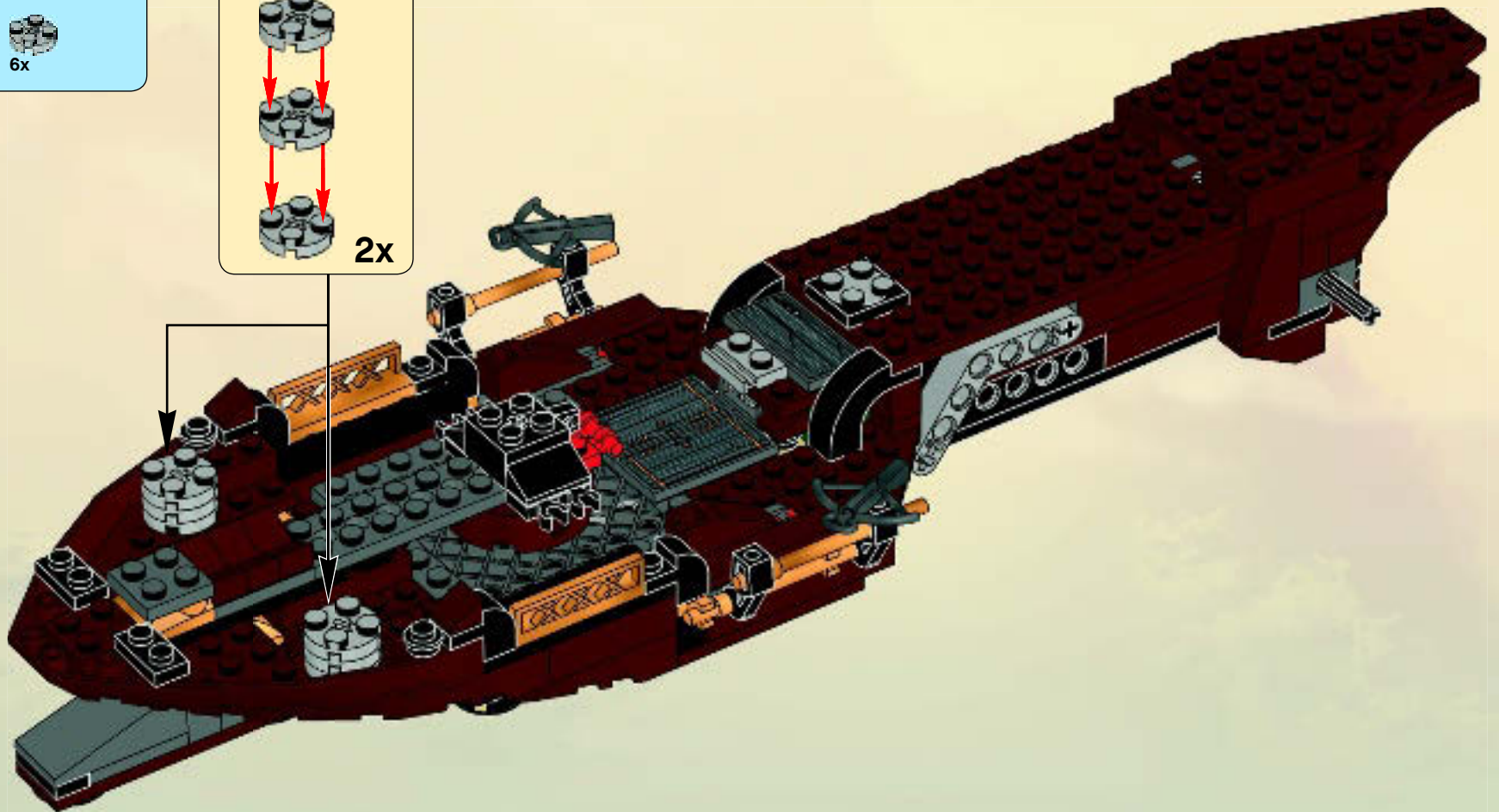
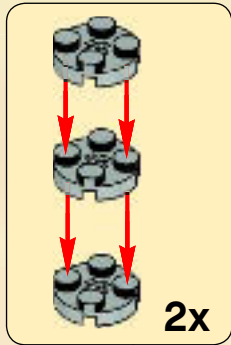

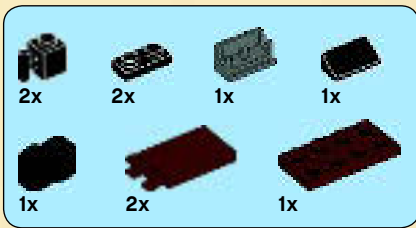

56

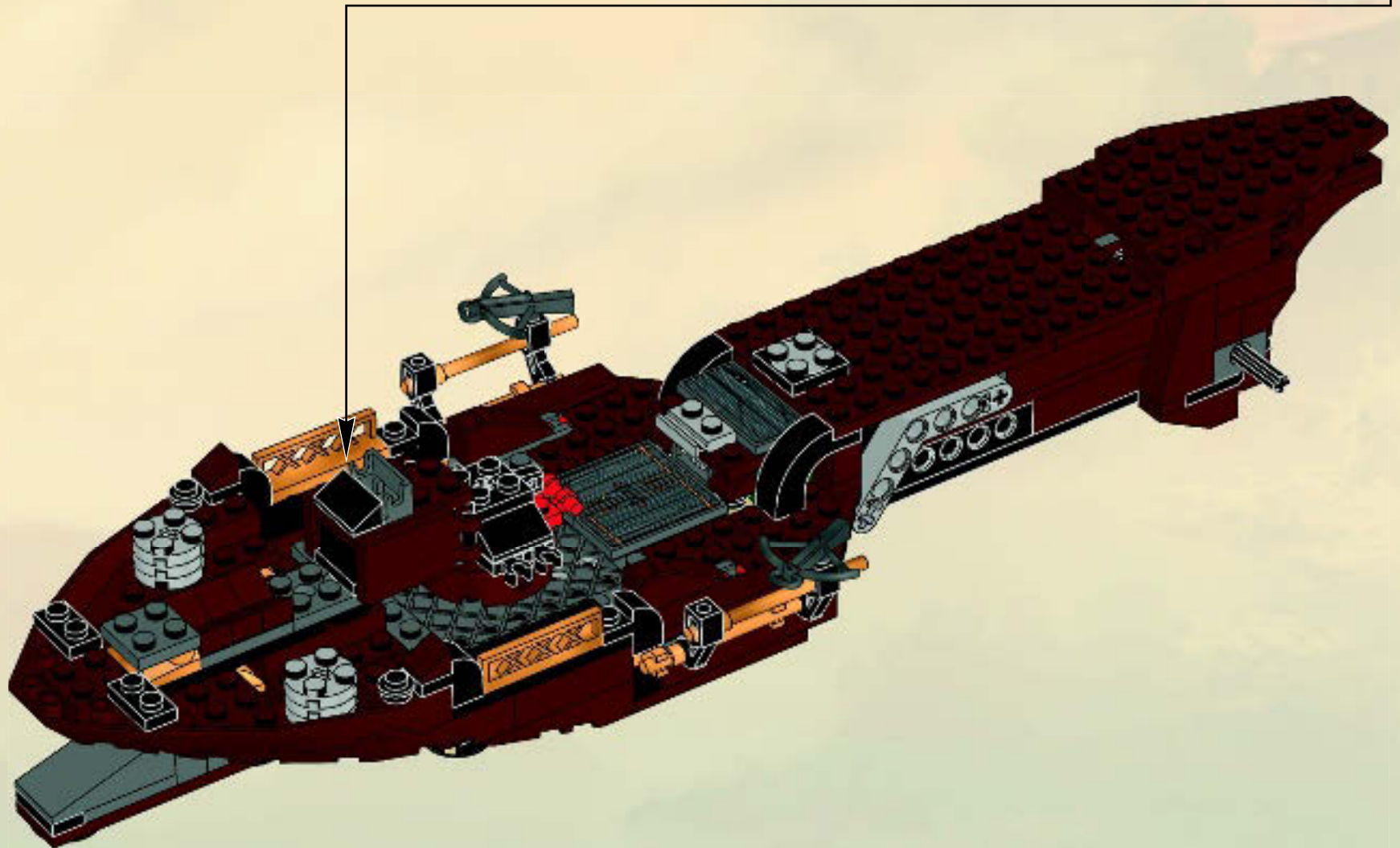
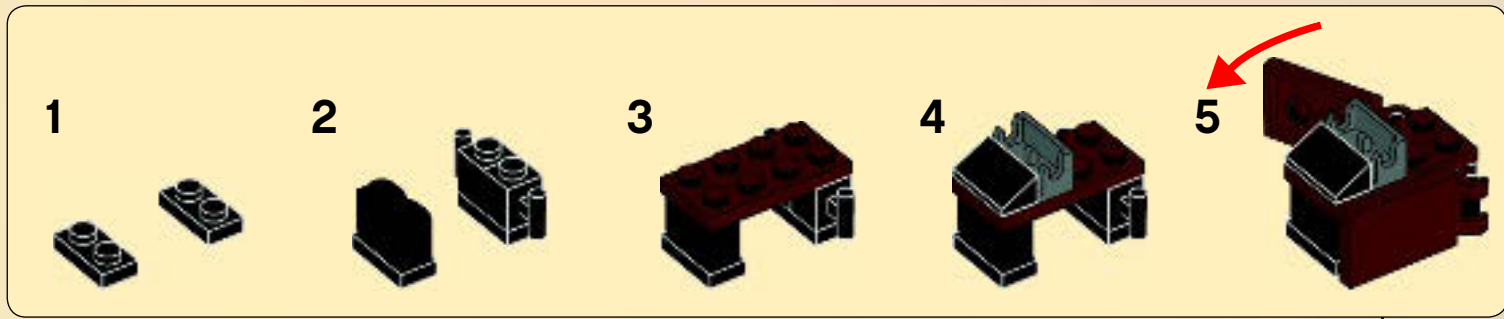

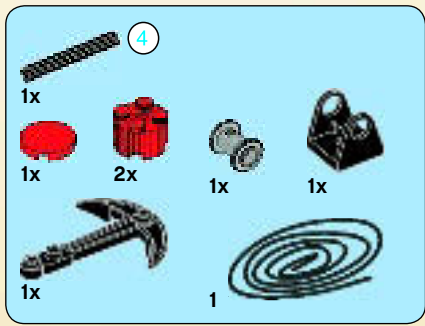

57

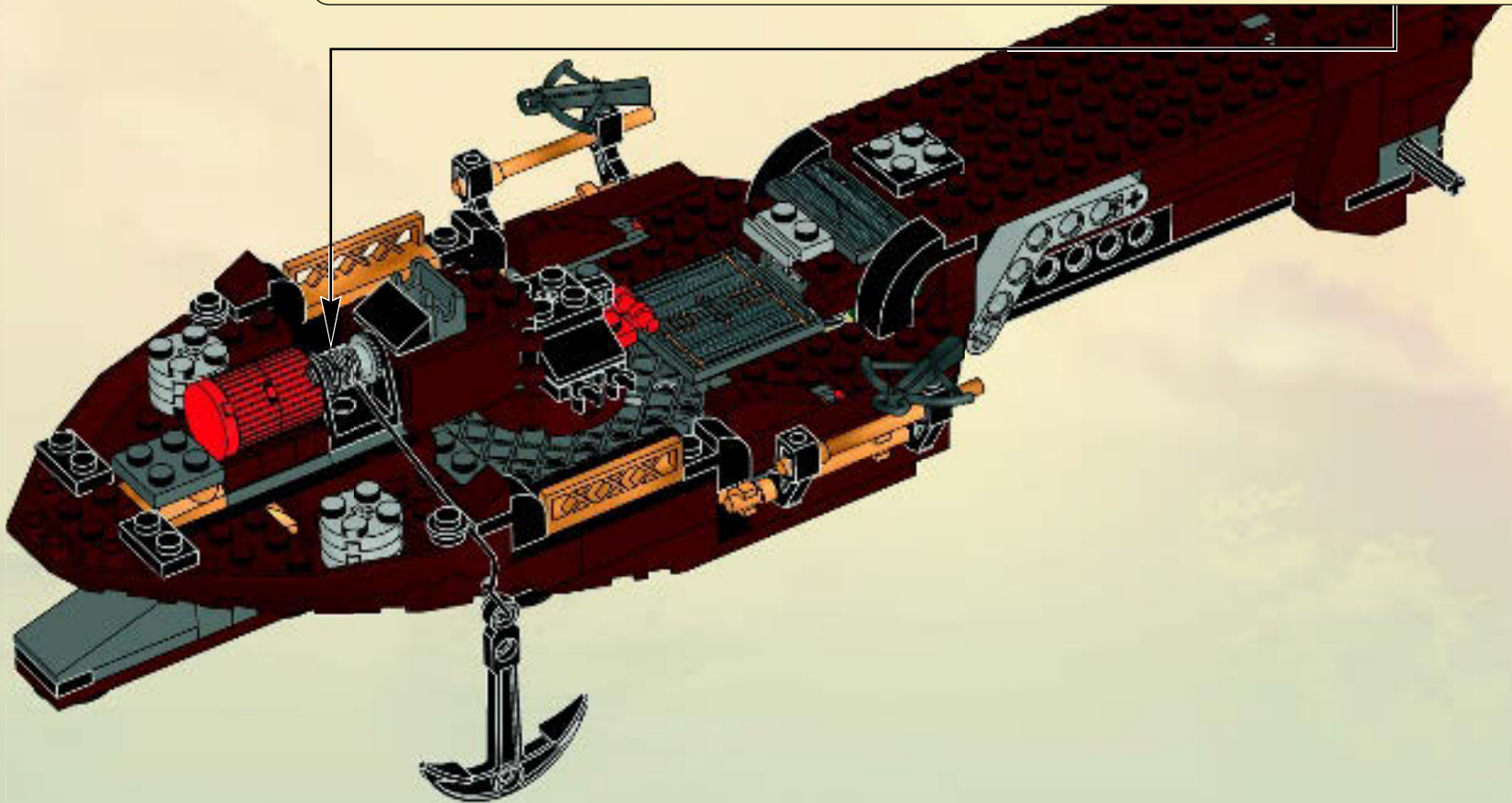
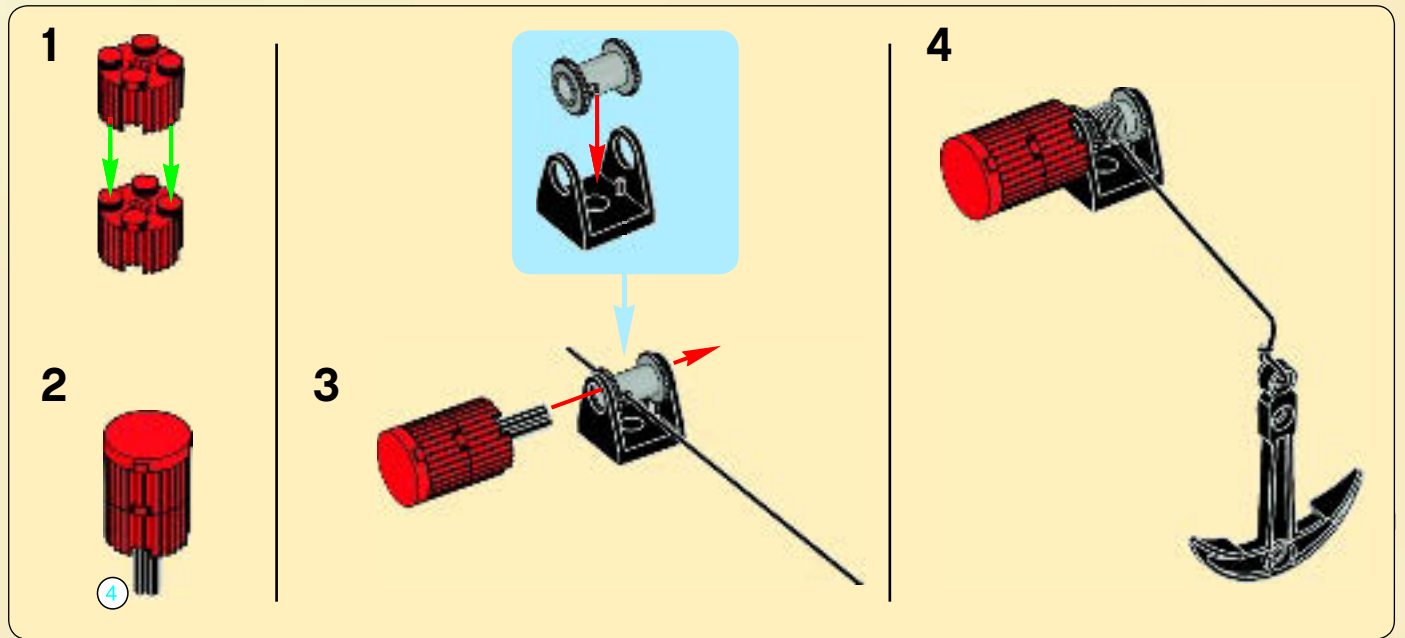

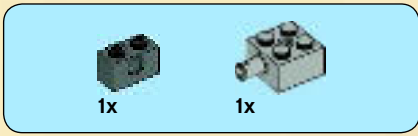

1

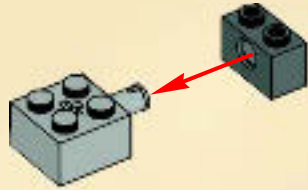

2

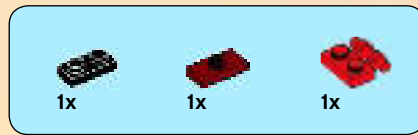

3

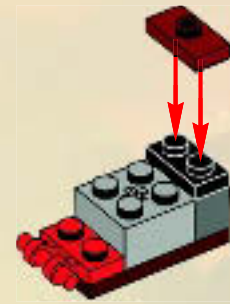

4

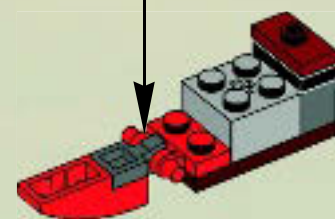

58

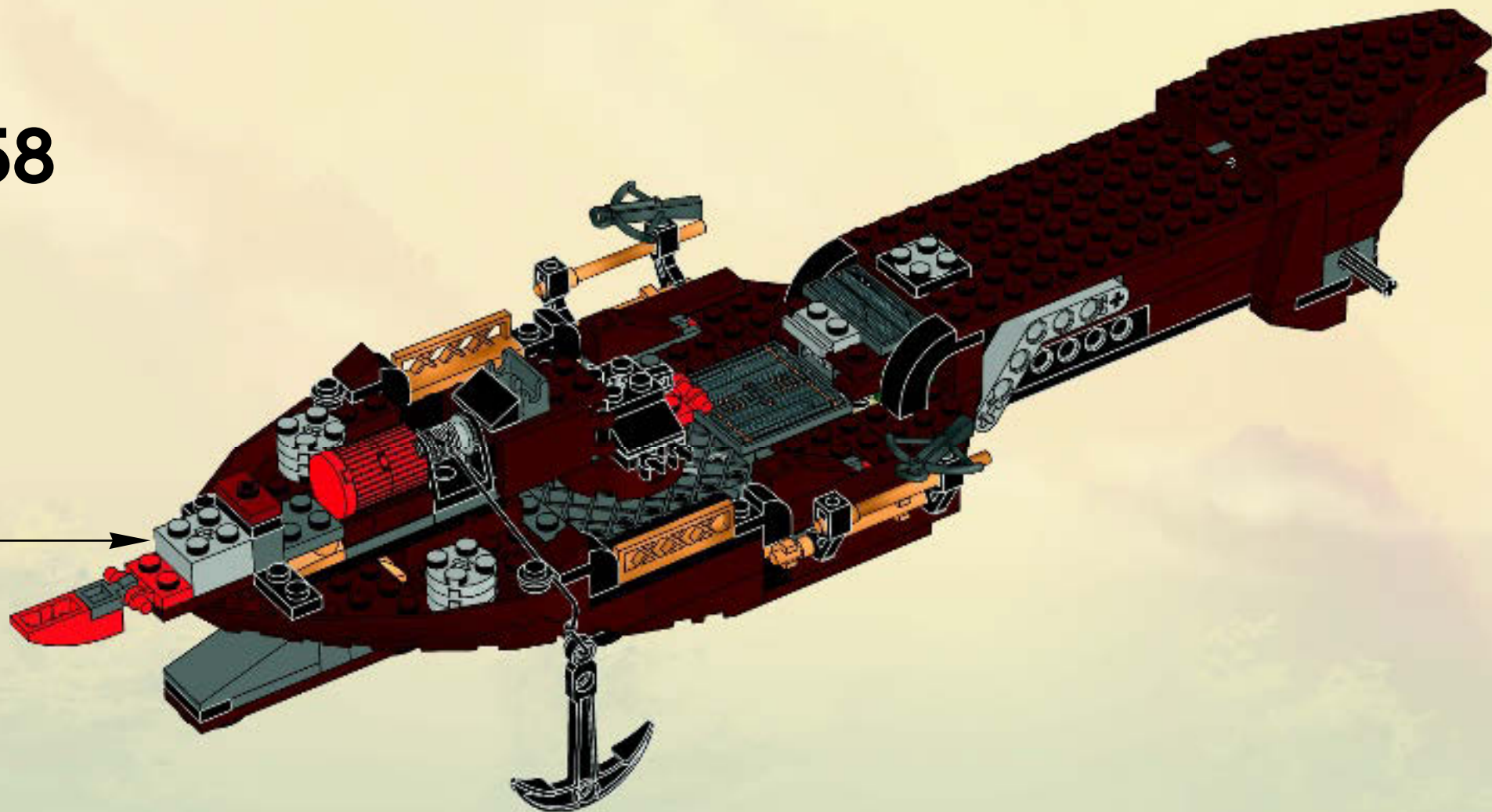



59

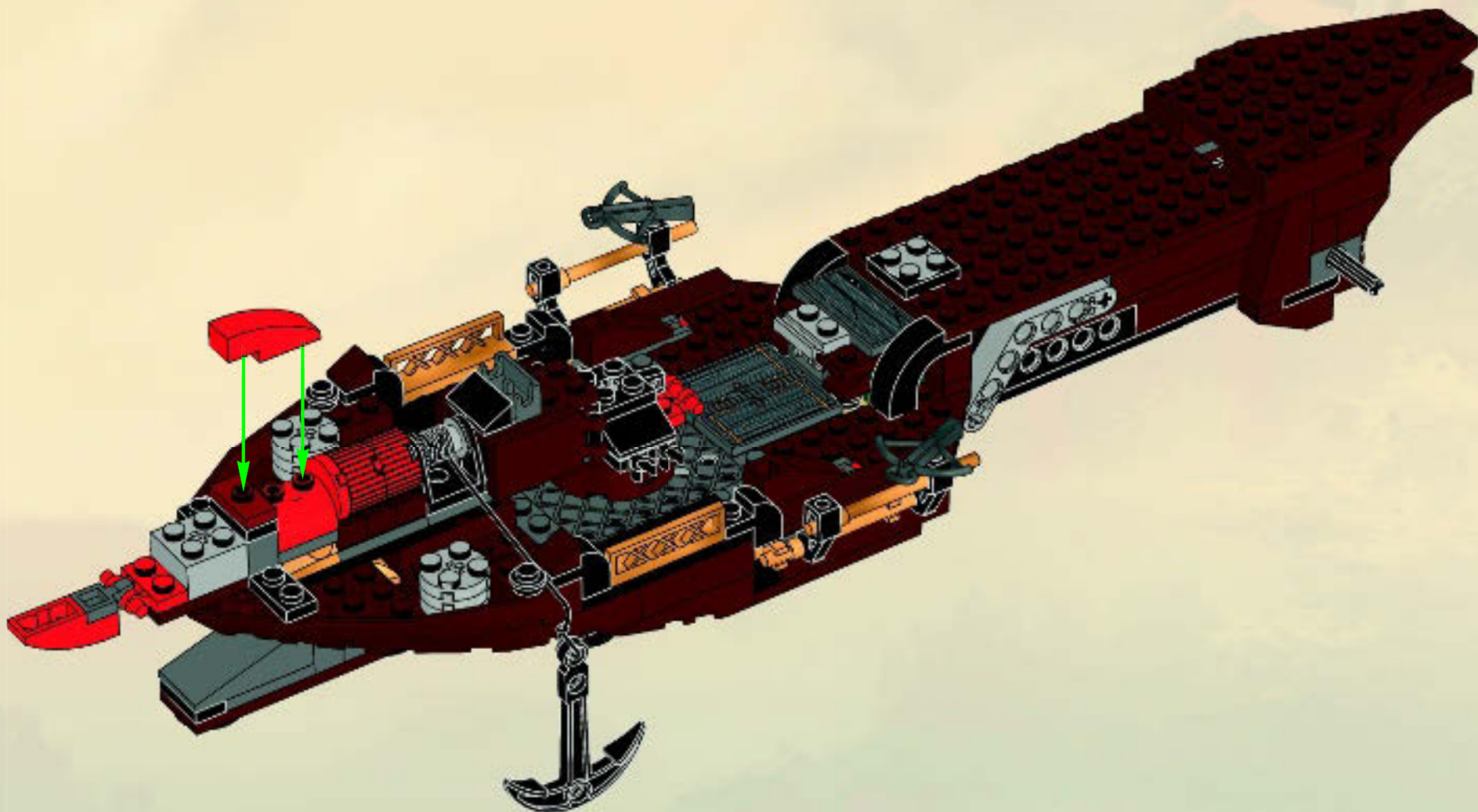

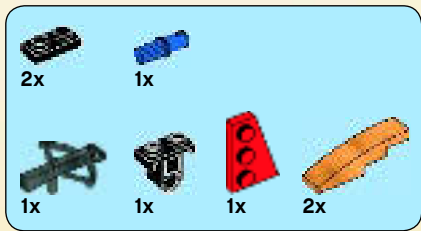

60

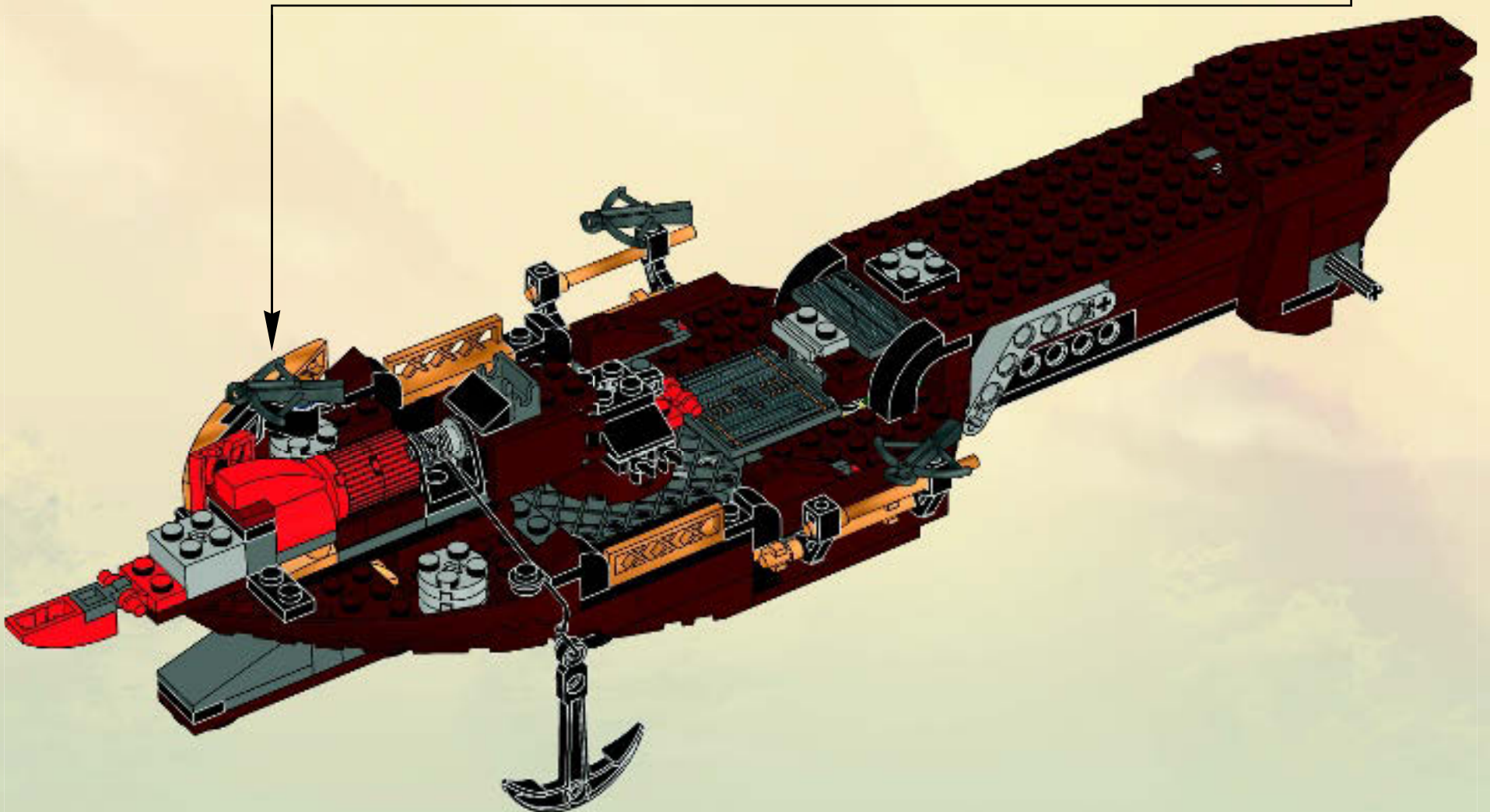
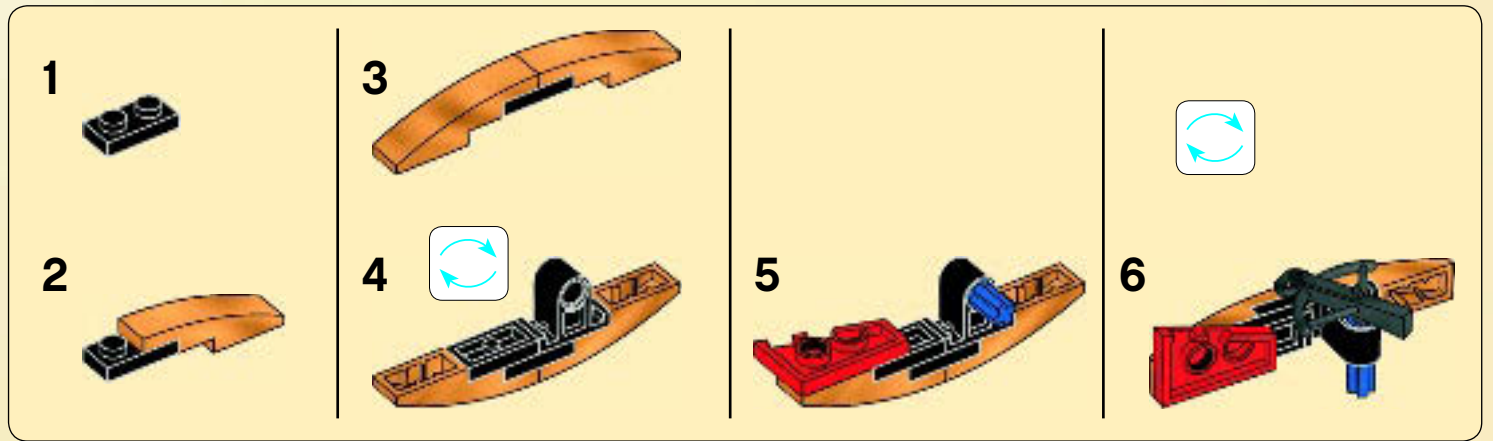



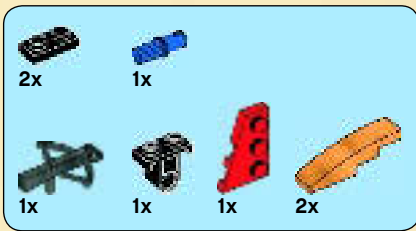

61

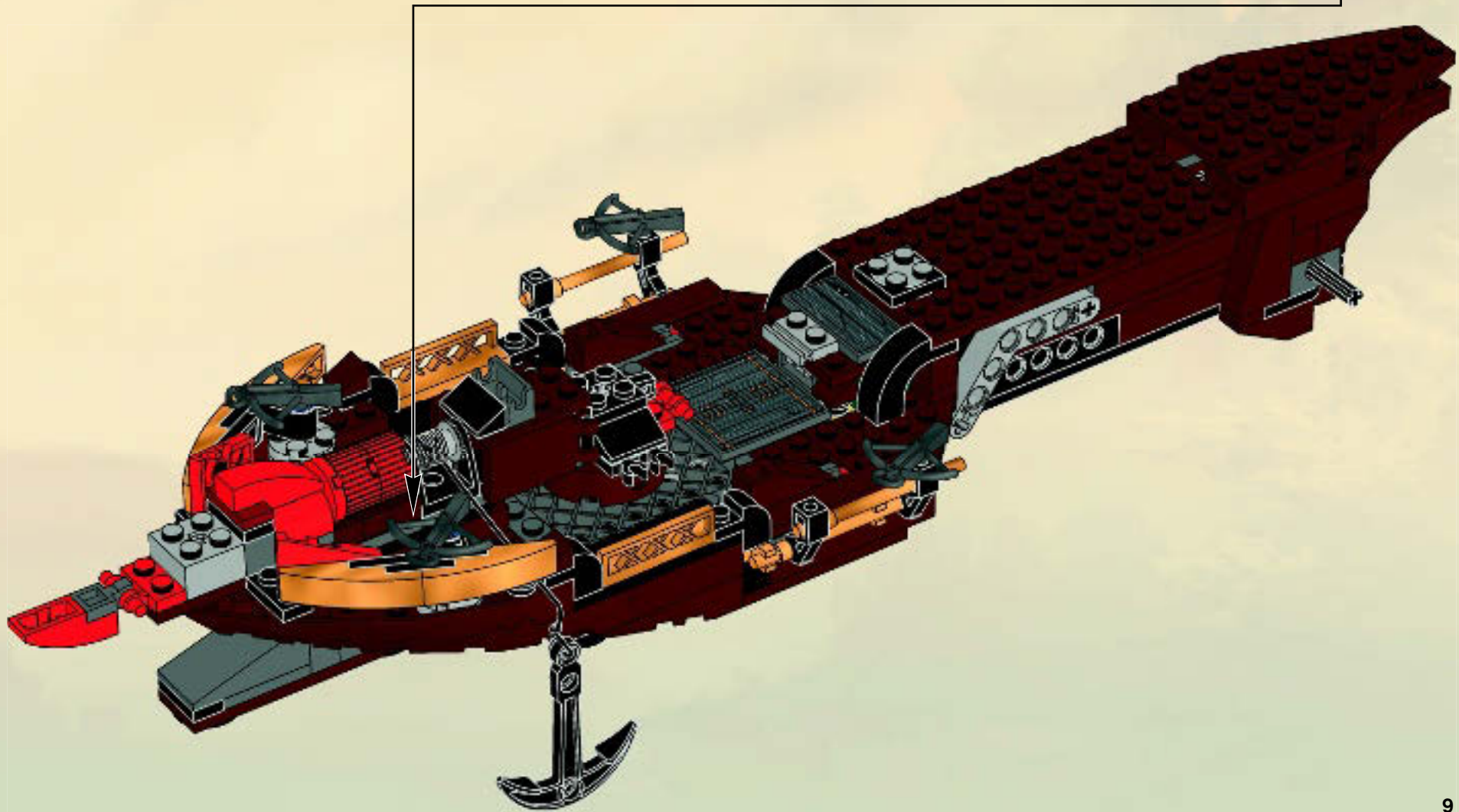
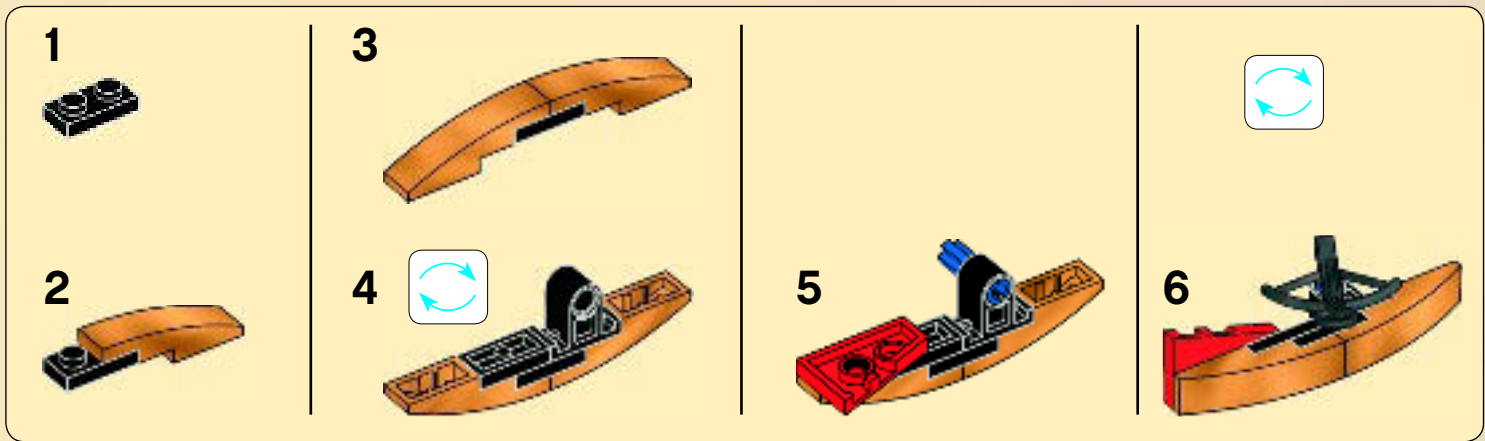

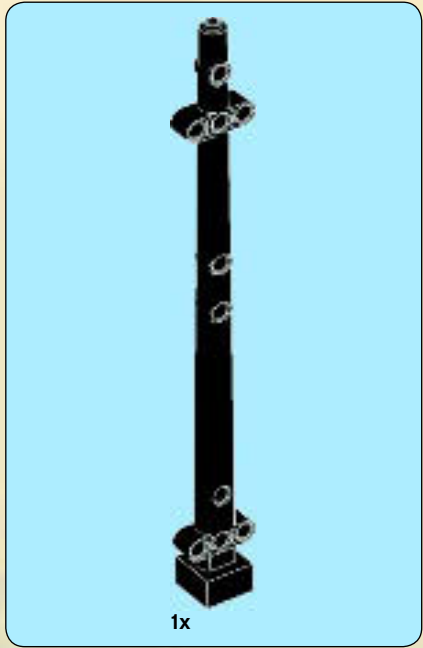
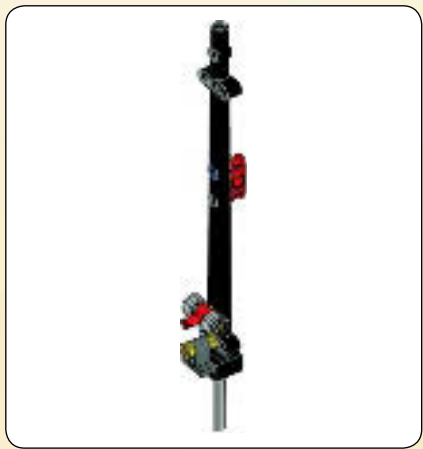

1

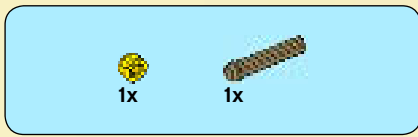

2





3



4

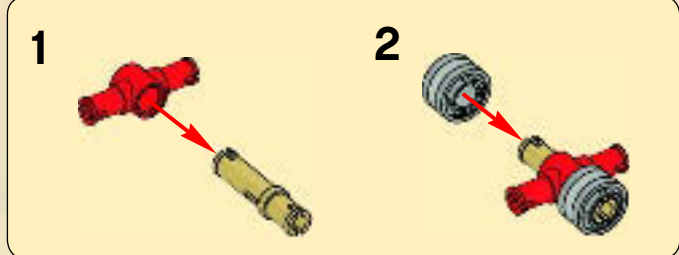

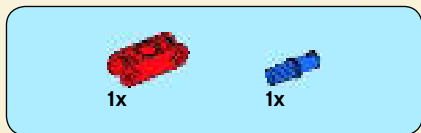

5

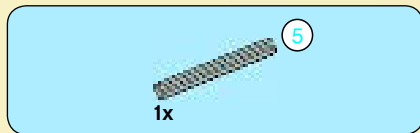
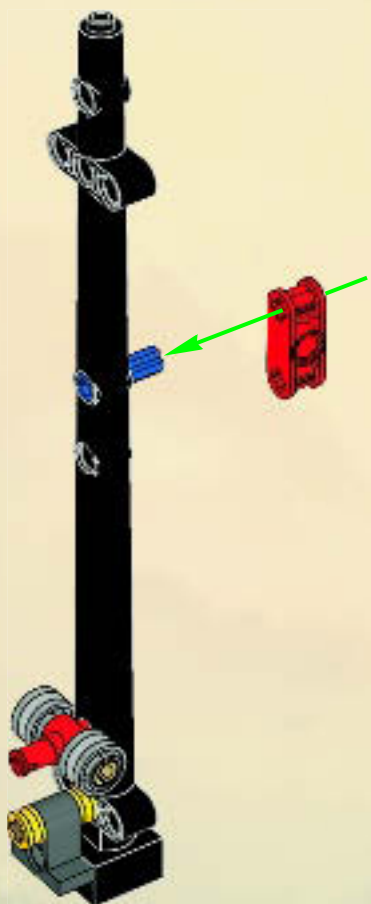

6



62

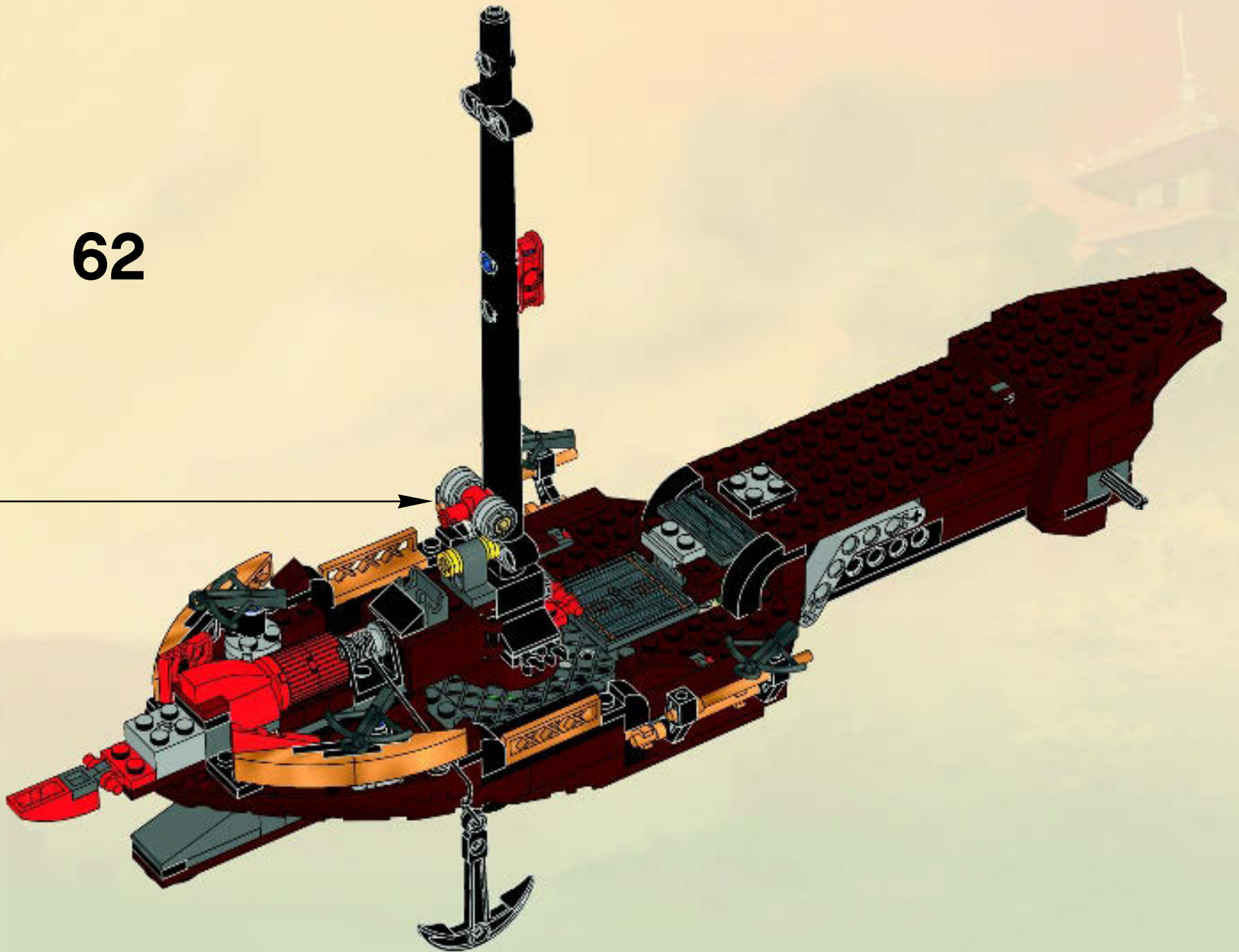

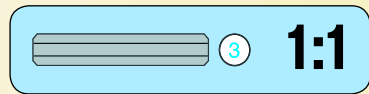
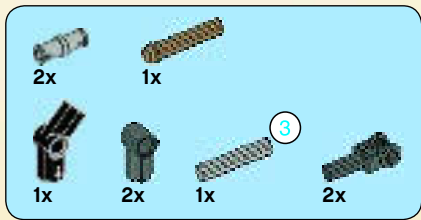

63

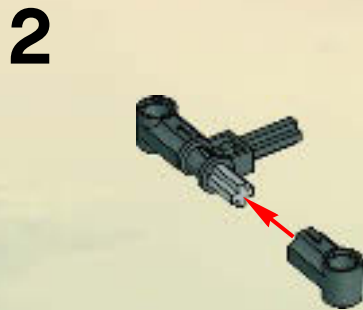
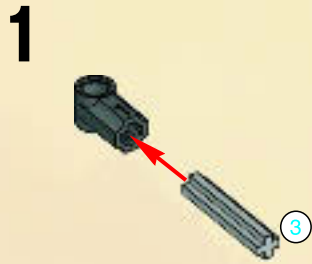

3



4

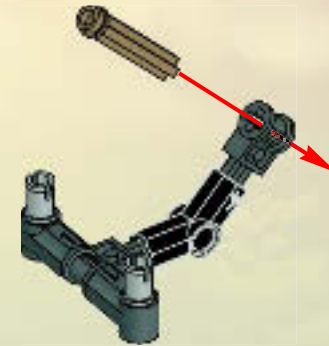

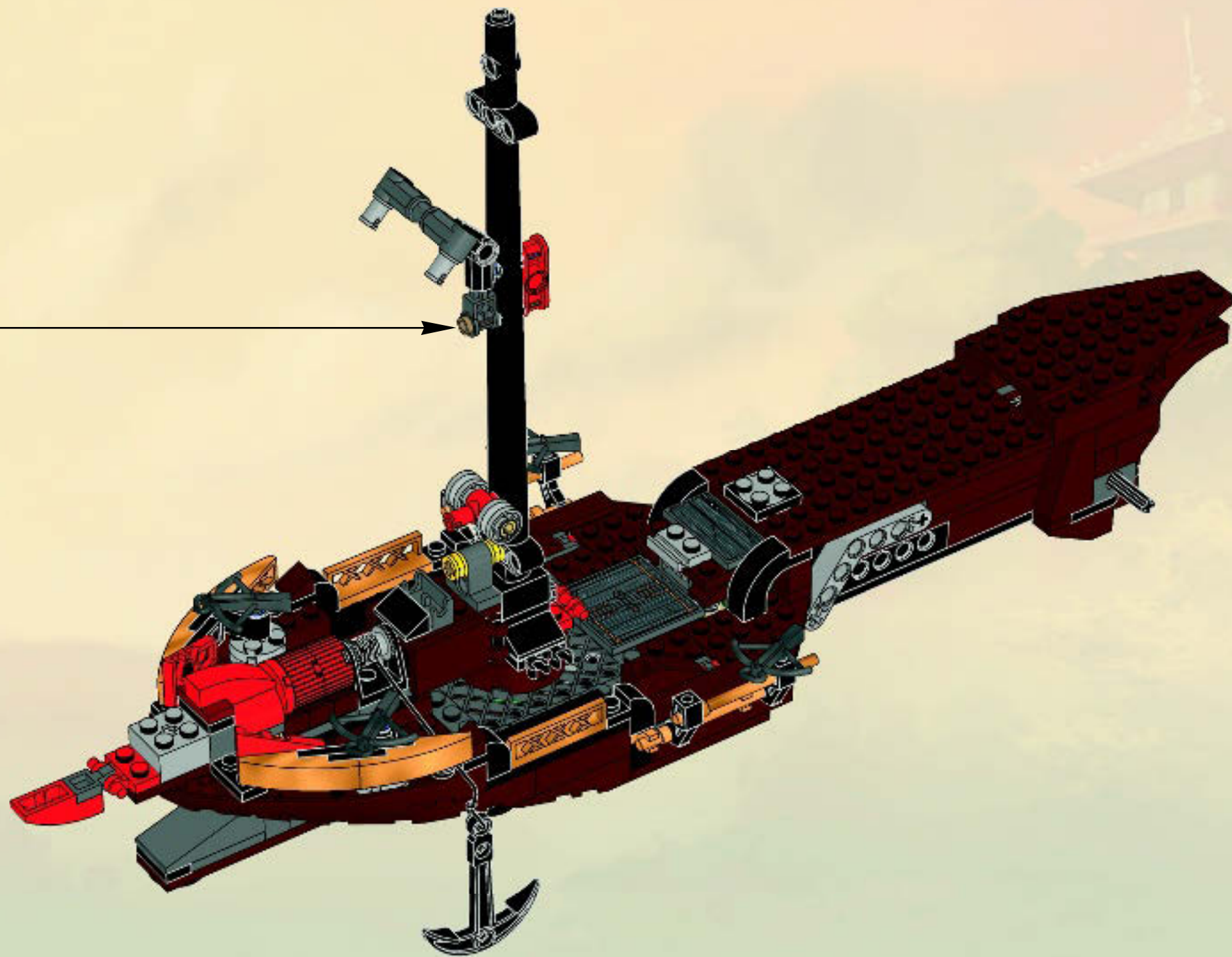

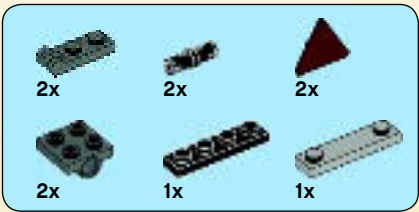

# 64

1

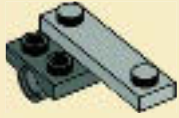

2



3



4

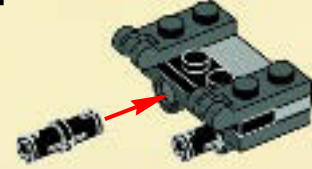

5



6

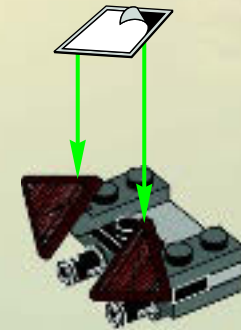



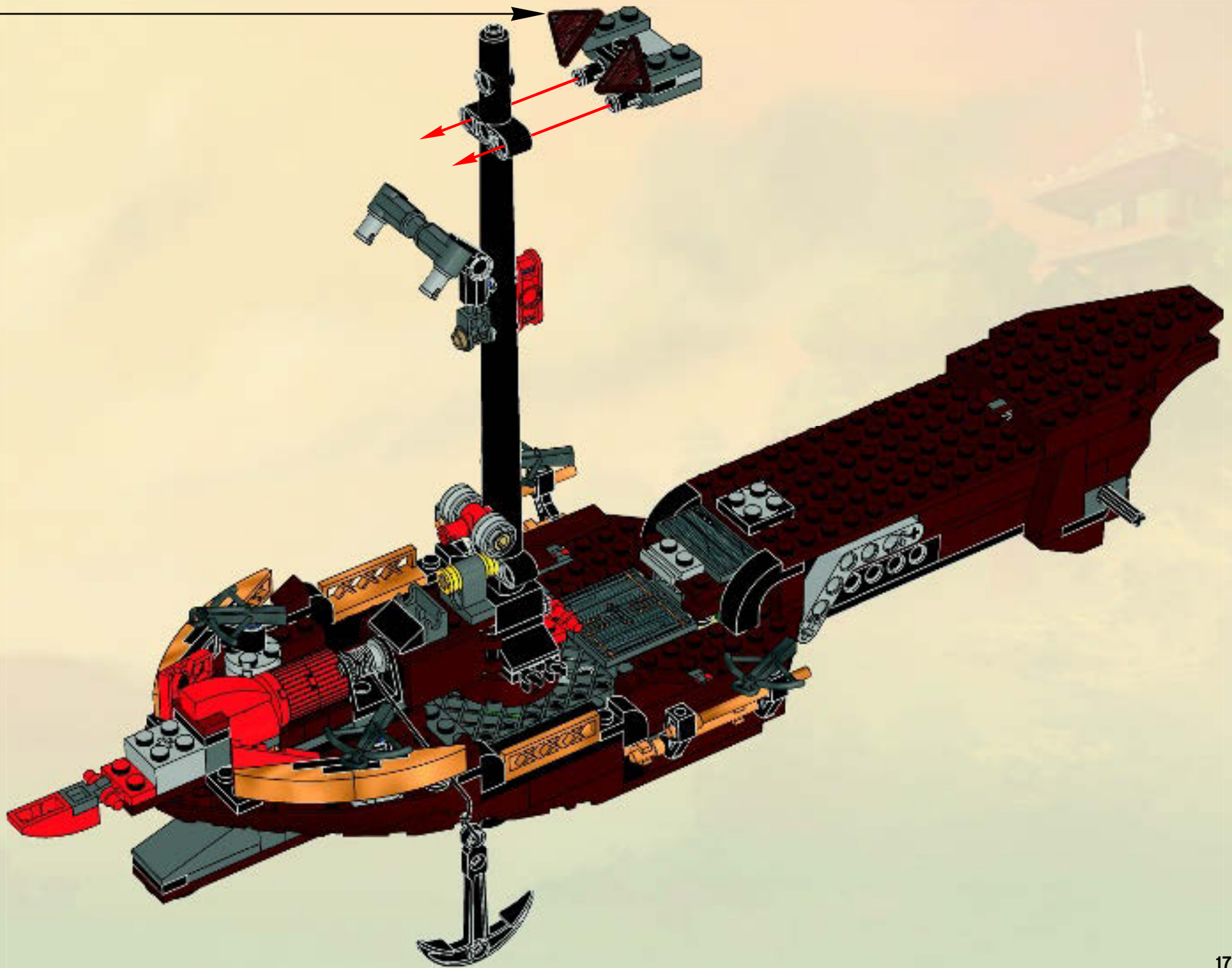

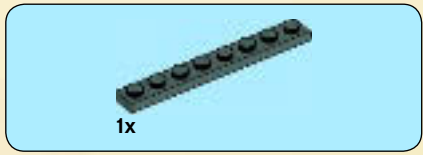

1

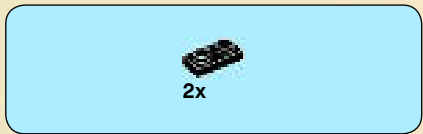

2

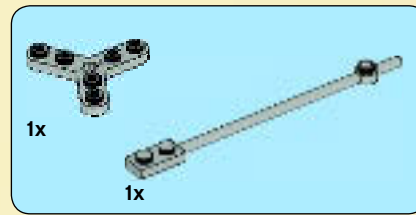

3

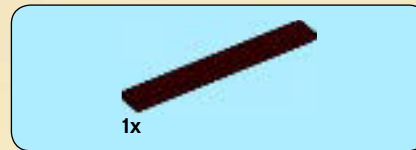
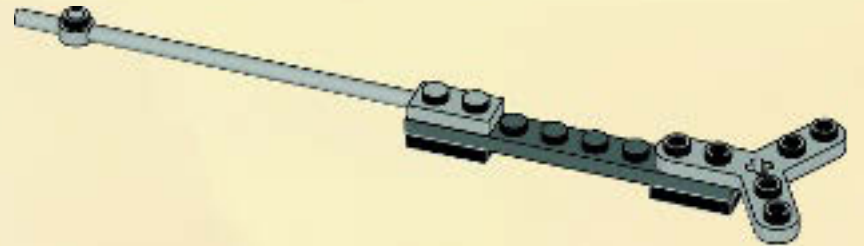

4



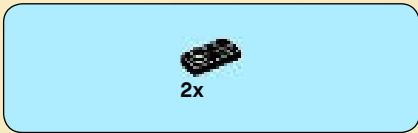

5

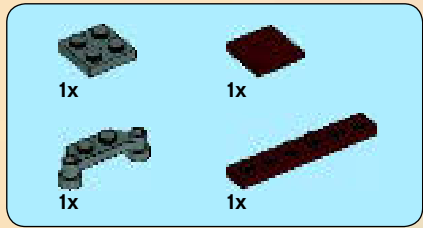
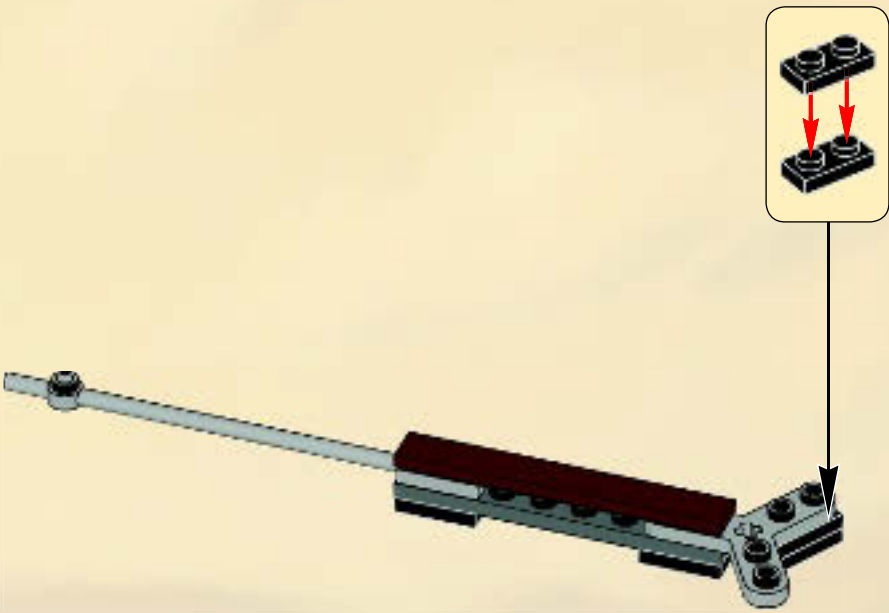

6





7

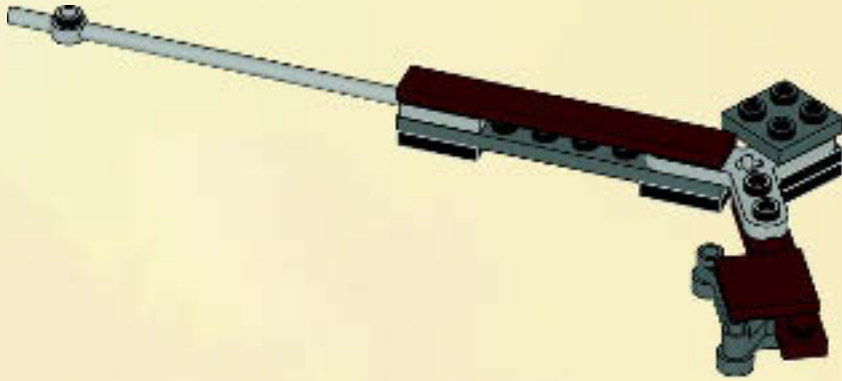

8

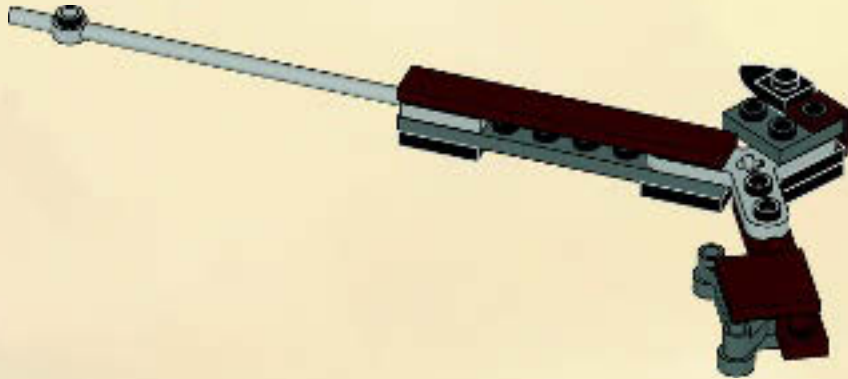

9

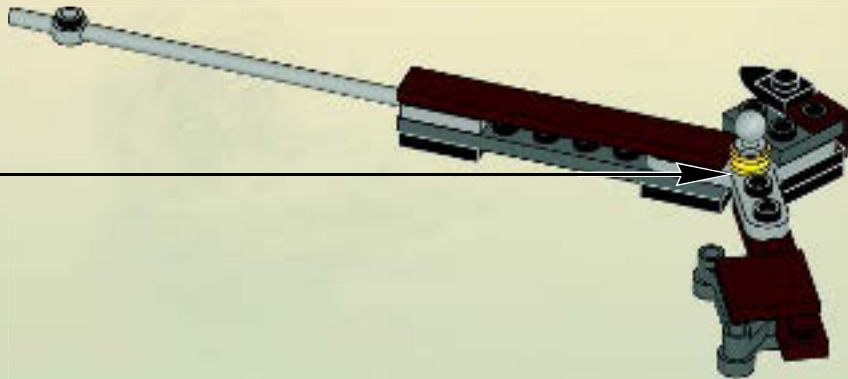
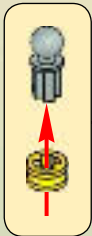

65

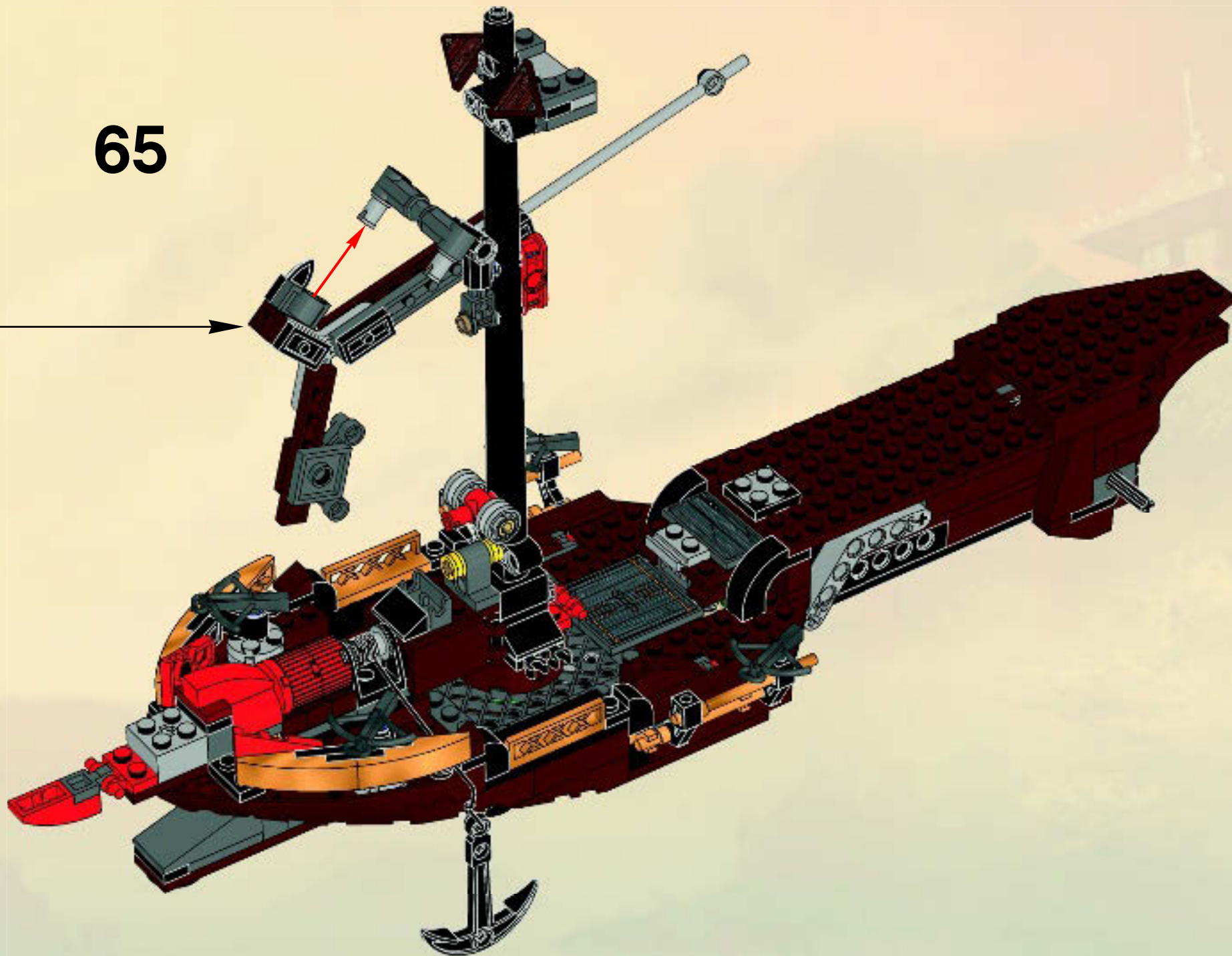

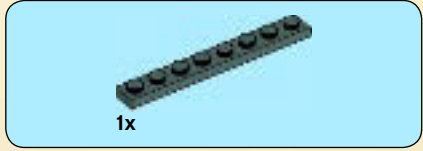

1

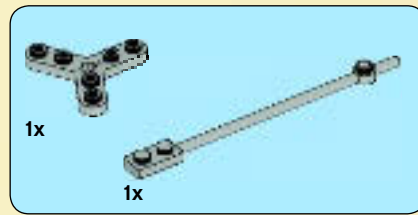
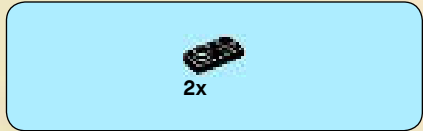

3

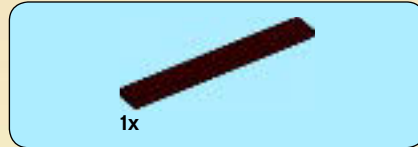
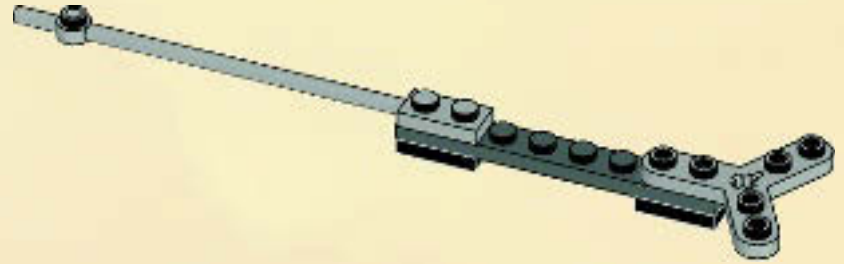

4

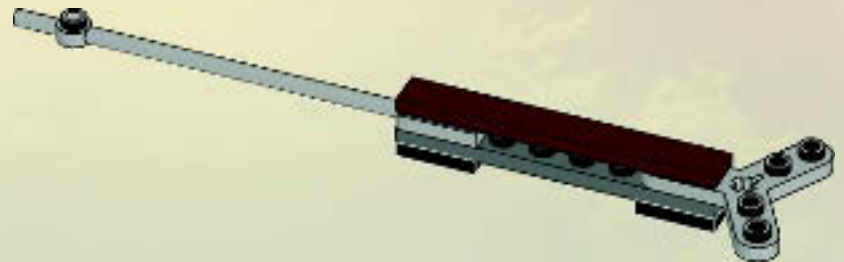



5

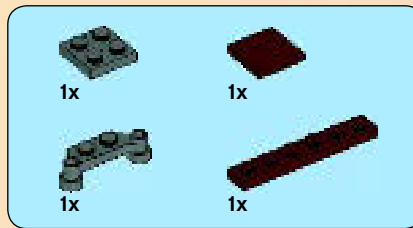
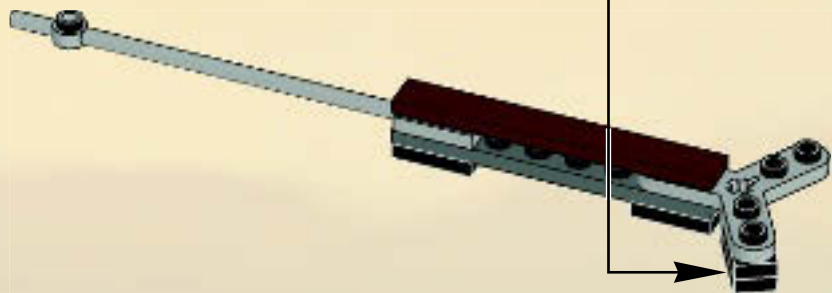
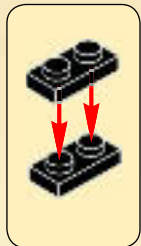

6

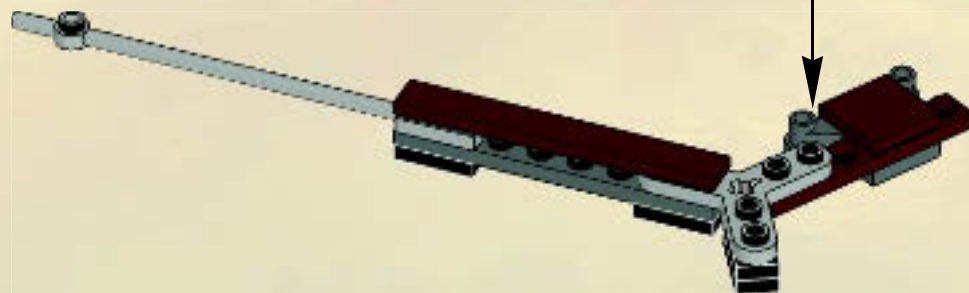
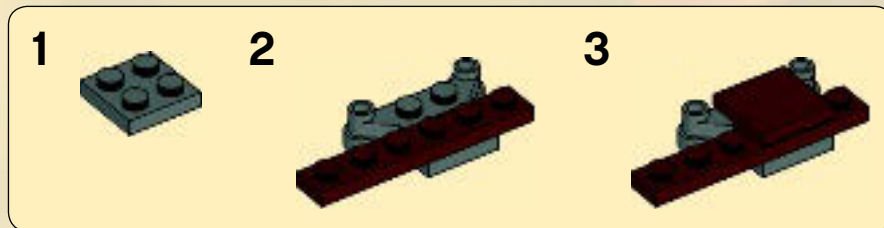



7

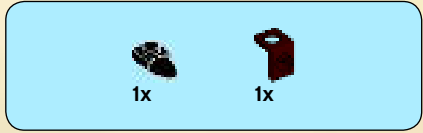
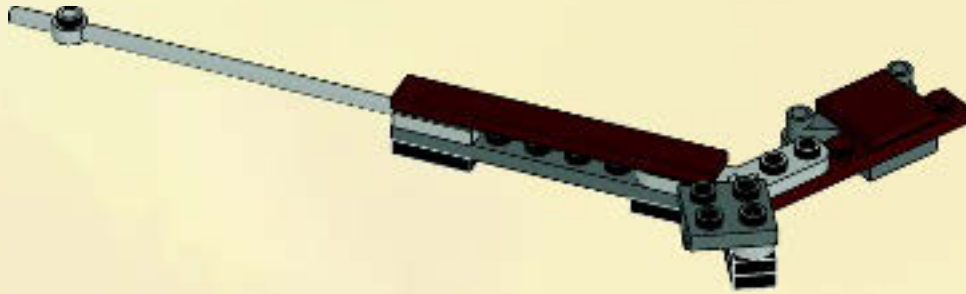

8

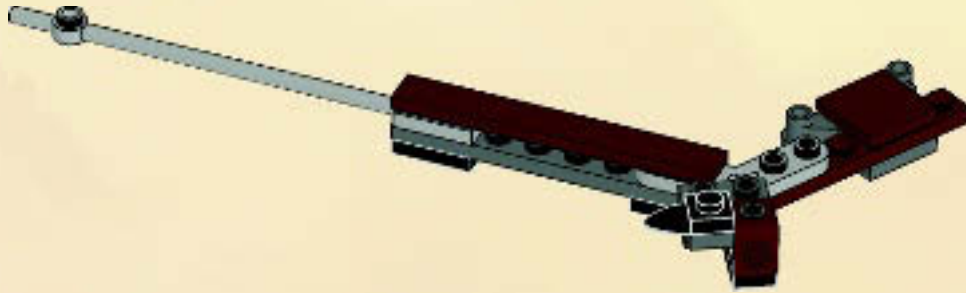

9

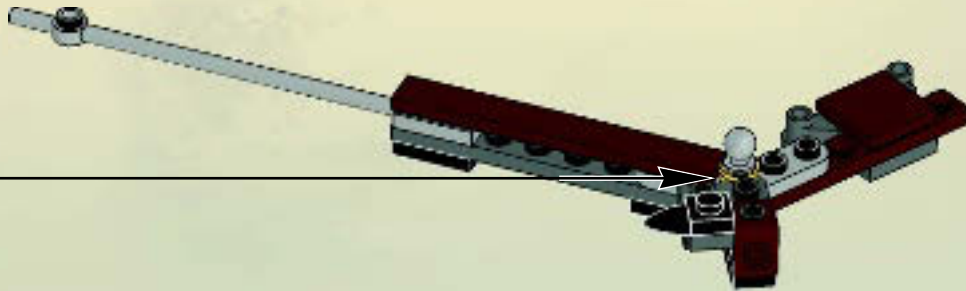



66

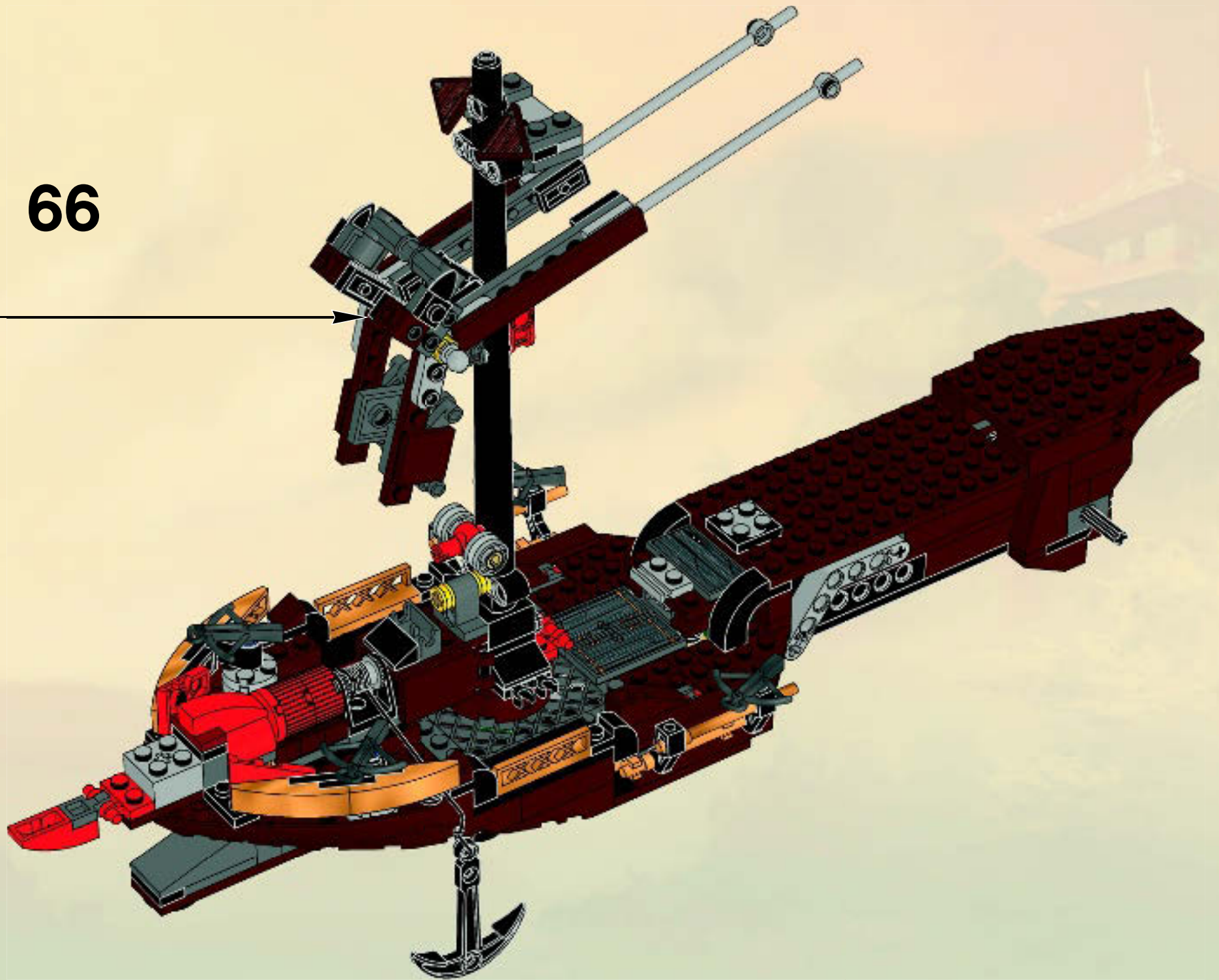

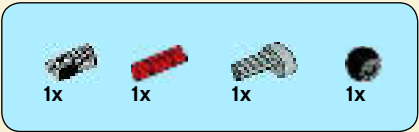

67

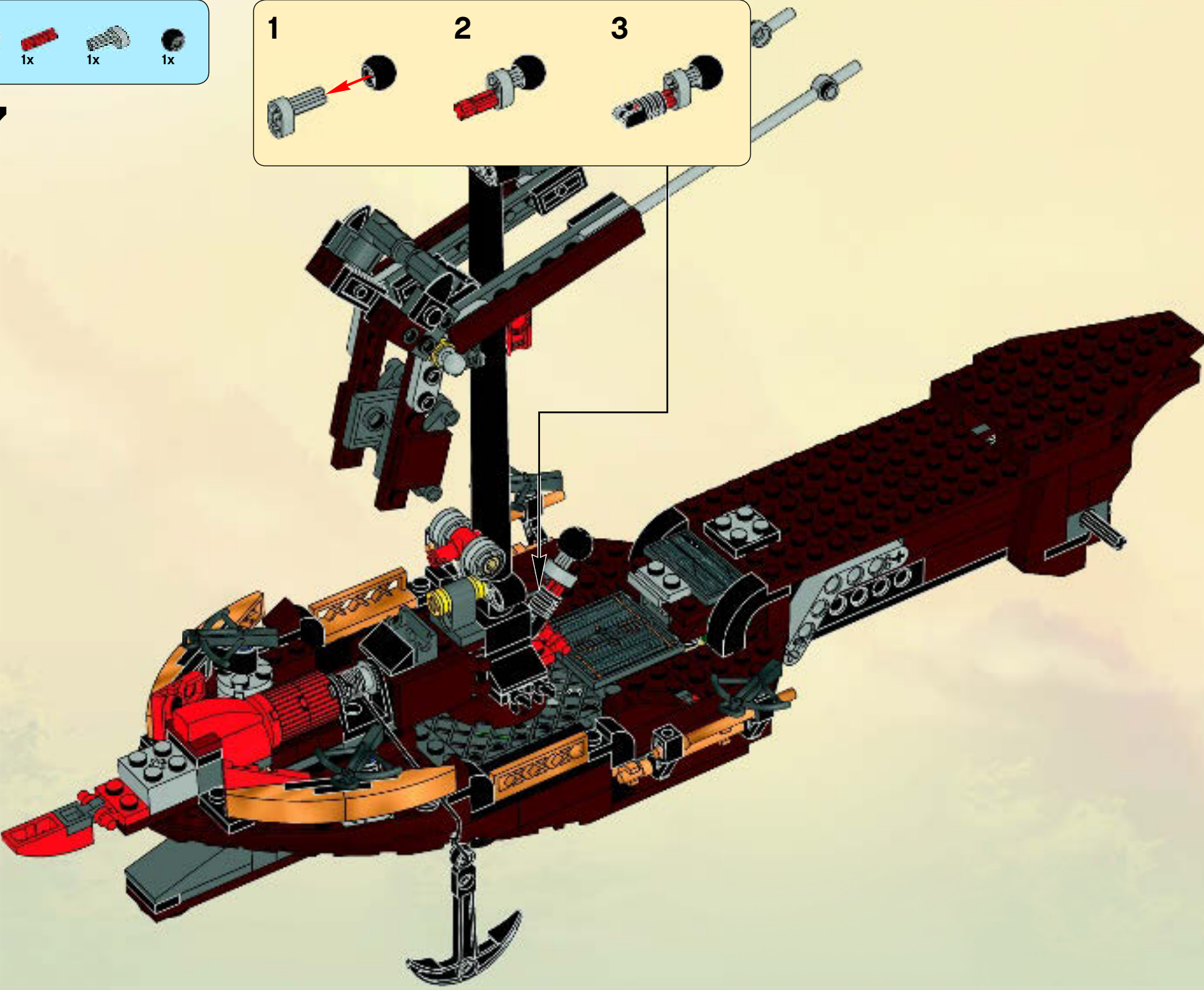
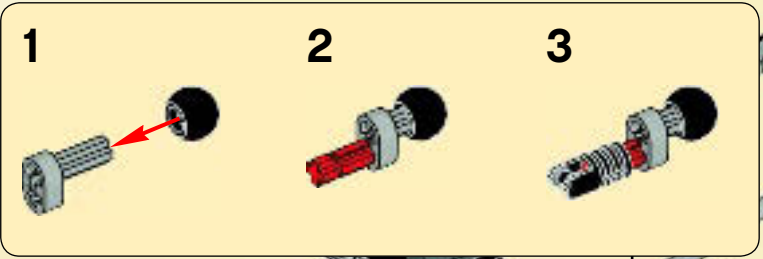

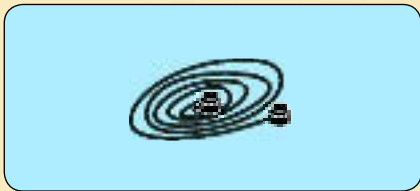

68

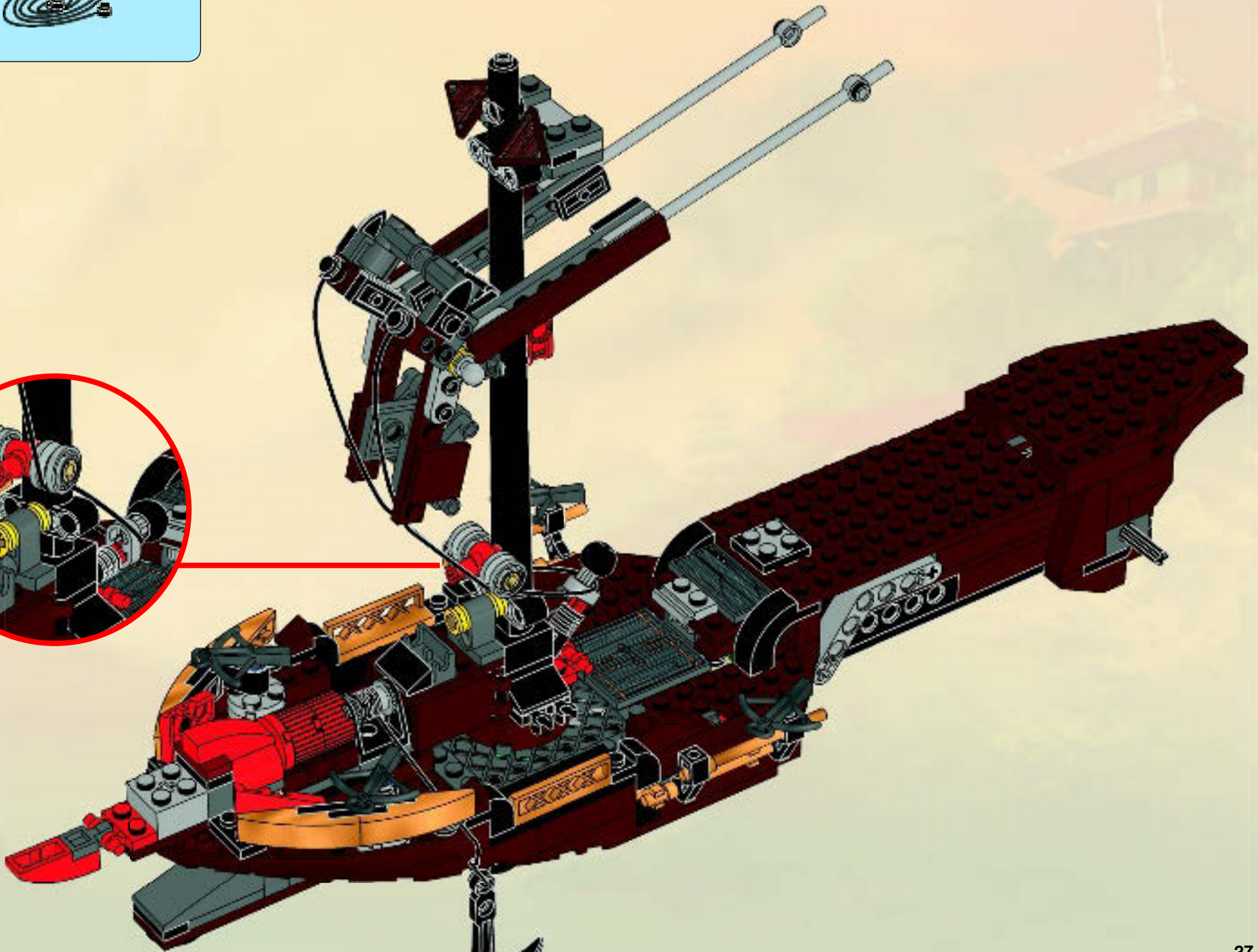
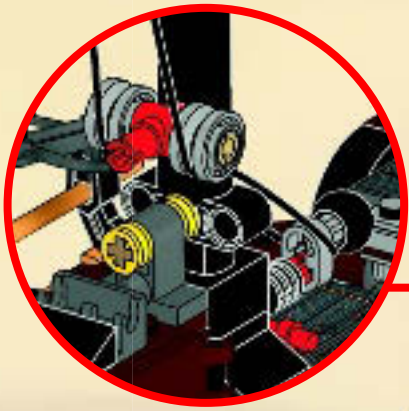

69

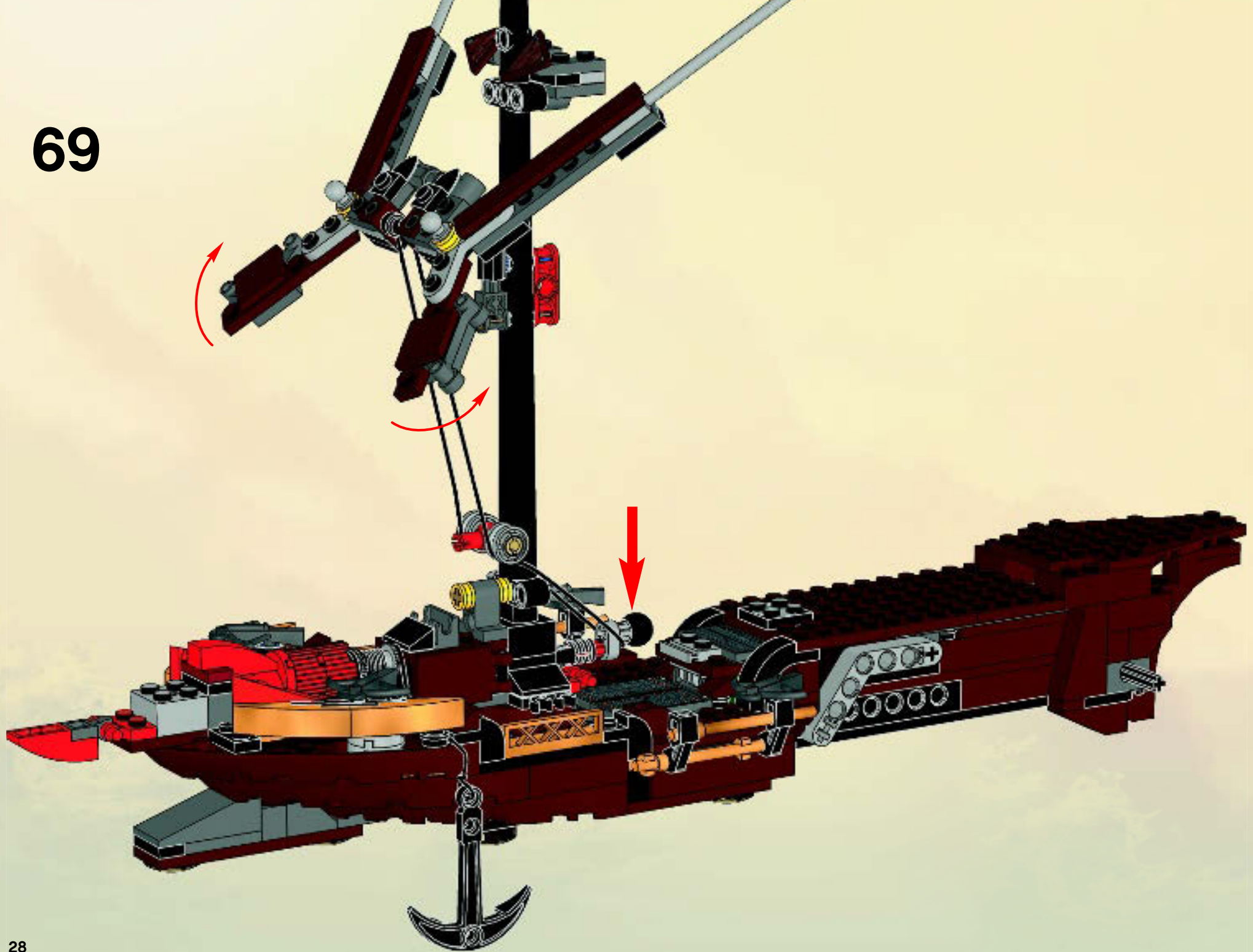

- 1x
- 2x
- 1x

# 70

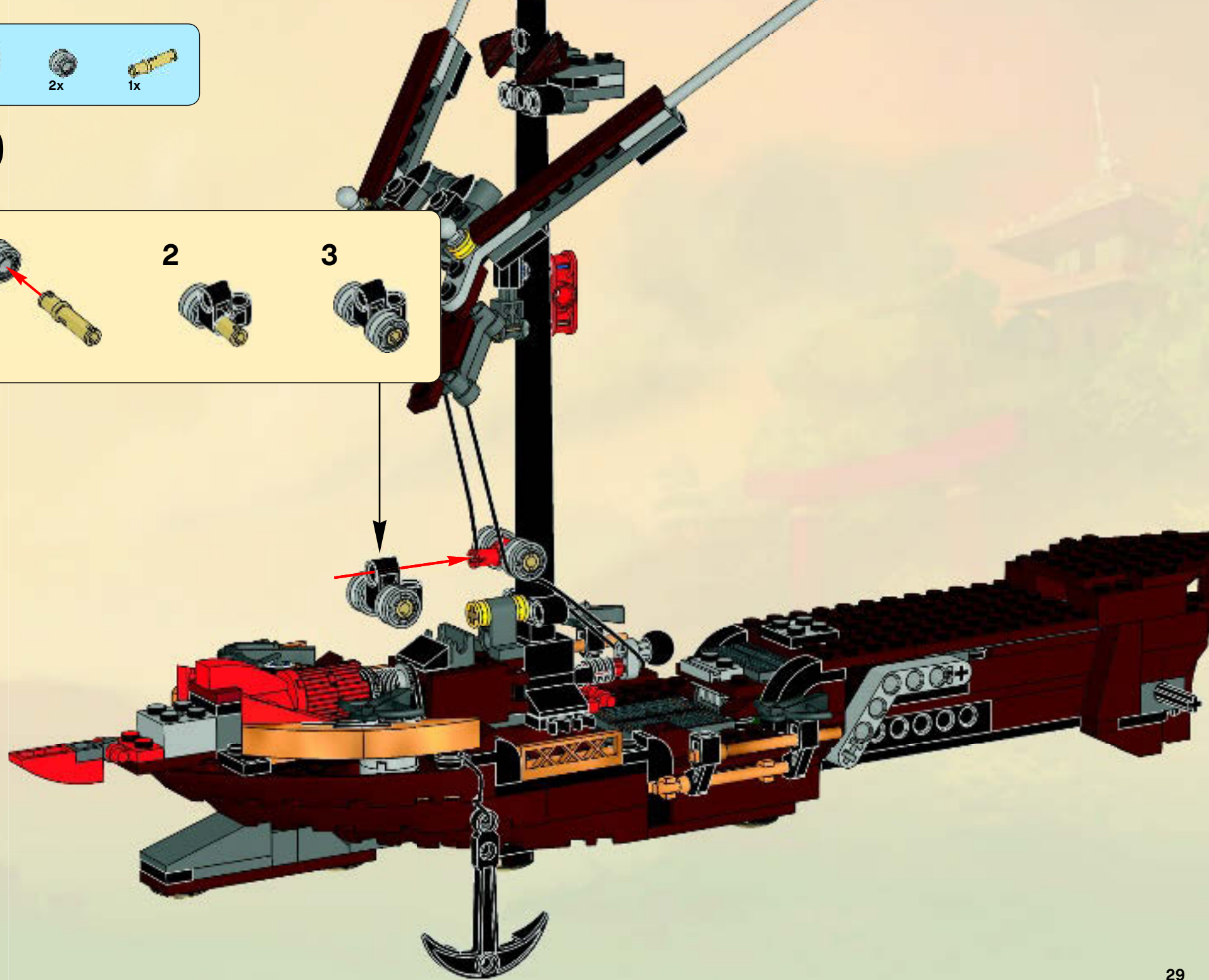
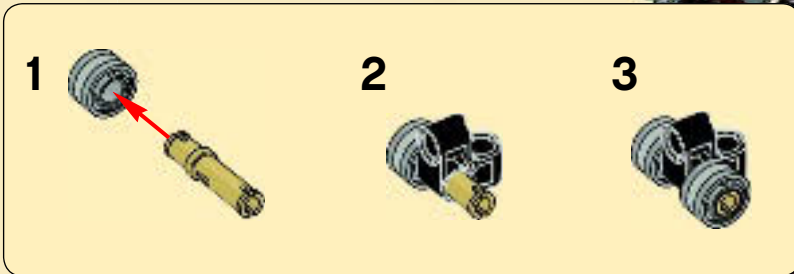

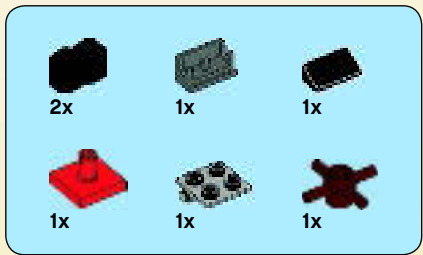

# 71

1

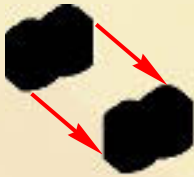

2

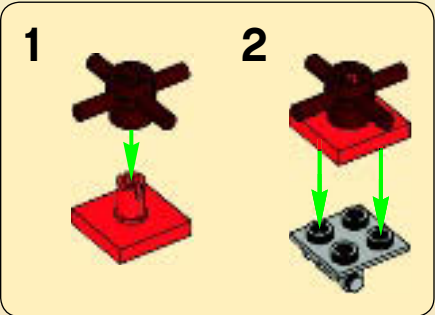

3



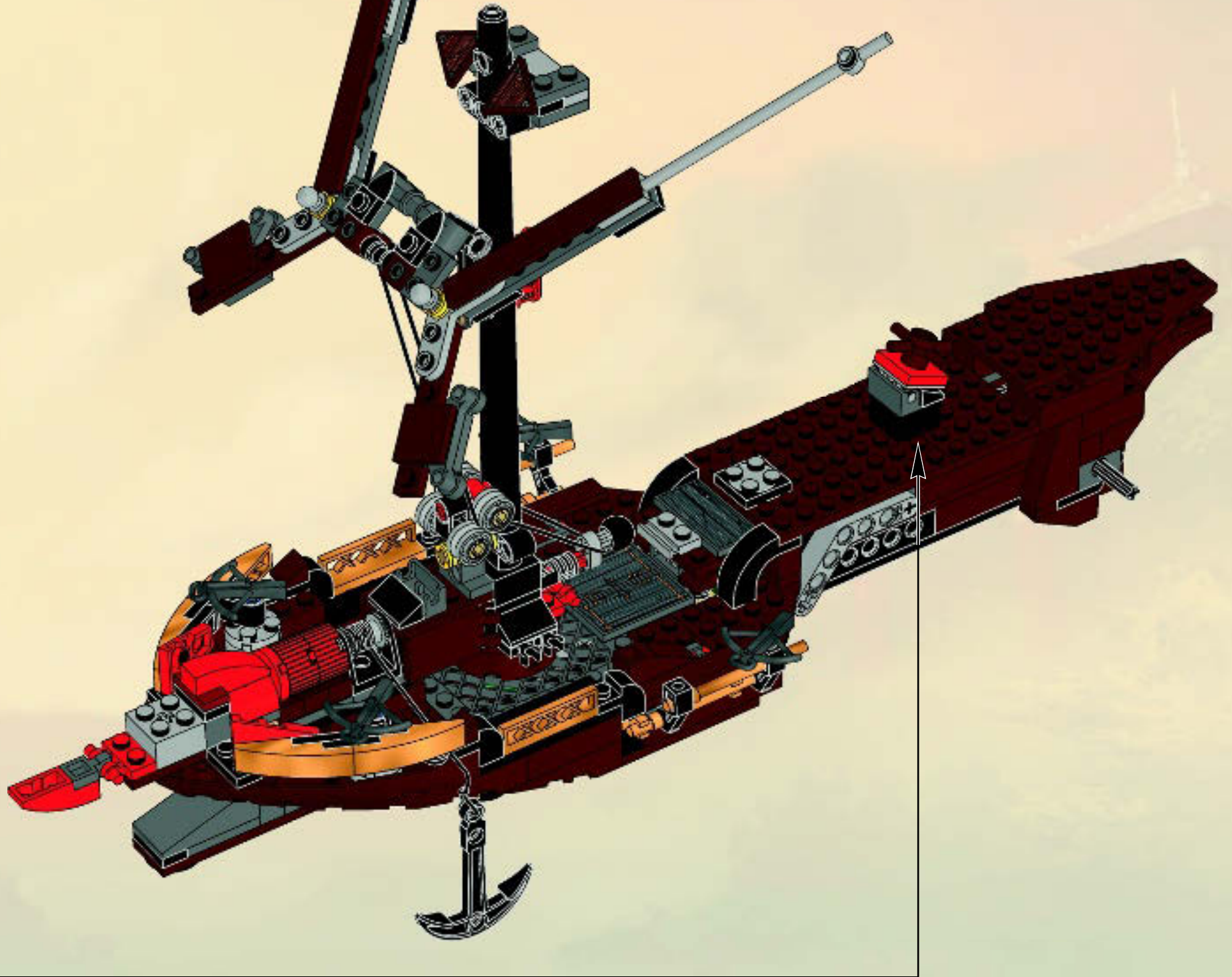

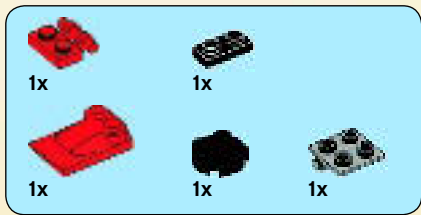

72

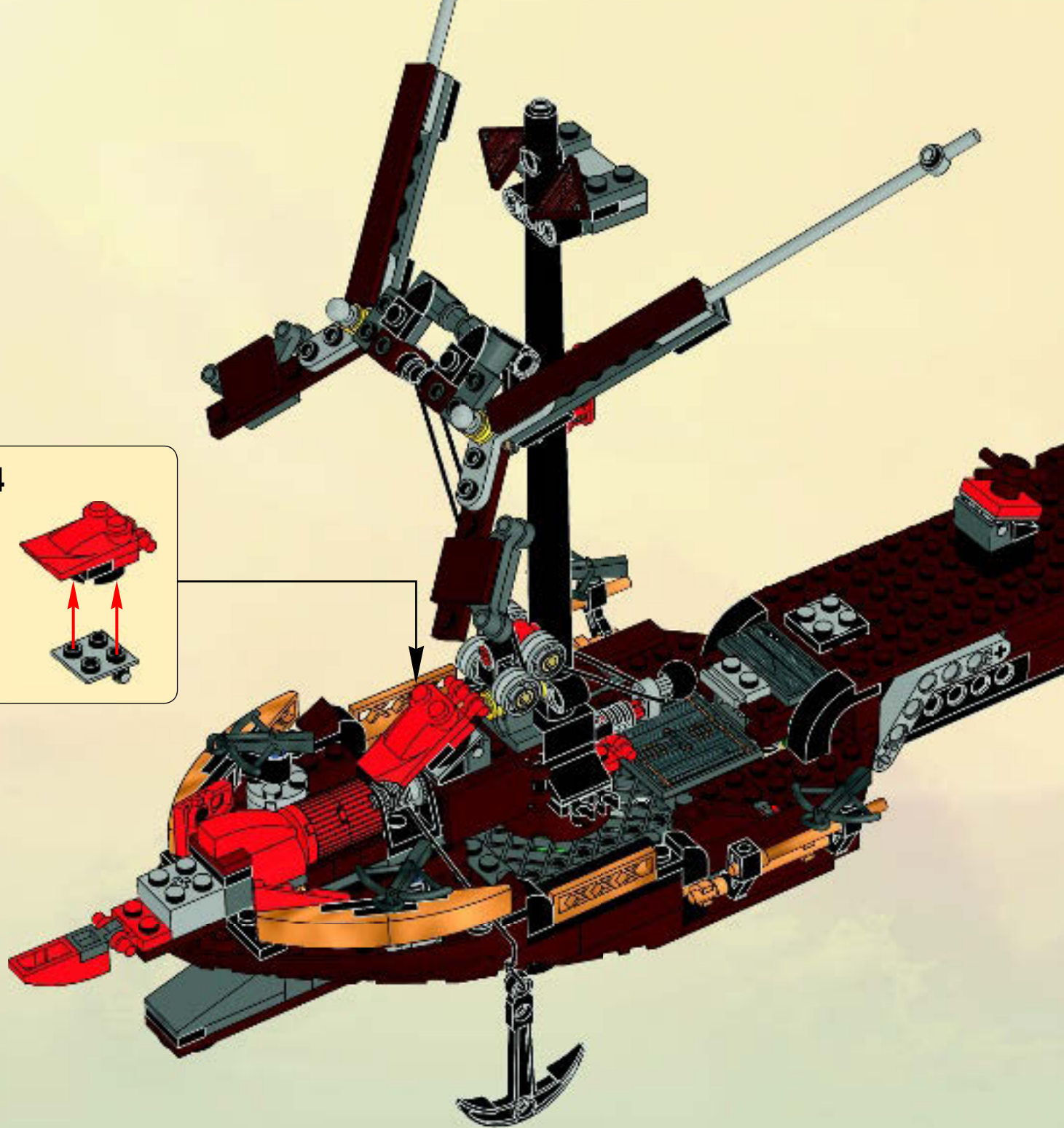
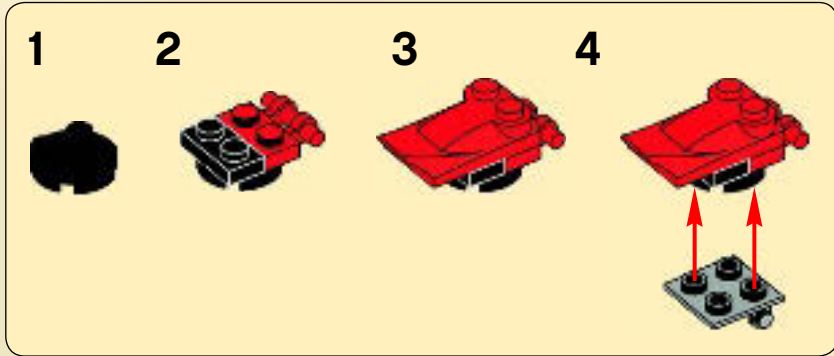



1x  1x 

73

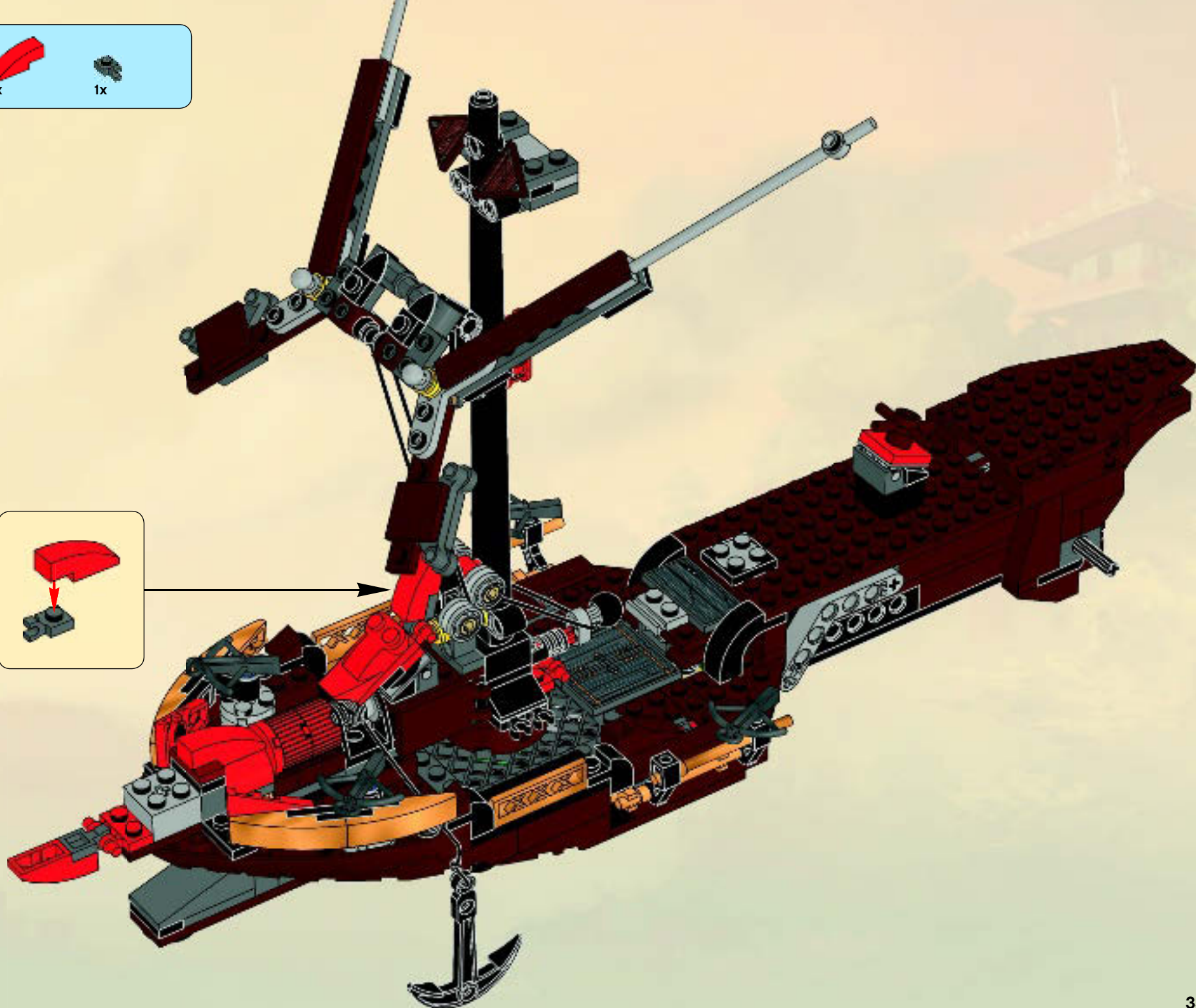
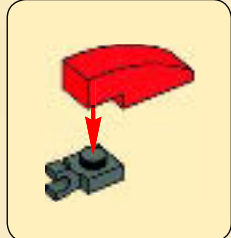

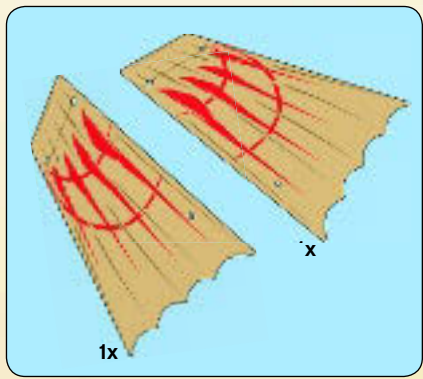

74

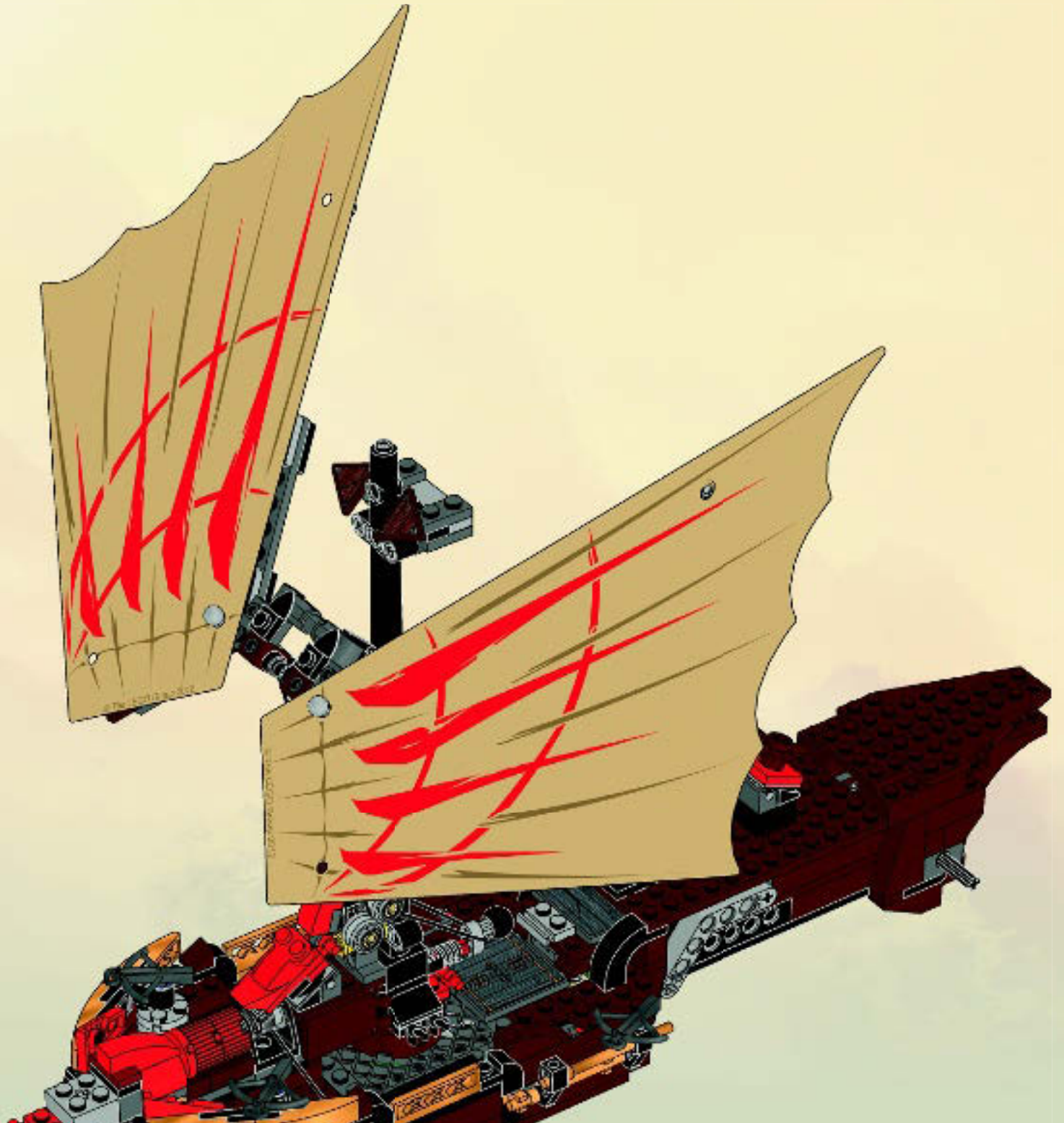



4x

75



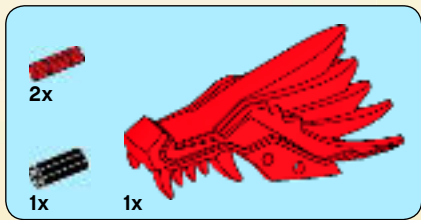

76

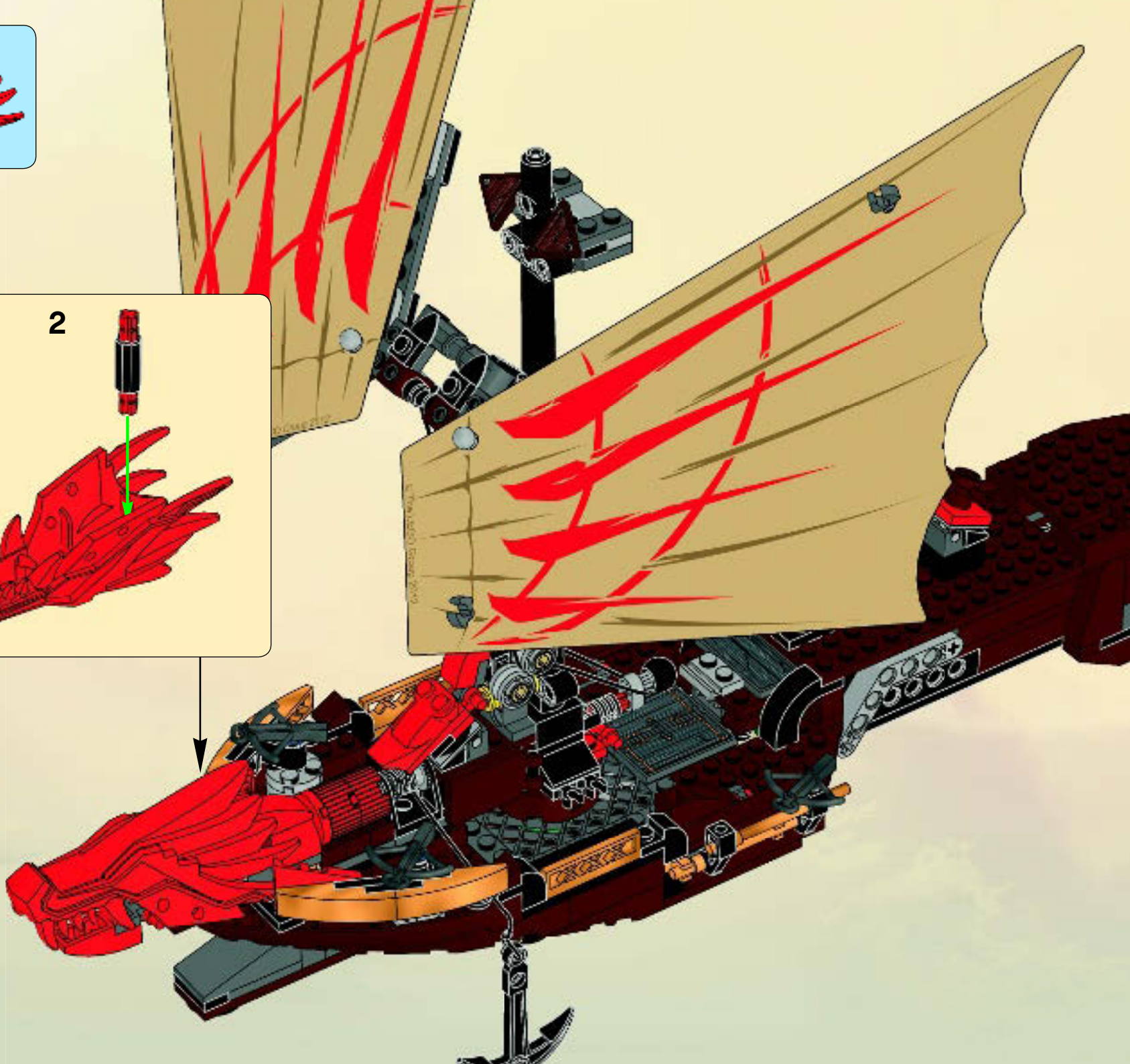
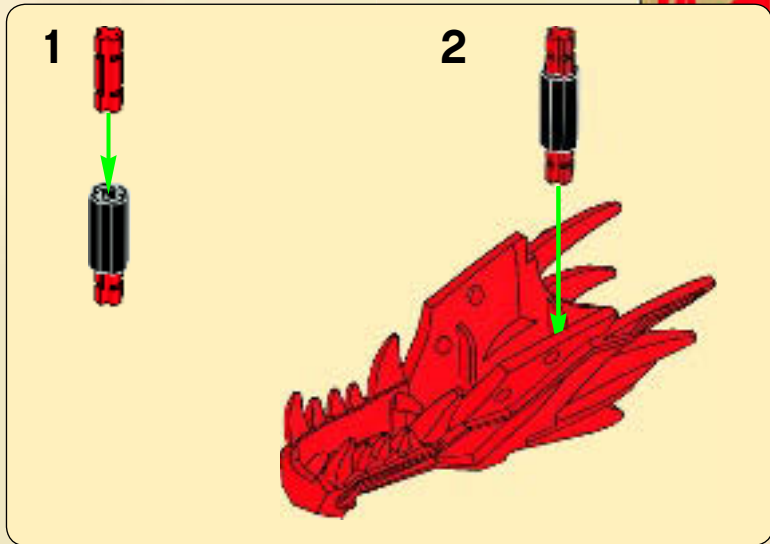

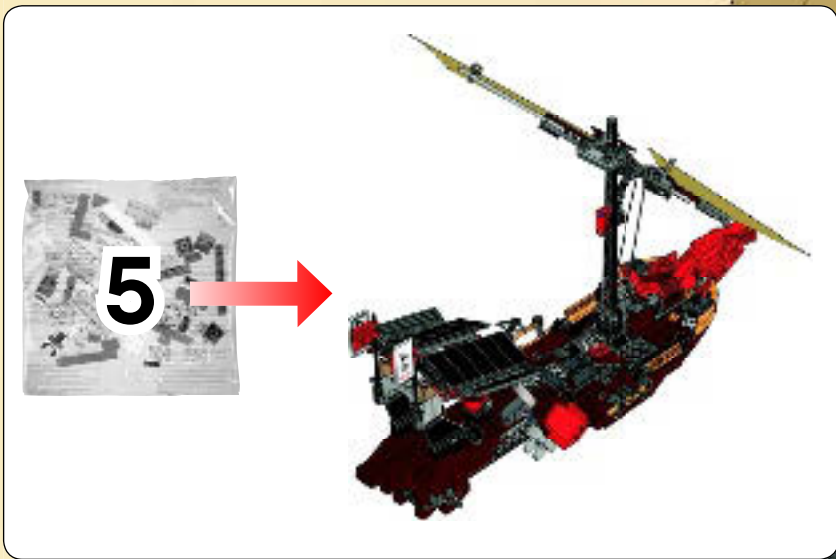

77

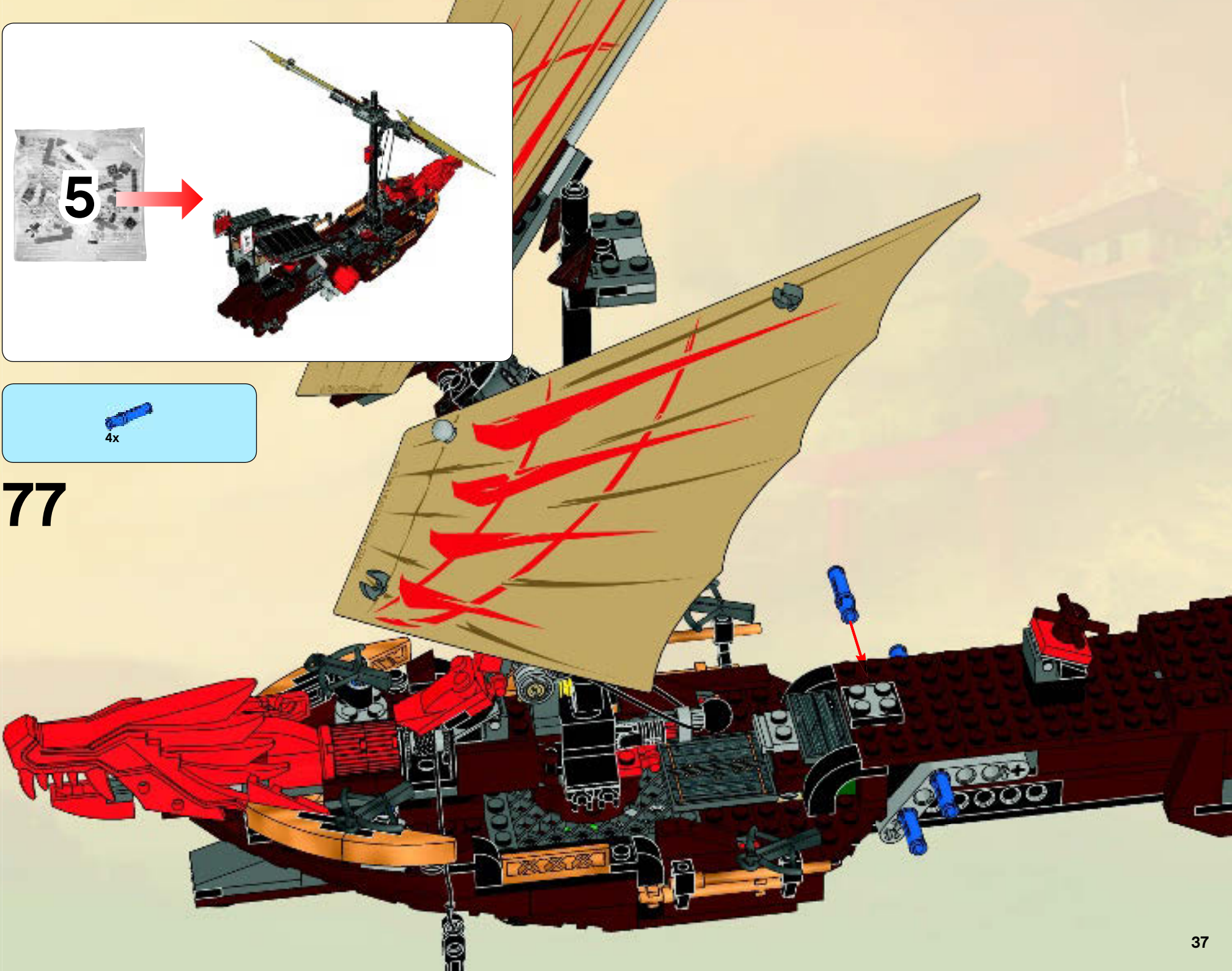

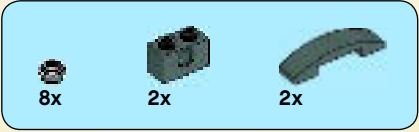

78

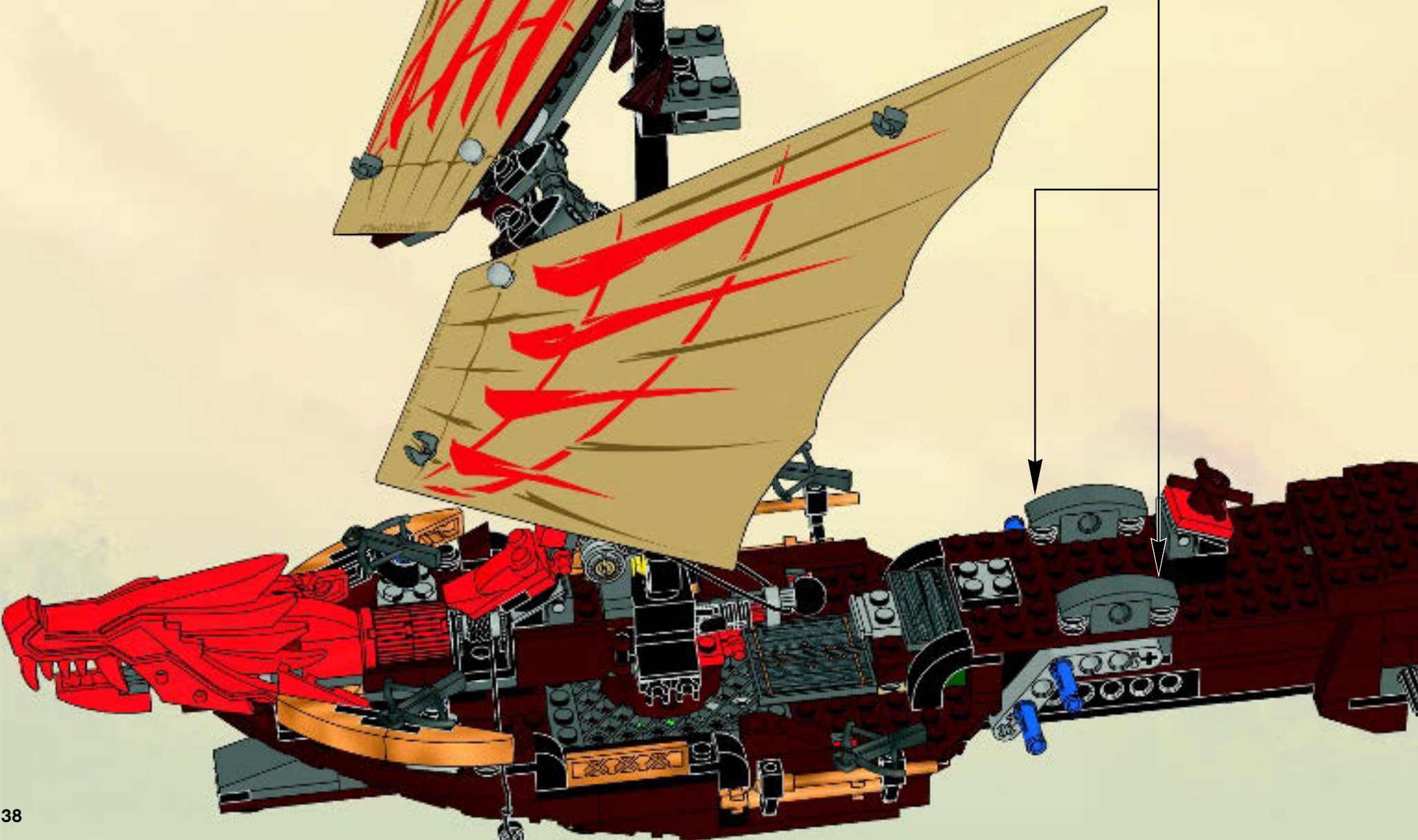





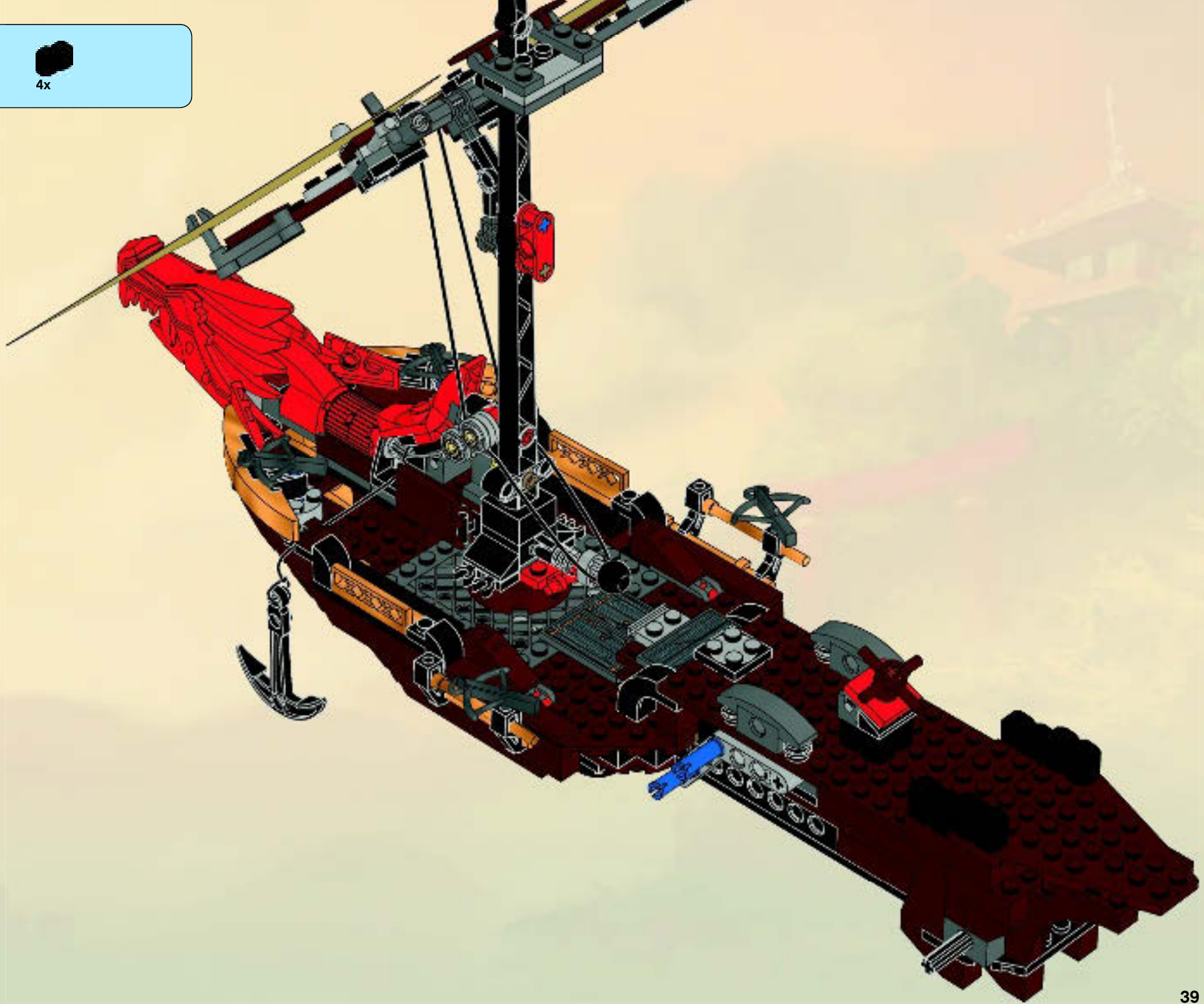

4x

79



4x  2x 

80

  2x

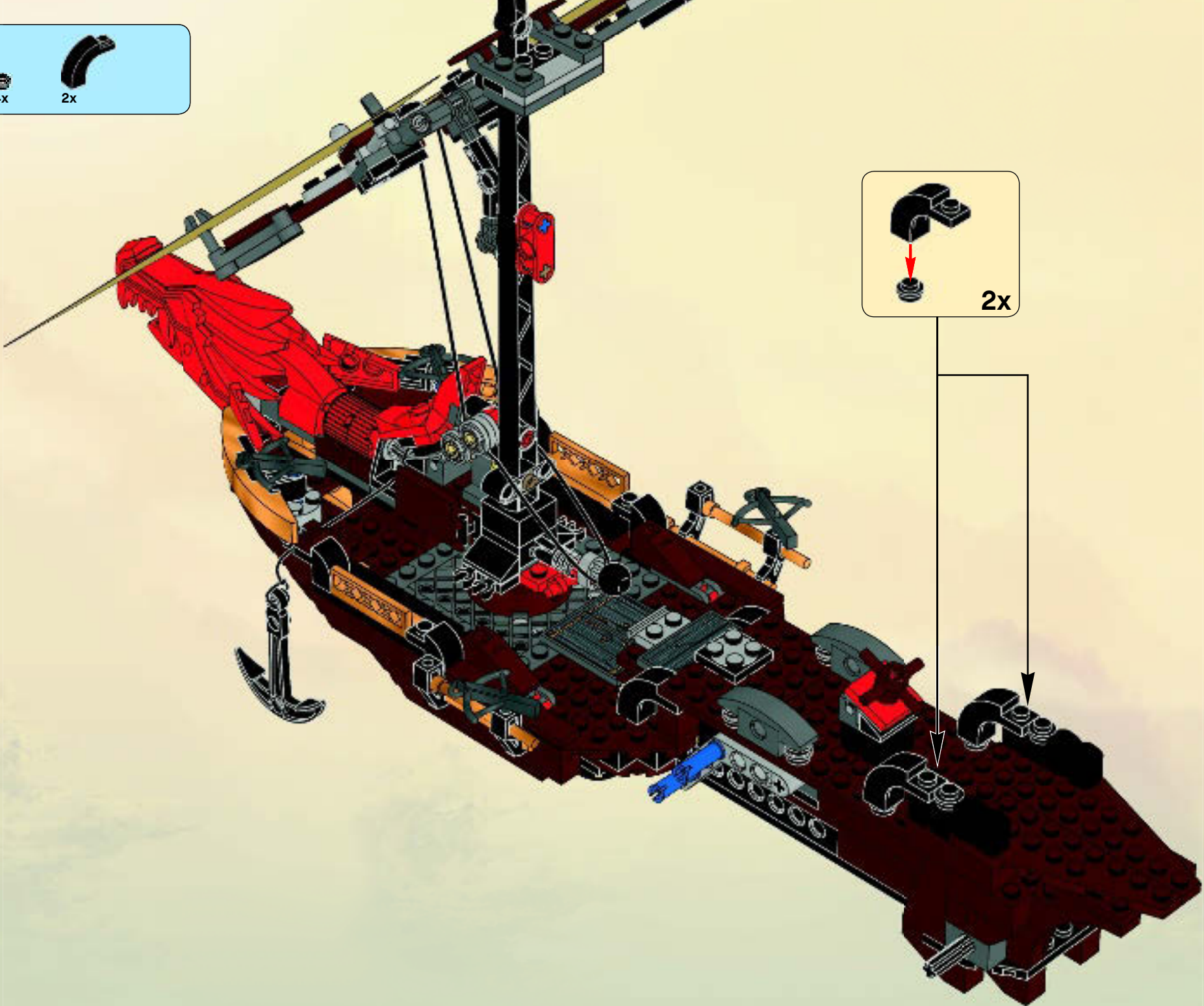





81

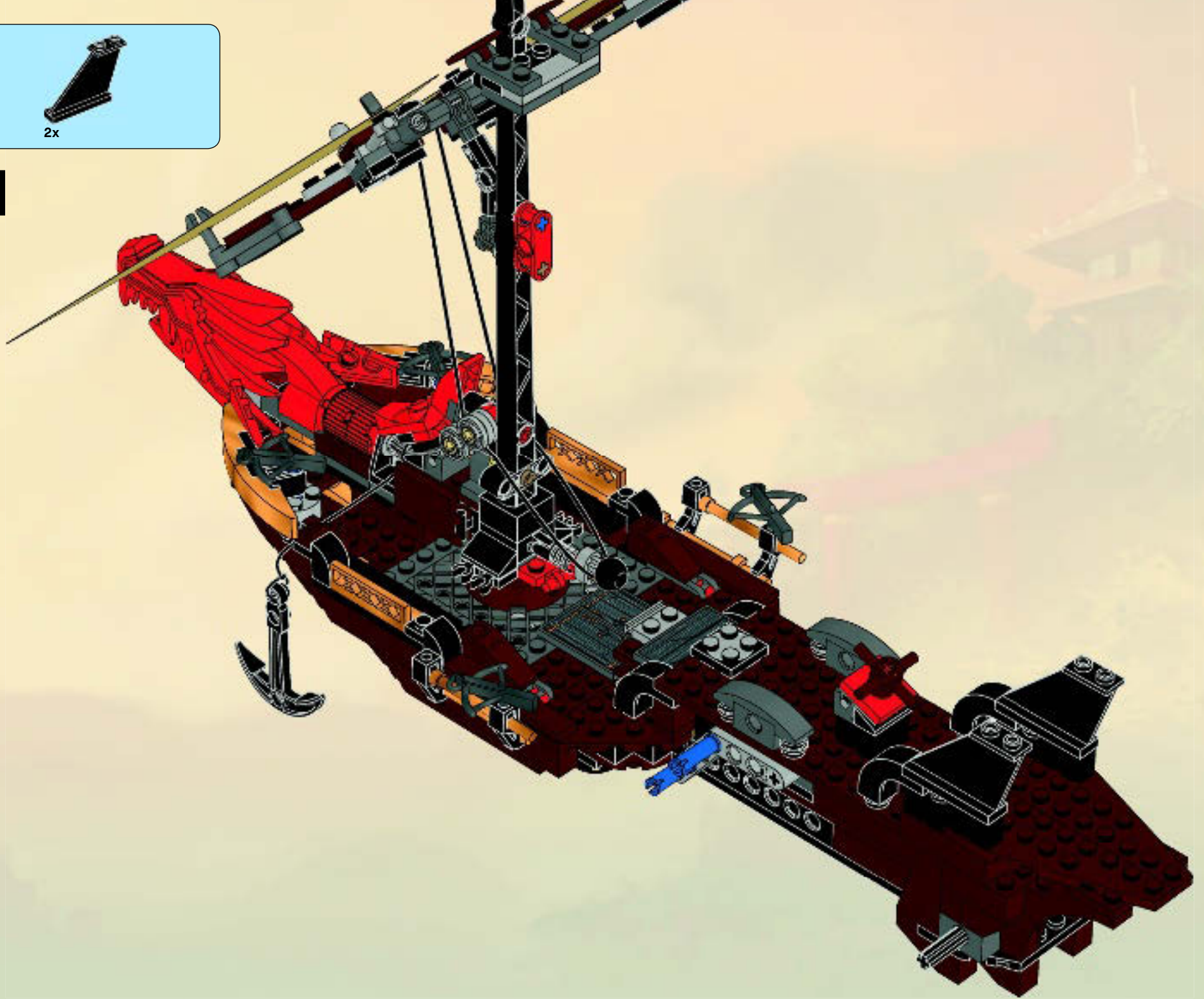

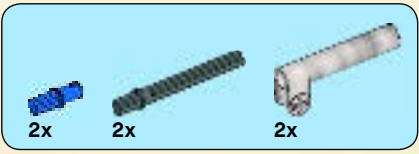

# 82

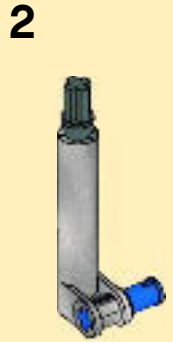
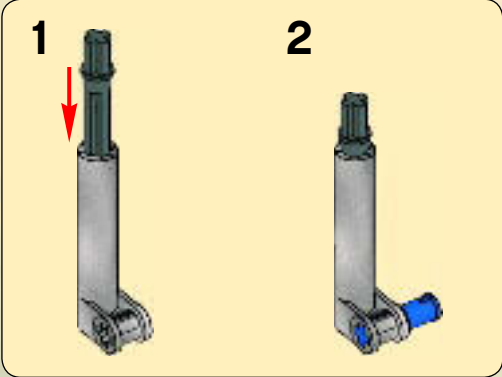
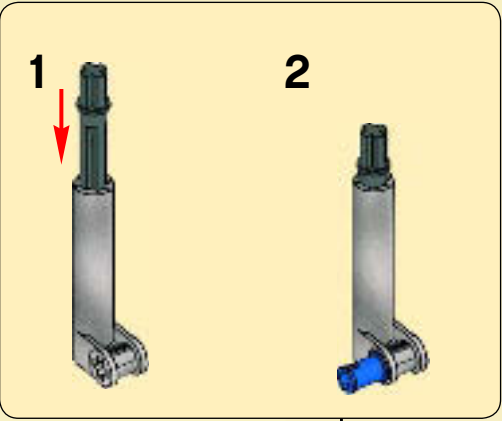



2x

83

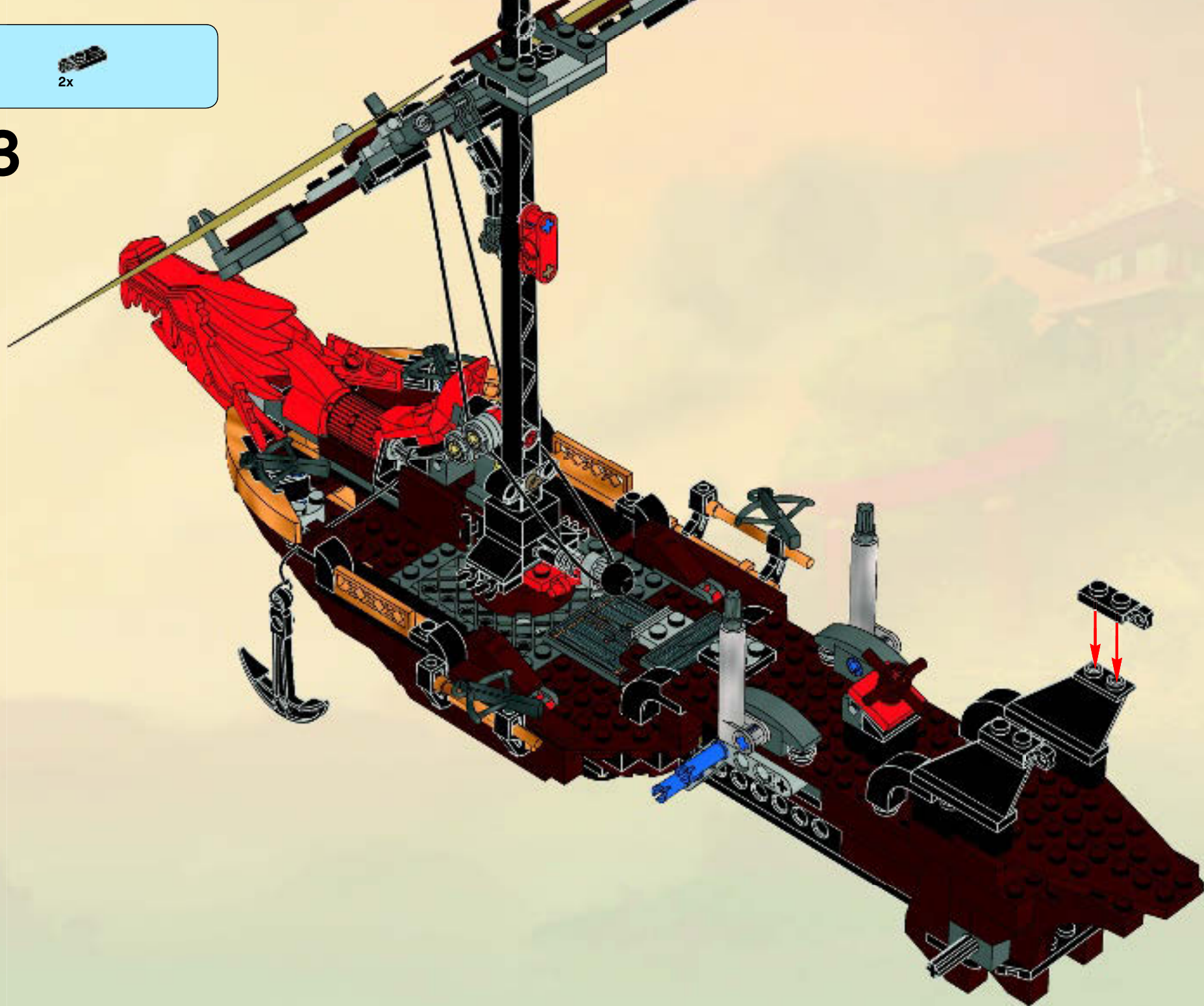

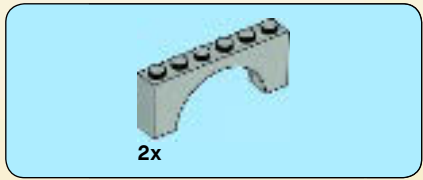

84

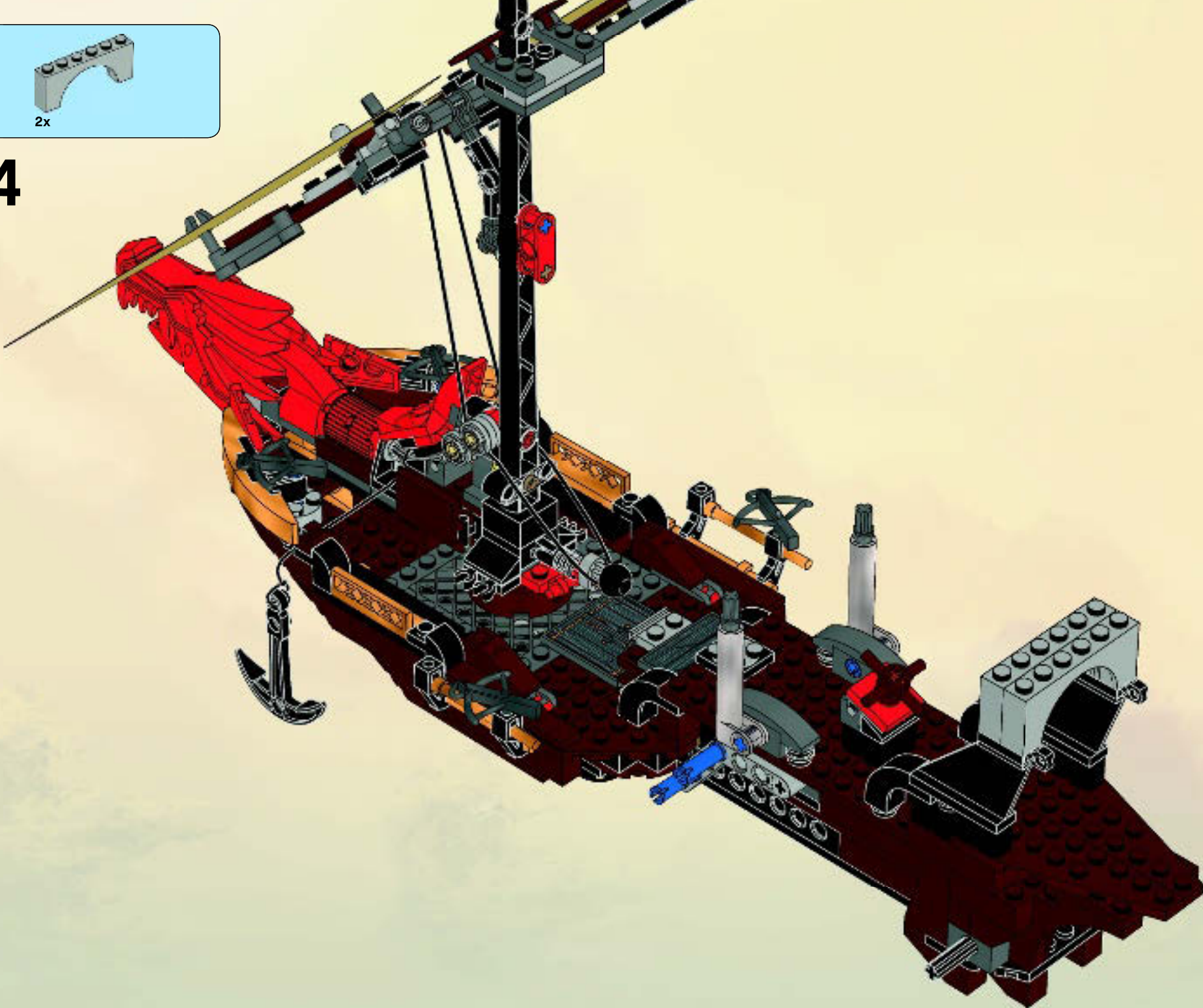

2x  2x 

85

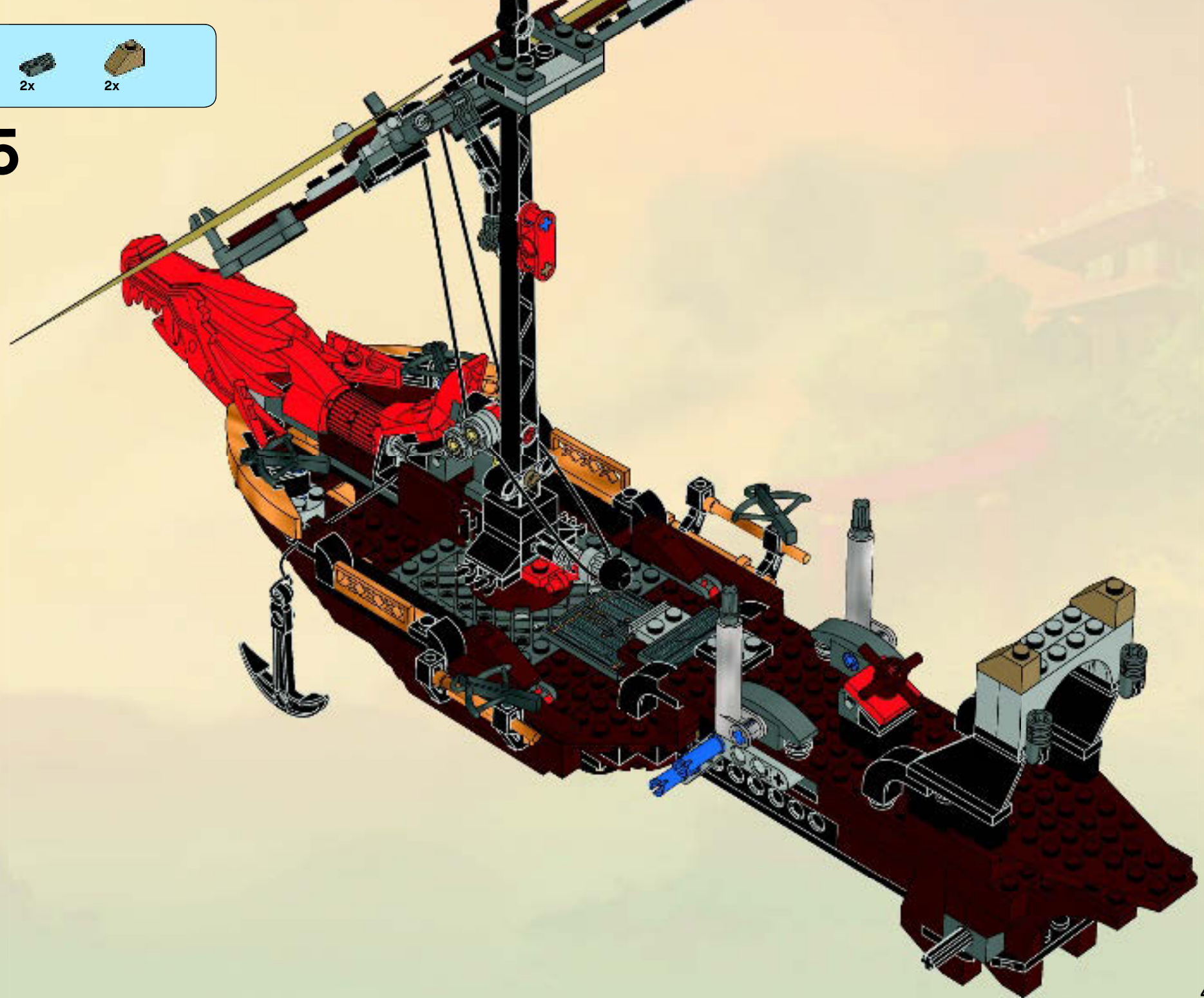

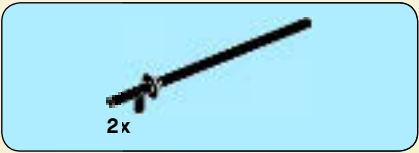

86

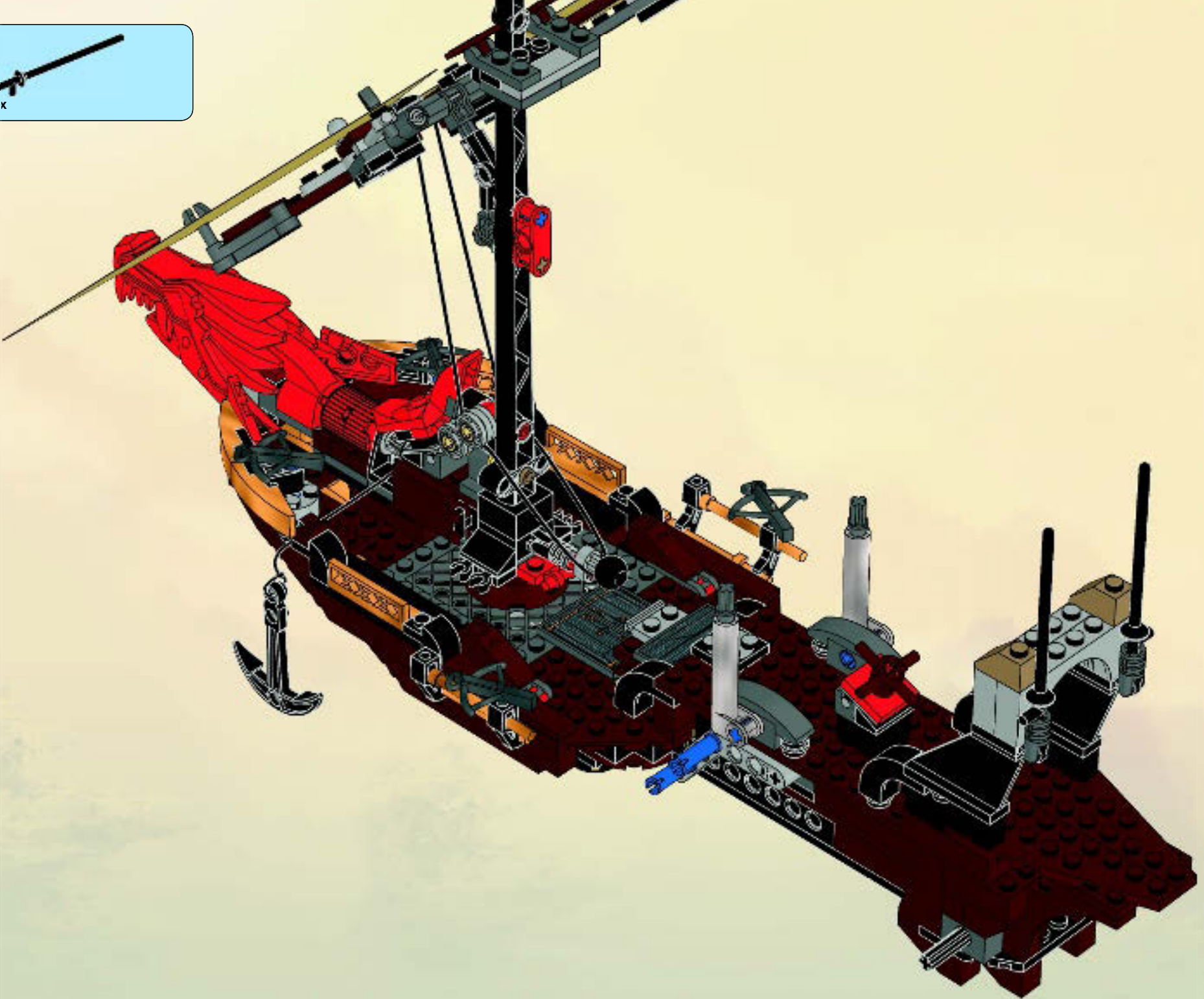

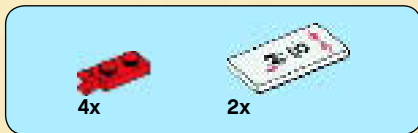

87

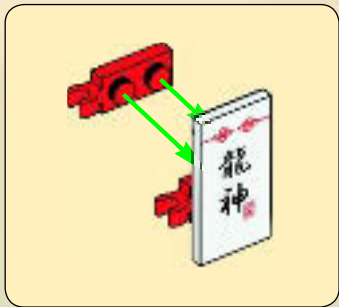
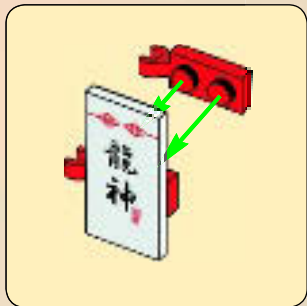
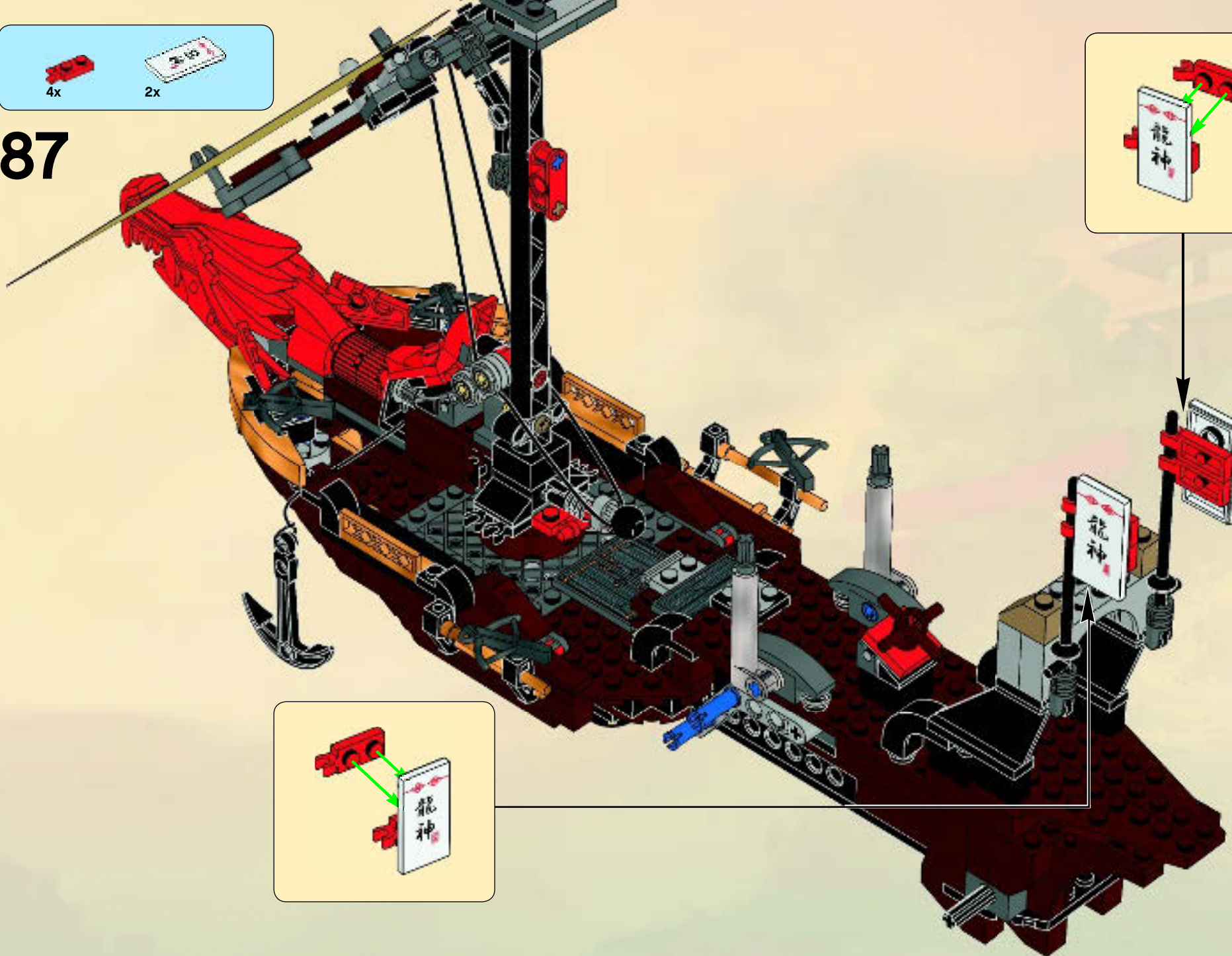

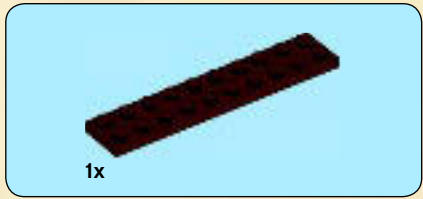

1

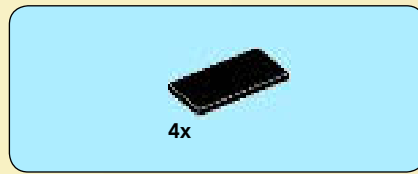

2

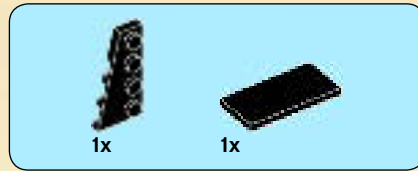
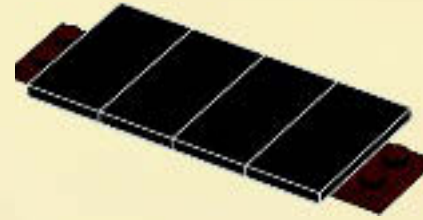

2

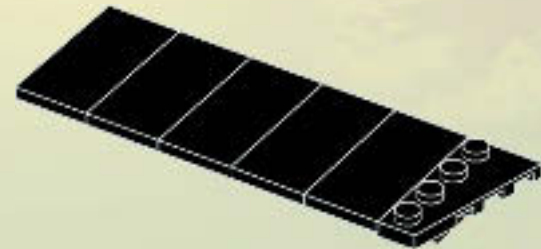





3

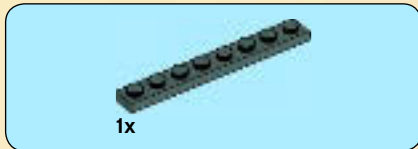
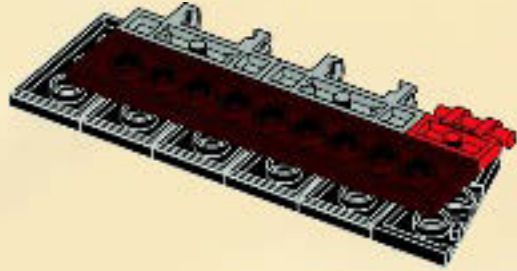

4

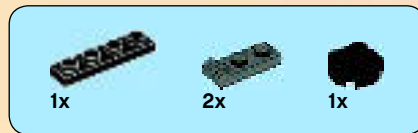
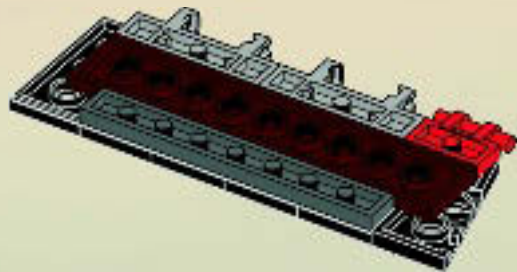

5

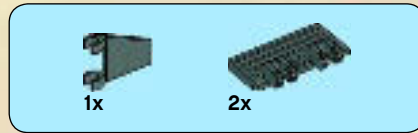
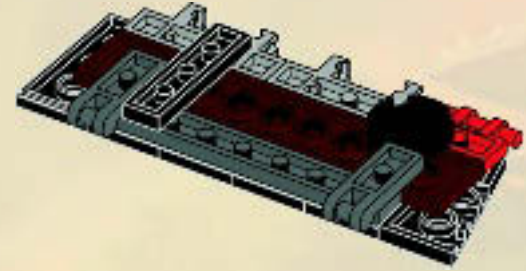

6

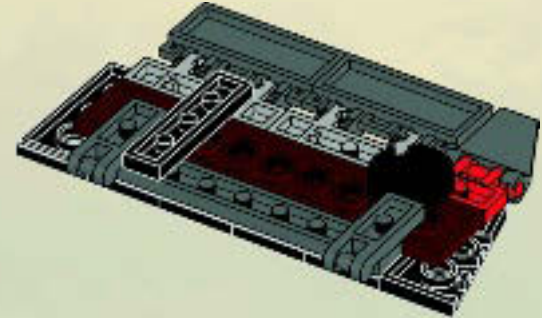

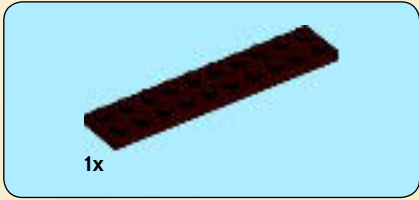
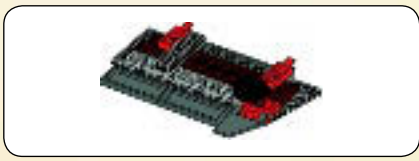

1

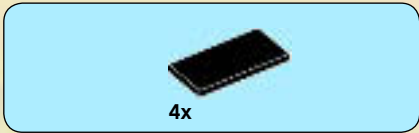

2

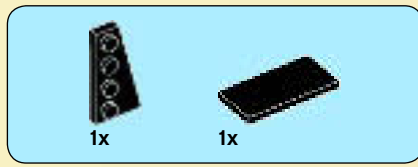
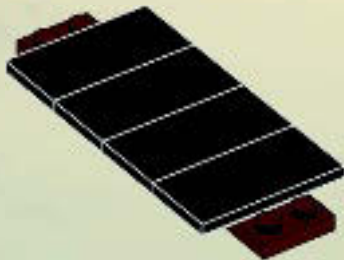

3

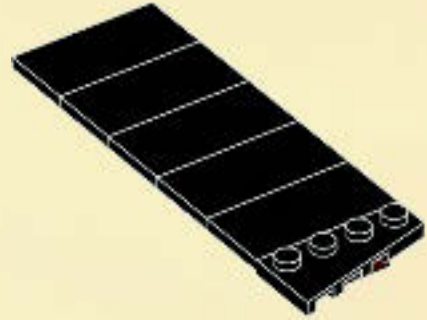

4

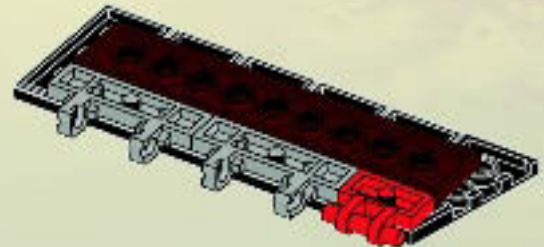
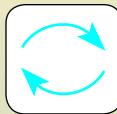

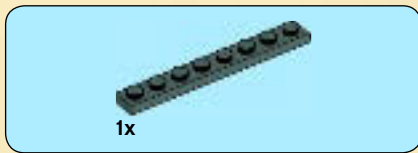

5

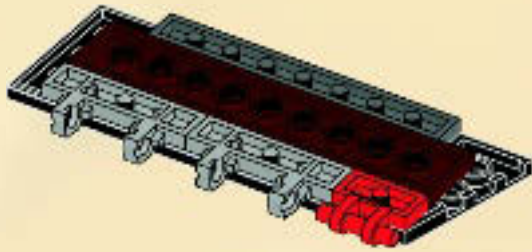

6

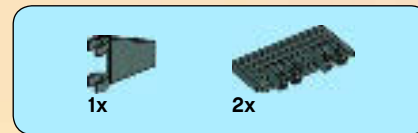
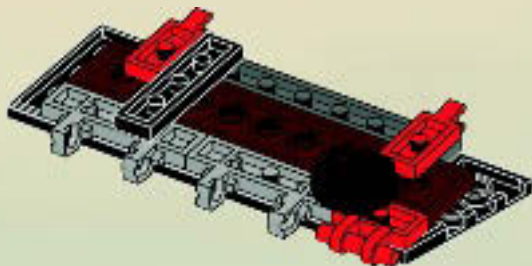

7

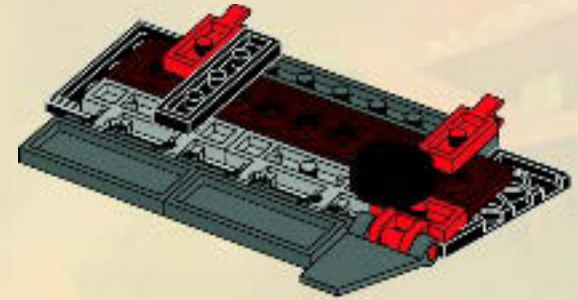

8

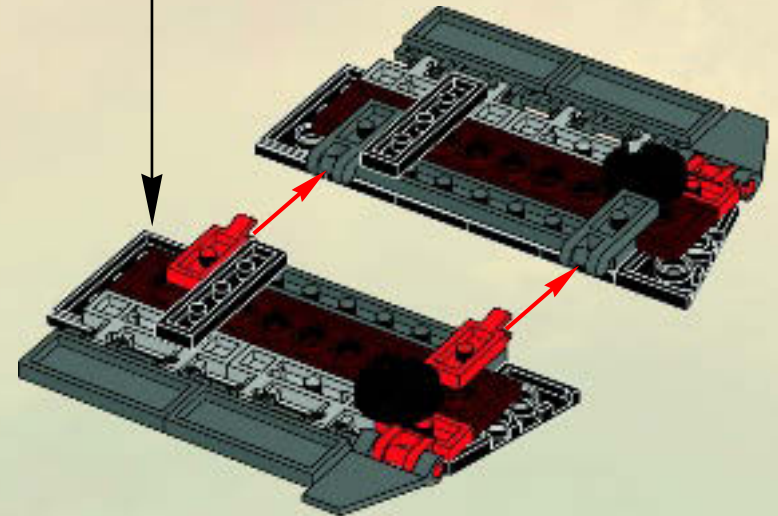



2x



2x

9

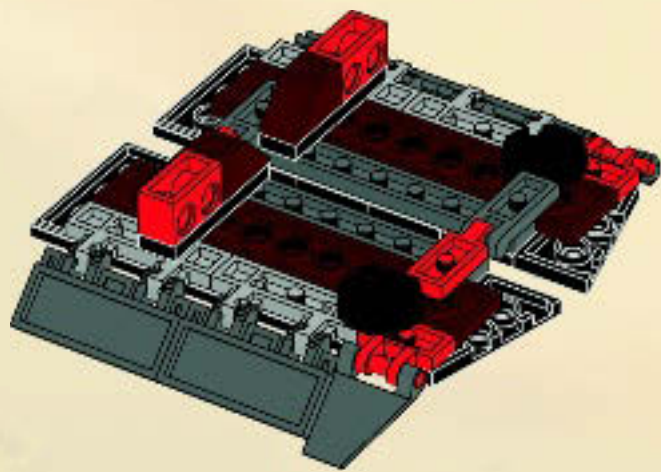

2x

10

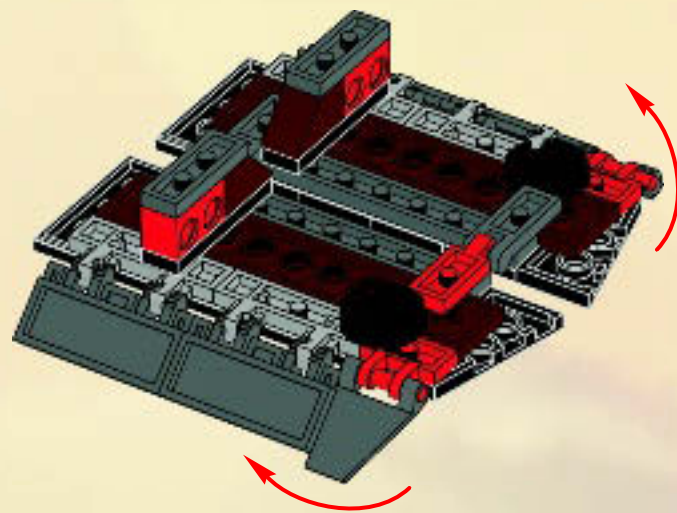

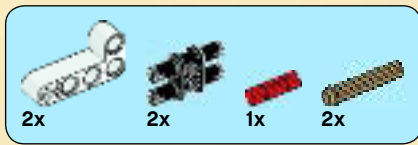

# 11

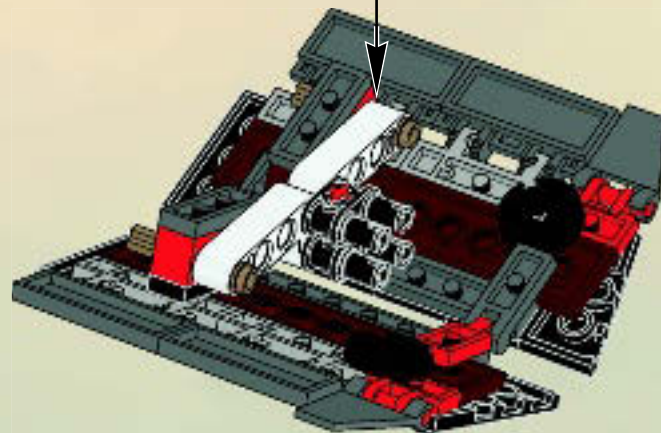
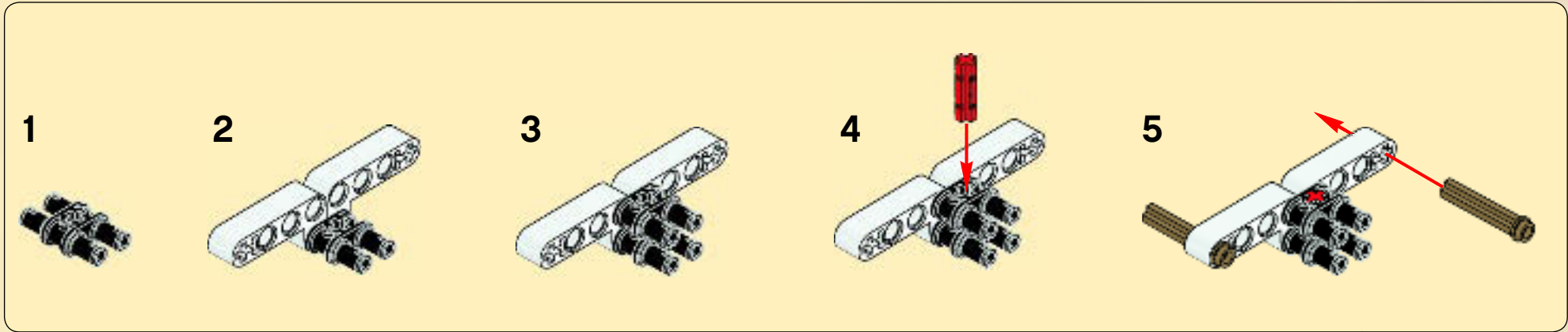



2x

12

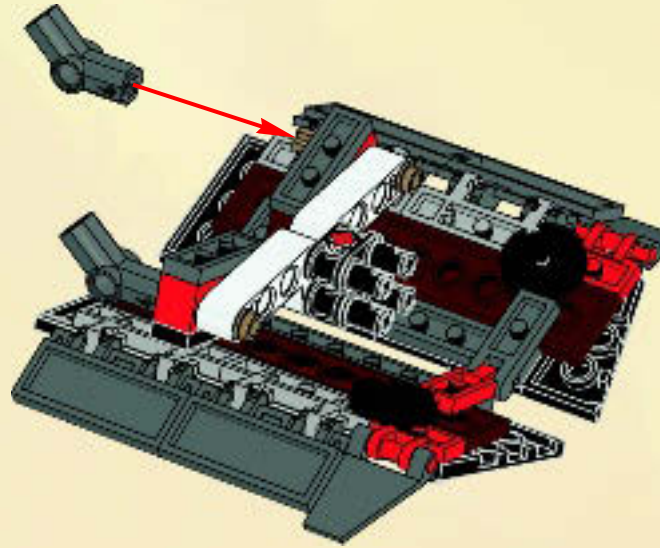

13

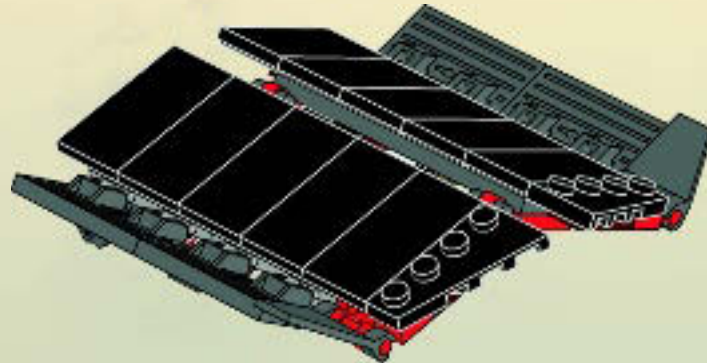
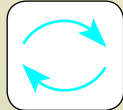

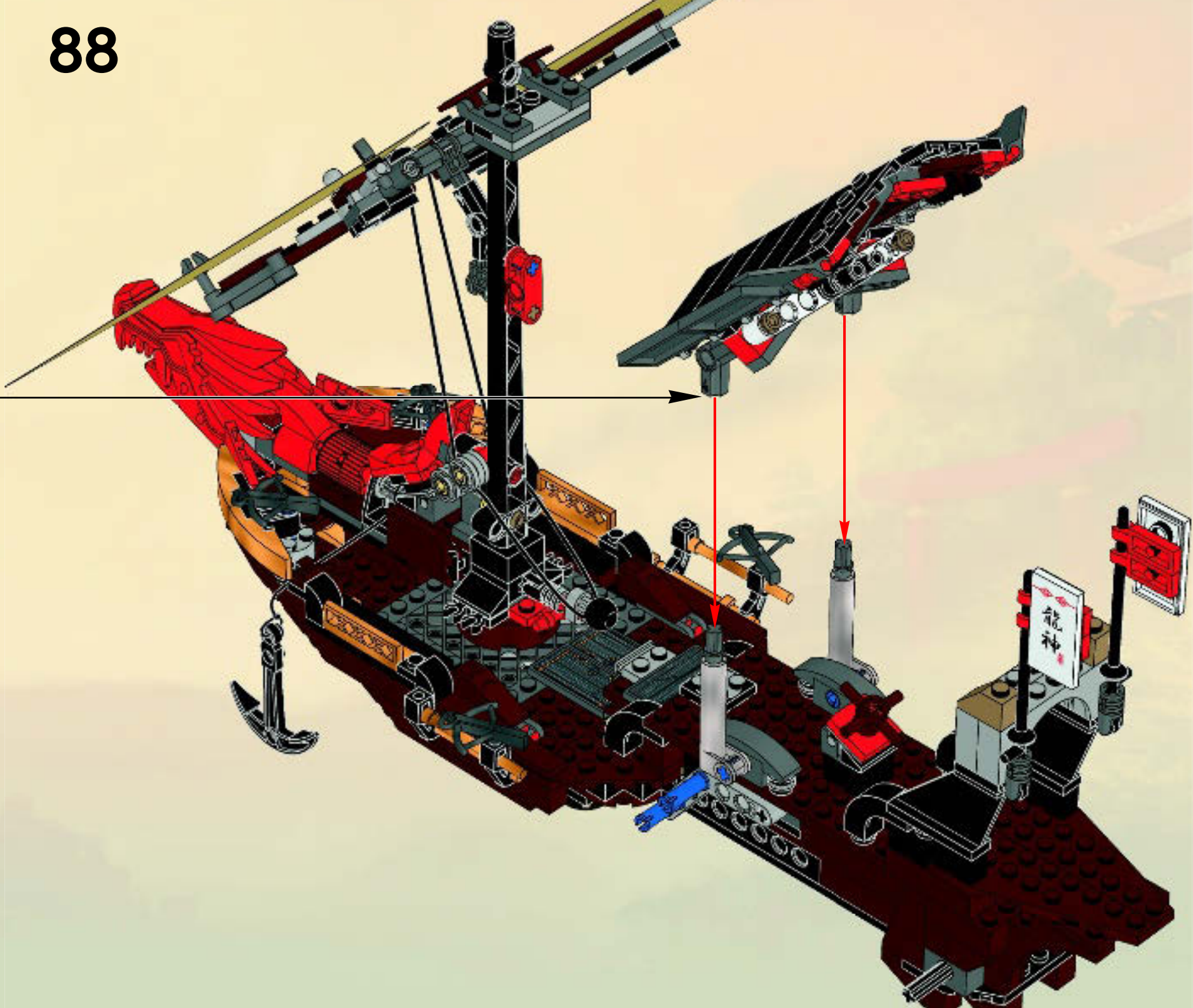

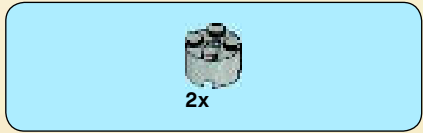
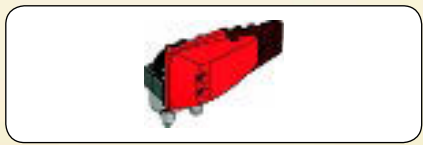

1



2



3



4





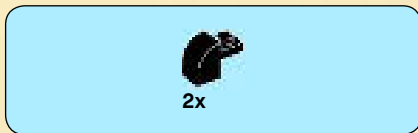

5



6

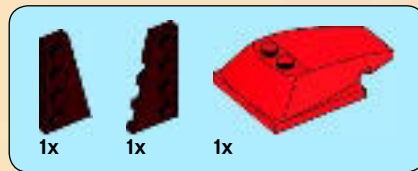
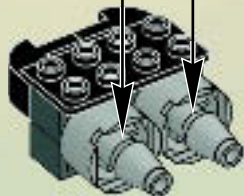
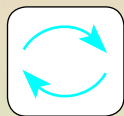
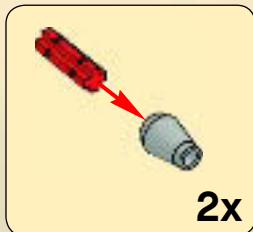

7

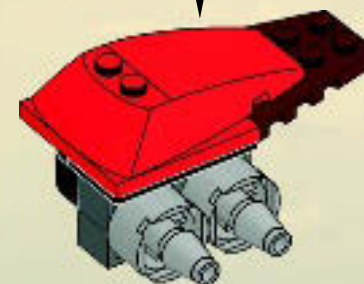
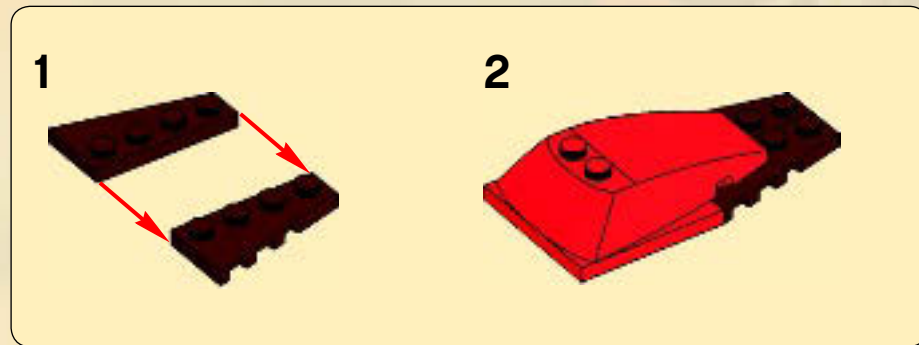

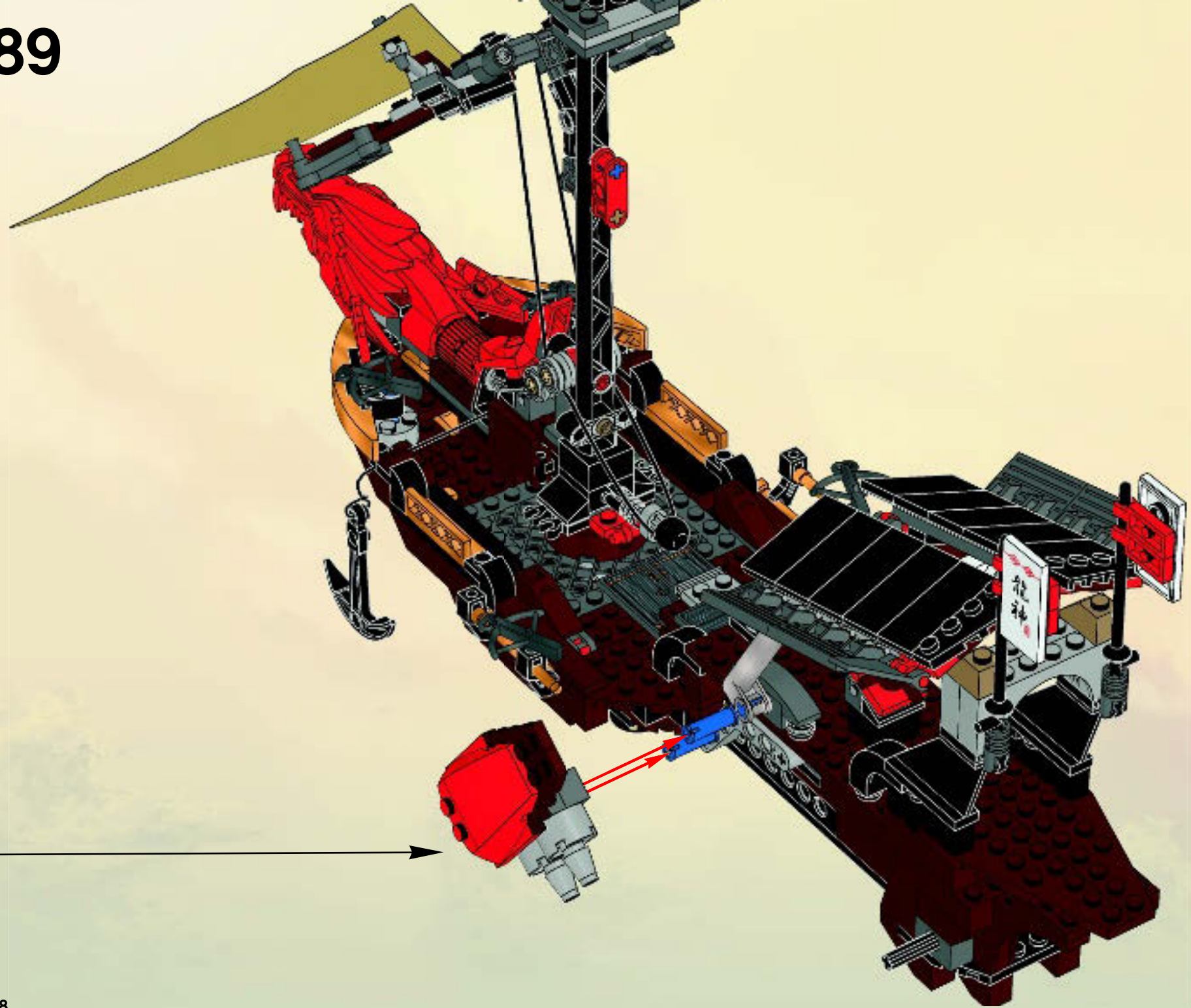

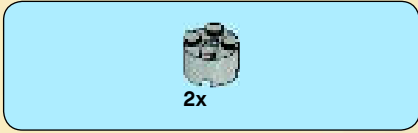
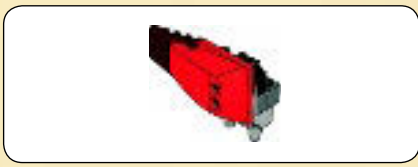

1



2

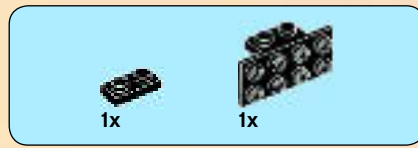
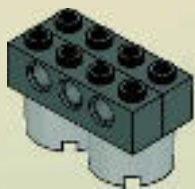

3

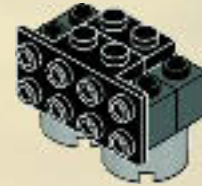

4

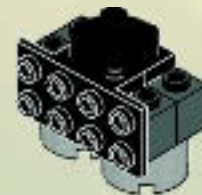



2x

5



2x



2x

6

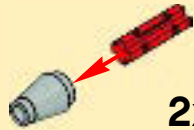

2x

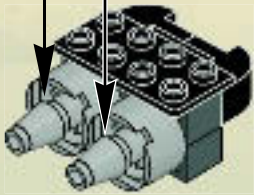

1x



1x

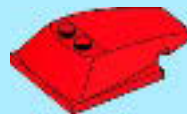

1x

7

1

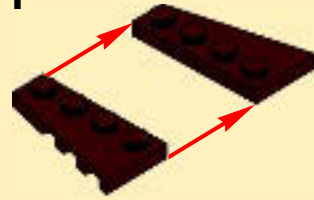

2

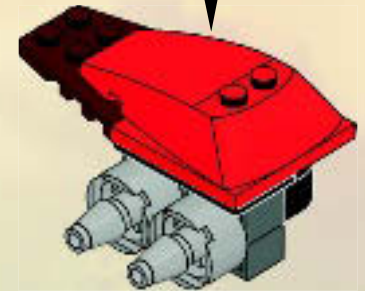

90

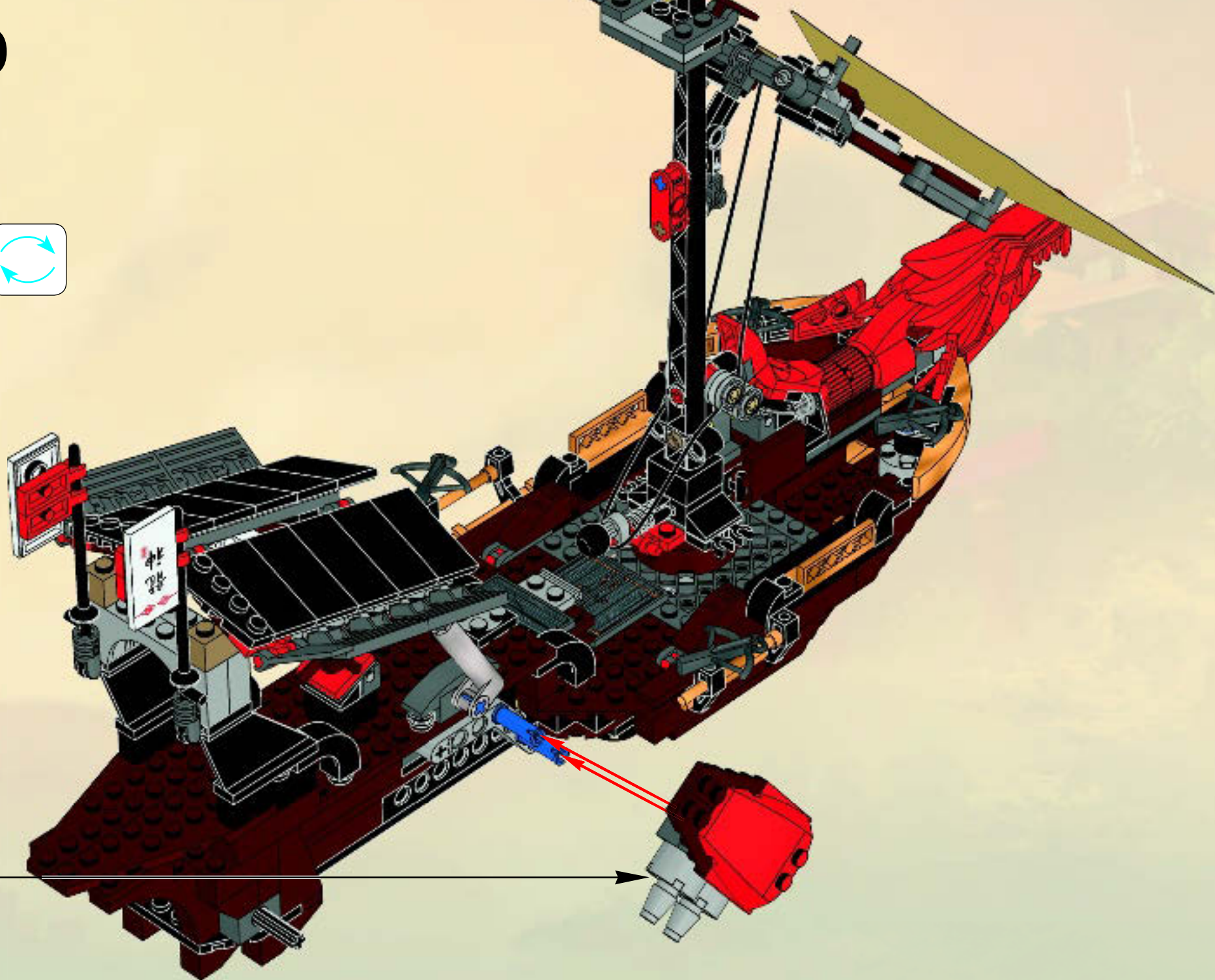
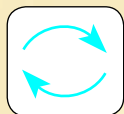

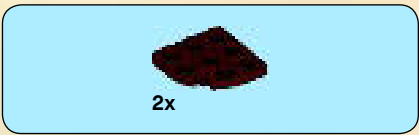
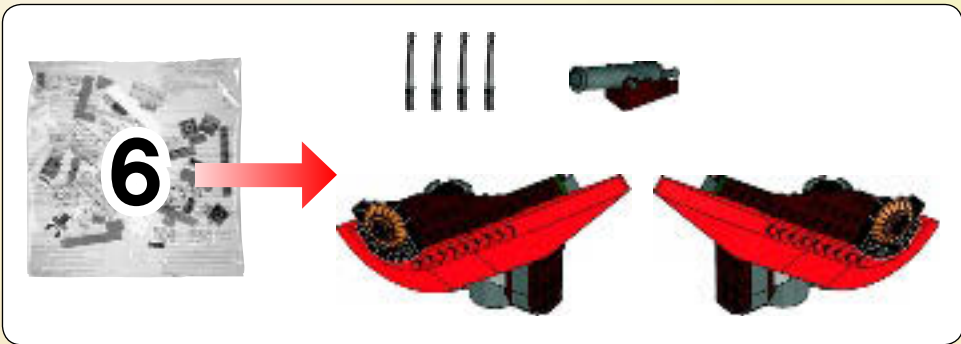

**1**

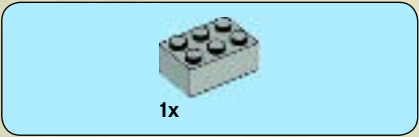
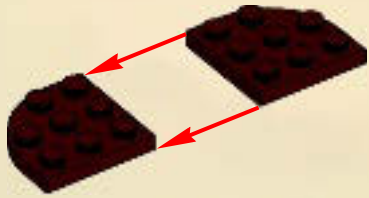

**2**

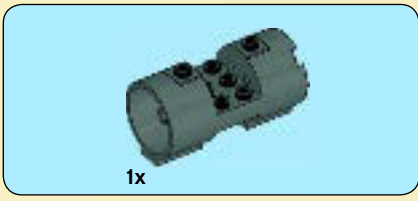

**3**

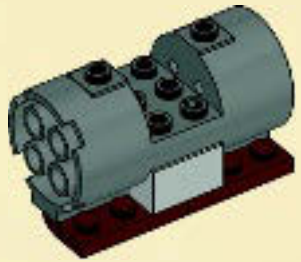

**4**

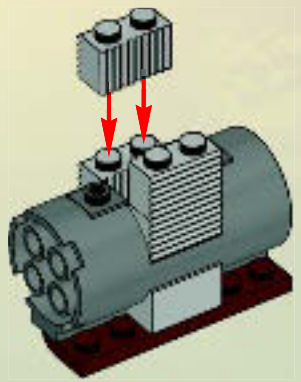

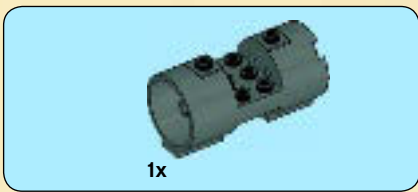

5

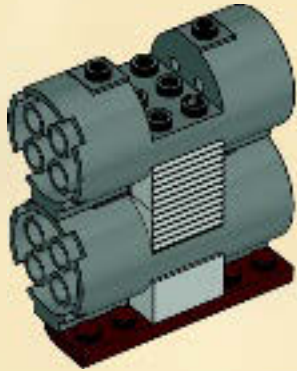

6

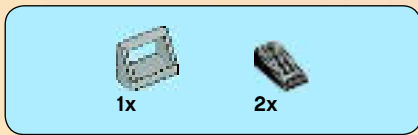
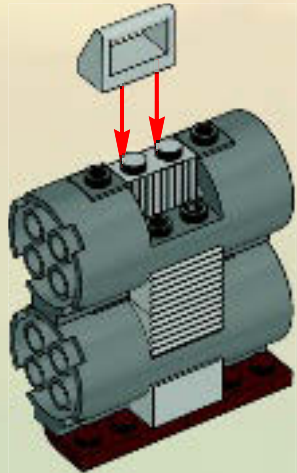

7

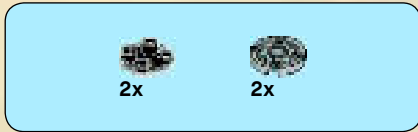
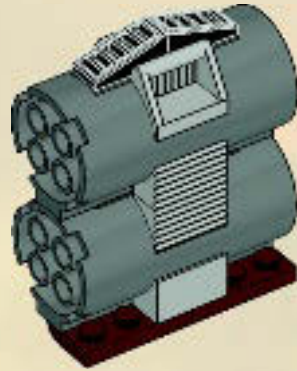

8

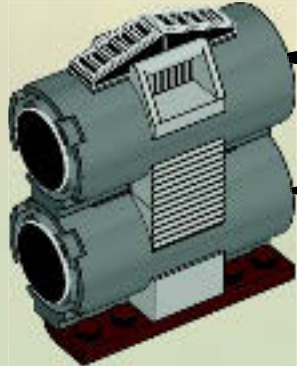
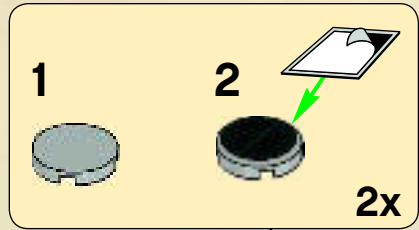

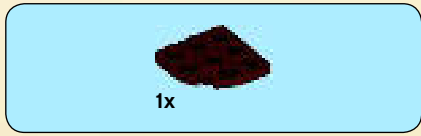

1

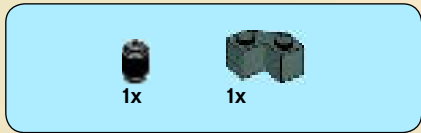

2

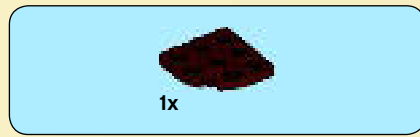

3

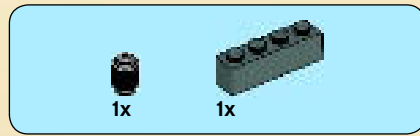

4

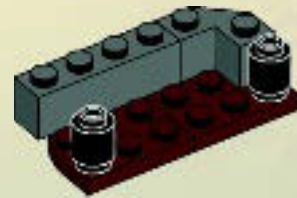



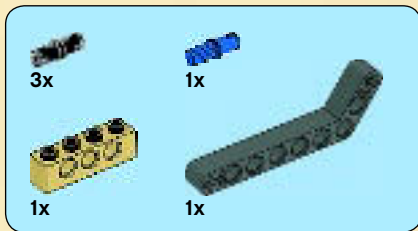

5

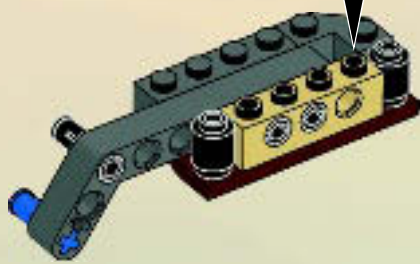
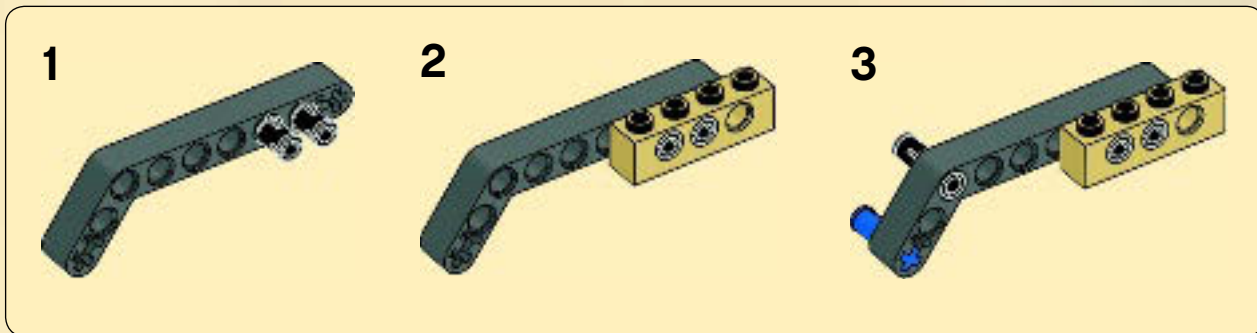

9

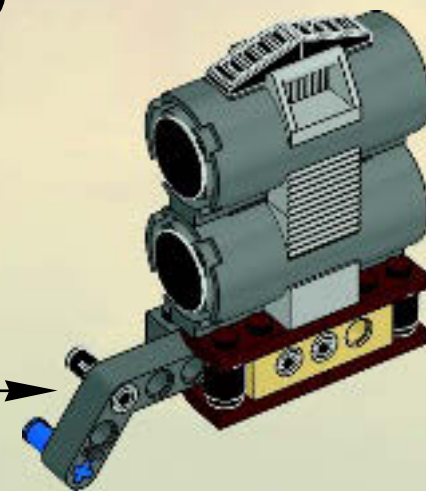

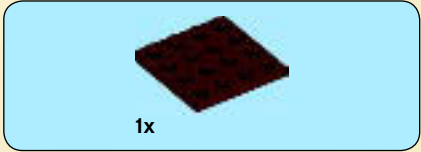

1

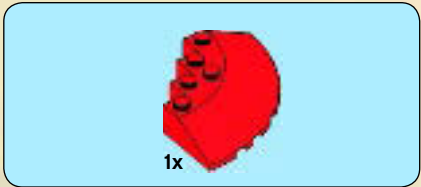

2



3

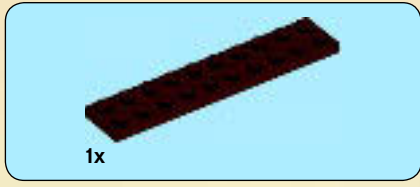

4

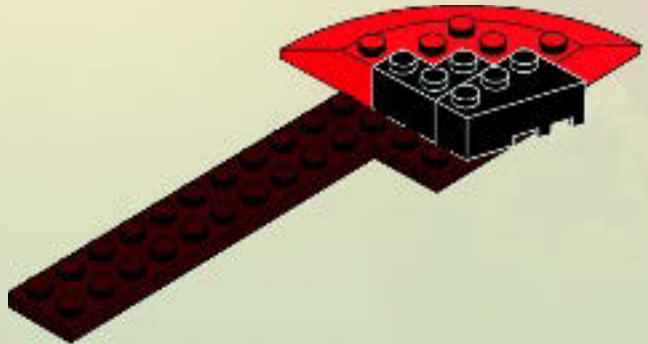

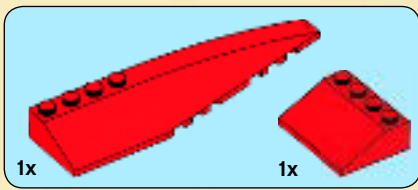

5

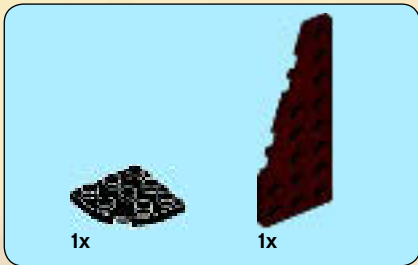
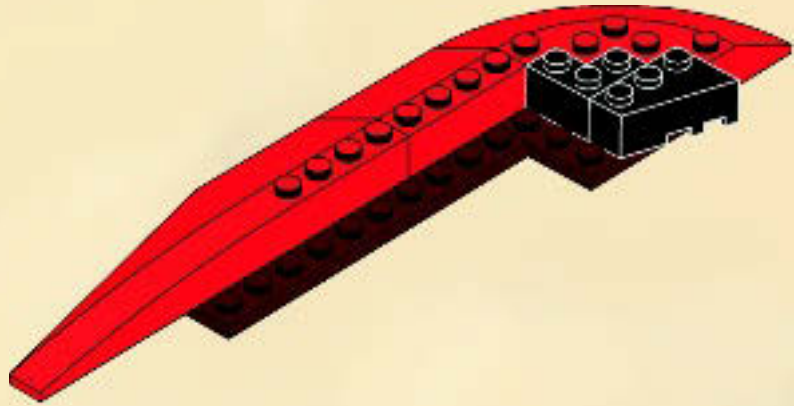

6

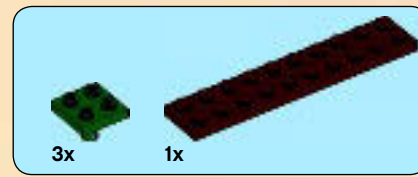
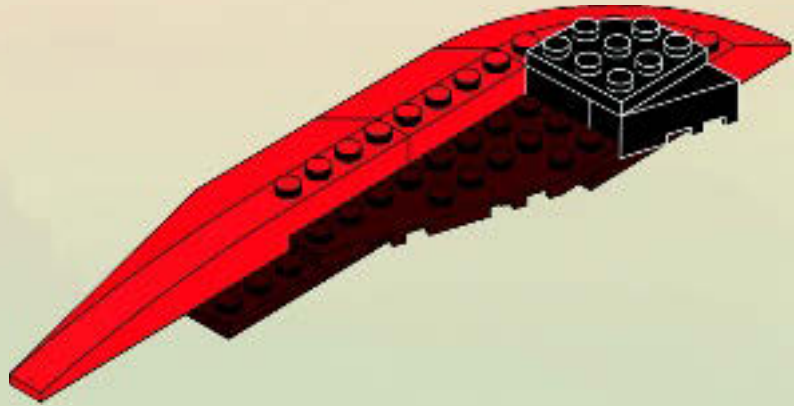

7

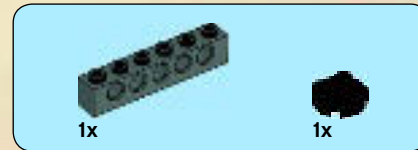
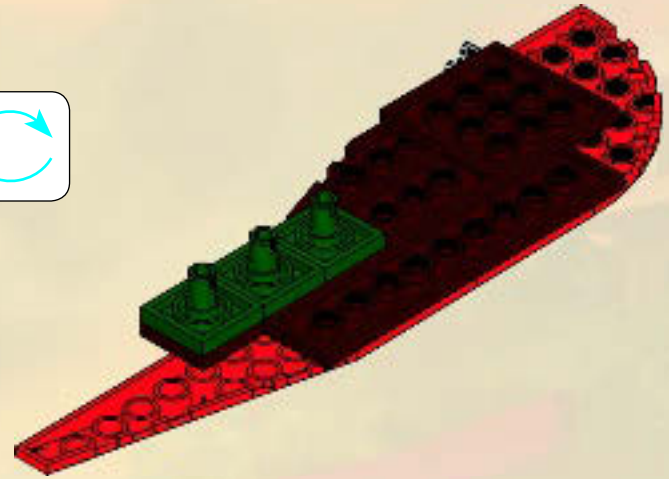
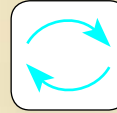

8

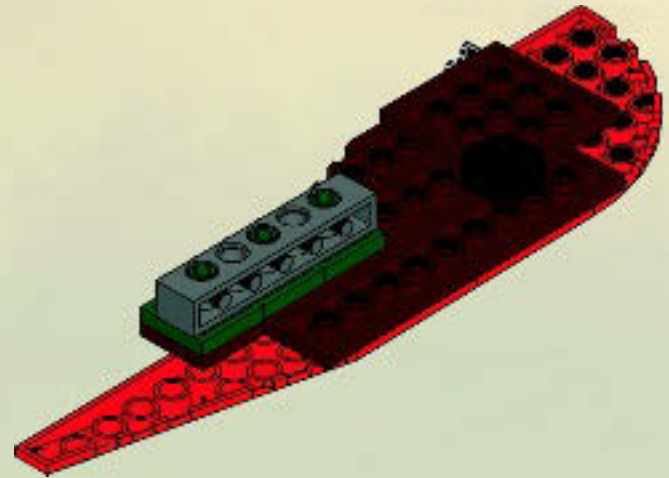



9

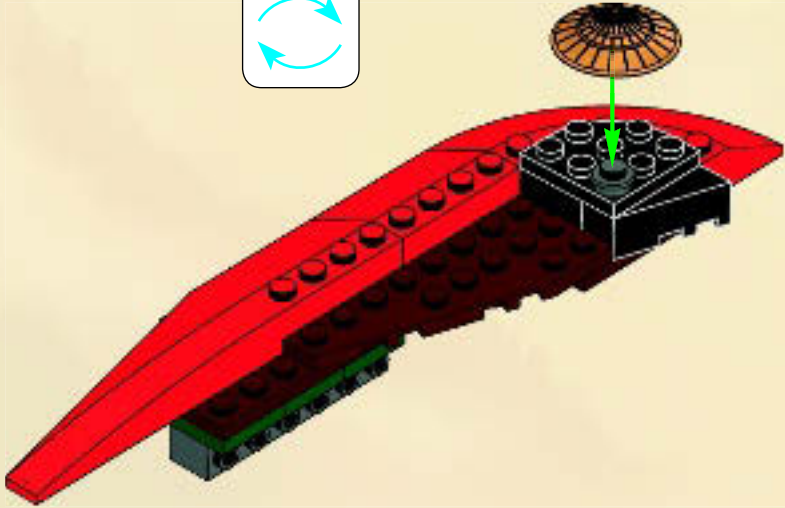

11

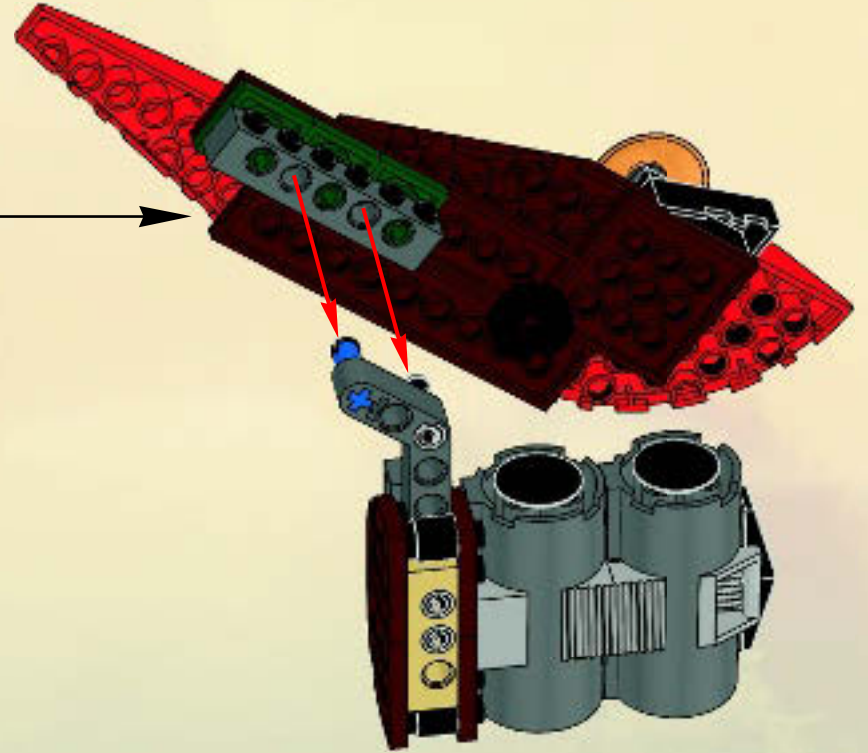

91

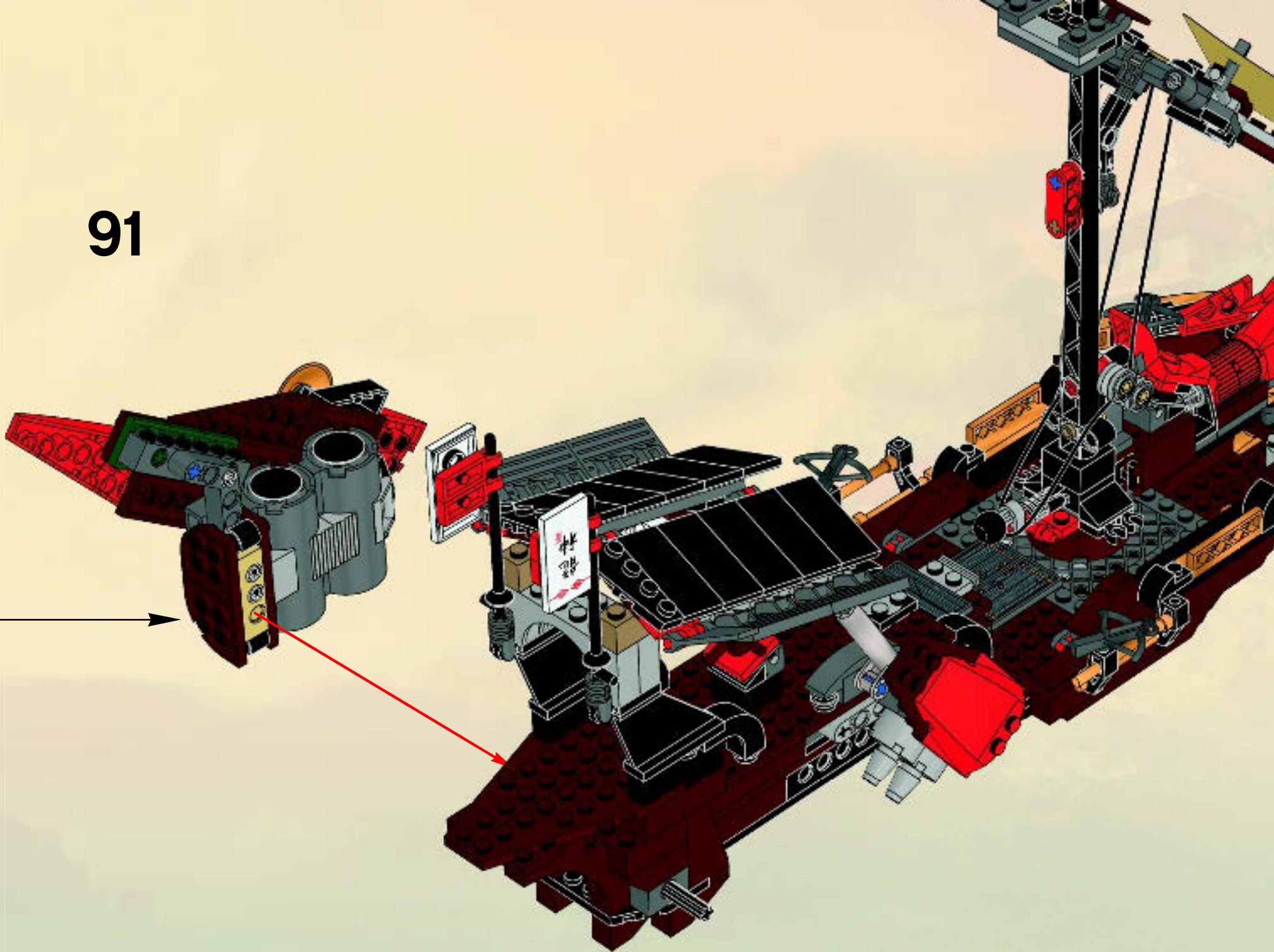

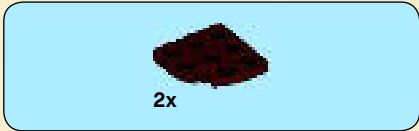

2x

1

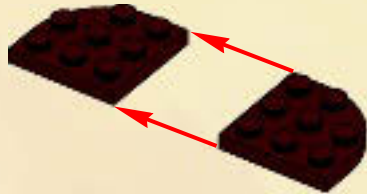

1x

2

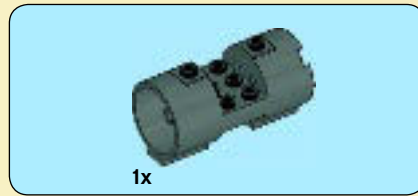

1x

3

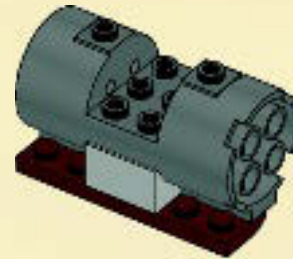

4x

4

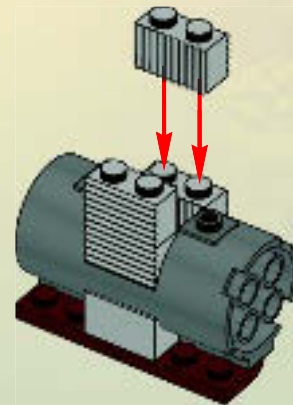



5

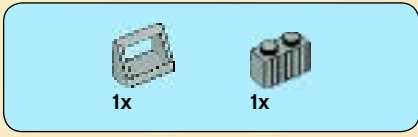
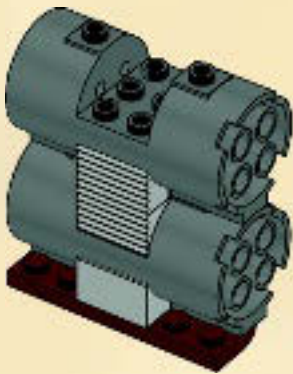

6

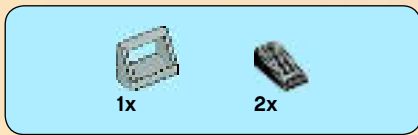
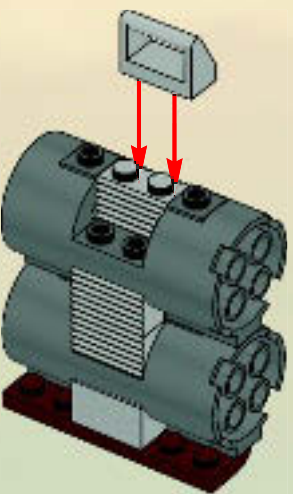

7

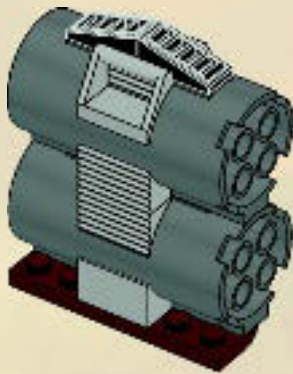

8

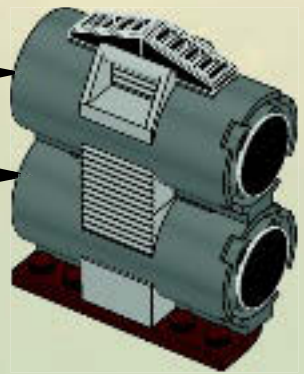
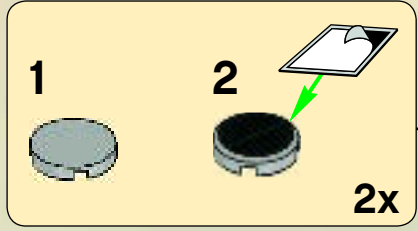



1

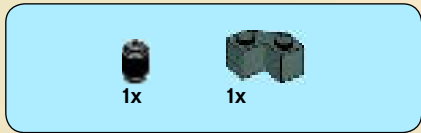

2

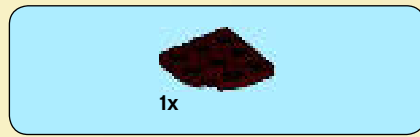

3

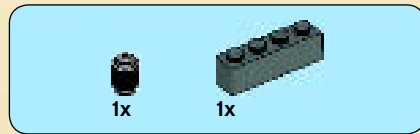

4





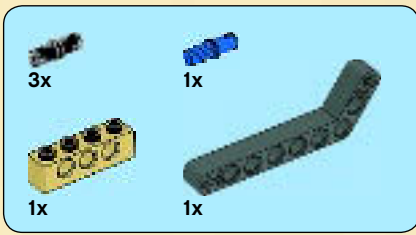

5

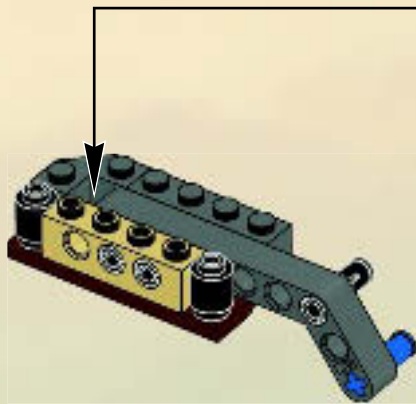
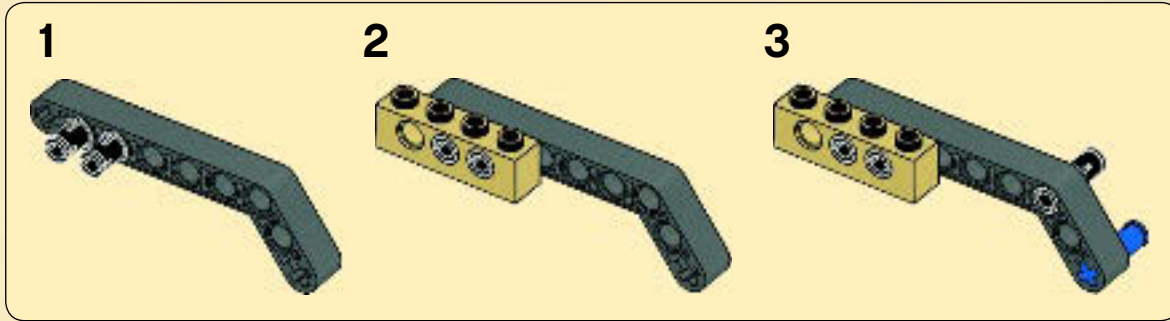

9

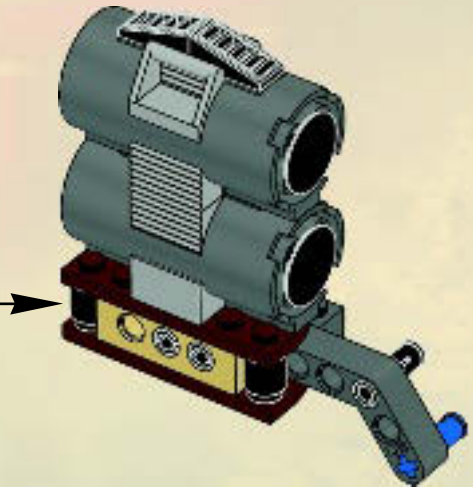

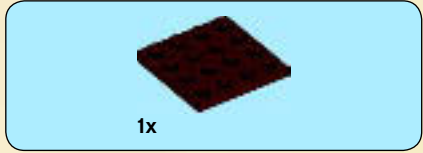

1

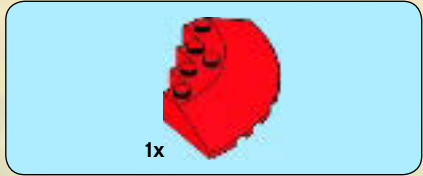

2

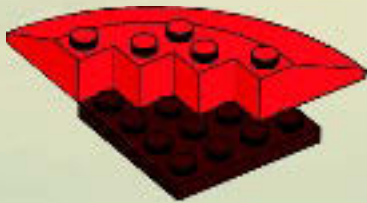

3



4

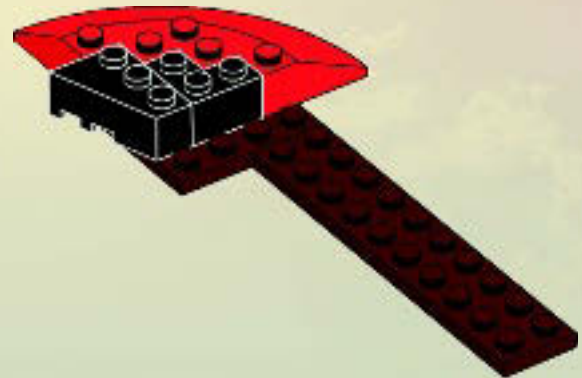
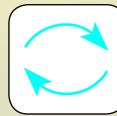

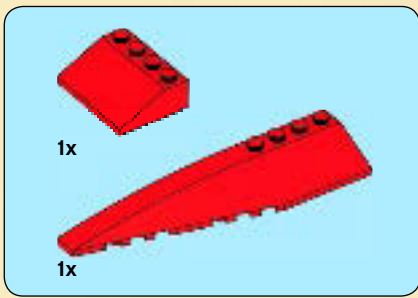

5

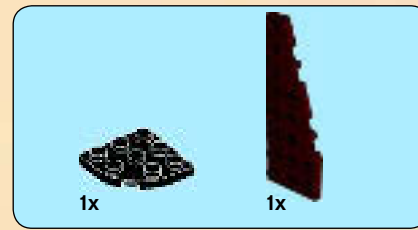
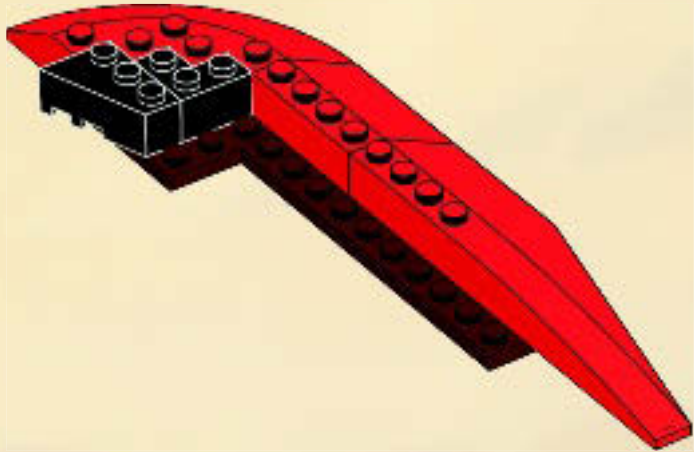

6

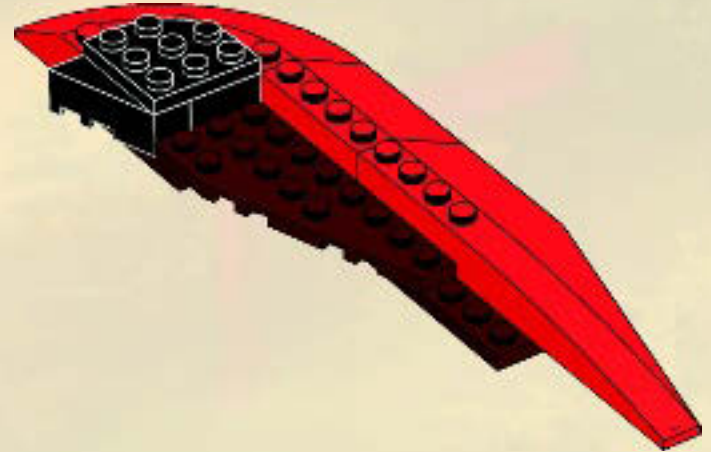

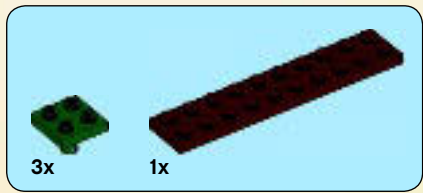

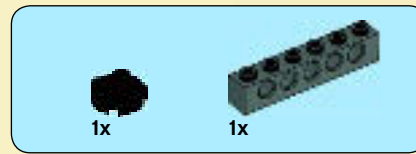
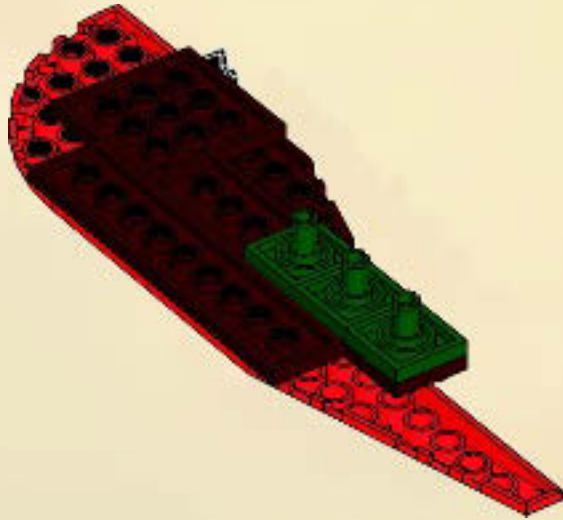

7

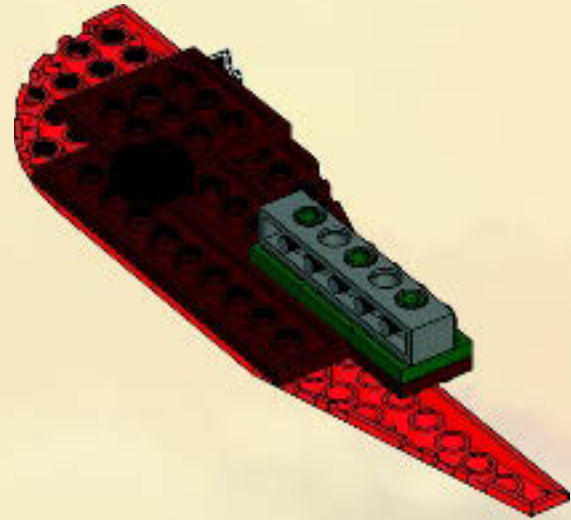

8



1x  1x 

9

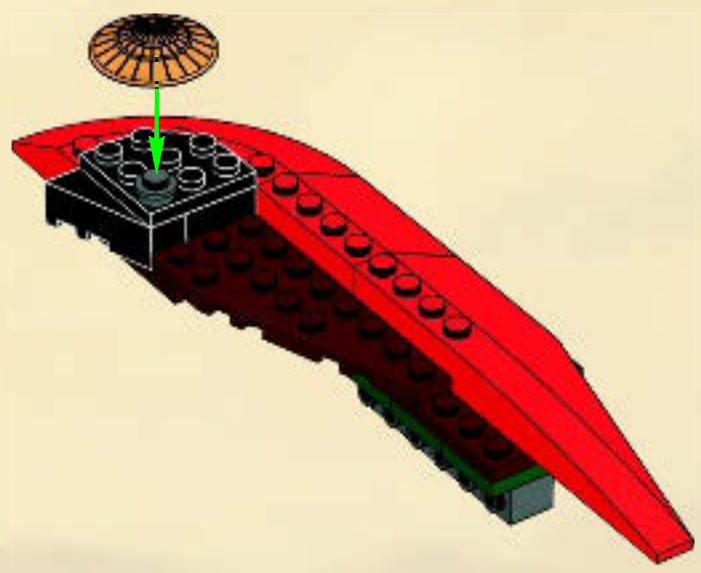
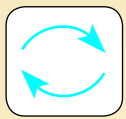

11

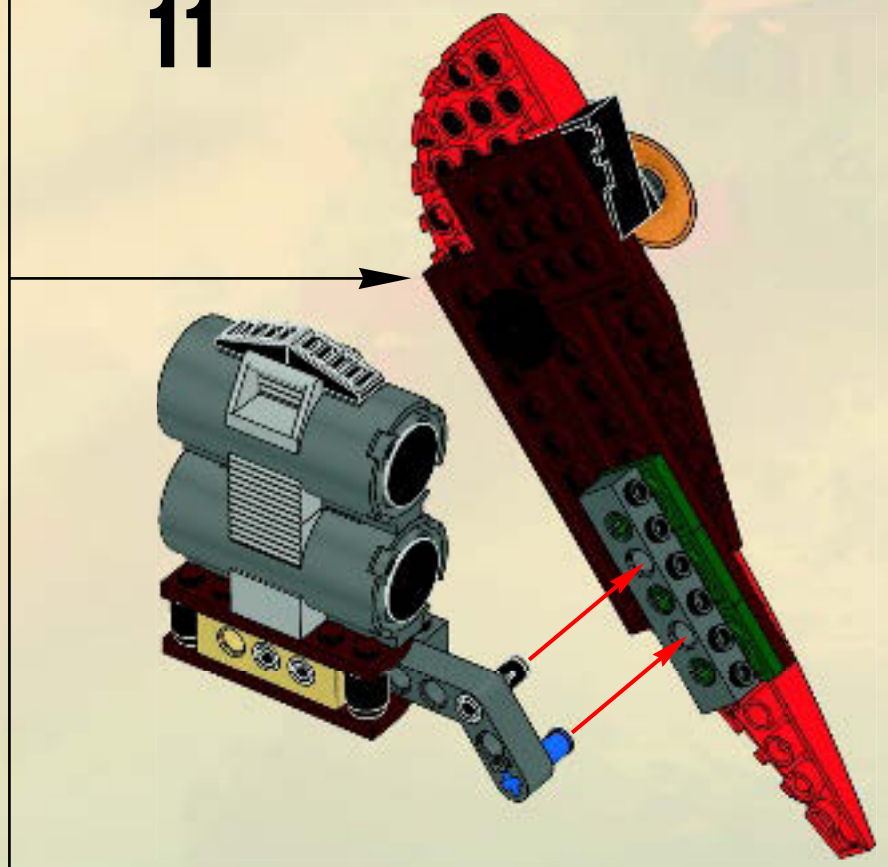

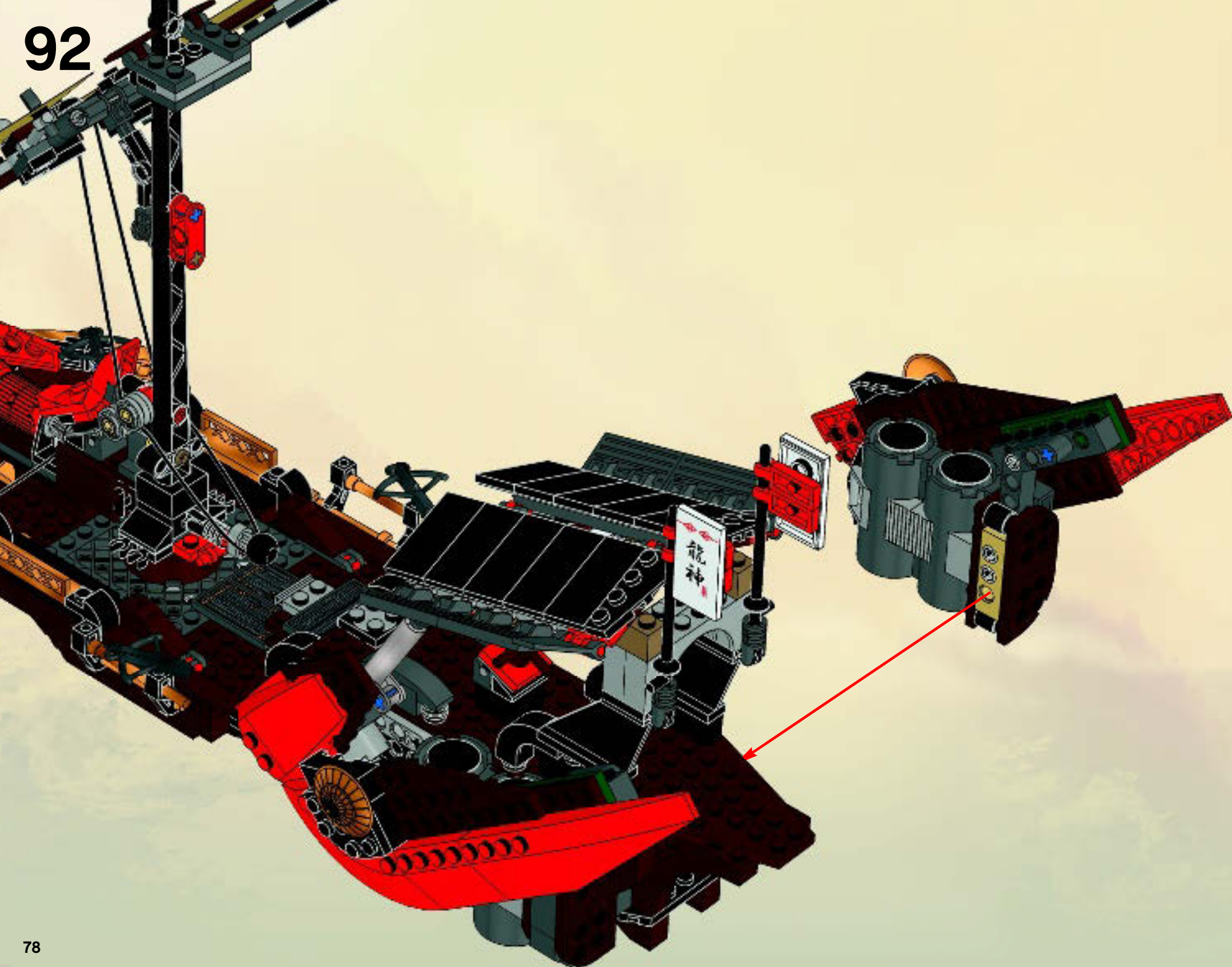

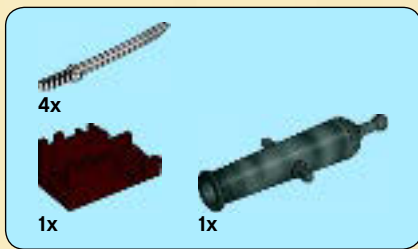

93

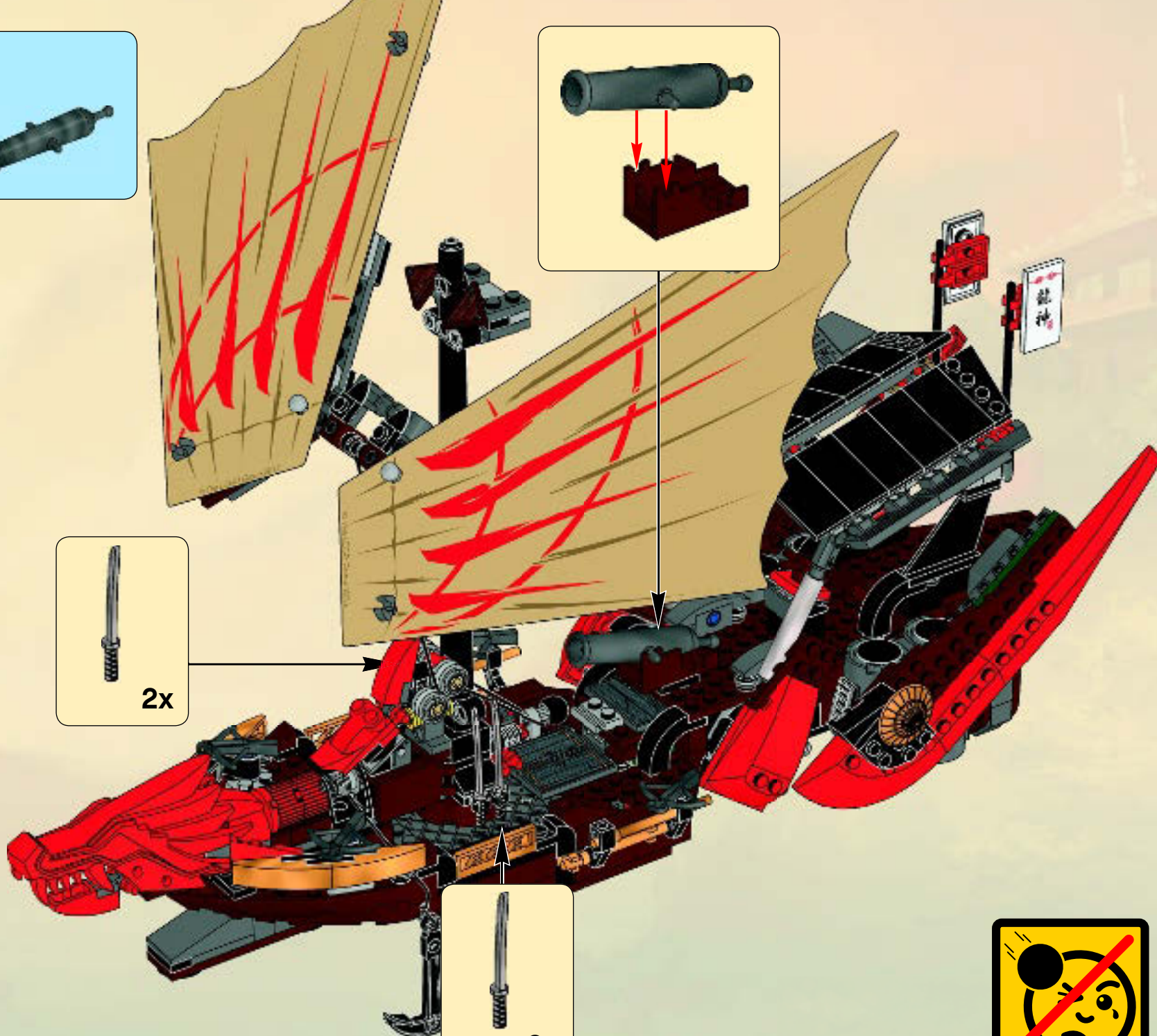
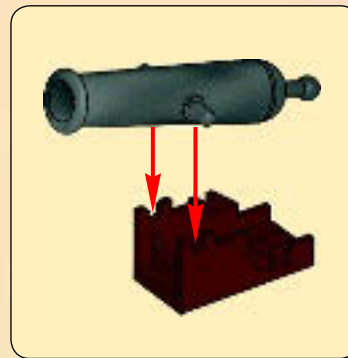

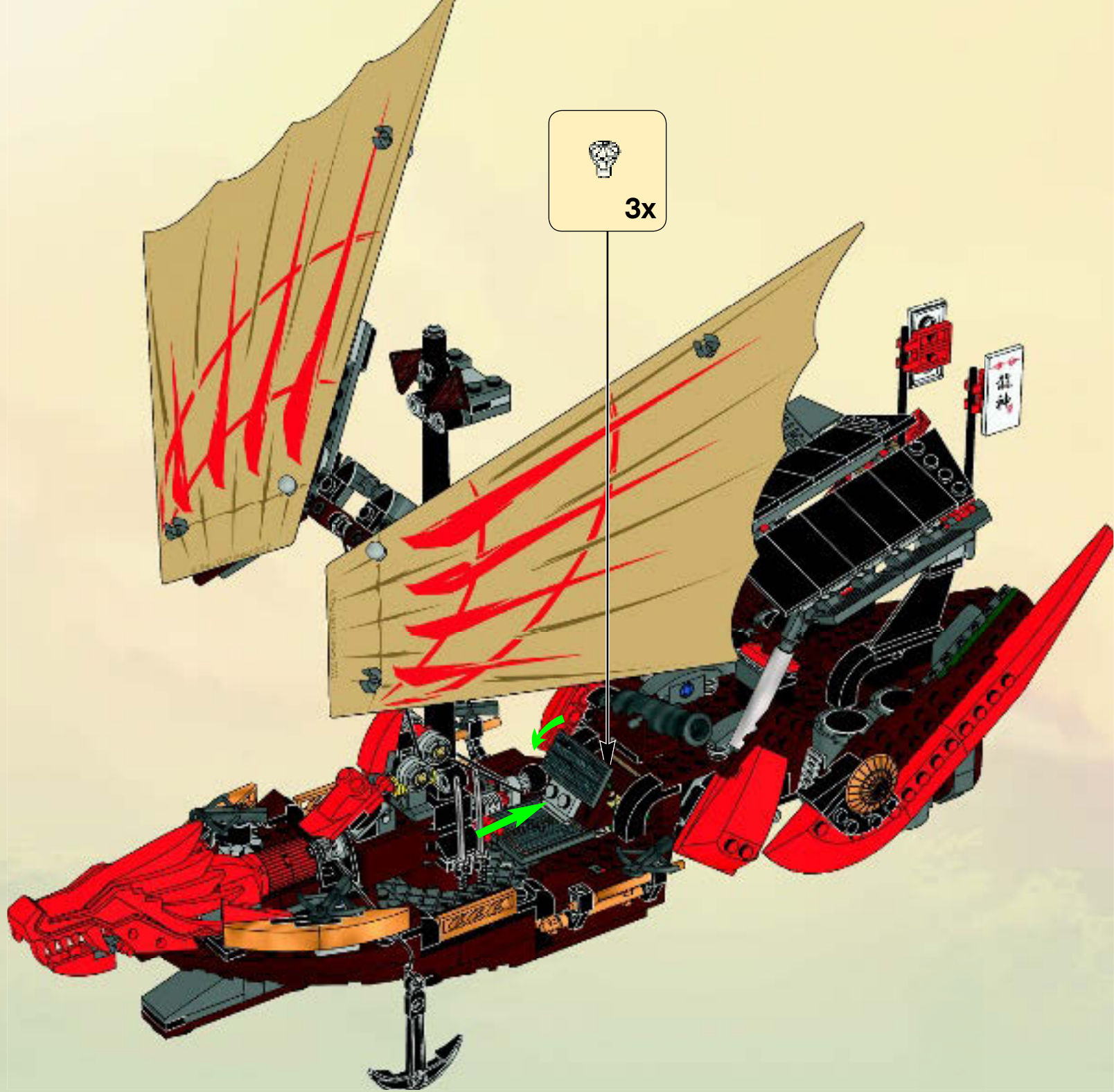

  
3x





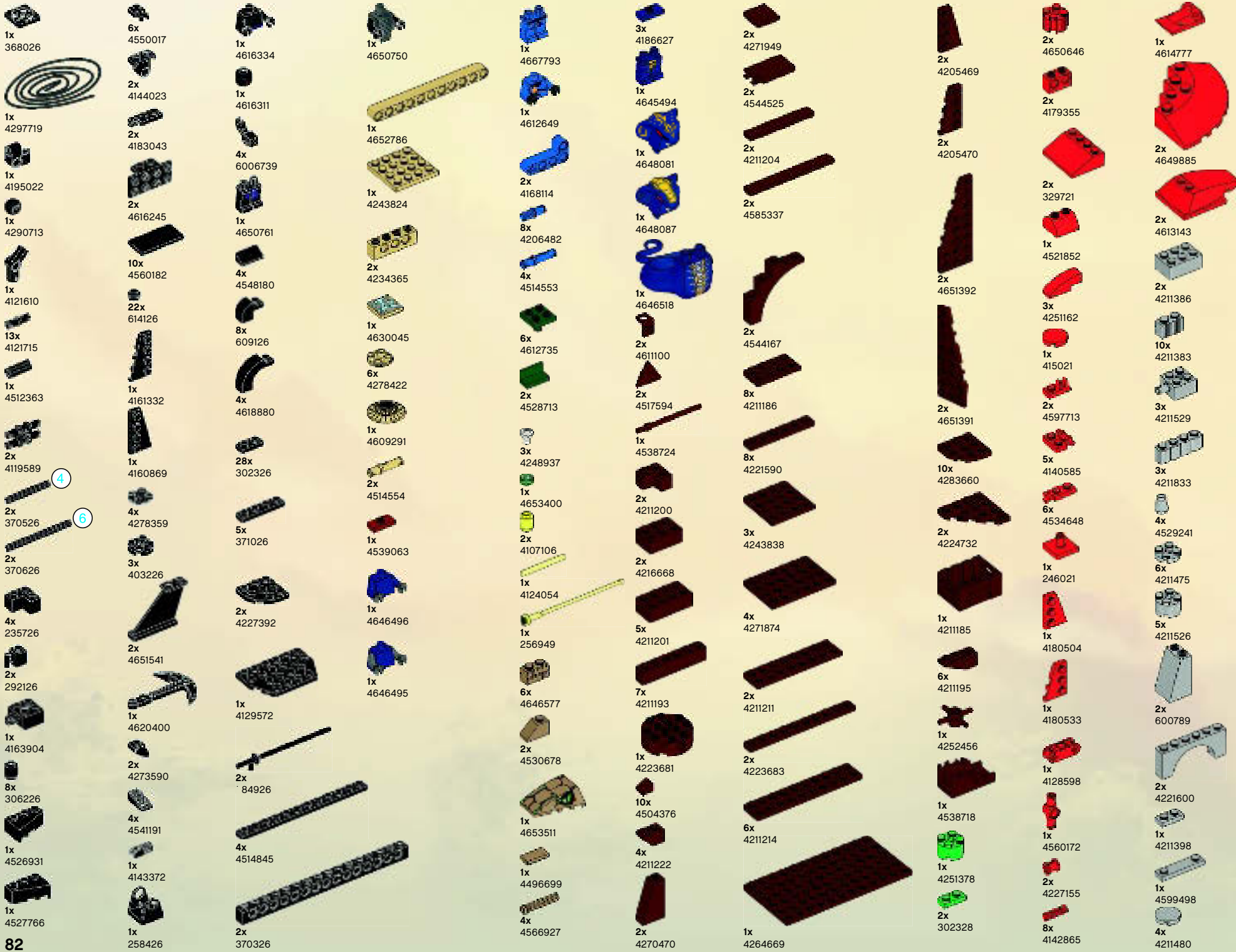

1x  
368026

1x  
4297719

1x  
4195022

1x  
4290713

1x  
4121610

13x  
4121715

1x  
4512363

2x  
4119589

2x  
370526

2x  
370626

4x  
235726

2x  
292126

1x  
4163904

8x  
306226

1x  
4526931

1x  
4527766

6x  
4550017

2x  
4144023

2x  
4183043

2x  
4616245

10x  
4560182

22x  
614126

1x  
4161332

1x  
4160869

4x  
4278359

3x  
403226

2x  
4651541

1x  
4620400

2x  
4273590

4x  
4541191

1x  
4143372

1x  
4143372

1x  
258426

1x  
4616334

1x  
4616311

4x  
6006739

1x  
4650761

4x  
4548180

8x  
609126

4x  
4618880

28x  
302326

5x  
371026

2x  
4227392

1x  
4129572

2x  
84926

4x  
4514845

2x  
370326

1x  
4650750

1x  
4652786

1x  
4243824

2x  
4234365

1x  
4630045

6x  
4278422

1x  
4609291

2x  
4514554

1x  
4539063

1x  
4646496

1x  
4646495

1x  
4667793

1x  
4612649

2x  
4168114

8x  
4206482

4x  
4514553

6x  
4612735

2x  
4528713

3x  
4248937

1x  
4653400

2x  
4107106

1x  
4124054

1x  
256949

6x  
4646577

2x  
4530678

1x  
4653511

1x  
4496699

4x  
4566927

3x  
4186627

1x  
4645494

1x  
4648081

1x  
4648087

1x  
4646518

2x  
4611100

2x  
4517594

1x  
4538724

2x  
4211200

2x  
4216668

5x  
4211201

7x  
4211193

1x  
4223681

10x  
4504376

4x  
4211222

2x  
4270470

2x  
4271949

2x  
4544525

2x  
4211204

2x  
4585337

2x  
4544167

8x  
4211186

8x  
4221590

3x  
4243838

4x  
4271874

2x  
4211211

2x  
4223683

6x  
4211214

1x  
4264669

2x  
4205469

2x  
4205470

2x  
4651392

2x  
4651391

10x  
4283660

2x  
4224732

1x  
4211185

6x  
4211195

1x  
4252456

1x  
4538718

1x  
4251378

2x  
302328

2x  
4650646

2x  
4179355

2x  
329721

1x  
4521852

3x  
4251162

1x  
415021

2x  
4597713

5x  
4140585

6x  
4534648

1x  
246021

1x  
4180504

1x  
4180533

1x  
4128598

1x  
4560172

2x  
4227155

8x  
4142865

1x  
4614777

2x  
4649885

2x  
4613143

2x  
4211386

10x  
4211383

3x  
4211529

3x  
4211833

4x  
4529241

6x  
4211475

5x  
4211526

2x  
600789

2x  
4221600

1x  
4211398

1x  
4599498

4x  
4211480

- 1x 4211568
- 4x 4211840
- 2x 4262978
- 4x 4211357
- 1x 4211370
- 1x 4540203
- 1x 4211469
- 1x 4211470
- 3x 4211881
- 2x 4211668
- 4x 4211758
- 2x 4211375
- 3x 4211807
- 1x 4211815
- 1x 4211639
- 2x 4211759

- 1x 4211609
- 1x 4211088
- 2x 4211103
- 2x 4624186
- 2x 4210633
- 2x 4215387
- 7x 4211111
- 4x 4213607
- 2x 4210917
- 2x 4210963
- 1x 4211054
- 1x 4210637
- 2x 4648256
- 4x 4211094
- 6x 4211133
- 2x 4211043

- 6x 4210998
- 2x 4211069
- 2x 4579354
- 1x 4210763
- 4x 4196768
- 6x 4521187
- 2x 4217558
- 3x 4560184
- 4x 4611708
- 1x 4260707
- 1x 4299022
- 1x 4210886
- 4x 4645091

- 2x 4649635
- 2x 4612797
- 4x 4289542
- 2x 4210695
- 3x 4211066
- 2x 4281516
- 2x 4210658
- 2x 4210688
- 1x 4516546
- 2x 4210665
- 2x 4508553
- 4x 4649538
- 4x 4523160
- 2x 4536675
- 4x 4600270

- 2x 4649896
- 2x 4617761
- 1x 4640843
- 1x 4646828
- 1x 4646871
- 6x 4286597
- 15x 4519970
- 2x 4518557
- 3x 4518687
- 13x 4623298
- 1x 4636105
- 4x 4612900
- 2x 4646867
- 2x 4609612
- 4x 4617248

- 1x 4646806
- 1x 4638950
- 2x 300101
- 2x 4612857
- 1x 4667795
- 1x 4651720
- 1x 4612637
- 1x 4651703
- 1x 4600294
- 1x 4609289
- 2x 4118980
- 1x 4611427
- 1x 4611429
- 4x 4239601
- 1x 4611432

- 3x 4541980
- 1x 4651357
- 2x 4612857
- 1x 4653733
- 1x 4651703
- 1x 4600294
- 1x 4609289
- 2x 4118980
- 1x 4611427
- 1x 4611429
- 4x 4239601
- 1x 4611432
- 1x 4263506

- 1x 4649529
- 1x 4651359

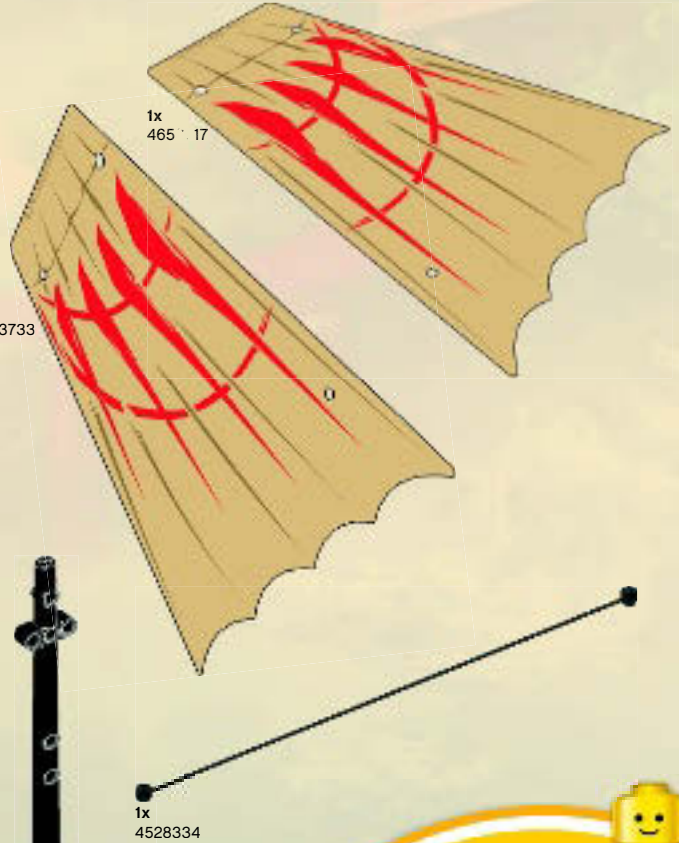

**Customer Service**  
**Kundenservice**  
**Service Consommateurs**  
**Servicio Al Consumidor**

[www.lego.com/service](http://www.lego.com/service) or dial

: 00800 5346 5555  
 : 1-800-422-5346



# WIN!

Go to [www.LEGOsurvey.com/product](http://www.LEGOsurvey.com/product) to fill out a survey for a chance to win a cool LEGO® Product.

No purchase necessary.

Open to all residents where not prohibited.



[www.LEGO.com](http://www.LEGO.com)



## [www.LEGOsurvey.com/product](http://www.LEGOsurvey.com/product)

### GEWINNE!

Nimm an der Umfrage auf [www.LEGOsurvey.com/product](http://www.LEGOsurvey.com/product) teil und hab die Chance ein cooles LEGO® Produkt zu gewinnen!

Die Teilnahme am Gewinnspiel führt zu keinerlei Kaufverpflichtungen. Teilnahme in allen nicht ausgeschlossenen Ländern möglich.

### WIN!

Ga naar [www.LEGOsurvey.com/product](http://www.LEGOsurvey.com/product), vul een enquêteformulier in en maak kans op een cool LEGO® product.

Geen aankoopverplichting. Iedereen mag deelnemen, uitgezonderd ingezetenden van landen waar een enquêteverbod geldt.

### GAGNE!

Visite [www.LEGOsurvey.com/product](http://www.LEGOsurvey.com/product) pour répondre à un questionnaire et avoir une chance de gagner un produit LEGO® très cool!

Aucune obligation d'achat. Ouvert à tous les résidents des pays autorisés.

### 当てよう!

[www.LEGOsurvey.com/product](http://www.LEGOsurvey.com/product) にアクセスして、アンケートにご記入ください。当選者にはレゴ®製品を差し上げます。

お買い上げの必要はありません。禁止されていない限り、すべての皆様にご利用いただけます。