



# NINJAGO

Masters of Spinjitzu

9447



**WARNING:** CHOKING HAZARD.  
Toy contains small parts and a small ball.  
Not for children under 3 years.

1

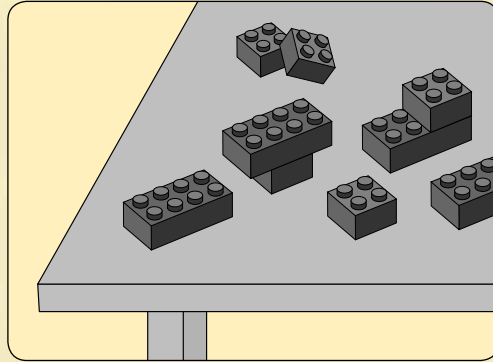
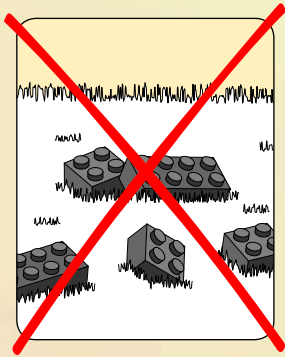

2

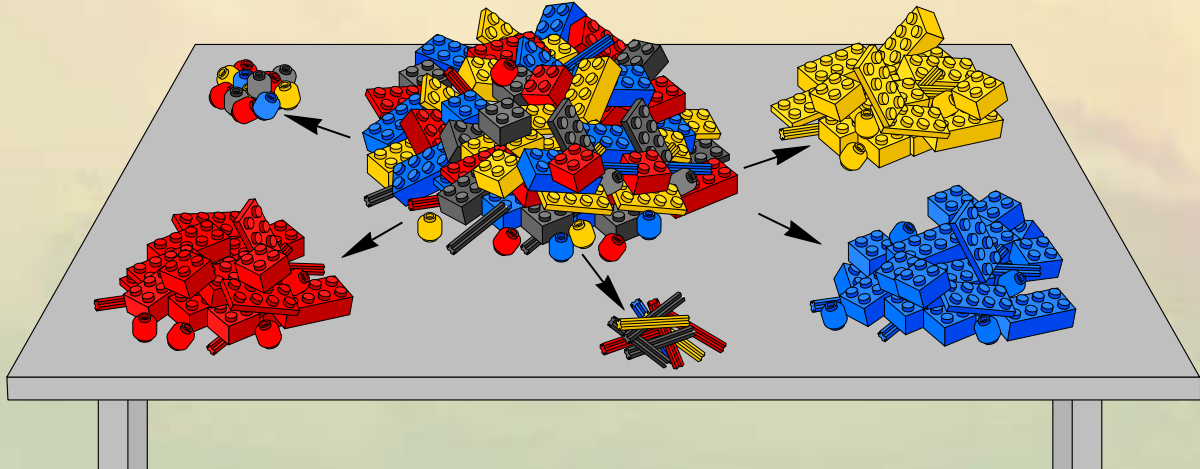



**AVERTISSEMENT : RISQUE D'ÉTOUFFEMENT.**

Le jouet contient des petites pièces ainsi qu'une petite boule.  
Il ne convient pas aux enfants de moins de 3 ans.



**ADVERTENCIA: PELIGRO DE ASFIXIA.**

Juguete que contiene partes pequeñas y una pelota pequeña.  
No recomendado para niños menores de 3 años.

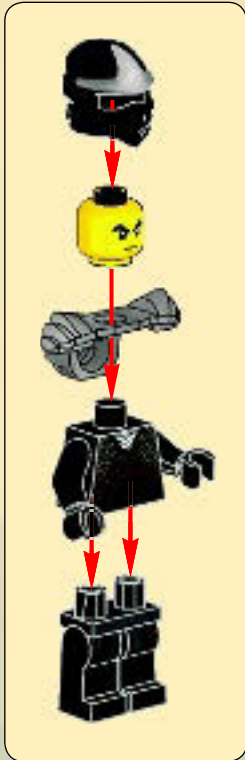

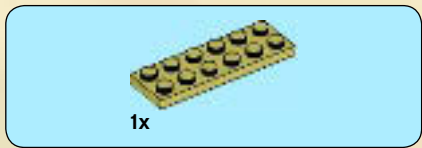

1

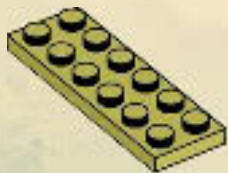

2

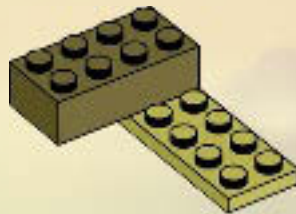

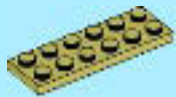

1x

3

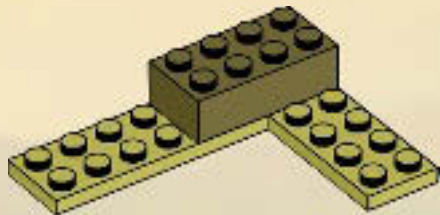

1x



2x

4

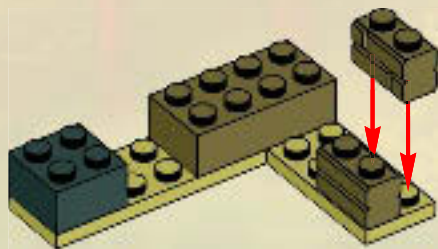

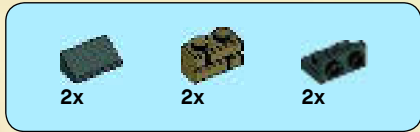

5

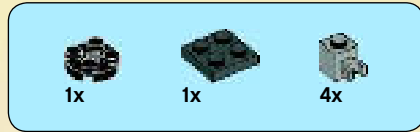
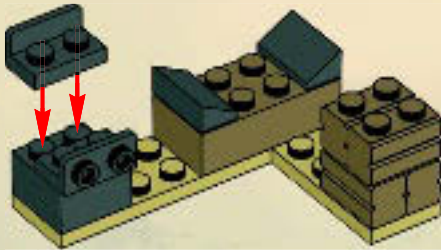

6

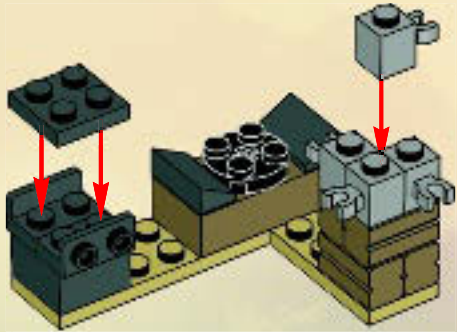



2x



1x



2x

# 7

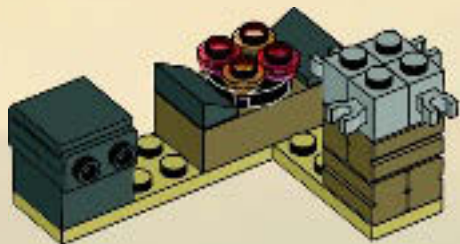

2x



2x

# 8

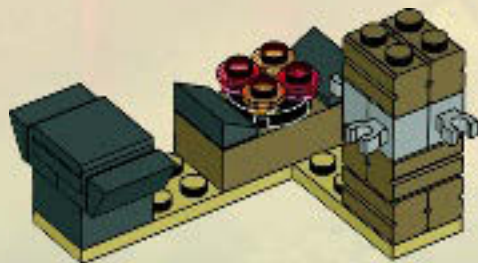





9



8





10

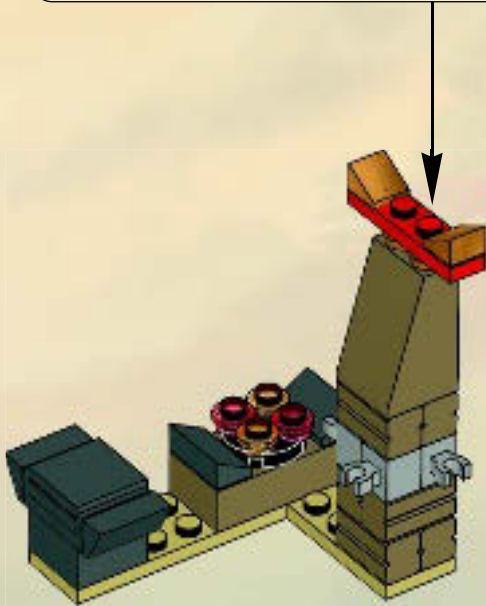
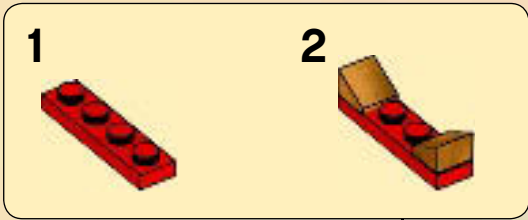

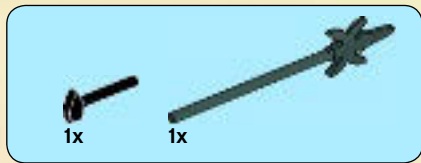

11

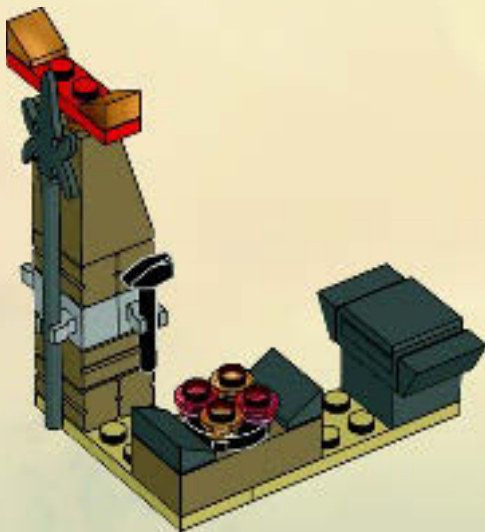
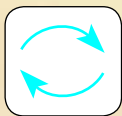

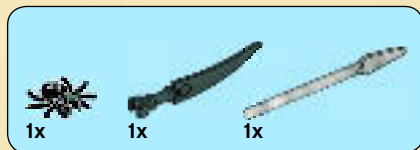

12

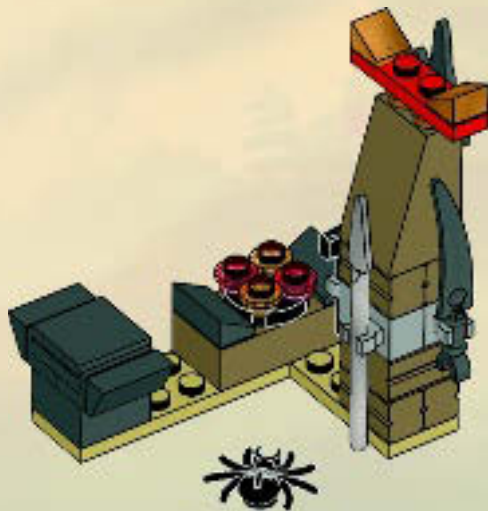
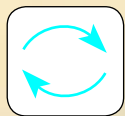



1

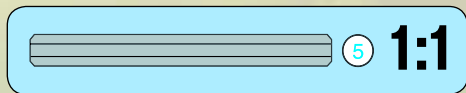
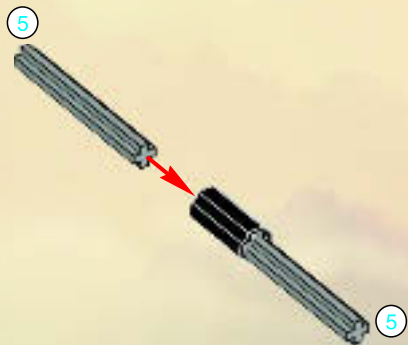



2x

2

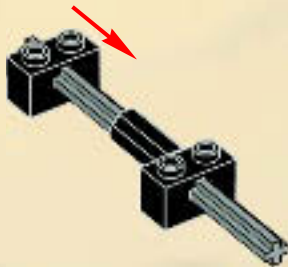

1x

3

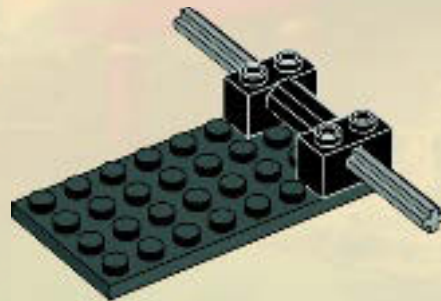



2x

4

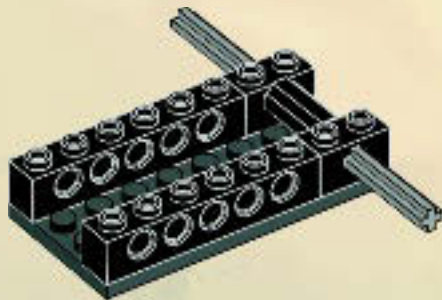

4x

5

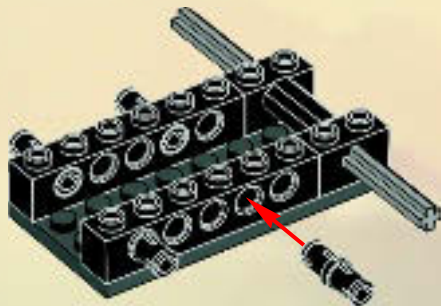



1x

6

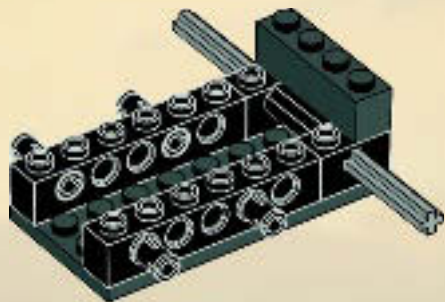

1x



1x

7

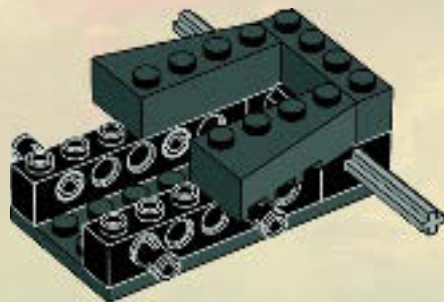





4x

8



4x

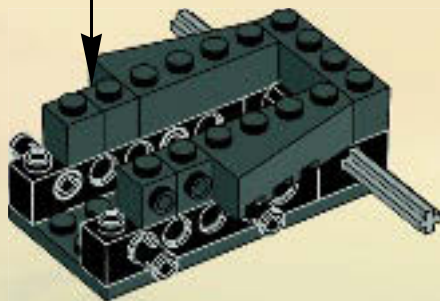



4x

9

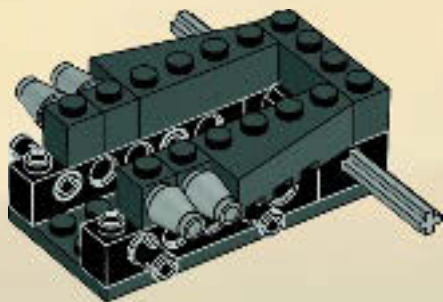

1x



2x

10

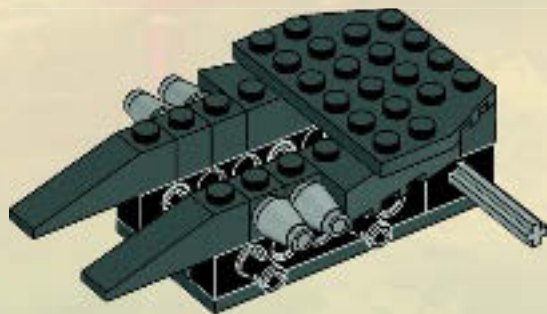



11

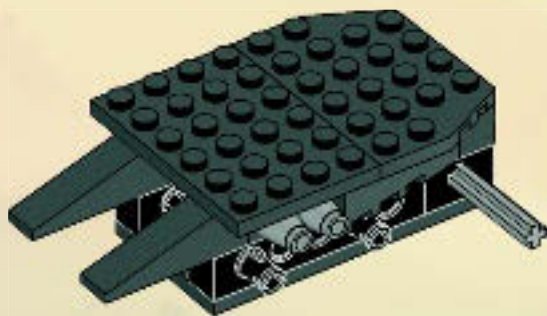



1x



2x

# 12

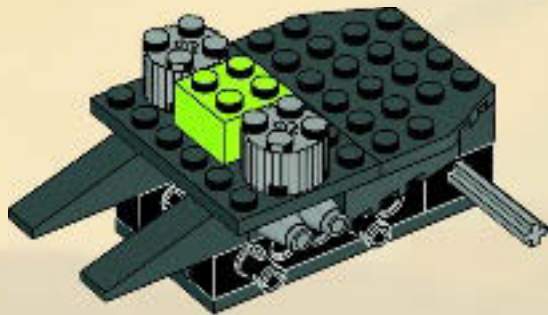

2x

# 13

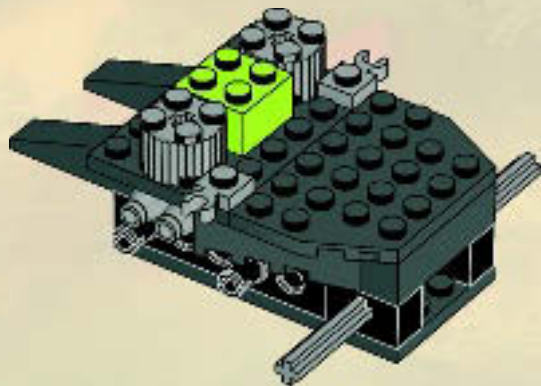



1x

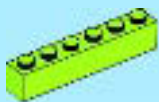

1x

# 14

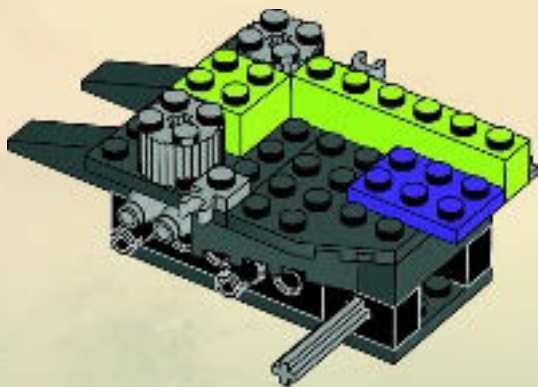



1x



1x

# 15

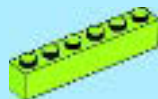
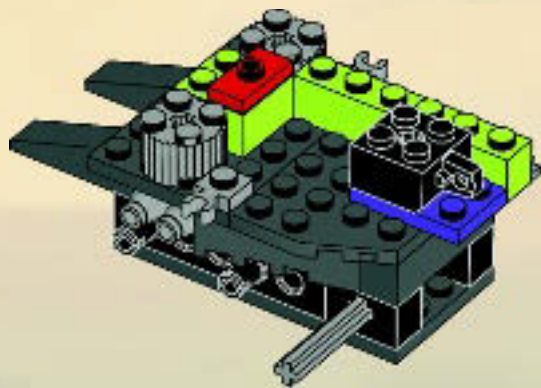

1x

# 16

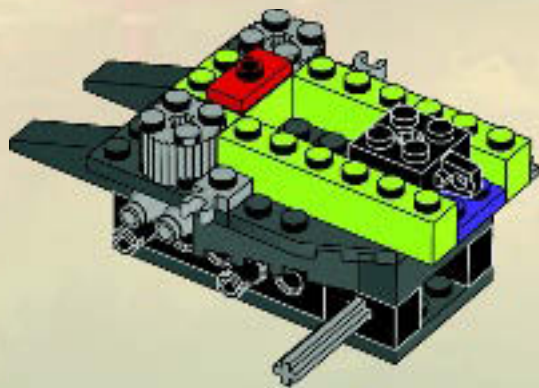



17

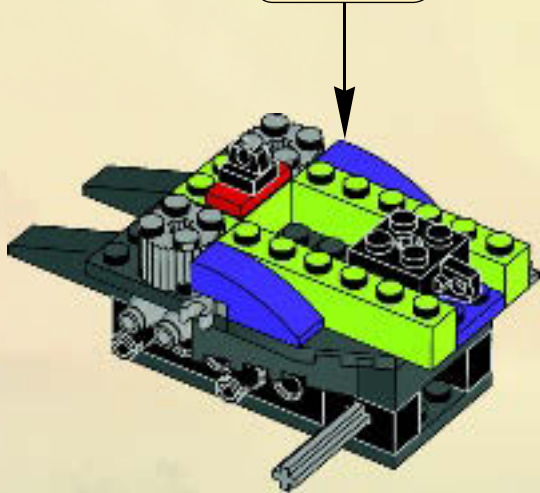





18

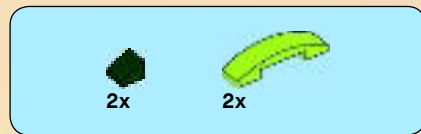
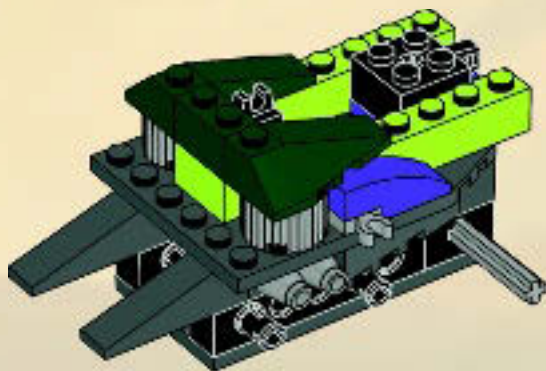

19

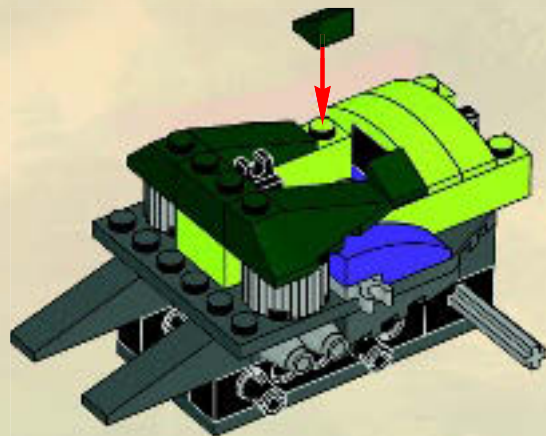



2x



2x

# 20

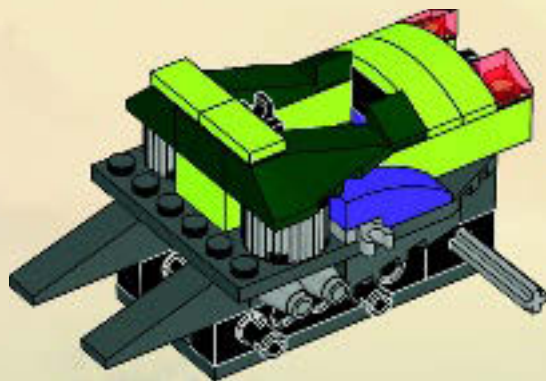



1x



1x

# 21

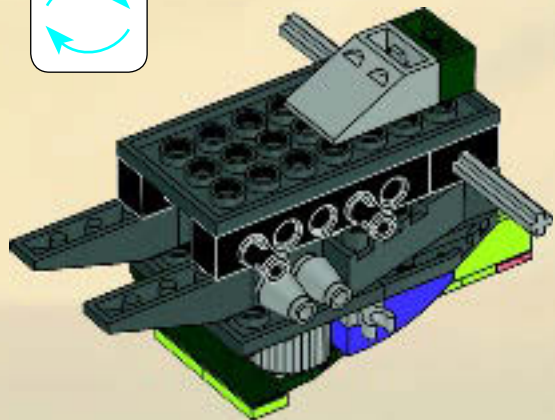
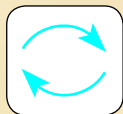

1x

# 22

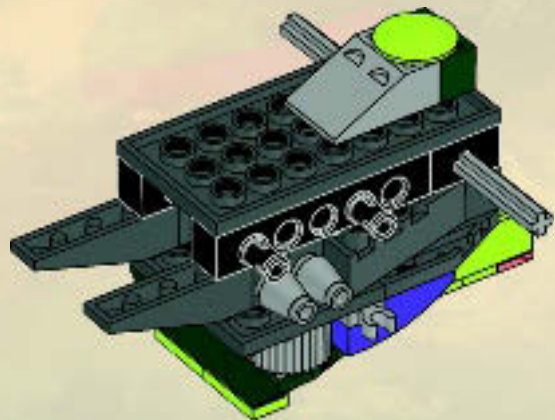



1

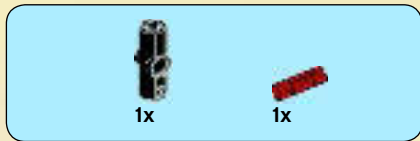
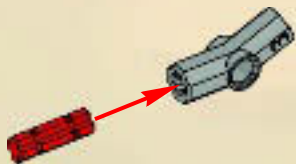

2

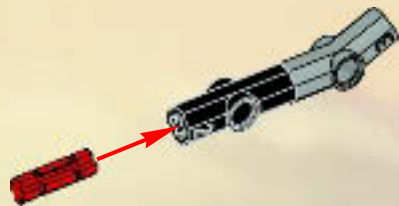



1x



1x

3

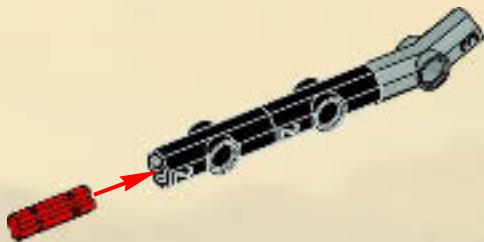

1x



1x

3

4

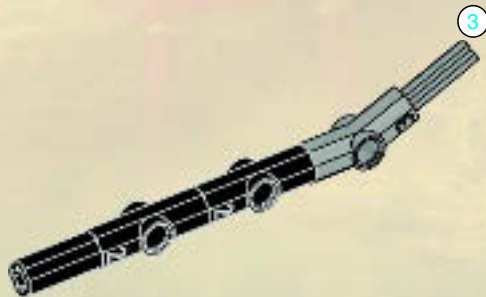

3

1:1



1x



1x

5

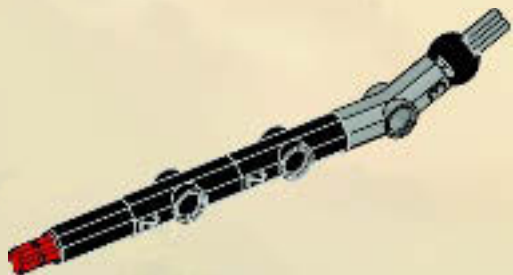

2x

6

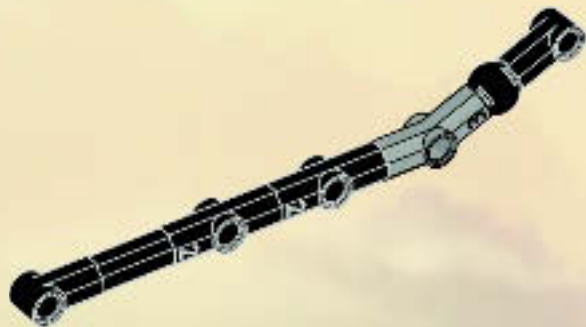

23

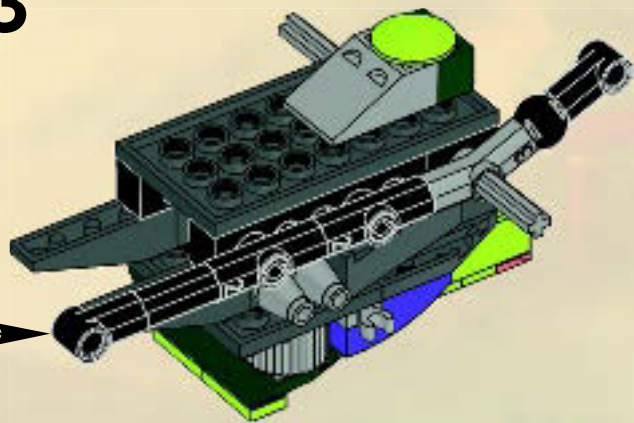



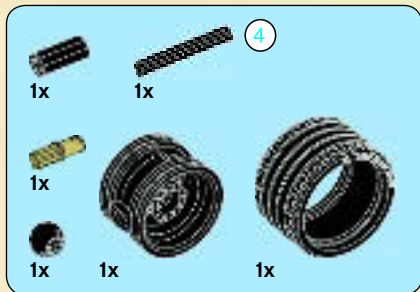

24

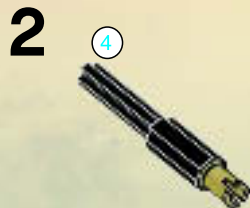

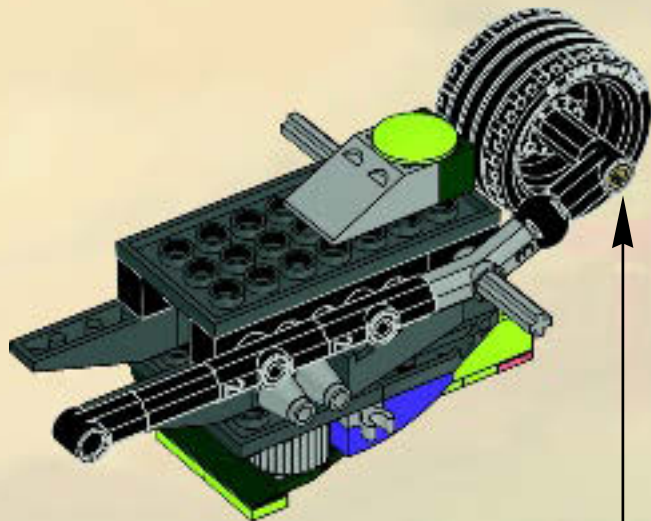

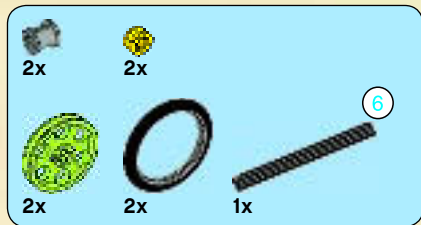

# 25



32

# 2



# 3

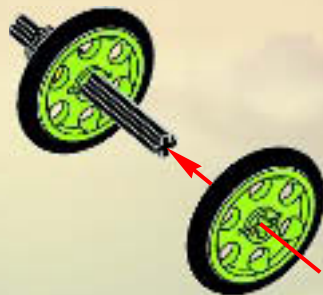

4



5

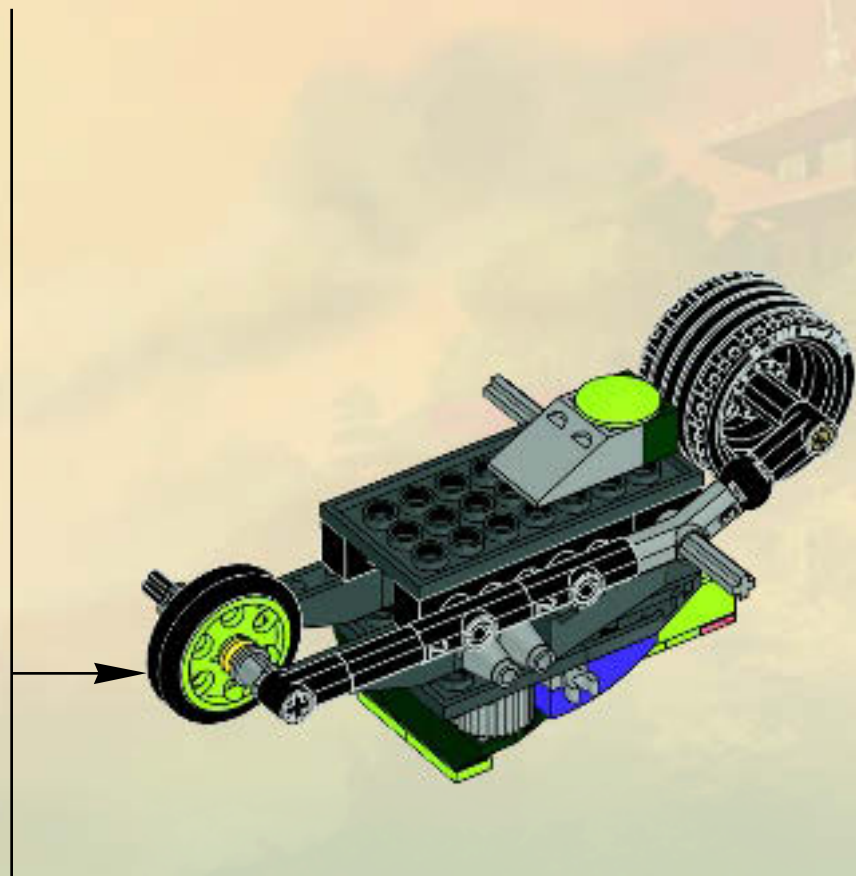
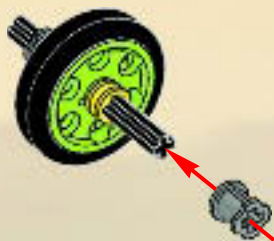



1

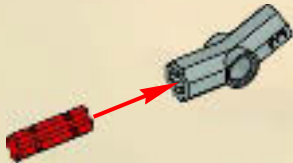

2





**NINJAGO**  
Masters of Spinjitzu







9573



9555



9447



9555



9447



9450



9591



9557



9447

9449  
9450

9556



9450



9447



9569

9449  
94509447  
9570  
9572

9556



9591



9591



9450



9450



9591

9449 9574  
9590 9591

9590

9450  
9591

9449



9591



9450



- 9555
- 9571
- 9450
- 9574
- 9573
- 9554
- 9591
- 9570
- 9449  
 9450
- 9573
- 9447  
 9556  
 9569
- 9554
- 9449



- 9590
- 9591
- 9572
- 9447
- 9447
- 9450 9554  
 9570 9572  
 9574
- 9557
- 9571
- 9449
- 9448  
 9449  
 9557
- 9591
- 9449  
 9550
- 9450





# NINJAGO

Masters of Spinjitzu



LLOYD ZX  
9574 • 9450



NRG ZANE  
9590



NRG KAI  
9591



NRG JAY  
9570



NRG COLE  
9572



CHOKUN  
9591 • 9450



MEZMO  
9566



FANGDAM  
9571



SPITTA  
9569 • 9448



PYTHOR  
9449



SLITHRAA  
9573



LIZURA  
9567



BYTAR  
9566 • 9448



1x



1x

3

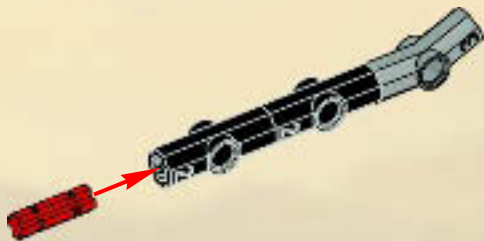

1x



1x

3

4

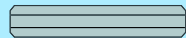
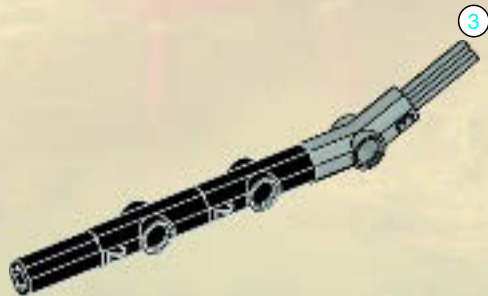

3

1:1



1x



1x

5

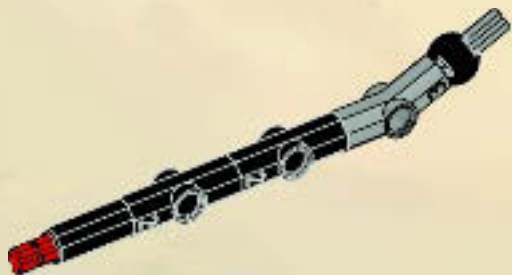

2x

6

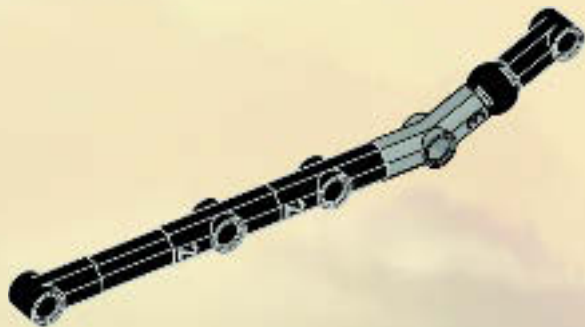

26

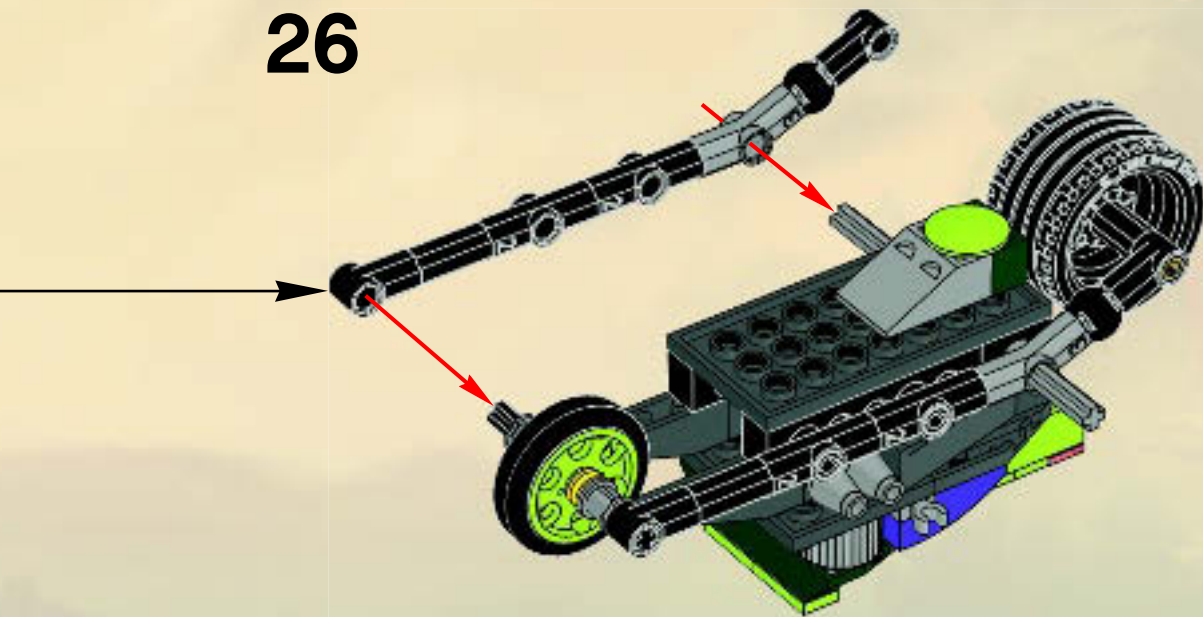

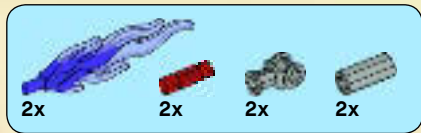

27

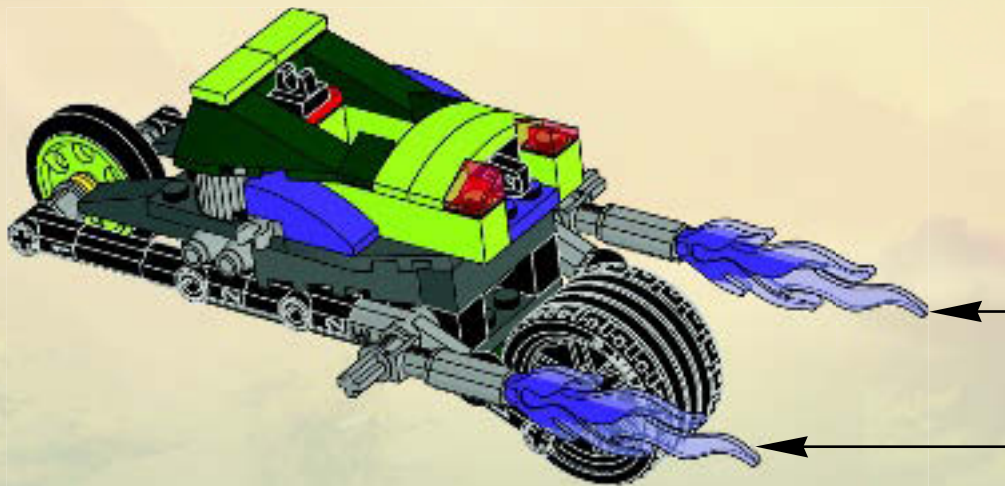
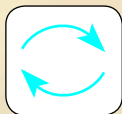
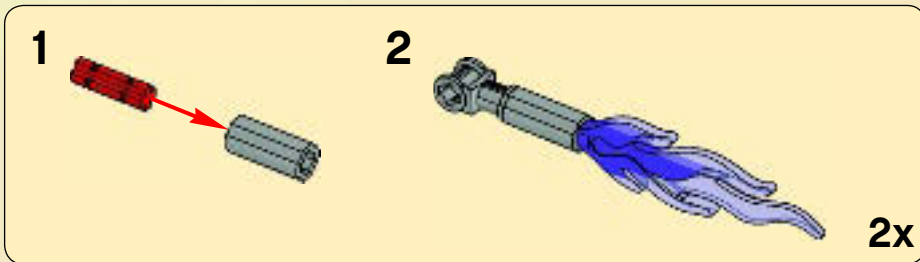





2x

28

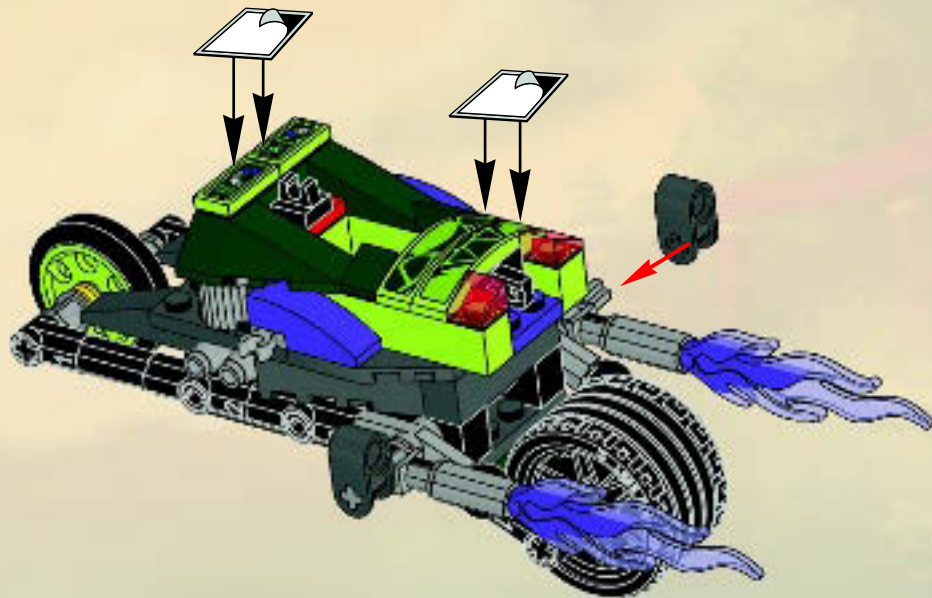



29

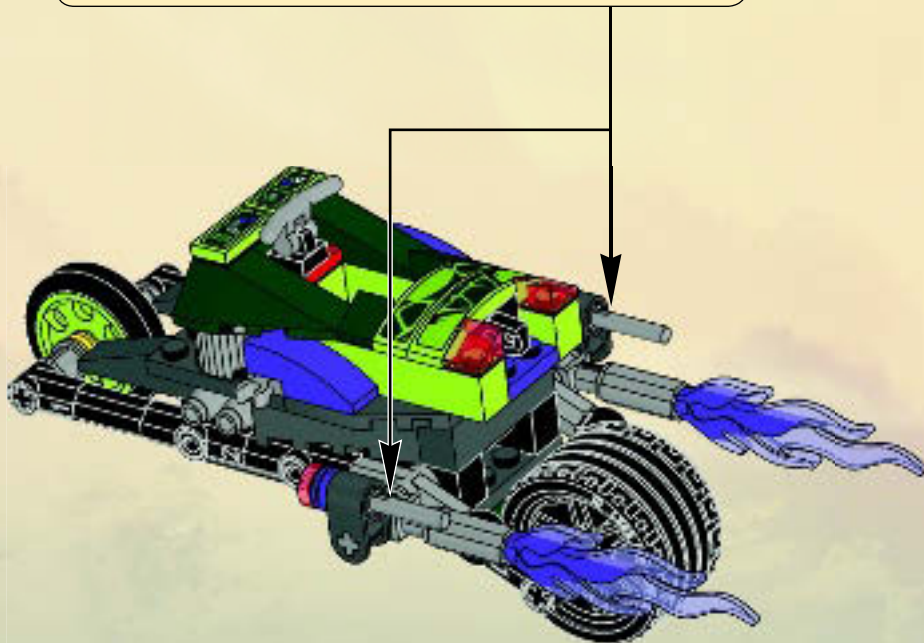
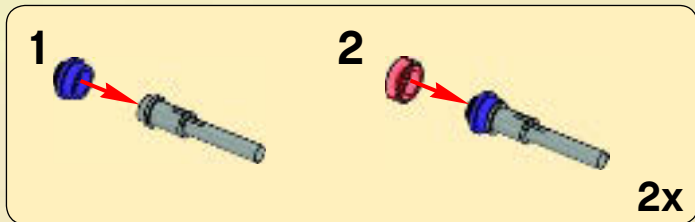

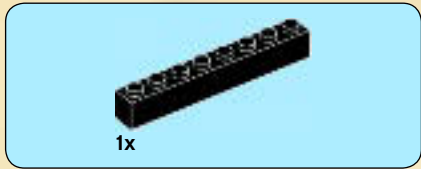

1



2





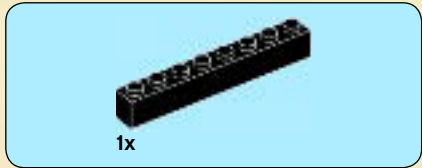

3



4

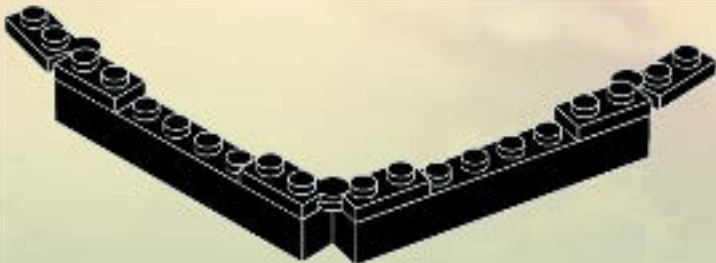



4x



5



1x



2x



6



7



8





2x



2x

9



2x

10



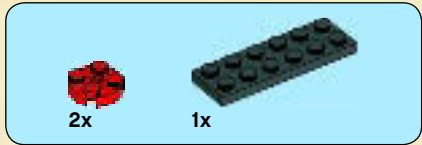

11

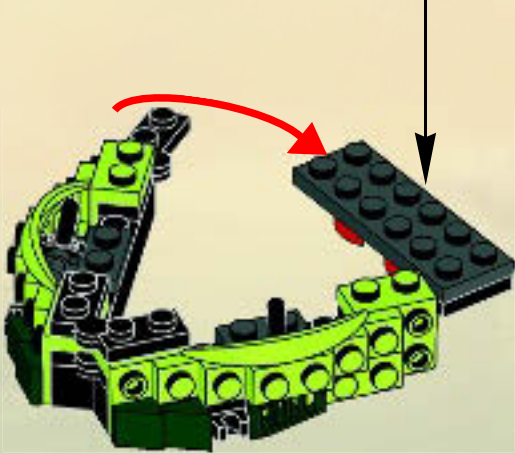
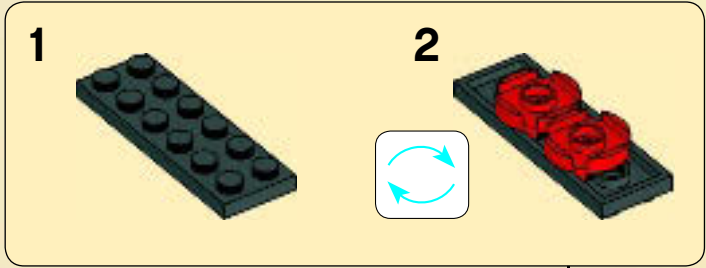



2x



2x

# 12



3x

# 13

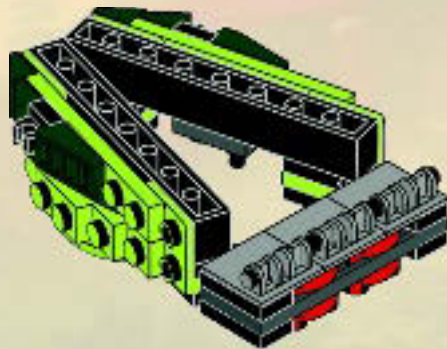
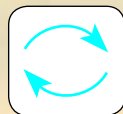



3x

14

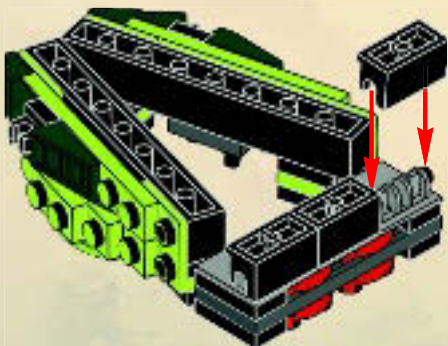

4x

15

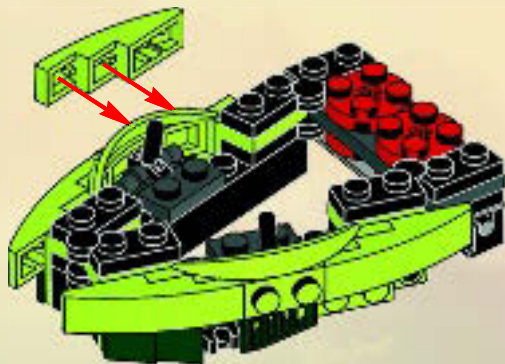
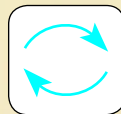



2x



2x

# 16

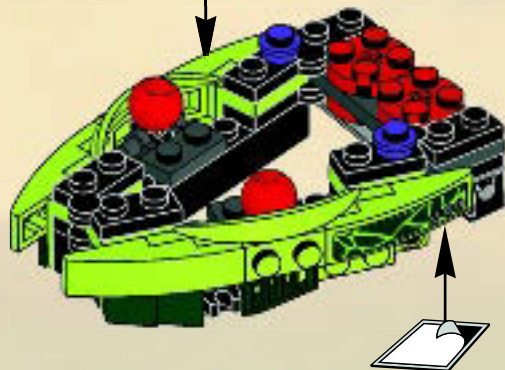

2x



1x

# 17

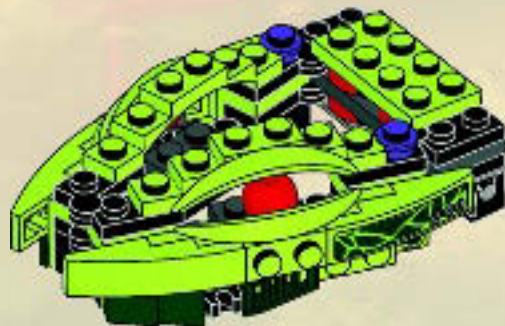





2x



1x

18

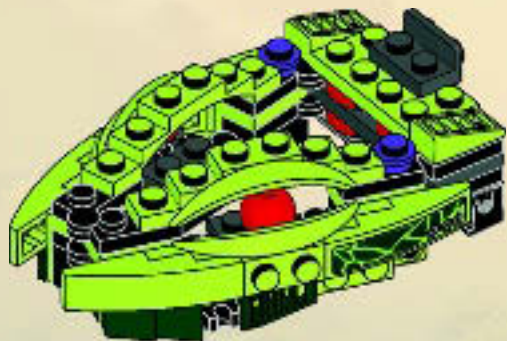

2x

19

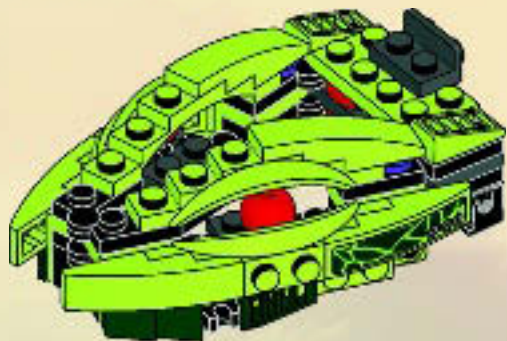

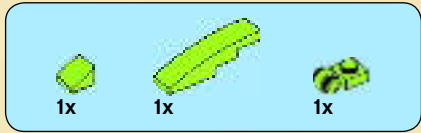

20

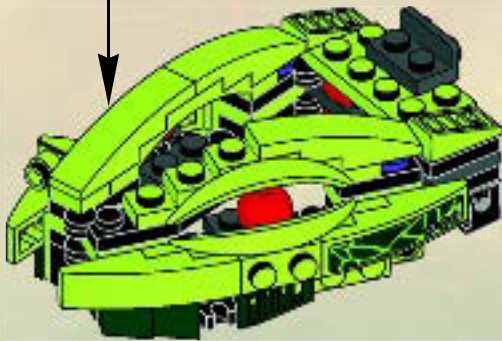
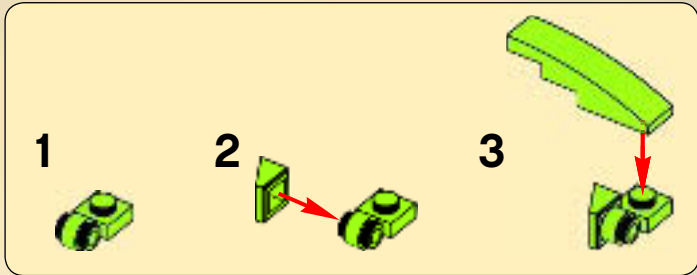

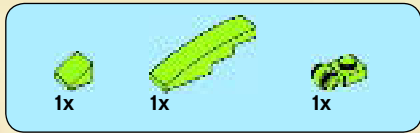

21

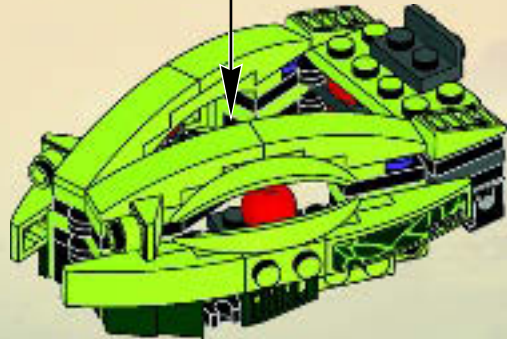
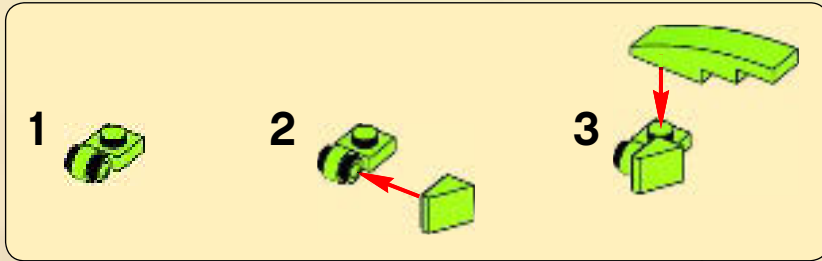



2x

# 22

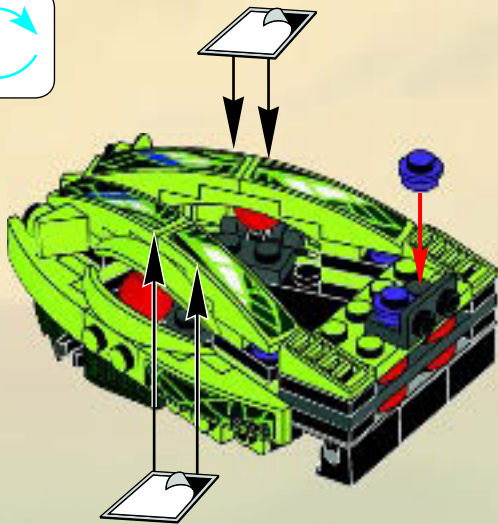
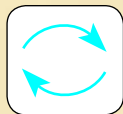

2x



1x



1x

# 23

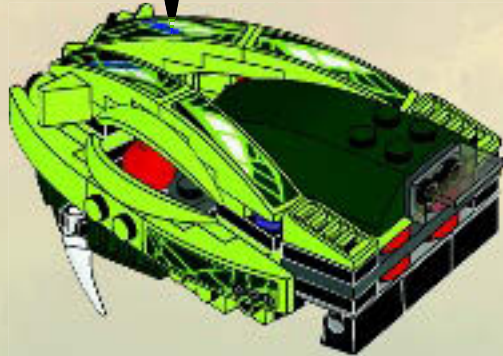

30

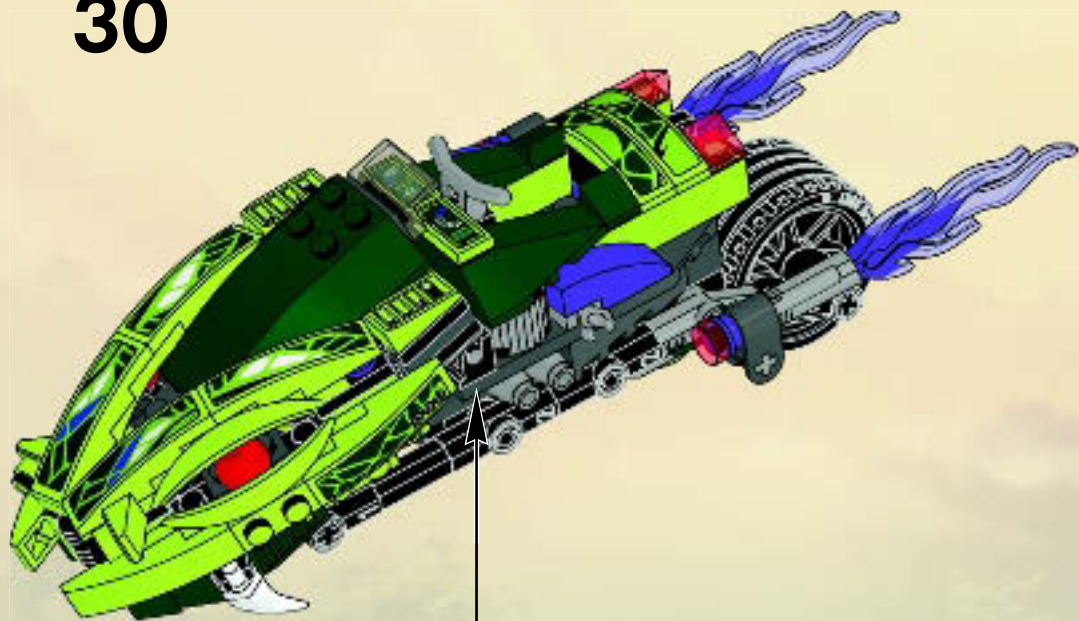

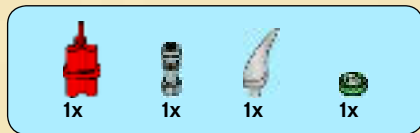

31

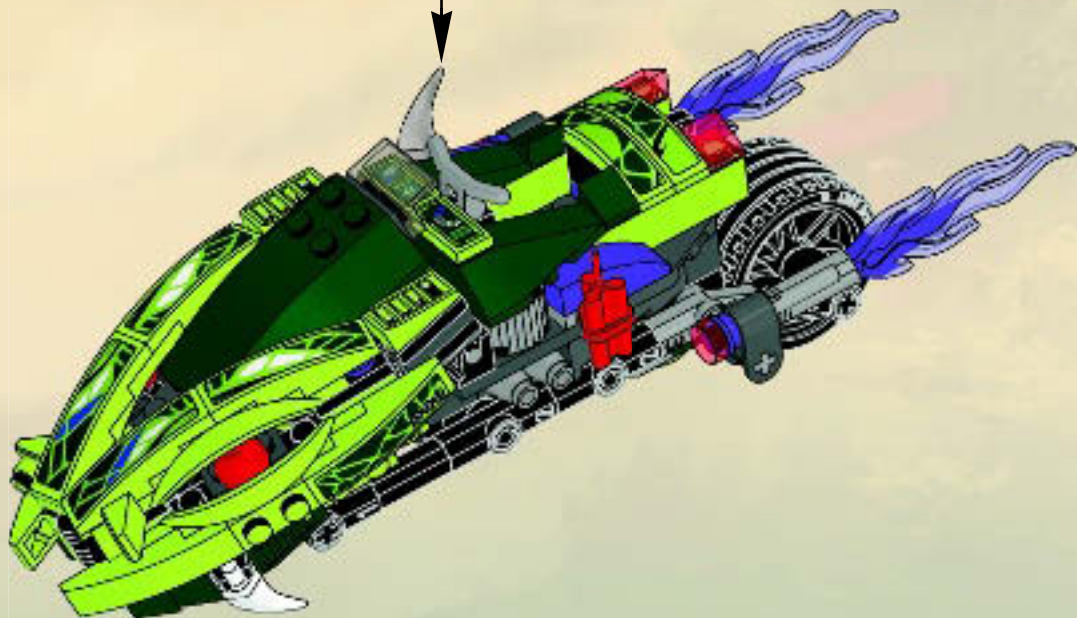



1x

1



1x

1x

2



60



1x

3

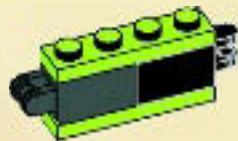

1x

1x

4

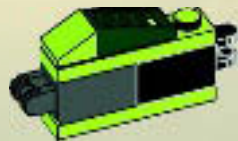



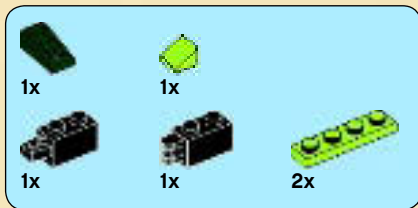

5





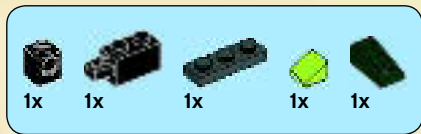

6

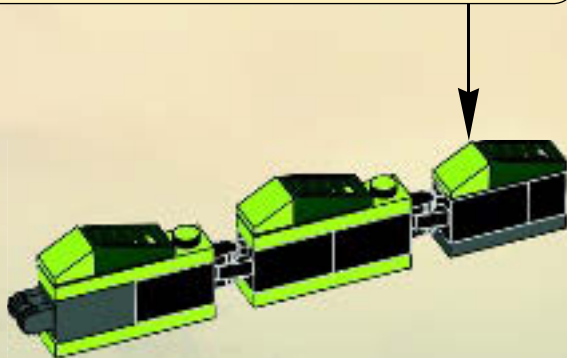
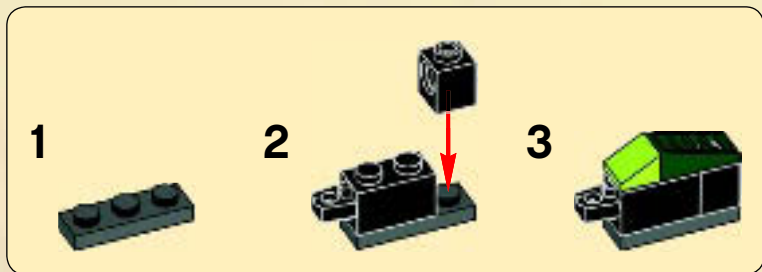



7

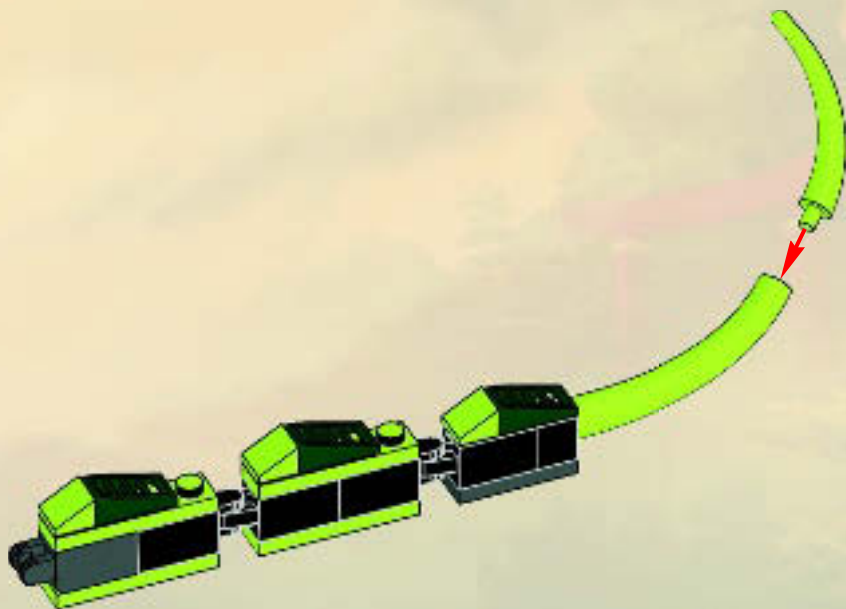

32

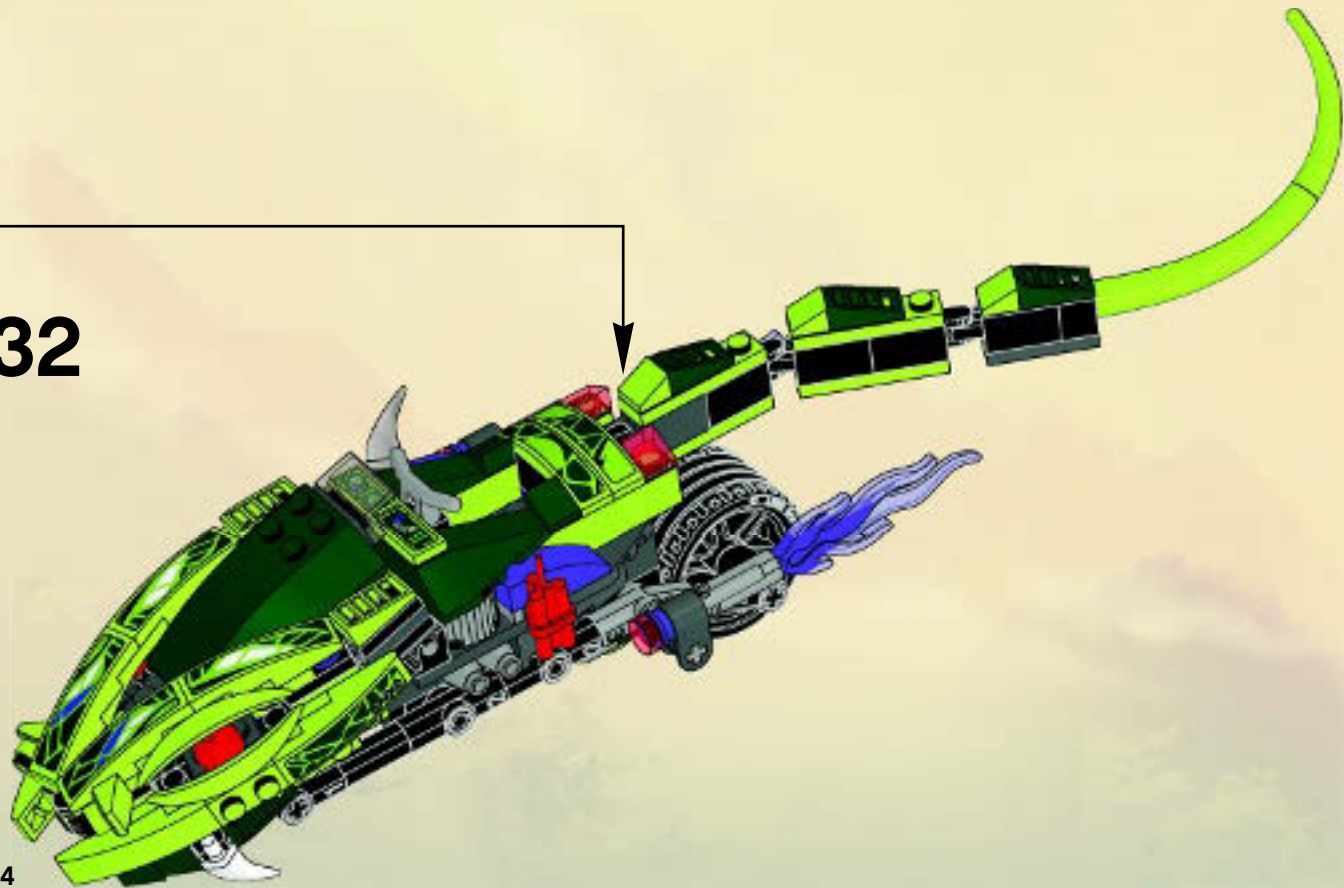

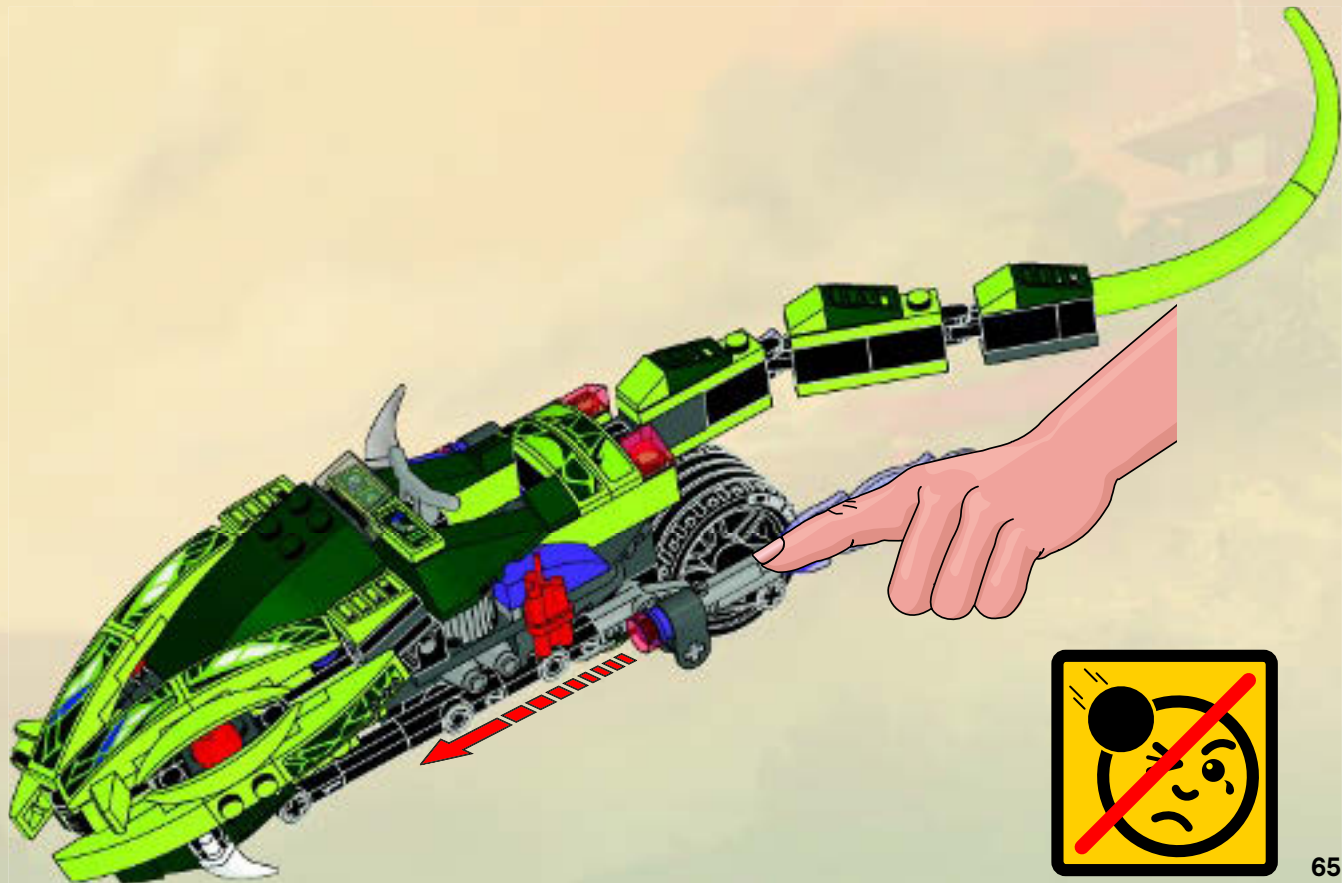



2x  
4566256



2x  
4113993



1x  
4666579



1x  
371021



1x  
379421



4x  
403221



1x  
4538780



2x  
4290714



10x  
4142865



1x  
4611426



1x  
4611426

66



2x  
4239601



2x  
300826



2x  
4233487



2x  
4144533



2x  
4143751



1x  
4163904



1x  
654126



2x  
389426



3x  
255526



6x  
74011



1x  
403226



1x  
4650495



1x  
4650131



1x  
452226



1x  
4114206



1x  
4650120



1x  
4113209



1x  
4299389



1x  
4299389



1x  
4499234



2x  
4289538



3x  
393726



3x  
4286267



2x  
281526



4x  
4107783



4x  
4107085



4x  
4121715



4x  
4512363



4x  
4512363

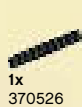

1x  
370526

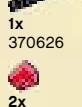

1x  
370626



2x  
4244363



2x  
4646864



2x  
3005741



1x  
4653403



1x  
4200798



1x  
4220632



2x  
4537919



5x  
4504372

4

6



8x  
4537927



2x  
4617069



4x  
4187743



1x  
4537936



2x  
4529160



2x  
4632576



2x  
4500125



4x  
4569452



1x  
4650250



1x  
4647765



1x  
4647900



1x  
4651603



1x  
4646805



1x  
4650635



1x  
4650634



1x  
4650634



4x  
4610474



2x  
4494219



2x  
4540385



1x  
4247145



6x  
4646577



1x  
6000852



2x  
4245570



6x  
4504375



1x  
4500060



1x  
4500059



1x  
4652932



5x  
4651834



2x  
4222960



4x  
4533772



4x  
4529241



2x  
4650645



1x  
4211570



2x  
4594238



1x  
4539481



1x  
4258308



3x  
4211881



2x  
4520320



2x  
4211622



2x  
4211552



2x  
4211553



2x  
4512360



3



2x  
4211815

5



2x  
4211639



1x  
4211060



1x  
4211103



4x  
4558955



1x  
4210724



1x  
4287972



1x  
4287973



1x  
4287973



4x  
4567887



2x  
4535930



1x  
4211055



3x  
6000606



2x  
4210660



1x  
4211094



1x  
4211133



1x  
4211002



1x  
4211115



1x  
4211115



1x  
4211061



1x  
4211061



1x  
4521572



2x  
4210851



1x  
4509194

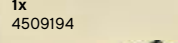

1x  
4210886



6x  
4566522



2x  
4578772



1x  
4225142



2x  
4587002



2x  
4523159



1x  
4614404



1x  
4611883



1x  
4646815



1x  
4617190



2x  
4651591



2x  
4651591

**Customer Service**

**Kundenservice**

**Service Consommateurs**

**Servicio Al Consumidor**

**www.lego.com/service or dial**



**: 00800 5346 5555**

**: 1-800-422-5346**





# NINJAGO

Masters of Spinjitzu



9449



9448



9450

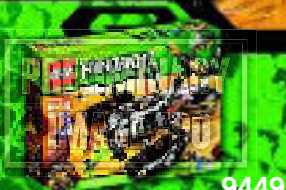

9449



9448

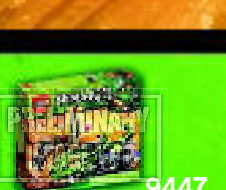

9447



9447





# NINJAGO

Masters of Spinjitzu



**CUSTOMISE YOUR SPINNERS  
PERSONNALISE TES TOUPIES  
PERSONALIZA TUS SPINNERS**



9591

9554



9555



9556

COMING SOON  
PROCHAINEMENT  
PRÓXIMAMENTE

?

9557

COMING SOON  
PROCHAINEMENT  
PRÓXIMAMENTE

?

SPIITTA



9569

NAG'JAY



9570

FANGDAM



9571

NAG COLE



9572

COMING SOON  
PROCHAINEMENT  
PRÓXIMAMENTE

?

9573

COMING SOON  
PROCHAINEMENT  
PRÓXIMAMENTE

?

9574

COMING SOON  
PROCHAINEMENT  
PRÓXIMAMENTE

?

9590

NAG KAI VS CHOKUN



NINJAGO.COM

**LEGO** **NINJAGO**  
Masters of Spinjitzu



**NINJAGO.COM**





[www.LEGOclub.com](http://www.LEGOclub.com)



LEGO® Club Email



LEGO® Club Magazine

**LEGO club**

**FREE! GRATIS! GRATUIT!**

**SIGN UP ONLINE!**

**[www.LEGOclub.com](http://www.LEGOclub.com)**



**00800 5346 5555\***



**1-866-534-6258 • 1-877-518-5346**

RG © Canada only

Canada seulement

- \* Freephone. Mobile charges may apply.
- \* Numéro sans frais. Des frais peuvent s'appliquer avec les téléphones cellulaires.
- \* Gebührenfrei. Kosten für Anrufe aus Mobilfunknetzen können abweichen.
- \* Gratis telefoonnummer vanaf vaste lijn.
- \* Det er et gratis nummer, når du ringer fra fasttelefon.
- \* Det är gratis, när du ringer från en fast telefon.
- \* Numéro sans frais. Des frais peuvent s'appliquer avec les téléphones portables.



# WIN!

Go to [www.LEGOsurvey.com/product](http://www.LEGOsurvey.com/product) to fill out a survey for a chance to win a cool LEGO® Product.

No purchase necessary.

Open to all residents where not prohibited.



## [www.LEGOsurvey.com/product](http://www.LEGOsurvey.com/product)

### GEWINNE!

Nimm an der Umfrage auf [www.LEGOsurvey.com/product](http://www.LEGOsurvey.com/product) teil und hab die Chance ein cooles LEGO® Produkt zu gewinnen!

Die Teilnahme am Gewinnspiel führt zu keinerlei Kaufverpflichtungen. Teilnahme in allen nicht ausgeschlossenen Ländern möglich.

### WIN!

Ga naar [www.LEGOsurvey.com/product](http://www.LEGOsurvey.com/product), vul een enquêteformulier in en maak kans op een cool LEGO® product.

Geen aankoopverplichting. Iedereen mag deelnemen, uitgezonderd ingezetenden van landen waar een enquêteverbod geldt.

### GAGNE!

Visite [www.LEGOsurvey.com/product](http://www.LEGOsurvey.com/product) pour répondre à un questionnaire et avoir une chance de gagner un produit LEGO® très cool!

Aucune obligation d'achat. Ouvert à tous les résidents des pays autorisés.

### 当てよう!

[www.LEGOsurvey.com/product](http://www.LEGOsurvey.com/product) にアクセスして、アンケートにご記入ください。当選者にはレゴ®製品を差し上げます。

お買い上げの必要はありません。禁止されていない限り、すべての皆様にご利用いただけます。



[www.LEGO.com](http://www.LEGO.com)

6014451

LEGO and the LEGO logo are trademarks of the/son des marques de commerce de/son marcas registradas de LEGO Group. ©2012 The LEGO Group.