



# NINJAGO

Master of Spinjitzu



9450



3

LLOYD ZX + SENSEI WU  
INCLUDED





**LLOYD ZX + SENSEI WU INCLUDED**  
**LLOYD ZX + SENSEI WU INCLUS**  
**INCLUYE A LLOYD ZX + SENSEI WU**

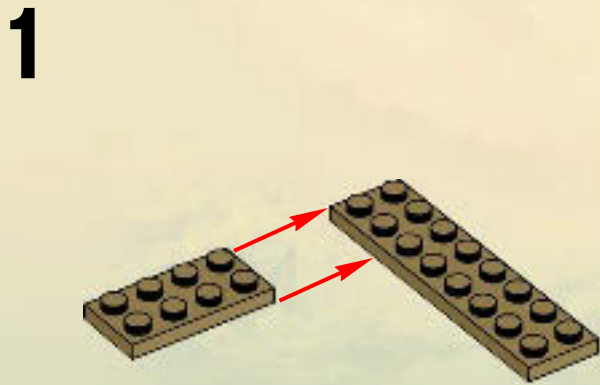
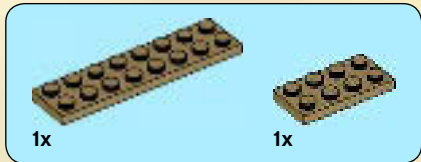

**2**

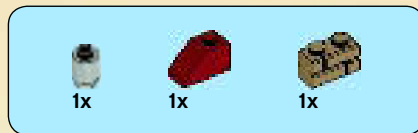
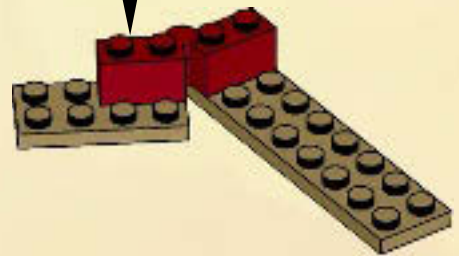
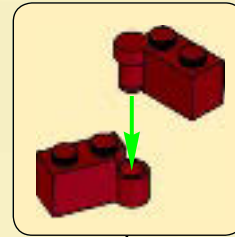

**3**

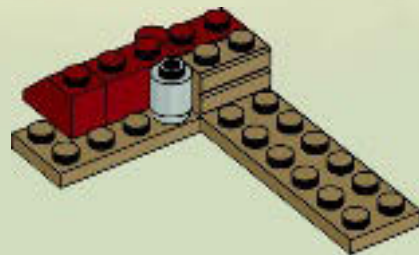

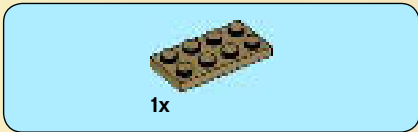

4

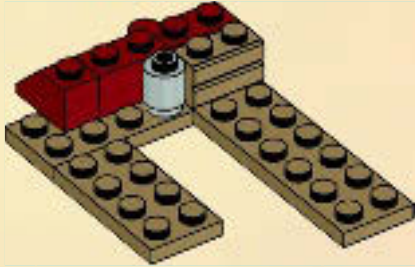

6

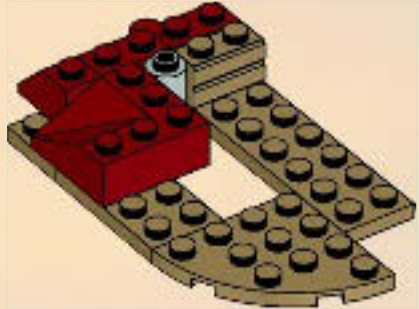

5

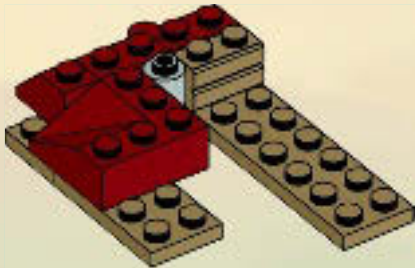

7





8

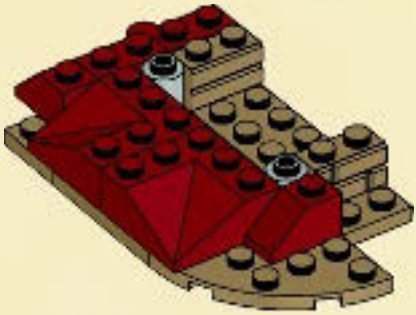

9

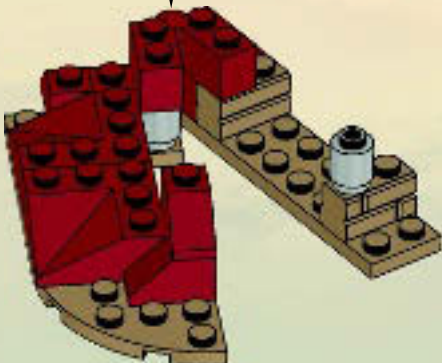
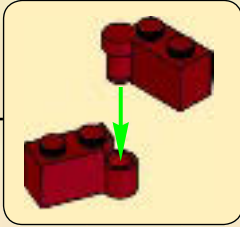

10

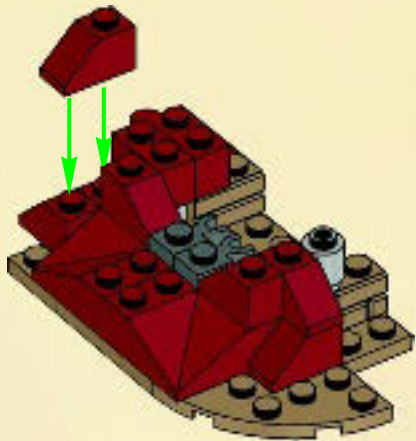

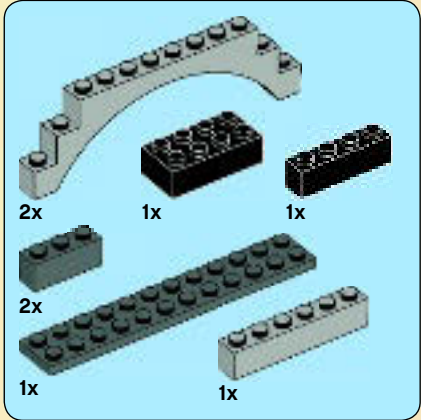

# 11

1

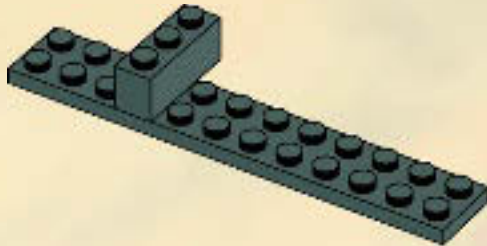

2

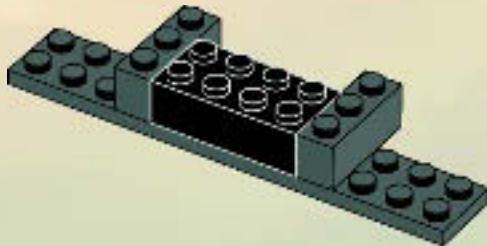

3

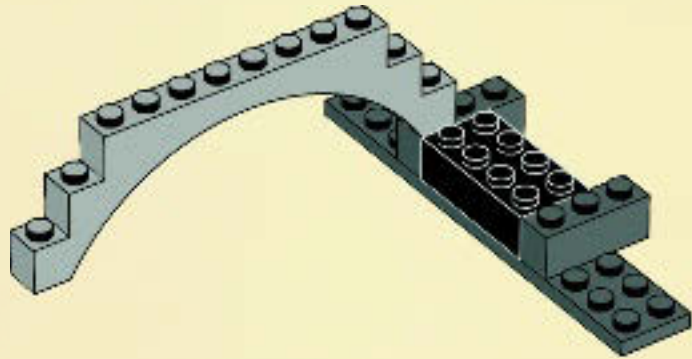

4

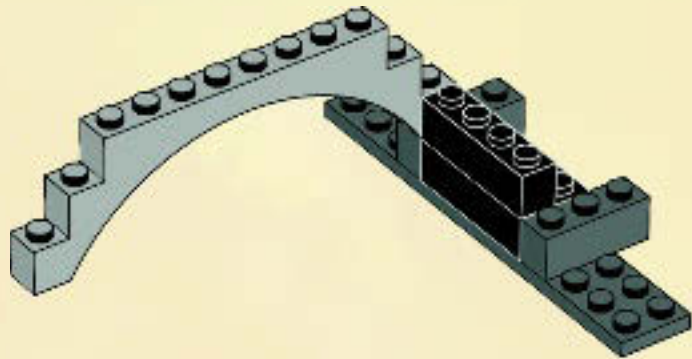

5

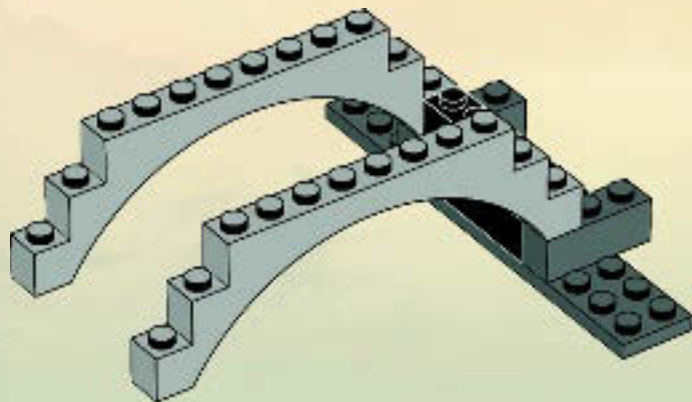

6

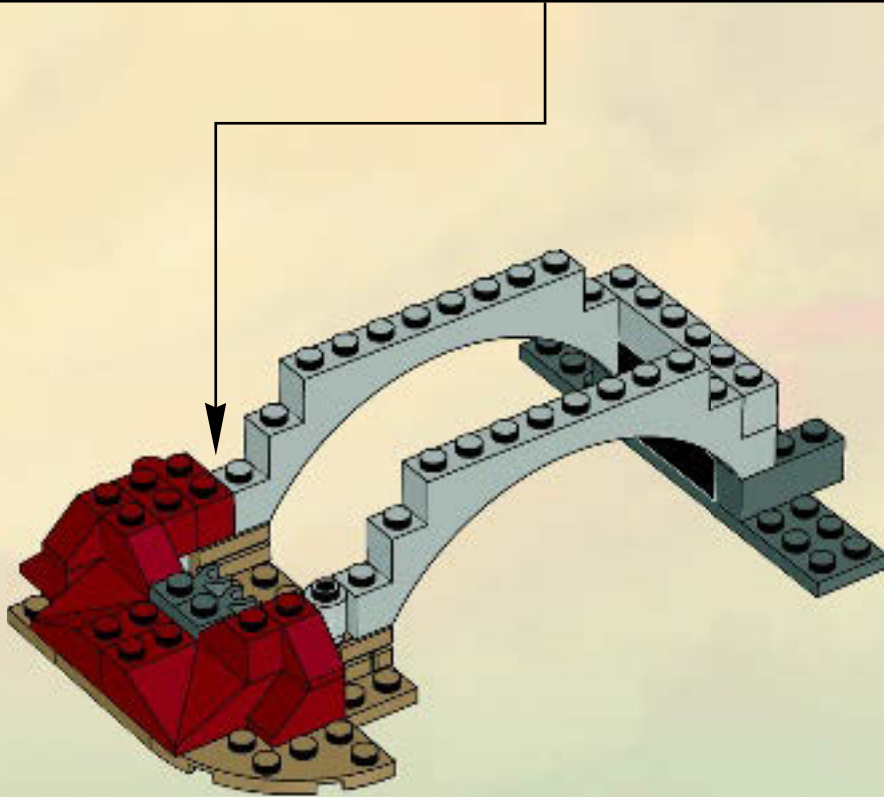
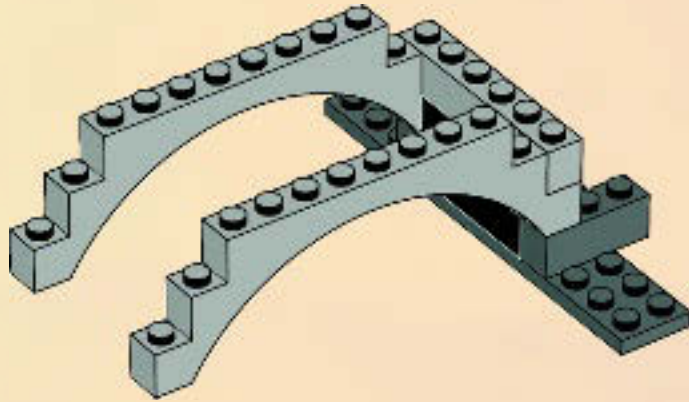



# 12

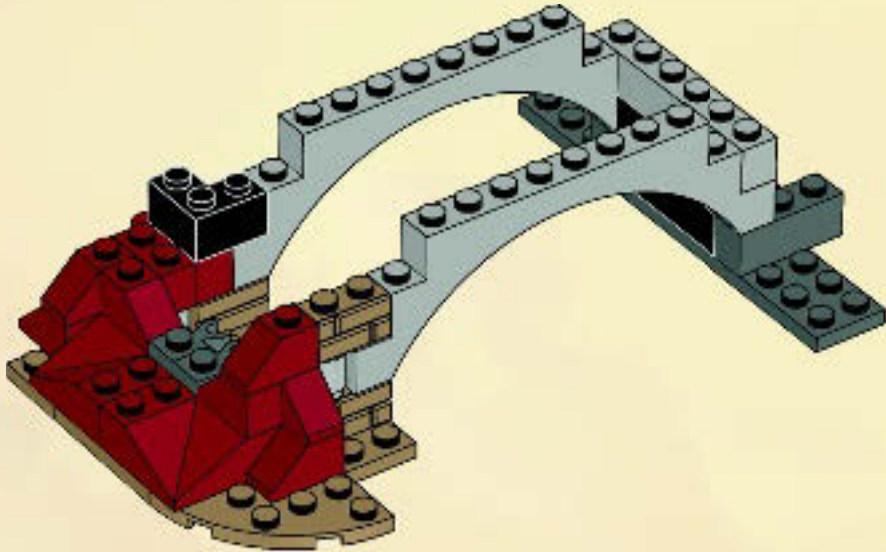





2x

# 13

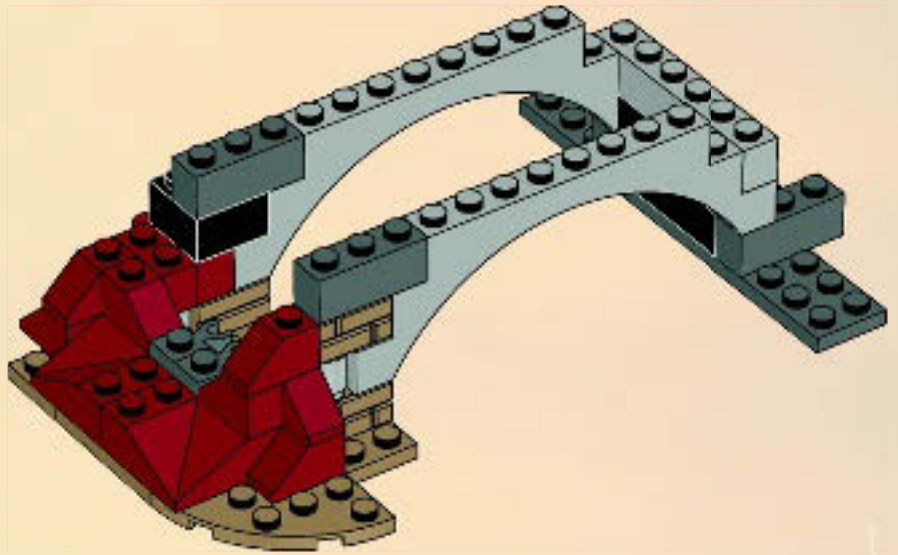

1x



1x

# 14

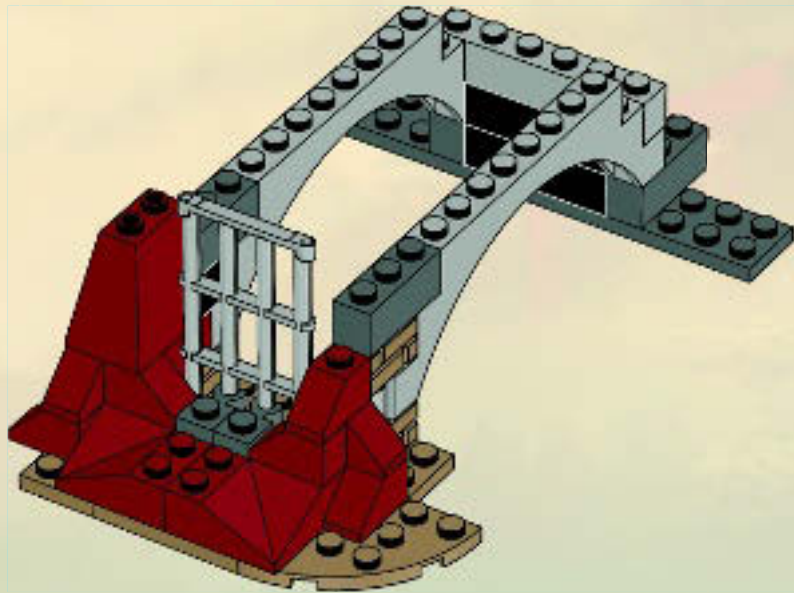



2x

# 15

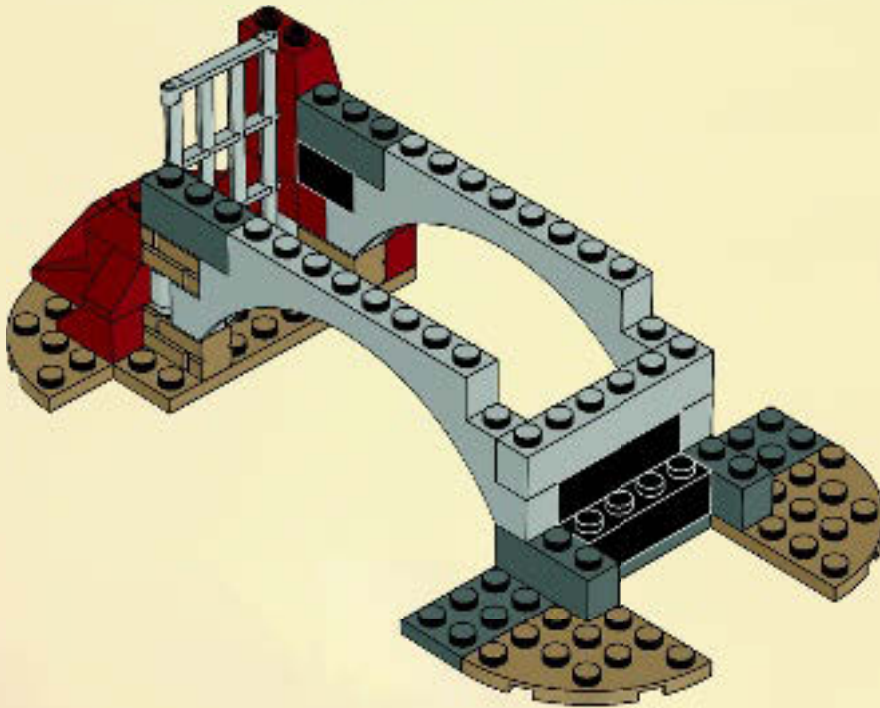

2x



2x

# 16

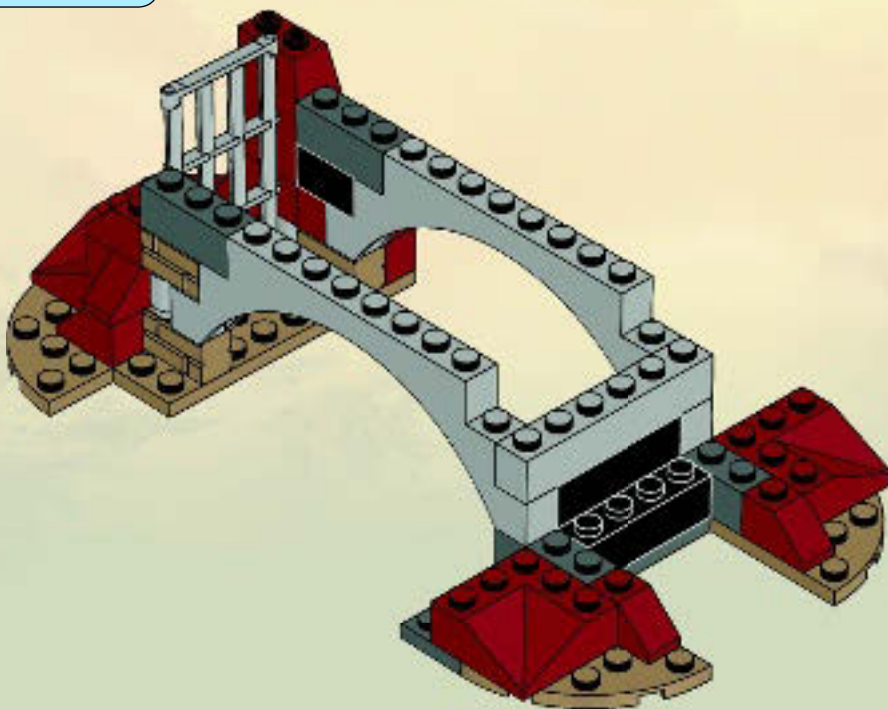



4x

# 17

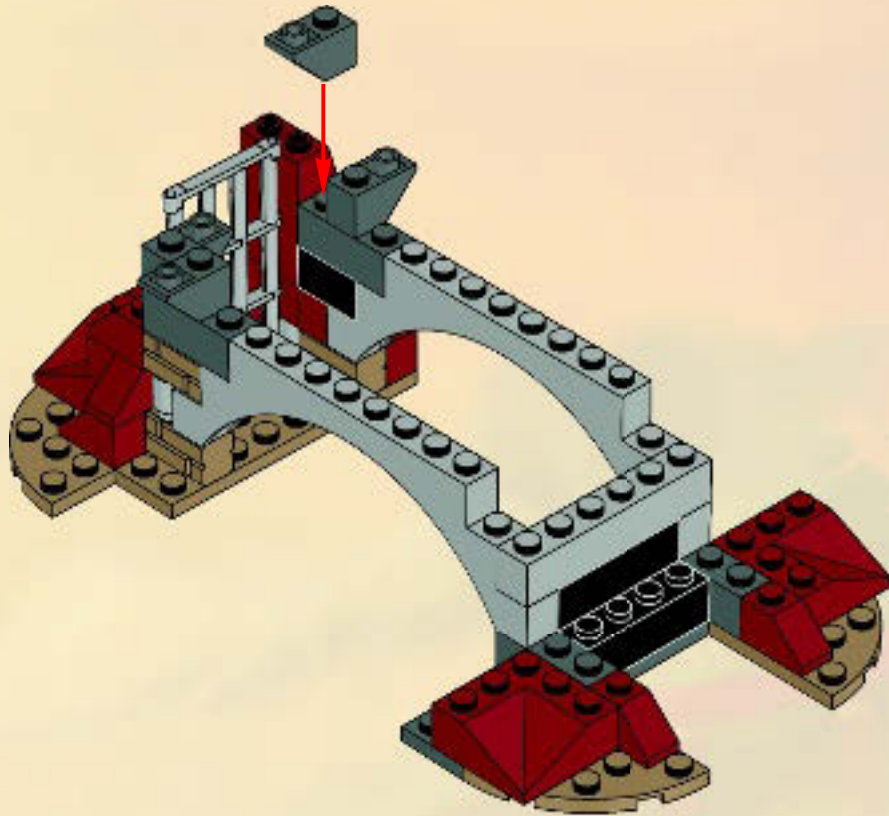

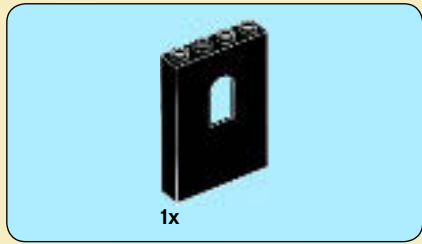

18

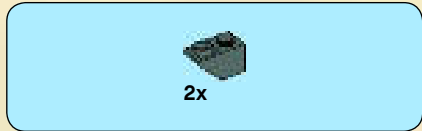
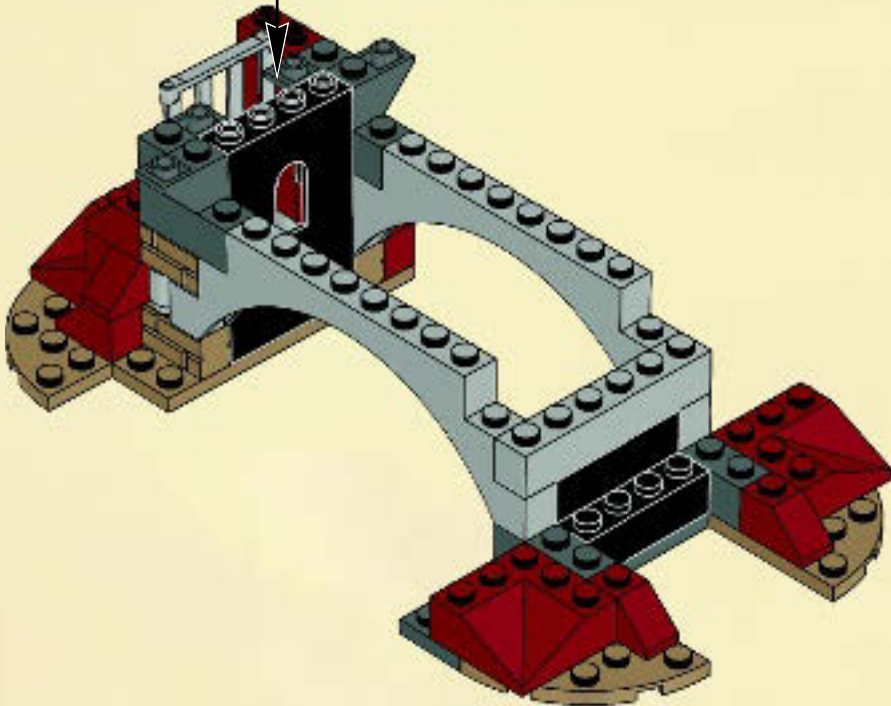

19

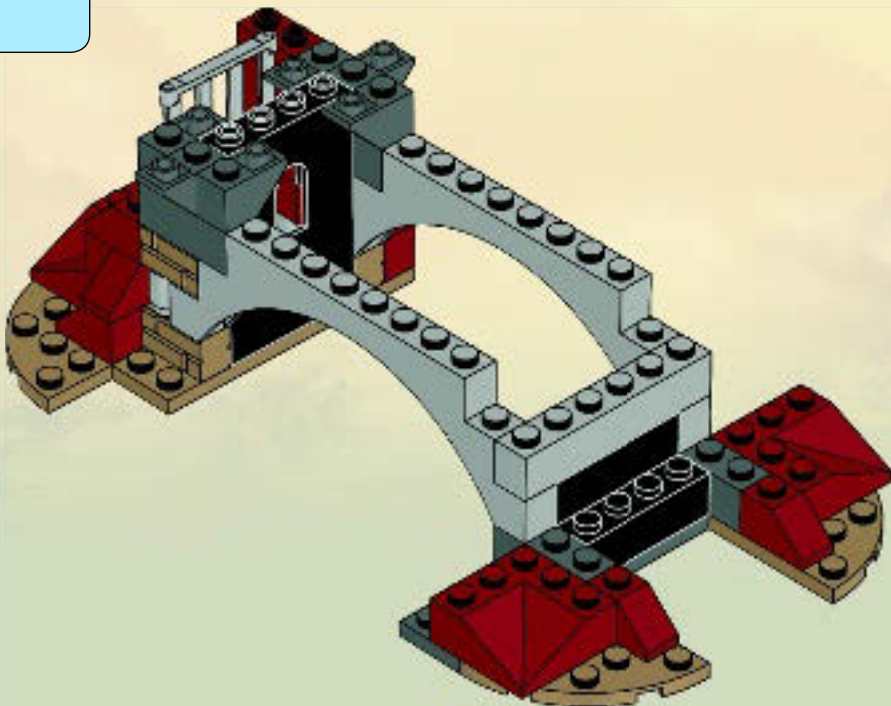



2x

# 20

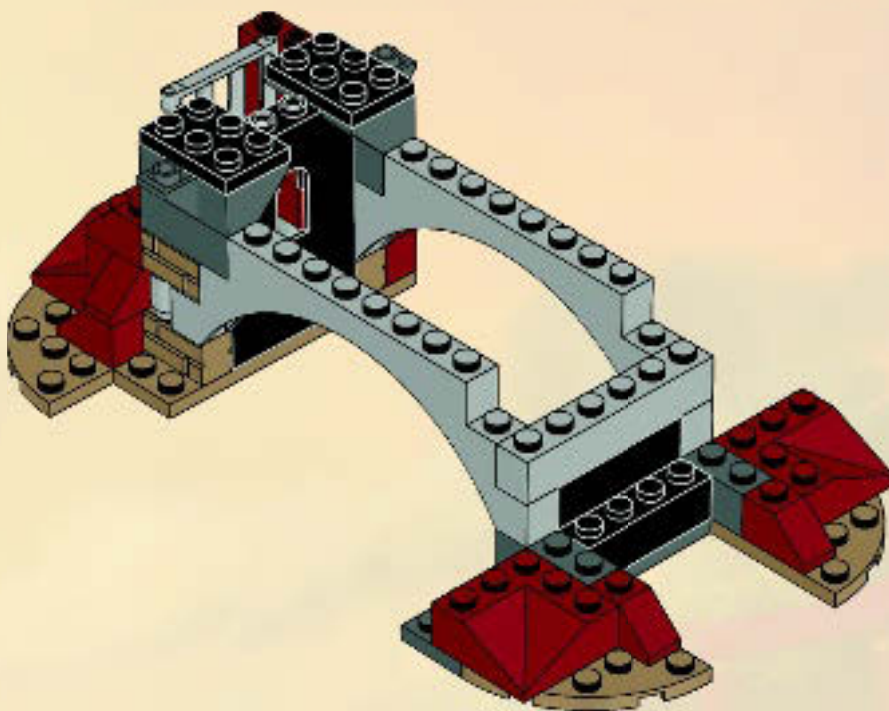



# 21

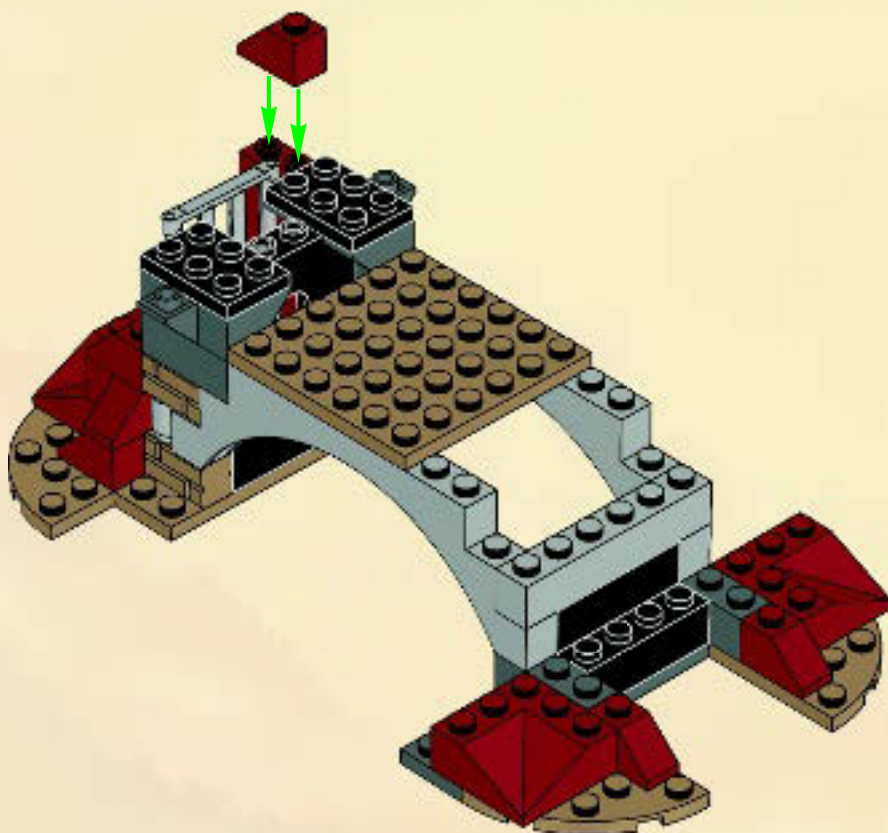



2x

# 22

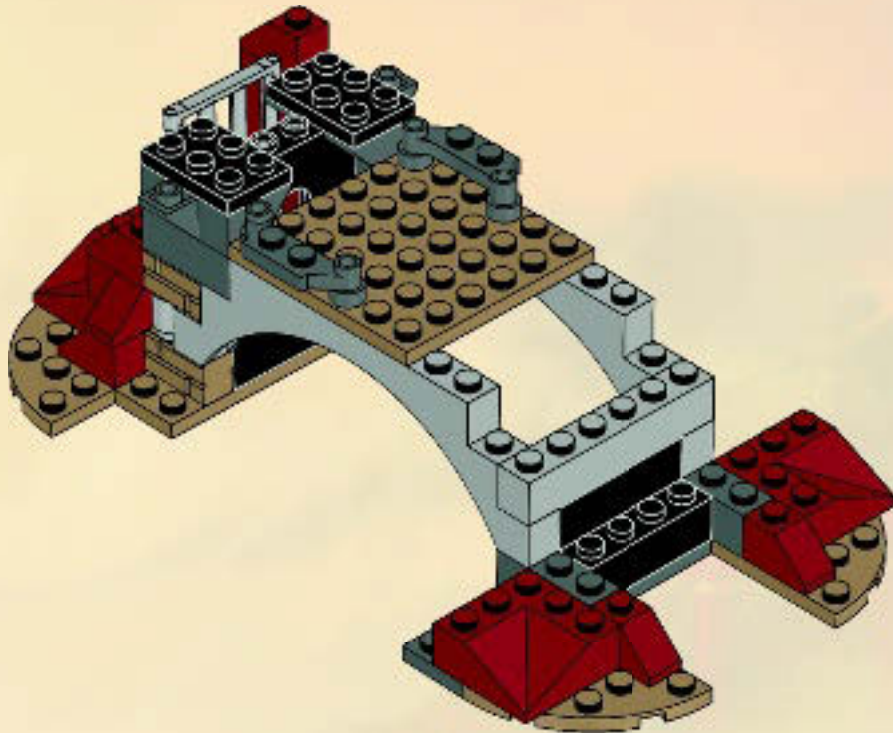

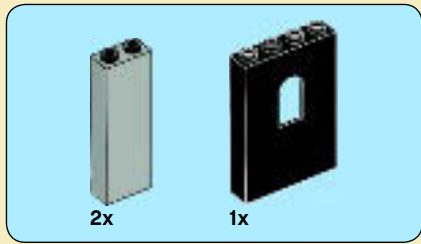

23

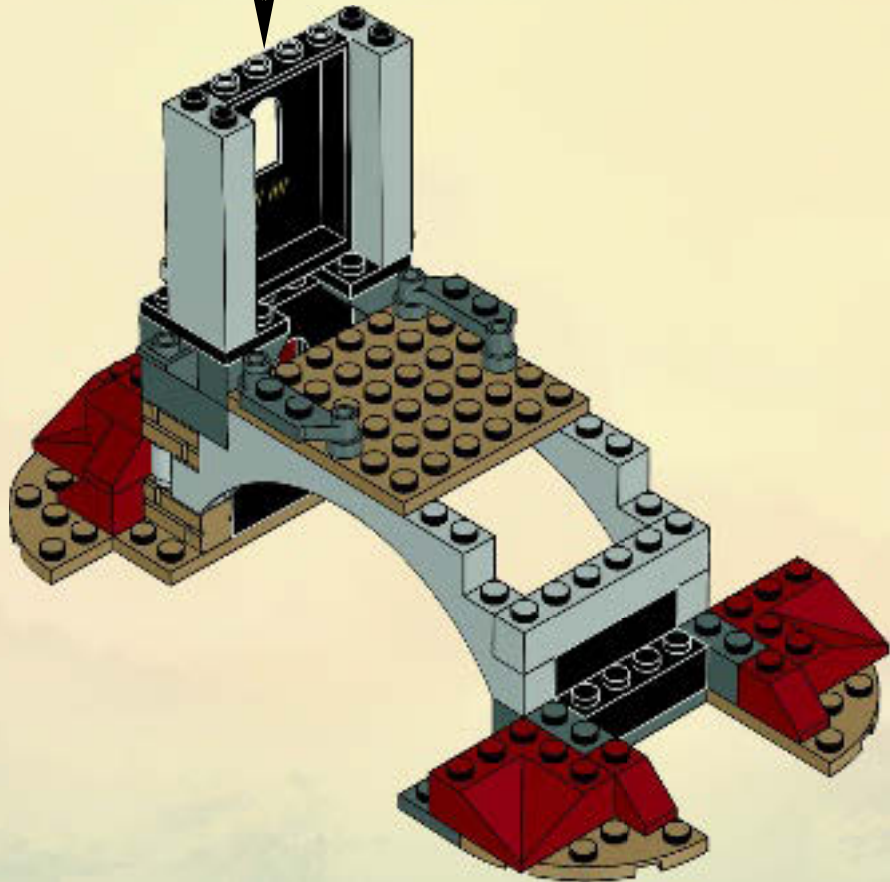
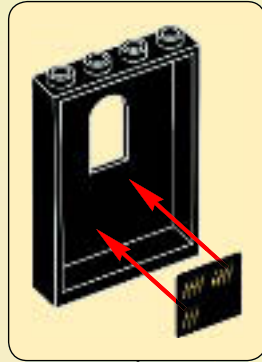





4x



6x

# 24

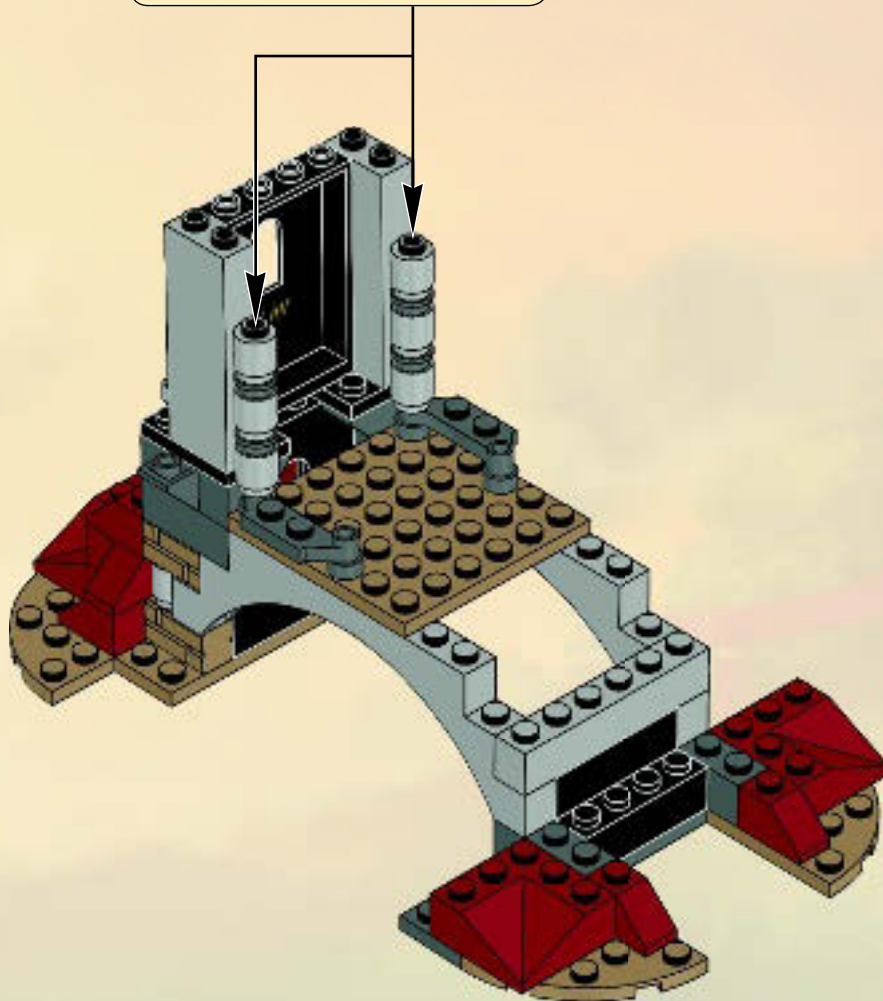
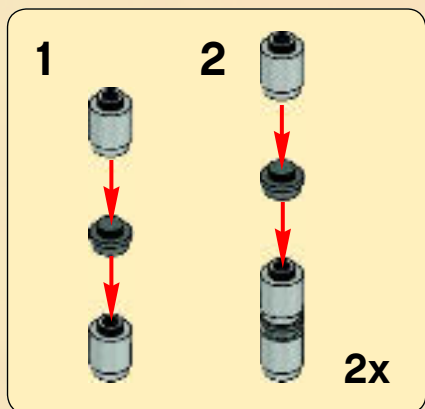



8x

# 25

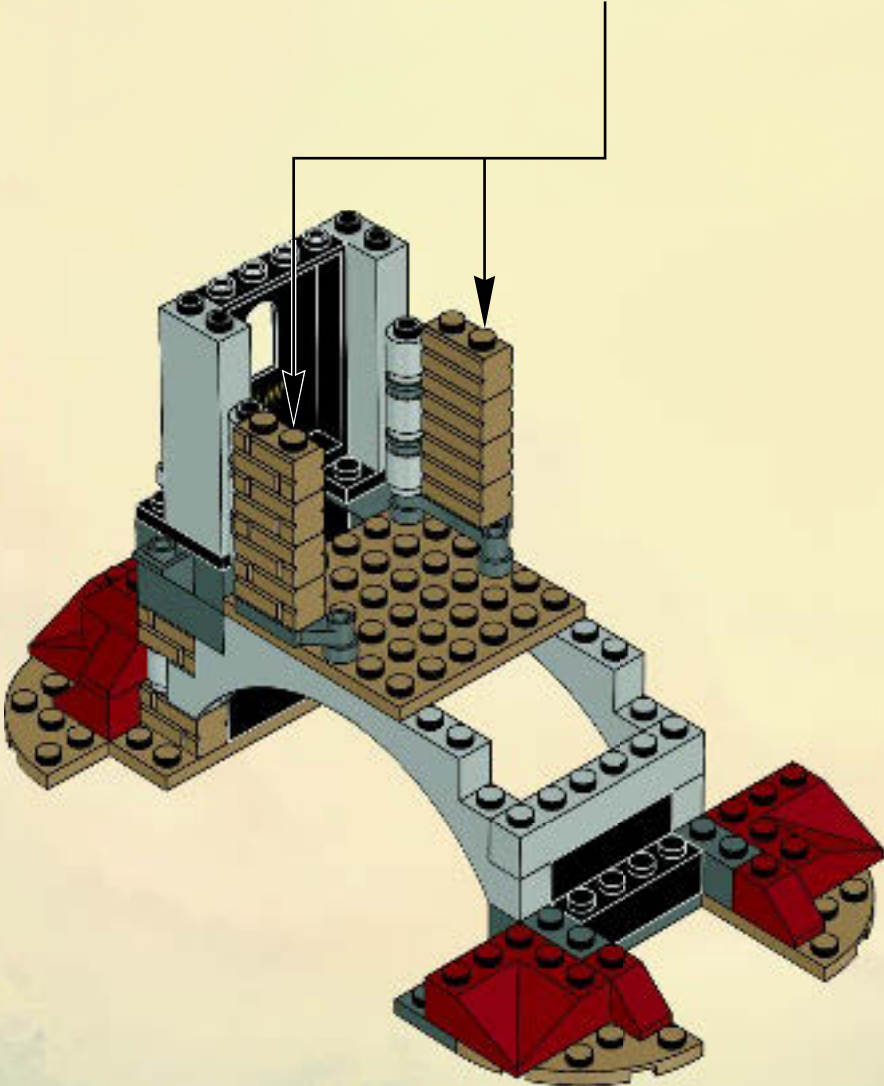
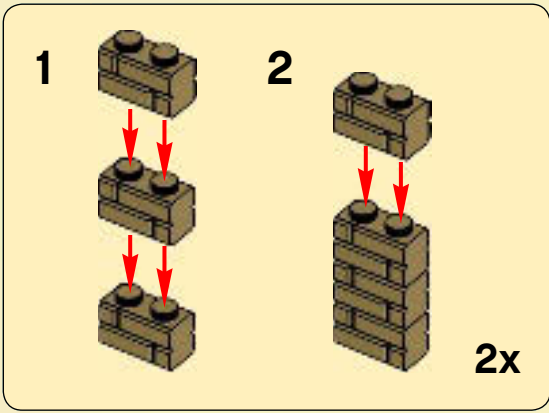

4x

6x

# 26

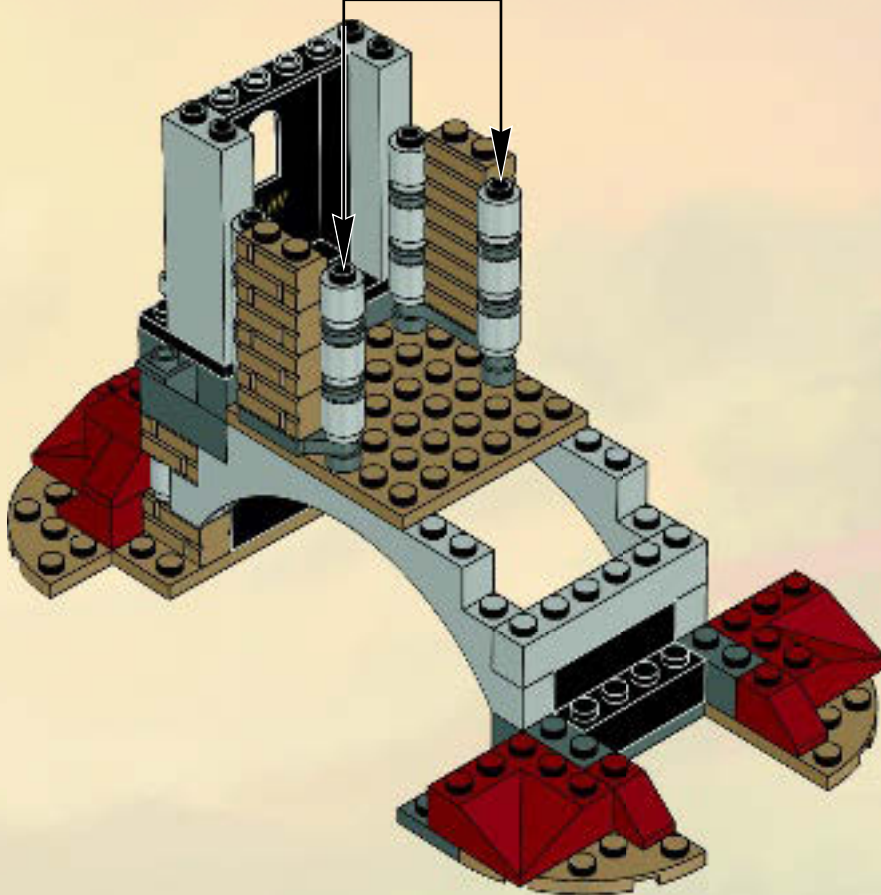
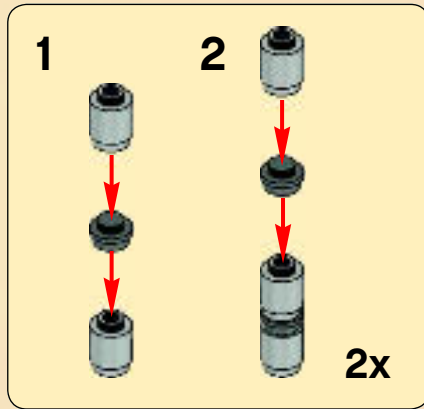



2x

# 27

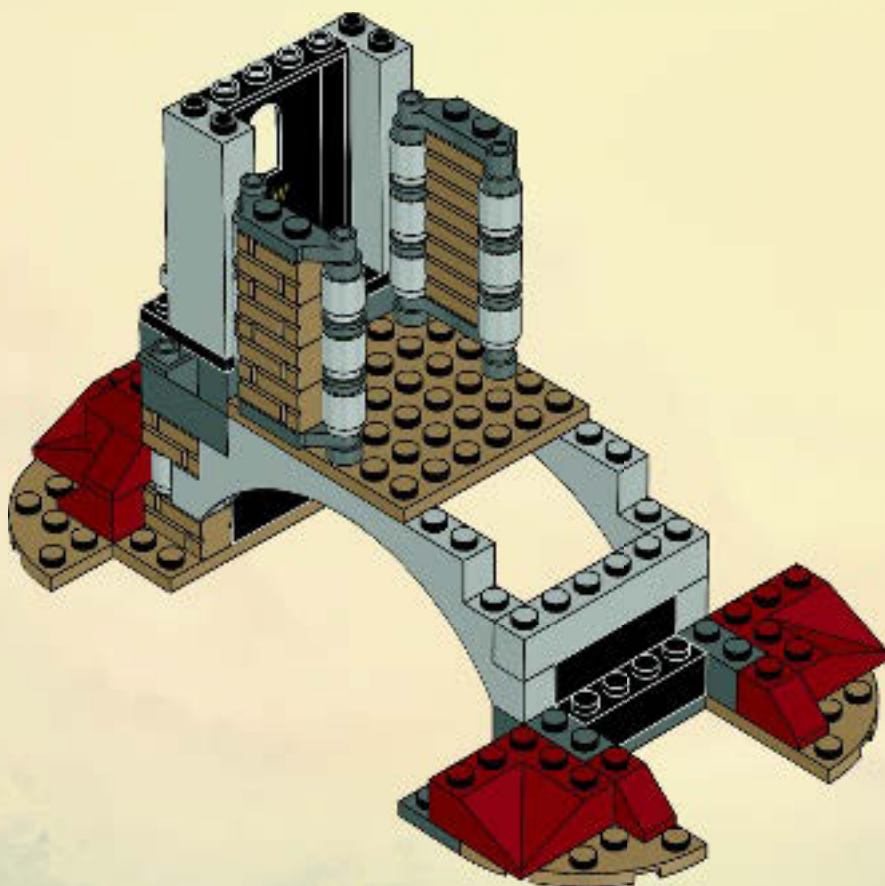

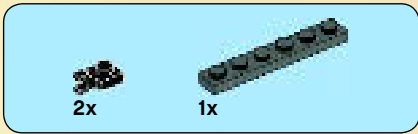

# 28

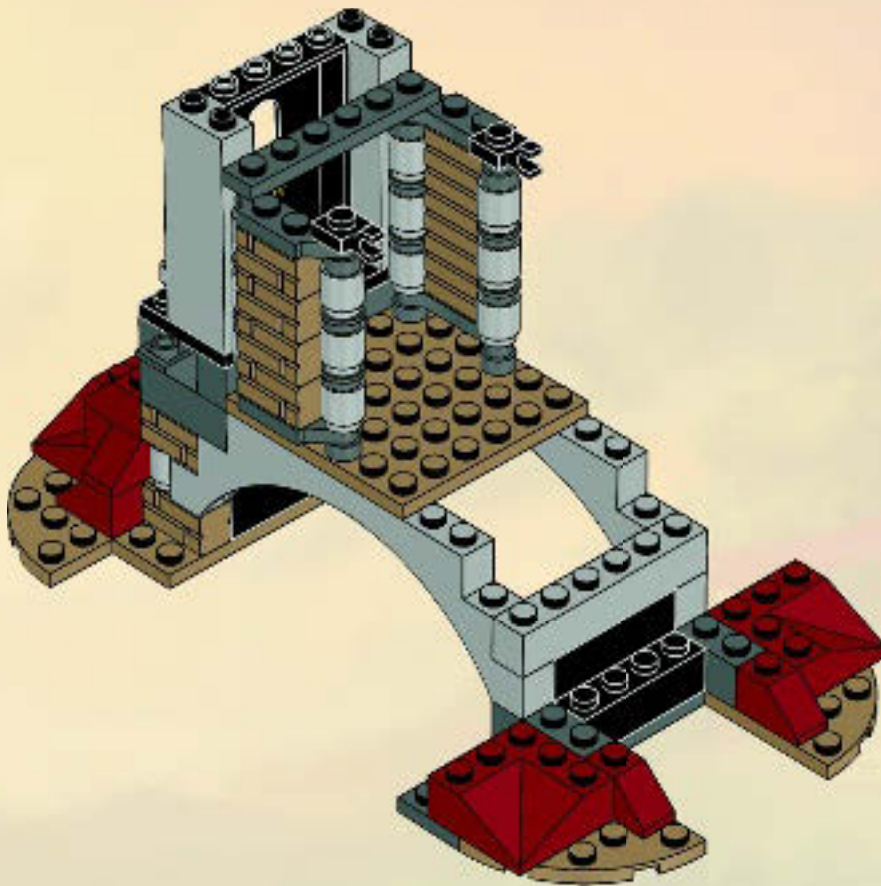



2x

# 29

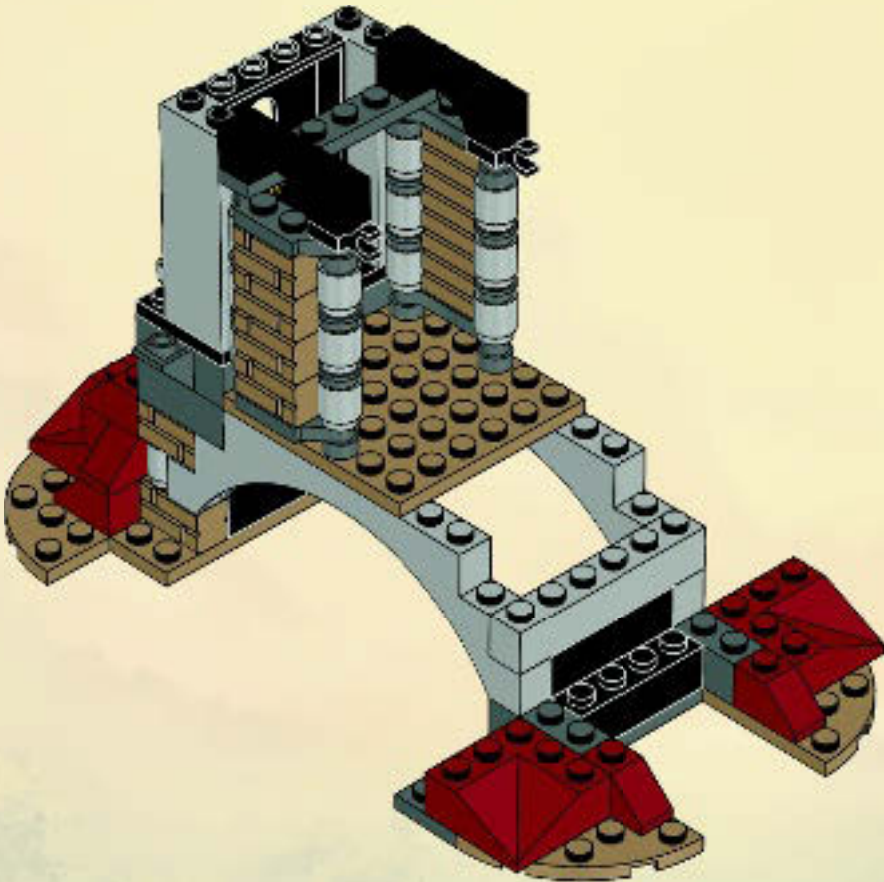

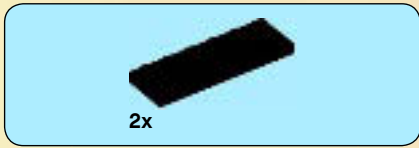

30

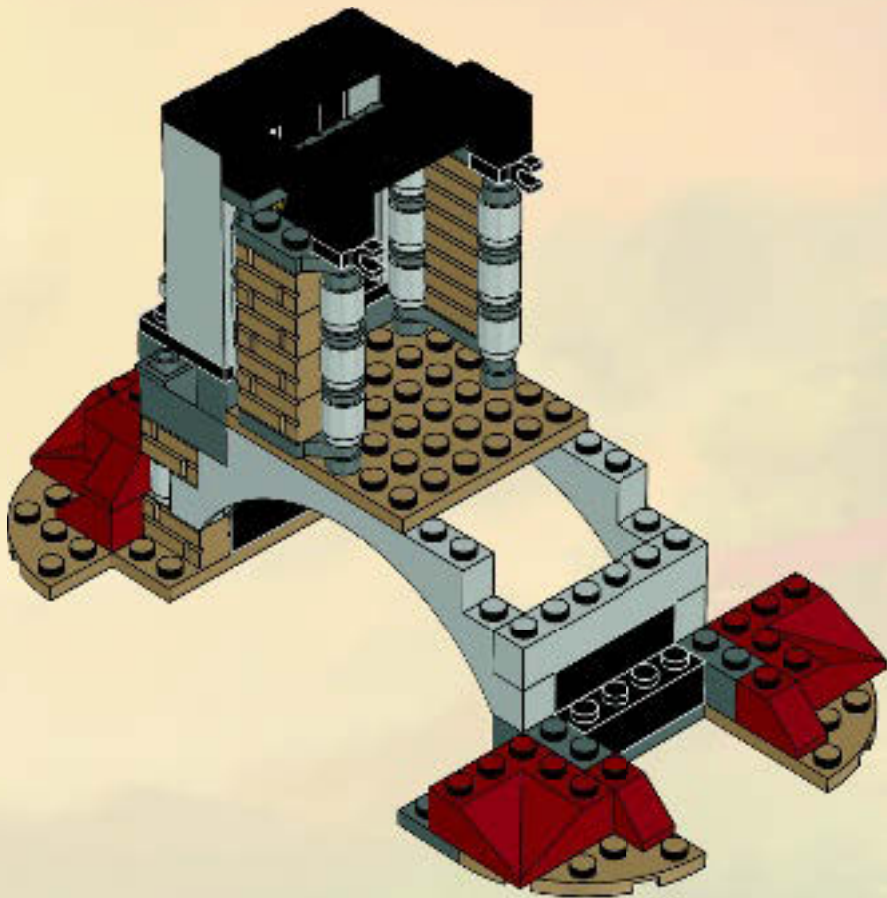

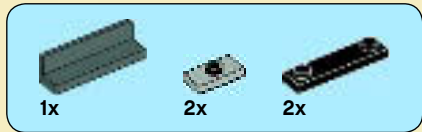

# 31

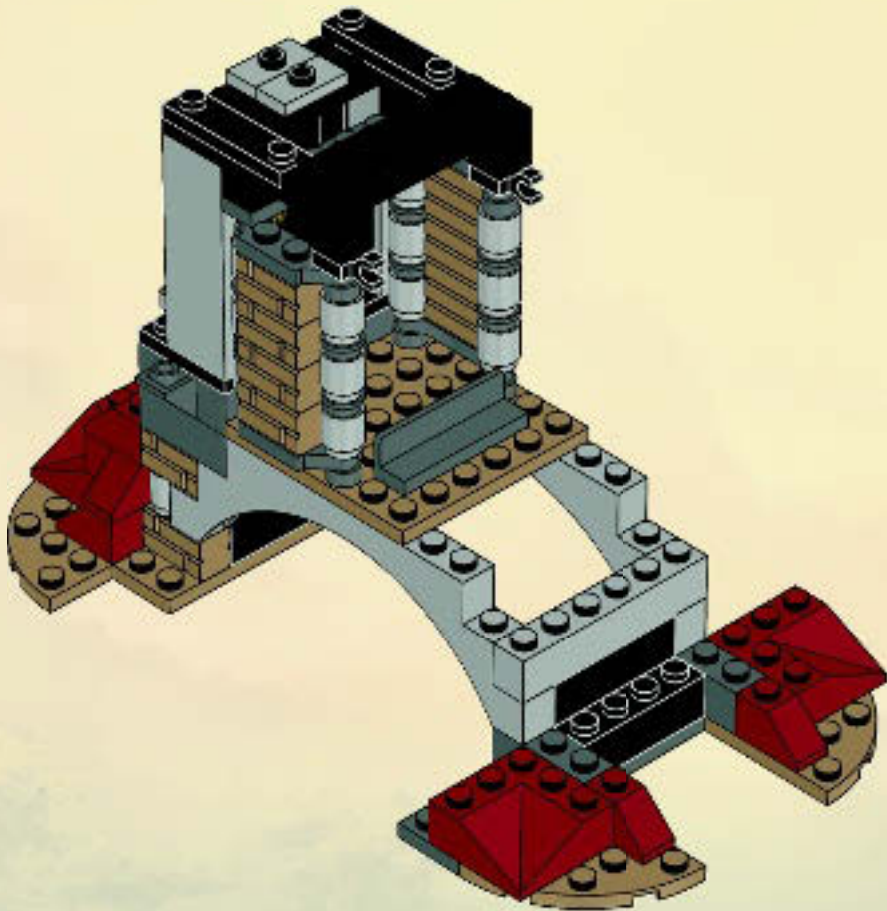



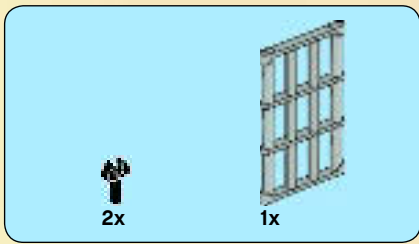

32

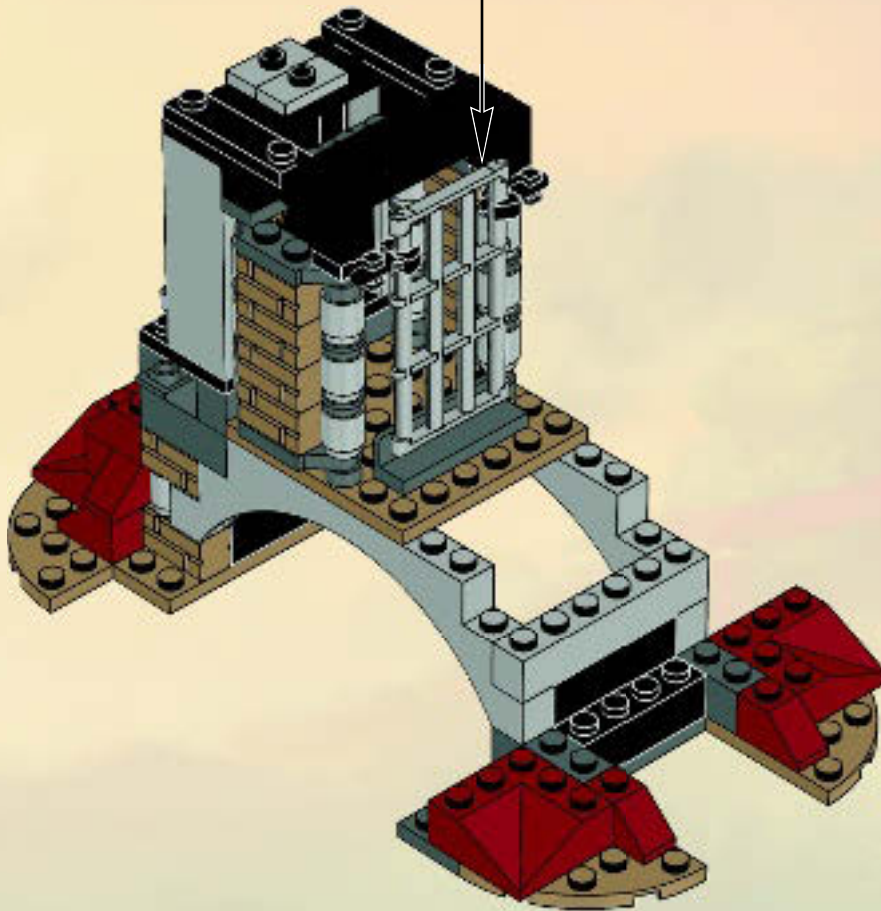
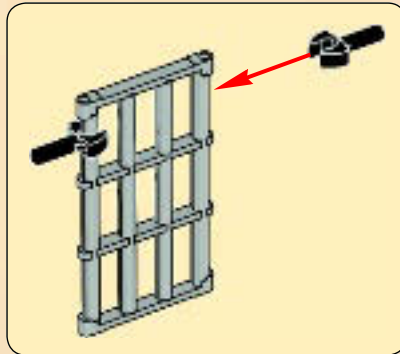



1x



2x

# 33

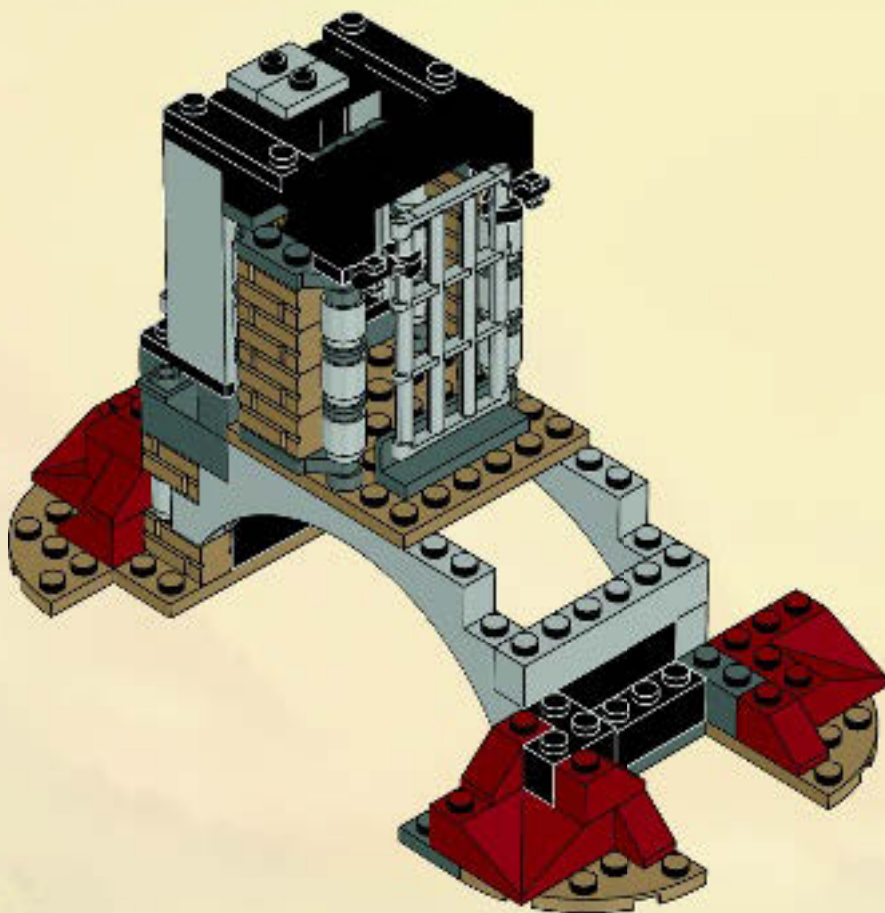

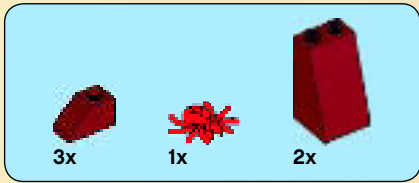

34

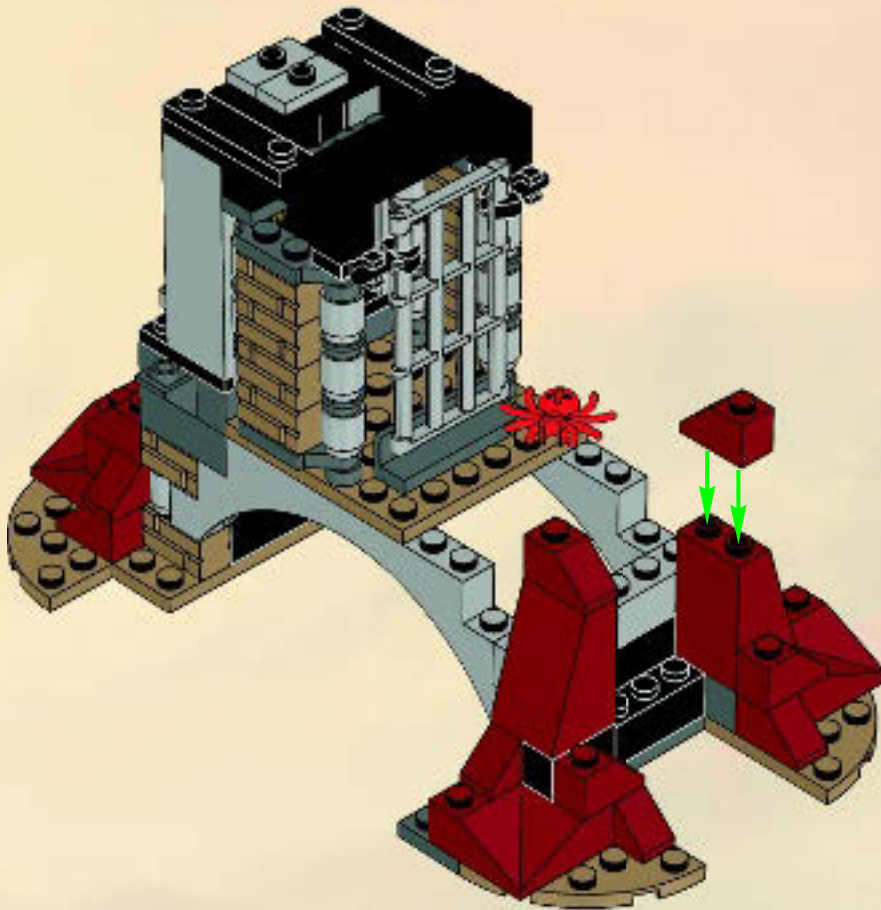

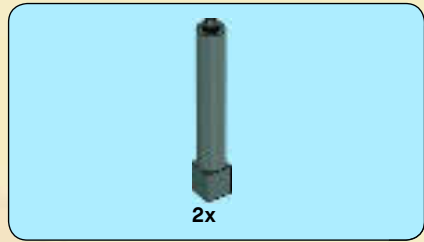
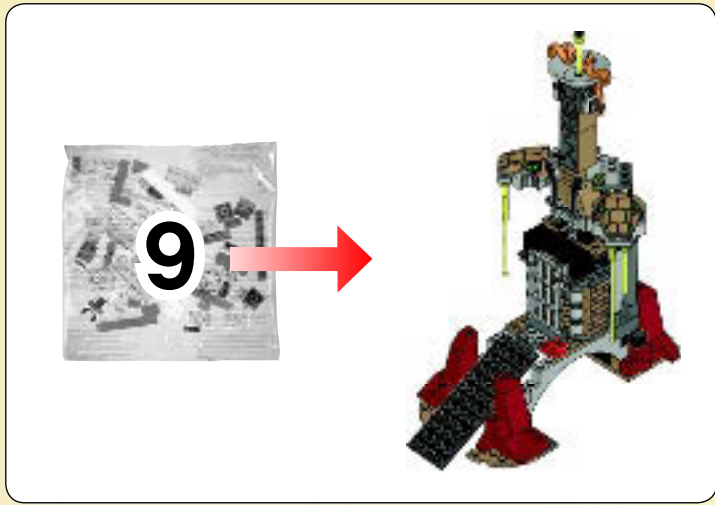

35

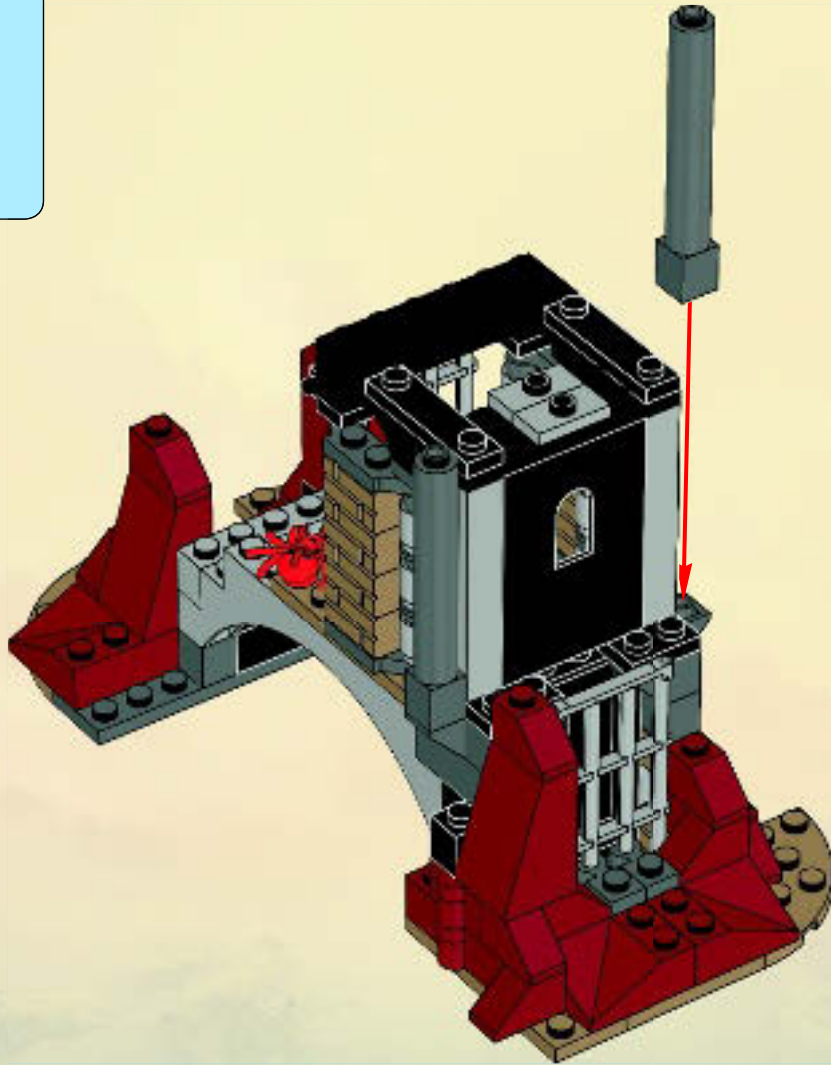
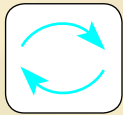



# NINJAGO

Masters of Spinjitzu





# NINJAGO

Masters of Spinjitzu



- 9573
- 9555
- 9447
- 9555
- 9447
- 9450
- 9591
- 9557
- 9447
- 9449  
9450
- 9556
- 9450
- 9447



- 9569
- 9449  
9450
- 9447  
9570  
9572
- 9556
- 9591
- 9591
- 9450
- 9450
- 9591
- 9449  
9574  
9590  
9591
- 9590
- 9450  
9591
- 9449
- 9591
- 9450



- 9555
- 9571
- 9450
- 9574
- 9573
- 9554
- 9591
- 9570
- 9449  
9450
- 9573
- 9447  
9556  
9569
- 9554
- 9449



- 9590
- 9591
- 9572
- 9447
- 9447
- 9450  
9554  
9570  
9572  
9574
- 9557
- 9571
- 9449
- 9448  
9449  
9557
- 9591
- 9449  
9550
- 9450



# NINJAGO

Masters of Spinjitzu



**LLOYD ZX**  
9574 • 9450



**NRG ZANE**  
9590



**NRG COLE**  
9591



**NRG JAY**  
9570



**NRG COLE**  
9572



**CHOKUN**  
9553 • 9450



**MEZMO**  
9555



**FANGDAM**  
9571



**SPITTA**  
9569 • 9449



**PYTHOR**  
9449



**SLITHRAA**  
9573



**LIZURA**  
9557



**BYTAR**  
9556 • 9448





1x



2x

# 36

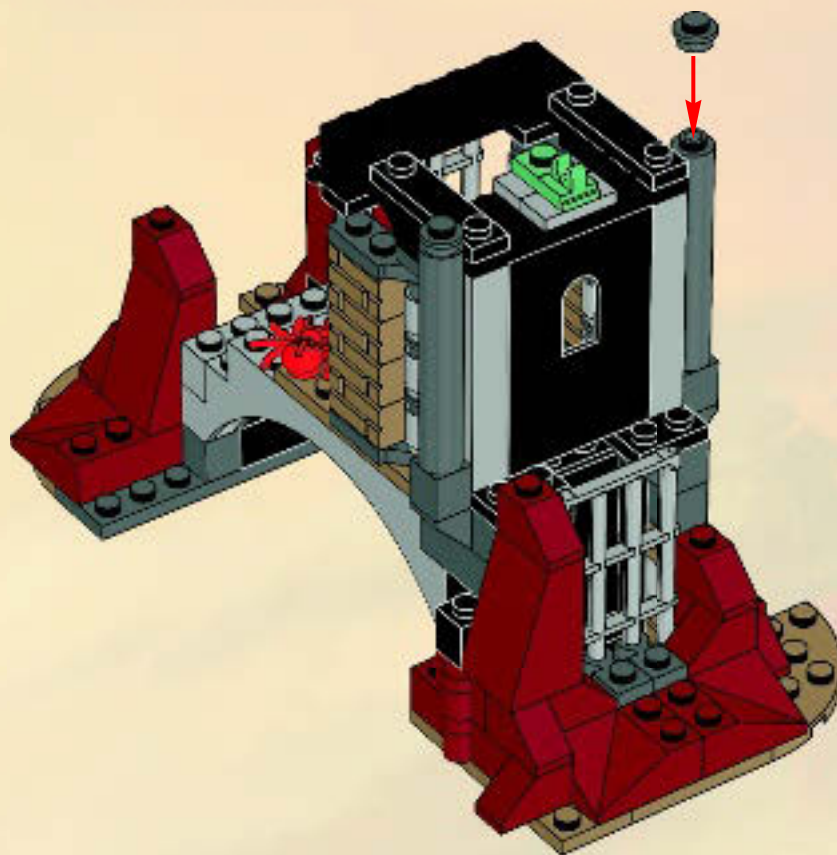

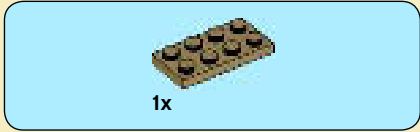
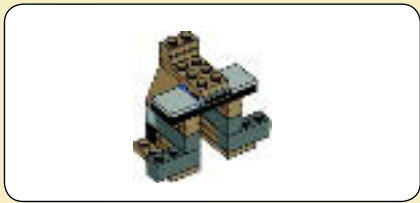

1

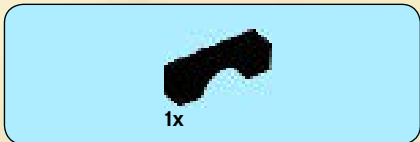

2

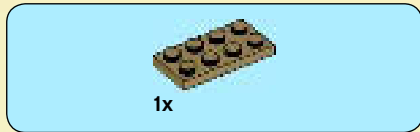

3

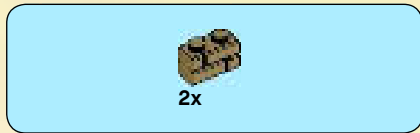
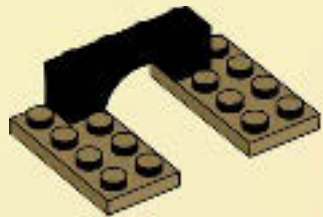

4

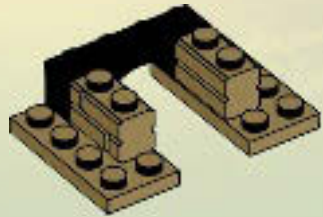

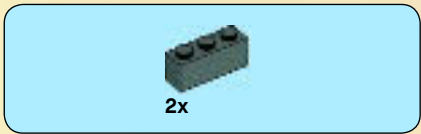

5

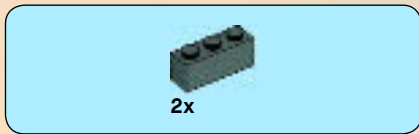
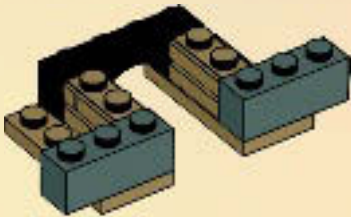

7

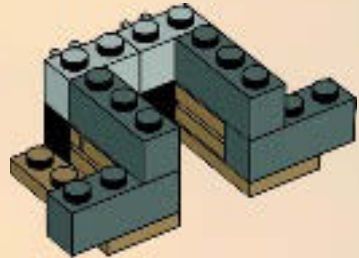

6

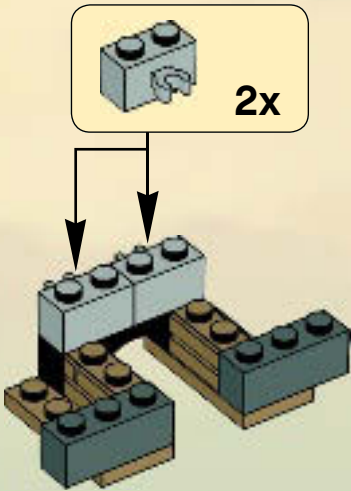

8

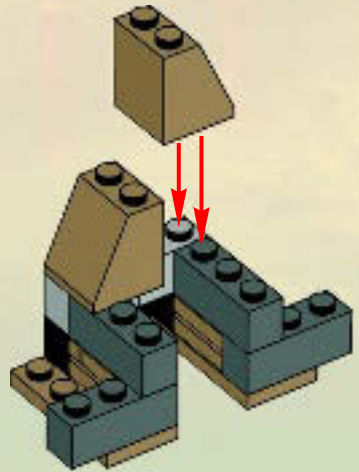



2x

# 9

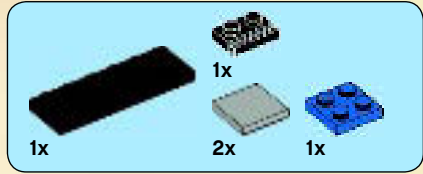
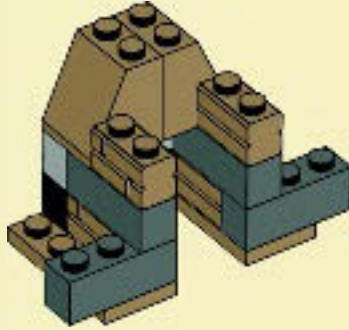

# 10

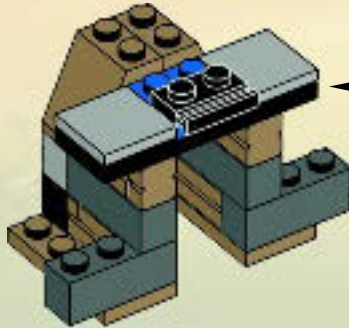
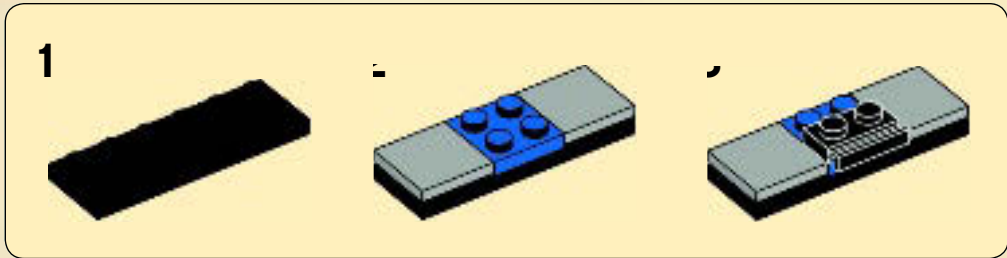



1x

11

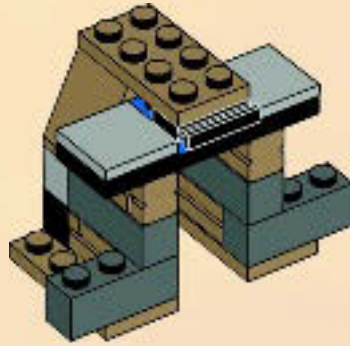

1x

12

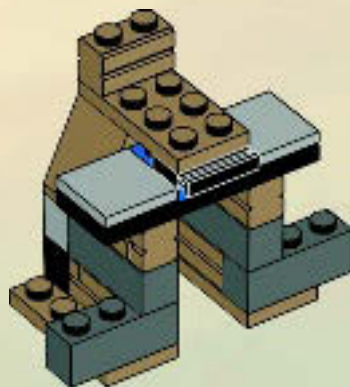



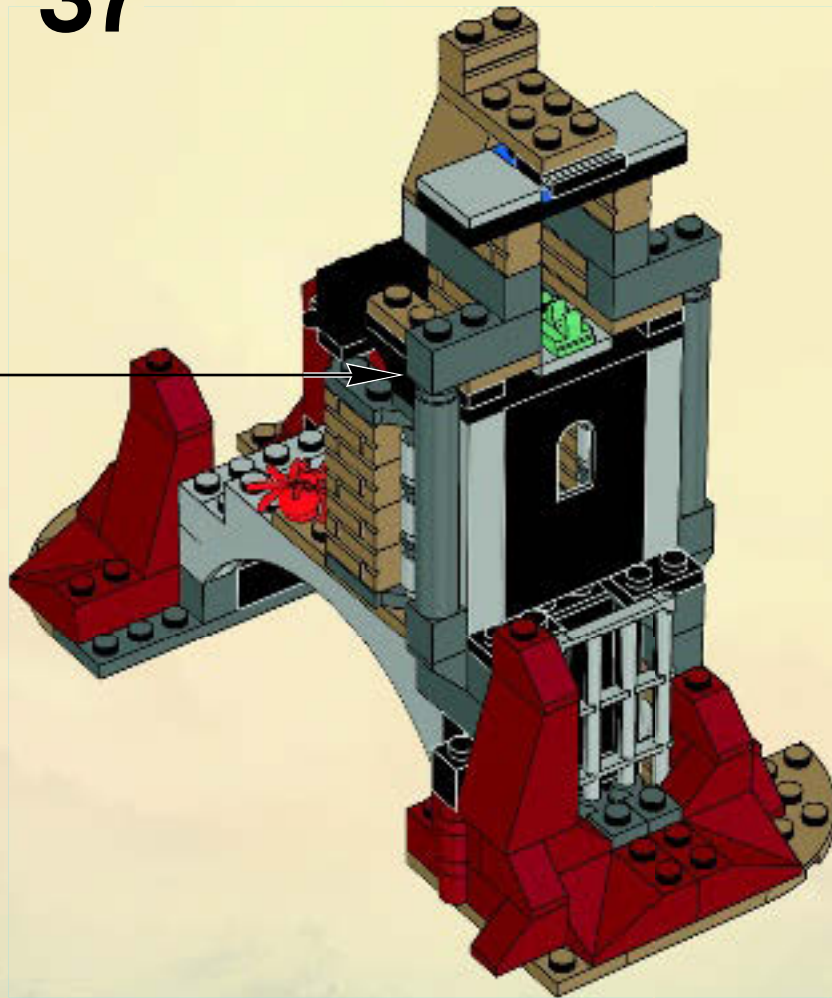

37

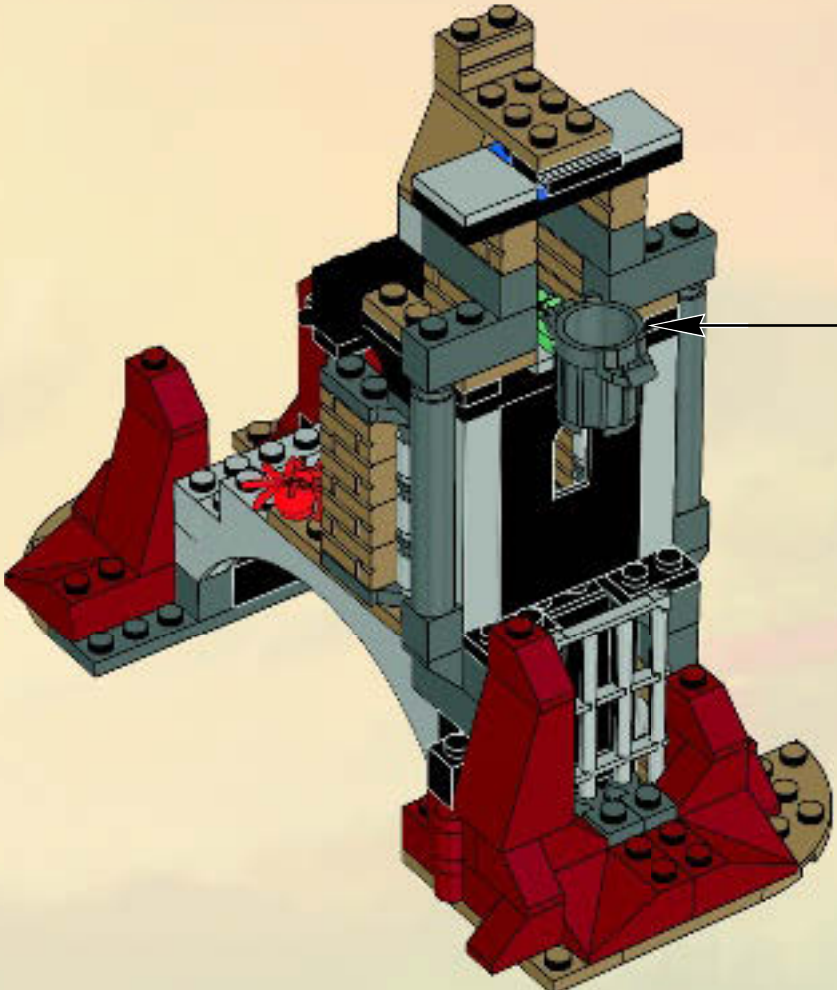

1x  2x 

# 38



  
  

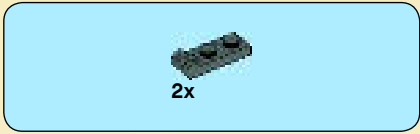

1

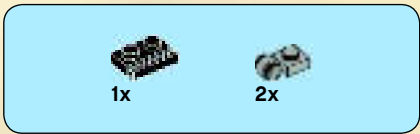
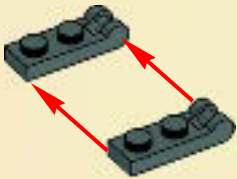

2

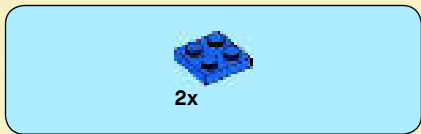
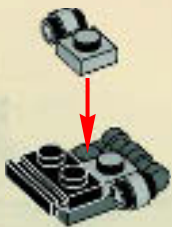

3

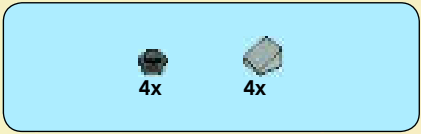
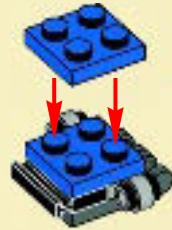

4

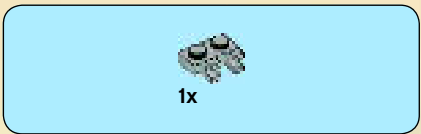
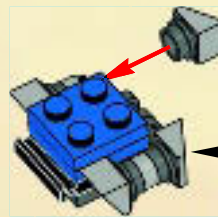
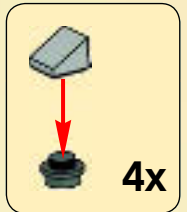

5





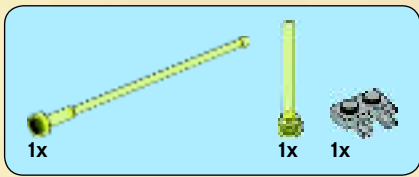

6

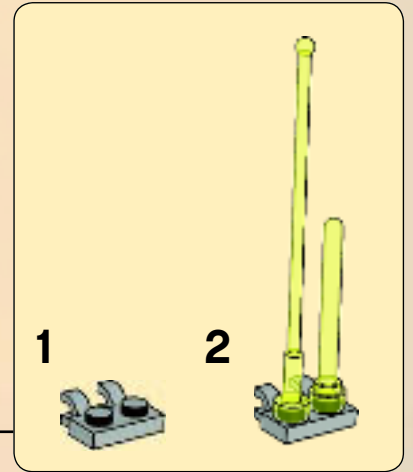
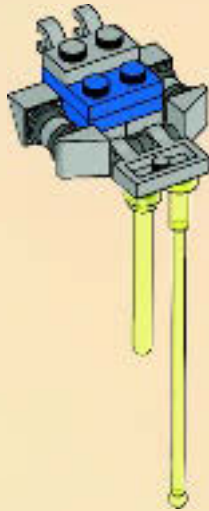
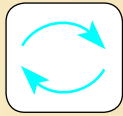

7

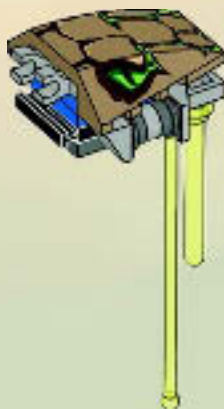
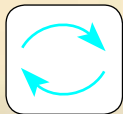

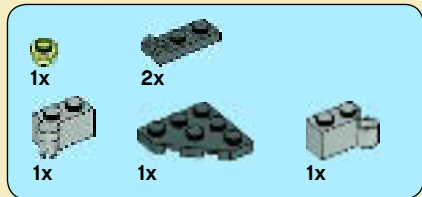

8

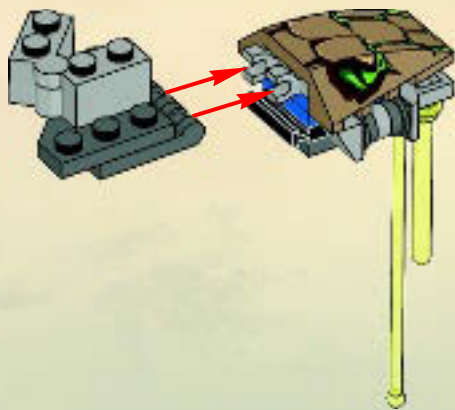
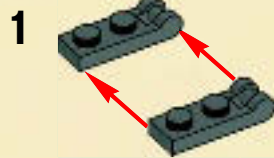
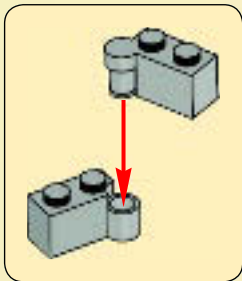

39

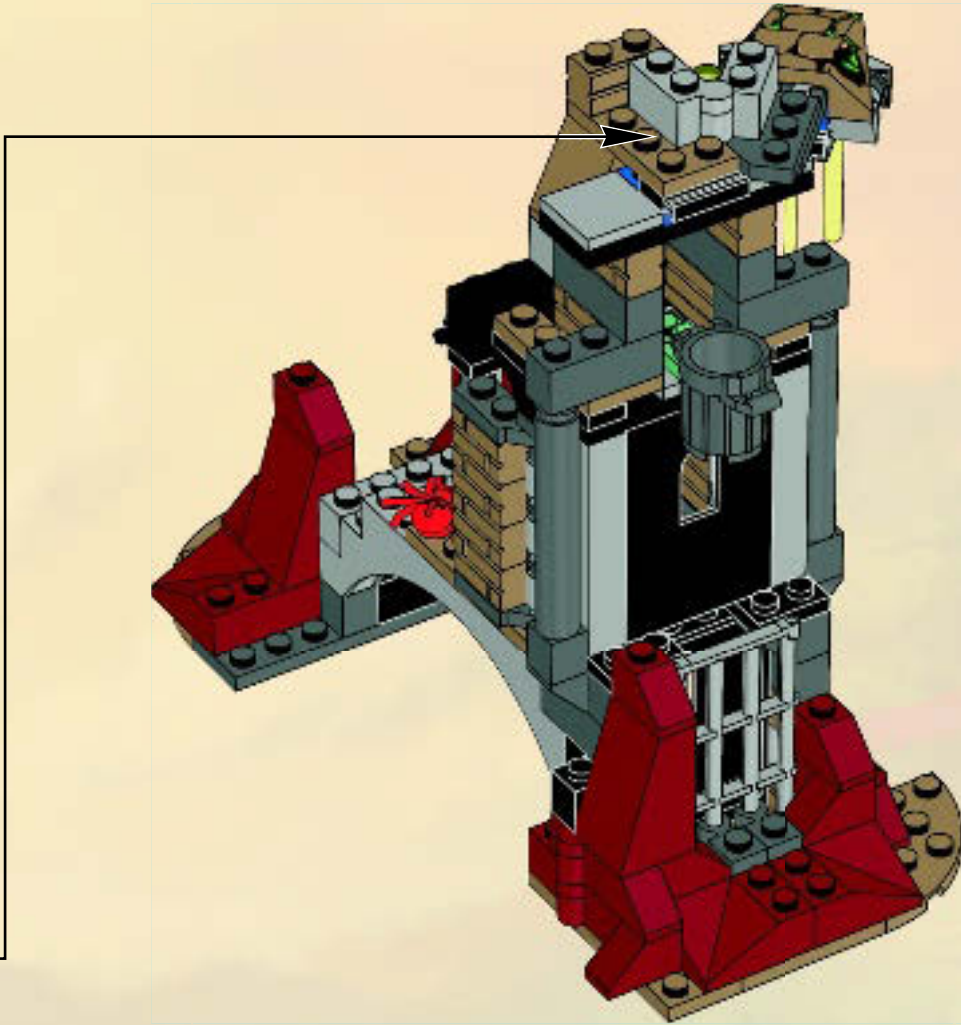

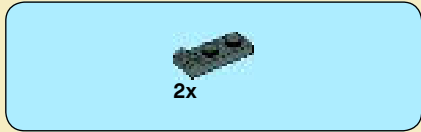

1

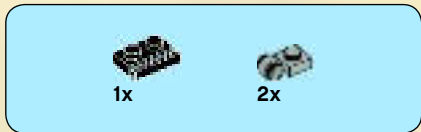
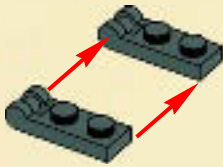

2

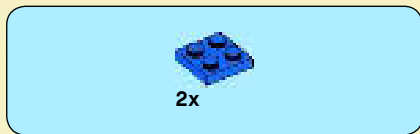
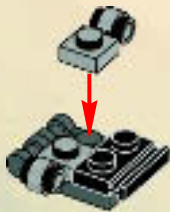

3

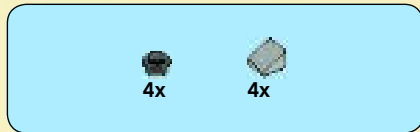
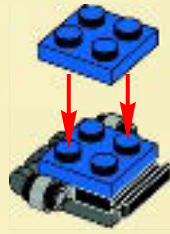

4

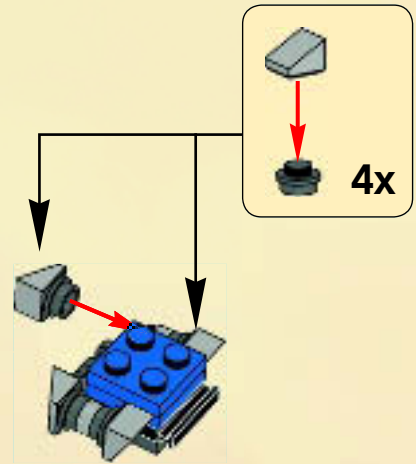

5

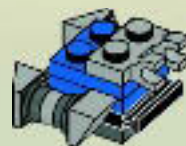

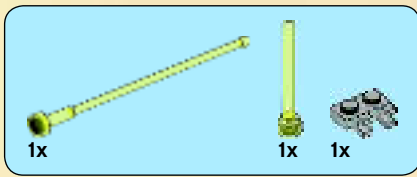

6

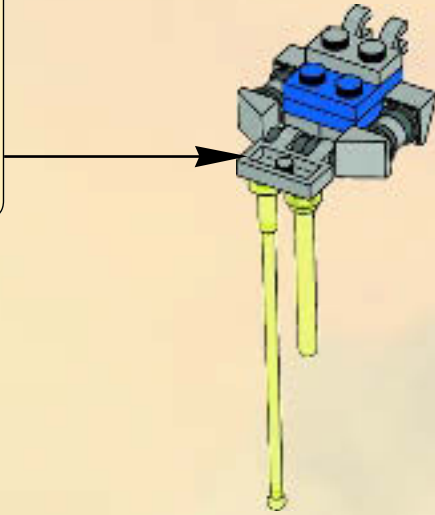
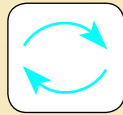
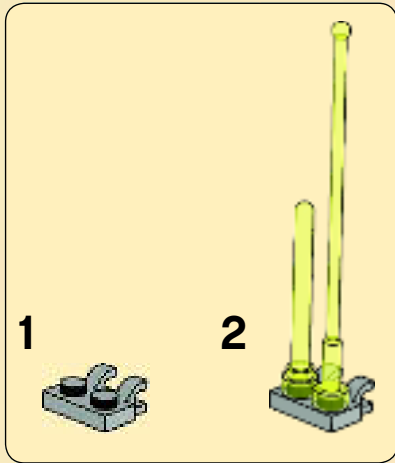

7

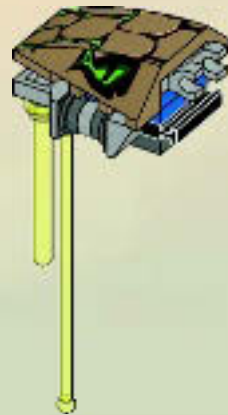
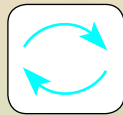

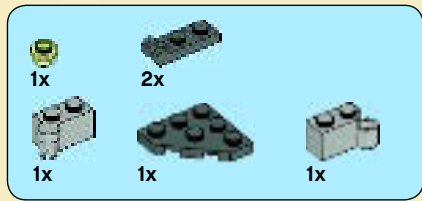

8

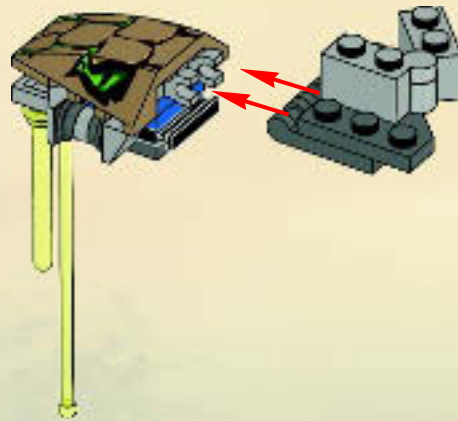
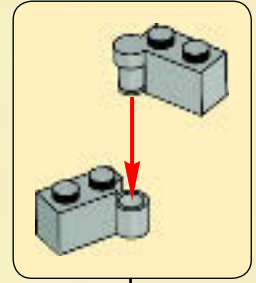
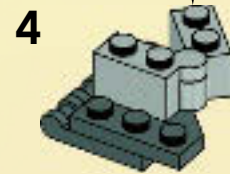
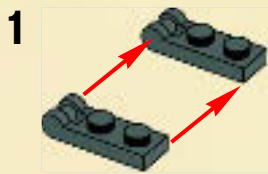

40

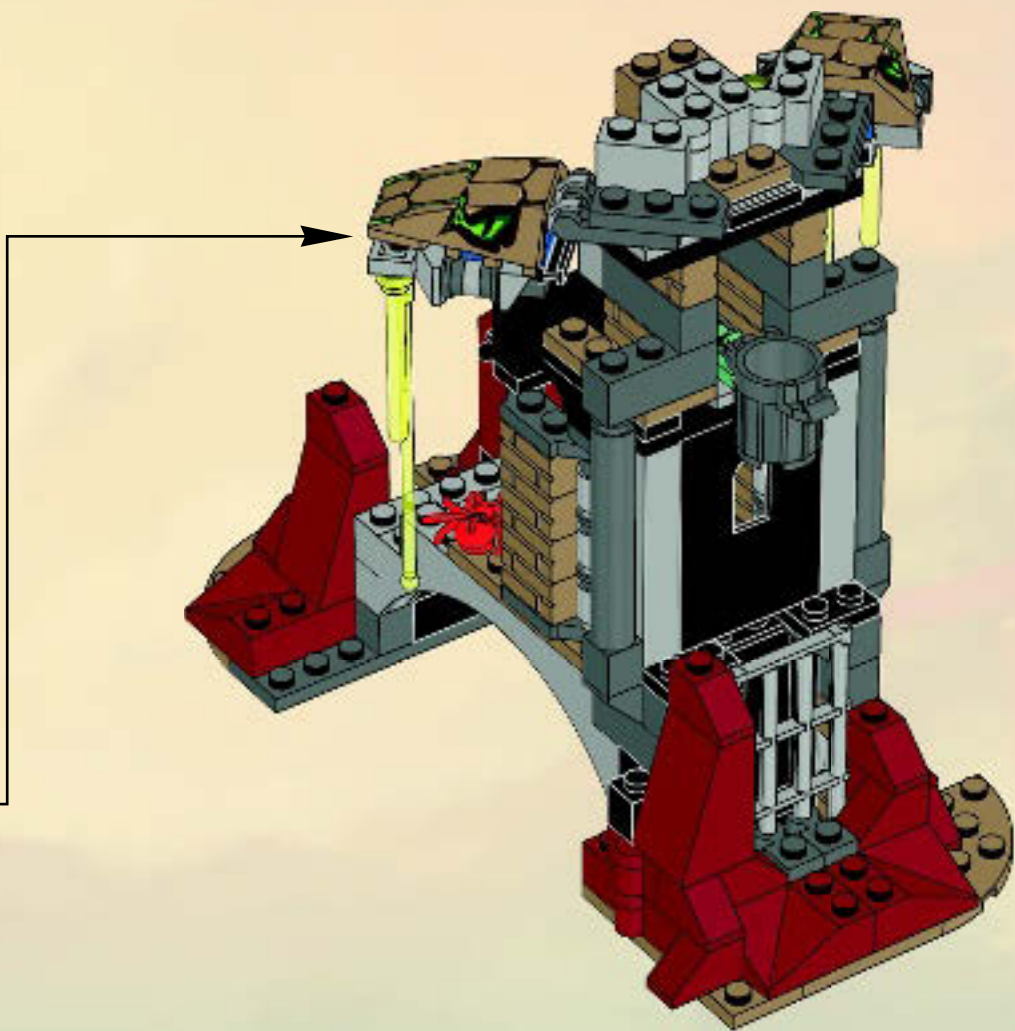

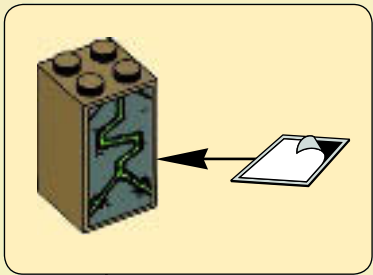

41

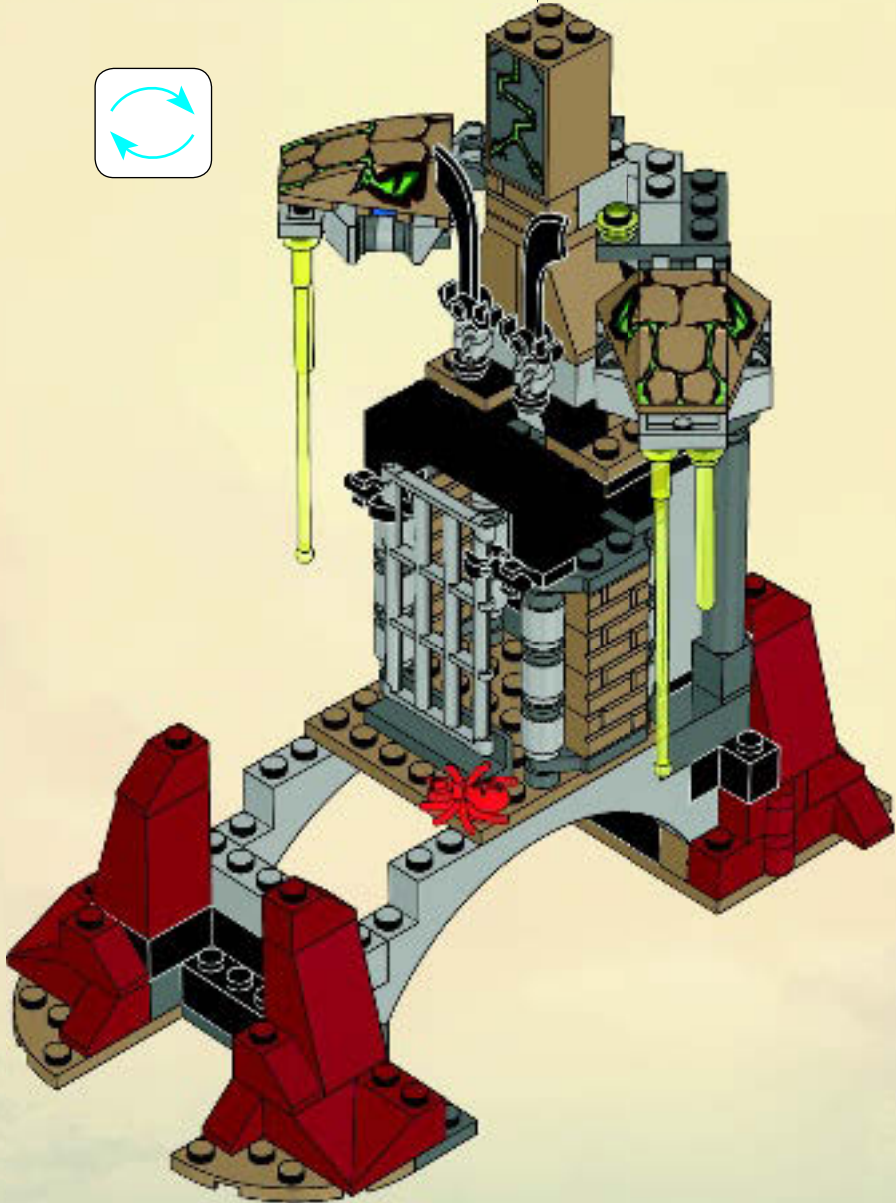
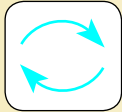



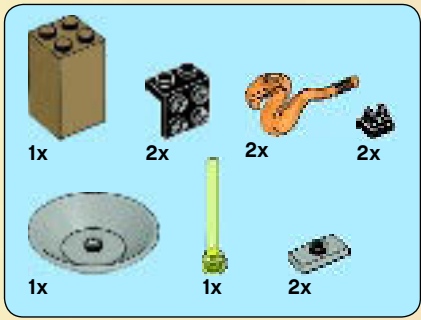

# 42

1

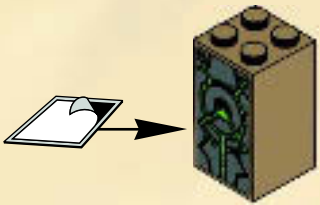

2

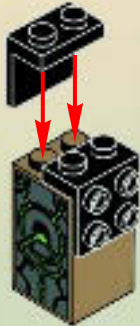

3

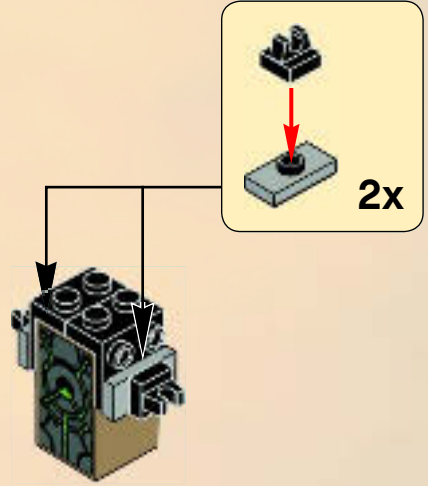

4

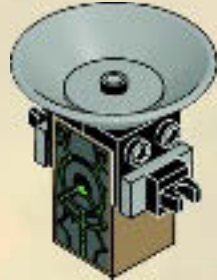

5



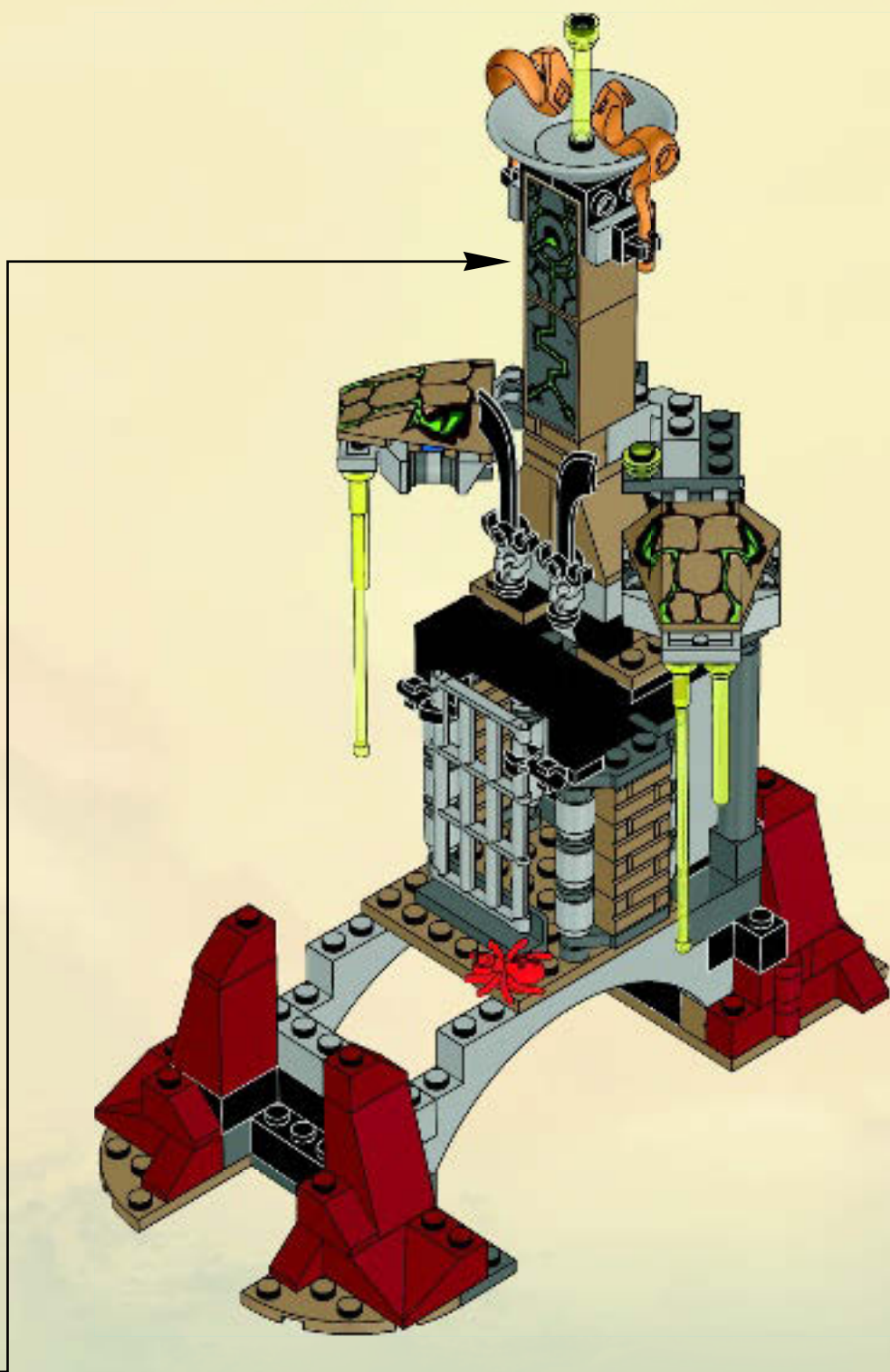

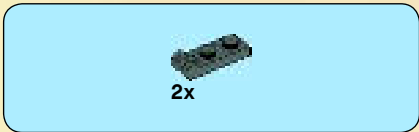

1

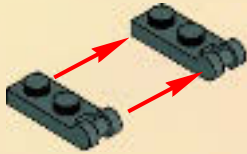

2



3

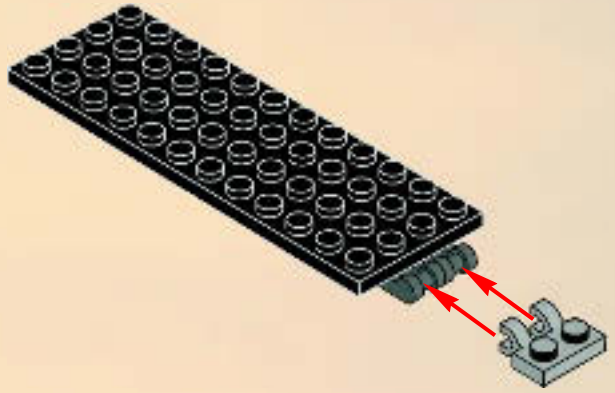

43

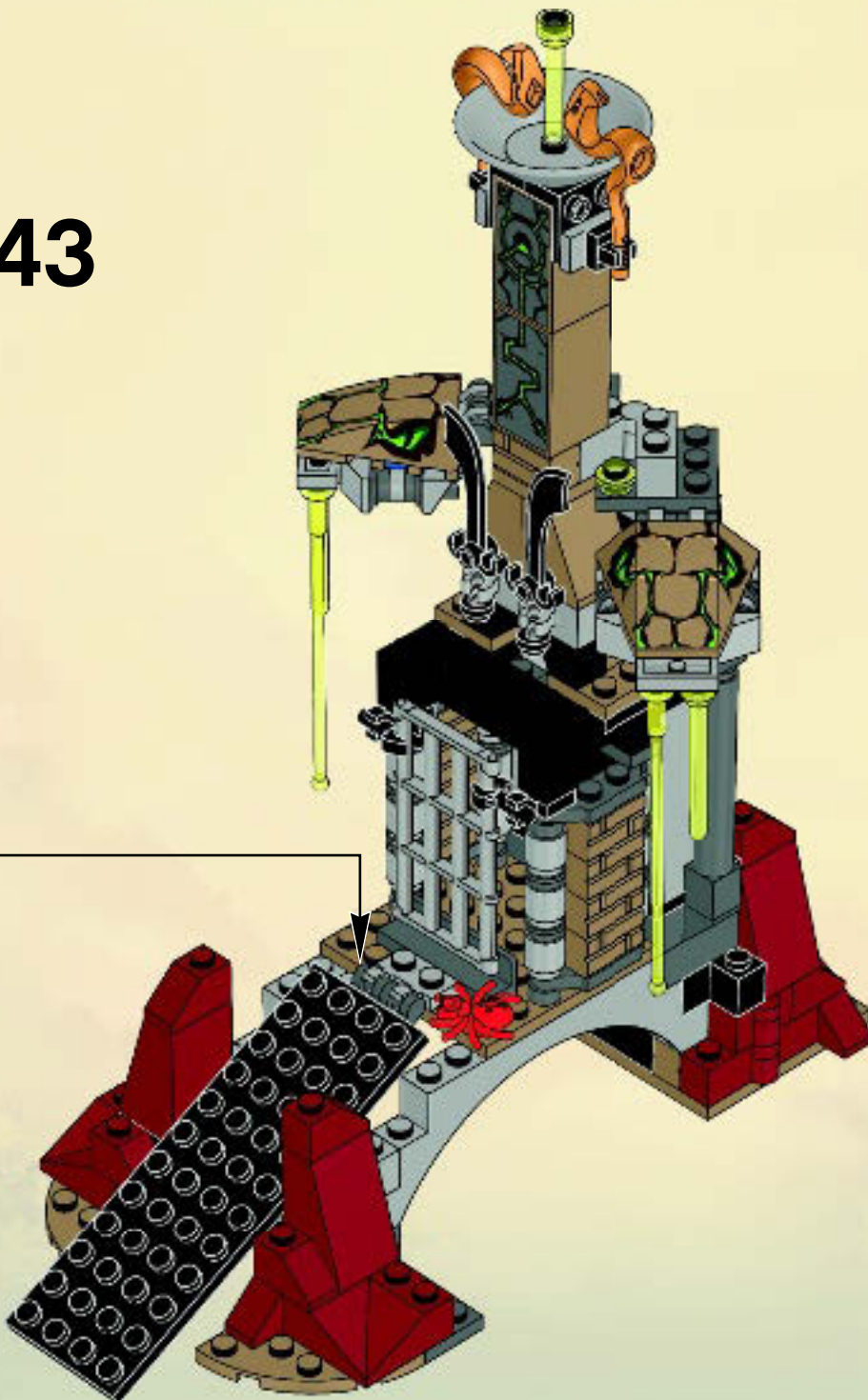

1

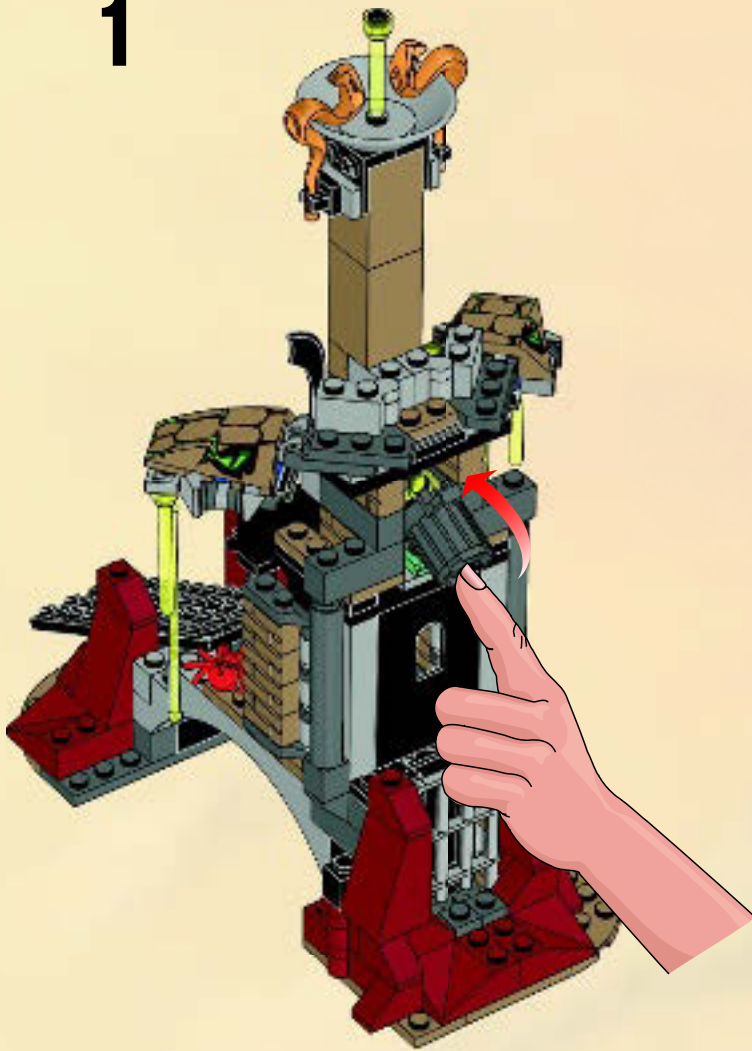

2





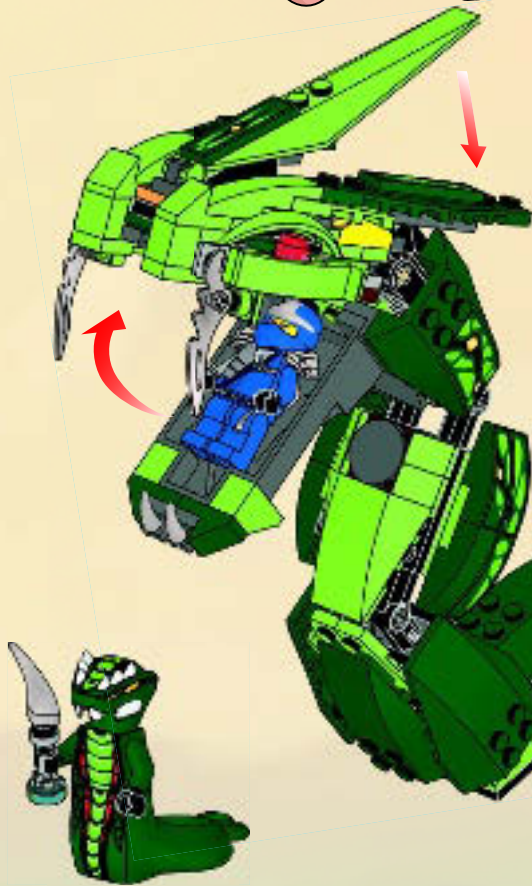
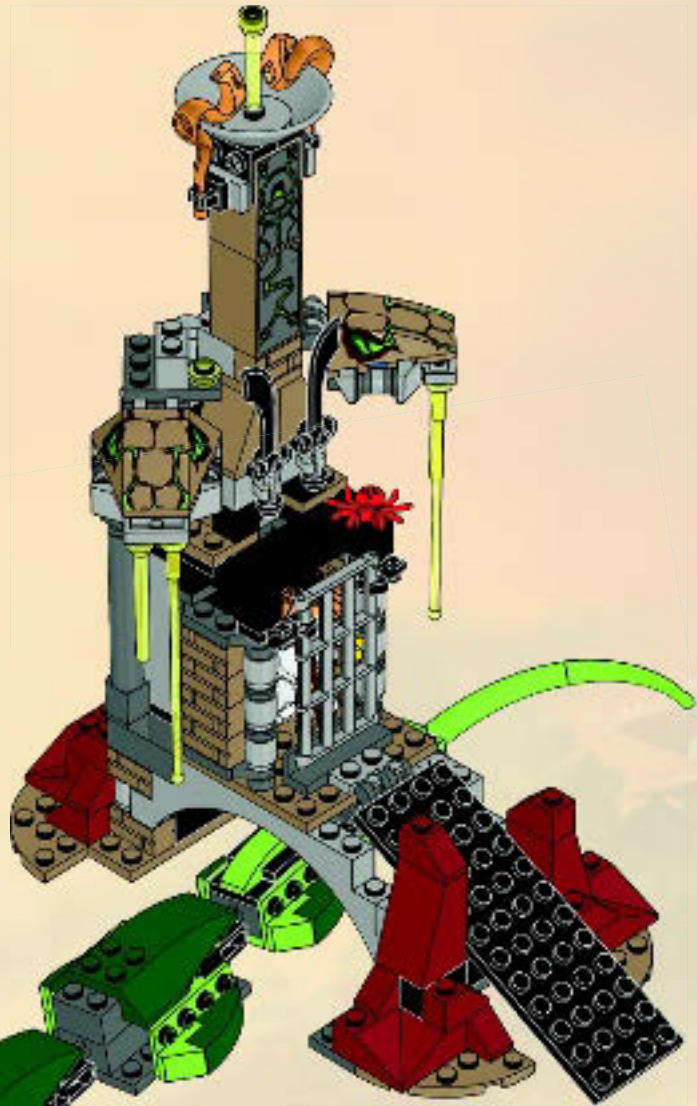
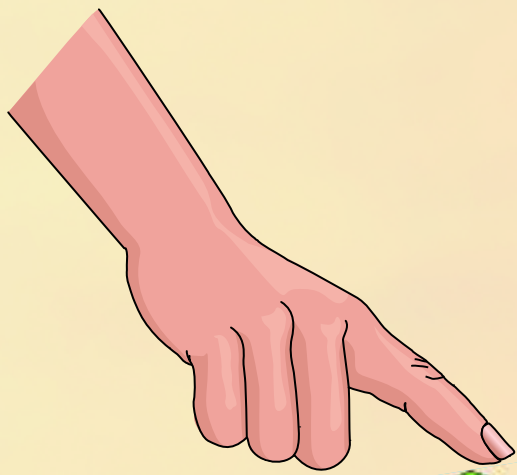



2x  
4495412



2x  
4143254



2x  
306201



2x  
4650644



2x  
4121932



2x  
4622545



2x  
379401



2x  
302301



1x  
244501



4x  
4615649



4x  
4293876



6x  
4282737

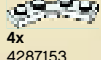

4x  
4287153



1x  
416201



8x  
4650588

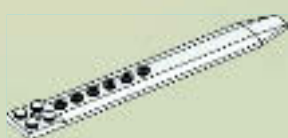

6x  
4549264

56



1x  
4160857



1x  
4161326



2x  
403201



1x  
4249506



2x  
241901



1x  
4651720



1x  
4651703



1x  
4600294



1x  
4609289



1x  
6019887



1x  
6006252



1x  
6016747



1x  
6016746



4x  
4662268



1x  
4159739



1x  
4181134



1x  
4114084



2x  
4666579



4x  
4558886



3x  
302321



1x  
4593768



4x  
4227155



2x  
4142865



5x  
302223



1x  
4650492



1x  
4650129



1x  
4650118



2x  
4143005



22x  
4206482



3x  
4514553



7x  
403224



1x  
4611432



1x  
4647015



1x  
4611427



4x  
4218699



6x  
235726



1x  
301026



2x  
300126



7x  
4644456



2x  
4233487



5x  
4619763



4x  
370026



2x  
389426



2x  
4529549



2x  
273026



6x  
4653087



2x  
4548180



1x  
4273703



1x  
428726



1x  
4647286



2x  
4160108



2x  
4160130



1x  
4180469



4x  
379426



3x  
302226



2x  
4565323



4x  
362326



2x  
302126



2x  
4599499



2x  
4599499



2x  
366626



9x  
4243819



1x  
303426



1x  
302926



2x  
255526

2x  
4517925

4x  
4144575

2x  
4277932

3x  
4107761

4x  
4183043

2x  
306826

2x  
244426

5x  
4613759

2x  
4604304

1x  
4636410

1x  
4283047

1x  
4251393

1x  
4251394

1x  
4283046

2x  
4227392

2x  
4160025

2x  
4537058

1x  
4650761

1x  
4616334

1x  
4647628

1x  
6016733

1x  
4616311

2x  
4273400

2x  
4656377

14x  
4273590

6x  
4143875

2x  
4285883

2x  
4289538

1x  
6016743

2x  
4121667

4x  
4610948

2x  
4598410

4x  
4584550

20x  
4121715

10x  
4107084

2x  
4107081

1x  
370526

1x  
370626

2x  
4629921

4x  
4187334

4x  
4233489

1x  
4650497

1x  
4650132

1x  
4650121

2x  
4544720

1x  
4653400

6x  
4244573

2x  
3005748

9x  
6000782

4x  
3005749

3x  
4114011

2x  
256949

2x  
4220634

2x  
4504372

2x  
4537925

12x  
4648274

4x  
4537928

2x  
4537927

5x  
4617069

1x  
4653662

2x  
4633822

8x  
4537937

11x  
4537936

2x  
4632576

12x  
4617067

1x  
4656148

3x  
4539907

3x  
4539908

1x  
4650635

1x  
4650634

2x  
4610474

2x  
4663285

16x  
4646577

2x  
4616593



2x  
465351



5x  
426784



1x  
4246957



1x  
4530712



3x  
4570451



1x  
6016729



2x  
4648467



14x  
4267850



7x  
4652932



5x  
4543949



2x  
4648340



2x  
4648342



1x  
4647764



1x  
6016717



1x  
4625236



15x  
4541526



3x  
6007898



4x  
4651936



2x  
6011462



2x  
4568761



2x  
4211225



2x  
4600541



1x  
4211202



2x  
4626666



9x  
4211189



6x  
4211186



3x  
4211214



2x  
4211219



1x  
4538724



6x  
6006740



2x  
4211311



4x  
4507833



2x  
4211363

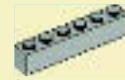

1x  
4211393



2x  
4641682



15x  
4211412



1x  
4211440



8x  
4521921



2x  
4224592



5x  
4211398



4x  
4211451

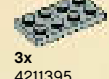

3x  
4211395



2x  
4211452



4x  
4632575



2x  
4611702



6x  
4654582



5x  
4556157



1x  
4211568



2x  
4211413



2x  
4262978



2x  
4211525



1x  
4580598



2x  
4599496



1x  
4539481



2x  
4211461



2x  
6011459



2x  
4211713

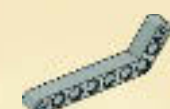

2x  
4211624



5x  
4560175



4x  
4211375



8x  
4211815

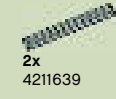

2x  
4211639



8x  
4211104



3x  
4211085



5x  
4497253



1x  
4513326



2x  
4622338



14x  
4213607



6x  
4211096



2x  
4211064



1x  
4225873



1x  
6008667



2x  
4180486



2x  
4211063



3x  
4211001



1x  
4211056



4x  
4539429



1x  
4211115



1x  
4211061



2x  
4180811



1x  
4161674



1x  
4211067



2x  
4211069



2x  
4587212



4x  
4210763



1x  
4620079



4x  
6000606



10x  
4521187



1x  
4210882



4x  
4217558



3x  
4271344



22x  
4210633



4x  
4278274



4x  
4223981



2x  
4210897



1x  
4210844



1x  
4626645



1x  
6001668



4x  
6006408



4x  
4264952



4x  
4498096



4x  
4265486



2x  
4210656



2x  
4598409



2x  
4508553



3x  
4523157



1x  
4600267



5x  
4649896



1x  
4626501



3x  
4640843



1x  
4600528



1x  
4600519



1x  
4614404



6x  
4618195



1x  
4611904



2x  
4654026



1x  
4600501



2x  
4648296



3x  
4623775



10x  
4518687



4x  
4566688



4x  
4657347



1x  
4549898



1x  
4583979



2x  
4651535



1x  
4646815



2x  
4612901



1x  
4617190



4x  
4609595



1x  
4646806



1x  
4646870



1x  
4646817



1x  
4650750



1x  
4652114



1x  
4647632



10x  
4529685



1x  
4654448

Customer Service  
Kundenservice  
Service Consommateurs  
Servicio Al Consumidor

[www.lego.com/service](http://www.lego.com/service) or dial



: 00800 5346 5555

: 1-800-422-5346



# WIN!

Go to [www.LEGOsurvey.com/product](http://www.LEGOsurvey.com/product) to fill out a survey for a chance to win a cool LEGO® Product.

No purchase necessary.

Open to all residents where not prohibited.



[www.LEGO.com](http://www.LEGO.com)



## [www.LEGOsurvey.com/product](http://www.LEGOsurvey.com/product)

### GEWINNE!

Nimm an der Umfrage auf [www.LEGOsurvey.com/product](http://www.LEGOsurvey.com/product) teil und hab die Chance ein cooles LEGO® Produkt zu gewinnen!

Die Teilnahme am Gewinnspiel führt zu keinerlei Kaufverpflichtungen. Teilnahme in allen nicht ausgeschlossenen Ländern möglich.

### WIN!

Ga naar [www.LEGOsurvey.com/product](http://www.LEGOsurvey.com/product), vul een enquêteformulier in en maak kans op een cool LEGO® product.

Geen aankoopverplichting. Iedereen mag deelnemen, uitgezonderd ingezetenden van landen waar een enquêteverbod geldt.

### GAGNE!

Visite [www.LEGOsurvey.com/product](http://www.LEGOsurvey.com/product) pour répondre à un questionnaire et avoir une chance de gagner un produit LEGO® très cool!

Aucune obligation d'achat. Ouvert à tous les résidents des pays autorisés.

### 当てよう!

[www.LEGOsurvey.com/product](http://www.LEGOsurvey.com/product) にアクセスして、アンケートにご記入ください。当選者にはレゴ製品を差し上げます。

お買い上げの必要はありません。禁止されていない限り、すべての皆様にご利用いただけます。