

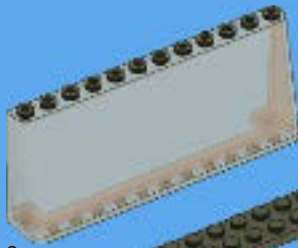

GRAND EMPORIUM
LE GRAND MAGASIN

10211





2x



1x

+

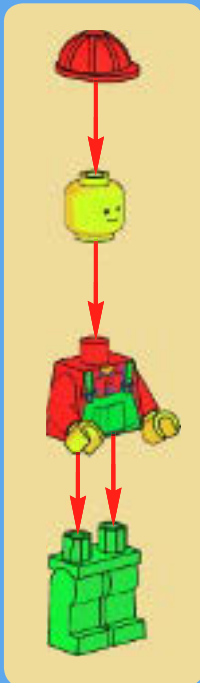

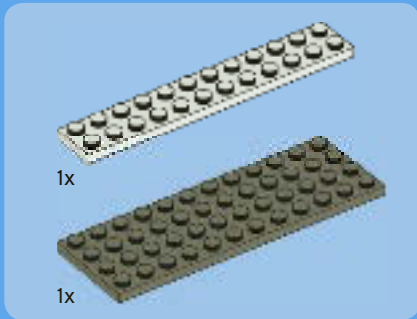
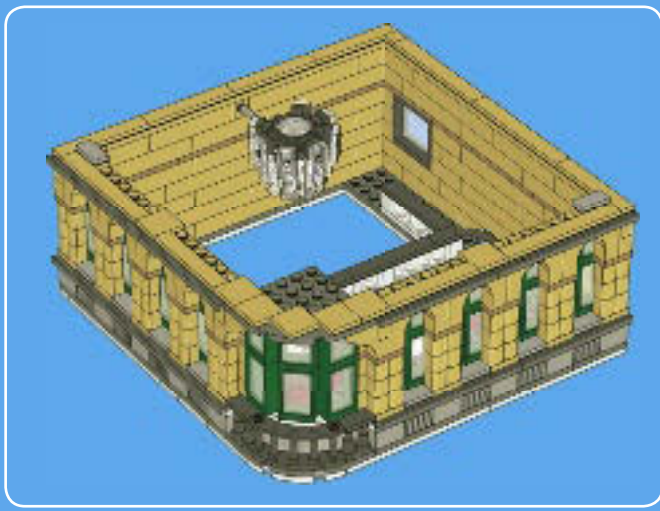

1

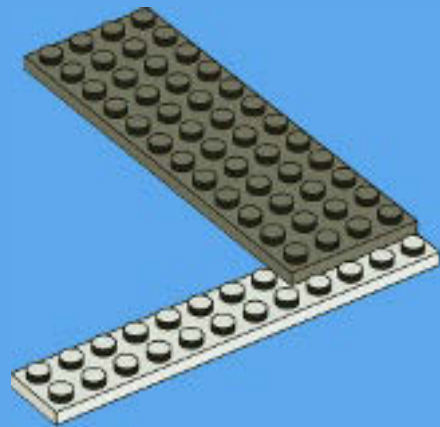

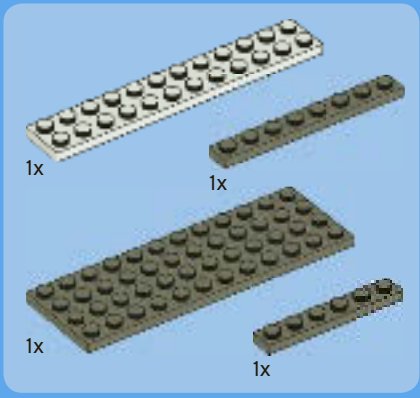

2

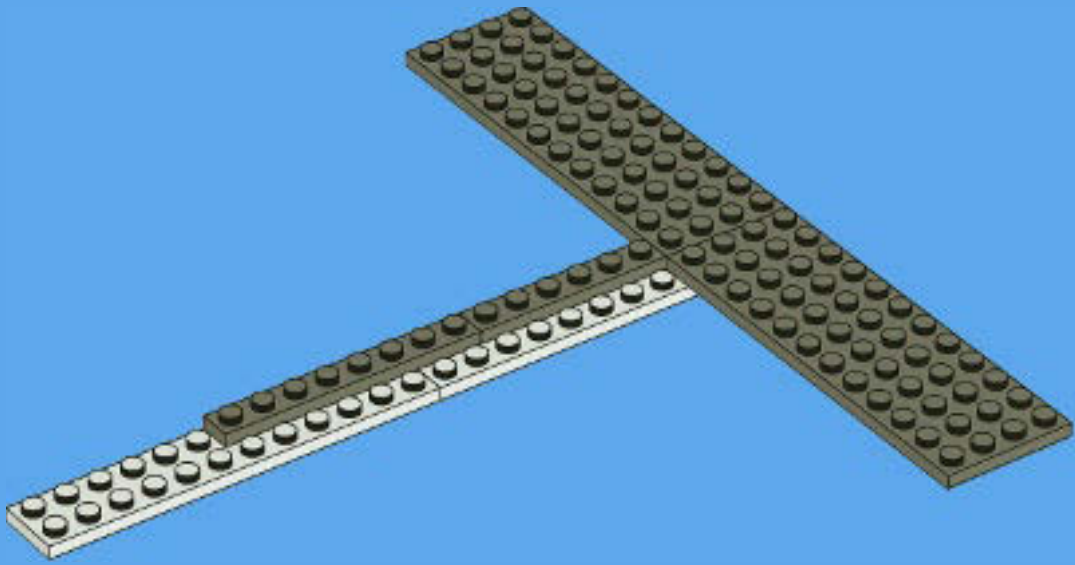

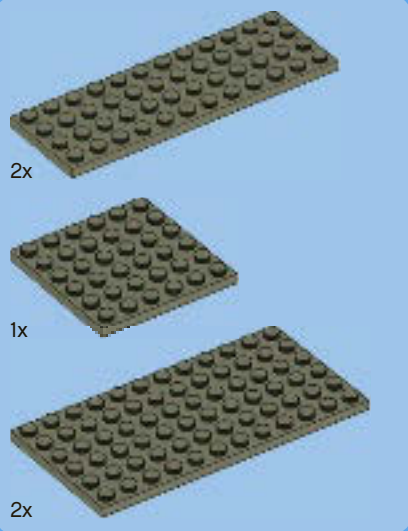

3

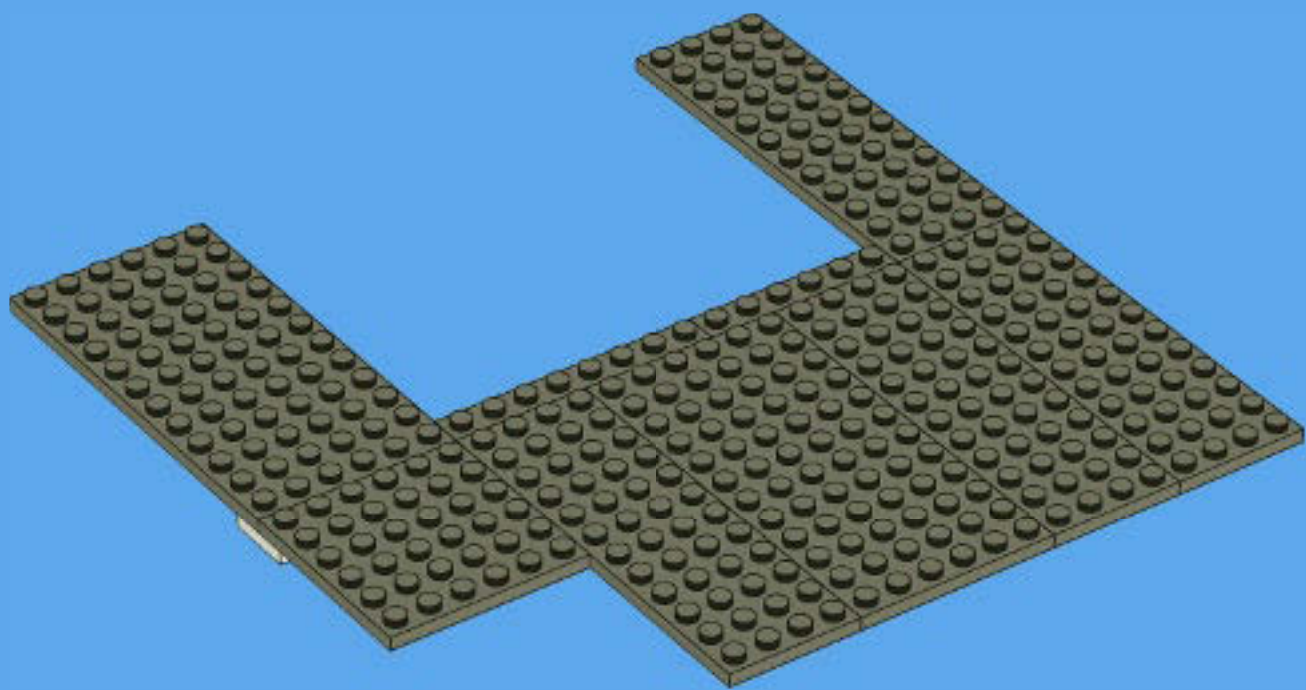

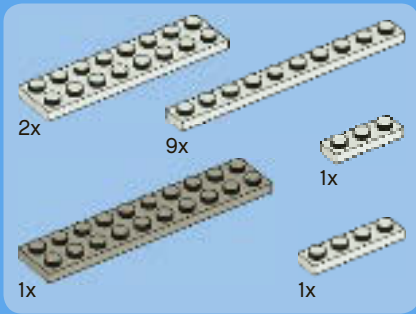

4

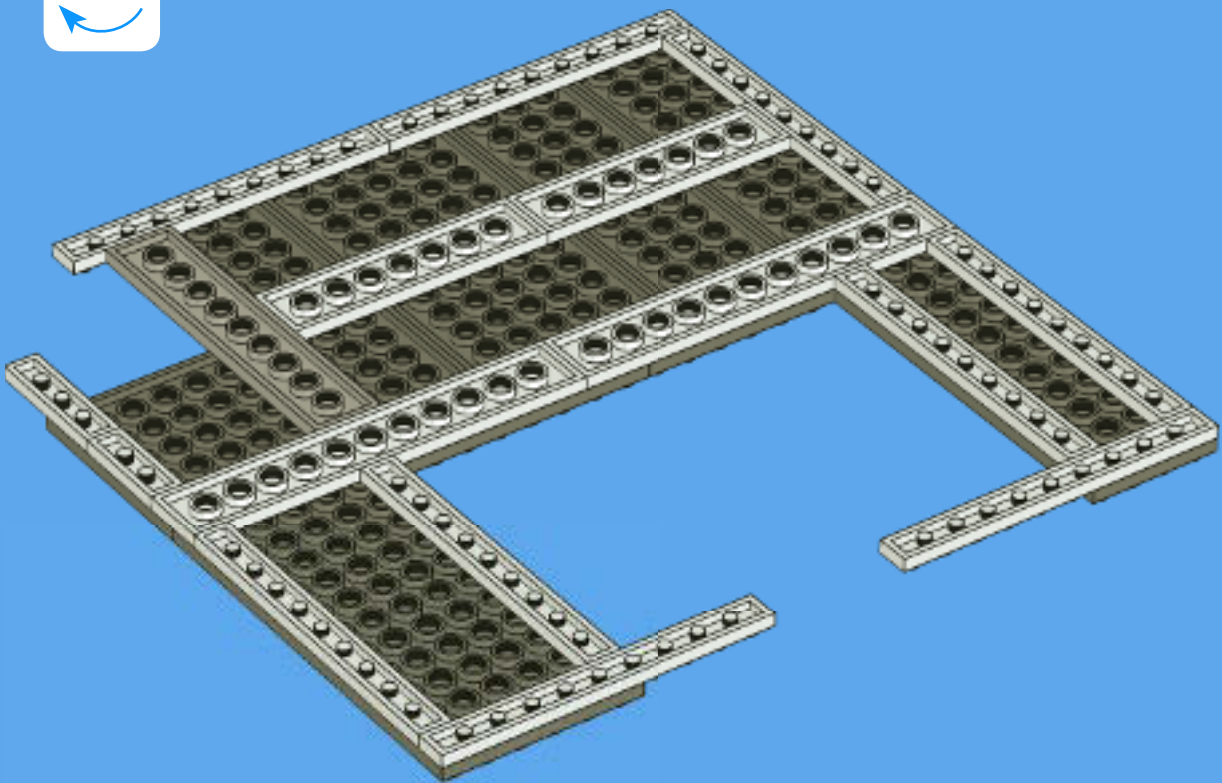

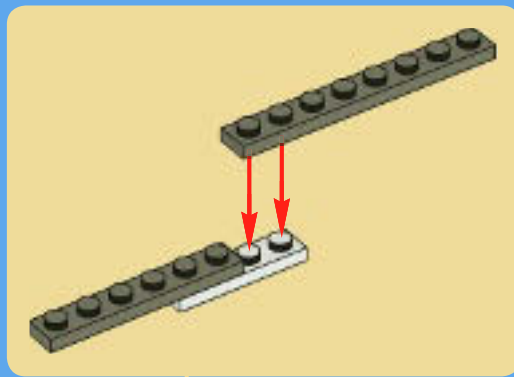
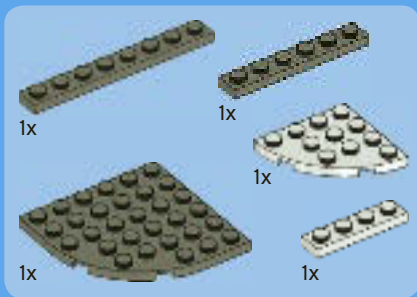

5

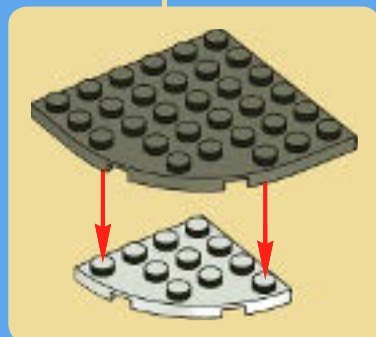
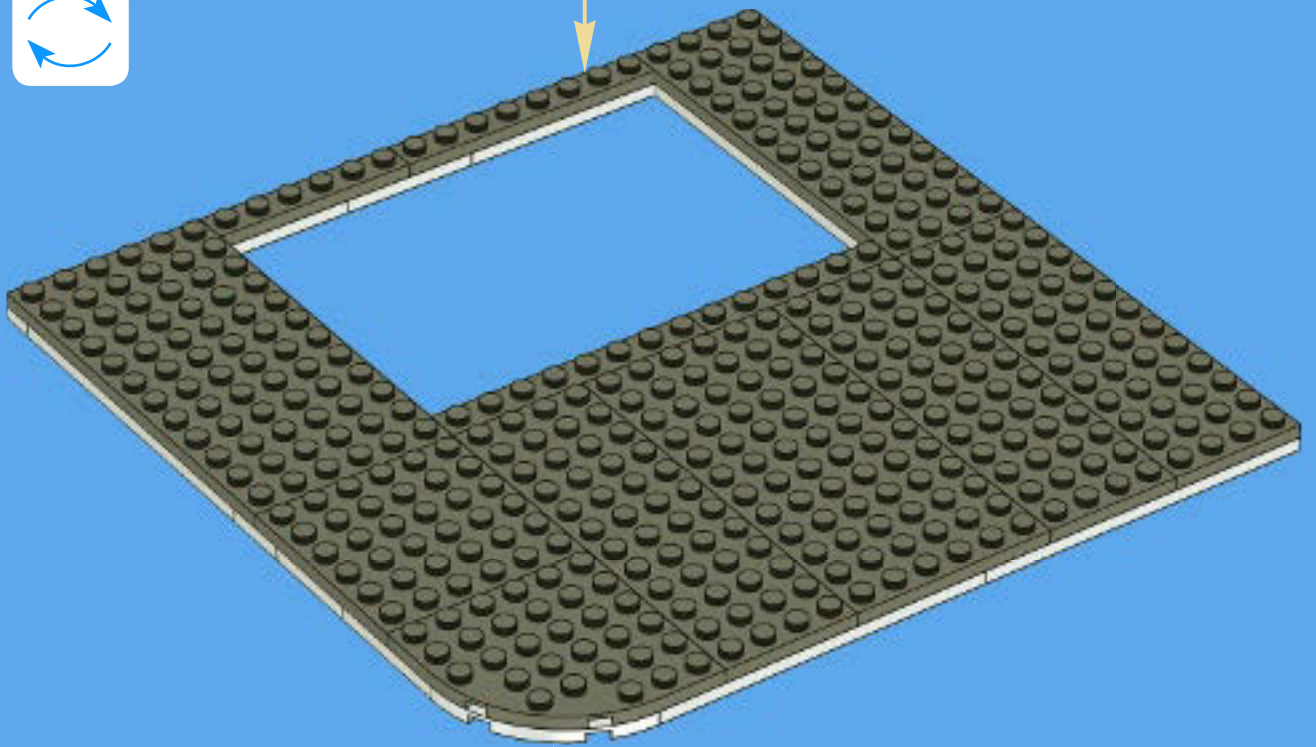

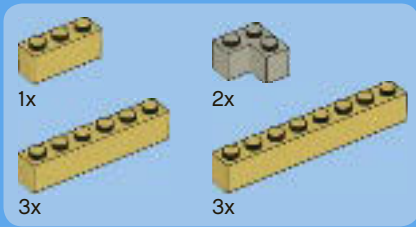

6

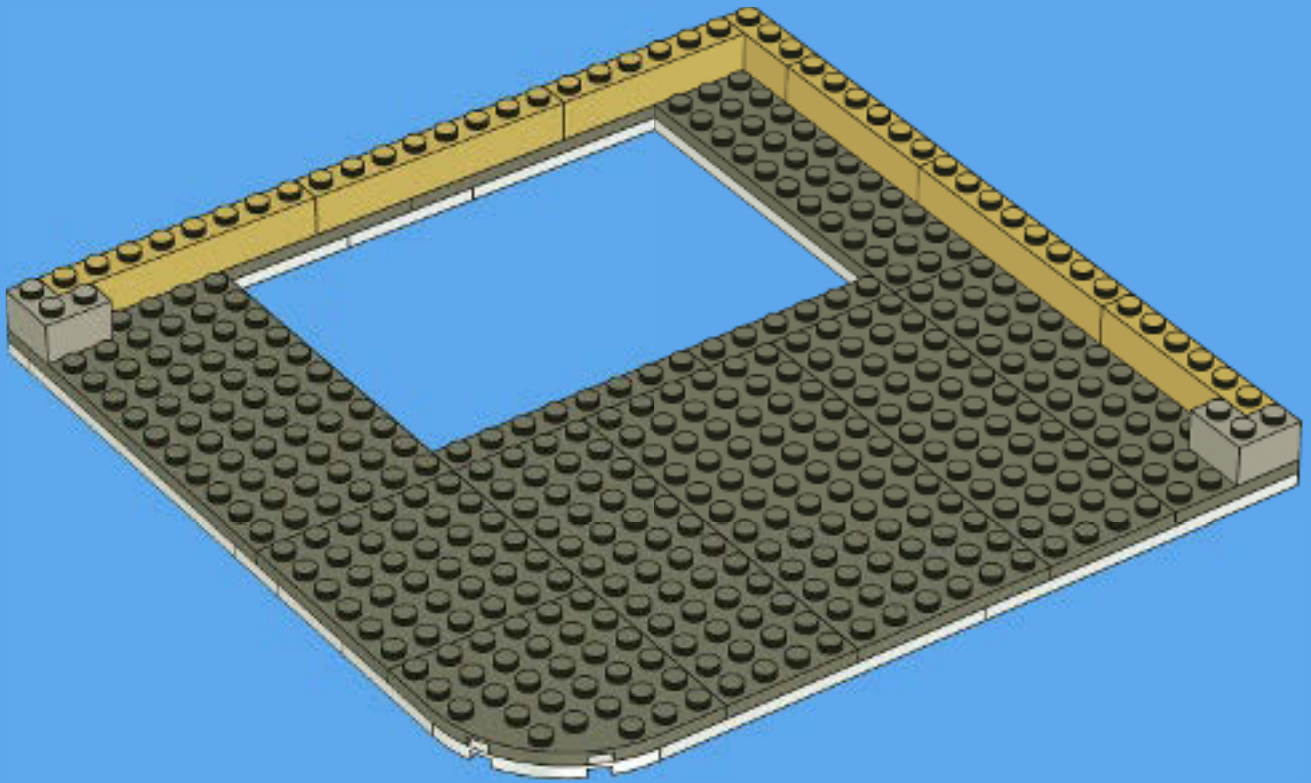

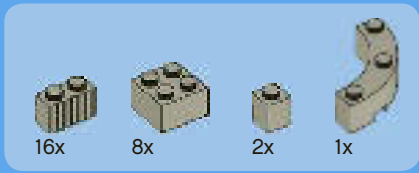

7

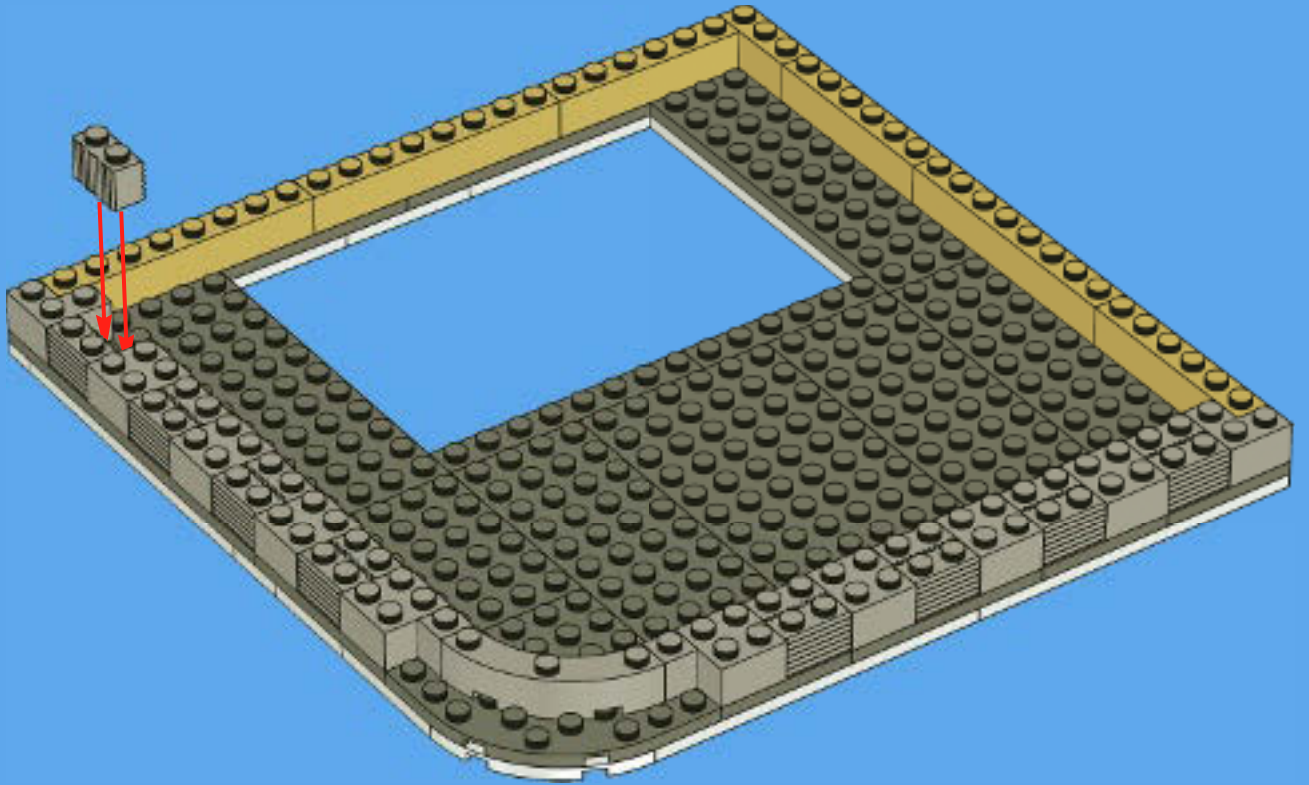

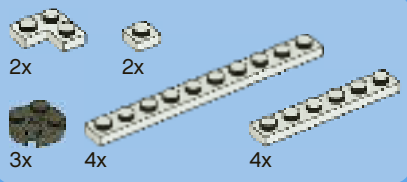

8

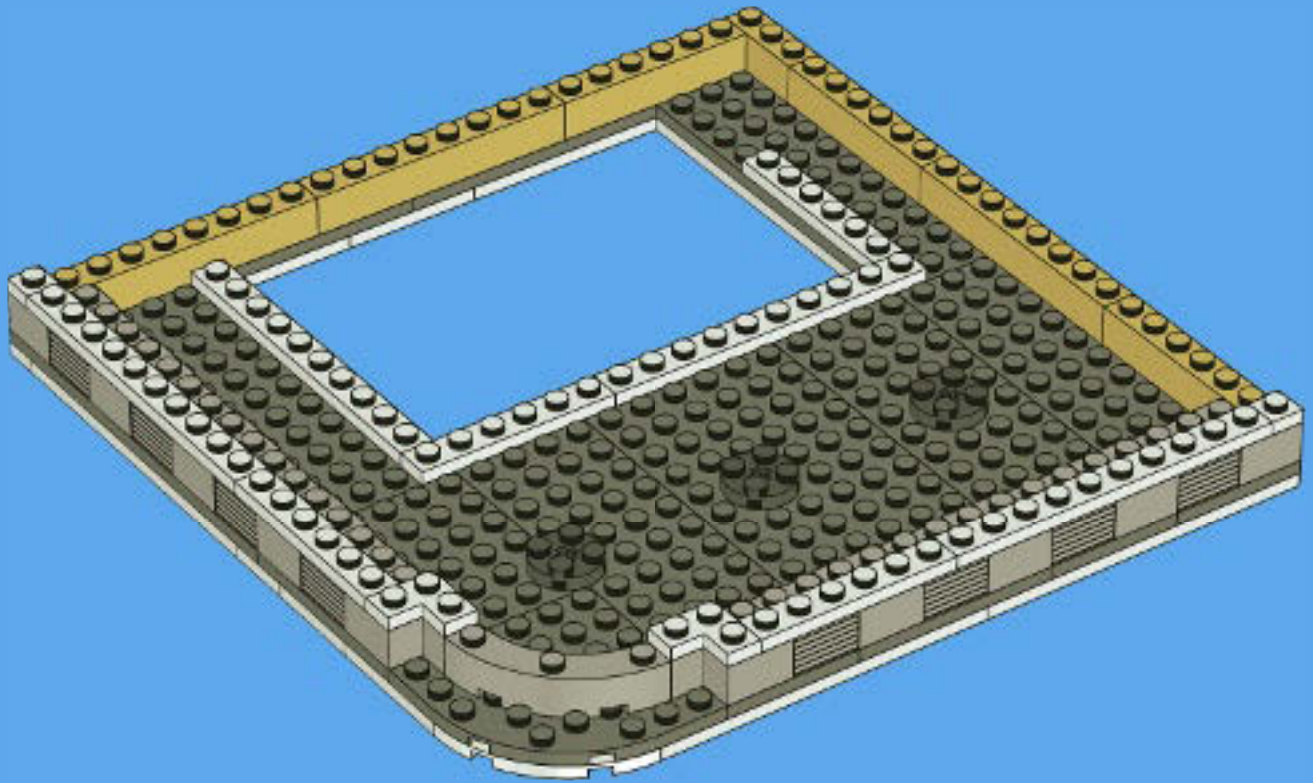

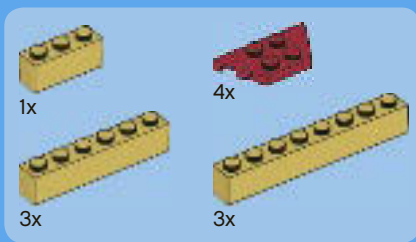

9

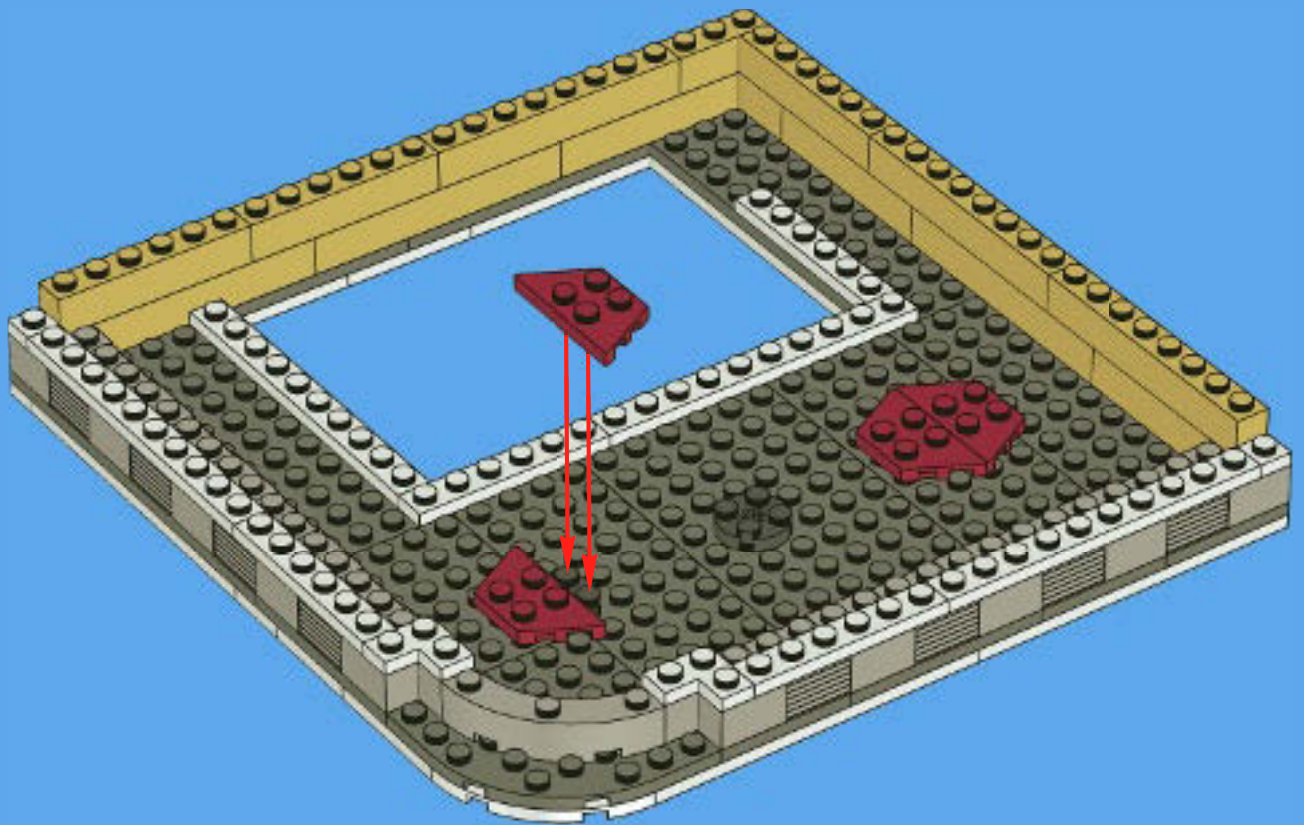

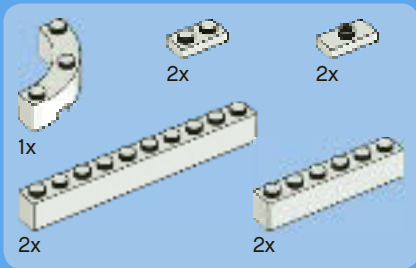

10

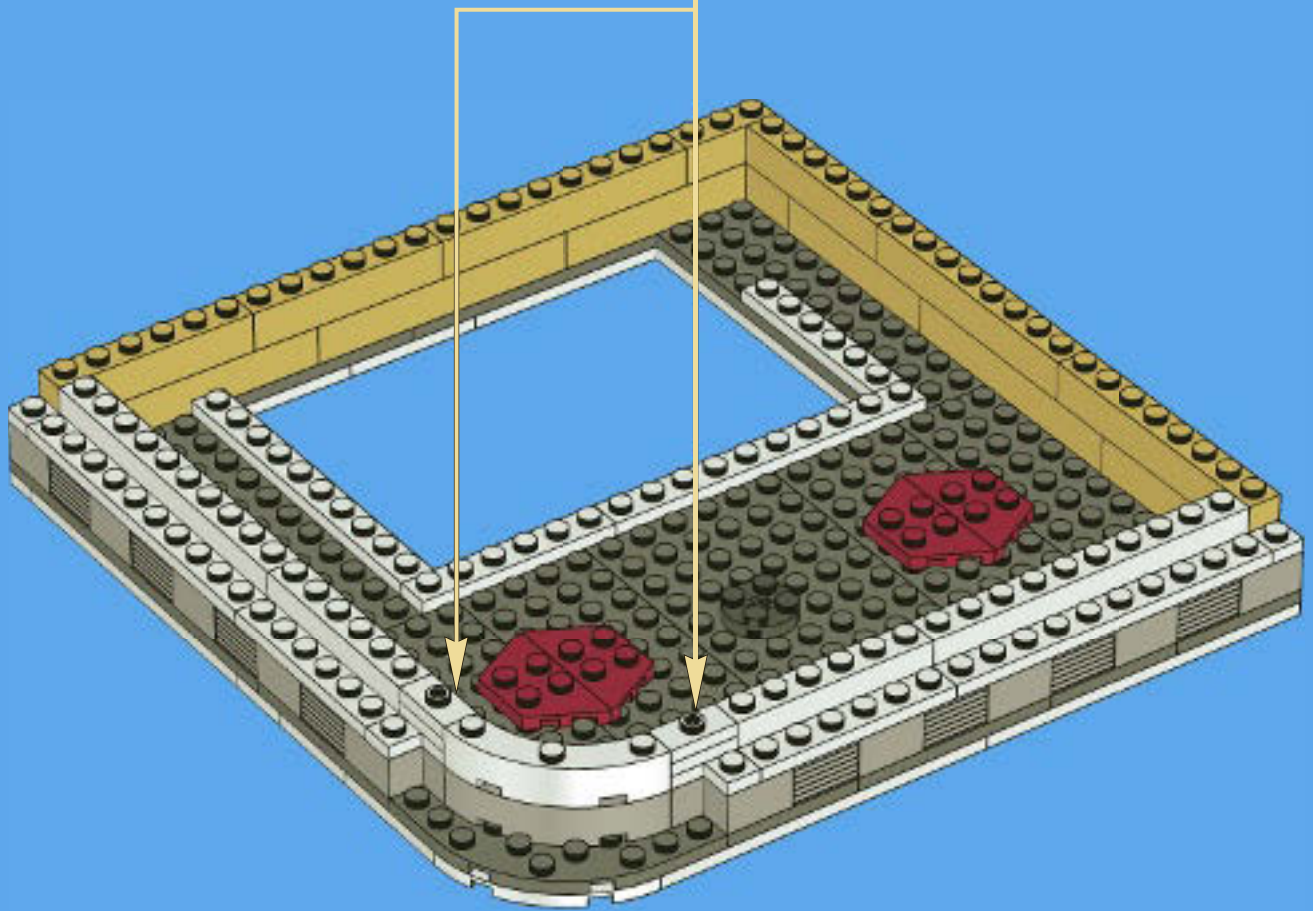
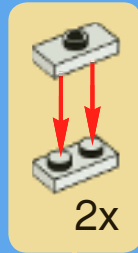



2x



4x



12x



2x

11

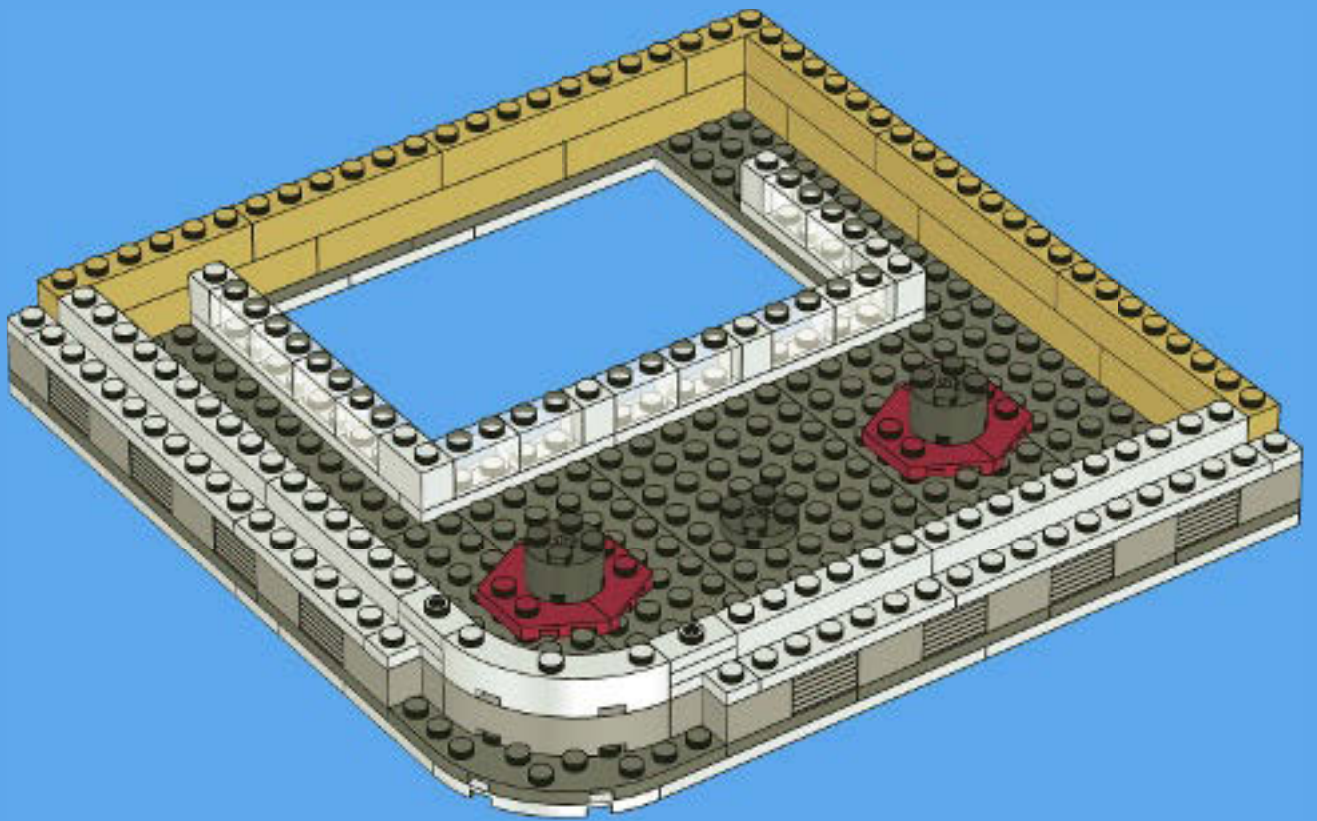

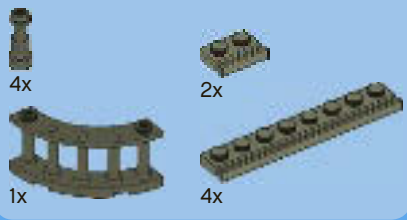

12

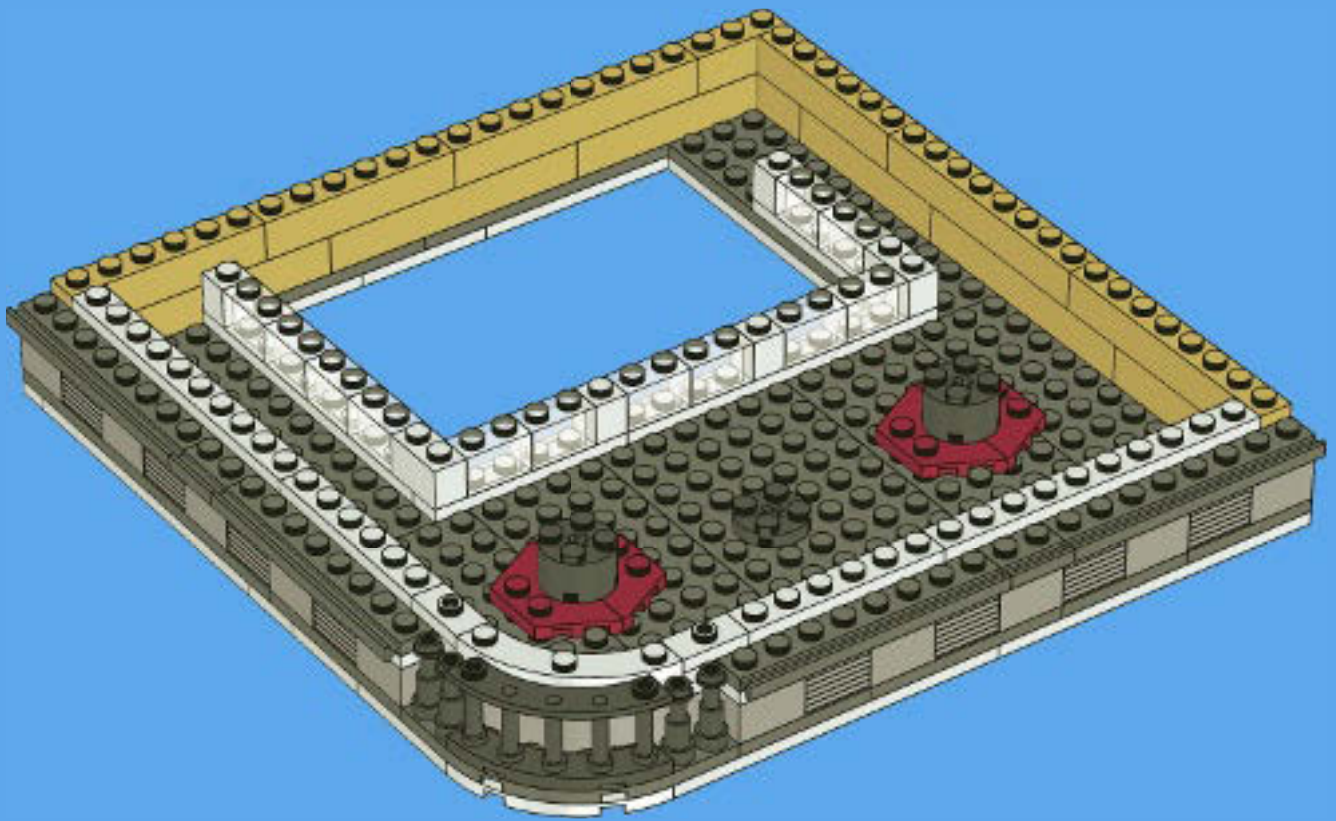

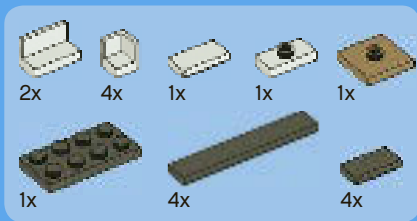

13

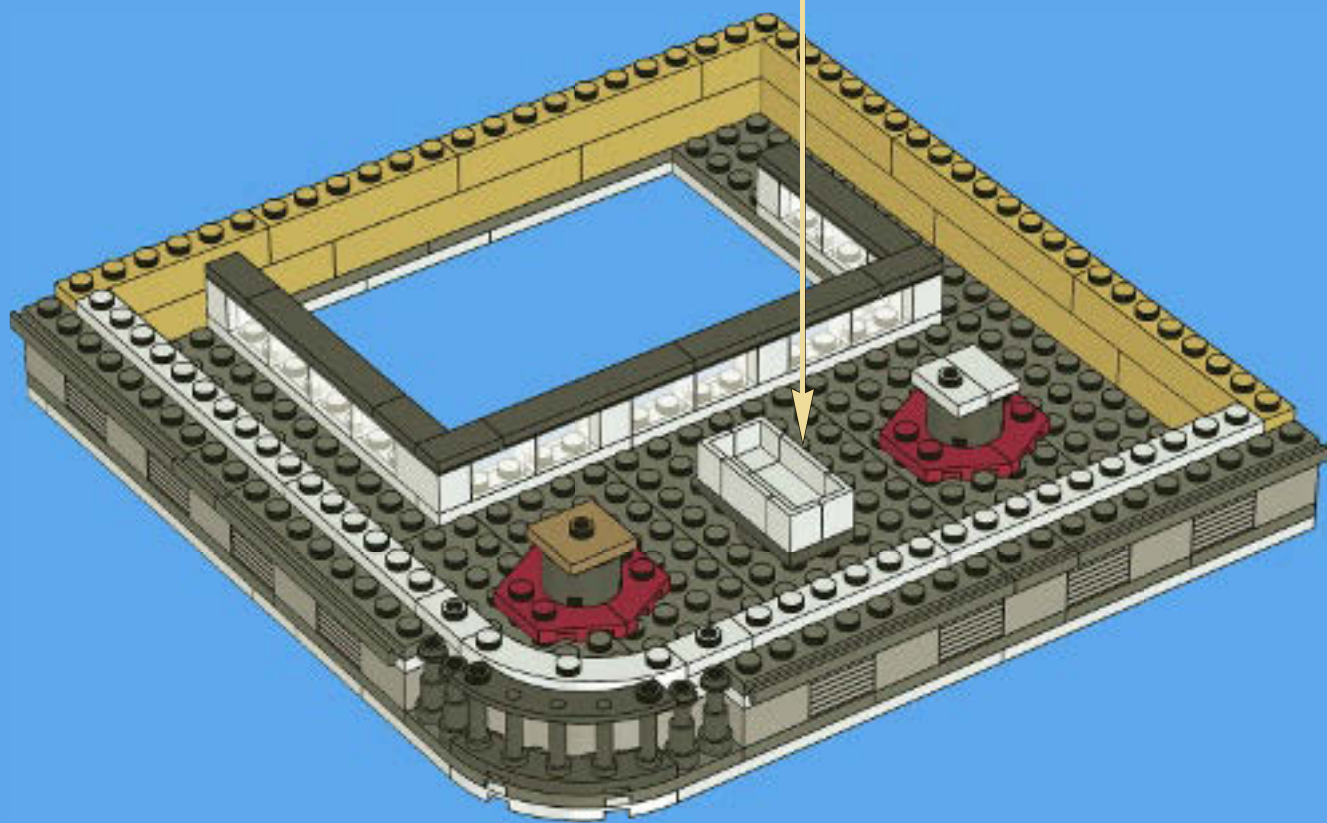
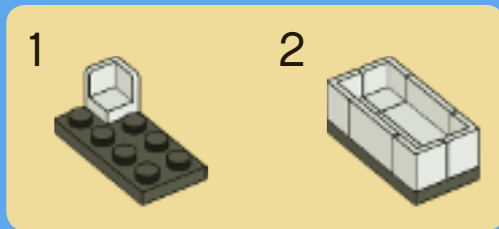



2x



10x



8x

14

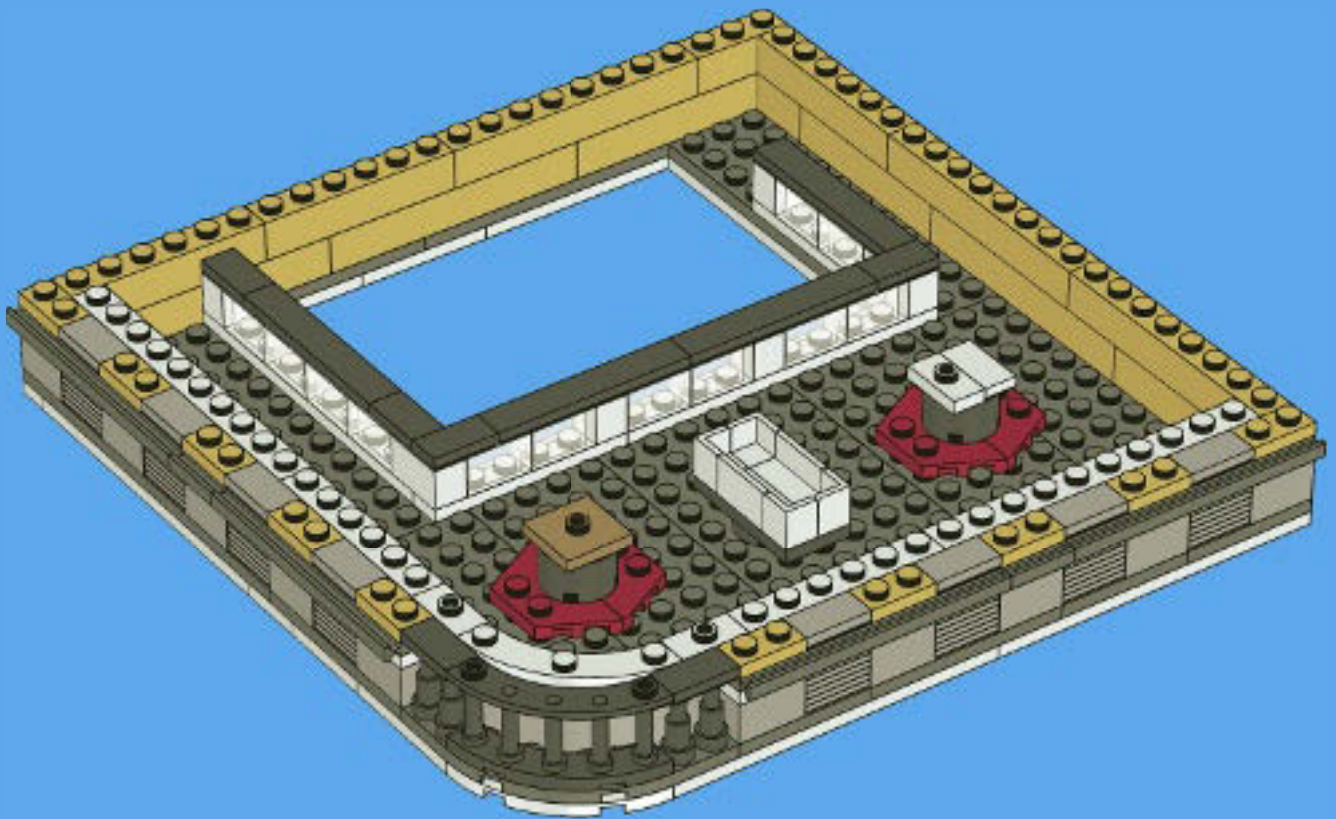

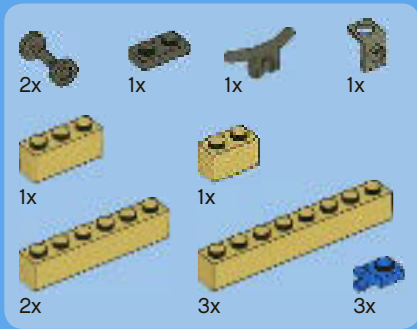

15

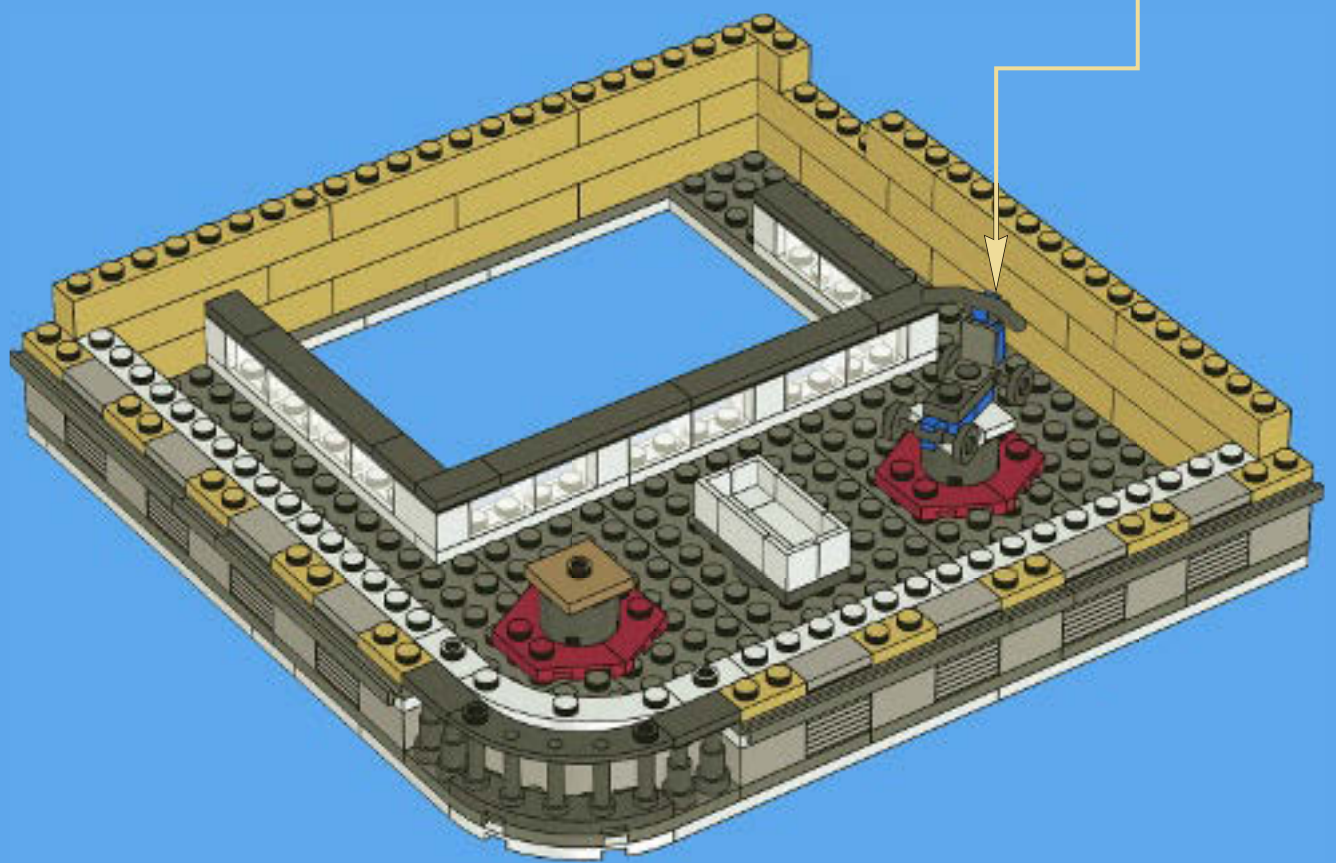
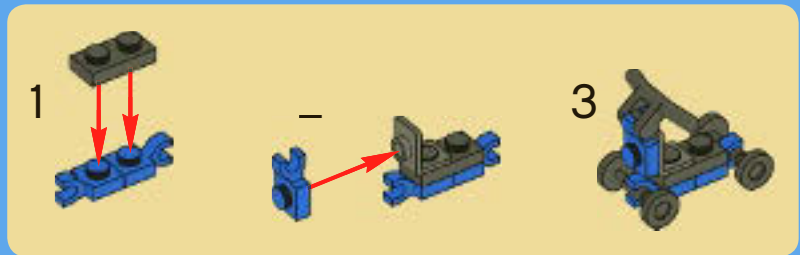



16

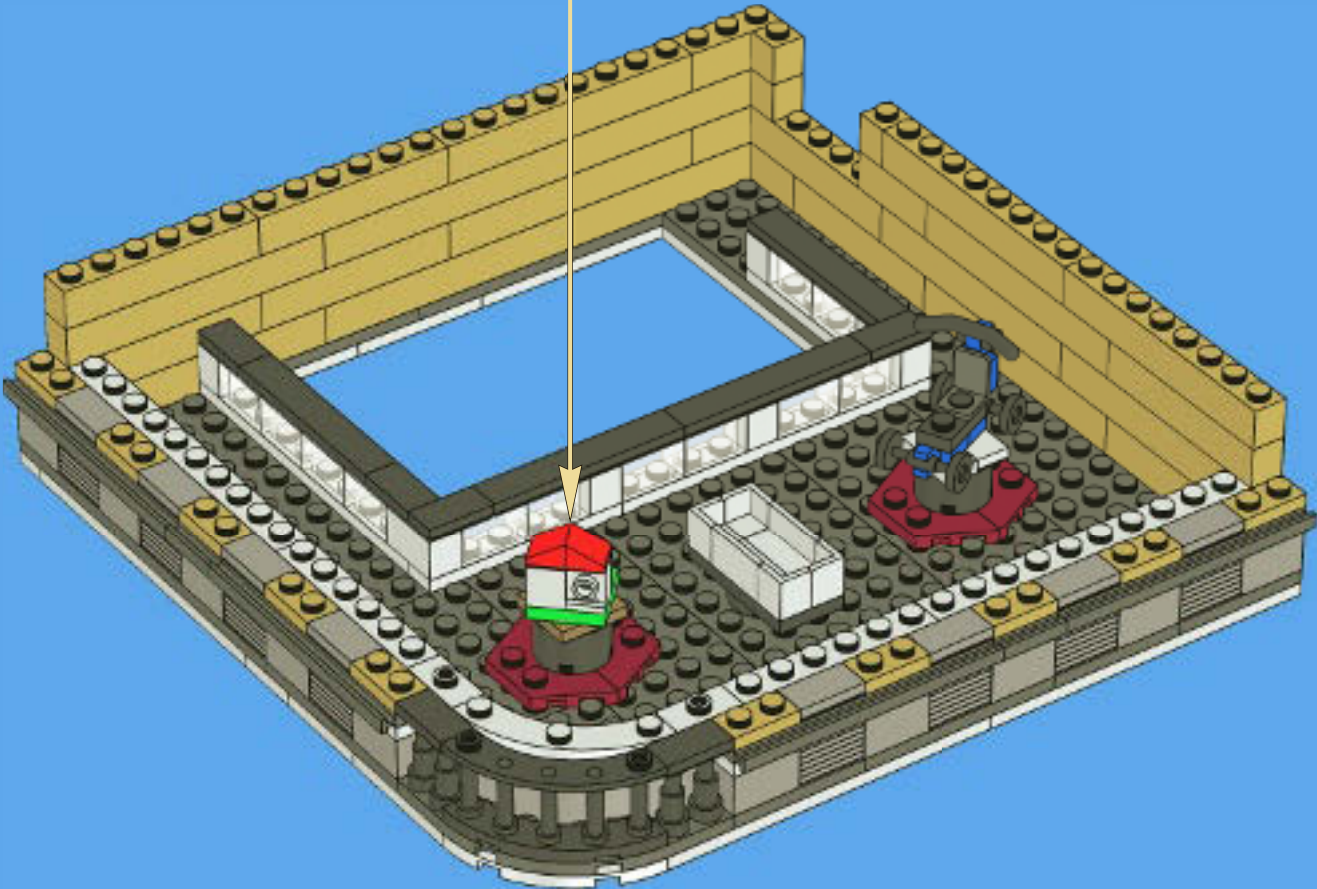

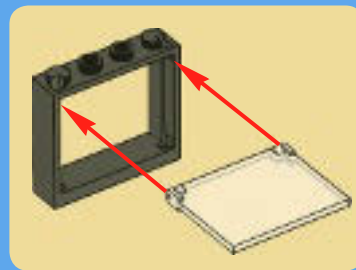
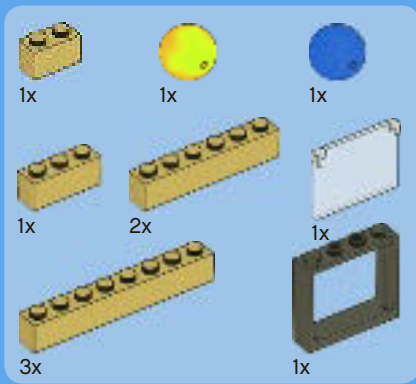

17

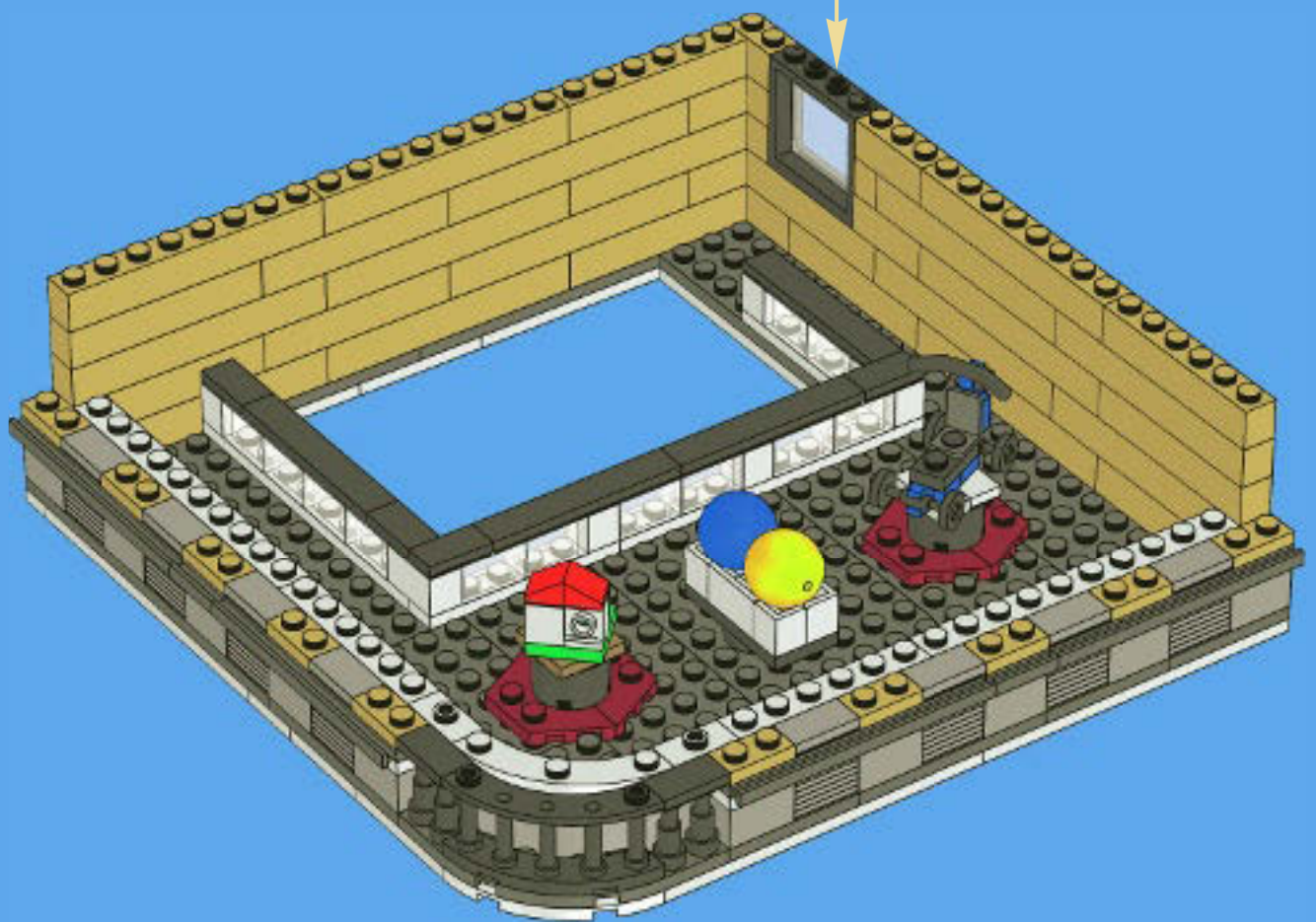



30x

18



10x





28x



3x

19

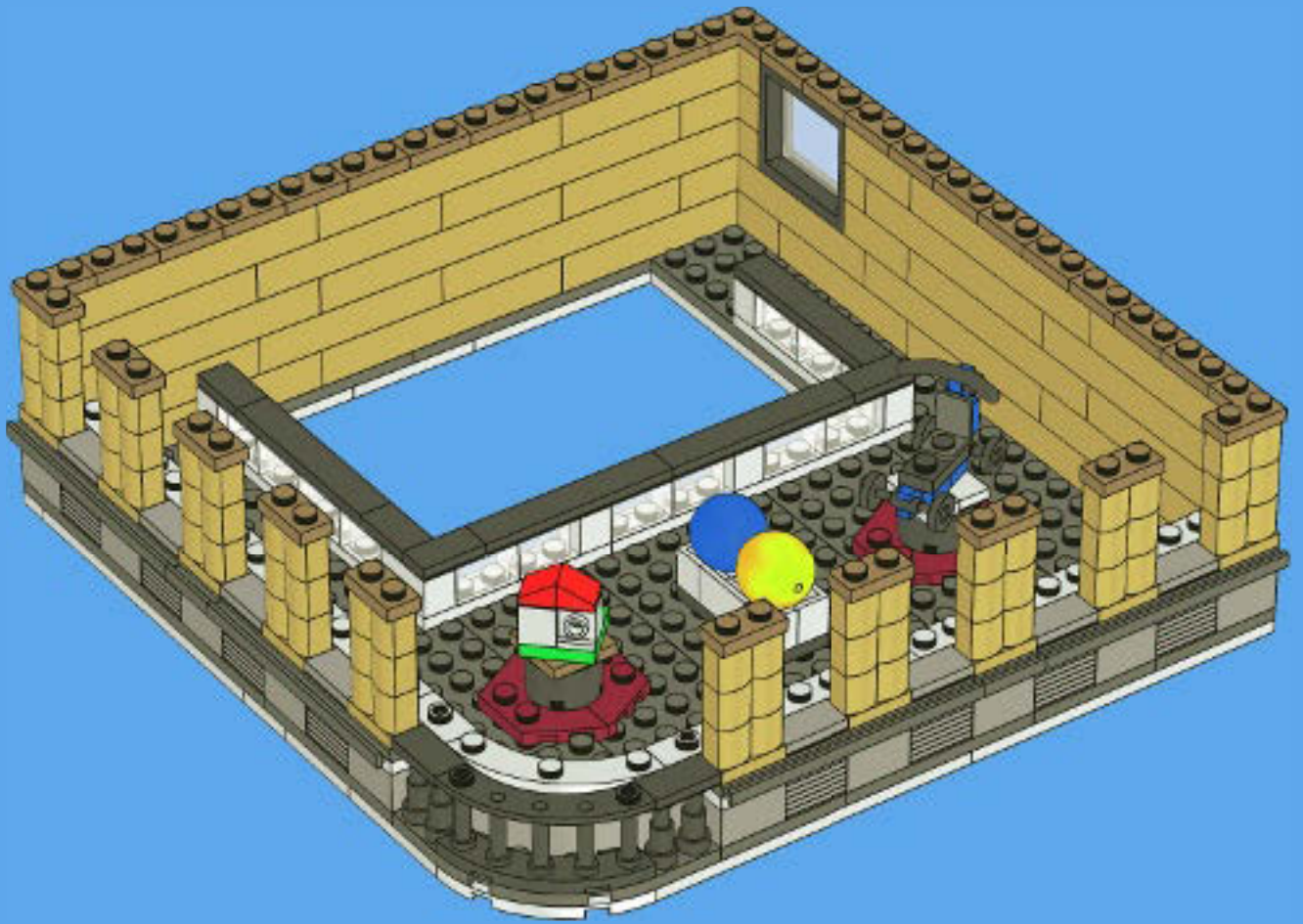

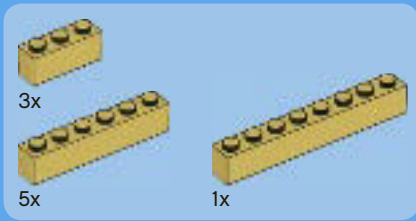

20



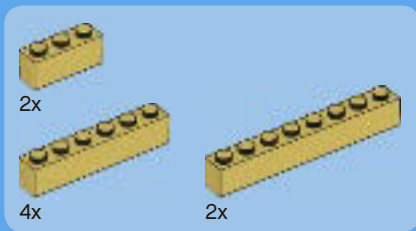

21





22

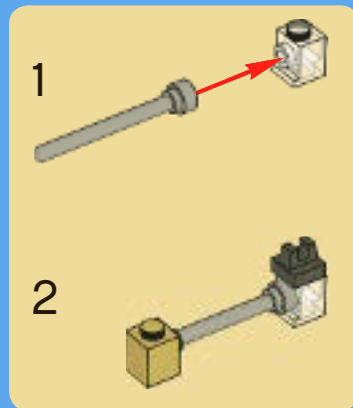
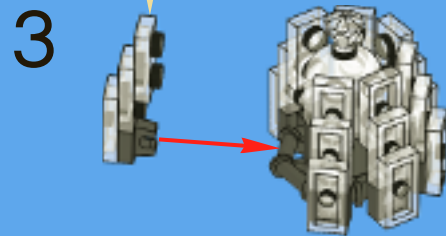
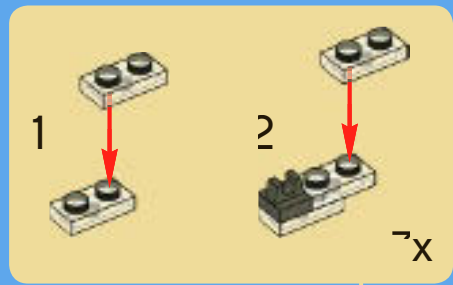
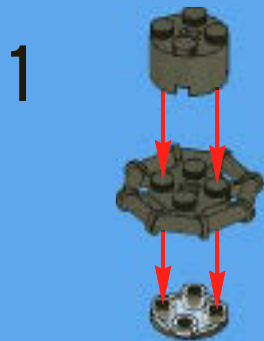





8x



4x



2x

23

1



2



3



4



2x

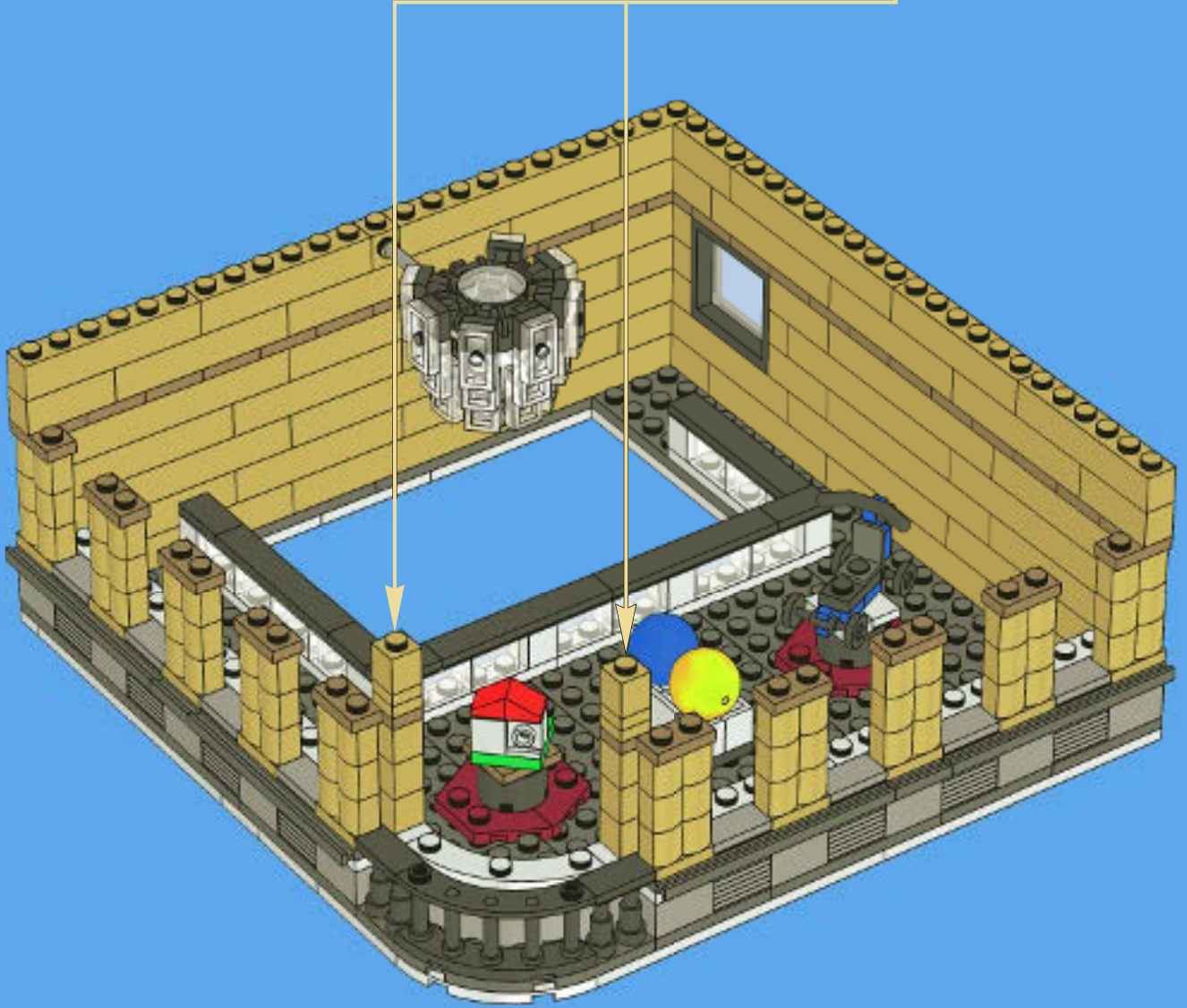

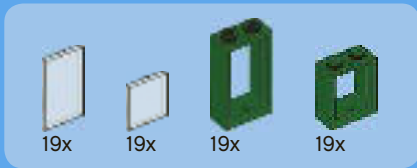

24

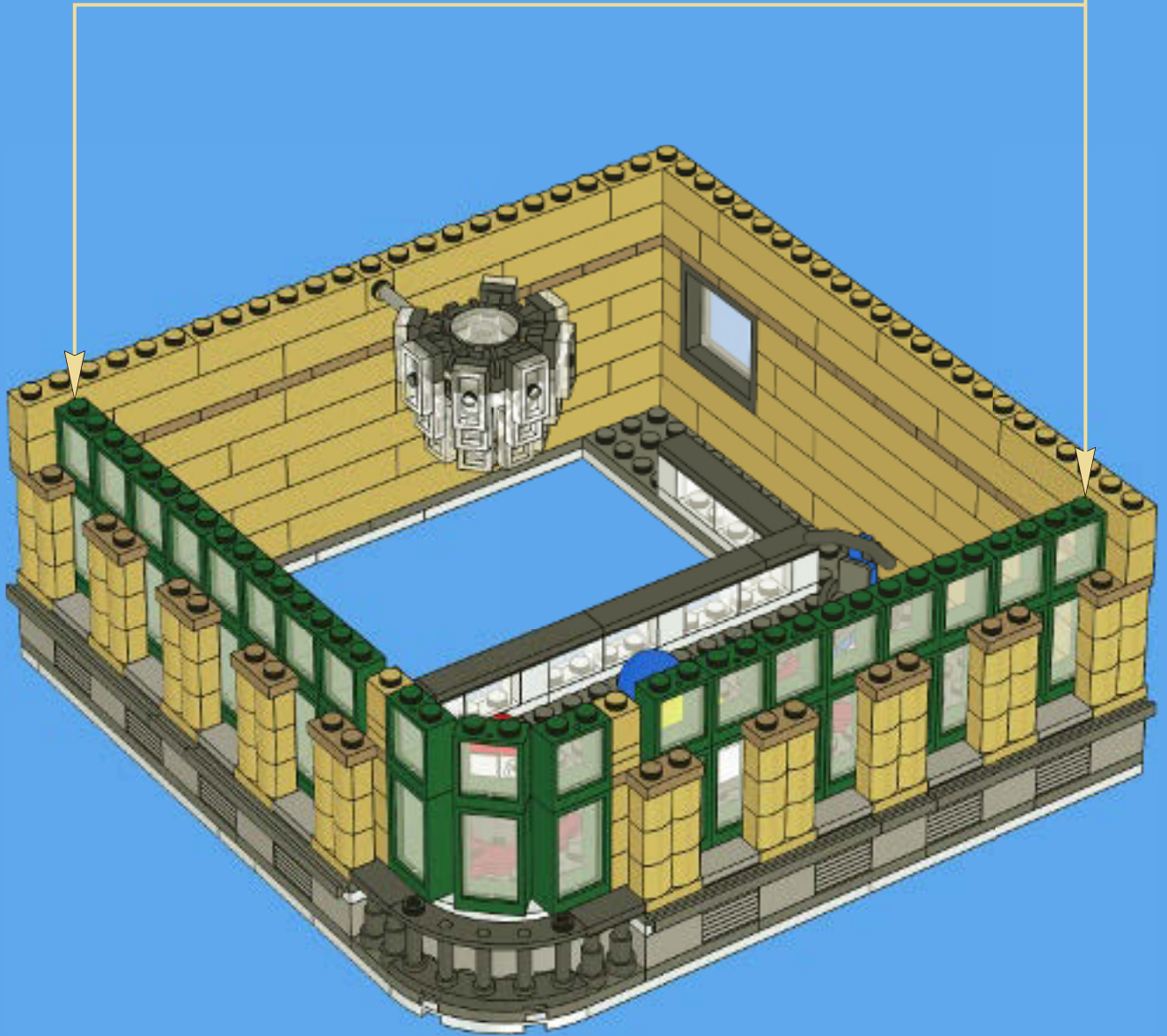
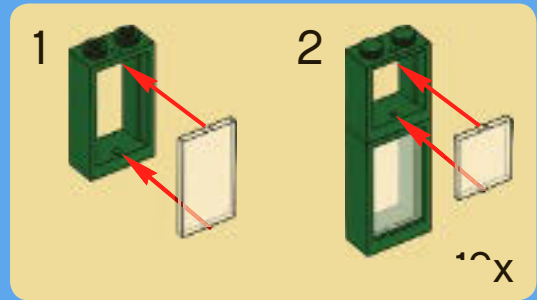

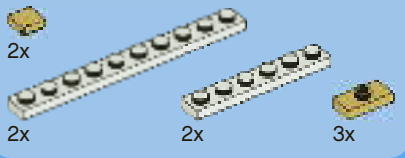

25

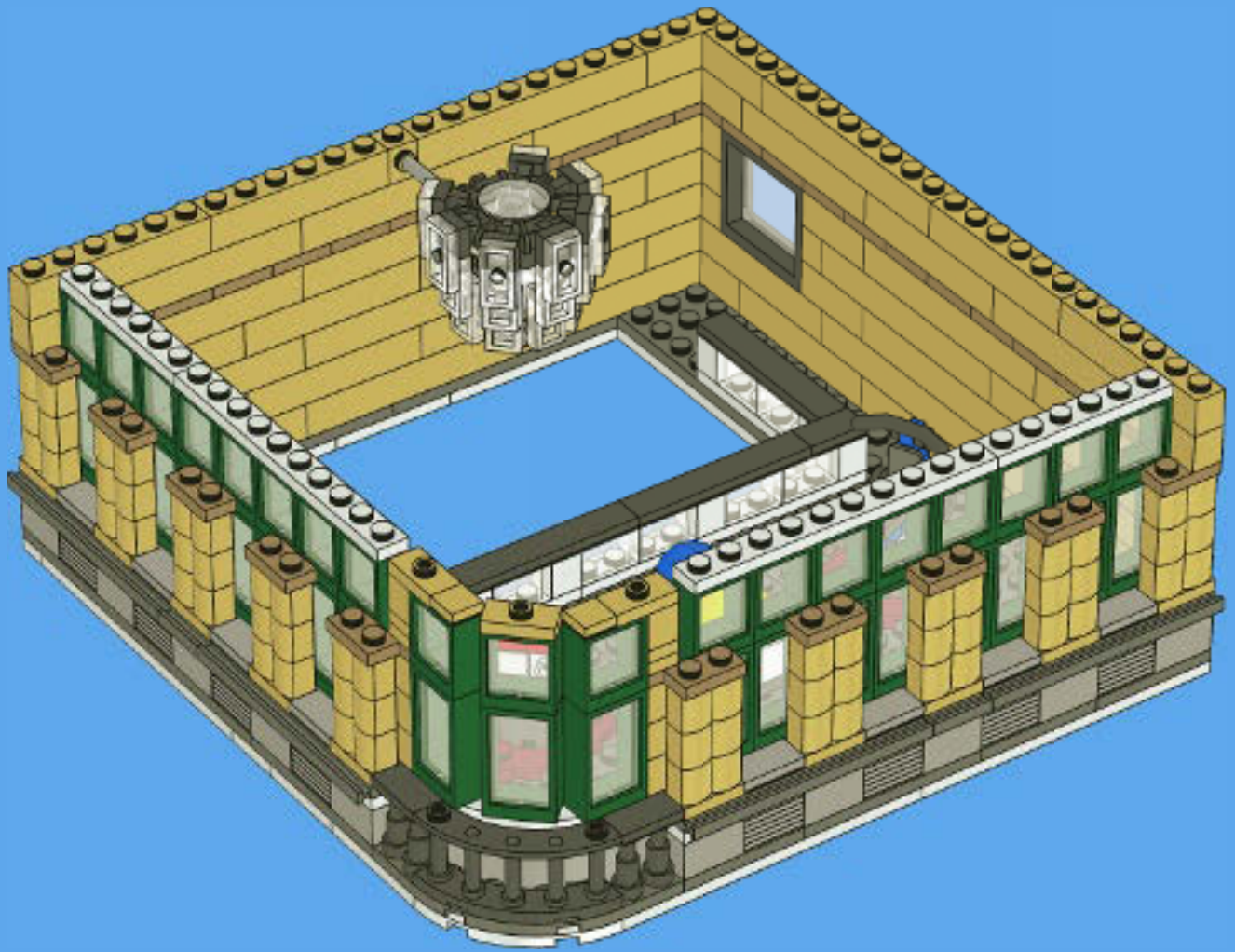

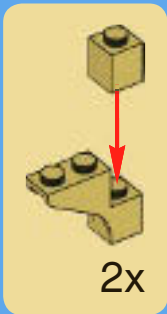

26

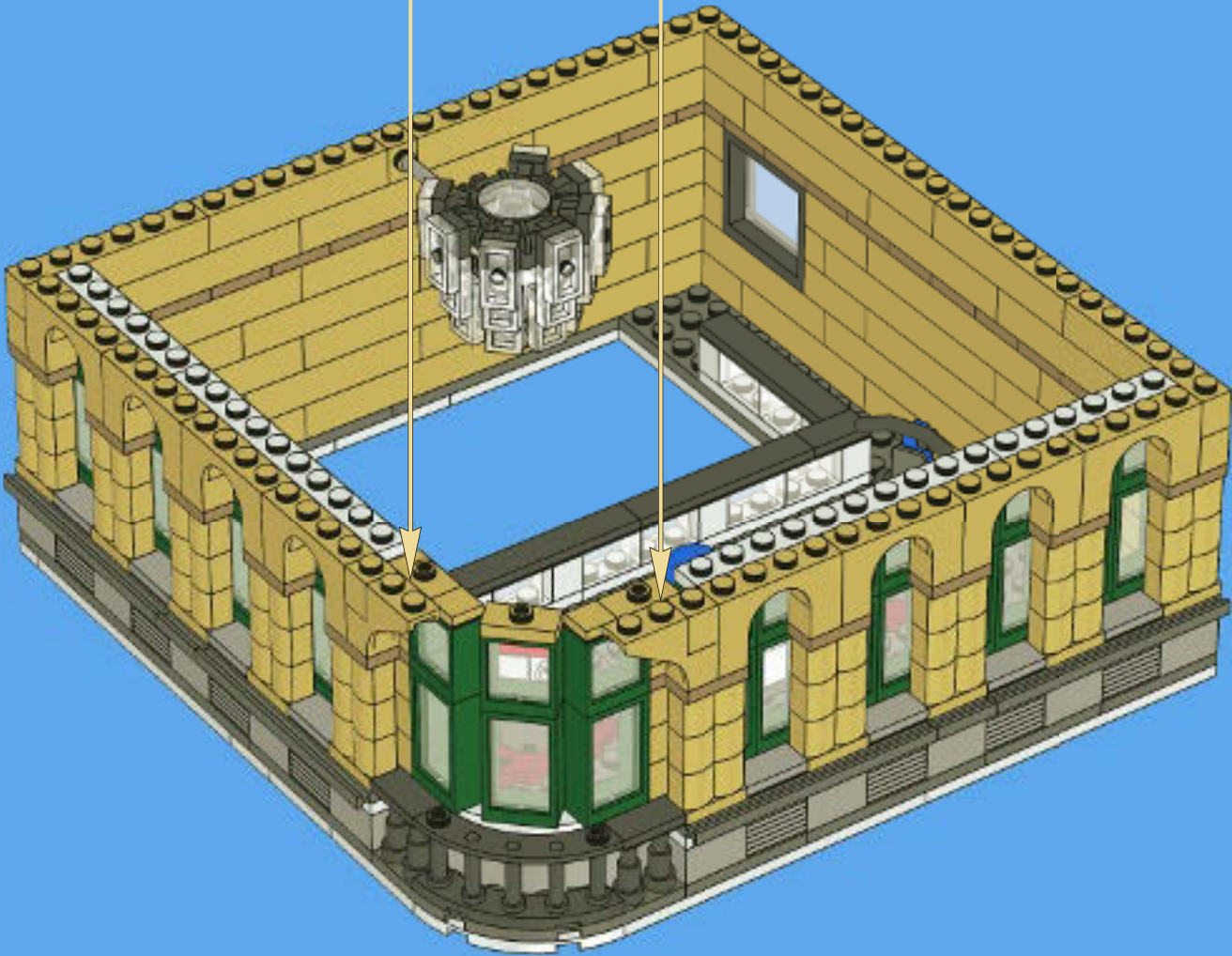



3x



9x



1x

27

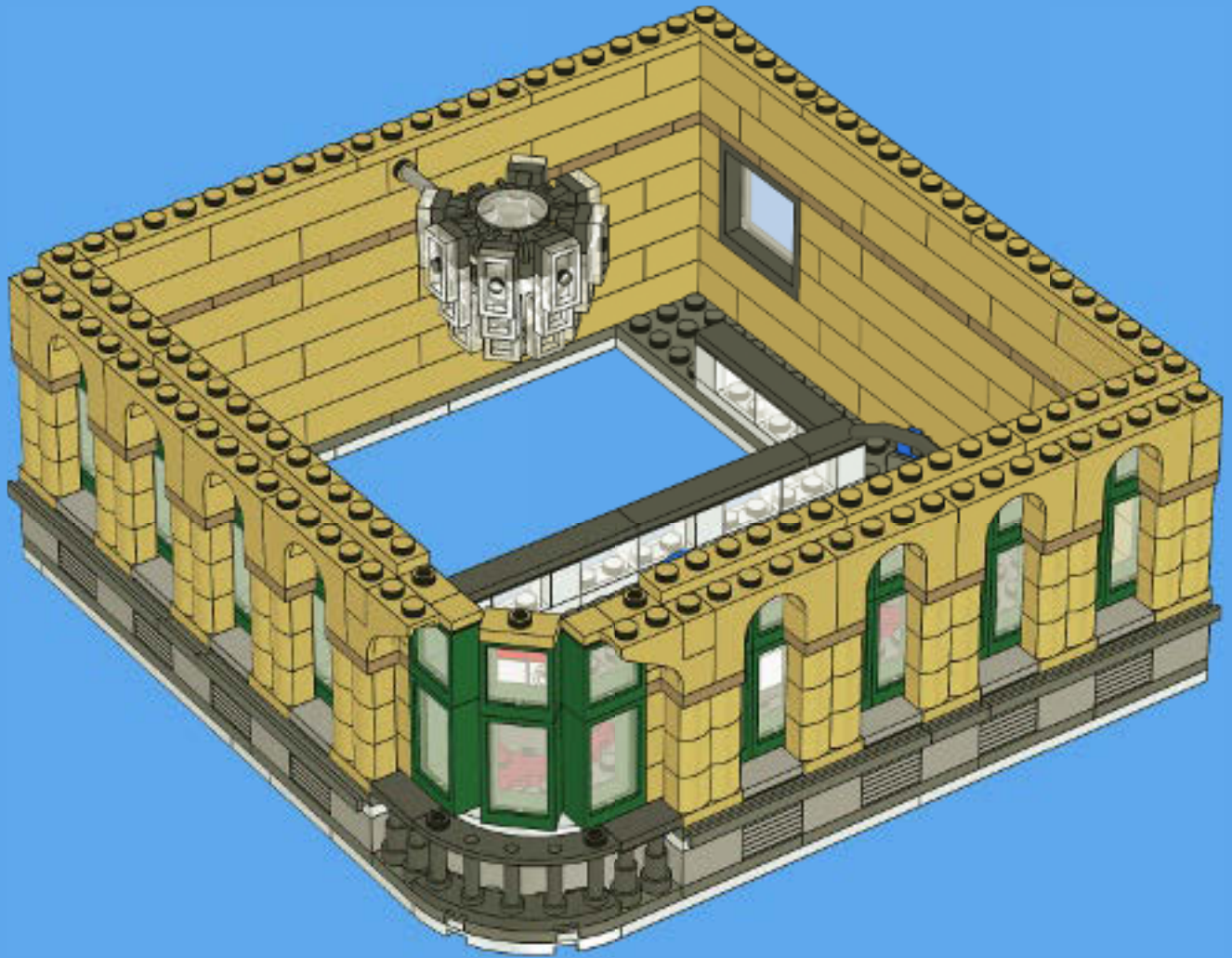

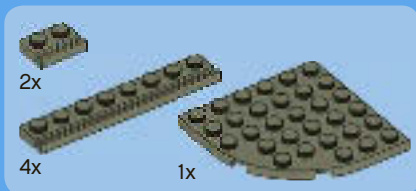

28

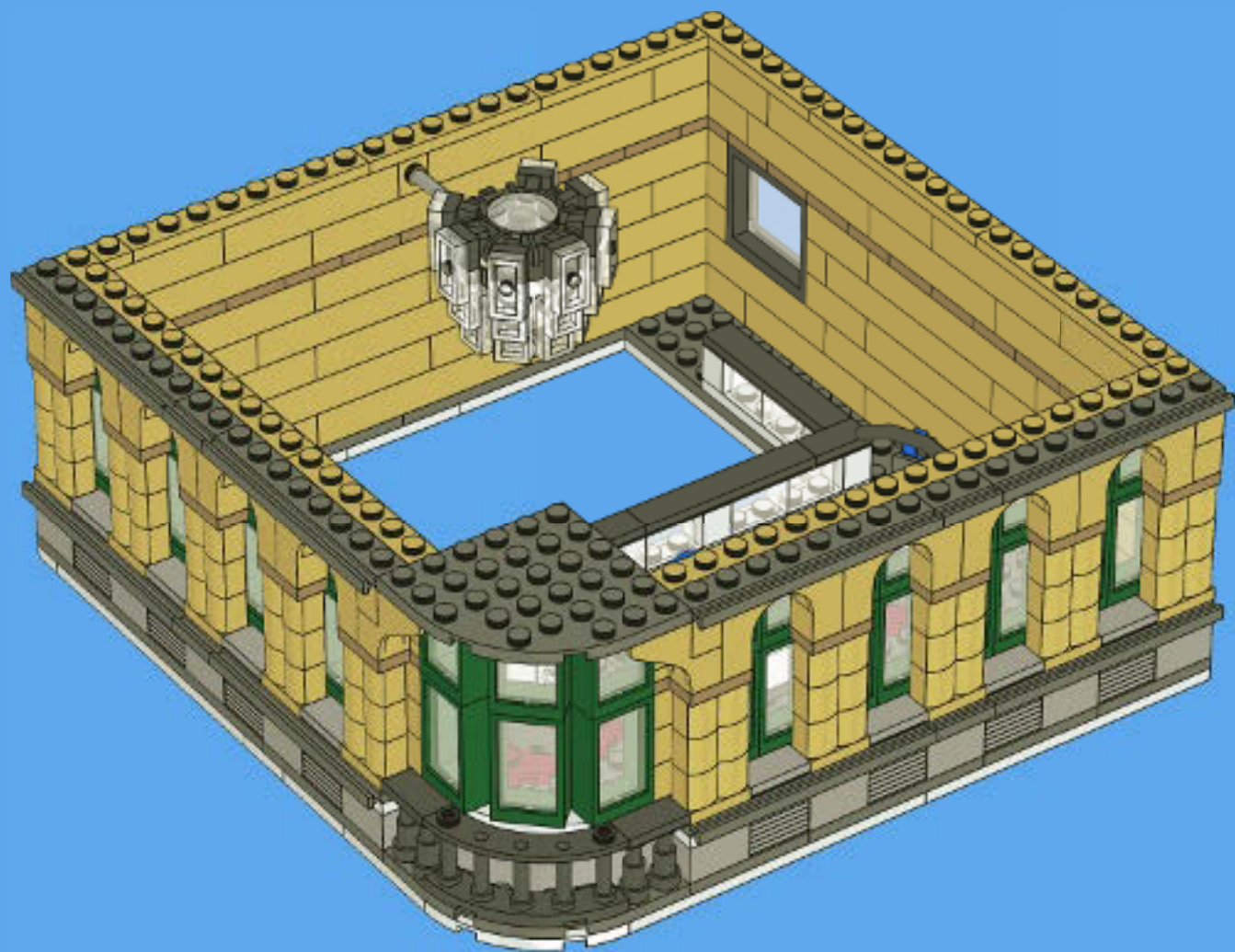

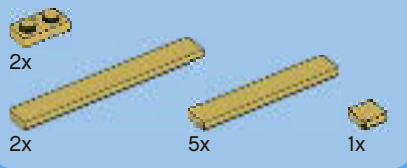

29

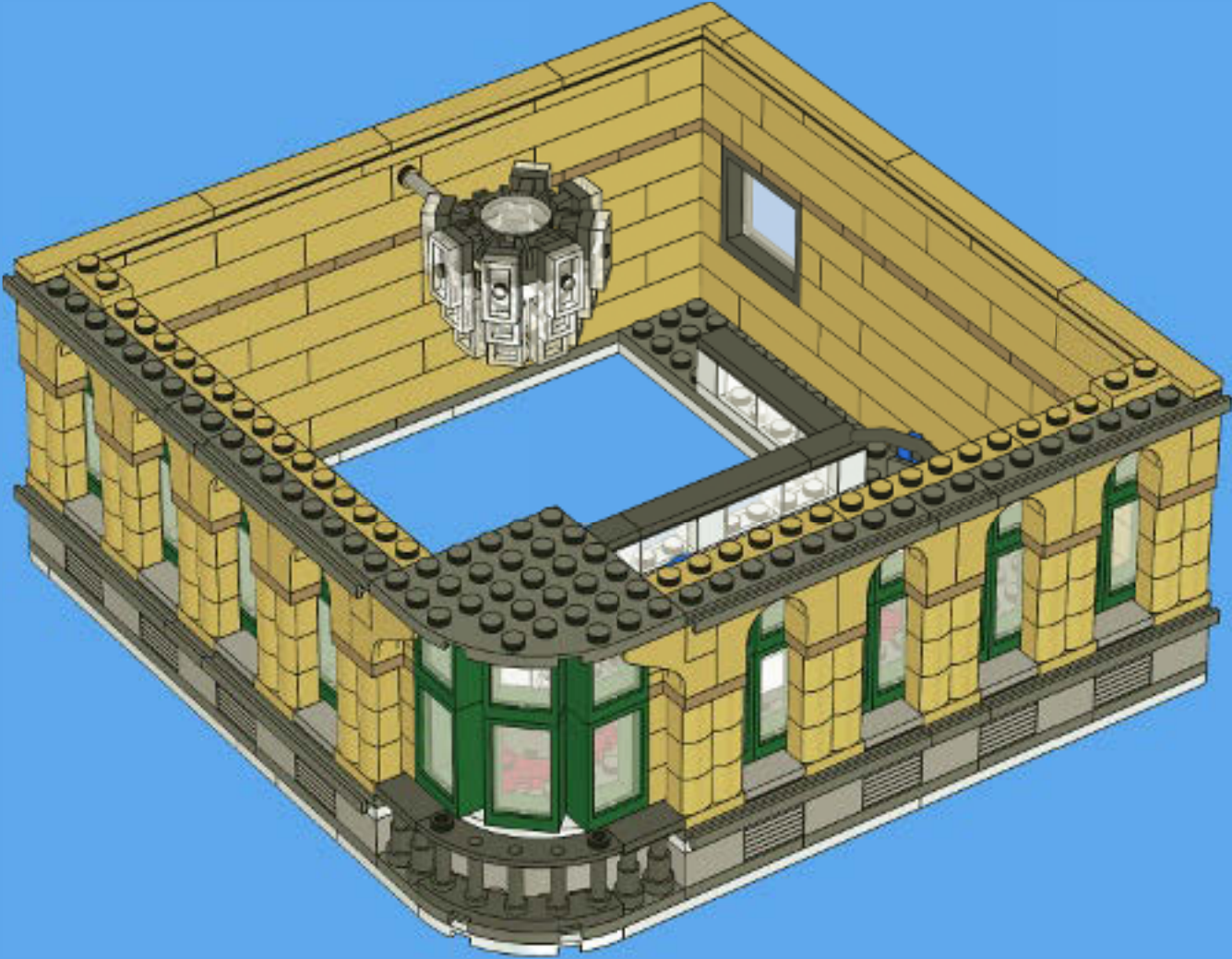

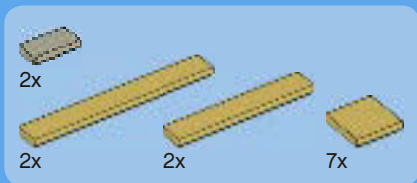

30

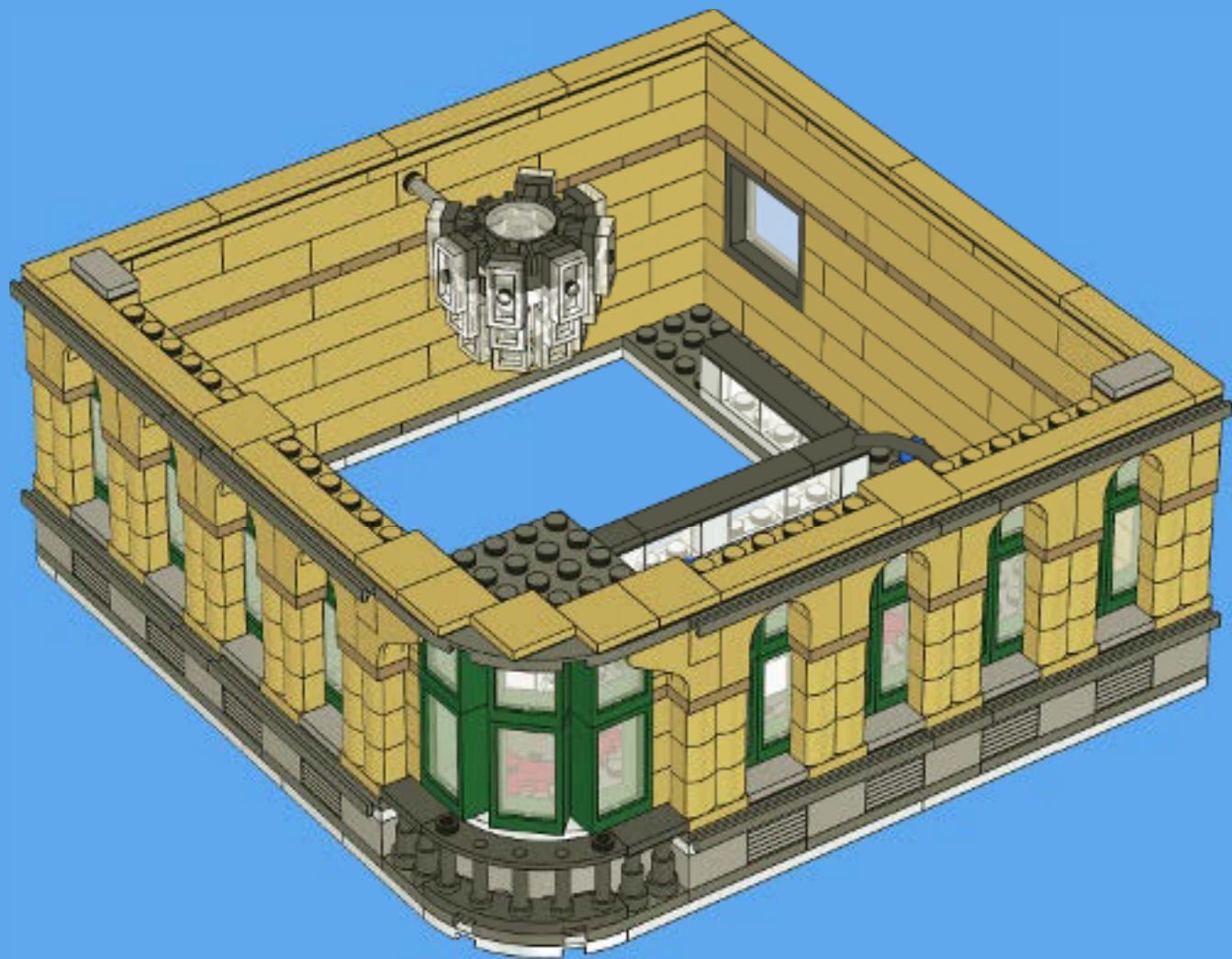

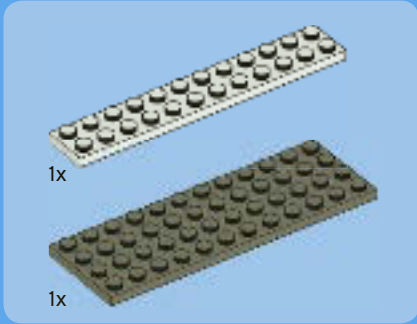
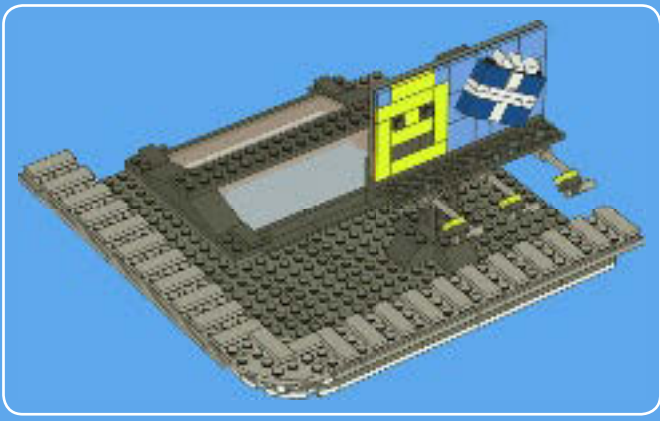

1

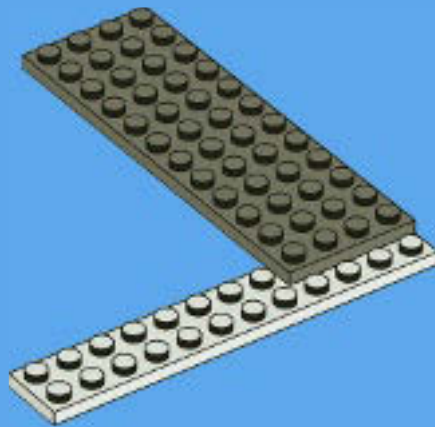

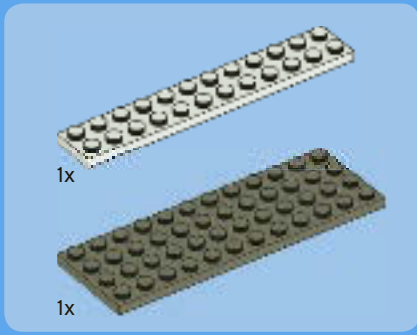

2

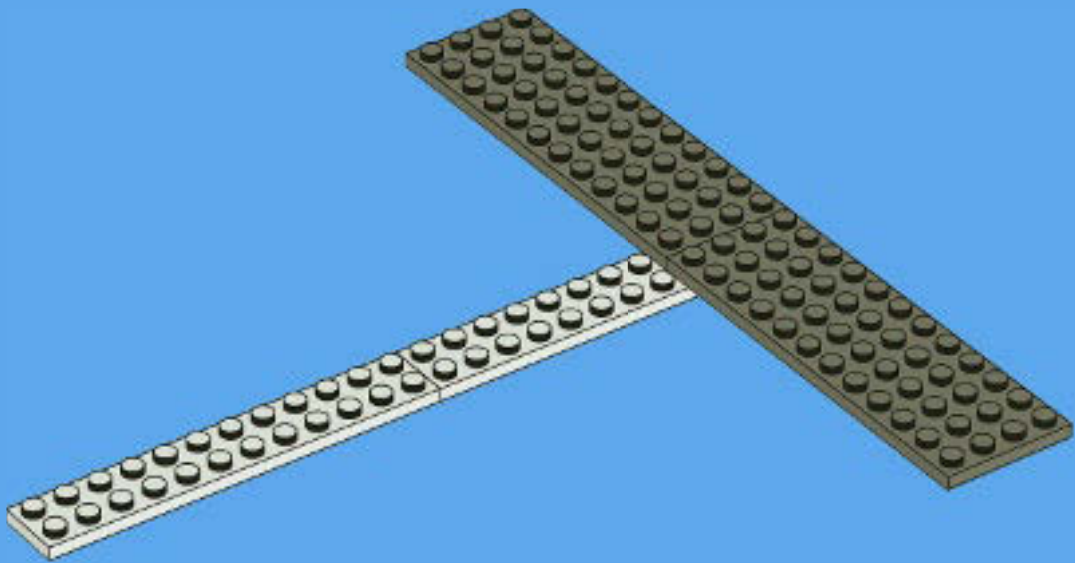



1x

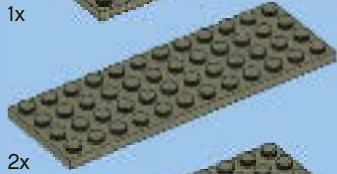

2x

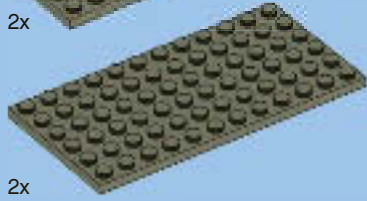

2x

3

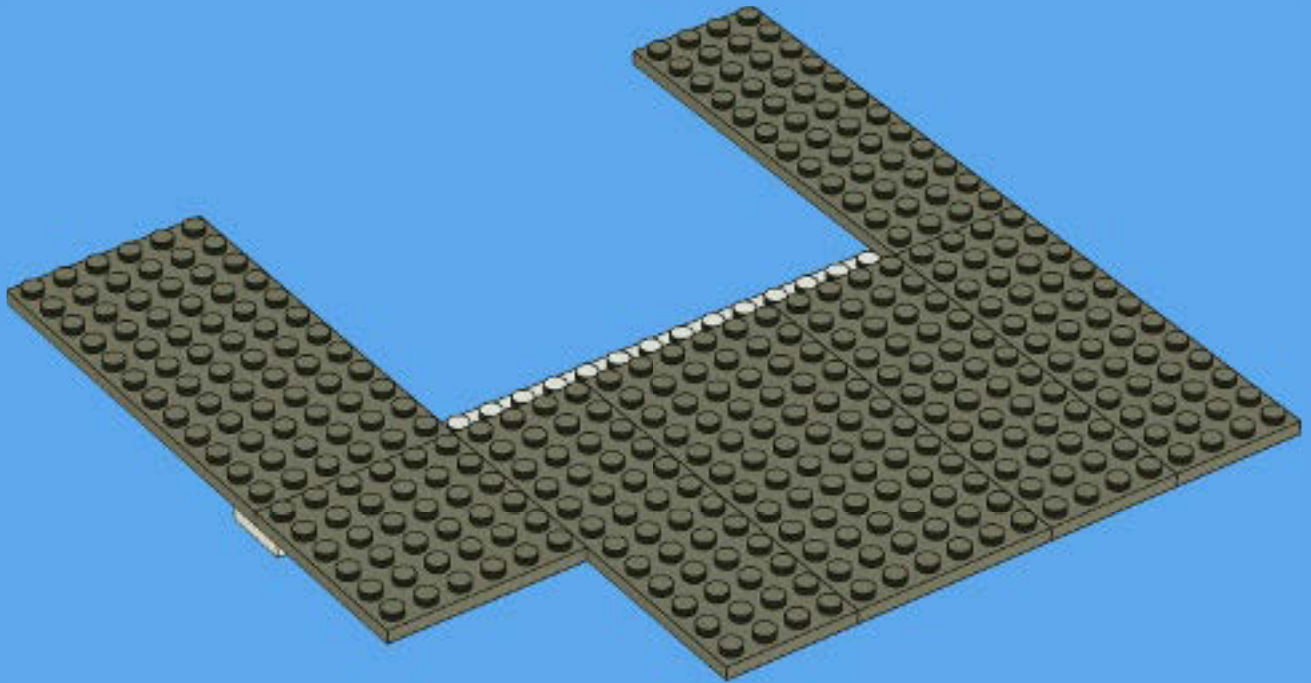

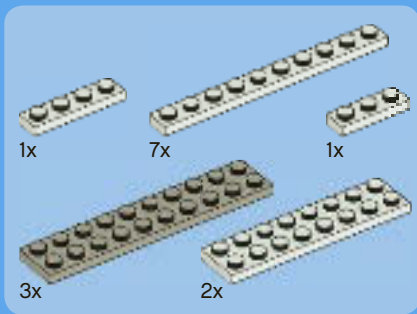

4

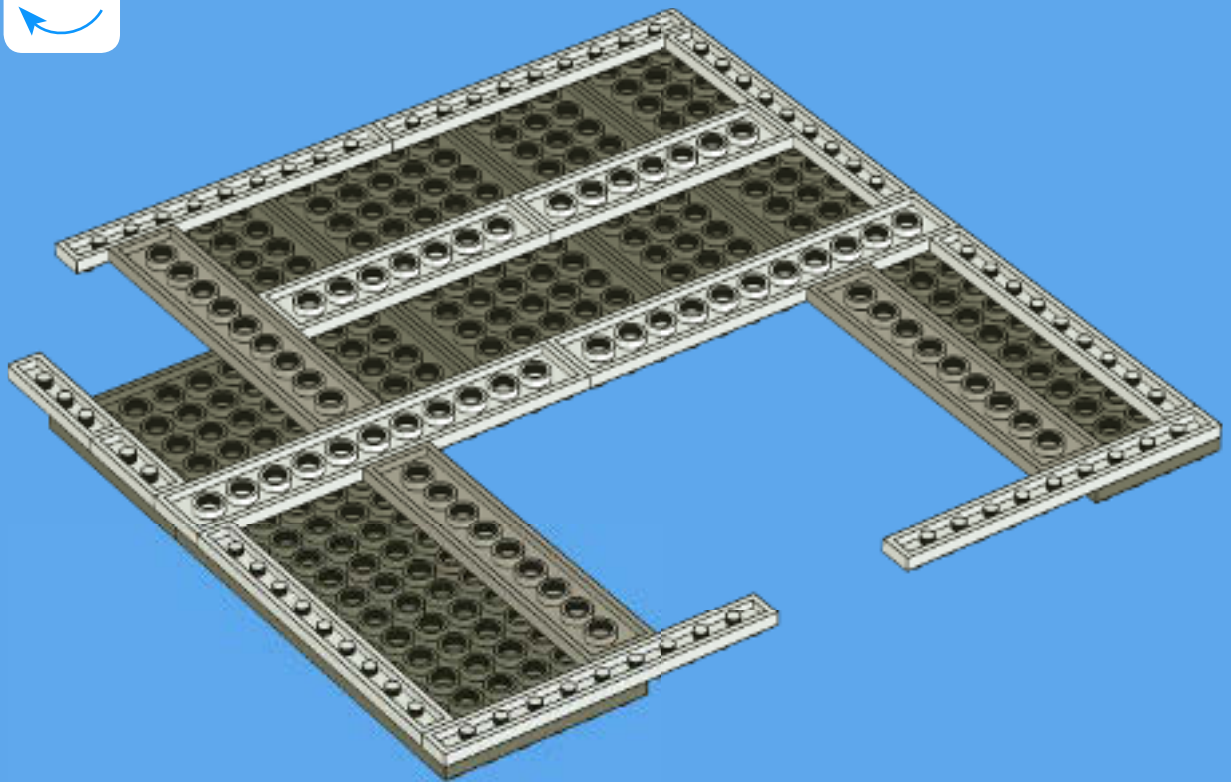

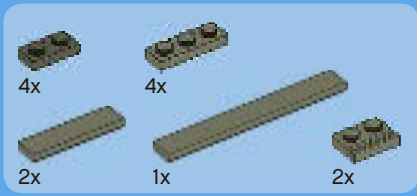

5

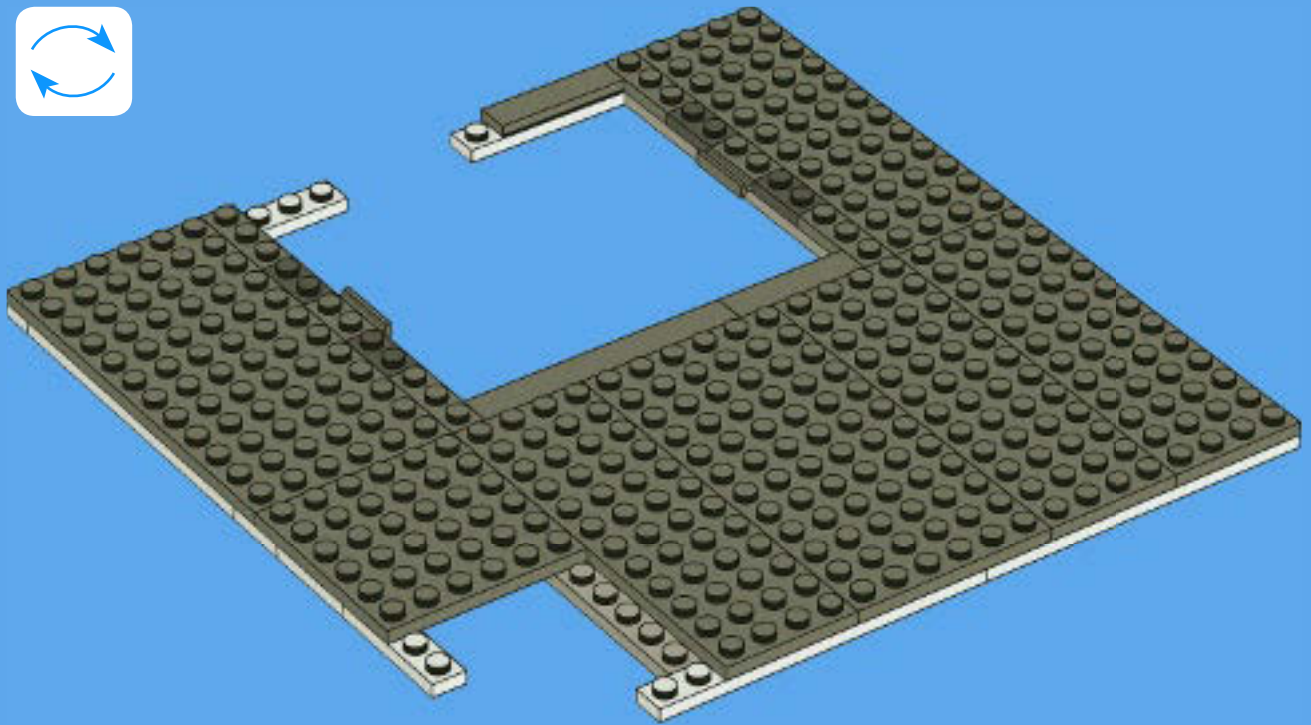

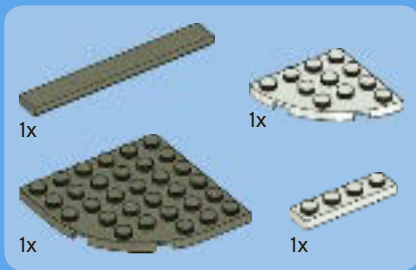

6

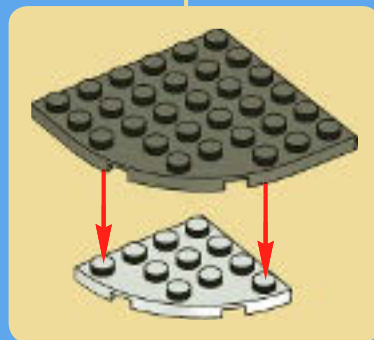
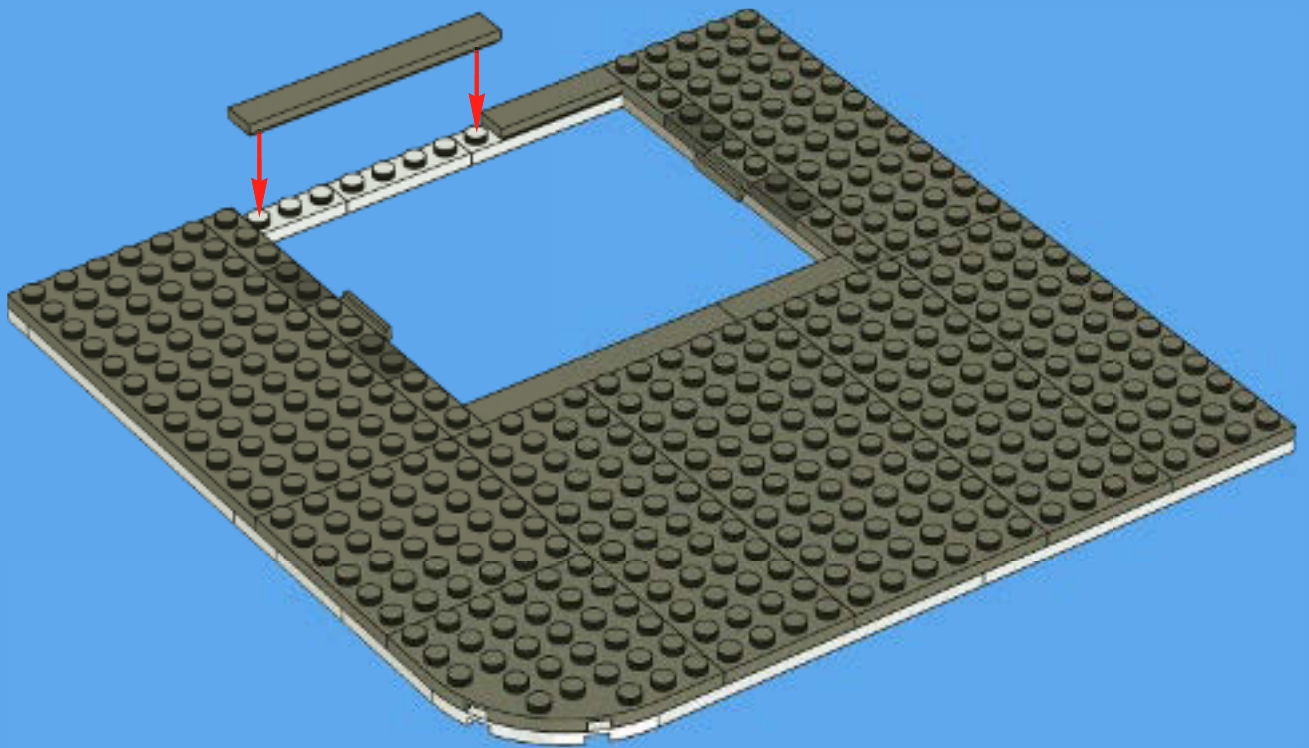

7

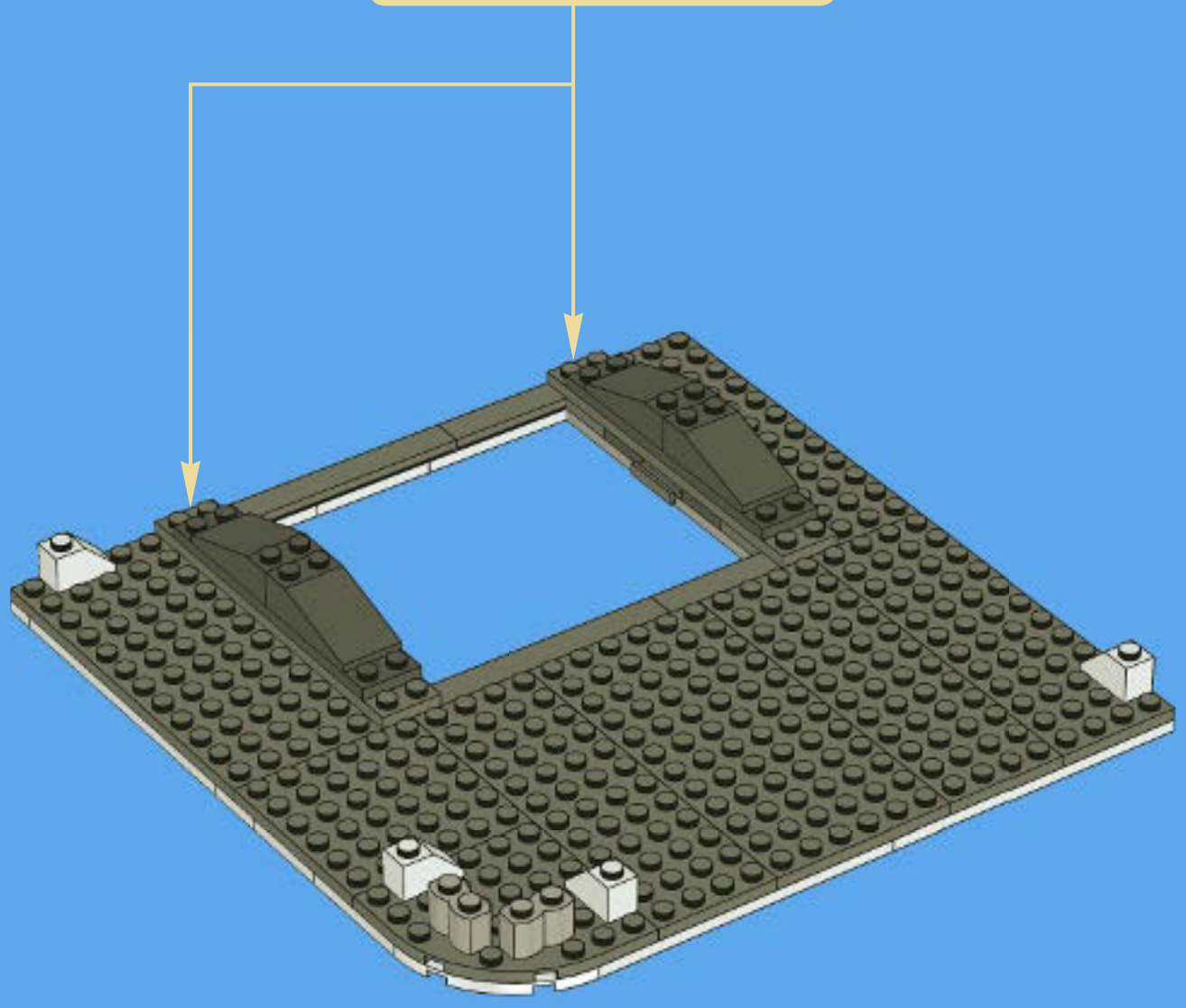
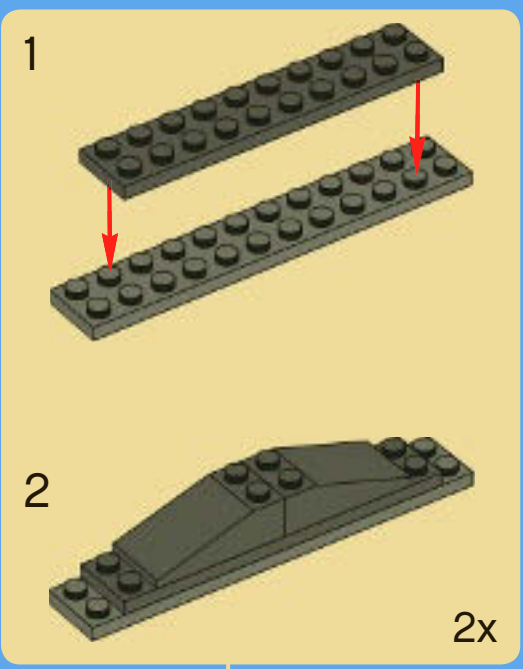
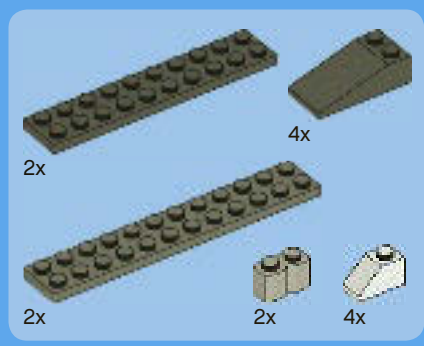

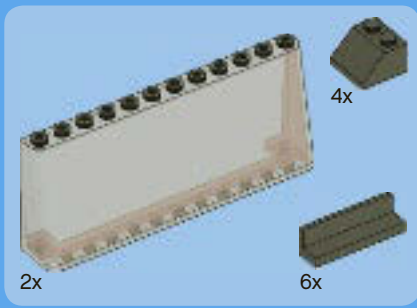

8

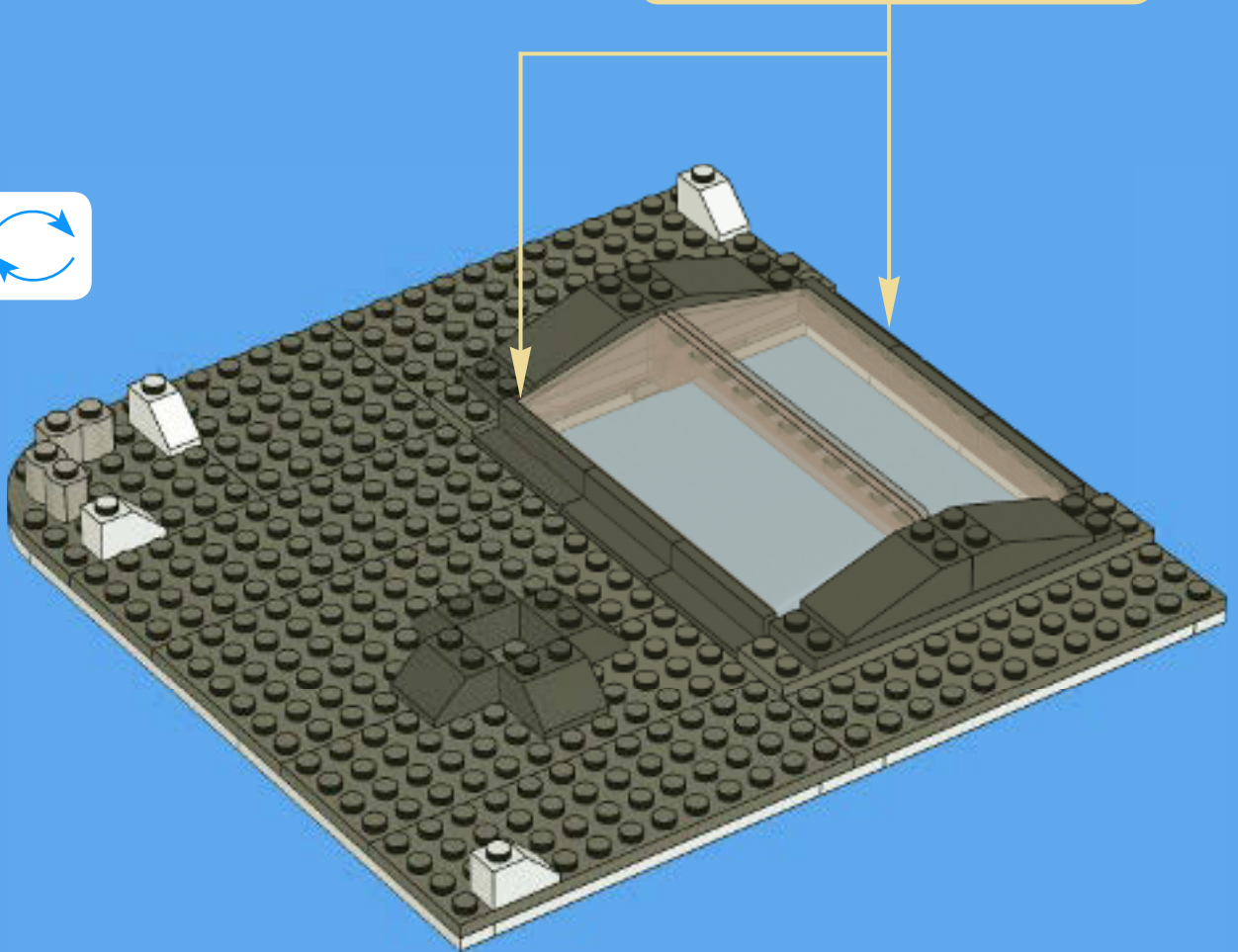
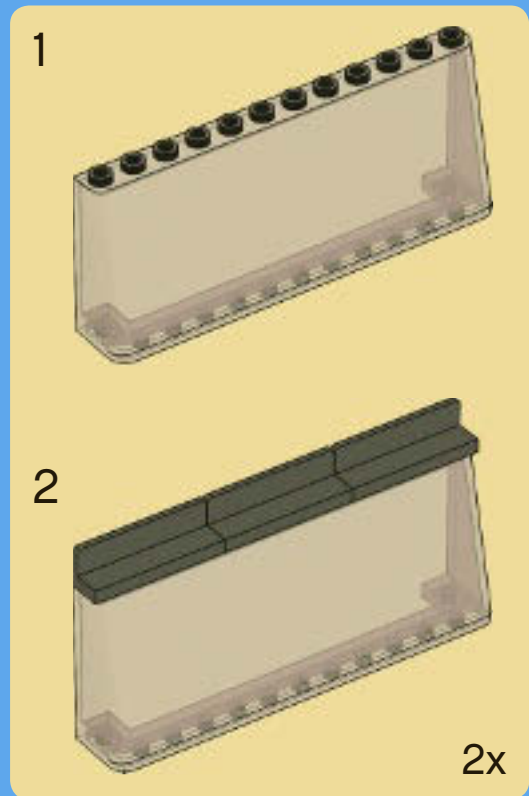



1x



1x



20x



4x

9

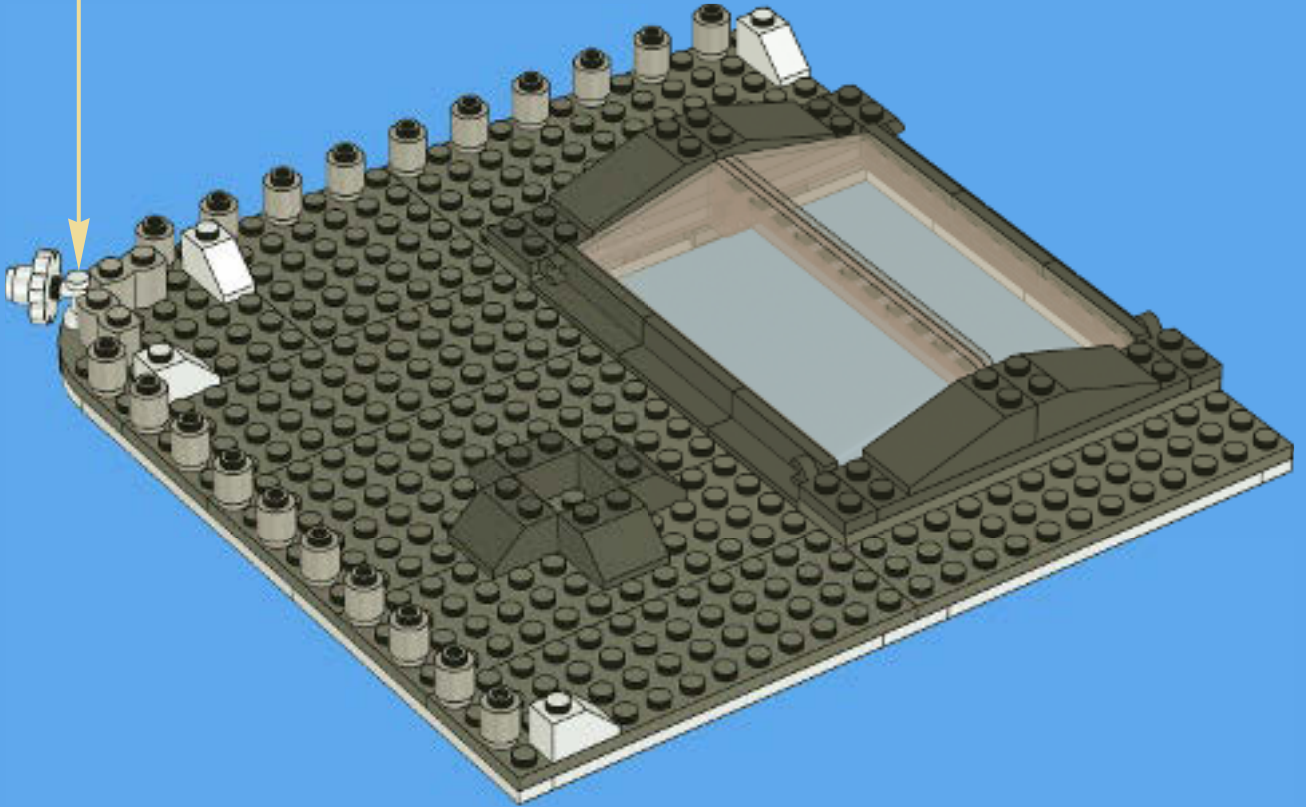
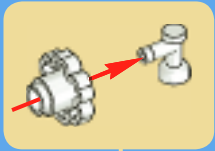

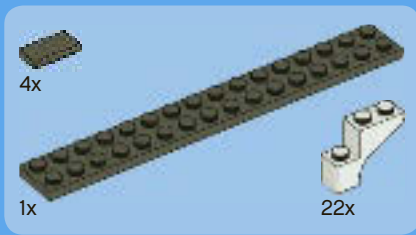

10

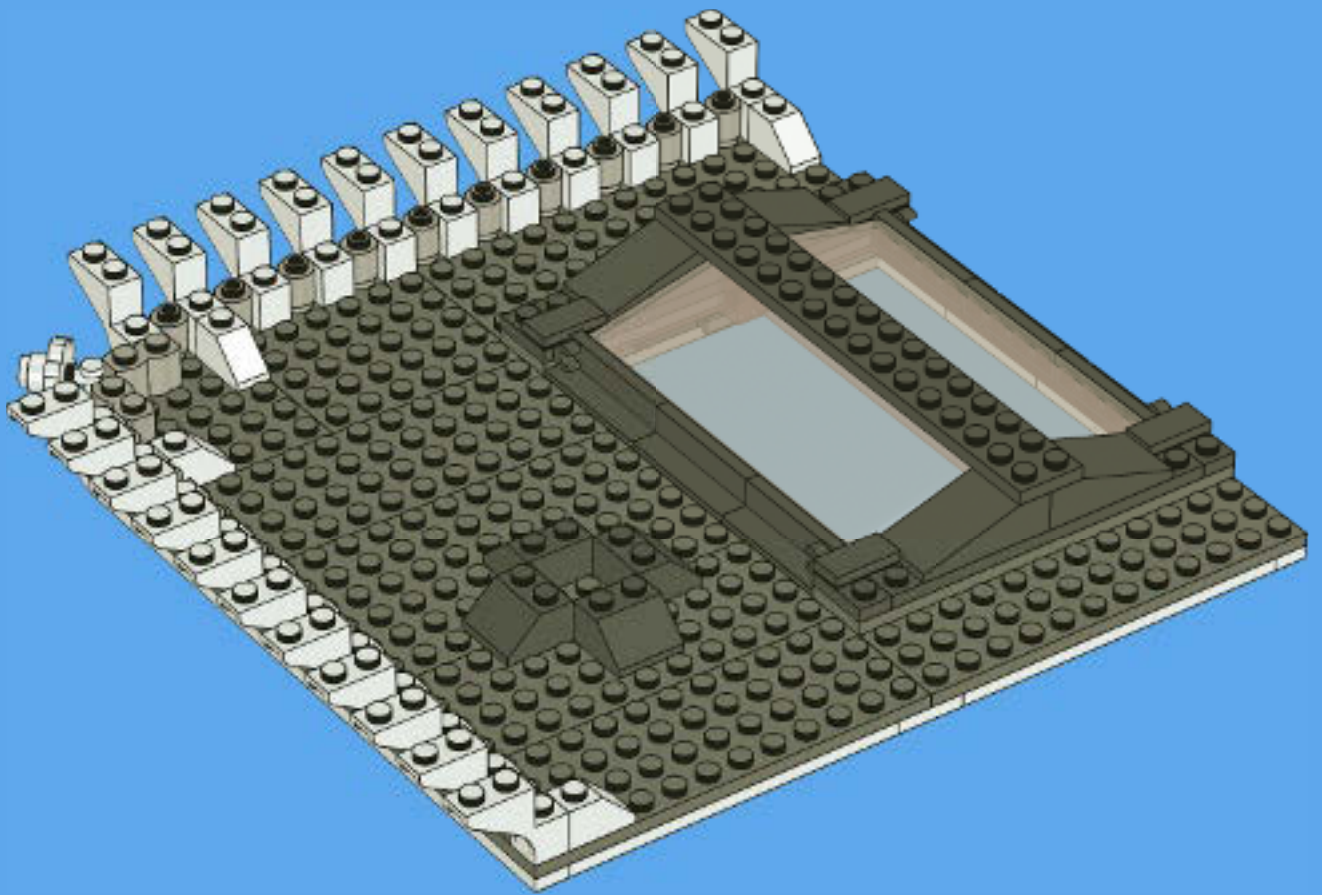



20x

11

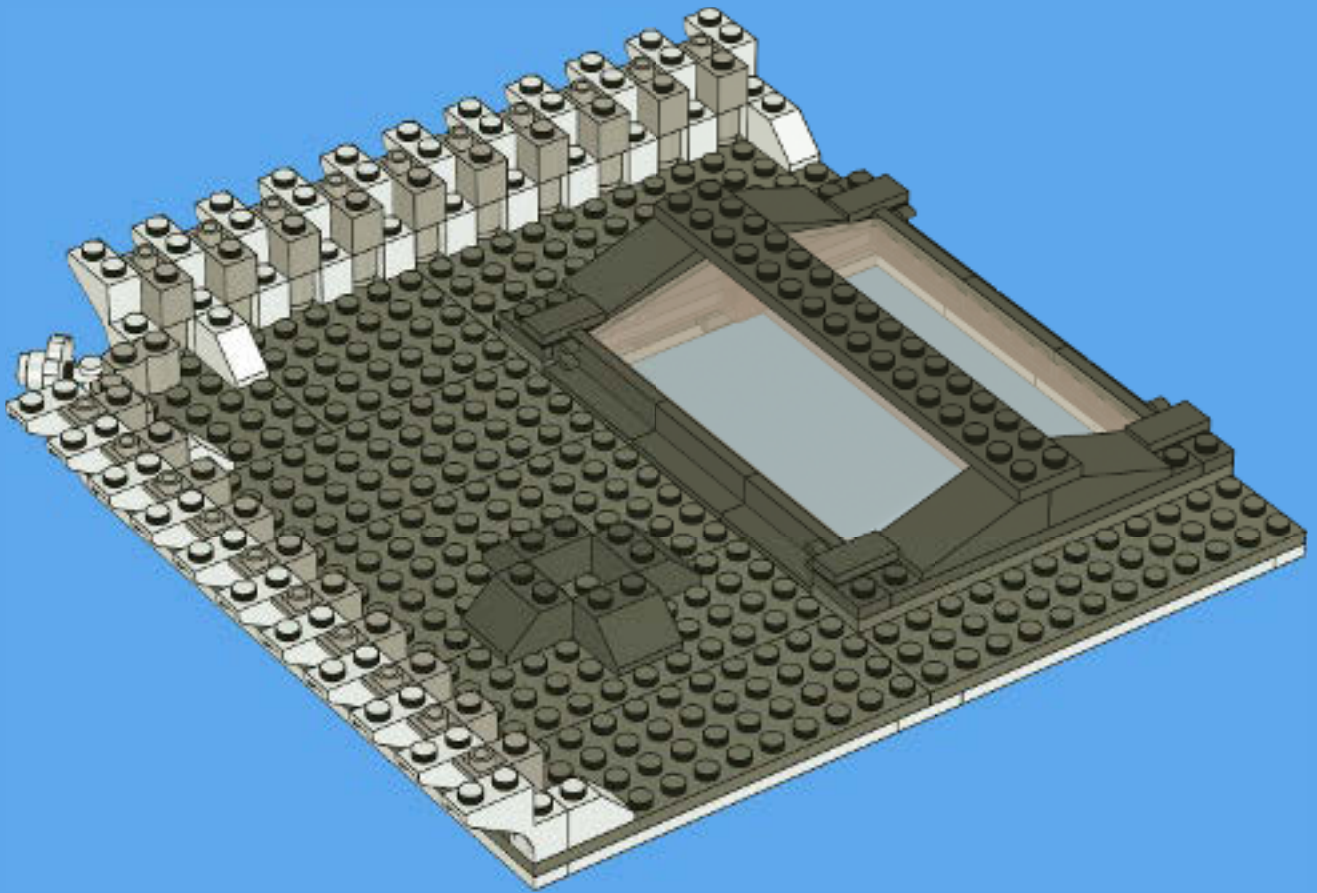



4x



1x

12

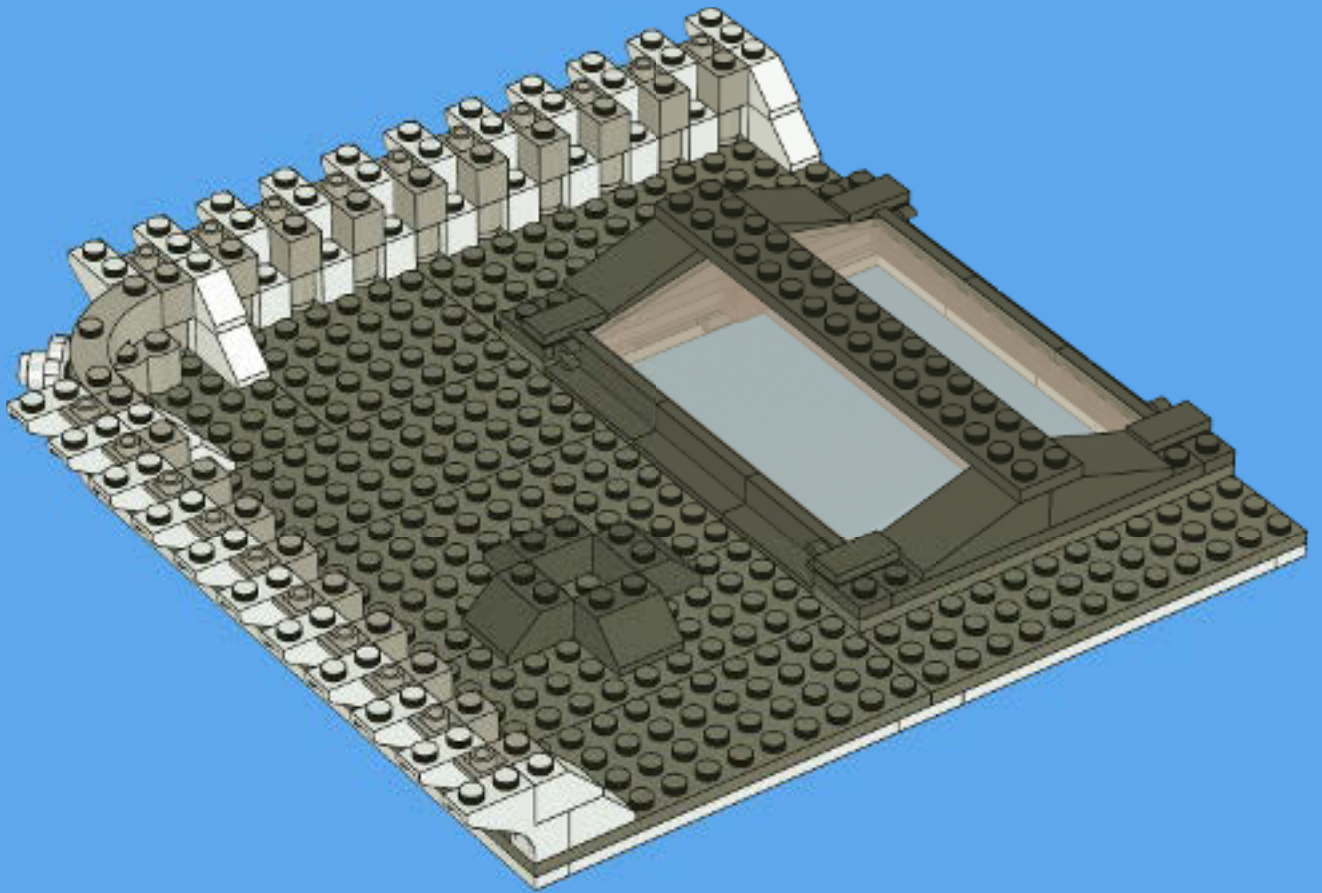



16x

13

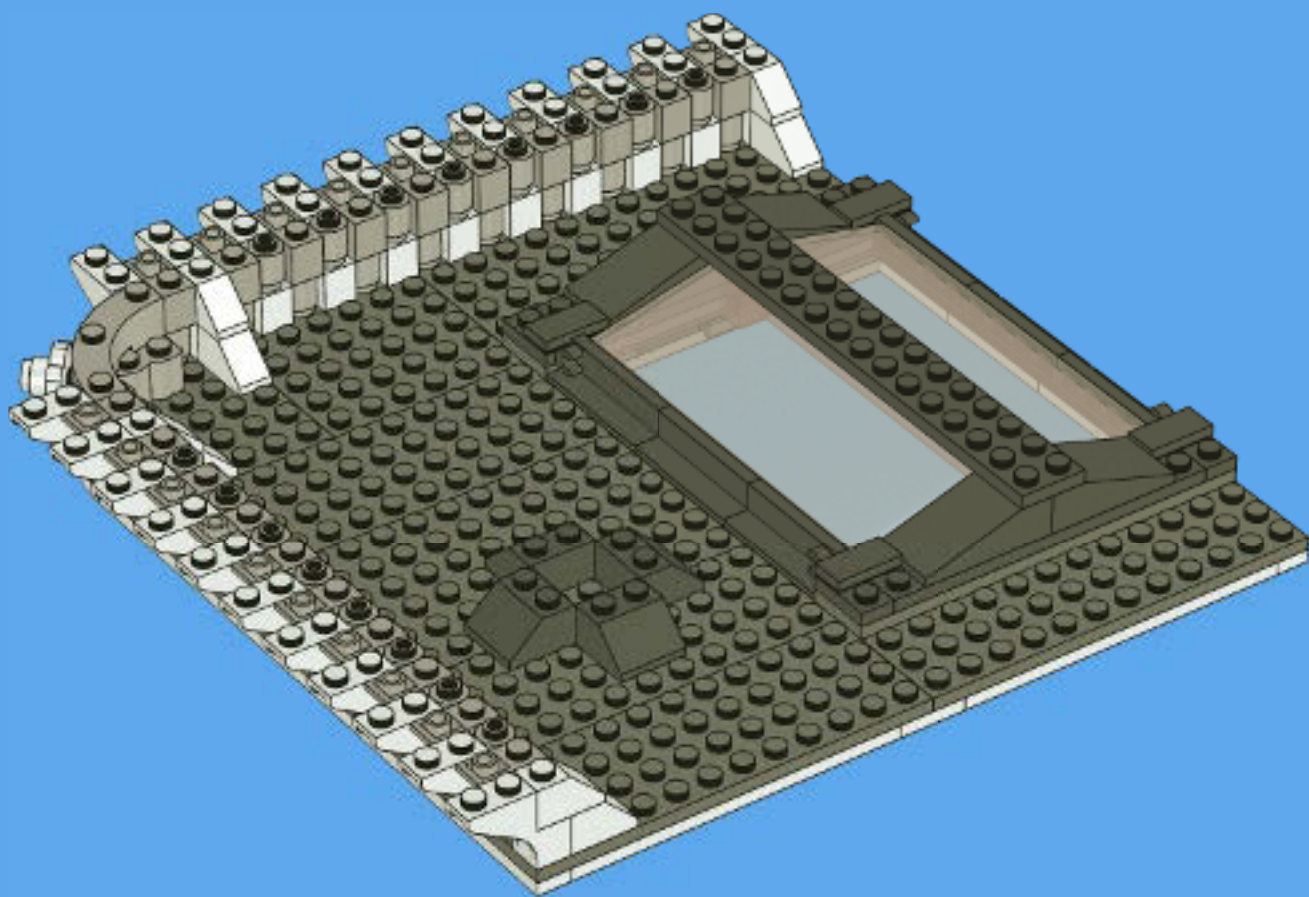

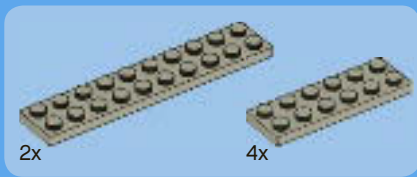

14

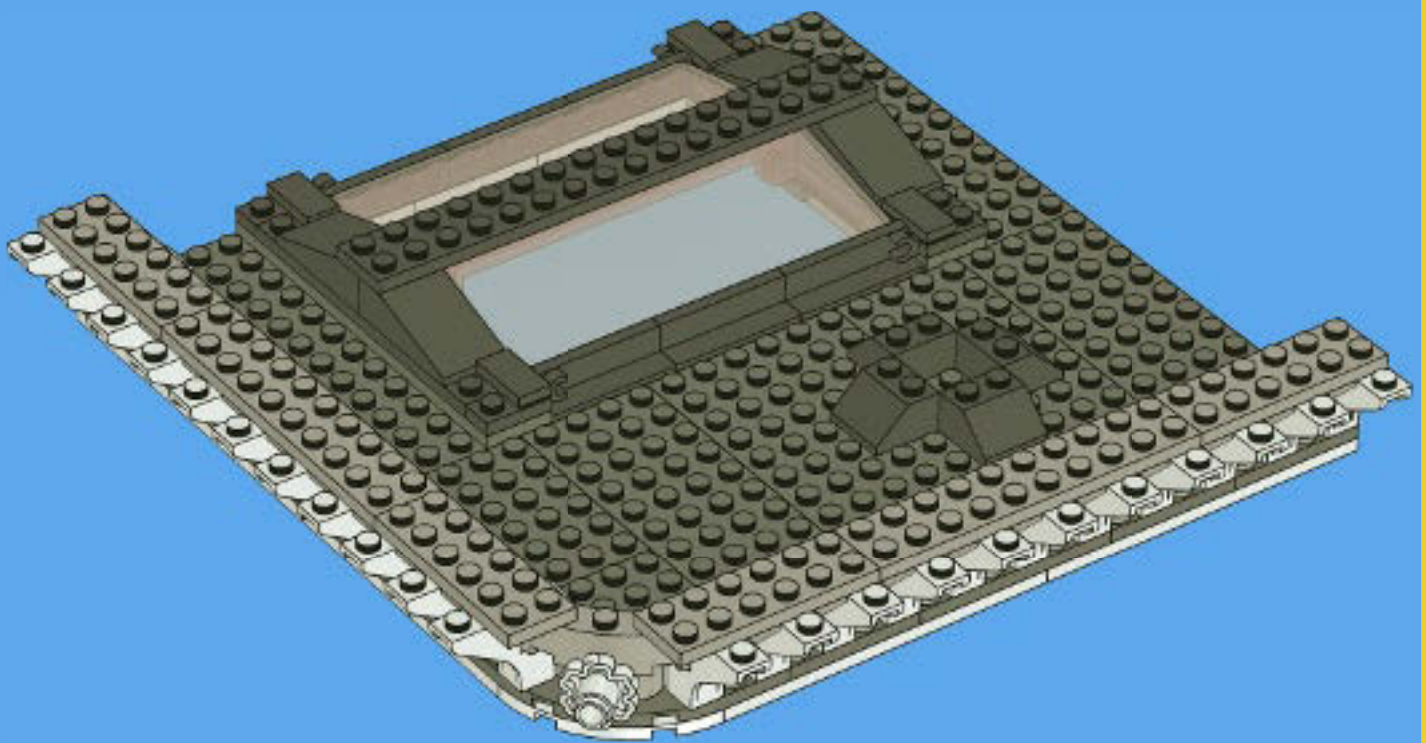

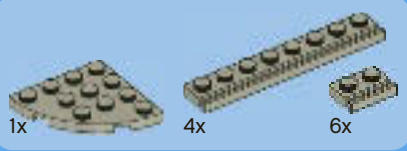

15

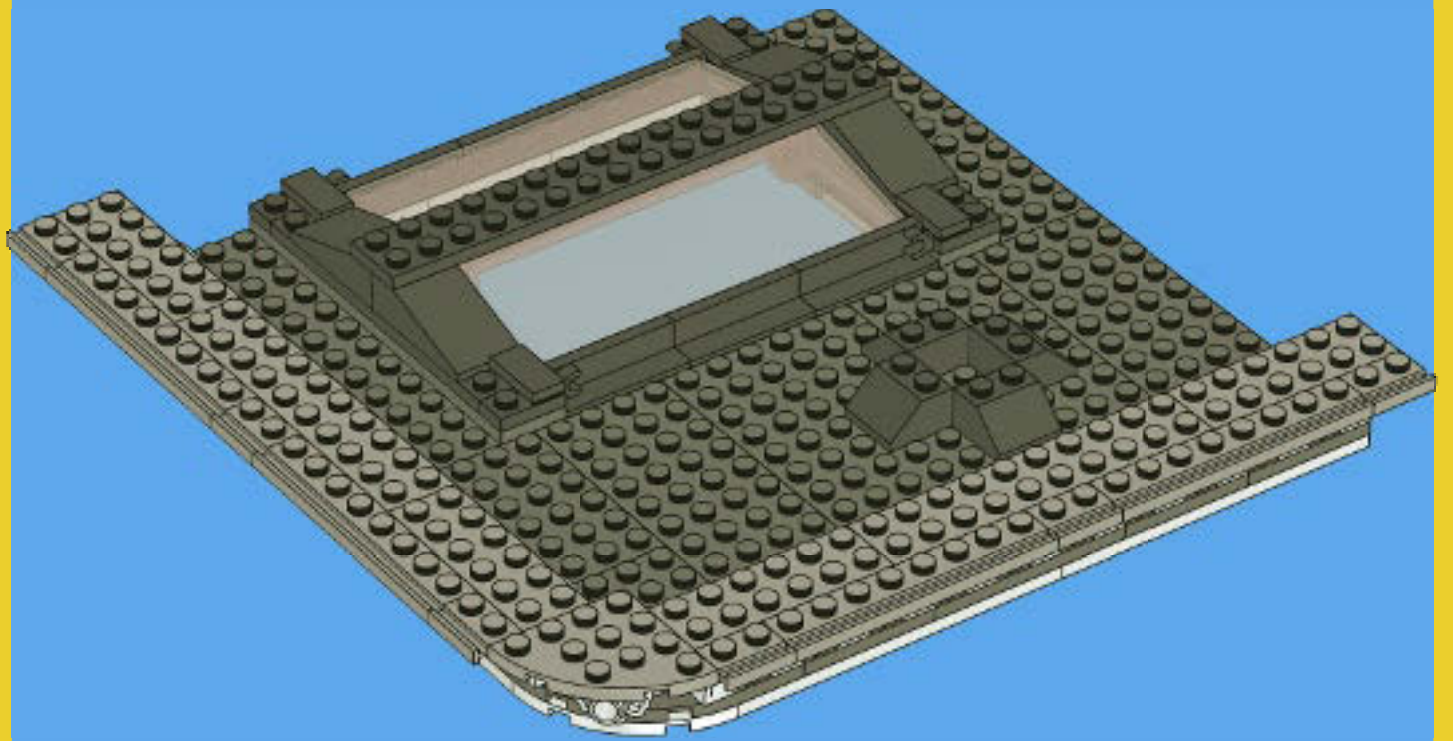

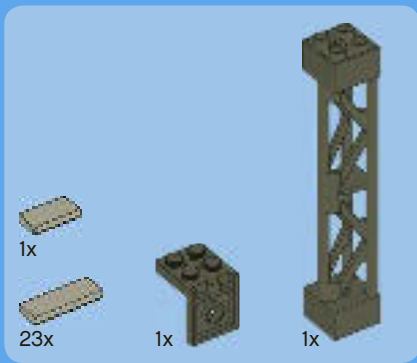

16

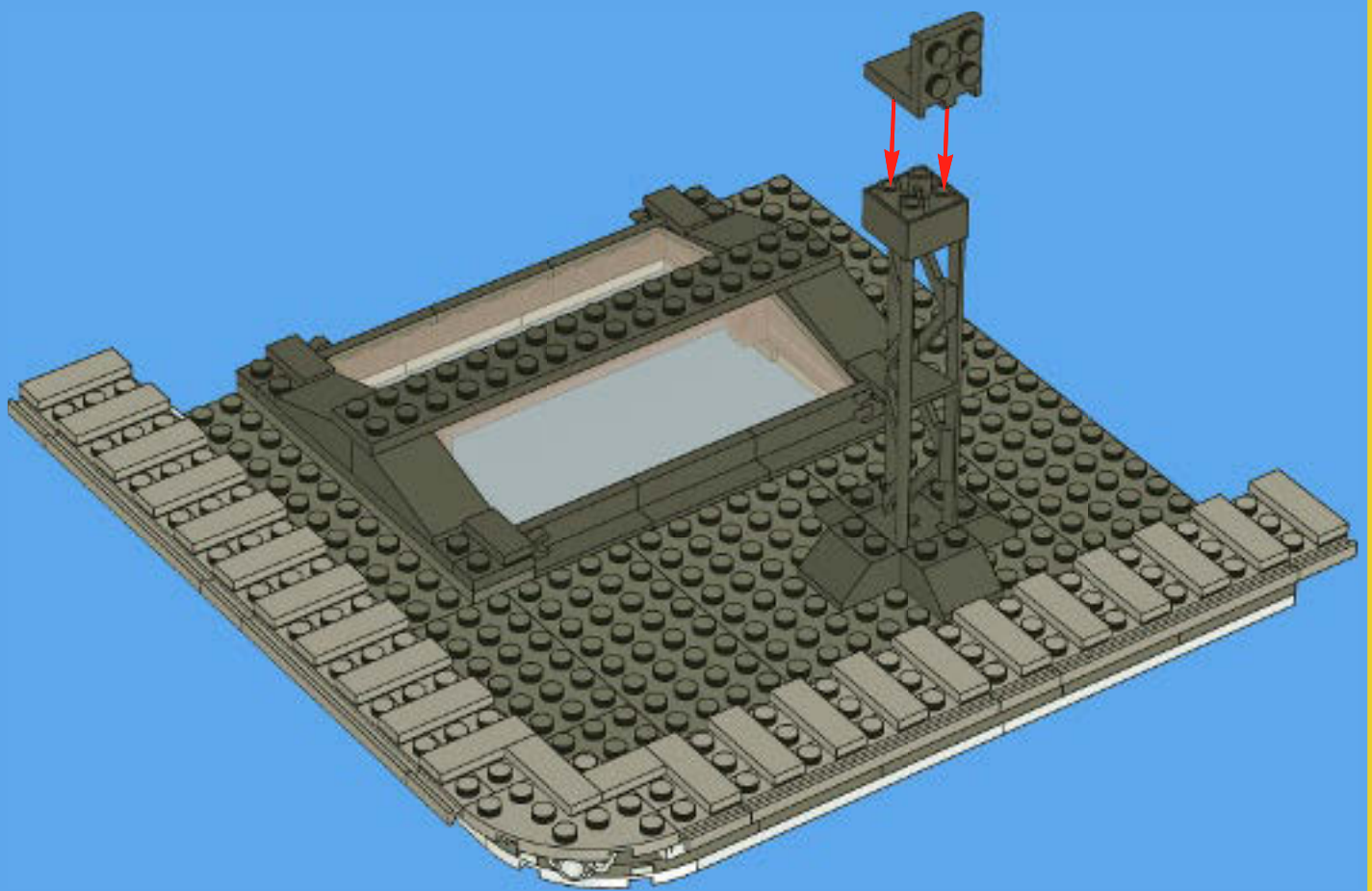



1x

1

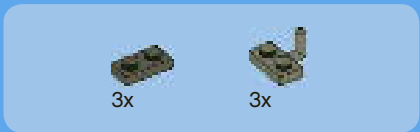
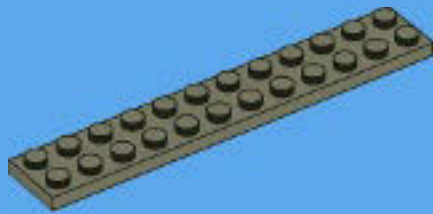

3x

3x

2

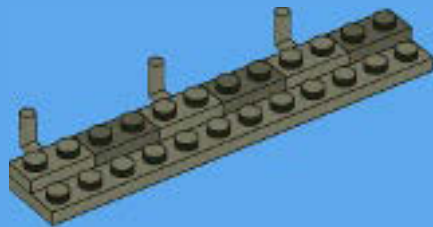



3x

3

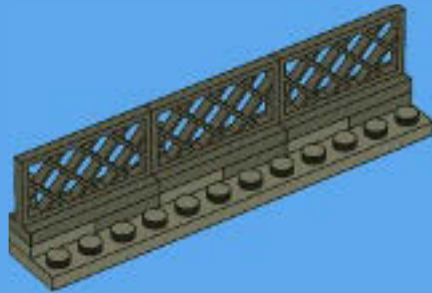

3x



3x



3x



3x

4

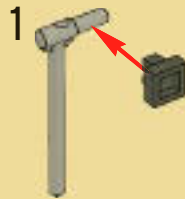

3x

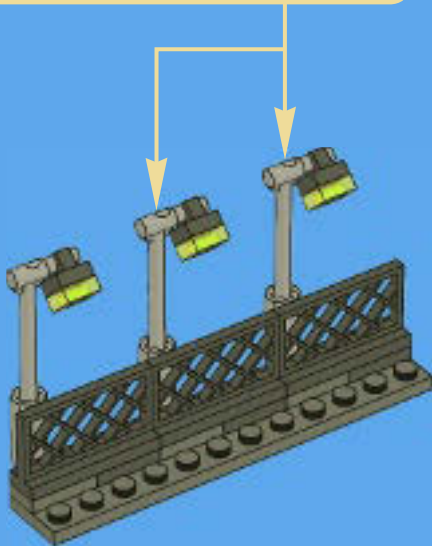

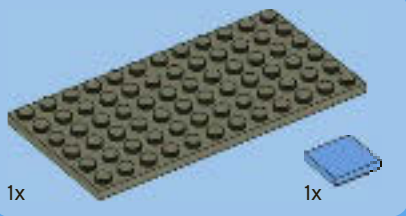

1

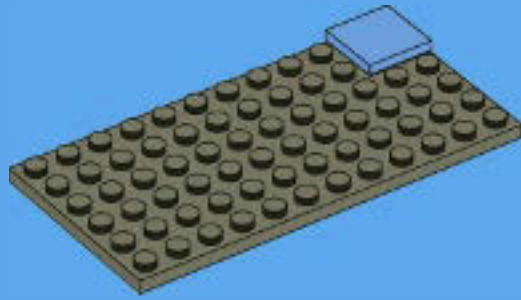

2

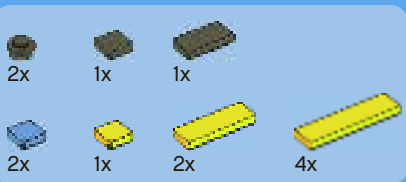
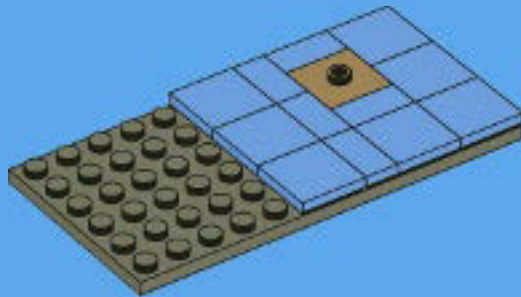

3

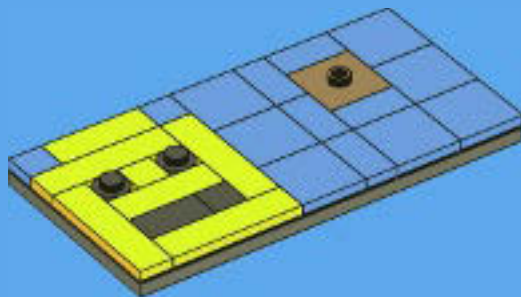

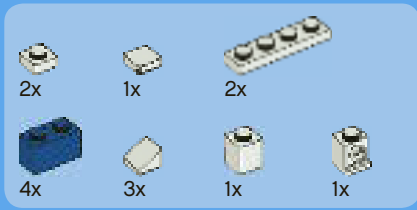

4

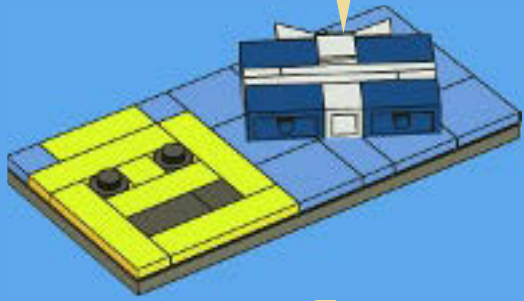
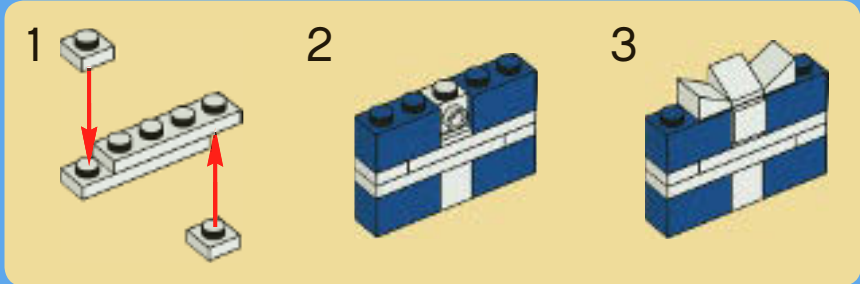

5

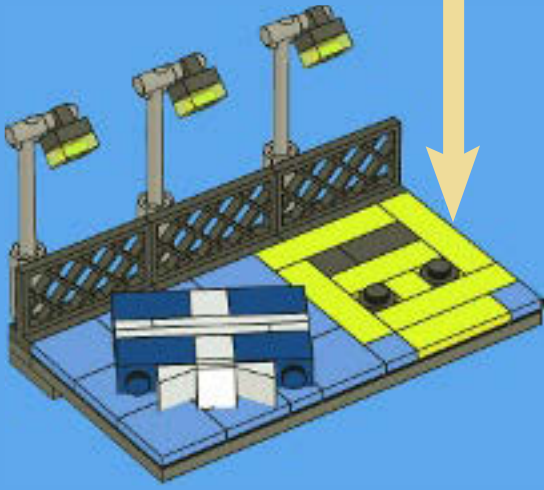

17

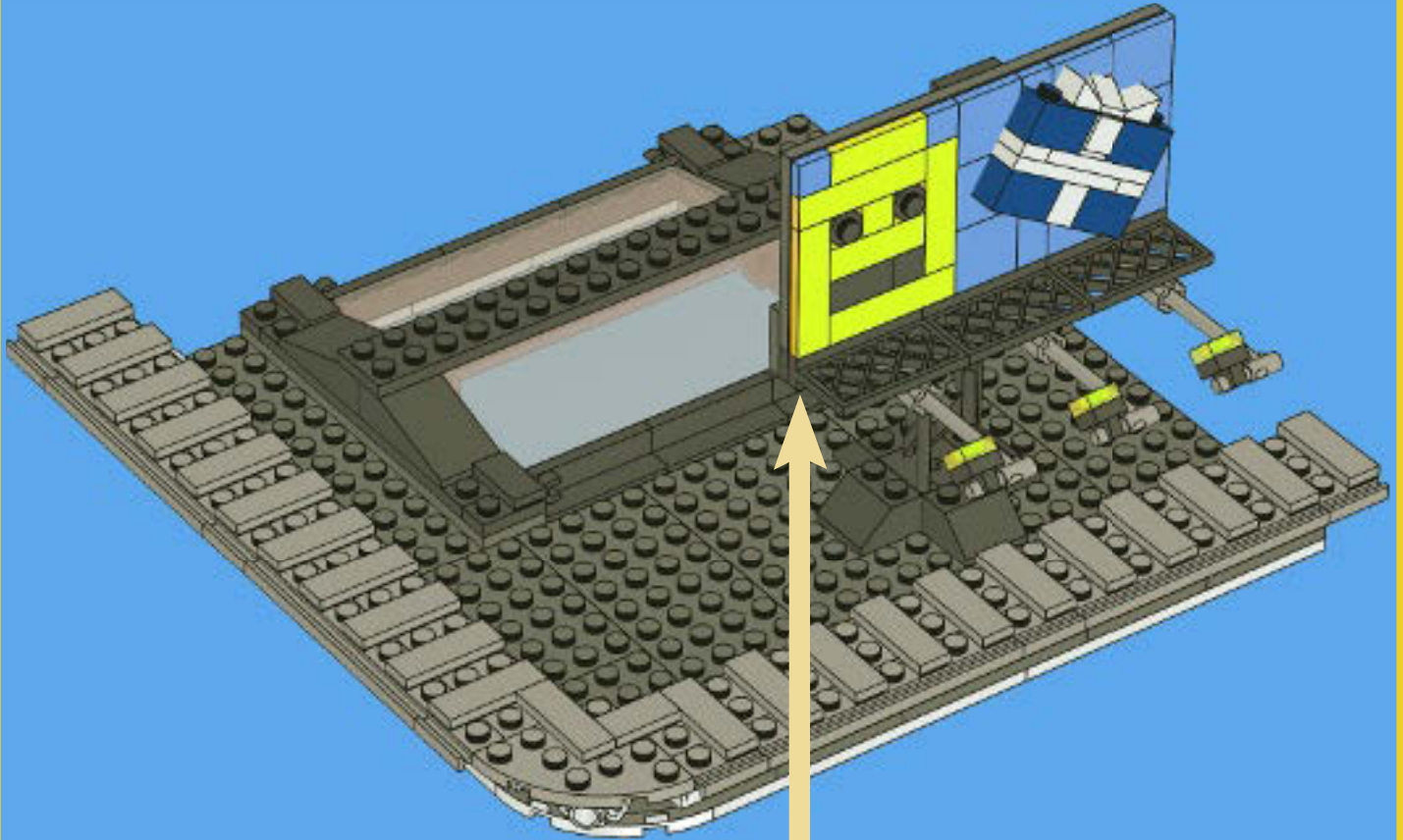

31

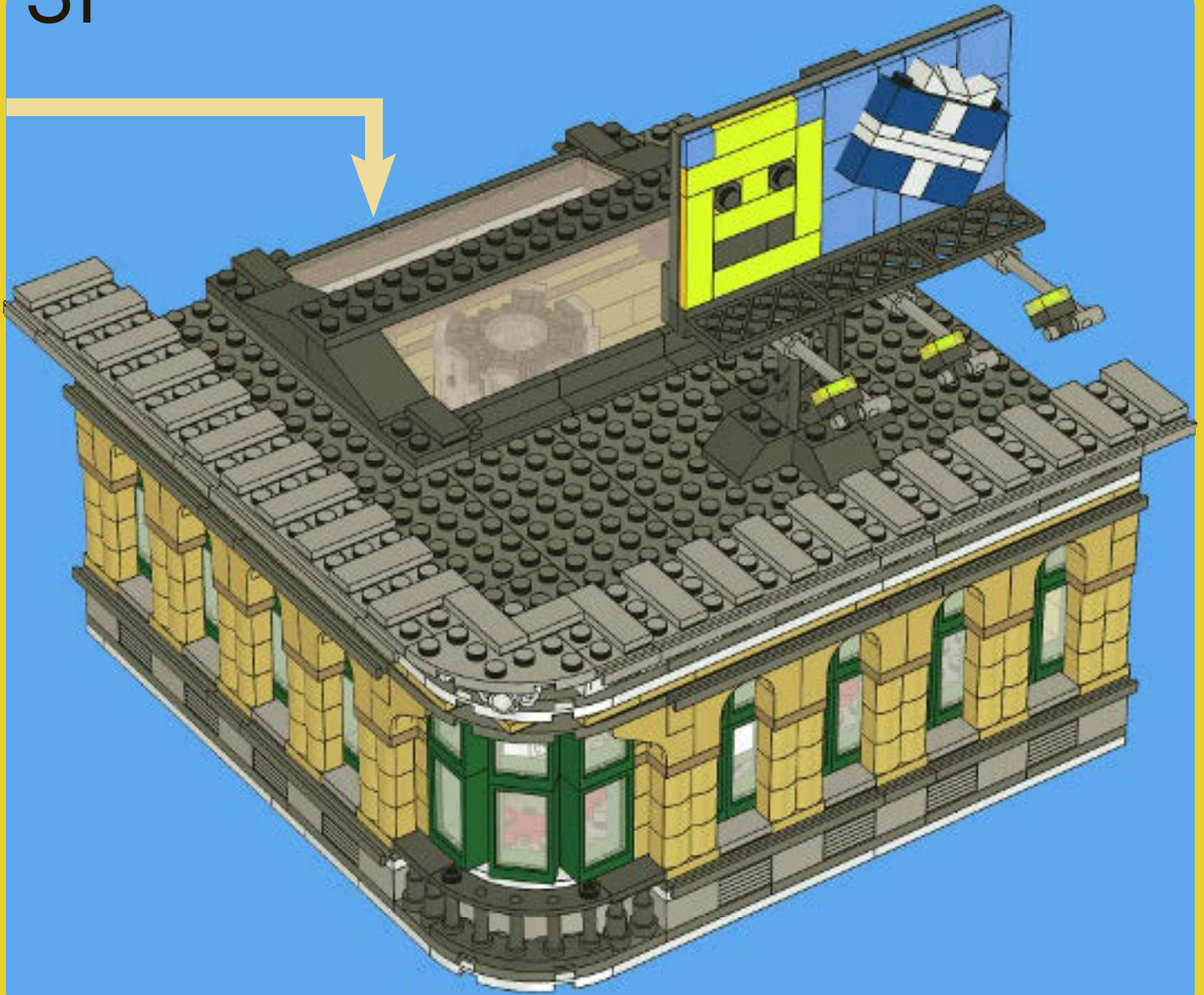

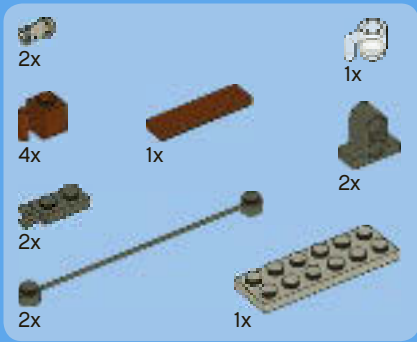

32

1

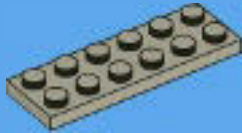

2

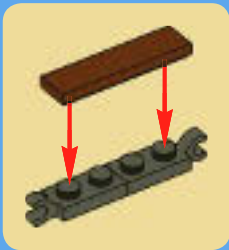

3

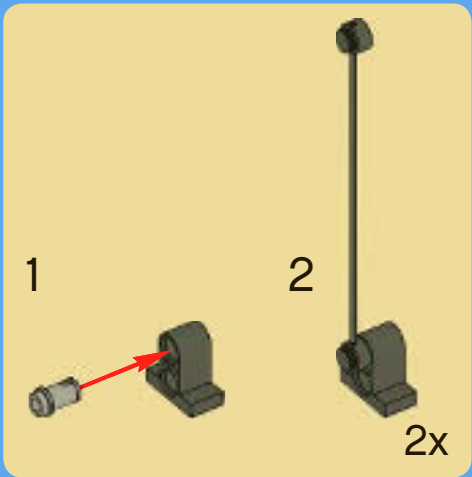

4

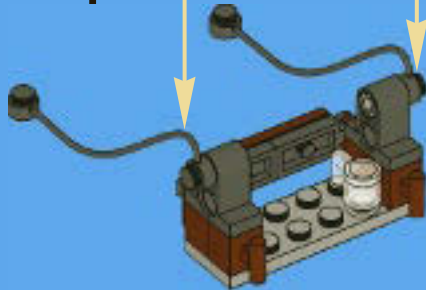

5



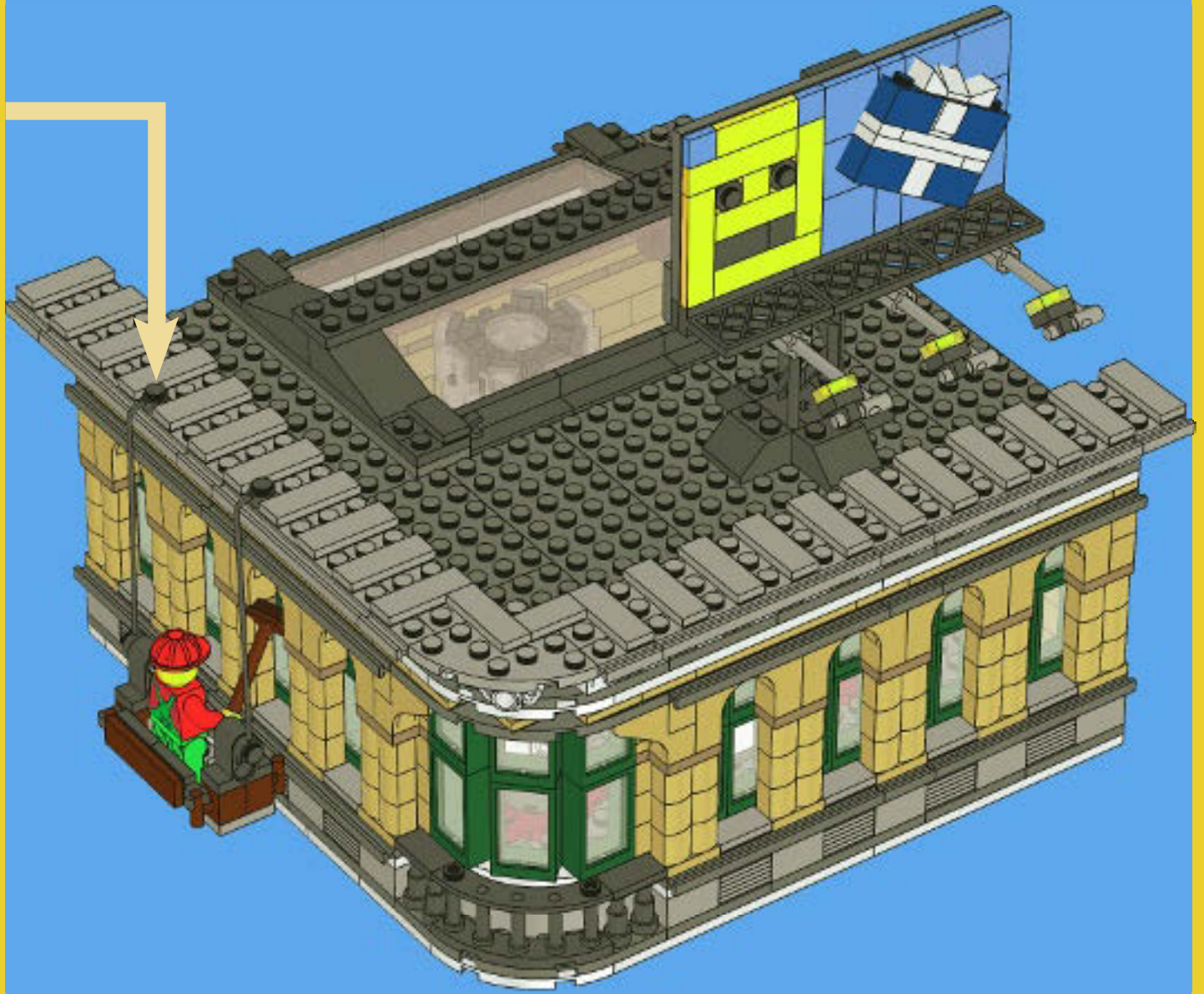

33



- 14x 300501
- 4x 300401
- 2x 300101
- 4x 300901
- 8x 611101
- 2x 407001
- 2x 4215470
- 3x 4504369
- 4x 366501
- 8x 4121932
- 1x 4540812
- 22x 4568956
- 18x 302401
- 4x 307001
- 4x 302301
- 2x 4521848
- 20x 306901
- 8x 242001
- 11x 362301
- 27x 371001
- 3x 302001
- 13x 366601
- 6x 303401
- 36x 447701
- 7x 244501
- 4x 4538353
- 5x 379401
- 3x 4249563
- 4x 4515364
- 2x 4501853
- 2x 474001
- 1x 4179580
- 4x 241901
- 3x 4178429
- 2x 4113016
- 3x 4541956
- 2x 459901
- 1x 434601
- 1x 434501
- 4x 623101
- 2x 486501
- 1x 472801
- 1x 4119500
- 1x 4186952
- 1x 9327
- 1x 4540737
- 2x 625401
- 26x 4113915
- 10x 4109995
- 3x 4124455
- 22x 4162465
- 44x 4112982
- 36x 4159774
- 1x 4558611
- 1x 4186017
- 3x 4579260
- 60x 4218749
- 1x 4118866
- 6x 4579306
- 16x 4190213
- 14x 4159553
- 6x 4125253
- 20x 4113917
- 14x 4185177
- 18x 4124067
- 14x 4157277
- 8x 4544139
- 6x 4114324
- 6x 4155708
- 2x 4217562
- 2x 4504379
- 1x 4521852
- 1x 4261628
- 4x 449521
- 1x 4550848
- 1x 4540429
- 1x 383321
- 1x 4562544
- 2x 4142865
- 3x 307024
- 10x 302424
- 5x 302324
- 5x 362324
- 5x 4558172
- 4x 243124
- 7x 4540040
- 1x 74333
- 7x 9336
- 1x 4545434
- 2x 242023
- 3x 4520946
- 1x 408123
- 1x 395623
- 1x 4543857
- 1x 9341
- 1x 4540446
- 1x 4174743
- 1x 4570137

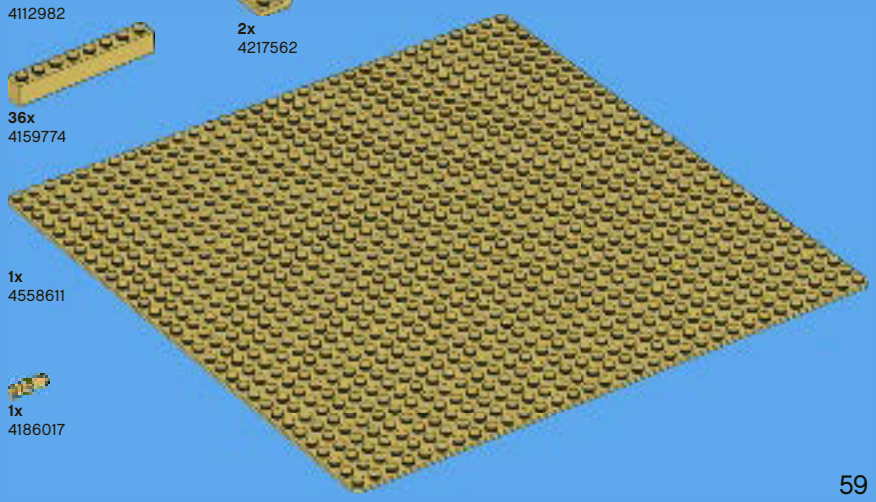

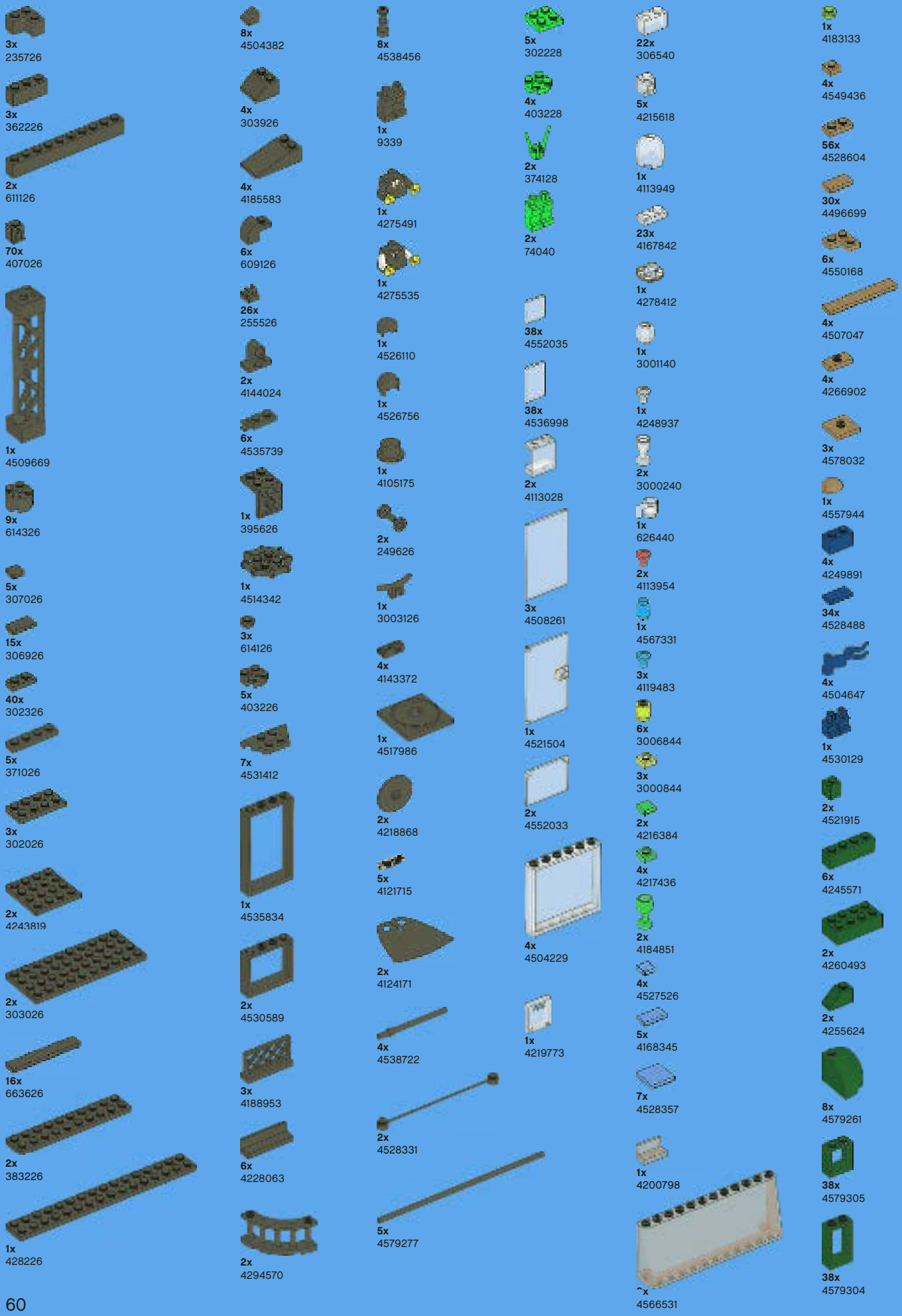

3x 235726
 3x 362226
 2x 611126
 70x 407026
 1x 4509669
 9x 614326
 5x 307026
 15x 306926
 40x 302326
 5x 371026
 3x 302026
 2x 4243819
 2x 303026
 16x 663626
 2x 383226
 1x 428226

8x 4504382
 4x 303926
 4x 4185583
 6x 609126
 26x 255526
 2x 4144024
 6x 4535739
 1x 395626
 1x 4514342
 3x 614126
 5x 403226
 7x 4531412
 1x 4535834
 2x 4530589
 3x 4188953
 6x 4228063
 2x 4294570

8x 4538456
 1x 9339
 1x 4275491
 1x 4275535
 1x 4526110
 1x 4526756
 1x 4105175
 2x 249626
 1x 3003126
 4x 4143372
 1x 4517986
 2x 4218868
 5x 4121715
 2x 4124171
 4x 4538722
 2x 4528331
 5x 4579277

5x 302228
 4x 403228
 2x 374128
 2x 74040
 38x 4552035
 38x 4536998
 2x 4113028
 3x 4508261
 1x 4521504
 2x 4552033
 4x 4504229
 1x 4219773

22x 306540
 5x 4215618
 1x 4113949
 23x 4167842
 1x 4278412
 1x 3001140
 1x 4248937
 2x 3000240
 1x 626440
 2x 4113954
 1x 4567331
 3x 4119483
 6x 3006844
 3x 3000844
 2x 4216384
 4x 4217436
 2x 4184851
 4x 4527526
 5x 4168345
 7x 4528357
 1x 4200798
 ~x 4566531

1x 4183133
 4x 4549436
 56x 4528604
 30x 4496699
 6x 4550168
 4x 4507047
 4x 4266902
 3x 4578032
 1x 4557944
 4x 4249891
 34x 4528488
 4x 4504647
 1x 4530129
 2x 4521915
 6x 4245571
 2x 4260493
 2x 4255624
 8x 4579261
 38x 4579305
 38x 4579304

4x 4225823
 4x 4211252
 1x 4211194
 3x 4211159
 2x 4520638
 1x 4550736
 1x 4211157
 2x 4504277
 11x 4211389
 11x 4211388
 2x 4550325
 16x 4211387
 9x 4211349
 15x 4211428
 8x 4211394
 19x 4211393
 12x 4211392
 2x 4211390

32x 4211383
 4x 4258455
 3x 4215472
 36x 4211412
 18x 4521921
 16x 4568637
 20x 4211437
 2x 4211436
 64x 4211519
 2x 4519930
 6x 4211415
 6x 4211398
 30x 4211414
 4x 4211397
 7x 4211413
 4x 4211353
 32x 4558169
 2x 4277927

6x 4211568
 3x 4211429
 3x 4211395
 33x 4211549
 2x 4211438
 12x 4211452
 7x 4211462
 4x 4211498
 1x 4262978
 1x 4515351
 1x 4579294
 1x 4221775
 3x 4565433
 2x 4211473
 1x 4494222
 2x 4211483
 1x 4211375
 3x 4512360
 4x 4526985
 1x 4514192

6x 4550169
 4x 4539114
 11x 4541544
 2x 4211053
 4x 4211056
 4x 4210998
 16x 4210967
 2x 4211008
 3x 4211134
 6x 4211067
 12x 4210706
 7x 4256149
 5x 4500517
 1x 4547222
 2x 4558955
 4x 4210848
 36x 4211052

34x 4211055
 2x 4211094
 4x 4211133
 2x 4211043
 3x 4260885
 4x 4210726
 16x 4210631
 10x 4543086
 1x 4570666
 1x 4210469
 1x 4216375
 1x 4490082
 10x 4523159
 2x 4505990
 2x 4287800
 1x 4527065
 10x 4249040

Customer Service
 Kundenservice
 Service Consommateurs
 Servicio Al Consumidor

www.lego.com/service or dial

 : 00800 5346 5555
 : 1-800-422-5346



10185

10197

10211

SHOP

FREE! GRATIS! GRATUIT!



club
MAGAZINE™

www.LEGOclub.com



00800 5346 5555*



1-866-534-6258 • 1-877-518-5346

US & Canada only

Canada seulement

* FreePhone. Mobile charges may apply. * Numéro sans Frais. Des Frais peuvent s'appliquer avec les téléphones cellulaires. * Gebührenfrei, Kosten für Anrufe aus Mobilfunknetzen können abweichen.
* Grátis telefonnummer vanaf vaste lijn. * Dec er ett gratis nummer, när du ringer från Fasttelefon. * Dec er gratis, når du ringer från en Fast telefon.



**VISIT THE WORLD'S
BIGGEST LEGO® SHOP!**

www.LEGOshop.com

WIN!

Go to www.nielsen.com/LEGO
to fill out a survey for a chance
to win a cool LEGO® Product.
No purchase necessary.
Open to all residents where not prohibited.

www.nielsen.com/LEGO

GEWINNE!

Nimm an der Umfrage auf www.nielsen.com/LEGO teil und hab die Chance ein cooles LEGO® Produkt zu gewinnen!

Die Teilnahme am Gewinnspiel führt zu keinerlei Kaufverpflichtungen. Teilnahme in allen nicht ausgeschlossenen Ländern möglich.

©2010 The LEGO Group. 4584866 / 6002342

WIN!

Ga naar www.nielsen.com/LEGO, vul een enquêteformulier in en maak kans op een cool LEGO® product.

Geen aankoopverplichting.
Iedereen mag deelnemen, uitgezonderd ingezetenden van landen waar een enquêteverbod geldt.

GAGNE !

Visite www.nielsen.com/LEGO pour répondre à un questionnaire et avoir une chance de gagner un produit LEGO® très cool !

Aucune obligation d'achat.
Ouvert à tous les résidents des pays autorisés.

当てよう!

www.nielsen.com/LEGOにアクセスして、アンケートにご記入ください。当選者にはレゴ®製品を差し上げます。

お買い上げの必要はありません。
禁止されていない限り、すべての皆様にご利用いただけます。