

LEGO

10224

2





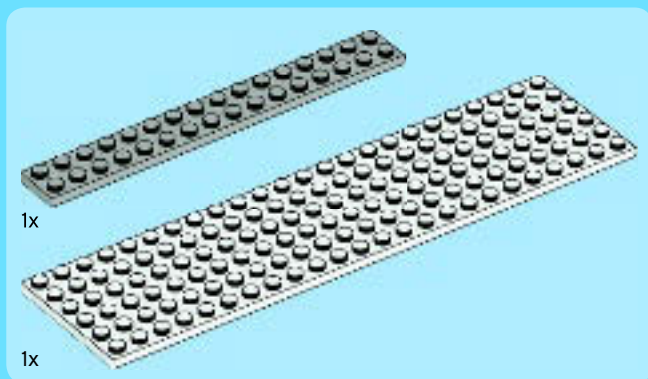

1

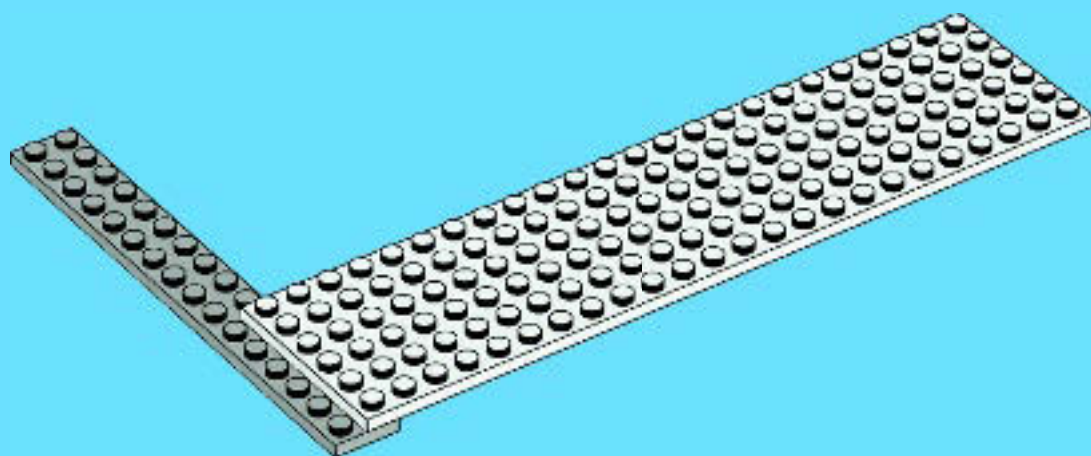

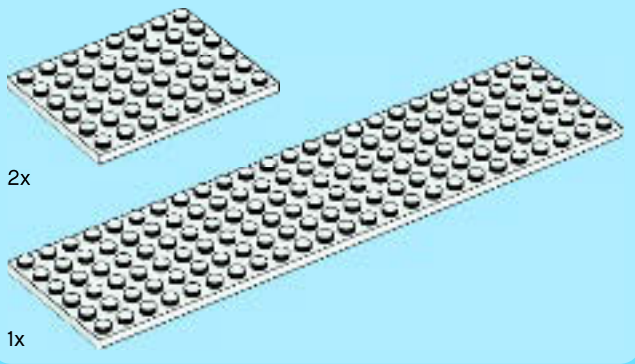

2

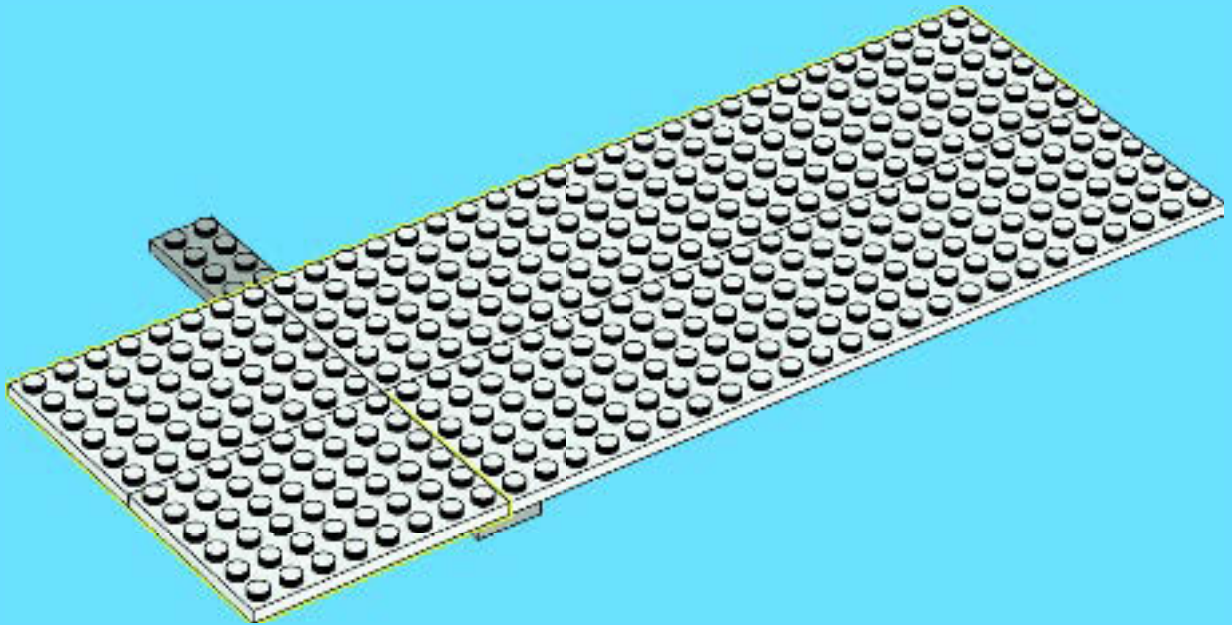

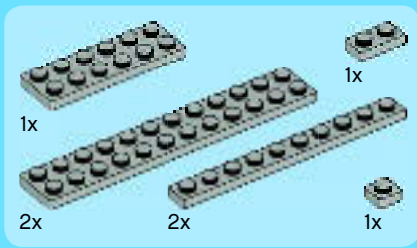

3

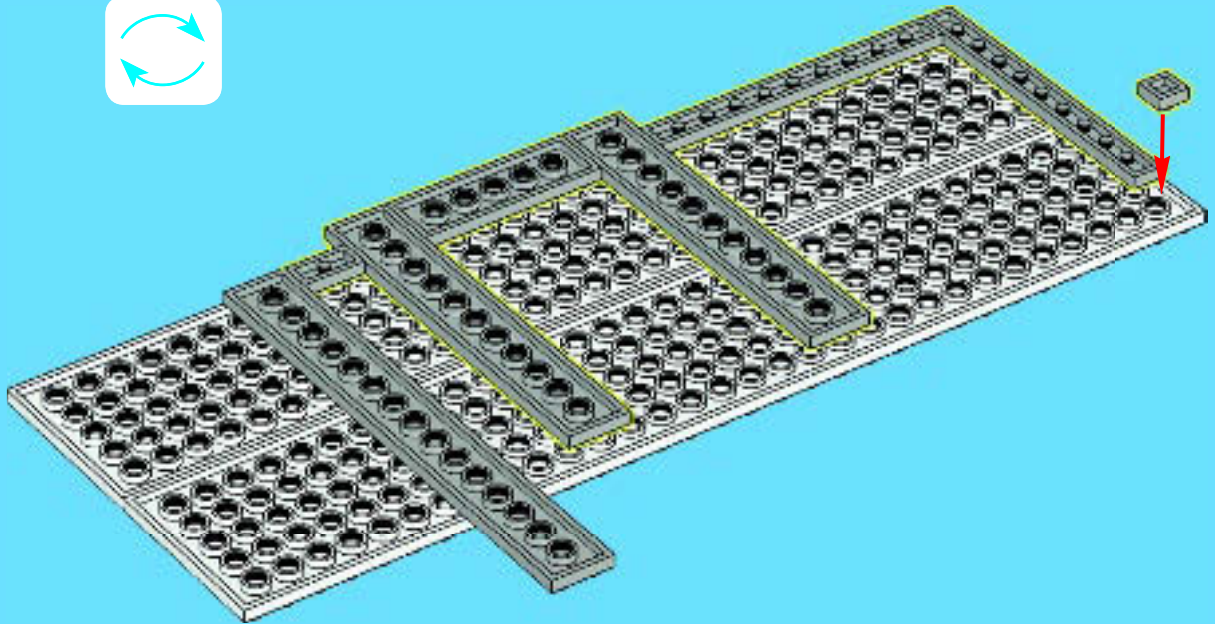

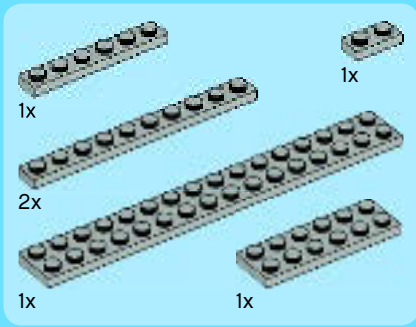

4

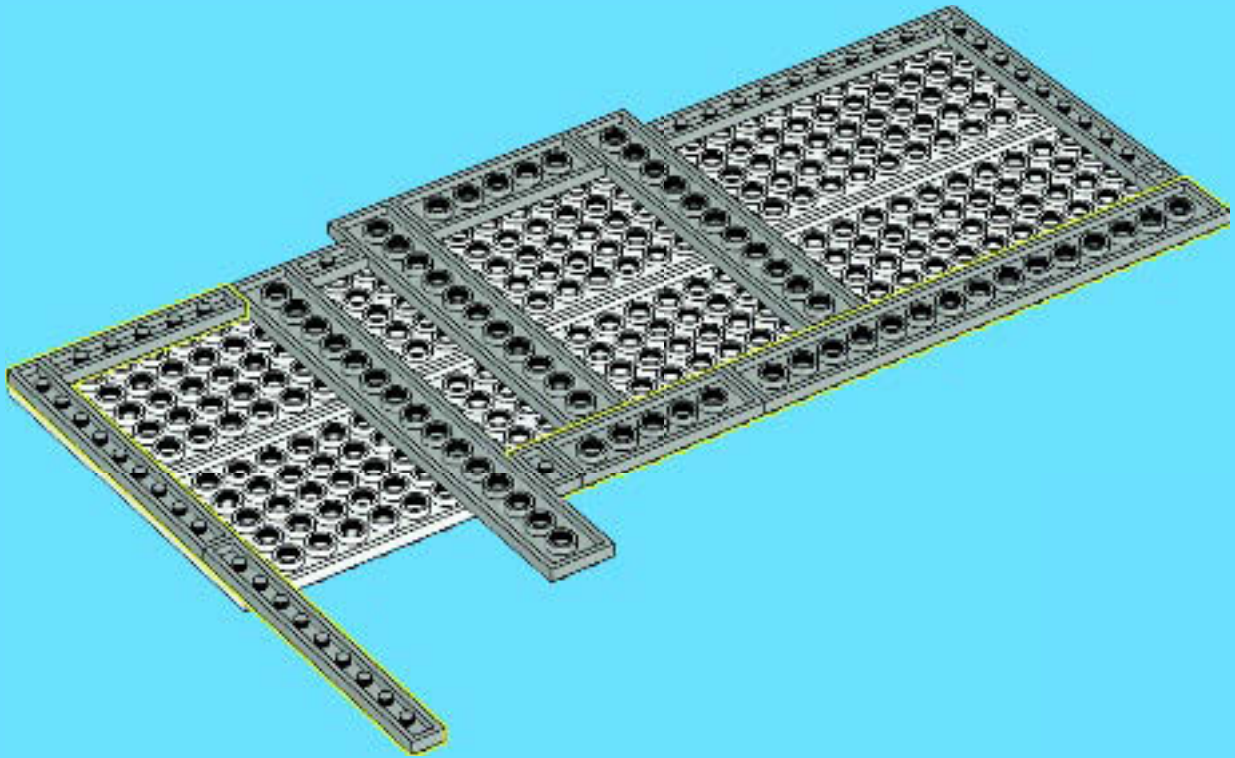

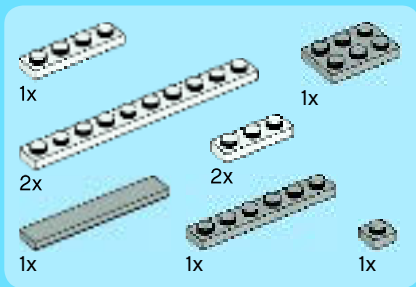

5

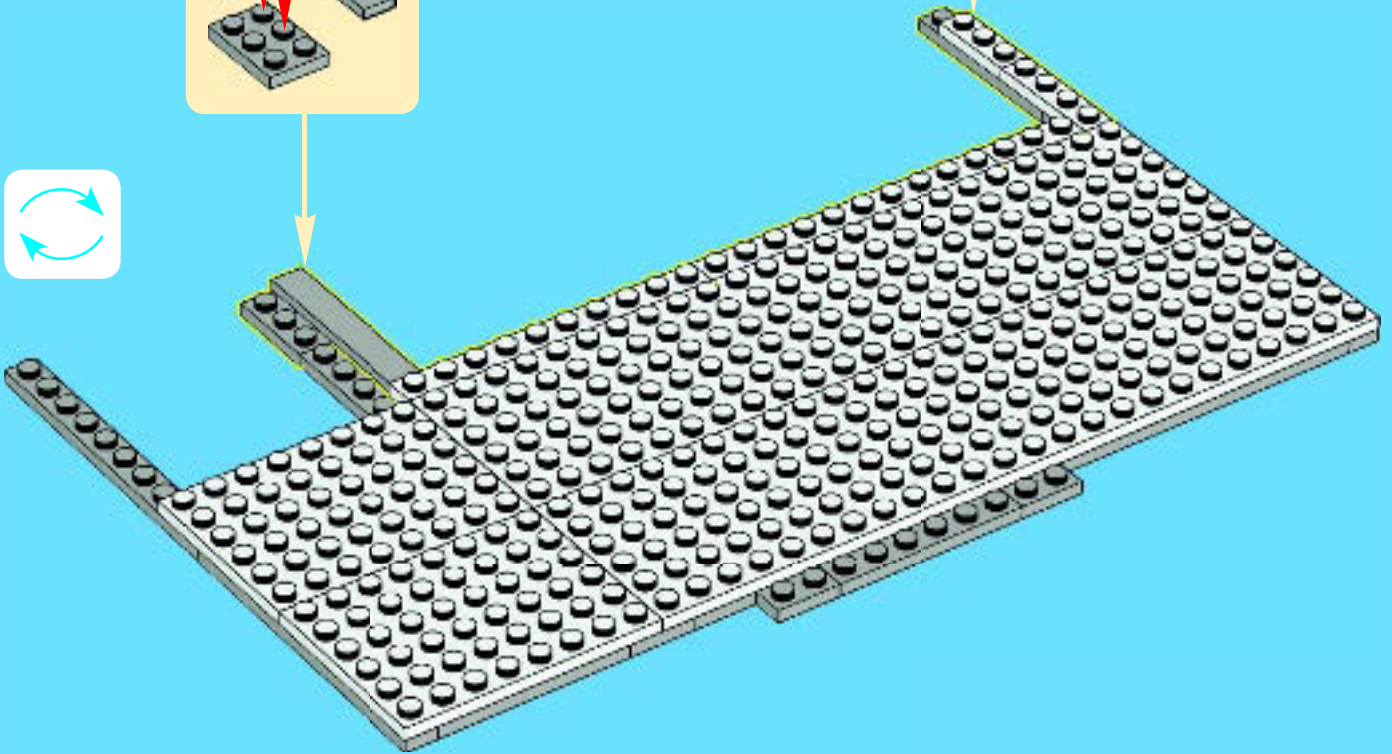
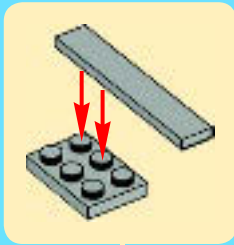
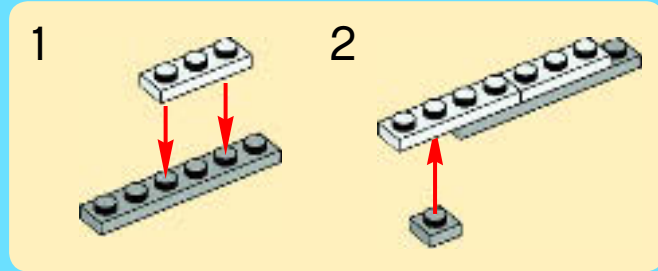

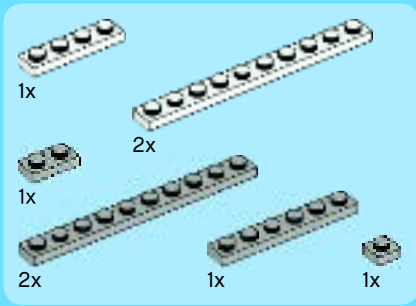

6

1

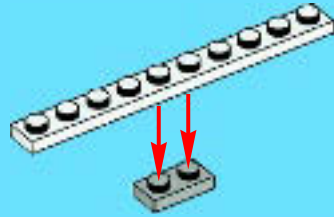

2

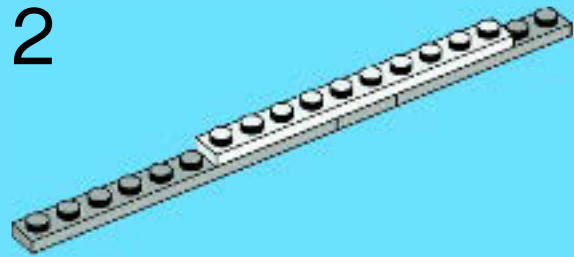

3

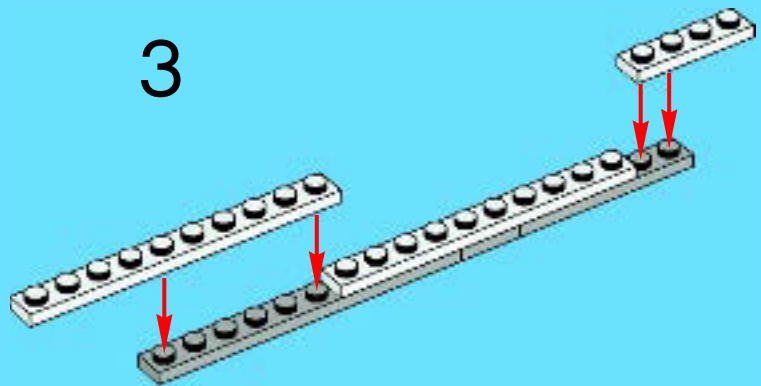

4

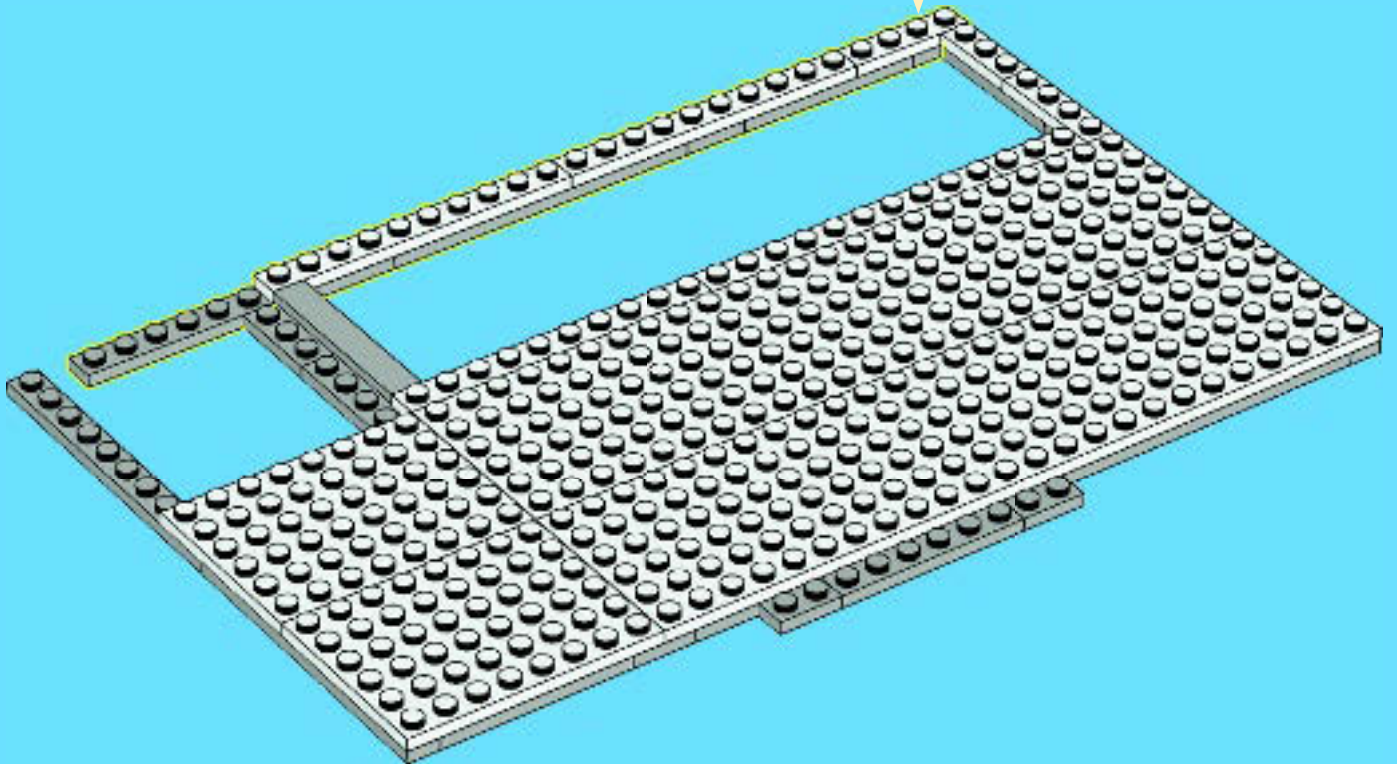
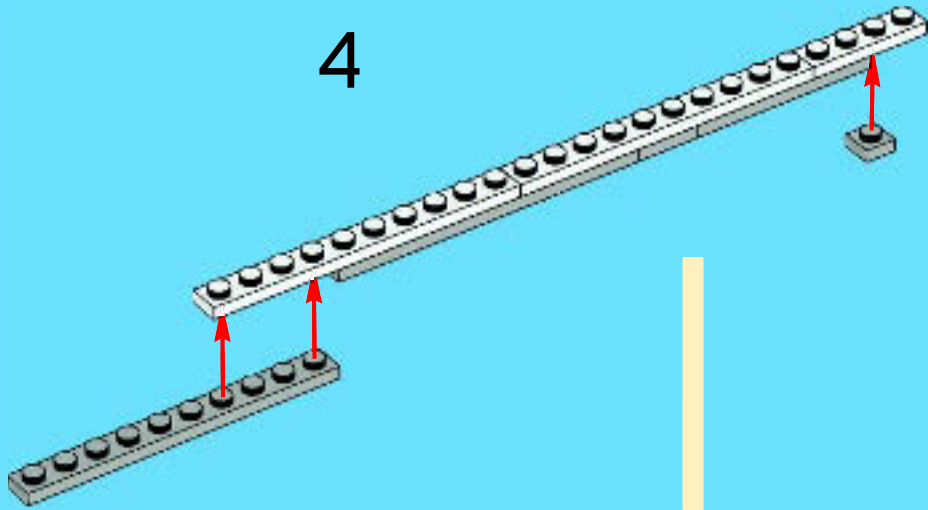

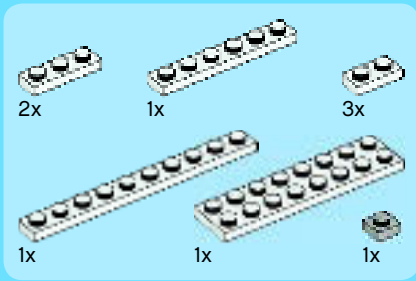

7

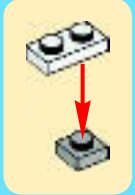
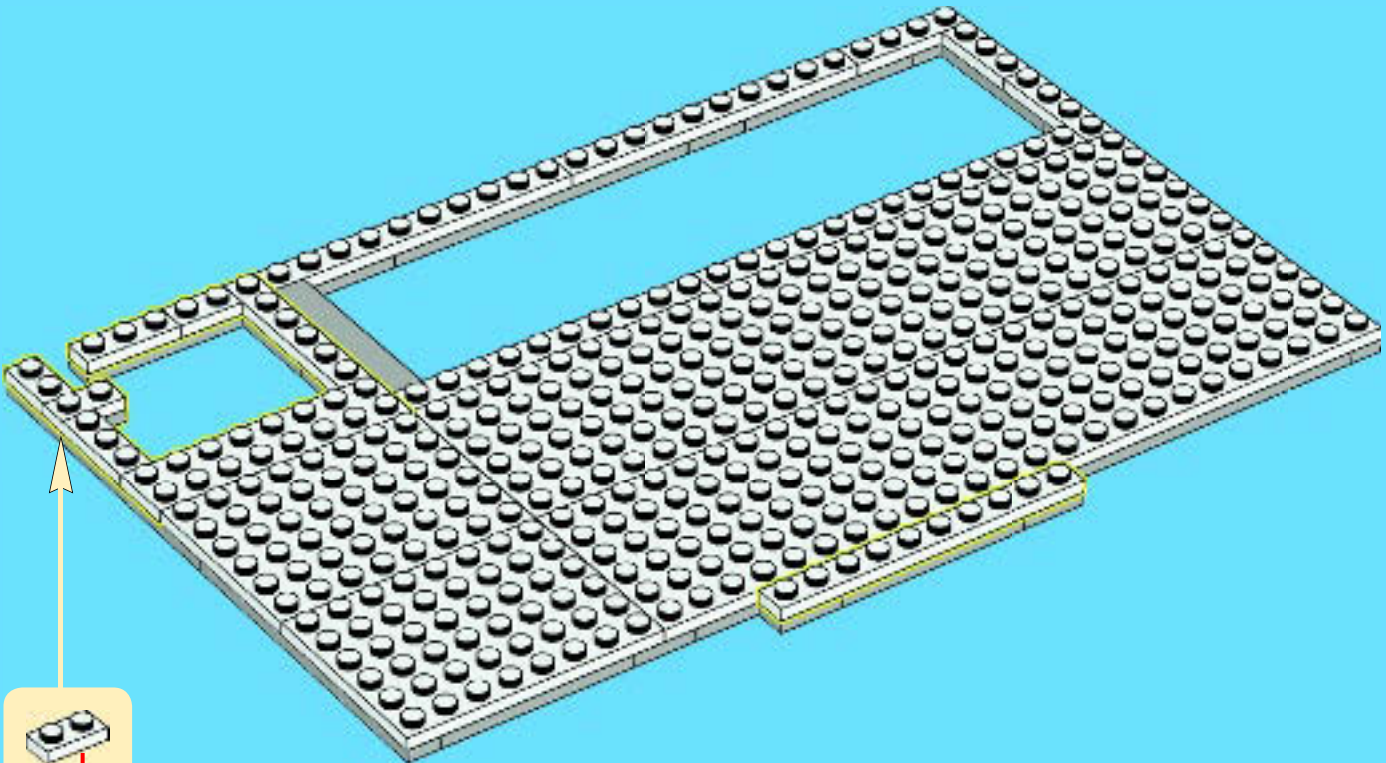

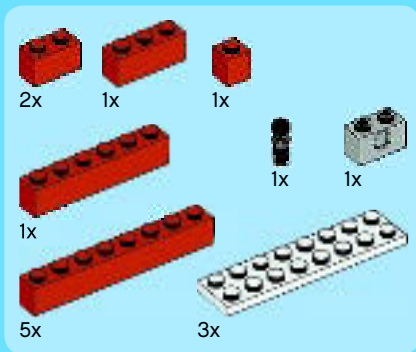

8

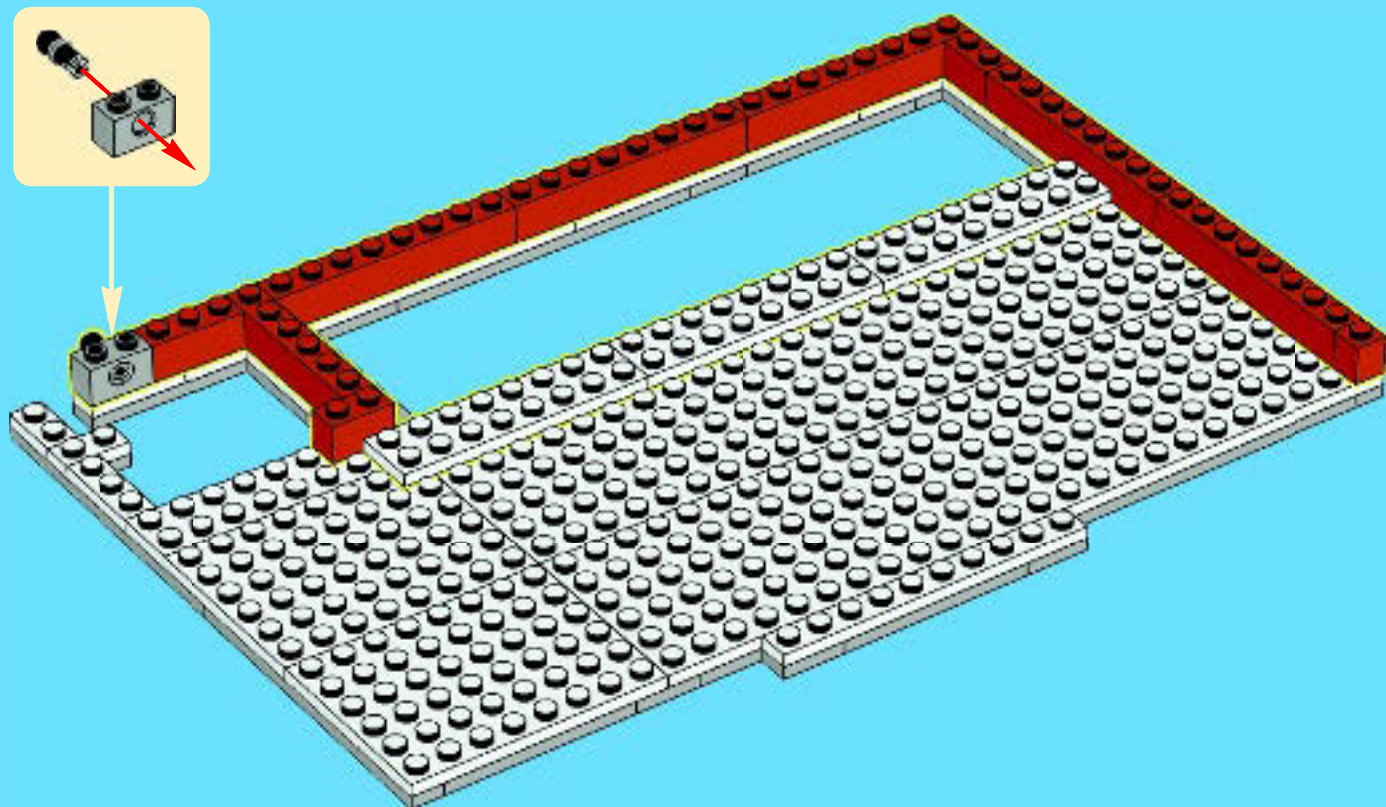
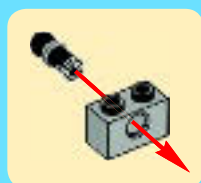

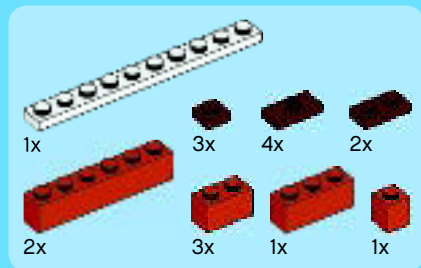

9

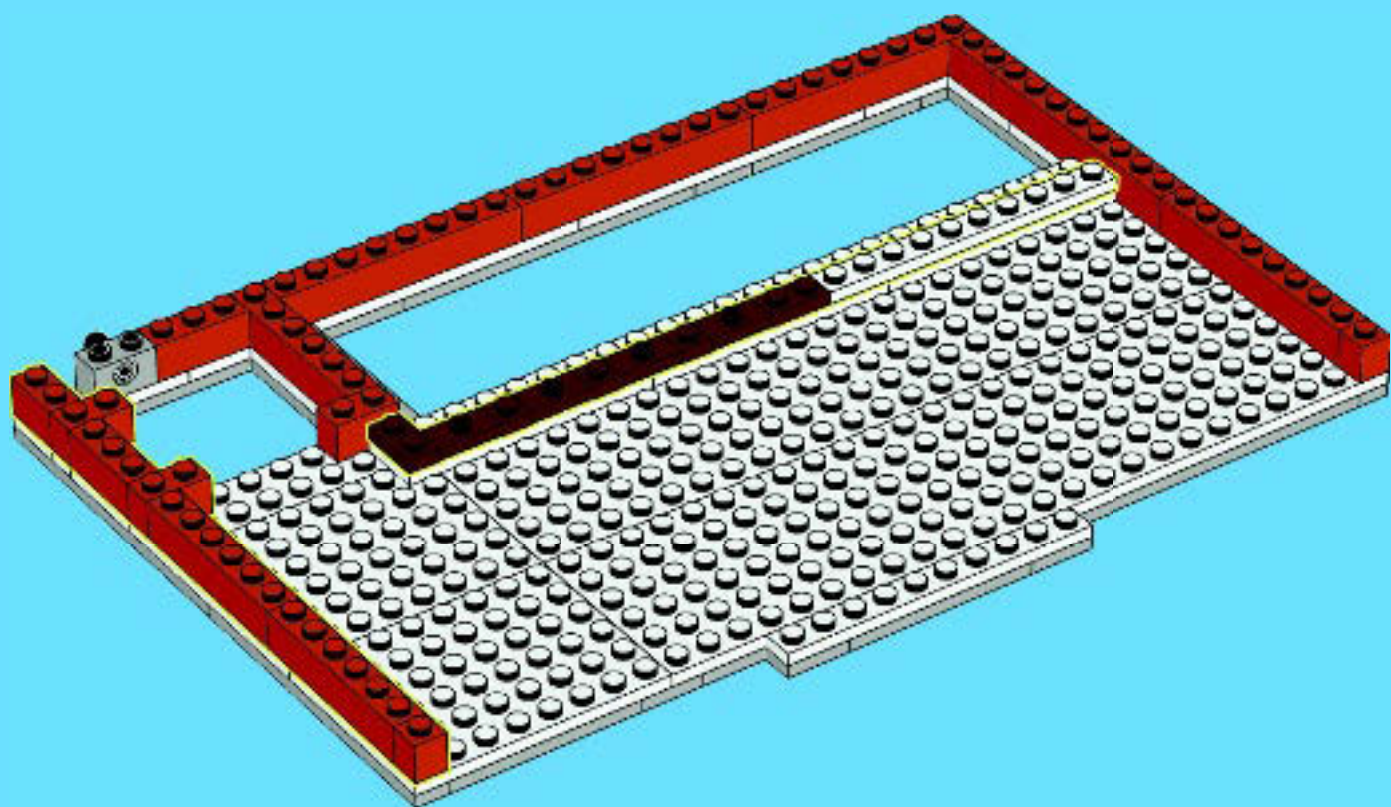

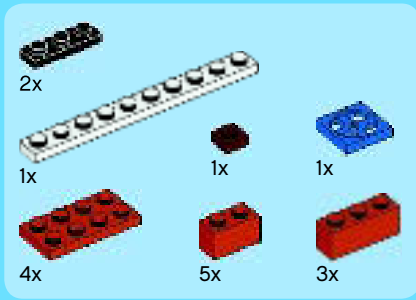

10

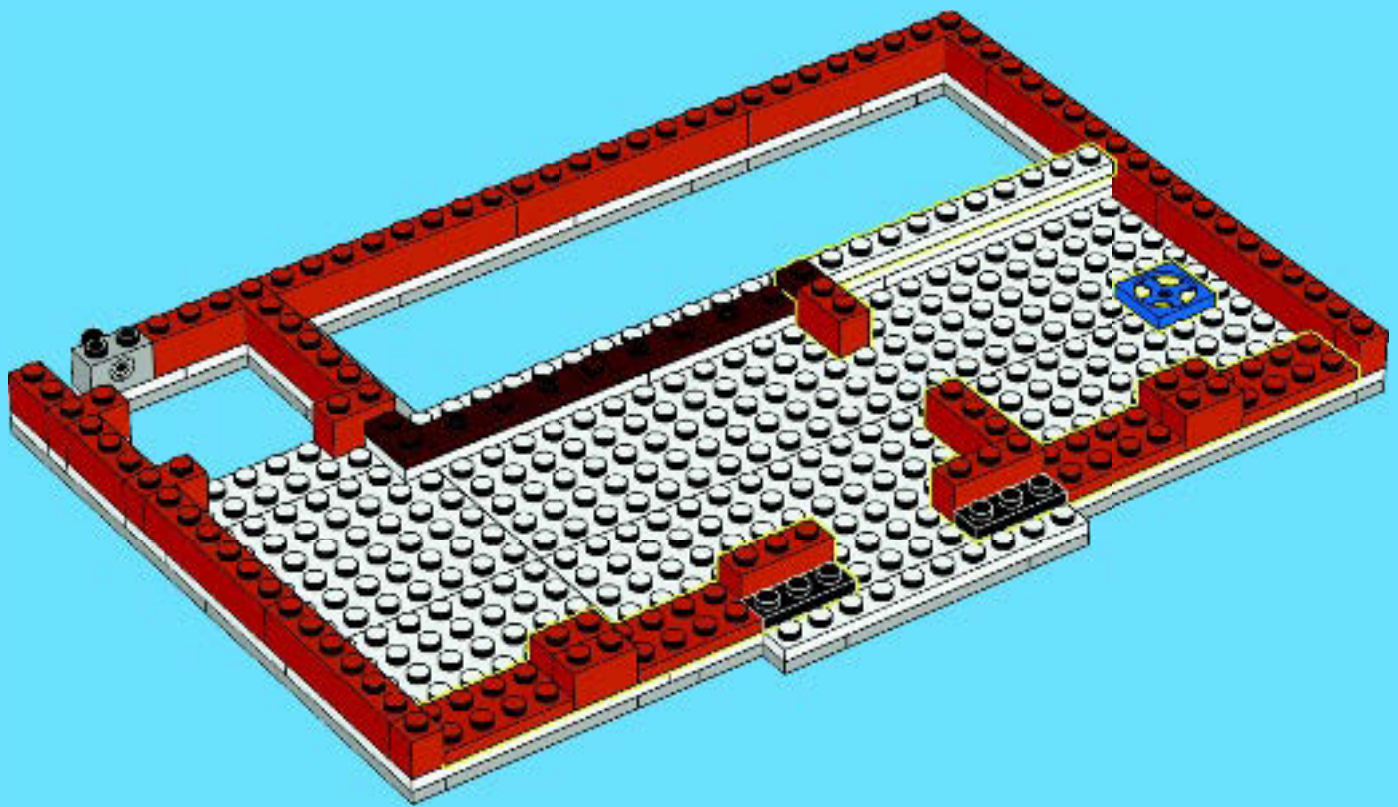



11

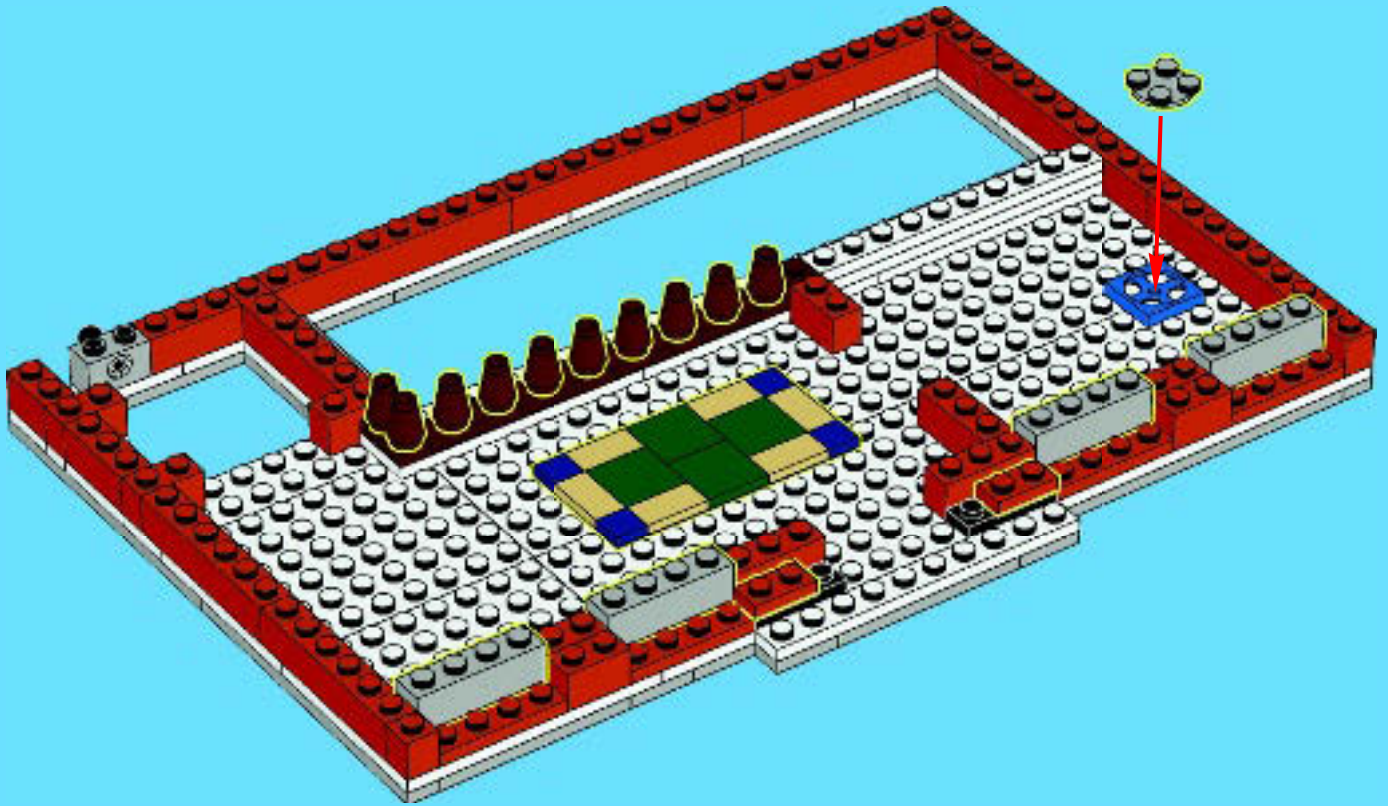

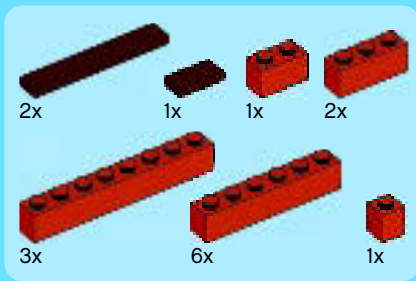

12

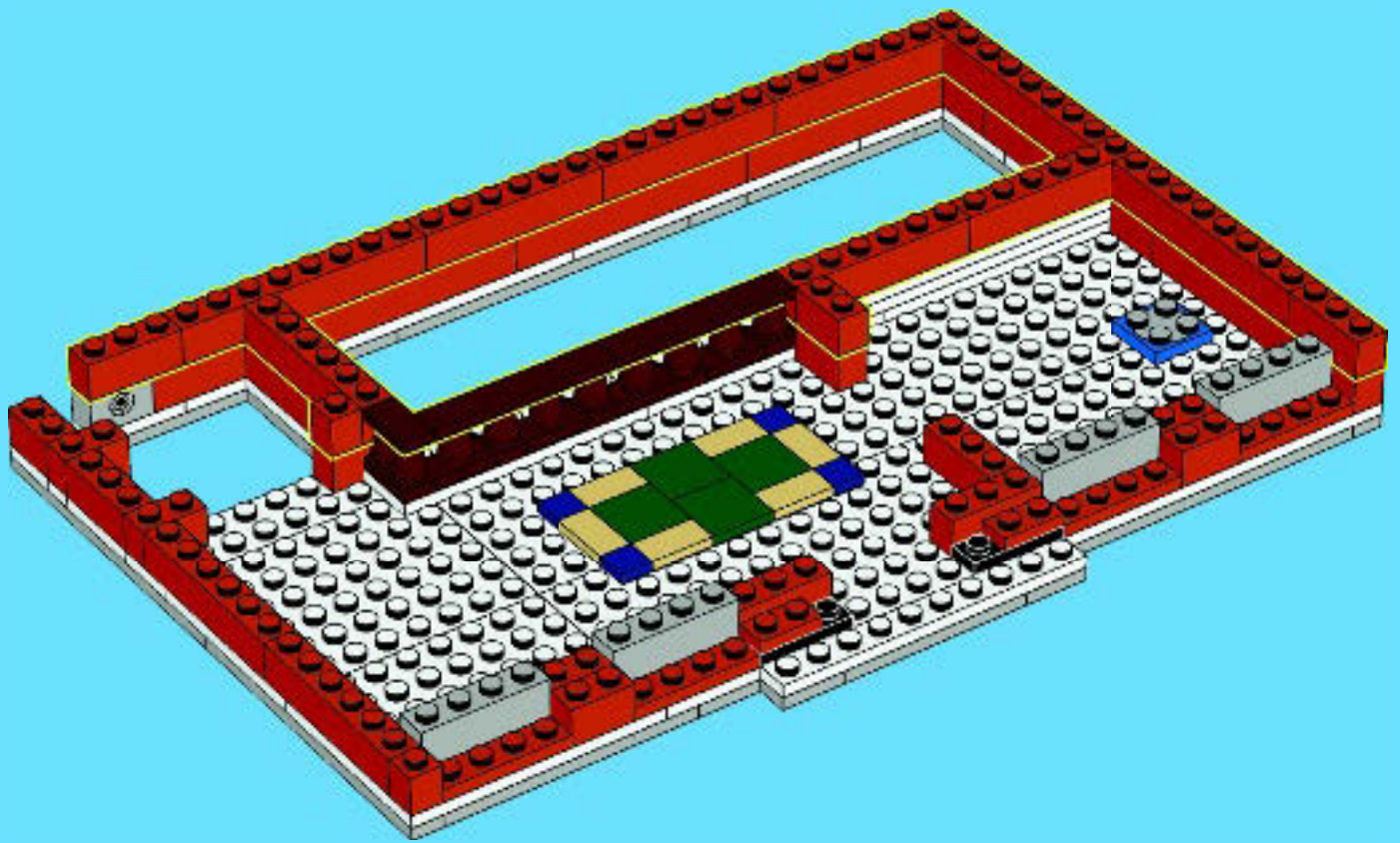



4x



8x



8x

13

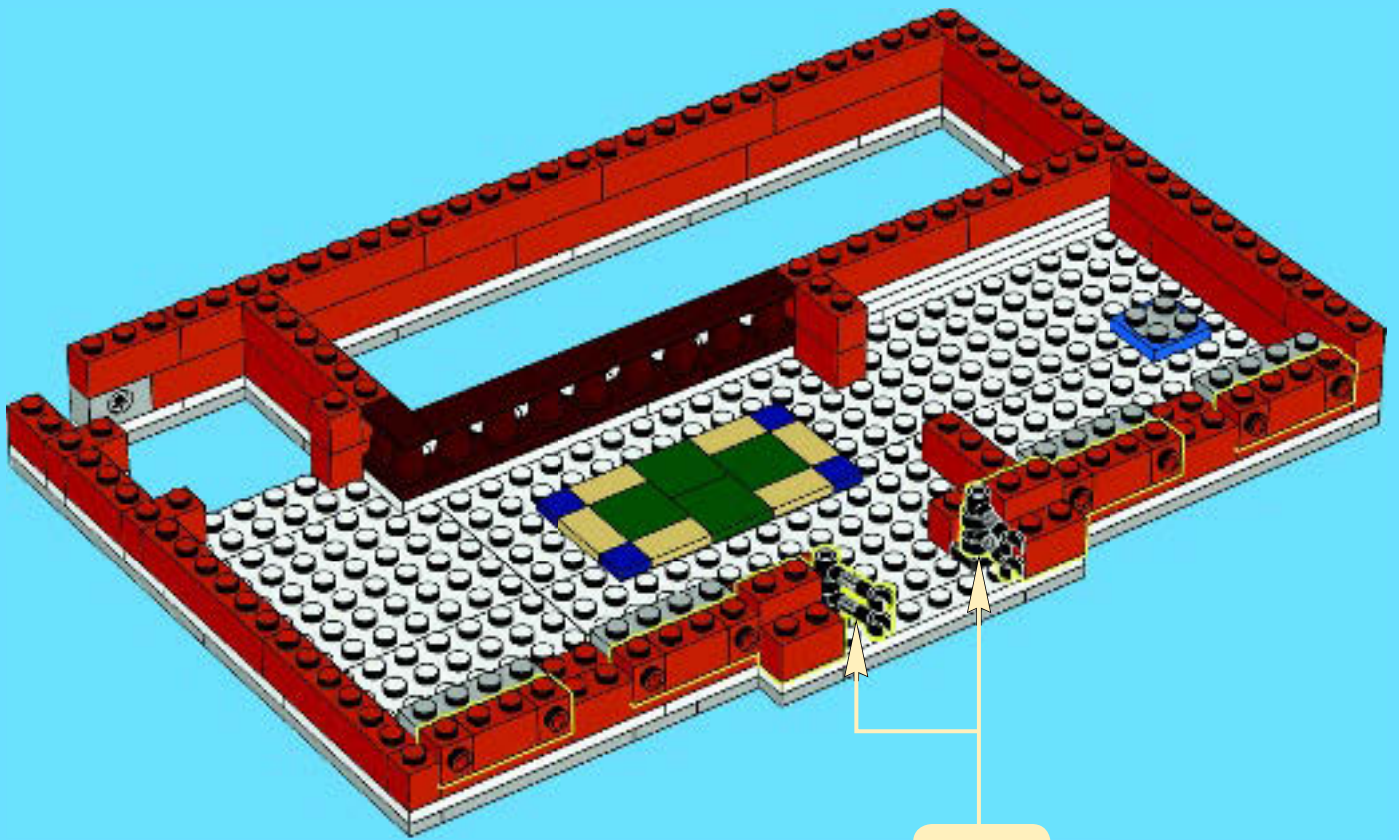

2x

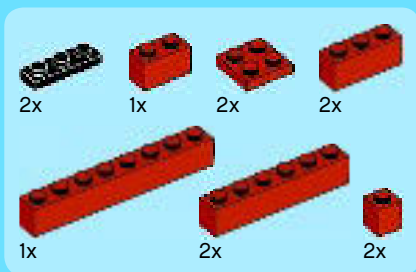

14

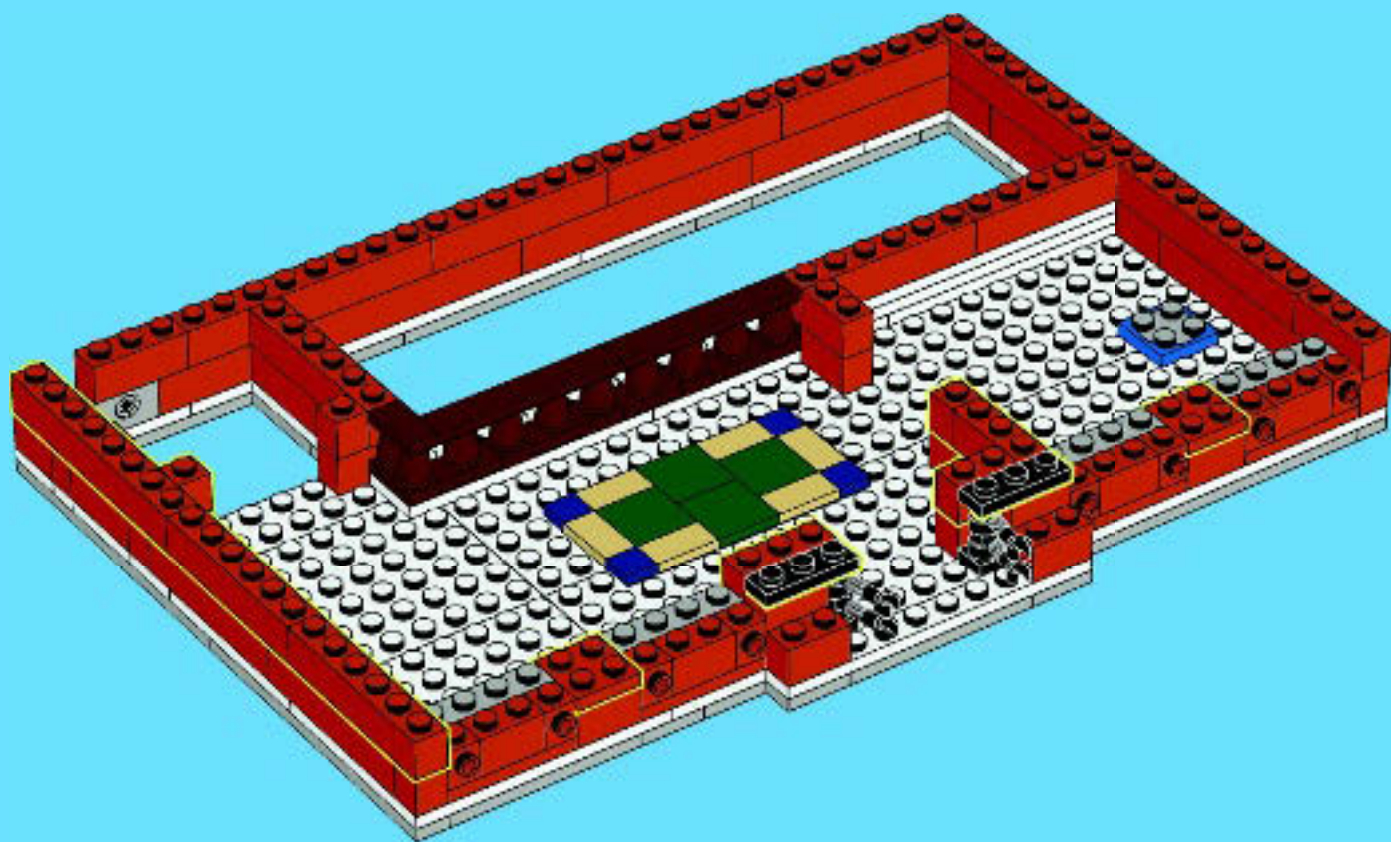

- 1x
- 1x
- 4x
- 6x
- 6x
- 6x
- 1x
- 2x
- 2x
- 1x
- 2x



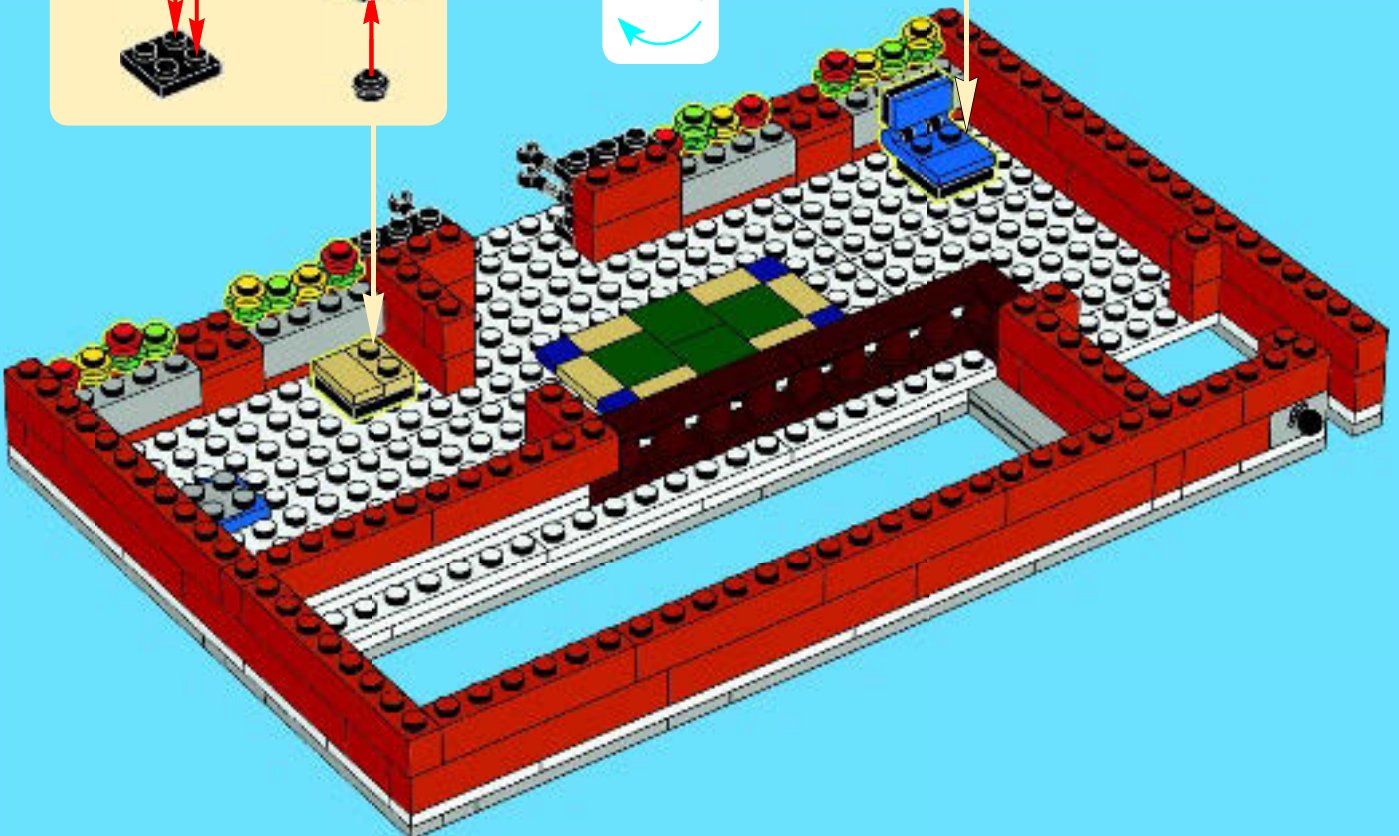
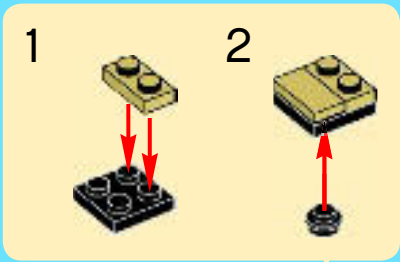
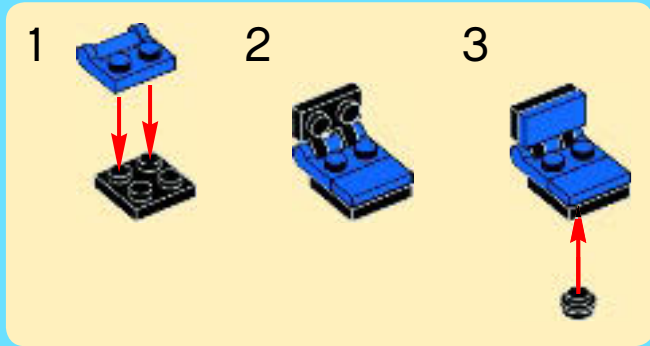

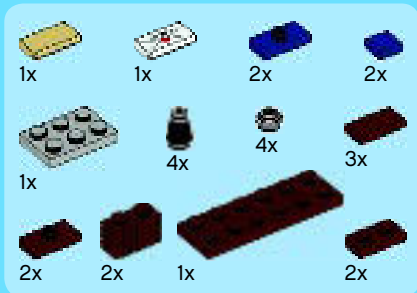



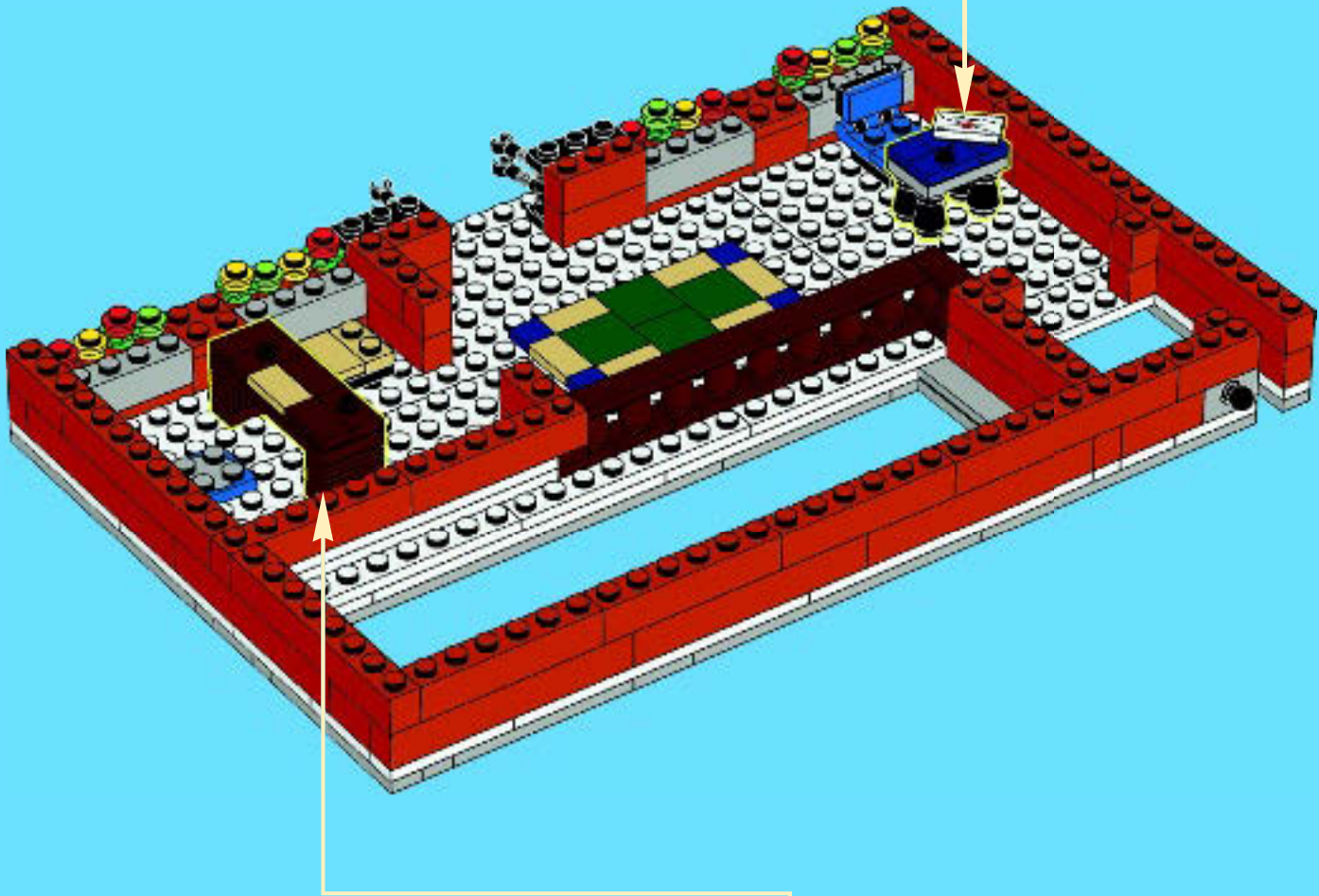
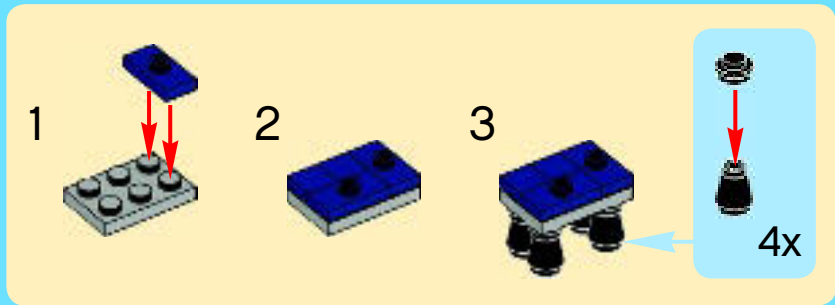

15





16



- | | | | | |
|--|---|---|---|--|
| 
1x | 
1x | 
1x | 
1x | 
1x |
| 
1x | 
1x | 
2x | 
1x | |
| 
1x | 
1x | 
2x | 
1x | |

17

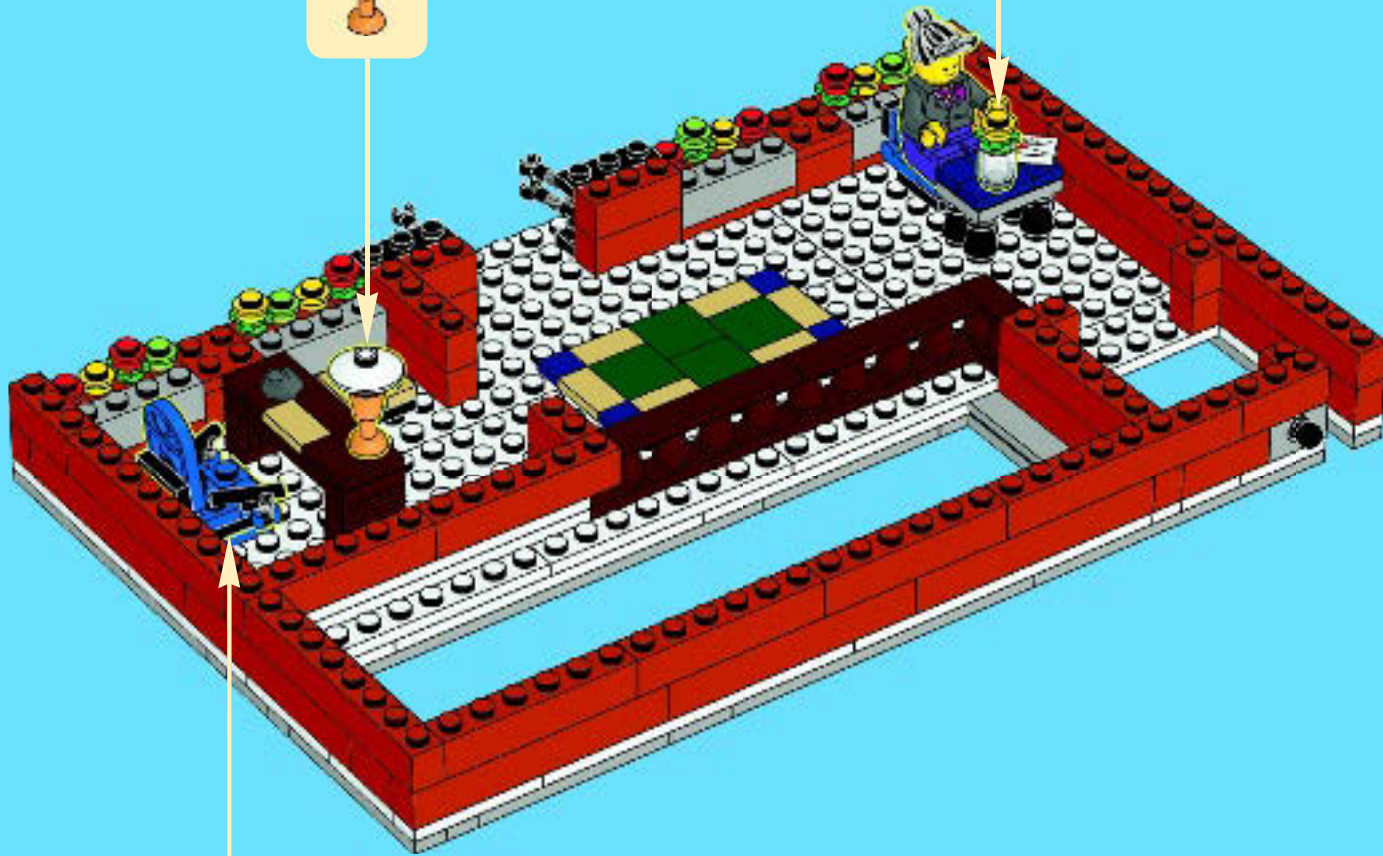
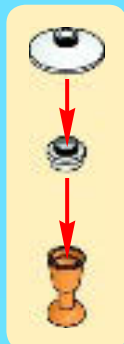

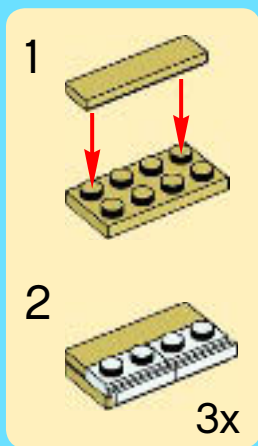
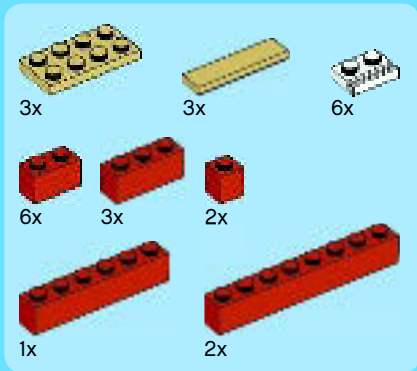

18

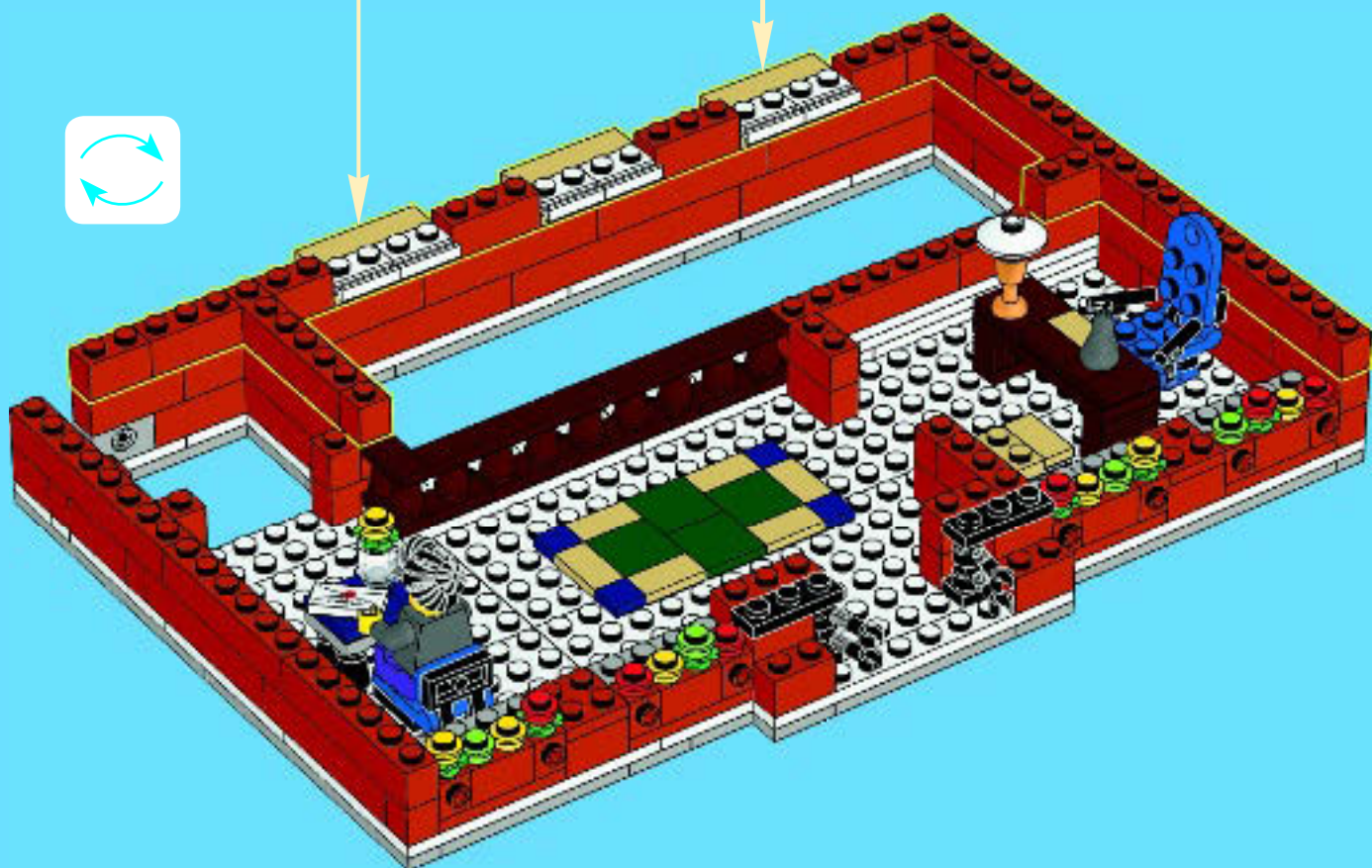

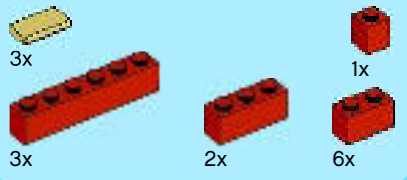

19

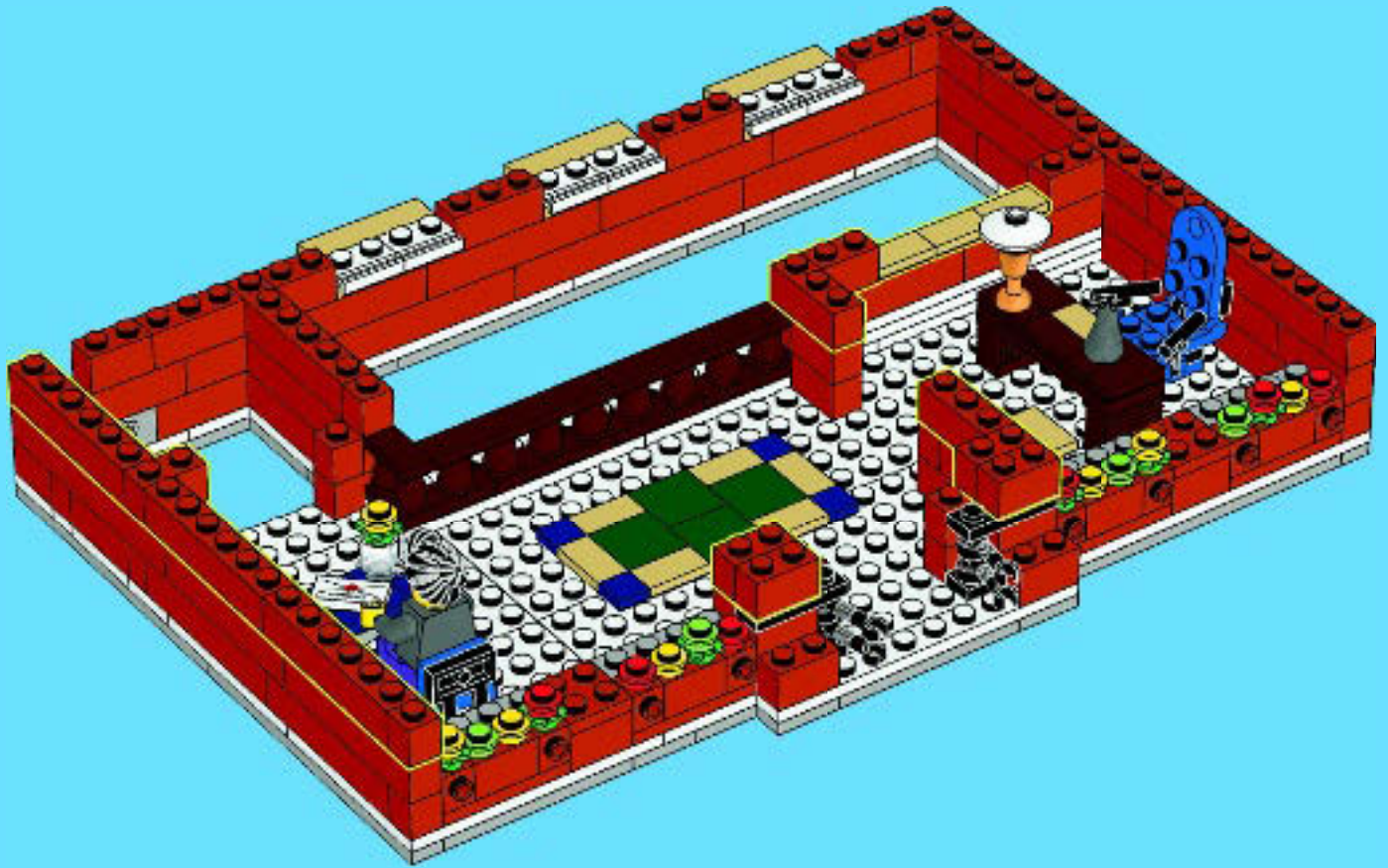

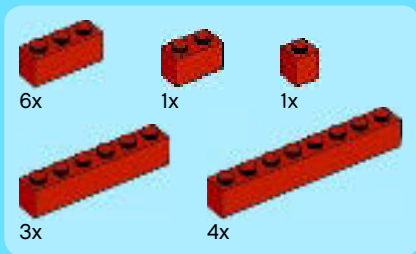

20



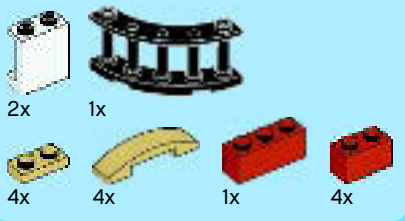

21

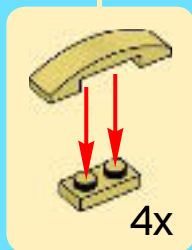
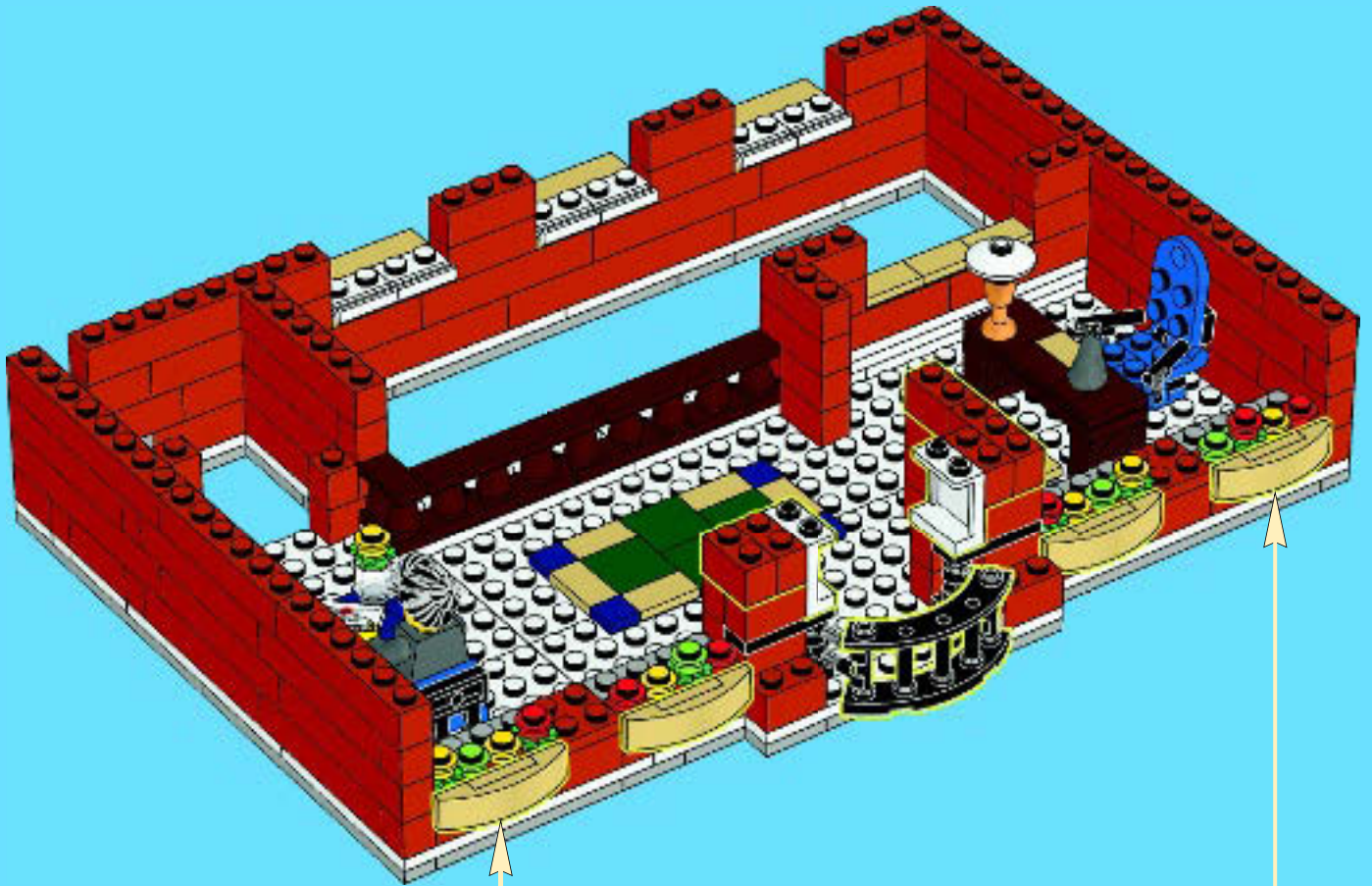

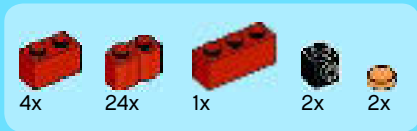

22

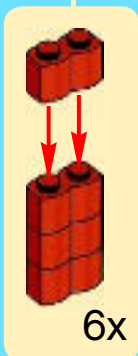
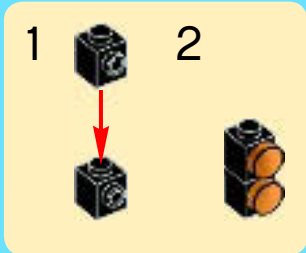

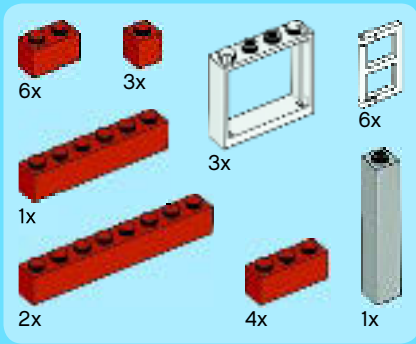

23

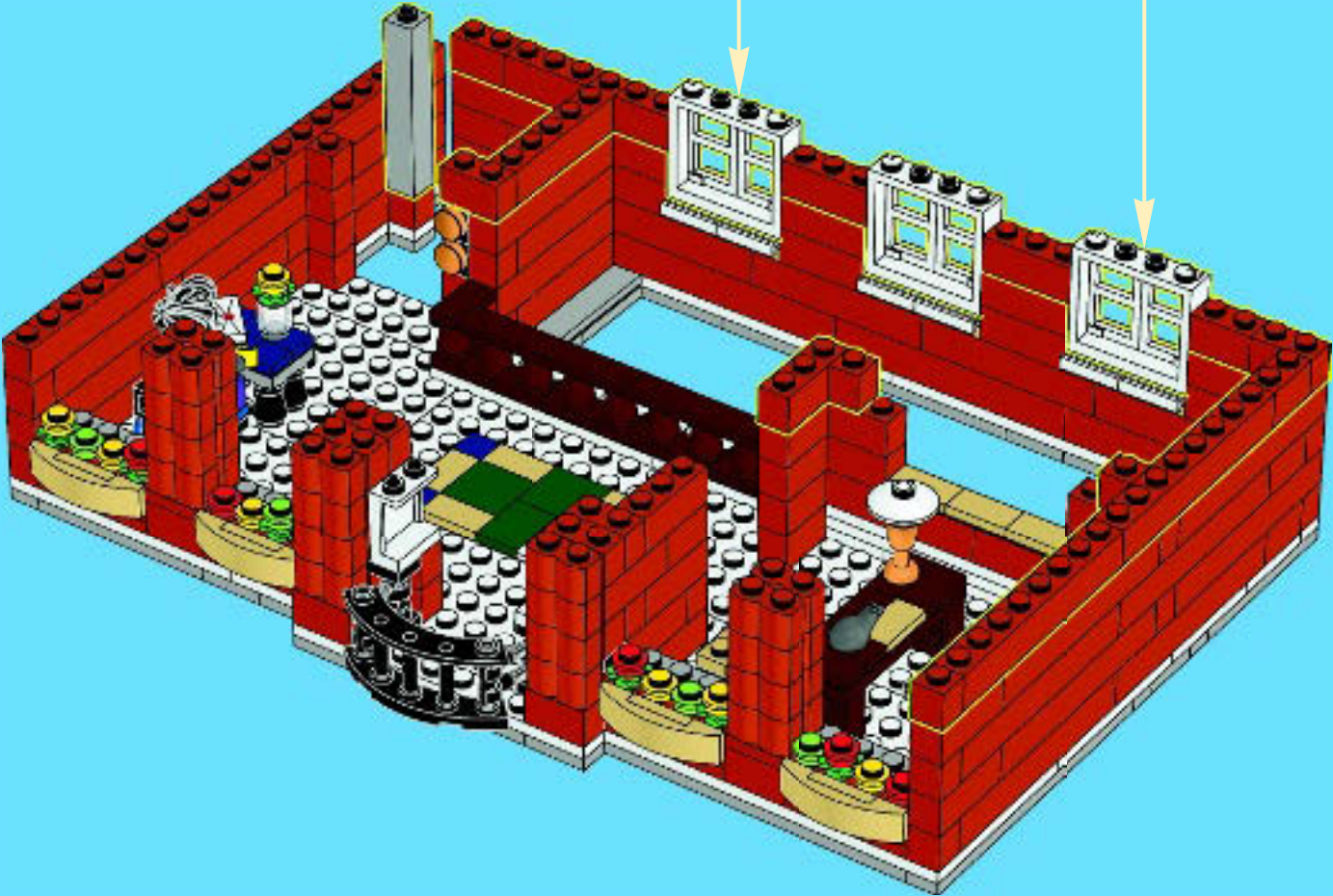
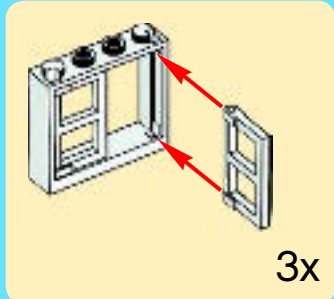

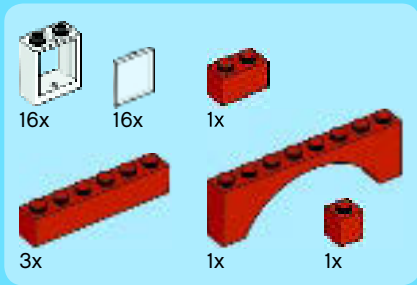

24

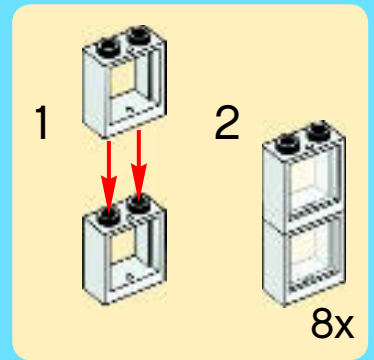

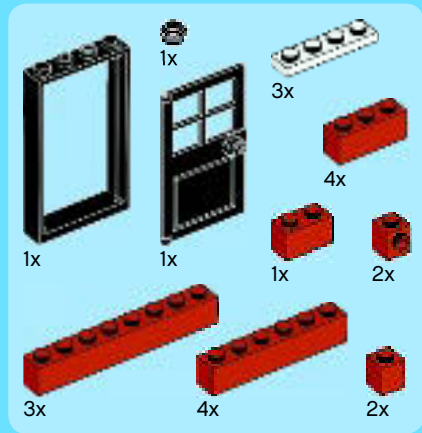

25

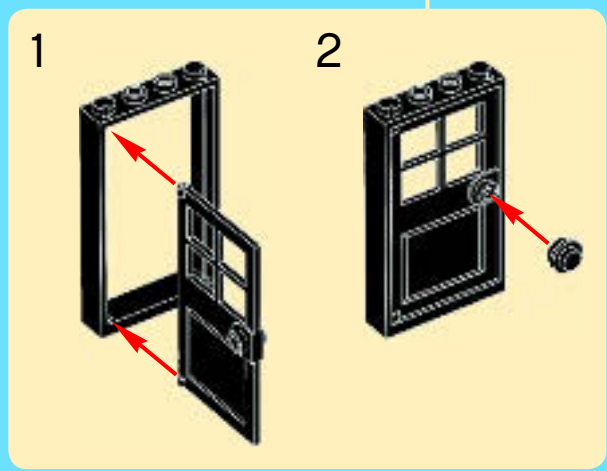

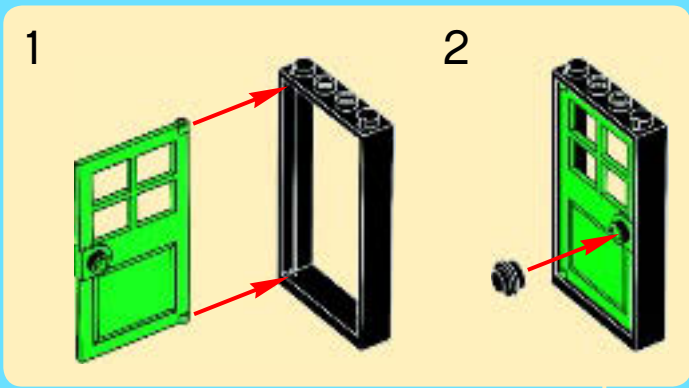
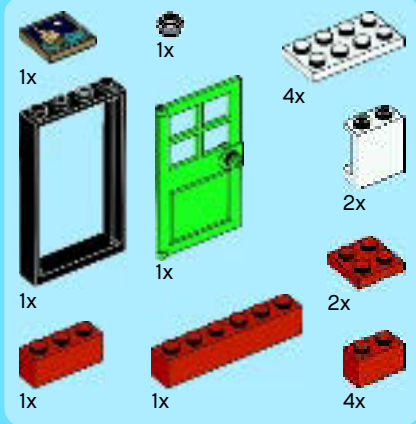

26



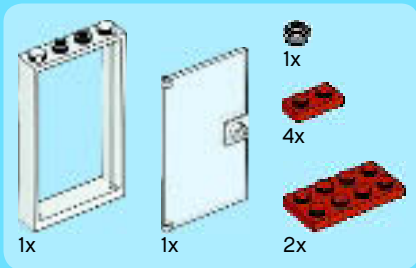

27

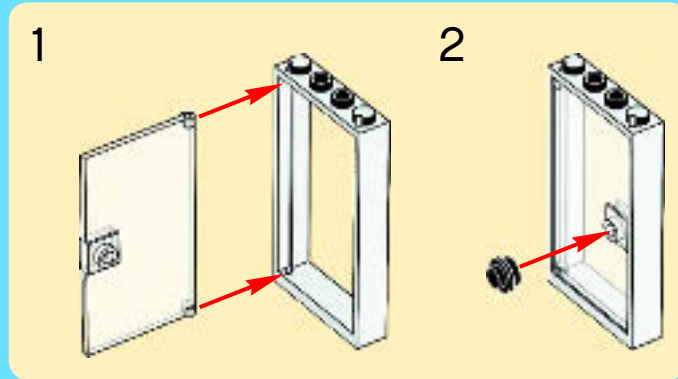

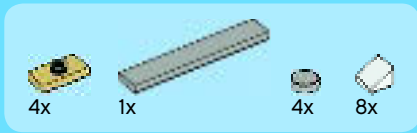

28

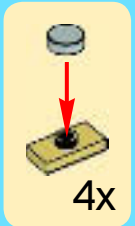



2x



5x



4x



4x

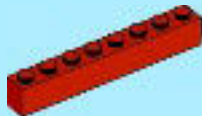

4x

29

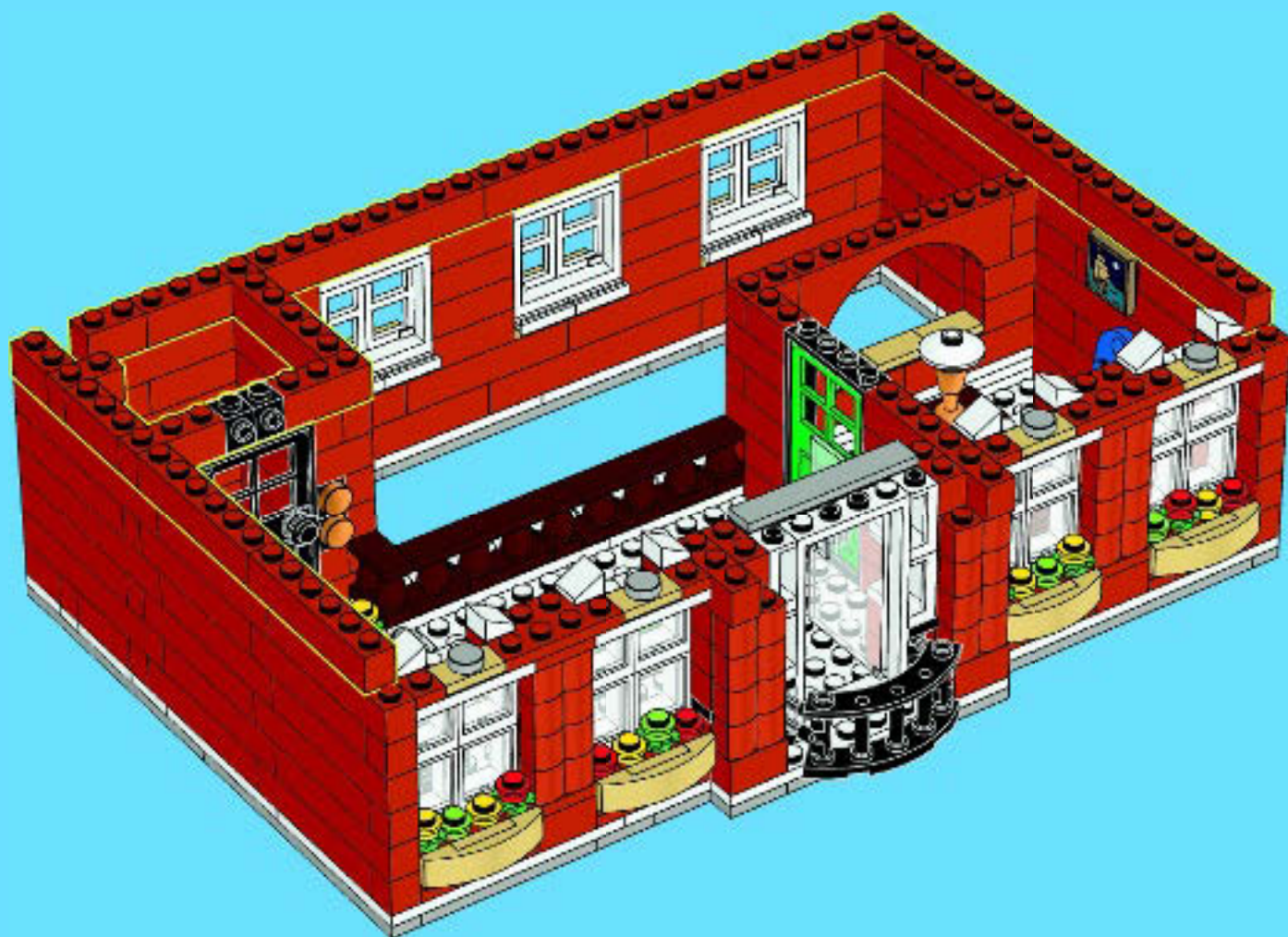

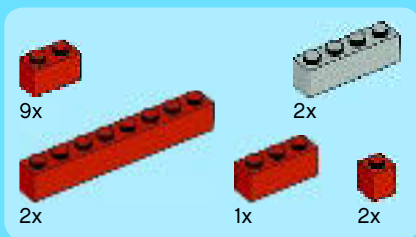

30



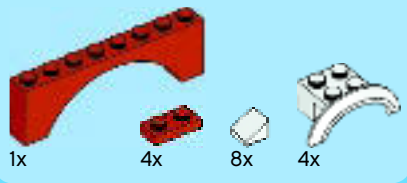

31

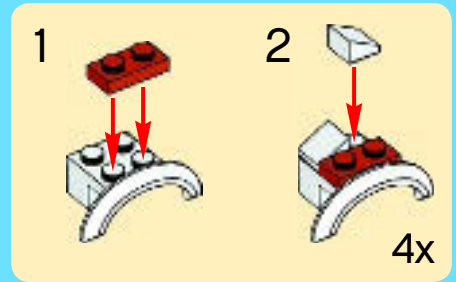

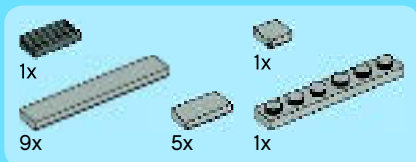

32



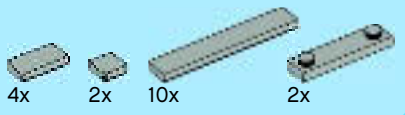

33







10222



10220



Trademarks, design patents and copyrights are used with the approval of the owner Volkswagen AG./Les marques déposées, les brevets de conception et les copyrights sont utilisés avec l'autorisation du propriétaire Volkswagen AG./El uso de las marcas comerciales, patentes de diseño y derechos de autor se realiza con el consentimiento de su propietario, Volkswagen AG.



CREATOR

5770

5771



 www.LEGO.com

LEGO and the LEGO logo are trademarks of the/sont des marques de commerce de/son marcas registradas de LEGO Group. ©2012 The LEGO Group. 6020962 / 6020965

creator.LEGO.com