

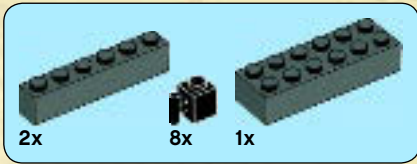

THE LORD OF THE RINGS

10237





32





32x



2x

33

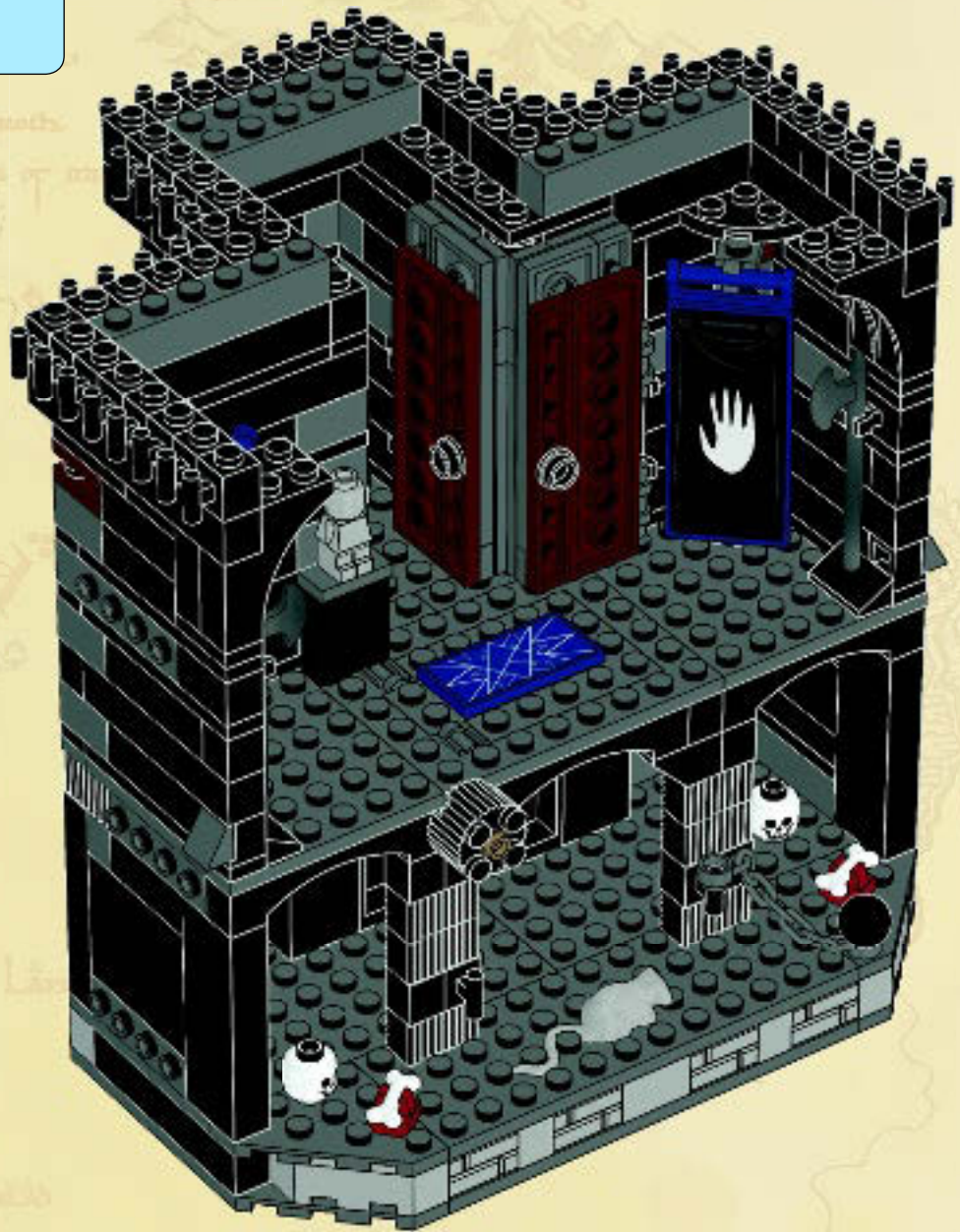

THE LORD OF THE RINGS



LE SEIGNEUR DES ANNEAUX



EL SEÑOR DE LOS ANILLOS

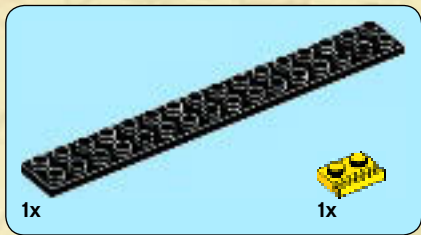

1

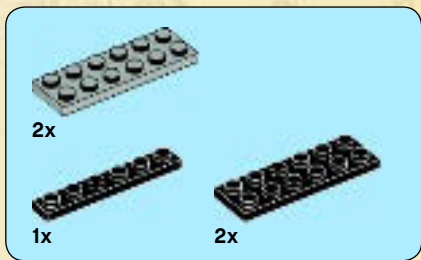
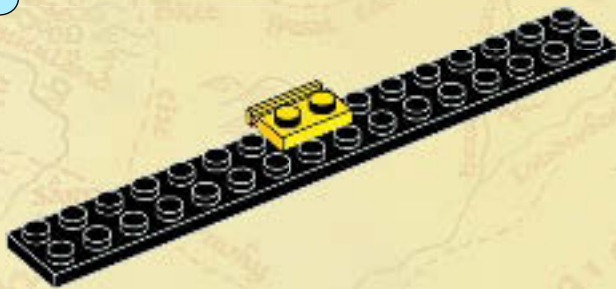

2

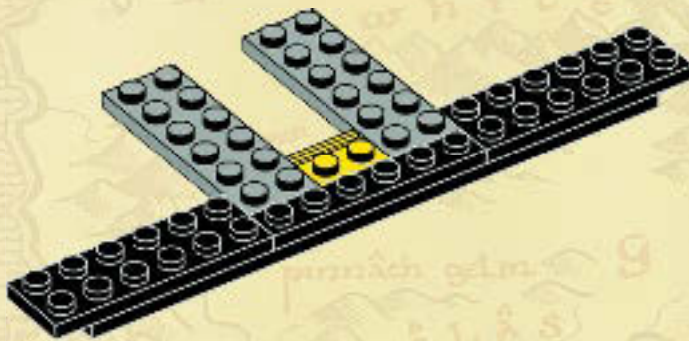

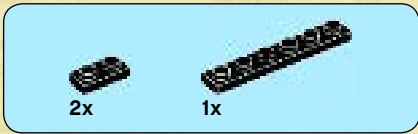

3

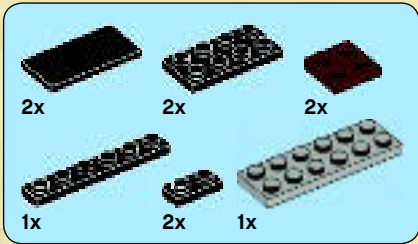
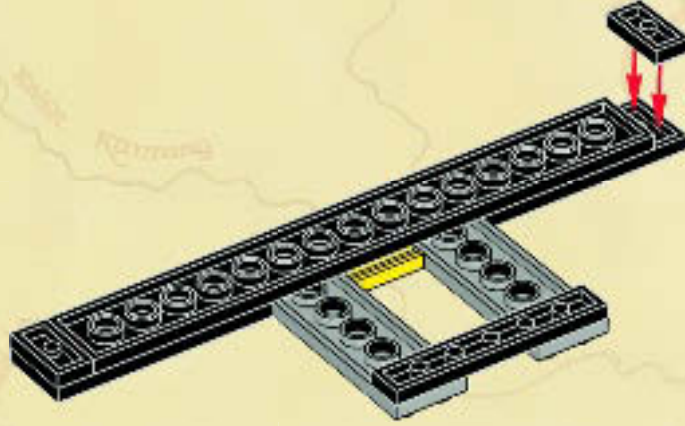

4

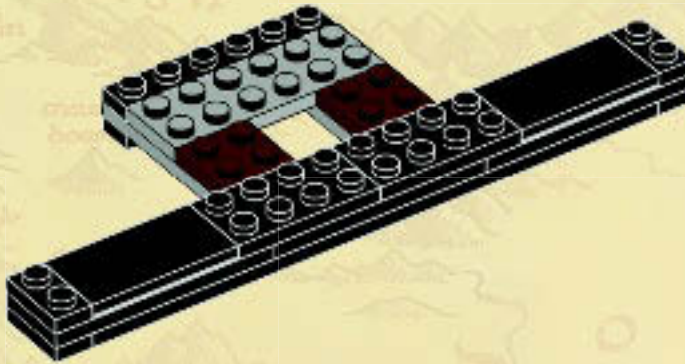

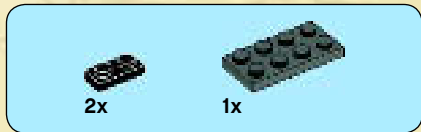

5

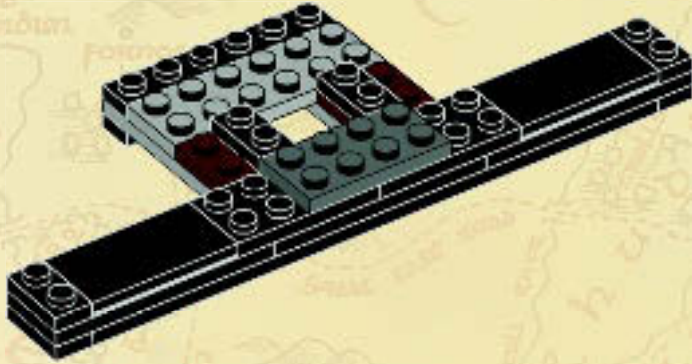

34

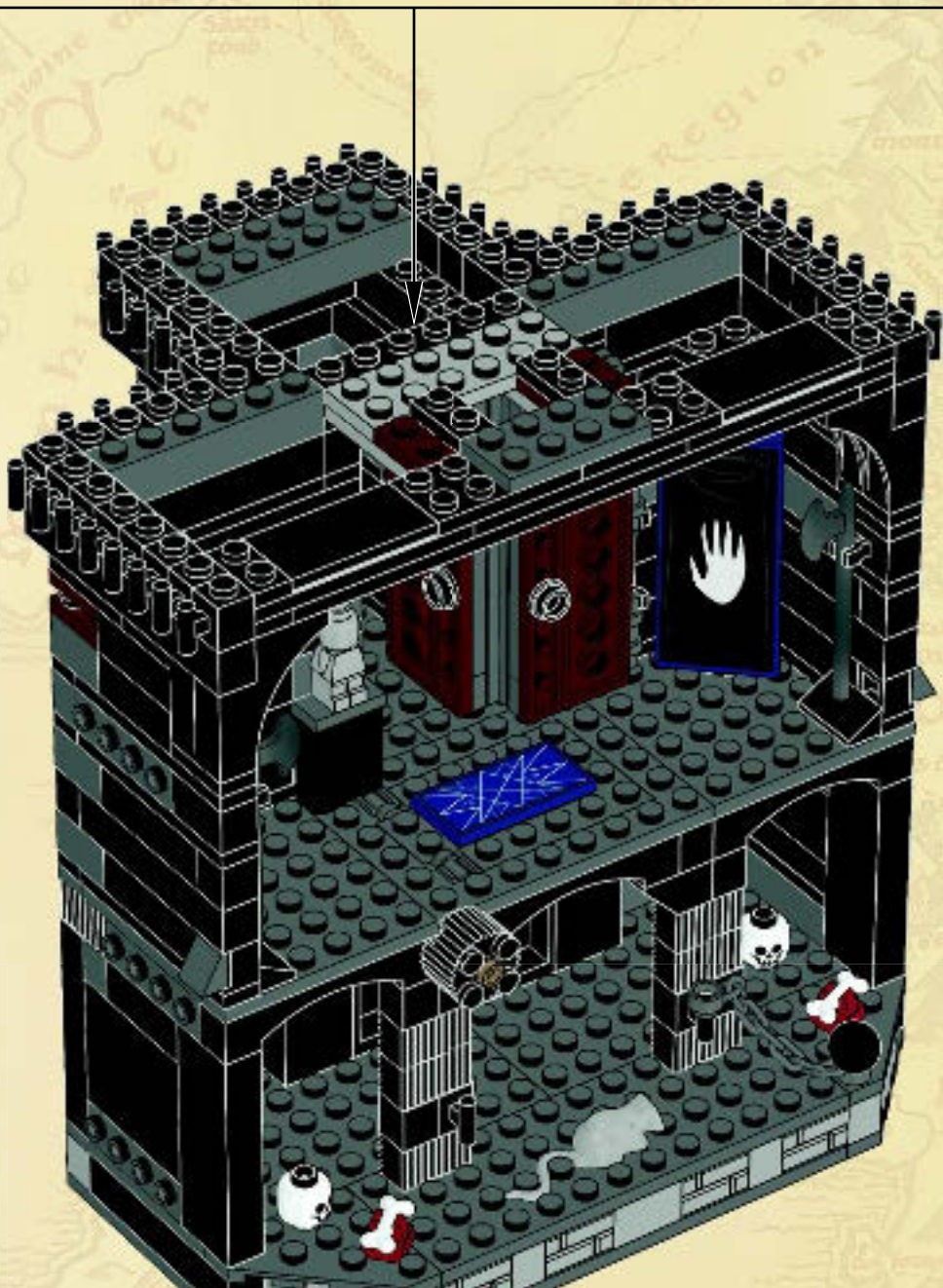

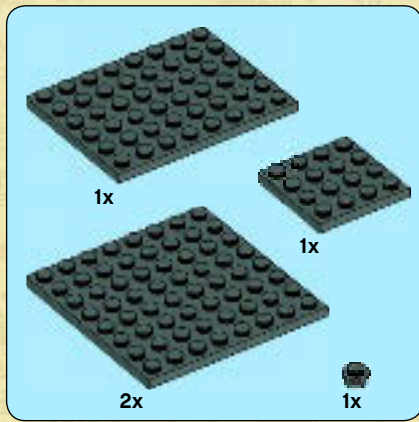

35

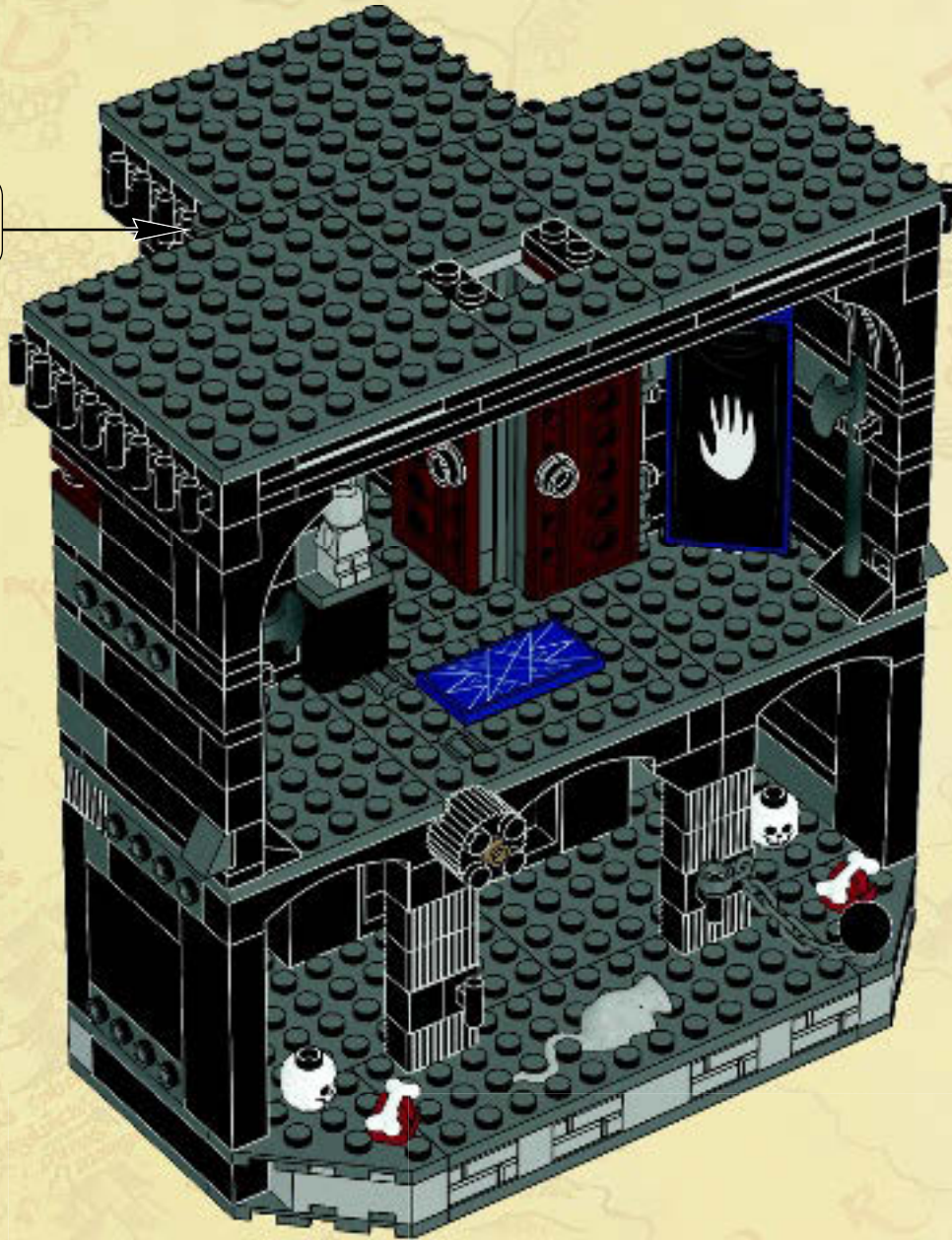



1

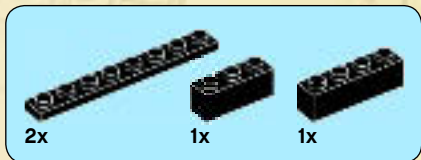
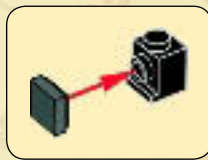

2



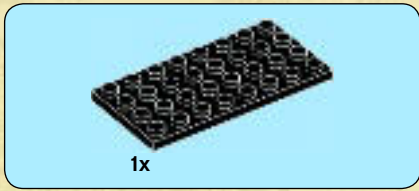

3

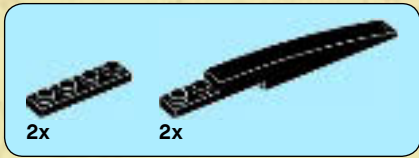

4

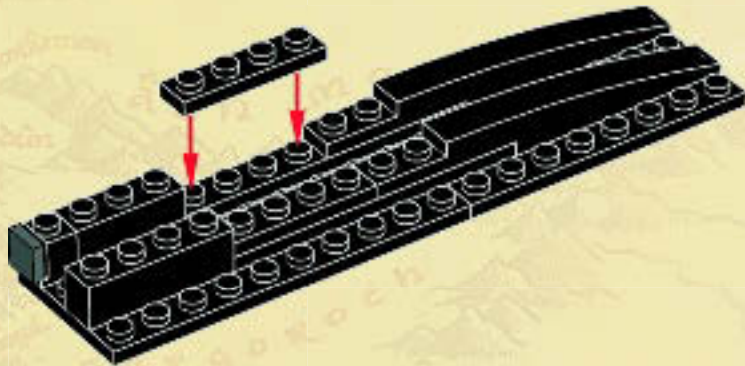

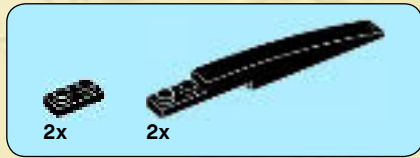

5

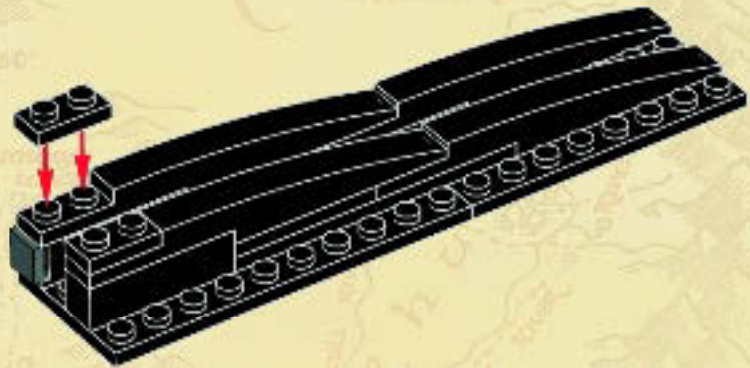

36

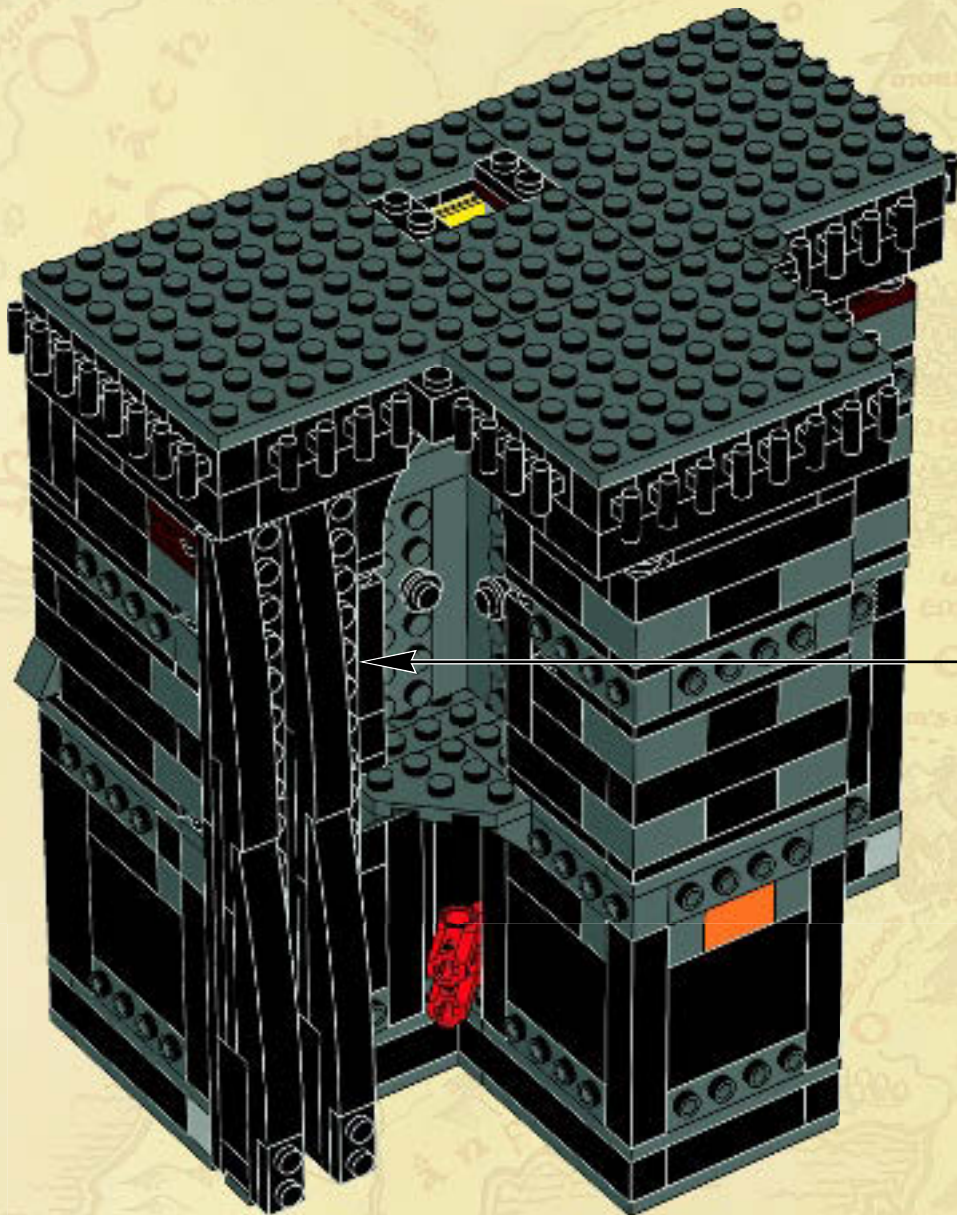



1

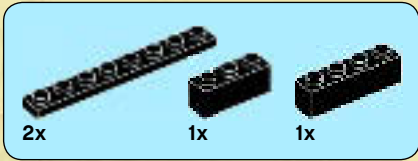
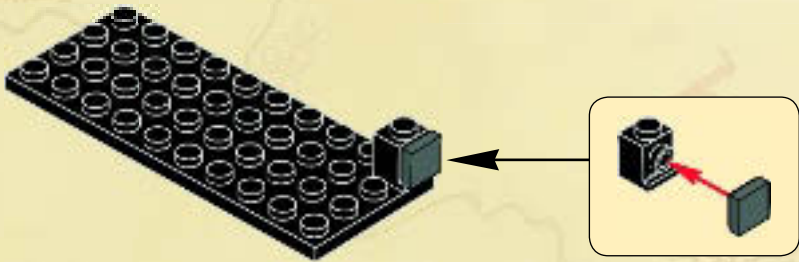

2

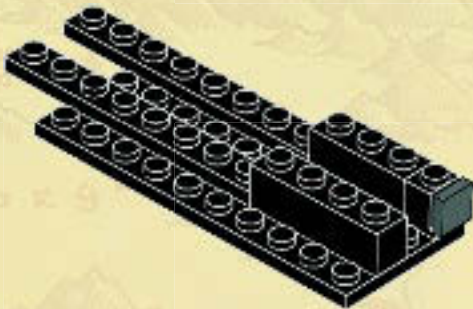

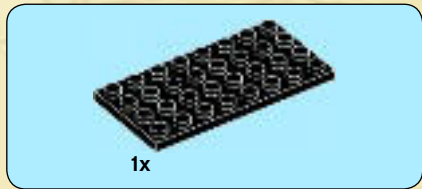

3

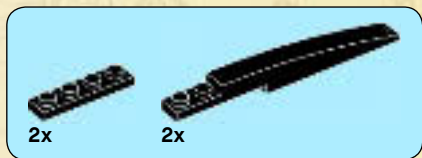
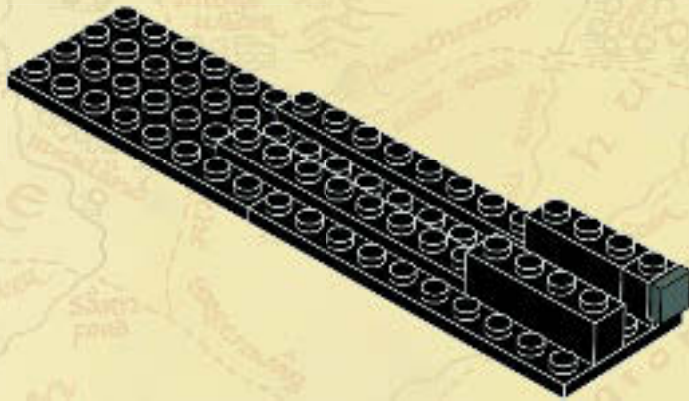

4

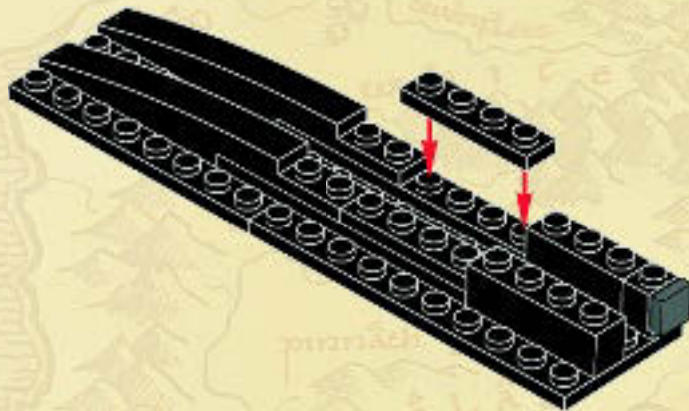

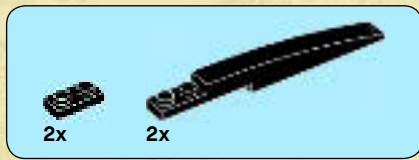

5

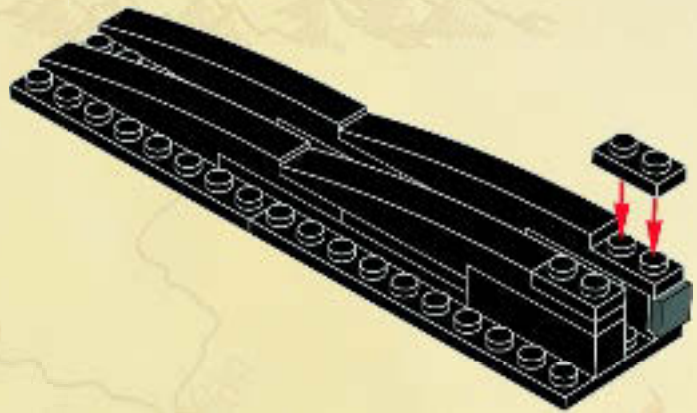

37



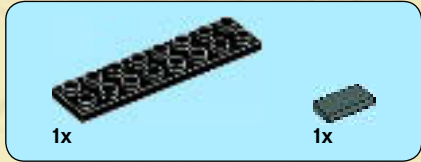

1



2

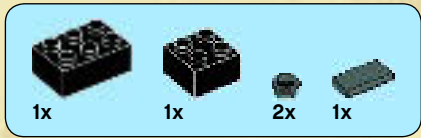

3

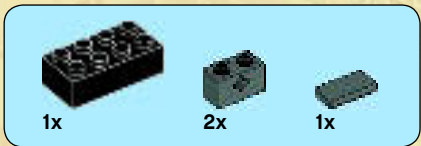
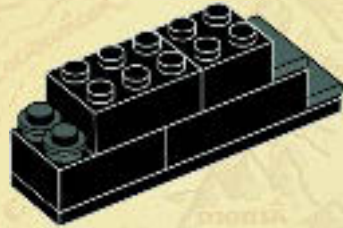

4

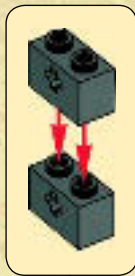



5



7

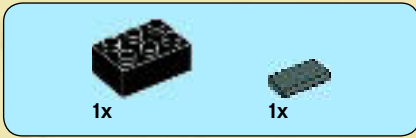
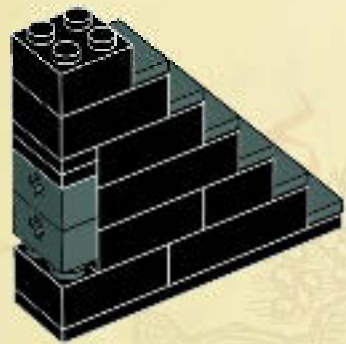

6

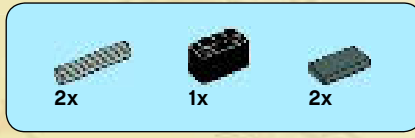
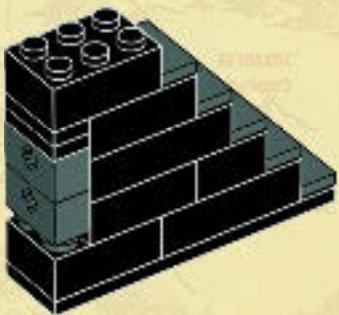

8

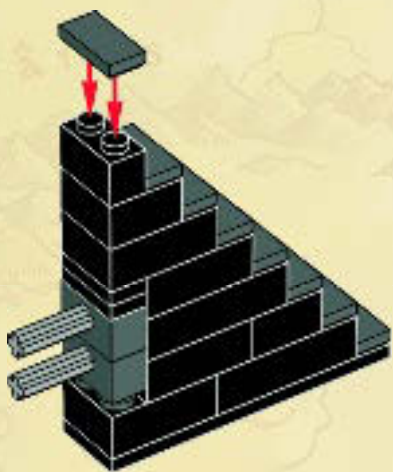

38



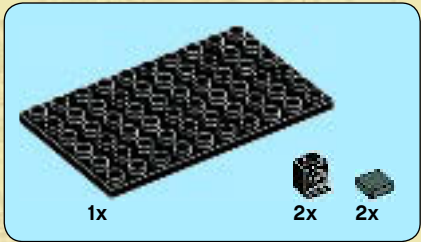
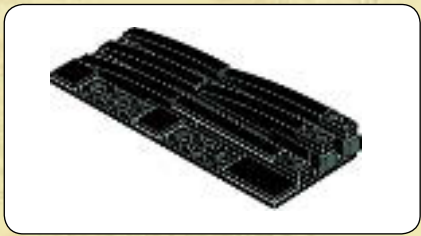

1

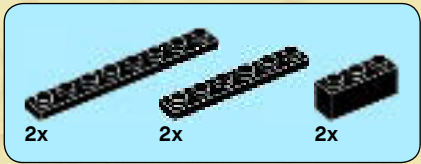
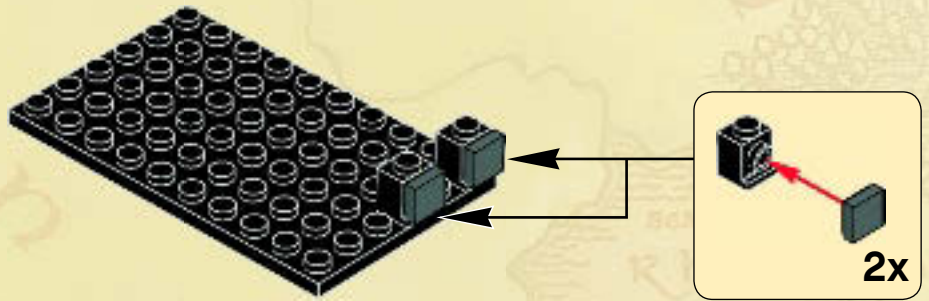

2

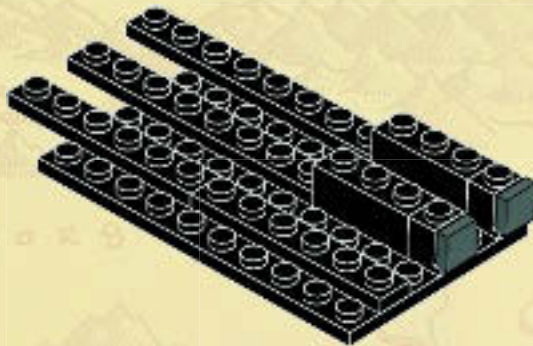

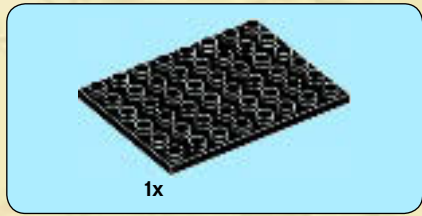

3

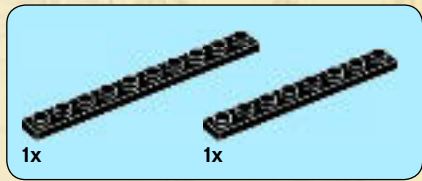
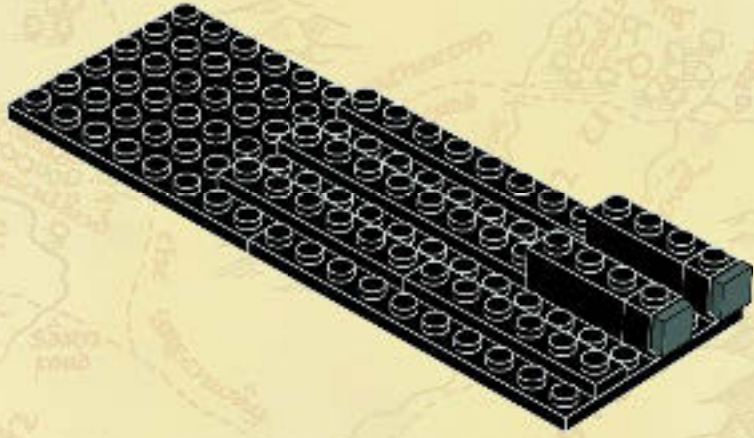

4

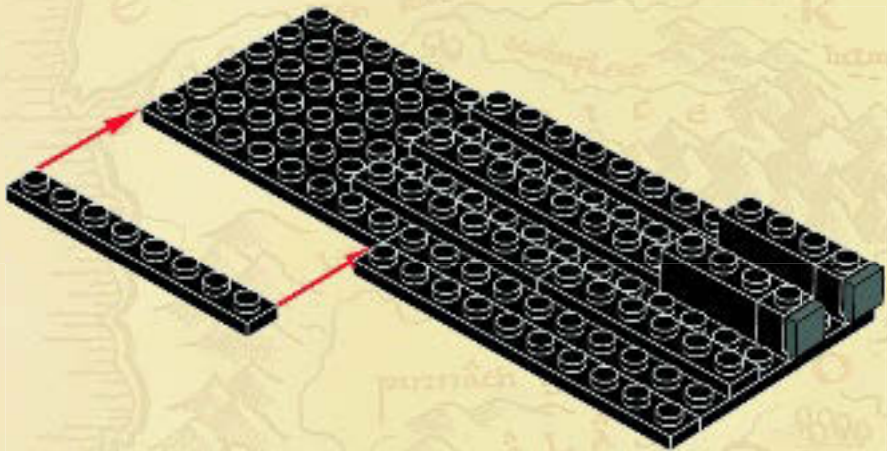



5

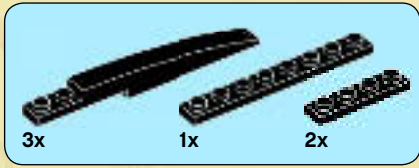
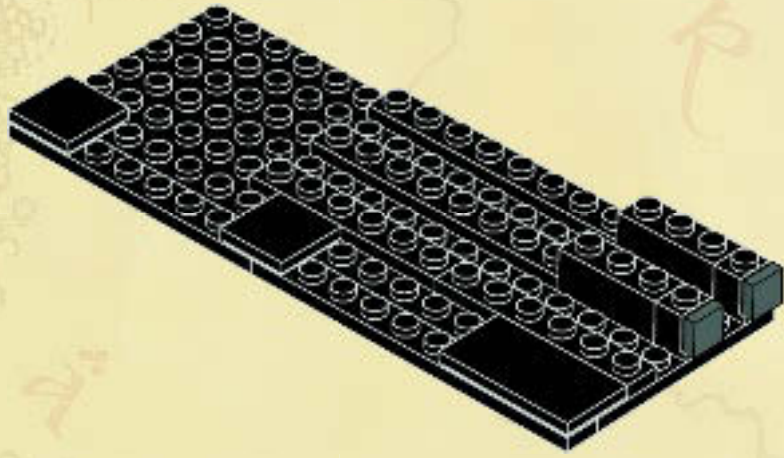

6

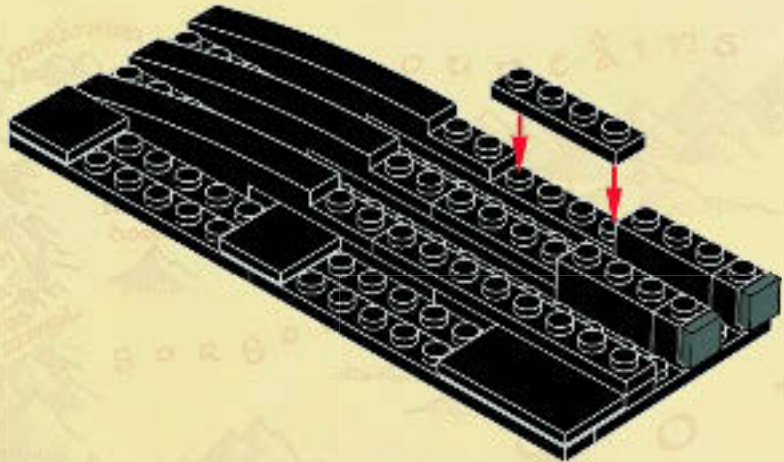

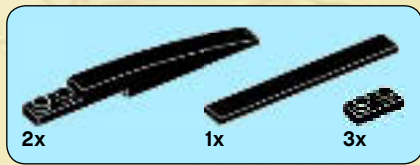

7

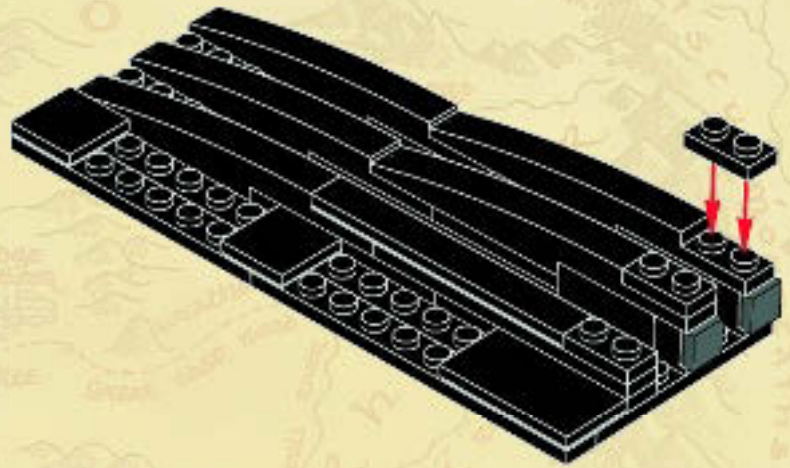

39



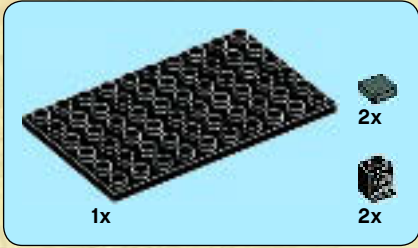

1

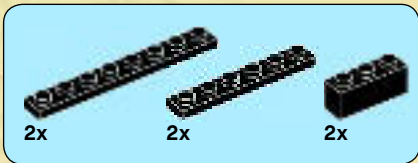
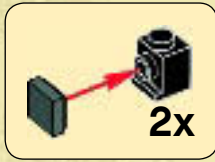

2

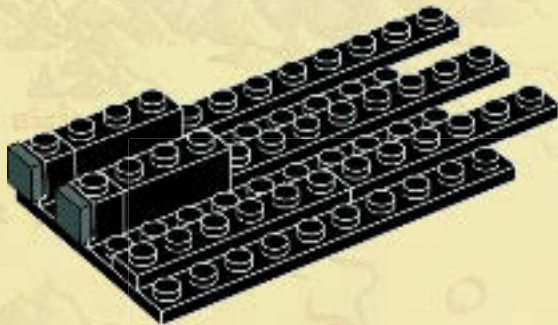

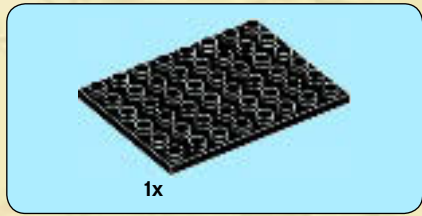

3

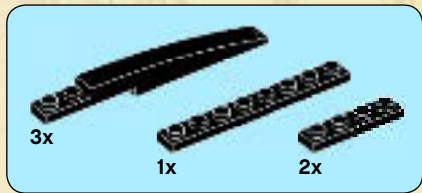
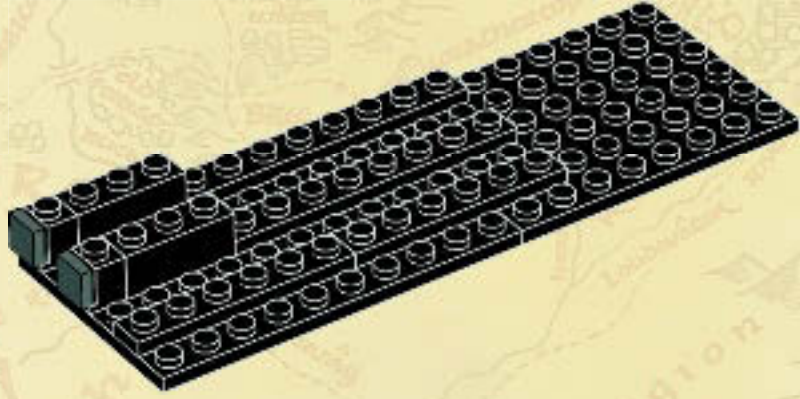

4

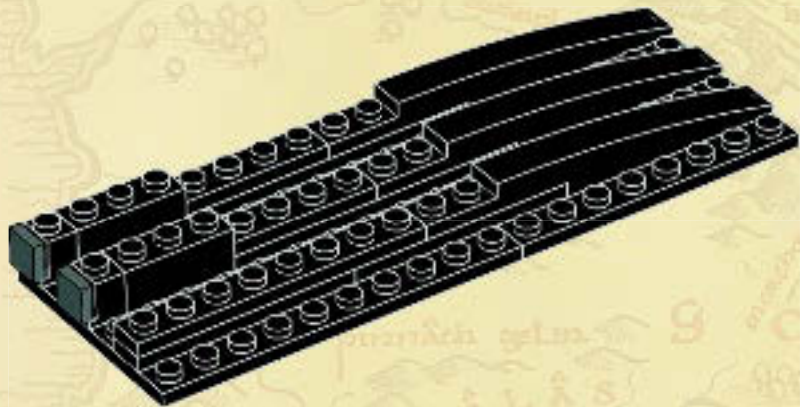

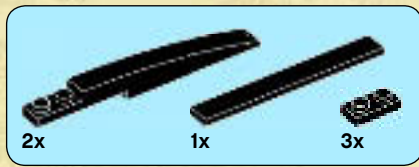

5

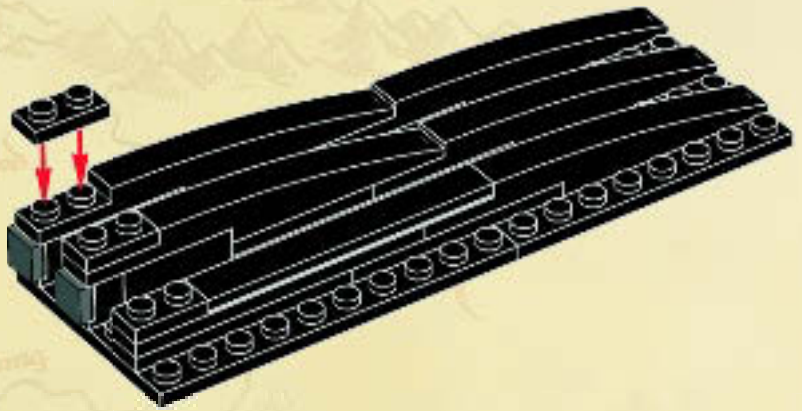

40

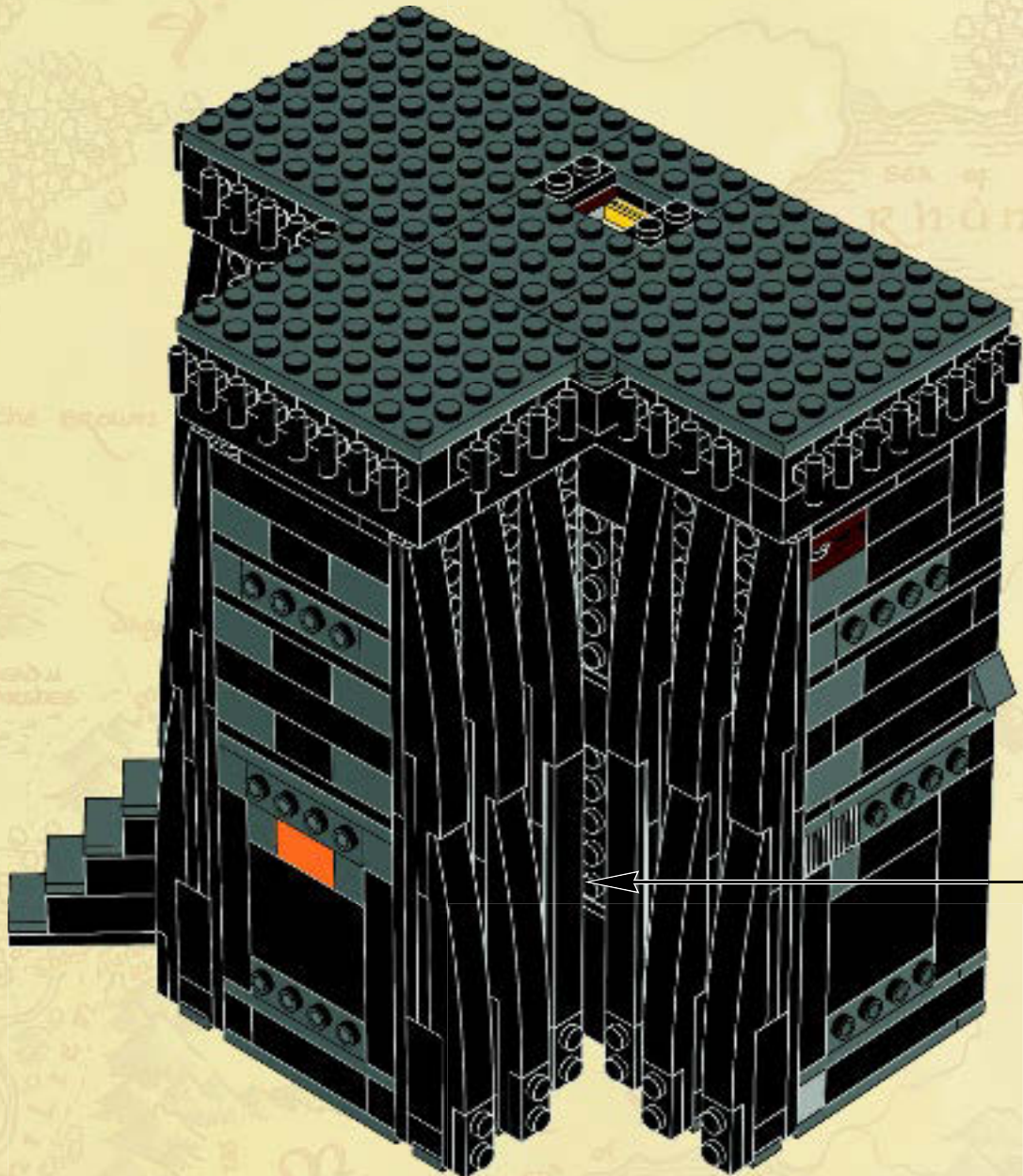

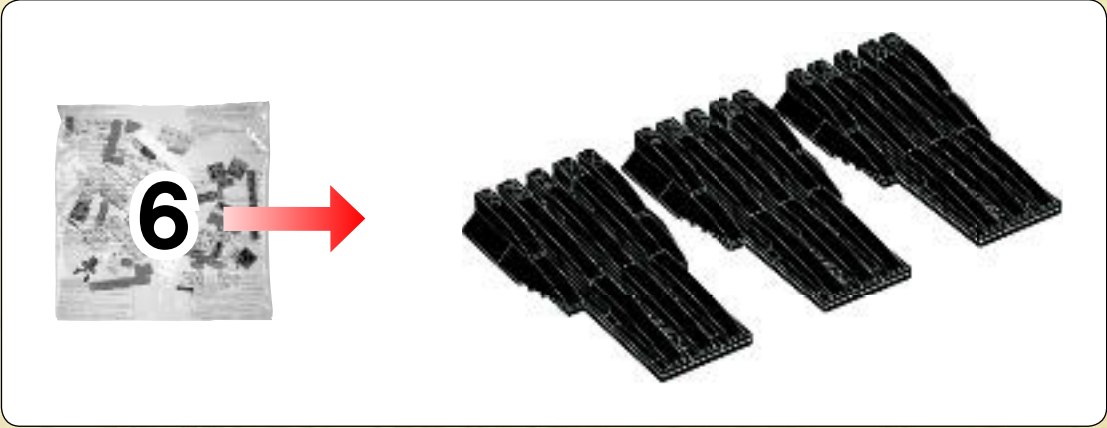

1

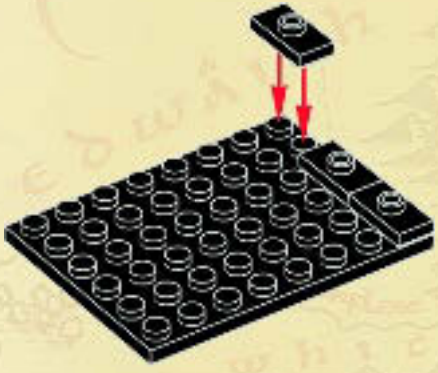

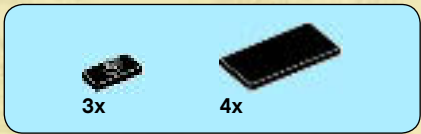

2

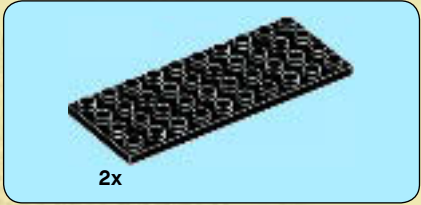
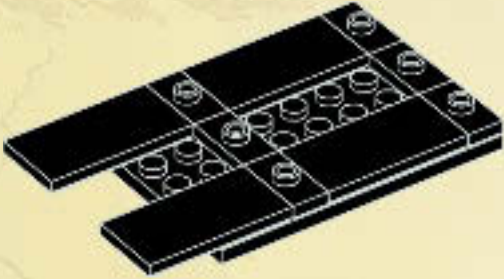

3

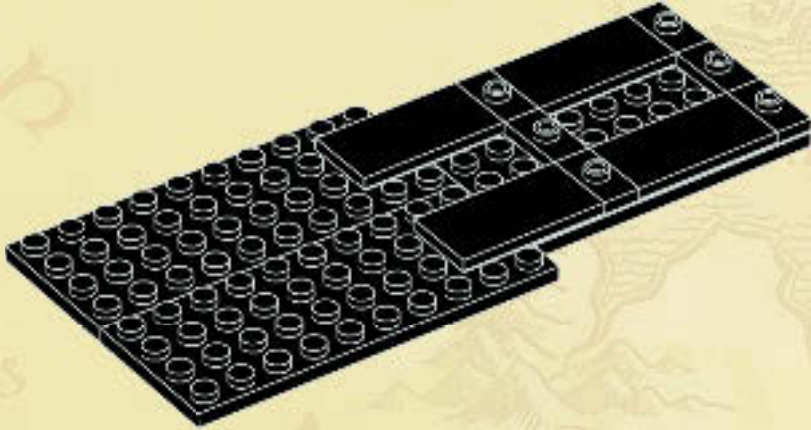

4

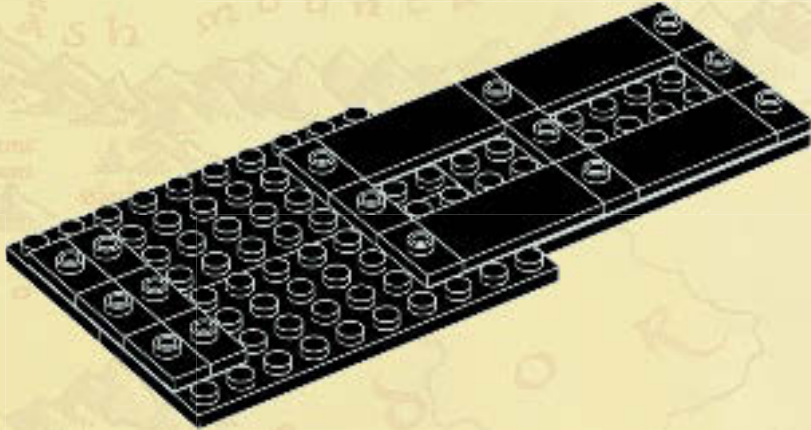



5

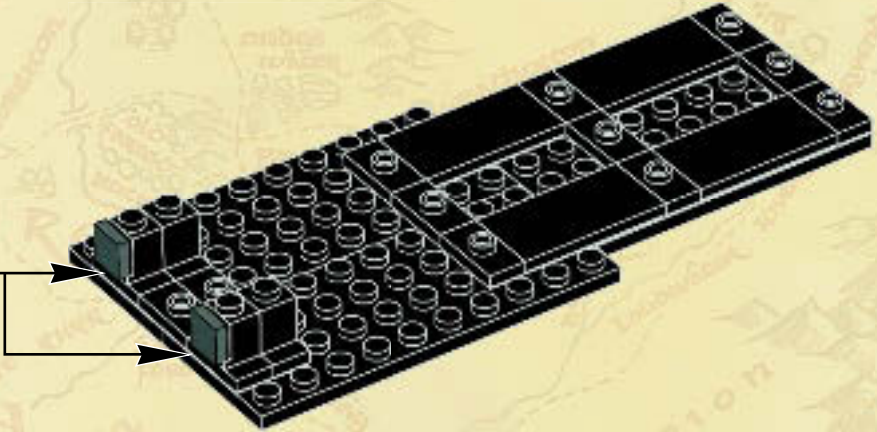
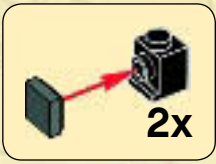

6

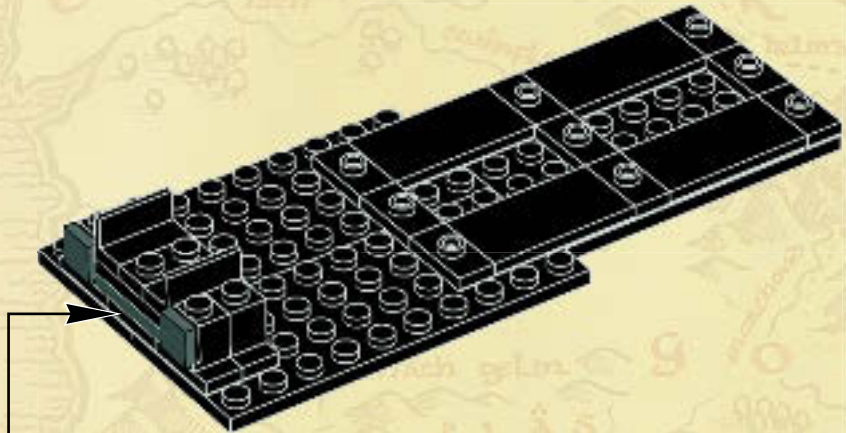
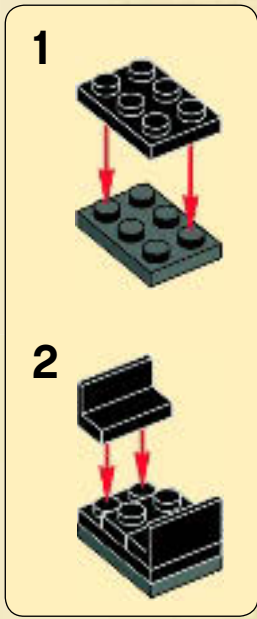

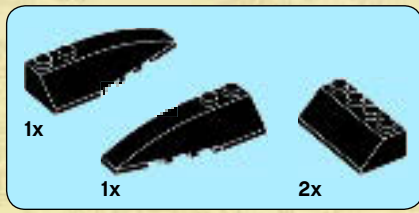

7

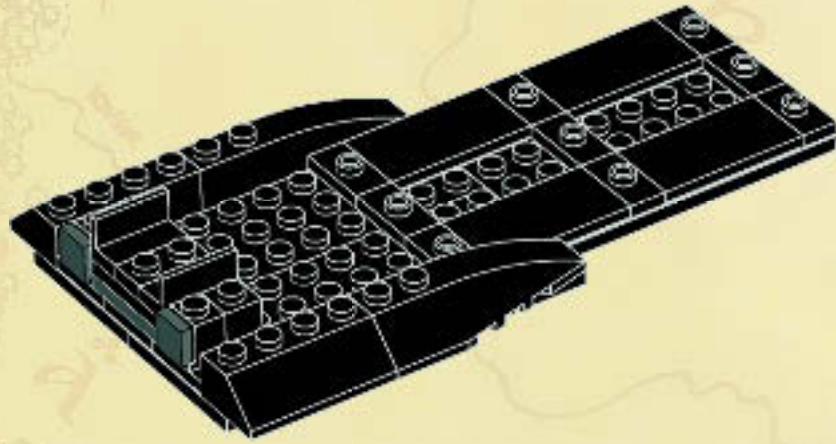

8

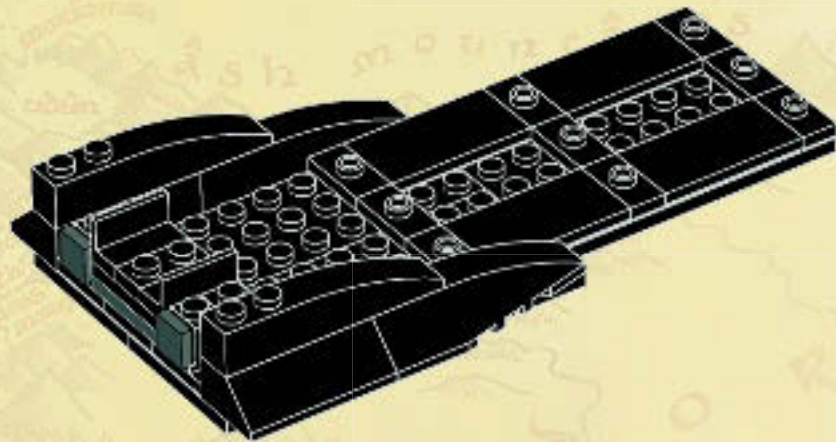

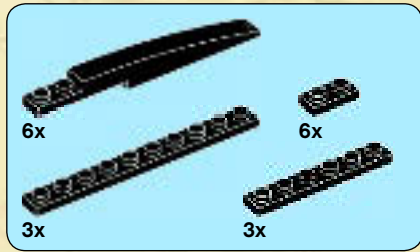

9

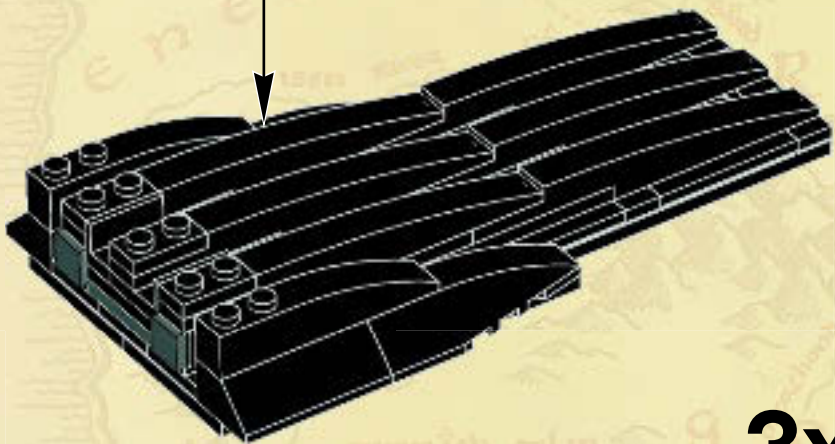
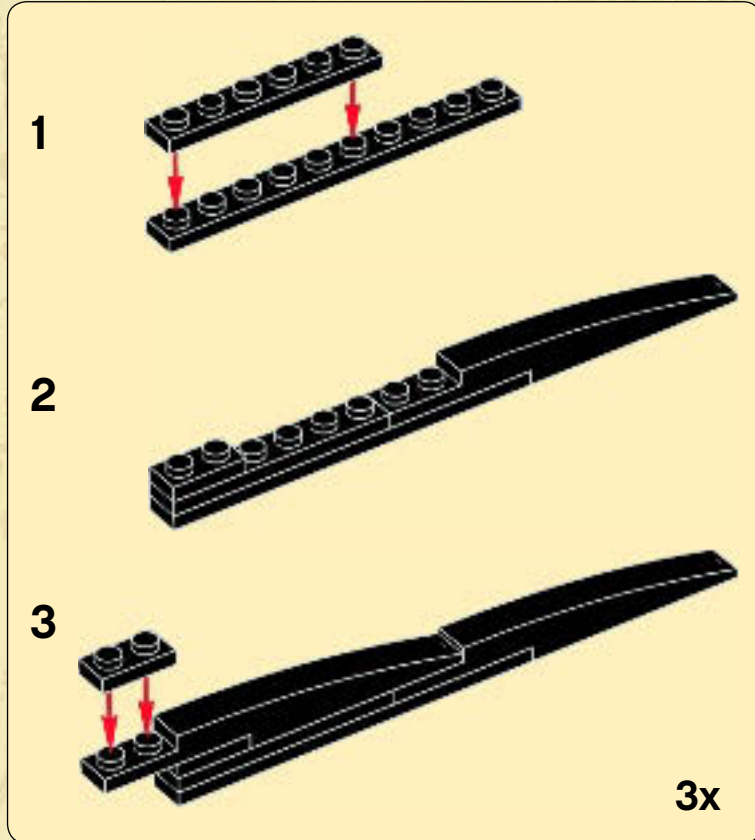

41

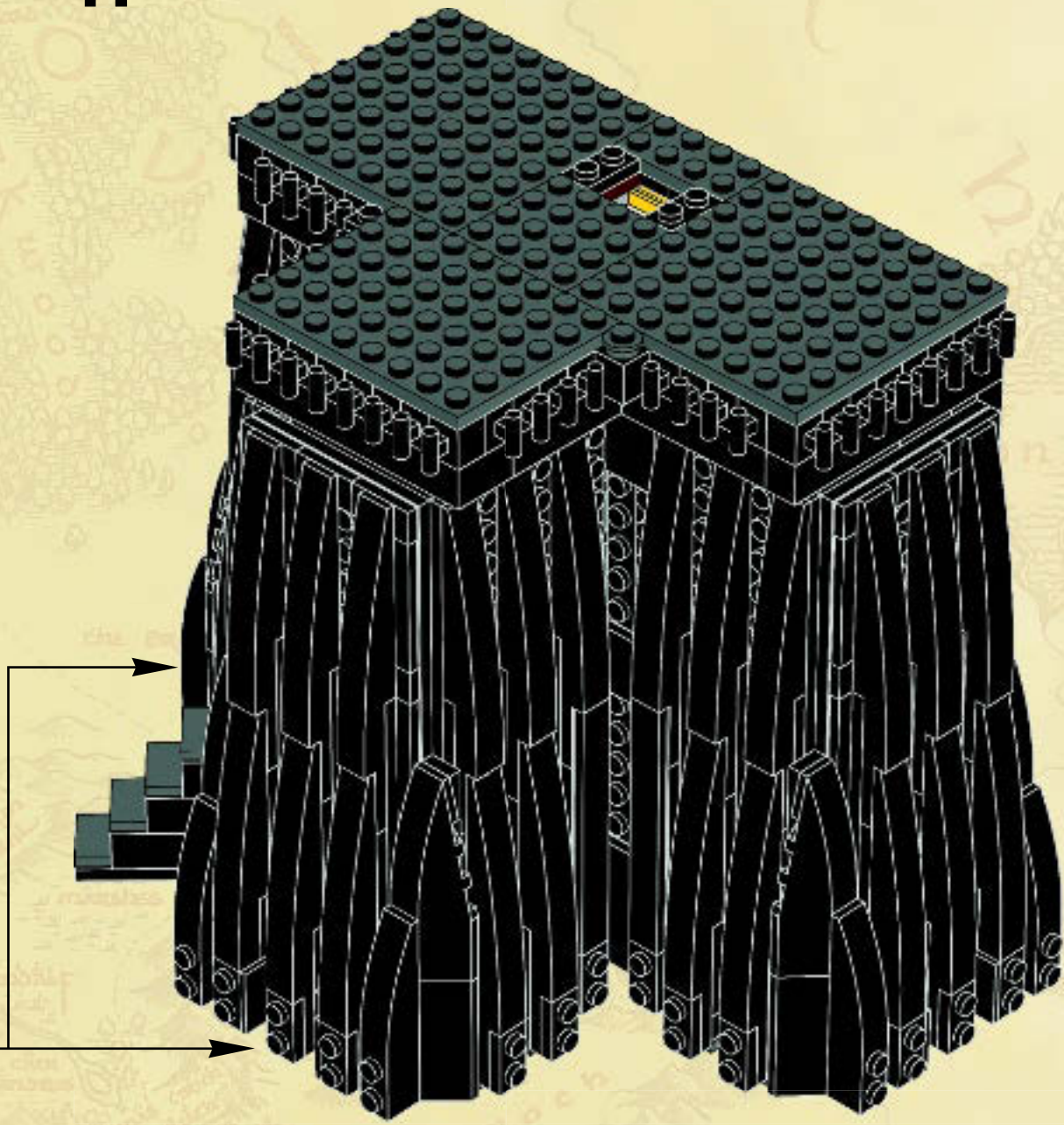

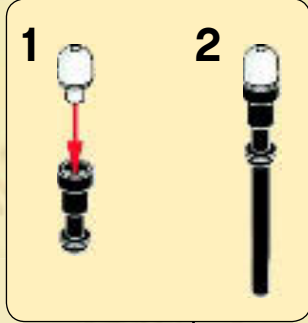
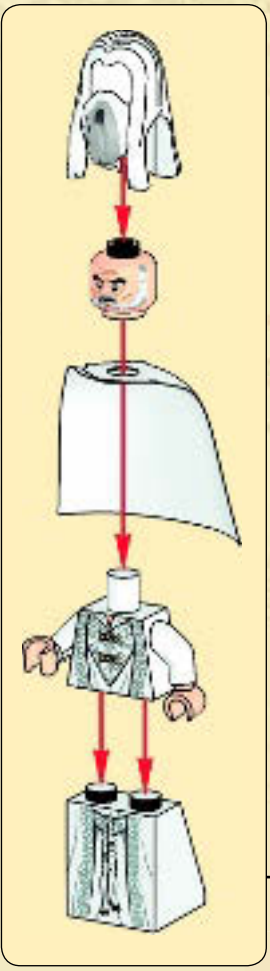
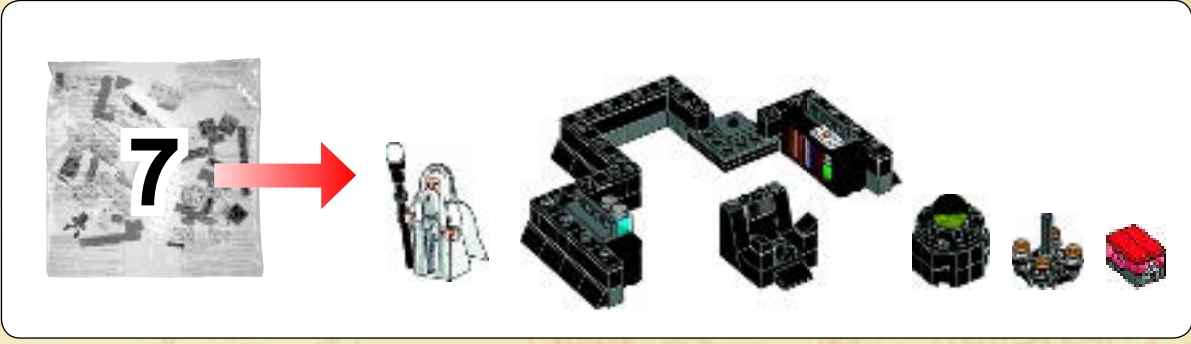

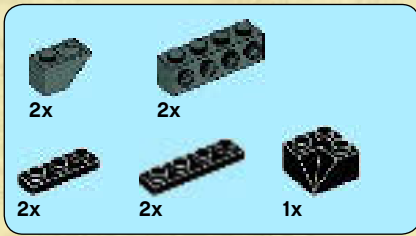

42

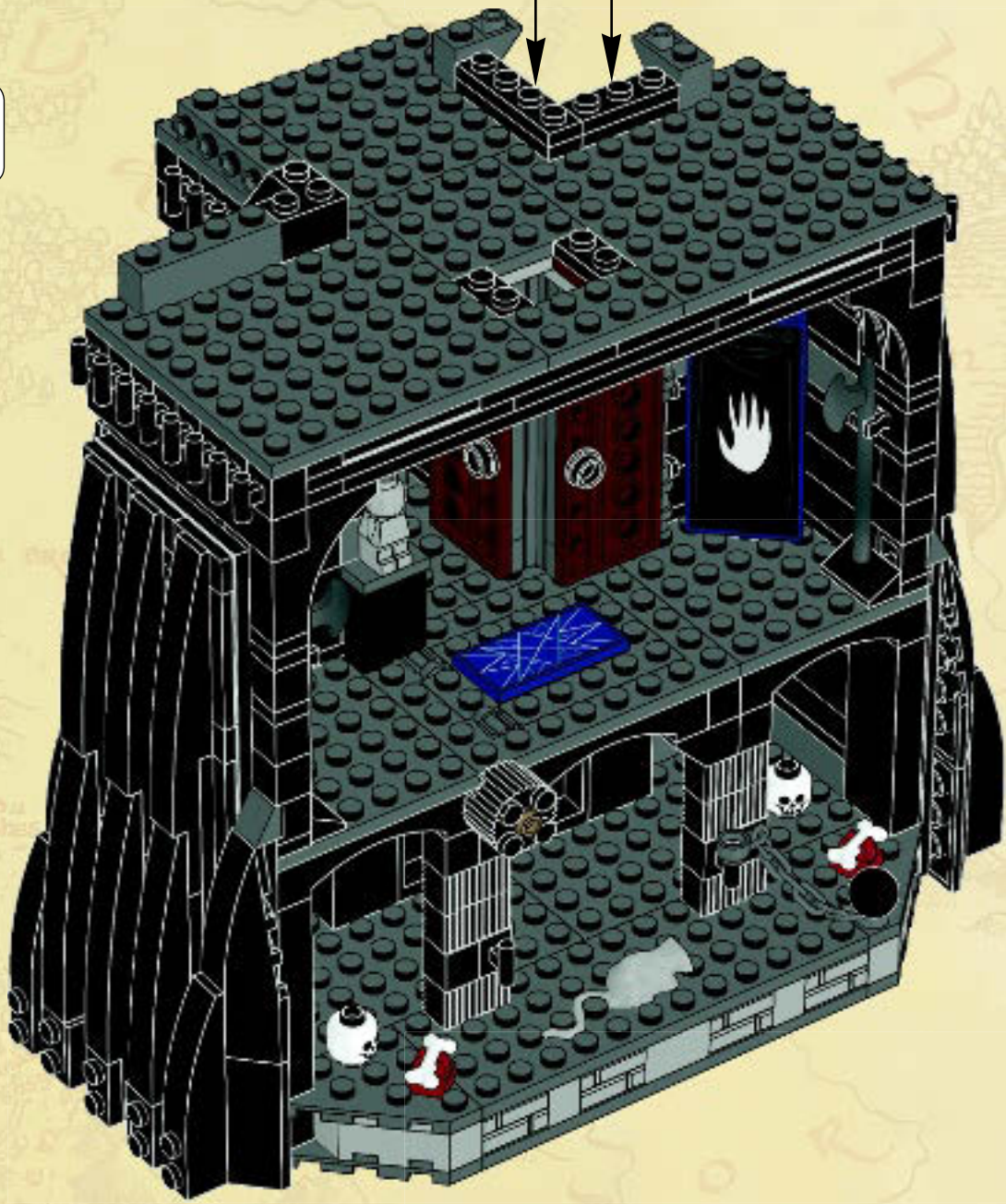
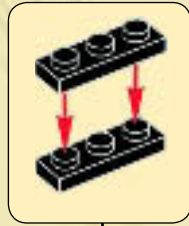
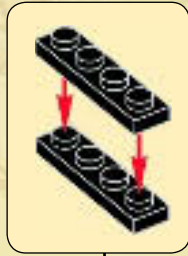



43

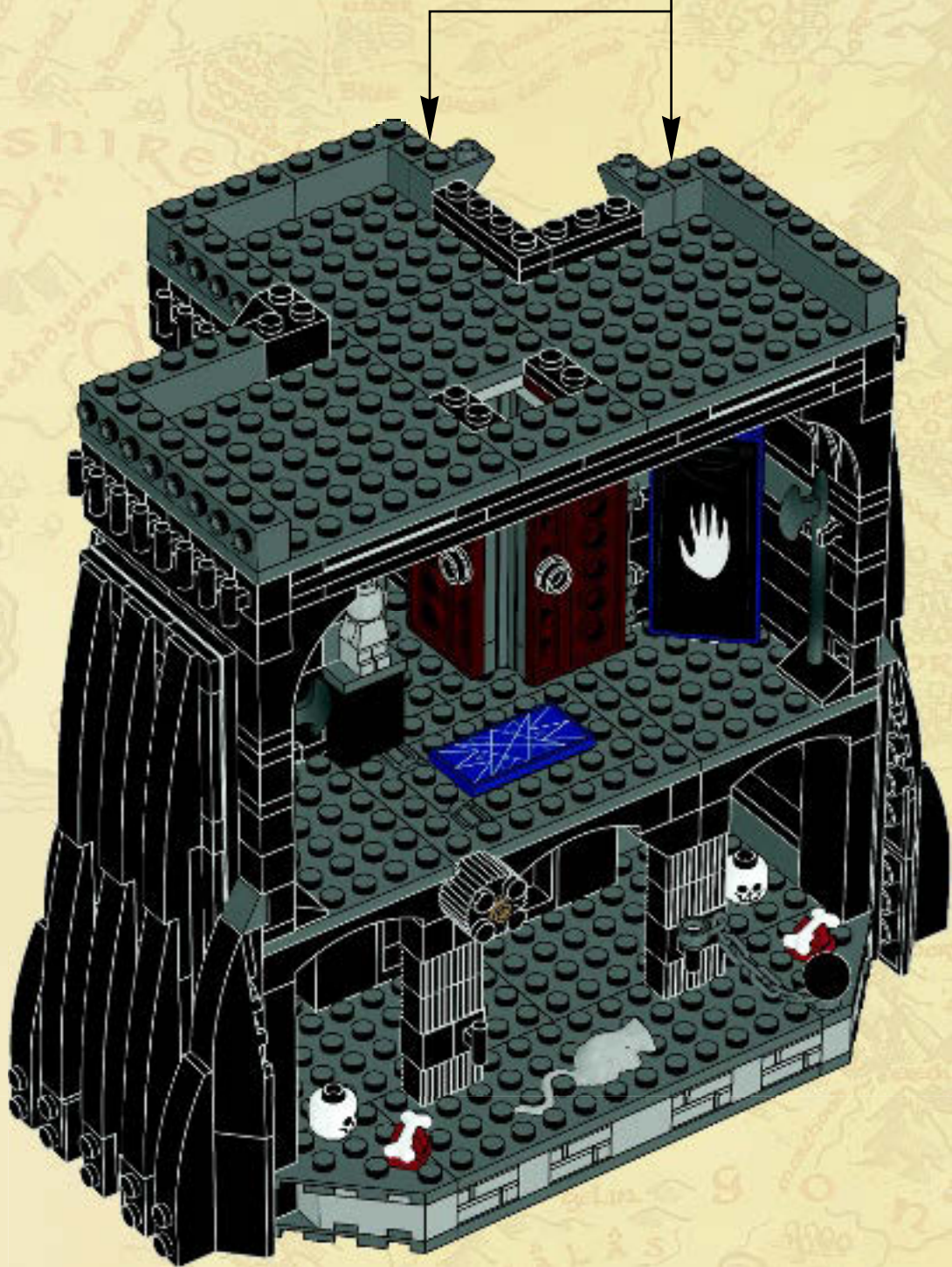

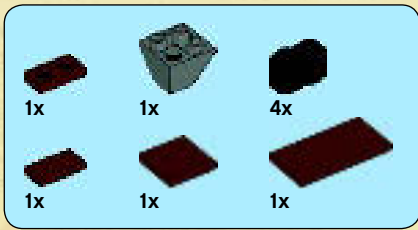

44

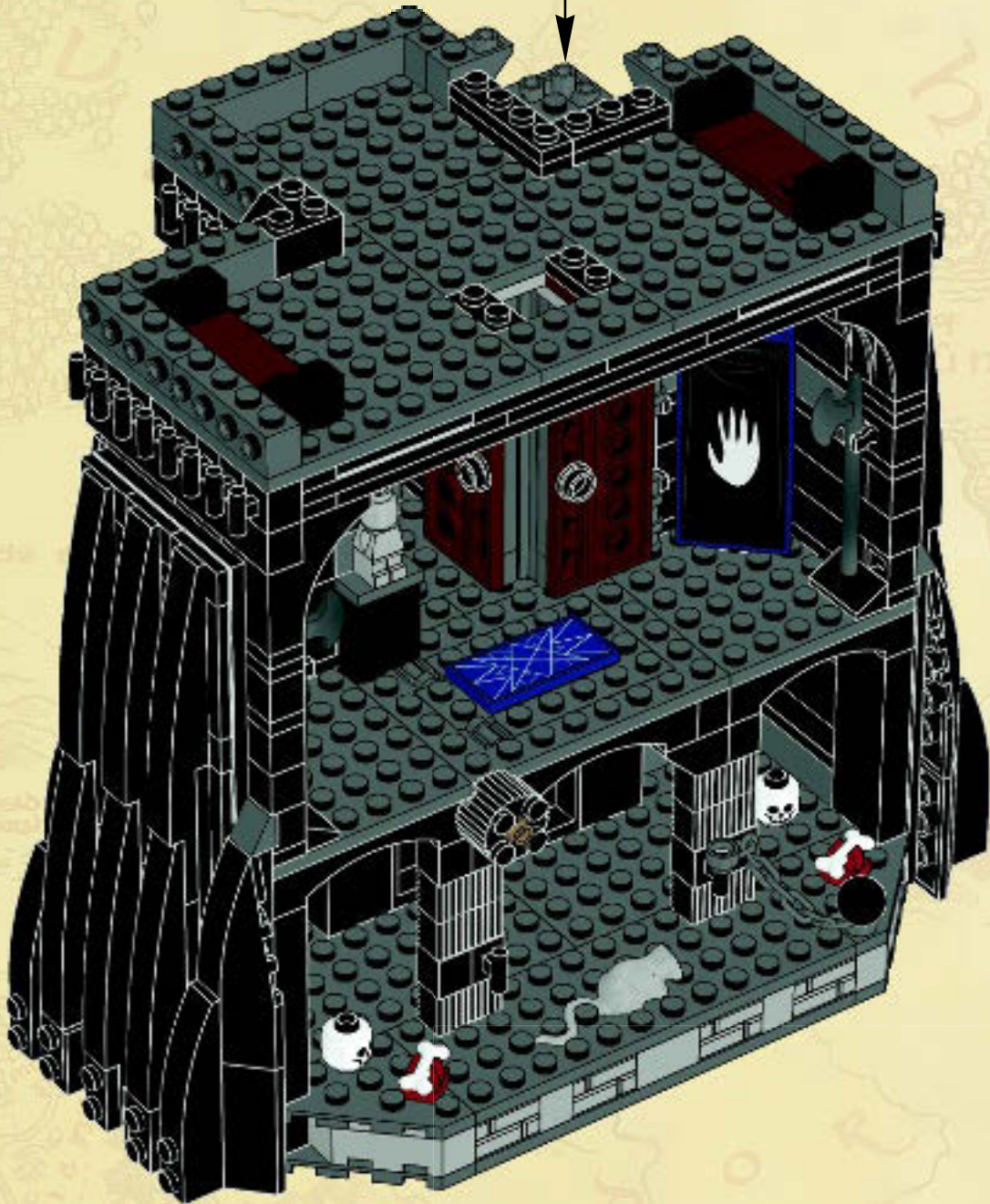
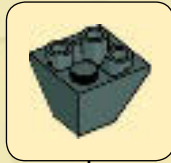



45

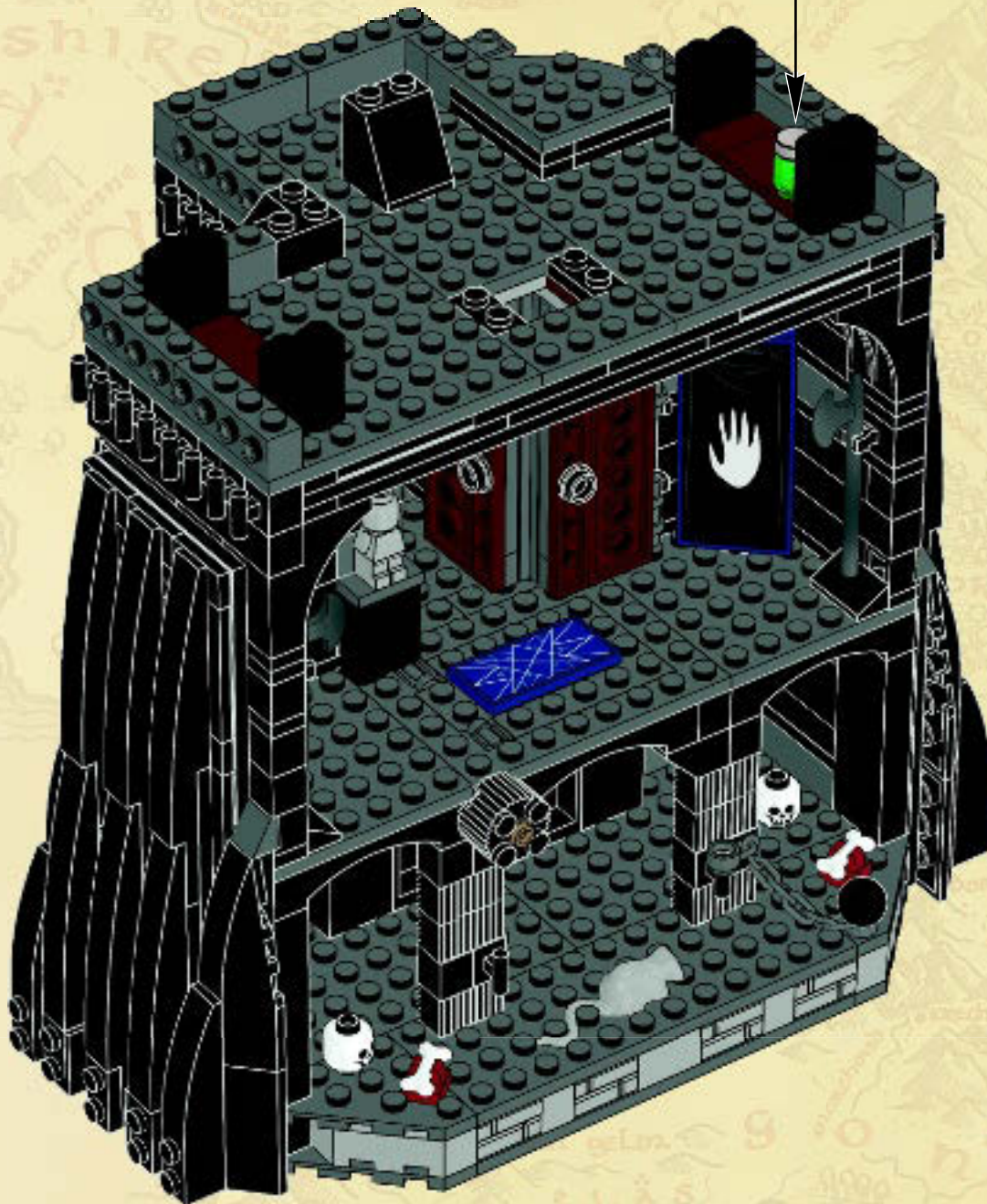

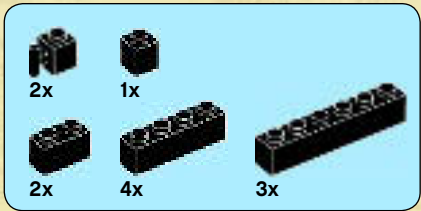

46

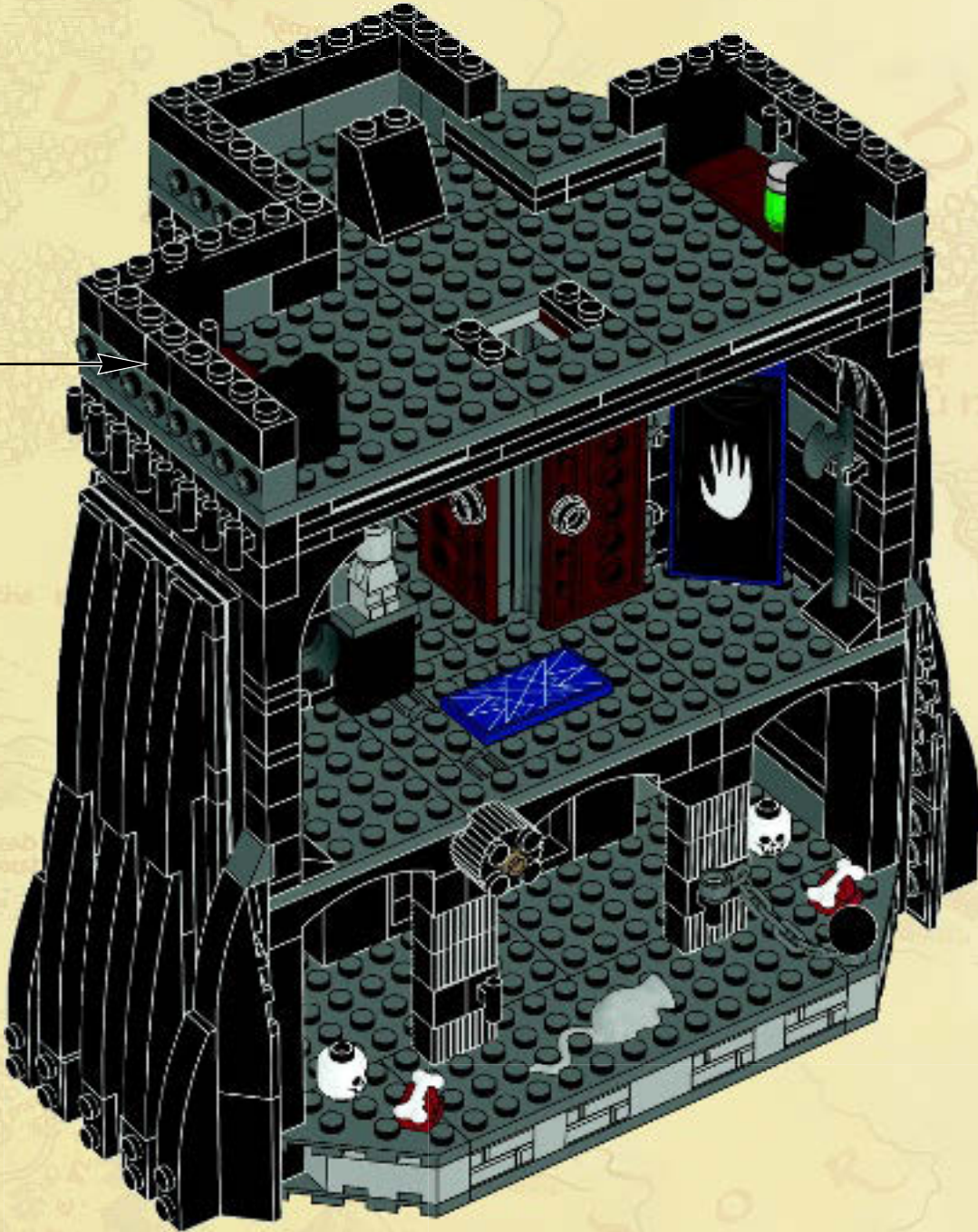



47

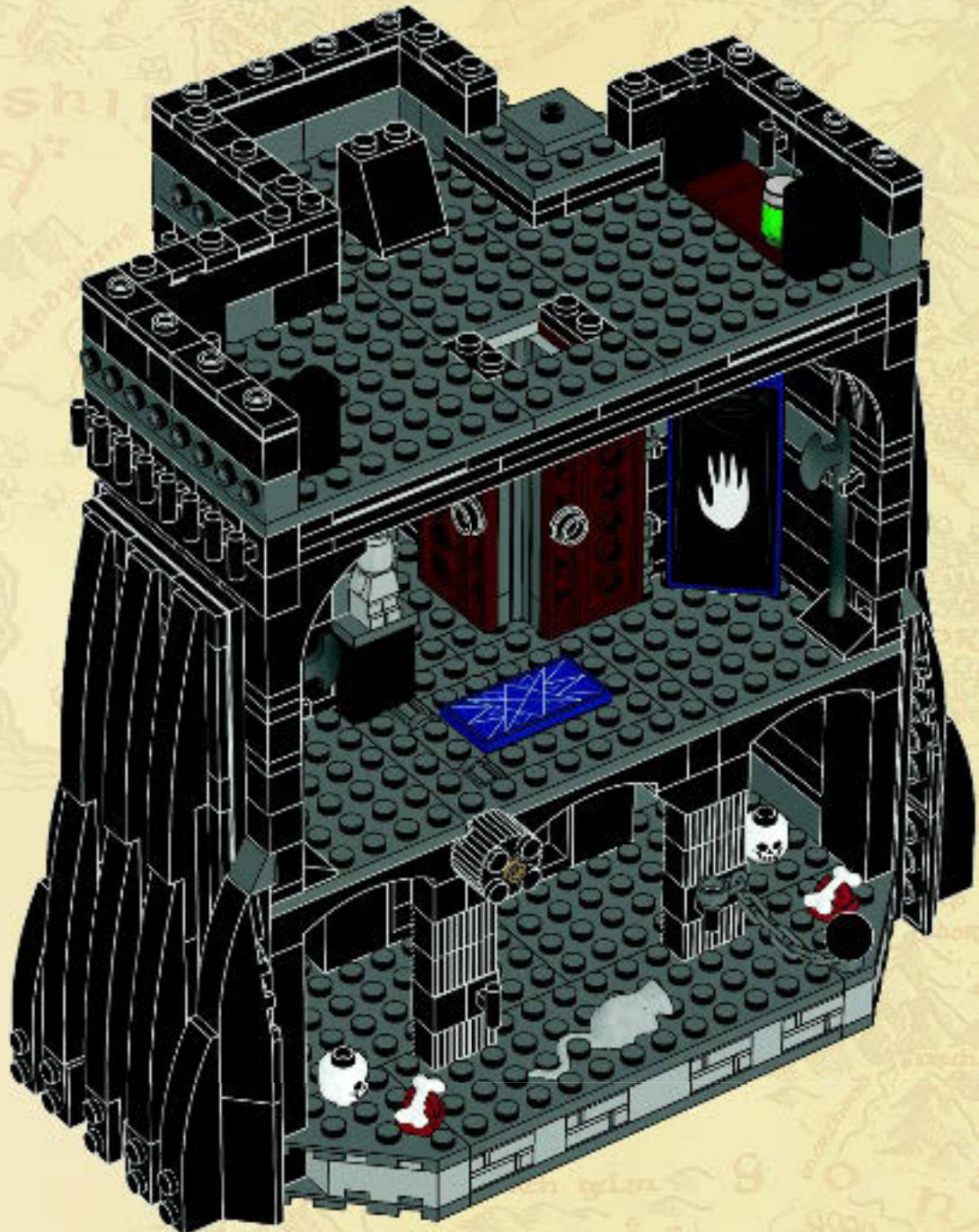

- 1x
- 3x
- 3x
- 3x
- 2x
- 1x

48

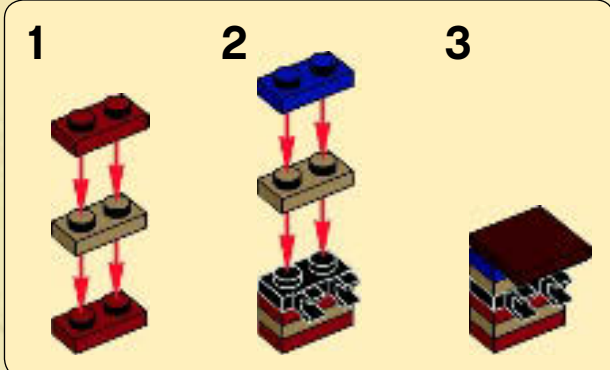
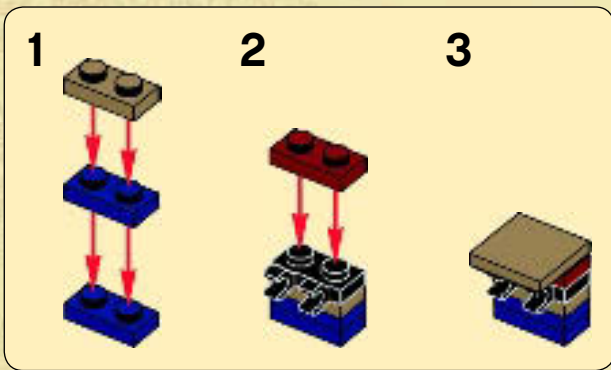



2x



18x

49

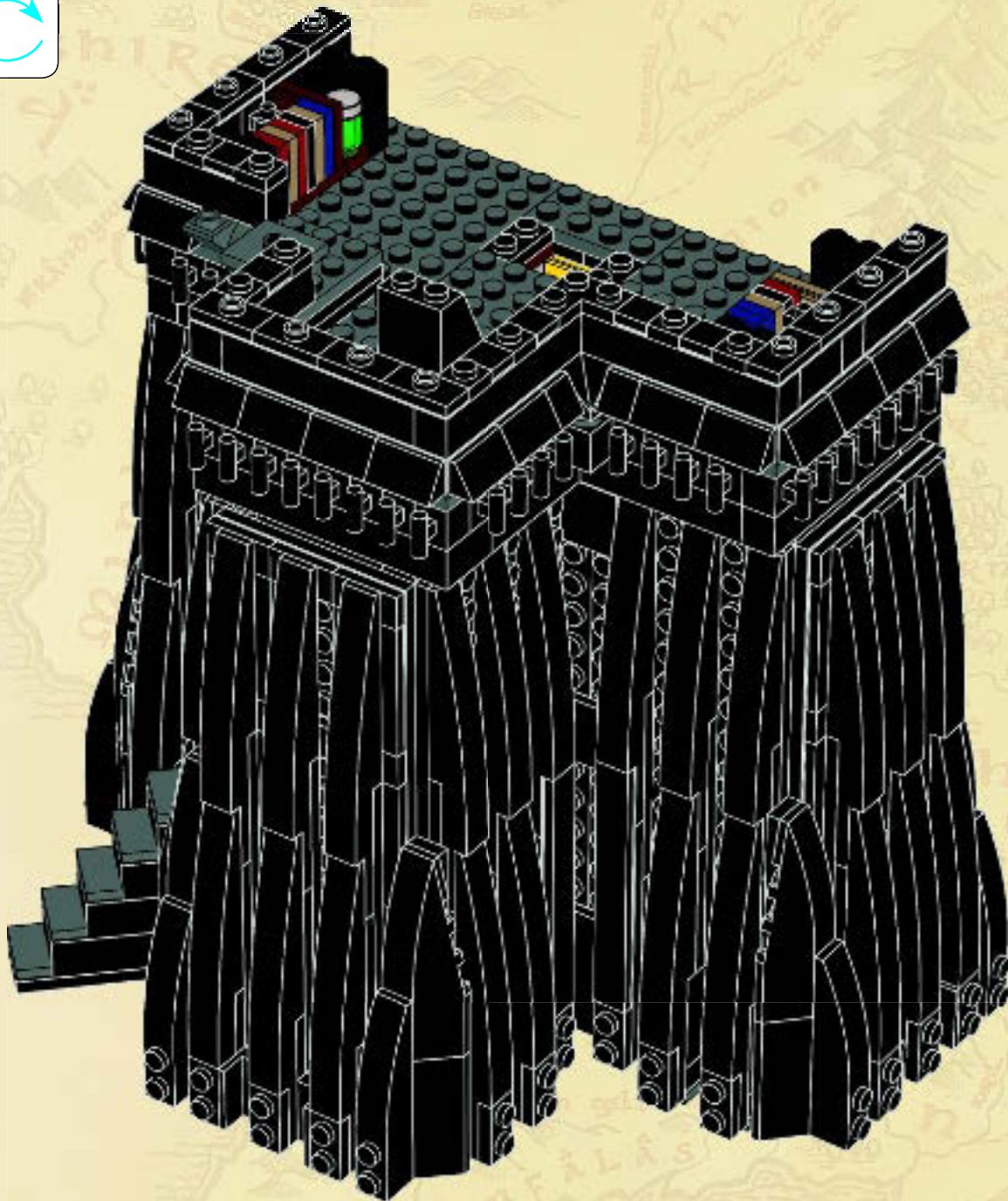
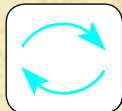

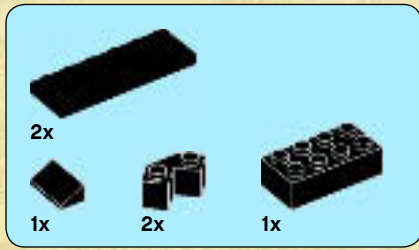

50





51



1x 2x 4x

52





Light brick
Brique lumière
Ladrillo luminoso



53

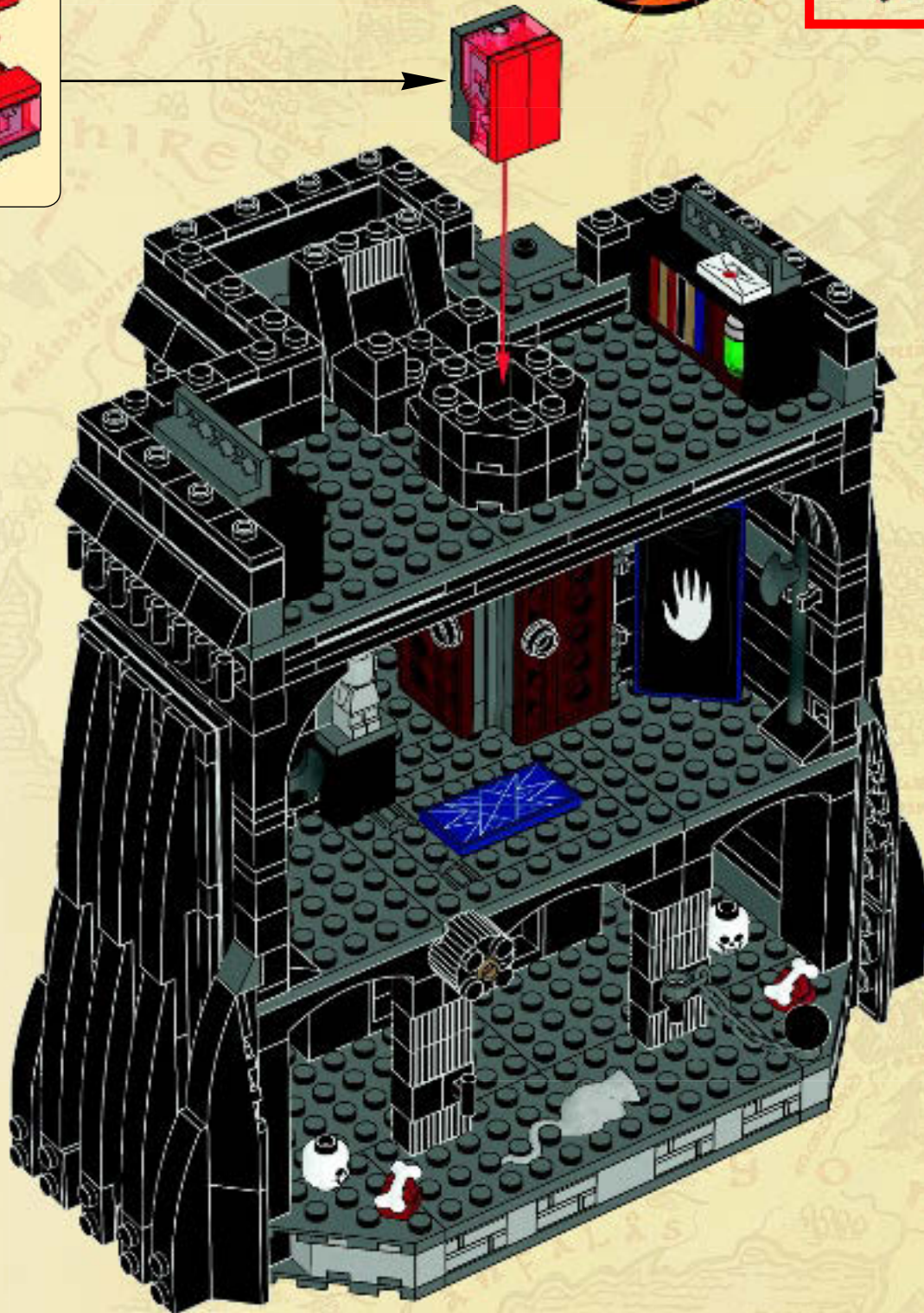
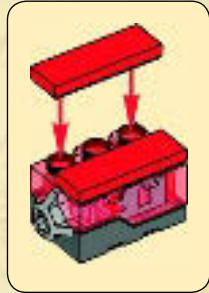

- 1x
- 1x
- 2x
- 1x
- 2x
- 1x

54



- 1
- 2

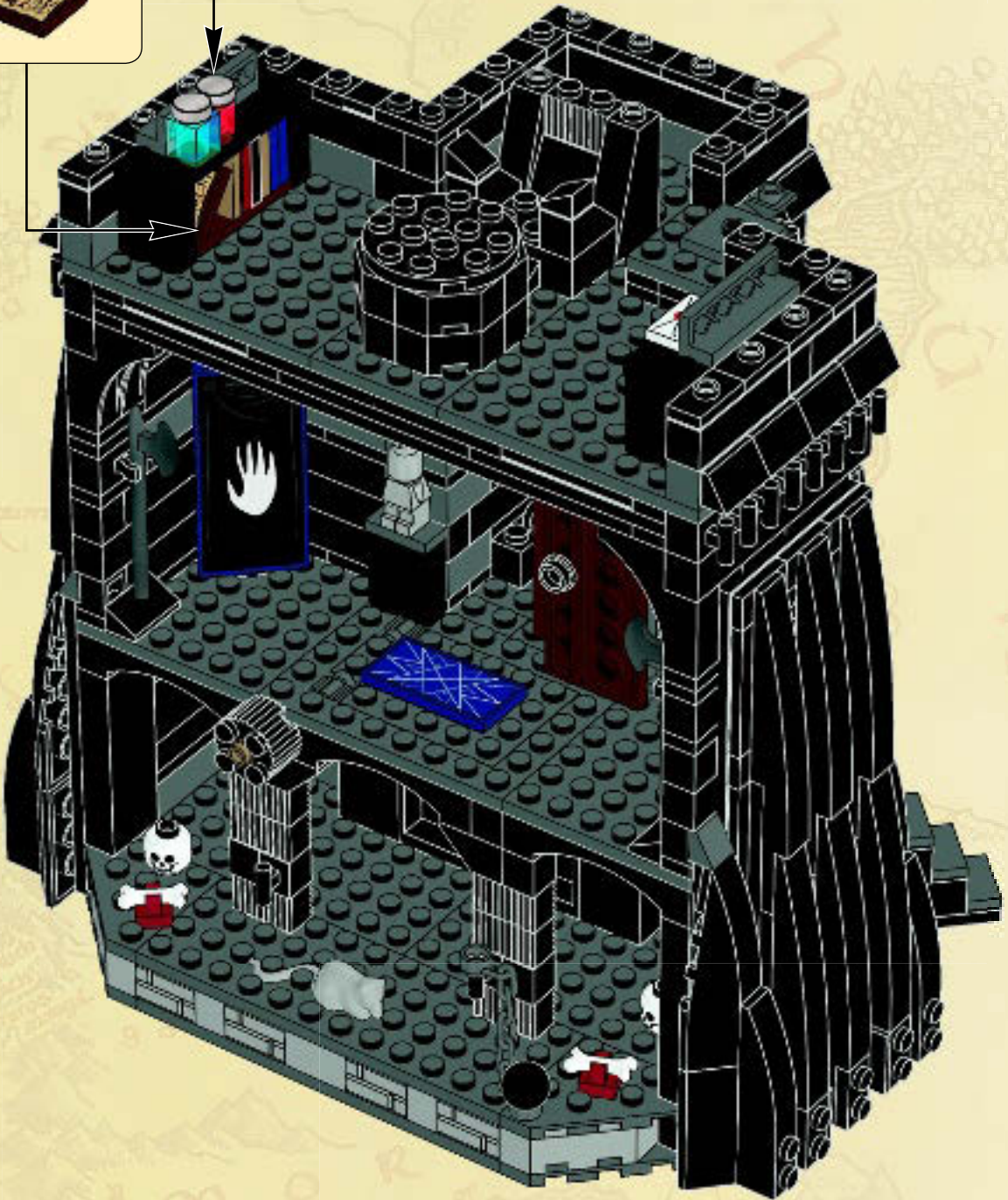

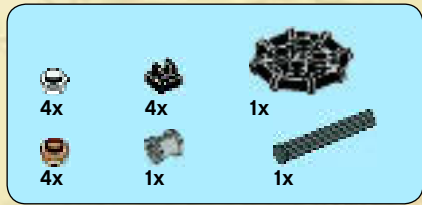

55

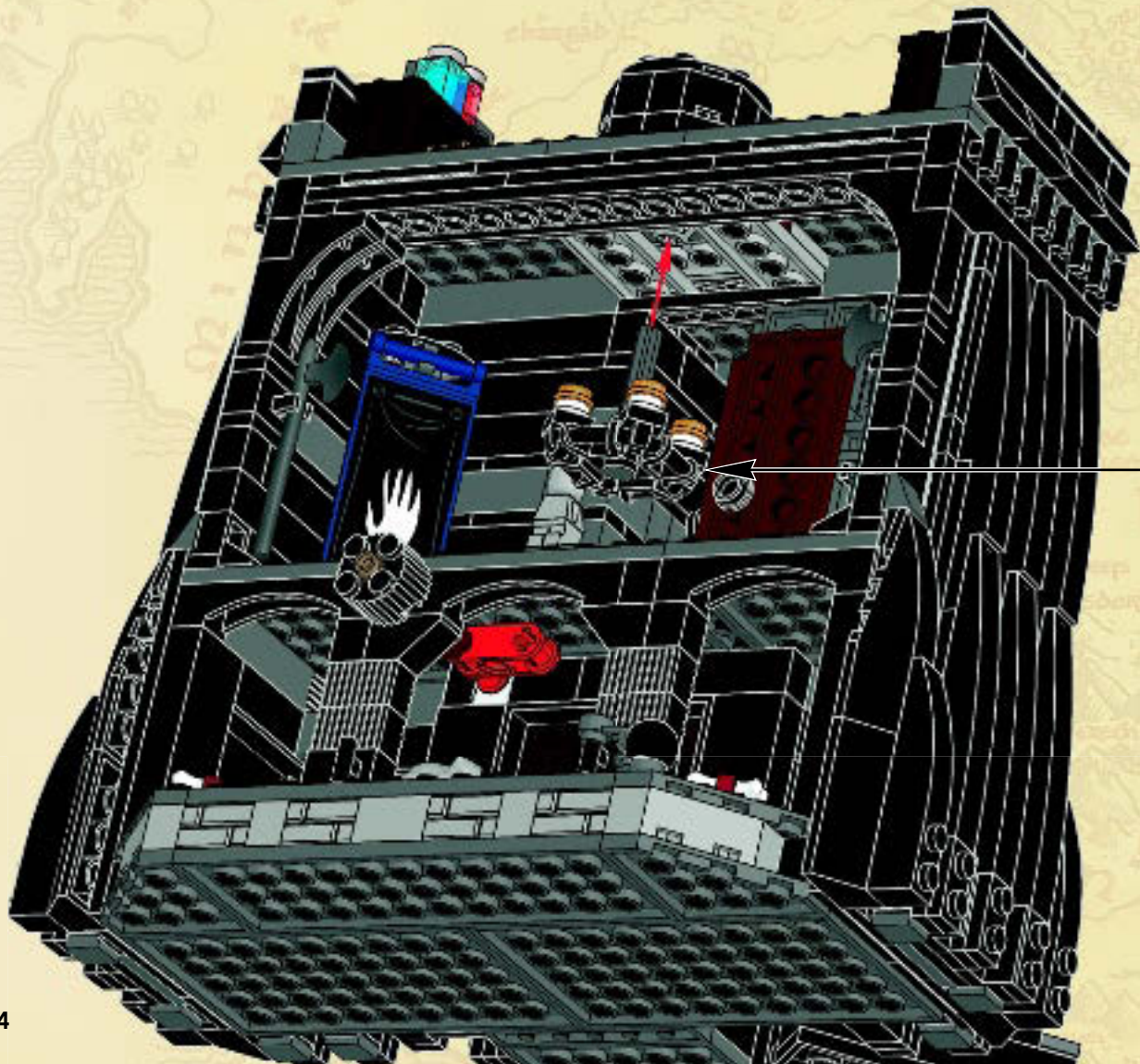



56

Light brick
Brique lumière
Ladrillo luminoso



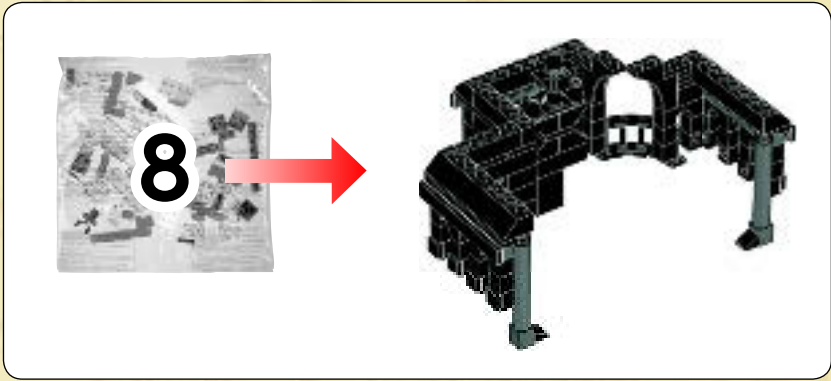

57

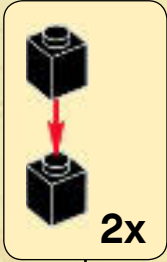
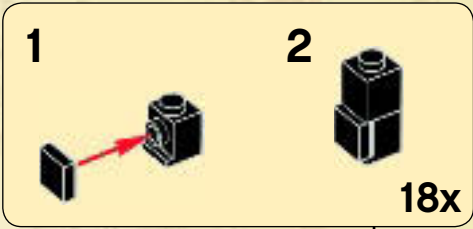



3x



10x

58

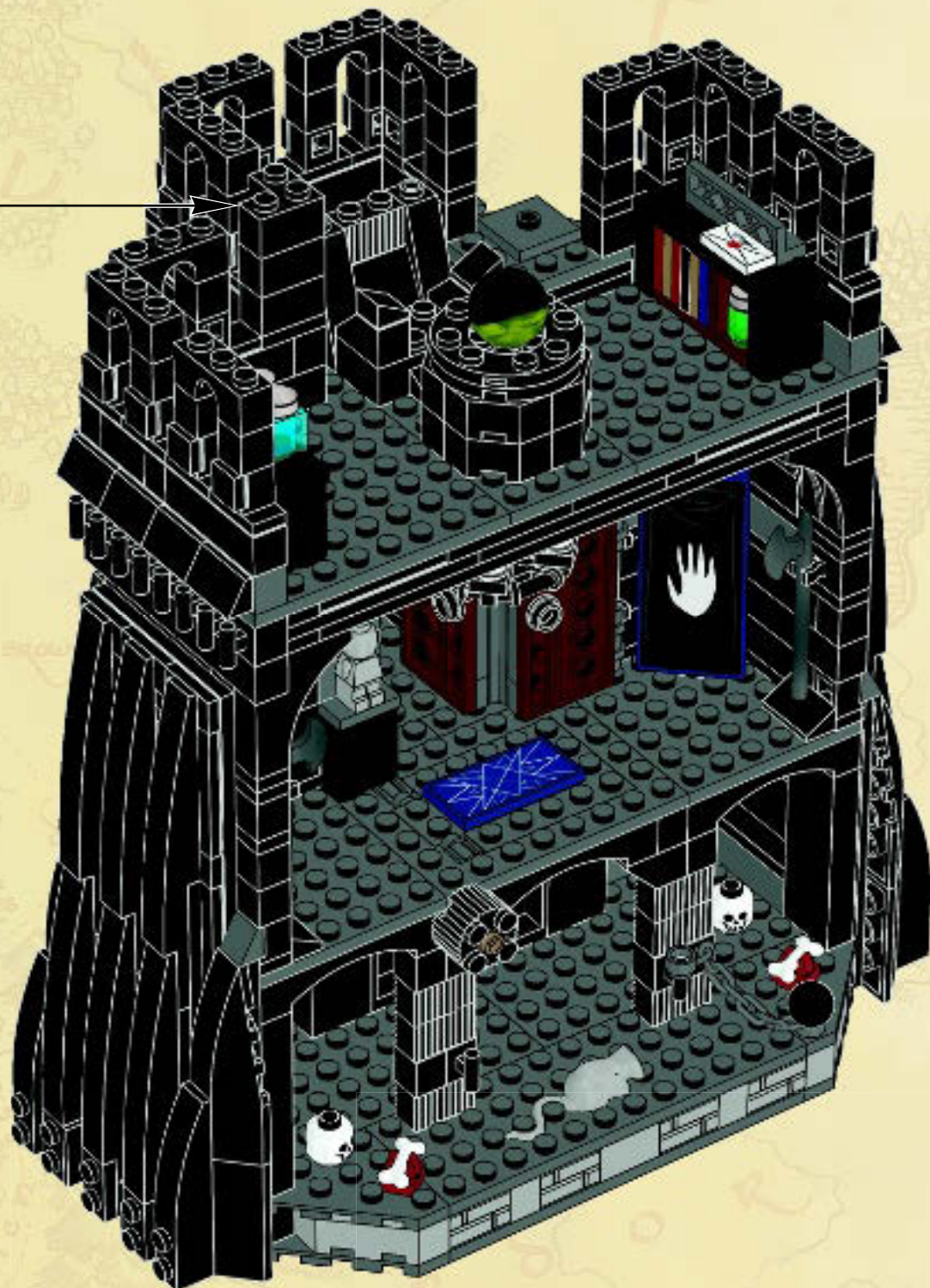
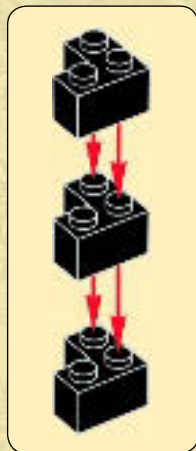



59

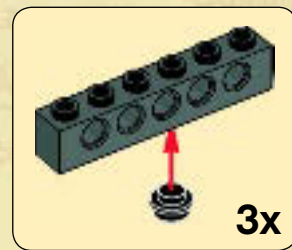
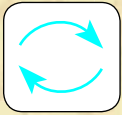

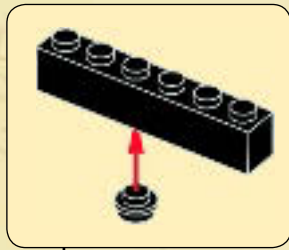
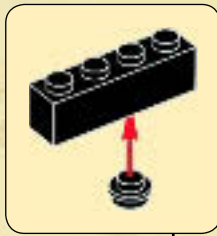
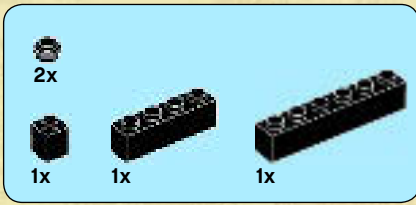

60



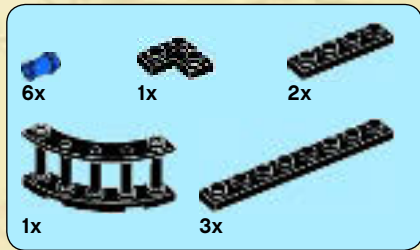

61

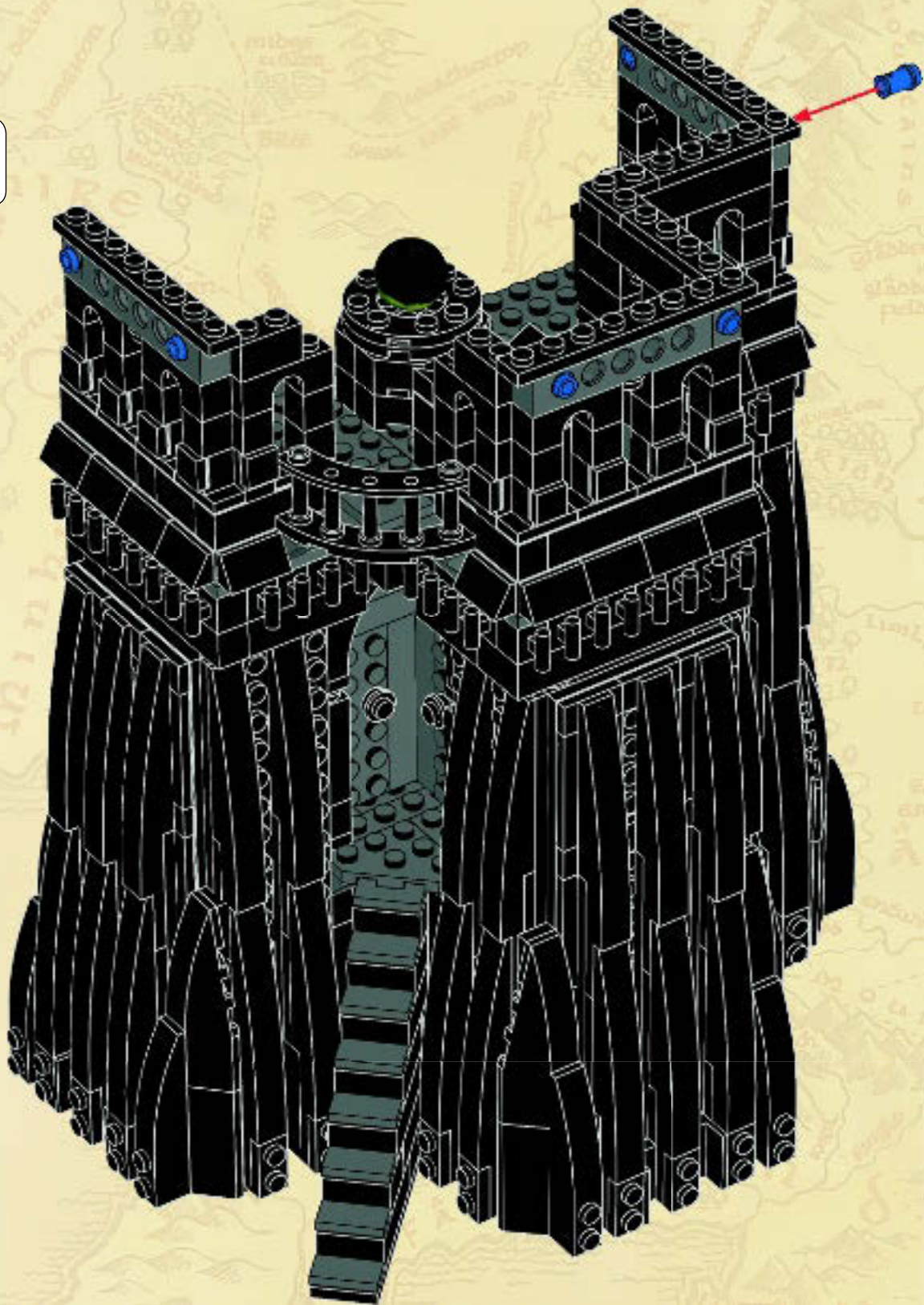
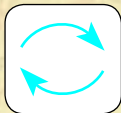



62

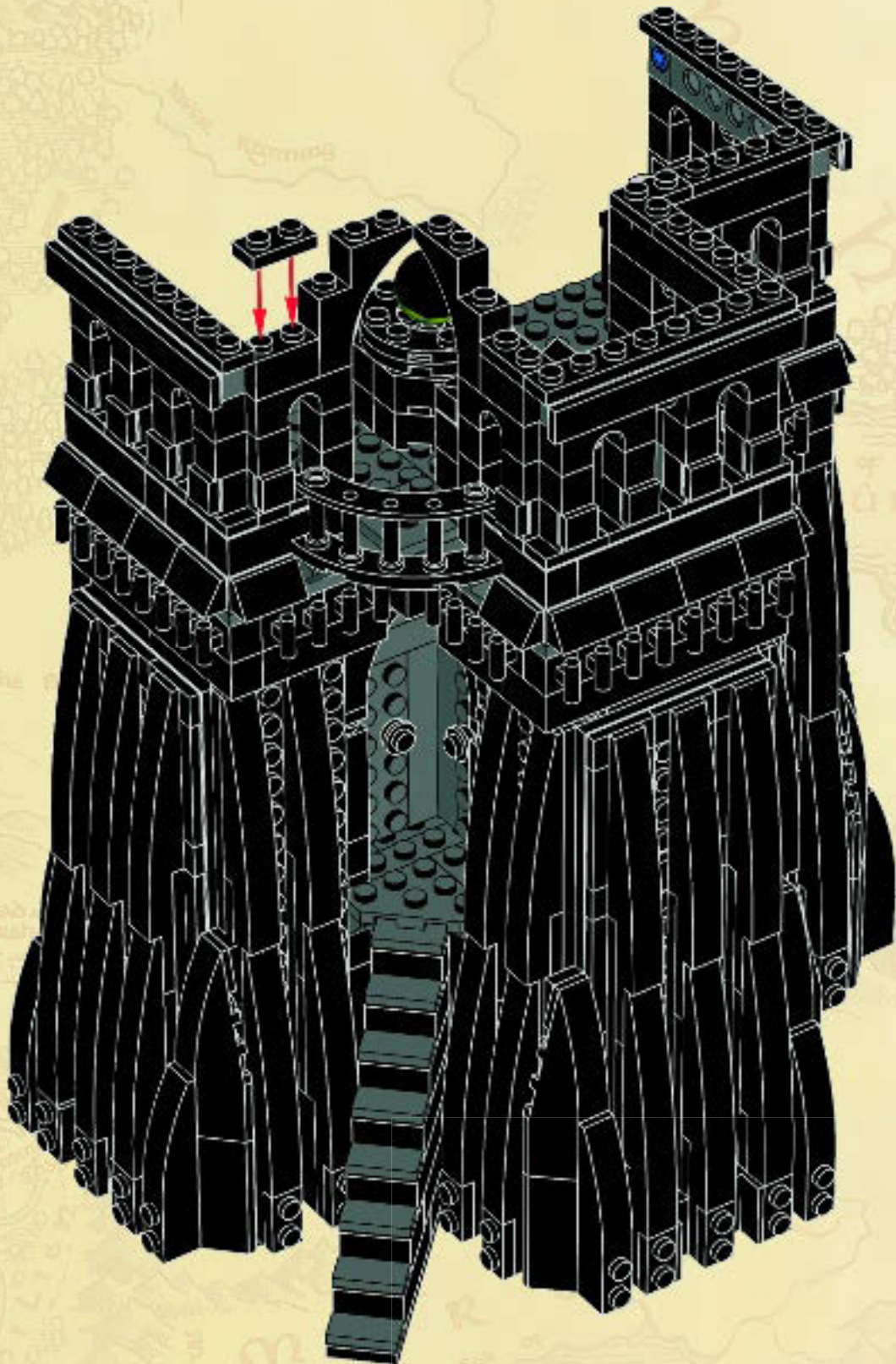



63

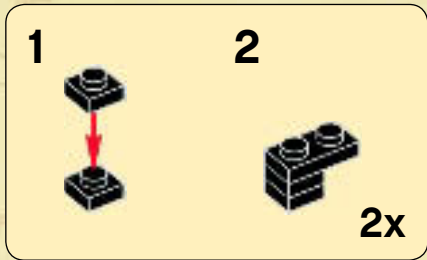

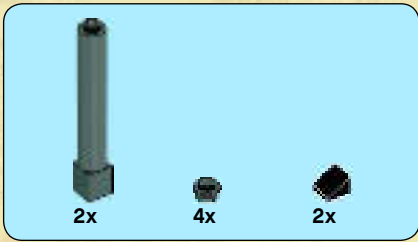

64

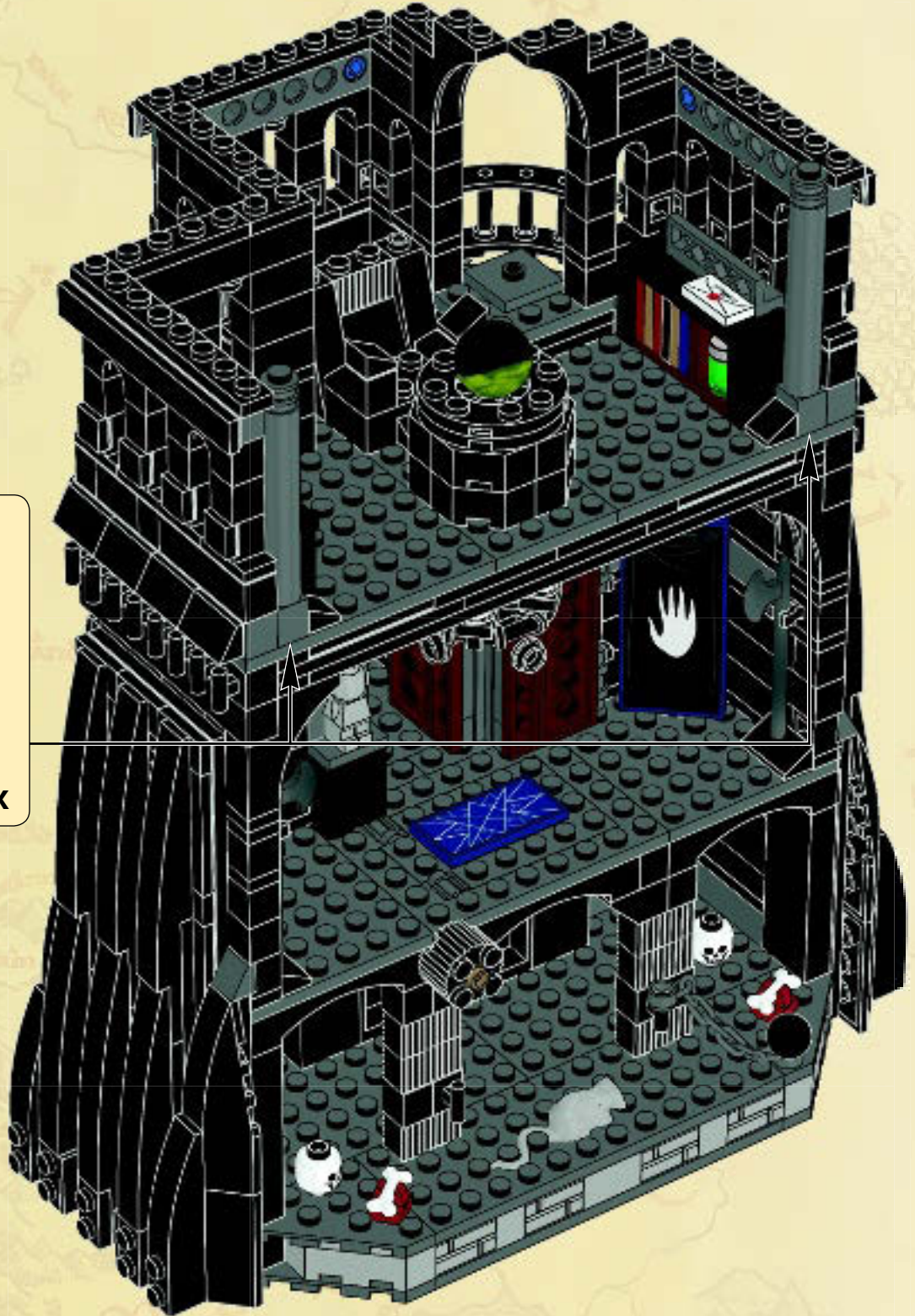
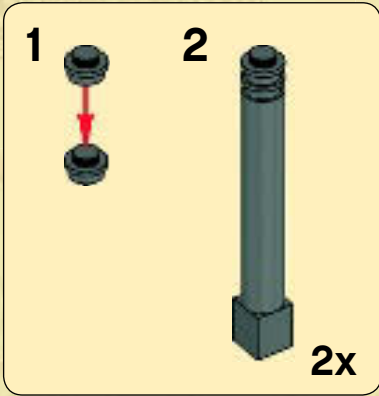
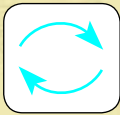

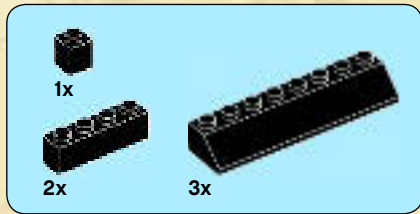

65

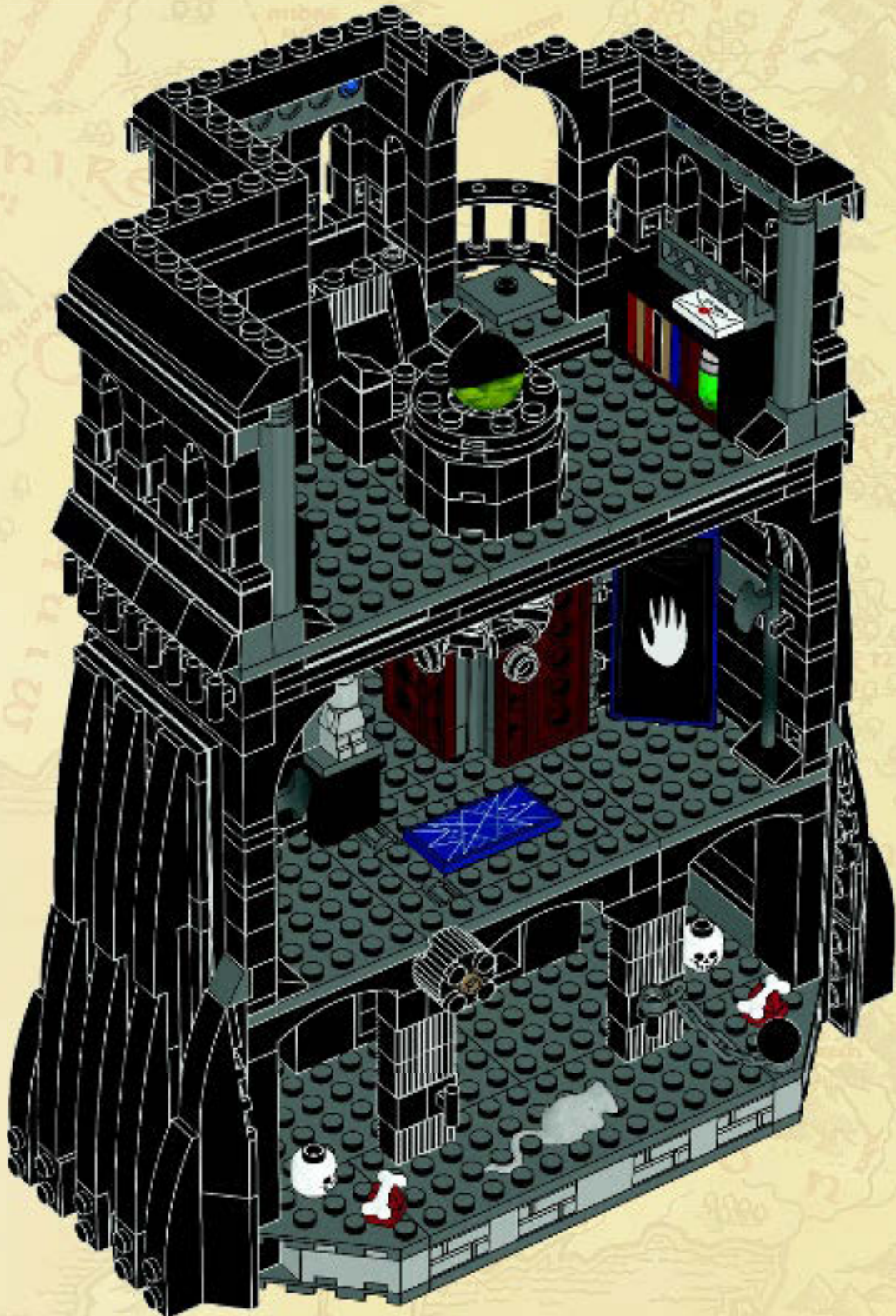

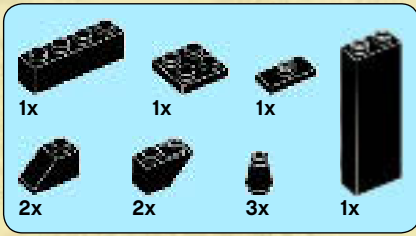

66

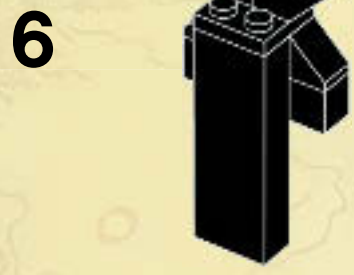
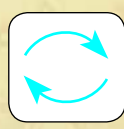
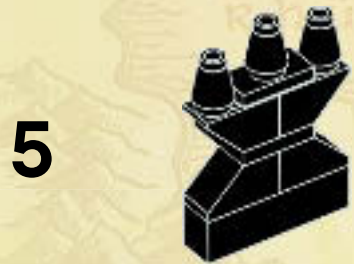
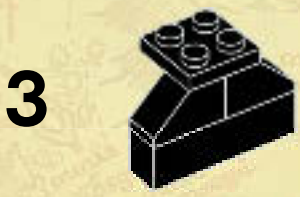
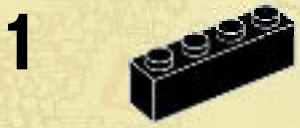

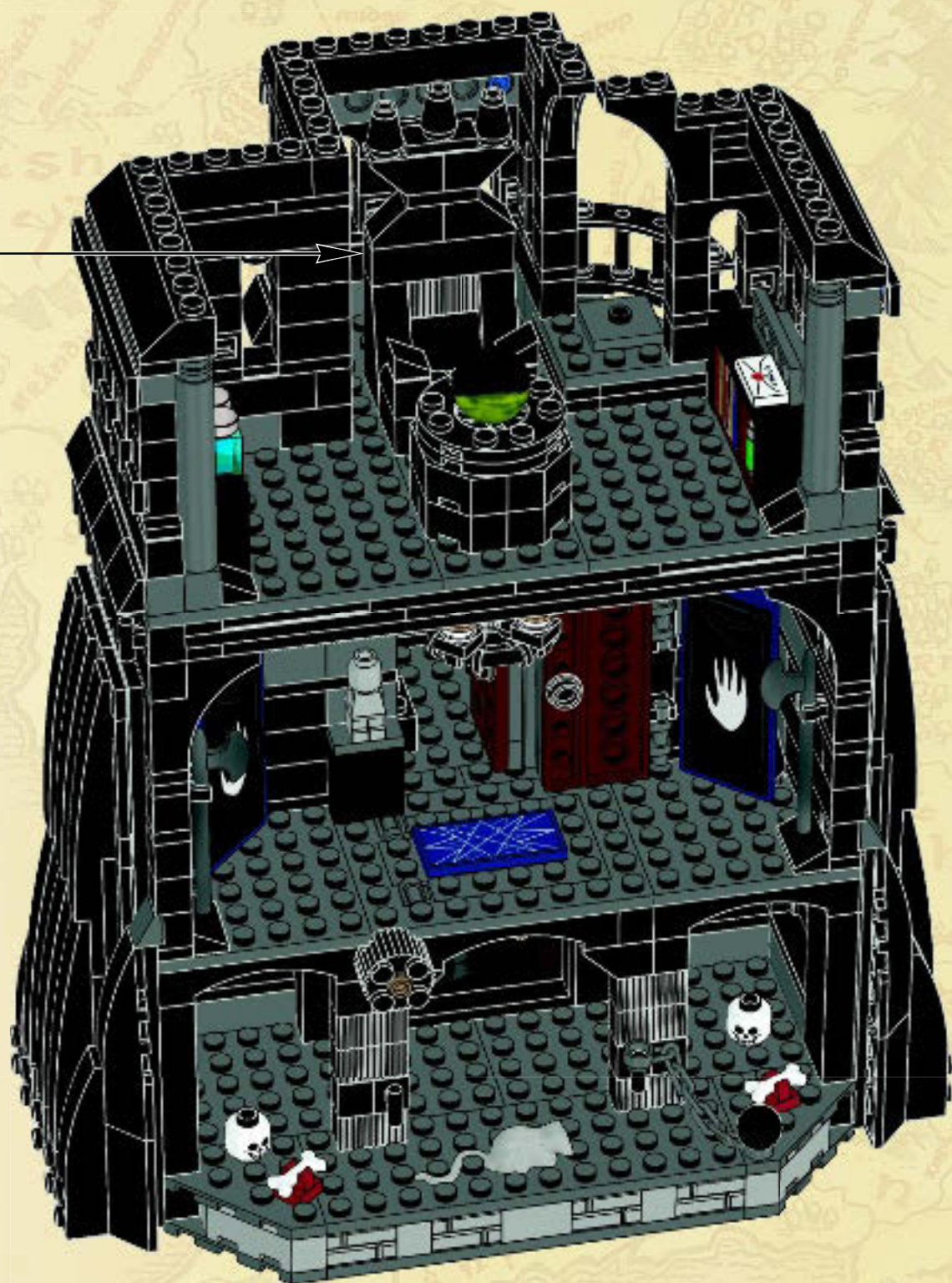

-  1x
-  1x
-  2x
-  1x

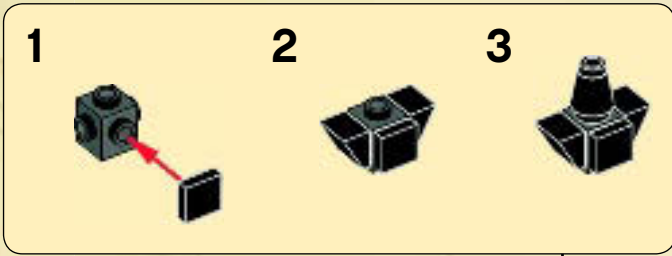

67

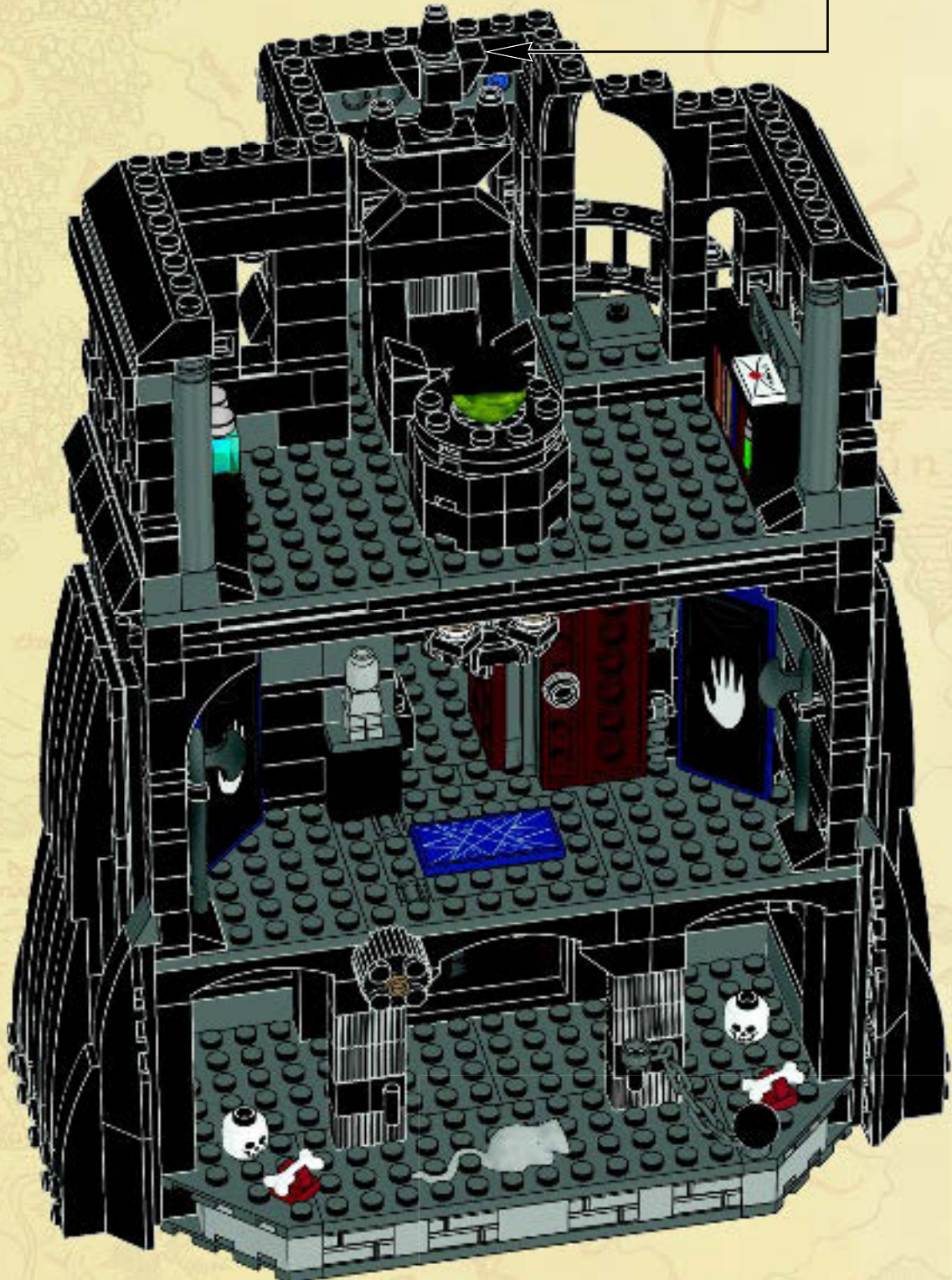

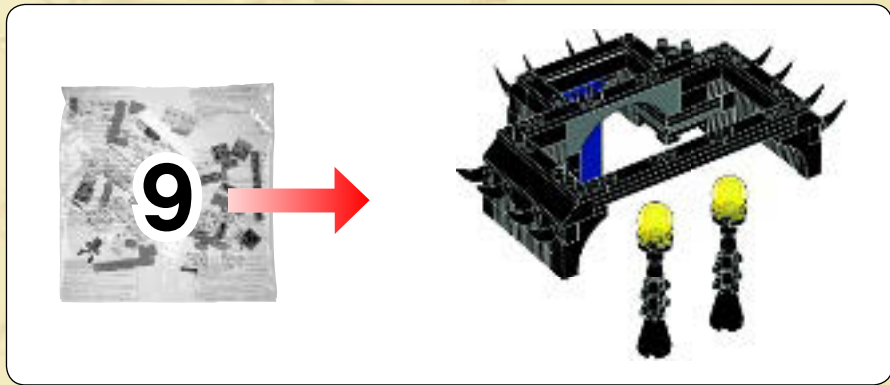

68

1



2



3



4



2x

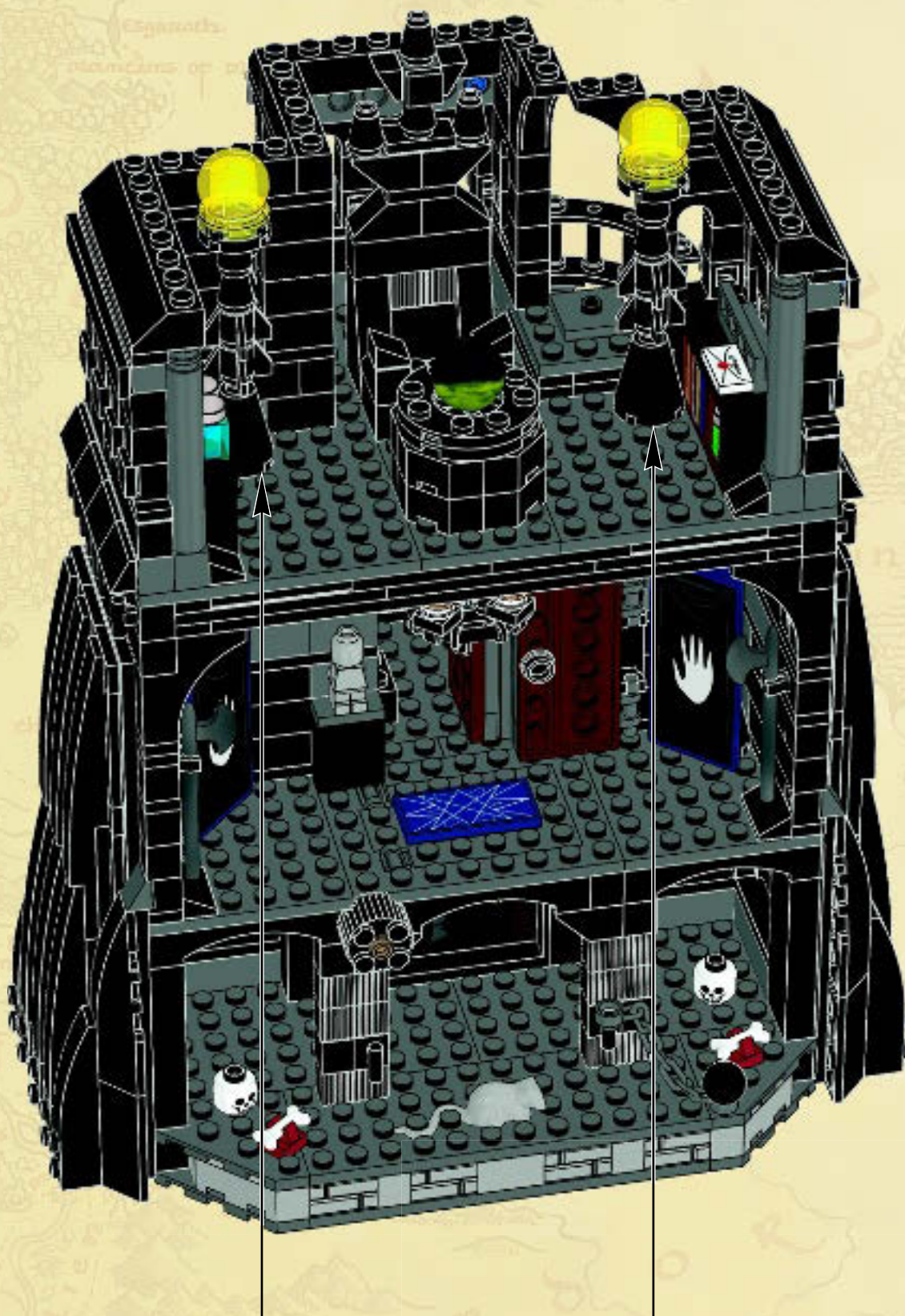



15x

5x

69

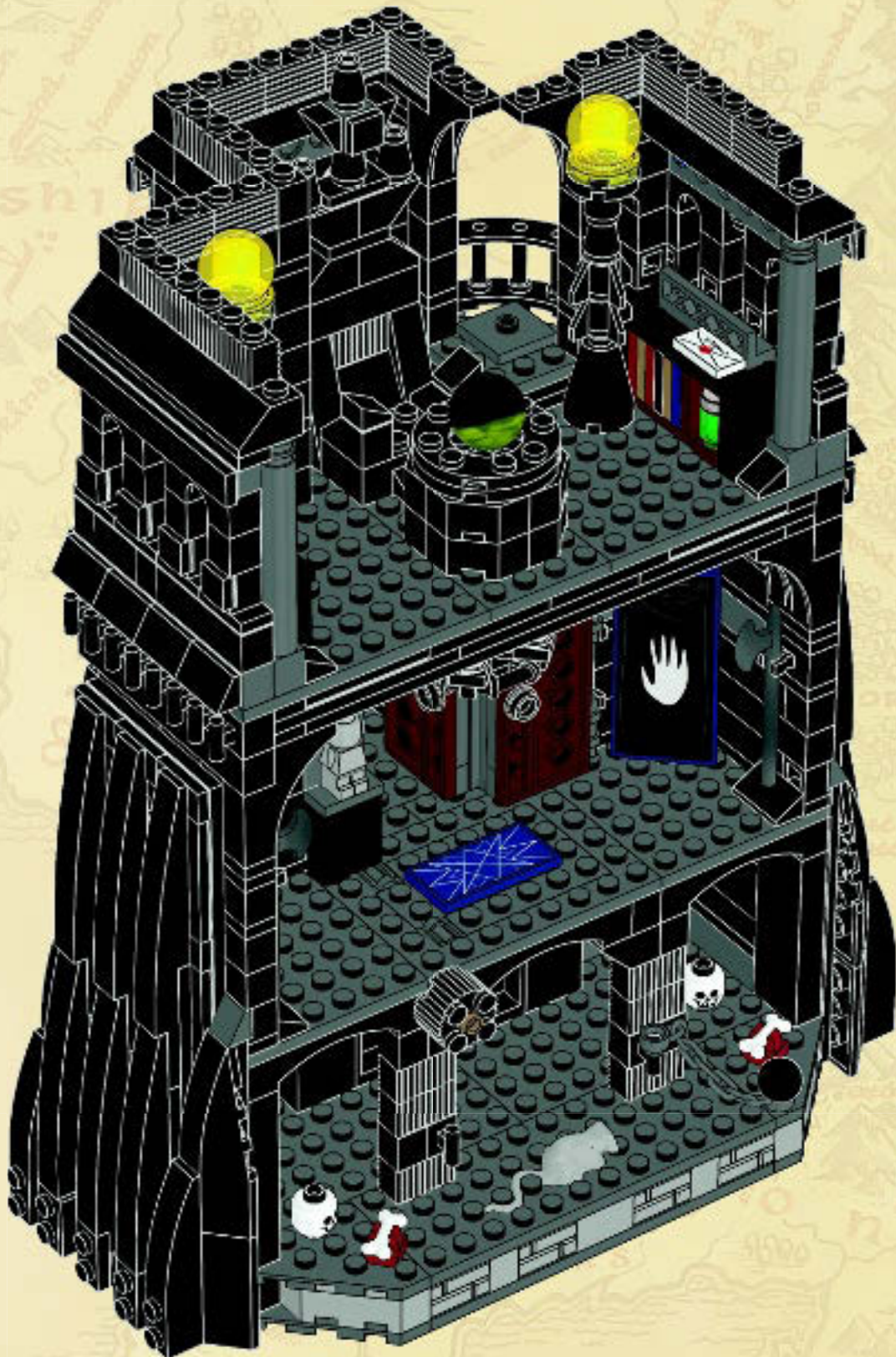



13x



2x



3x

70

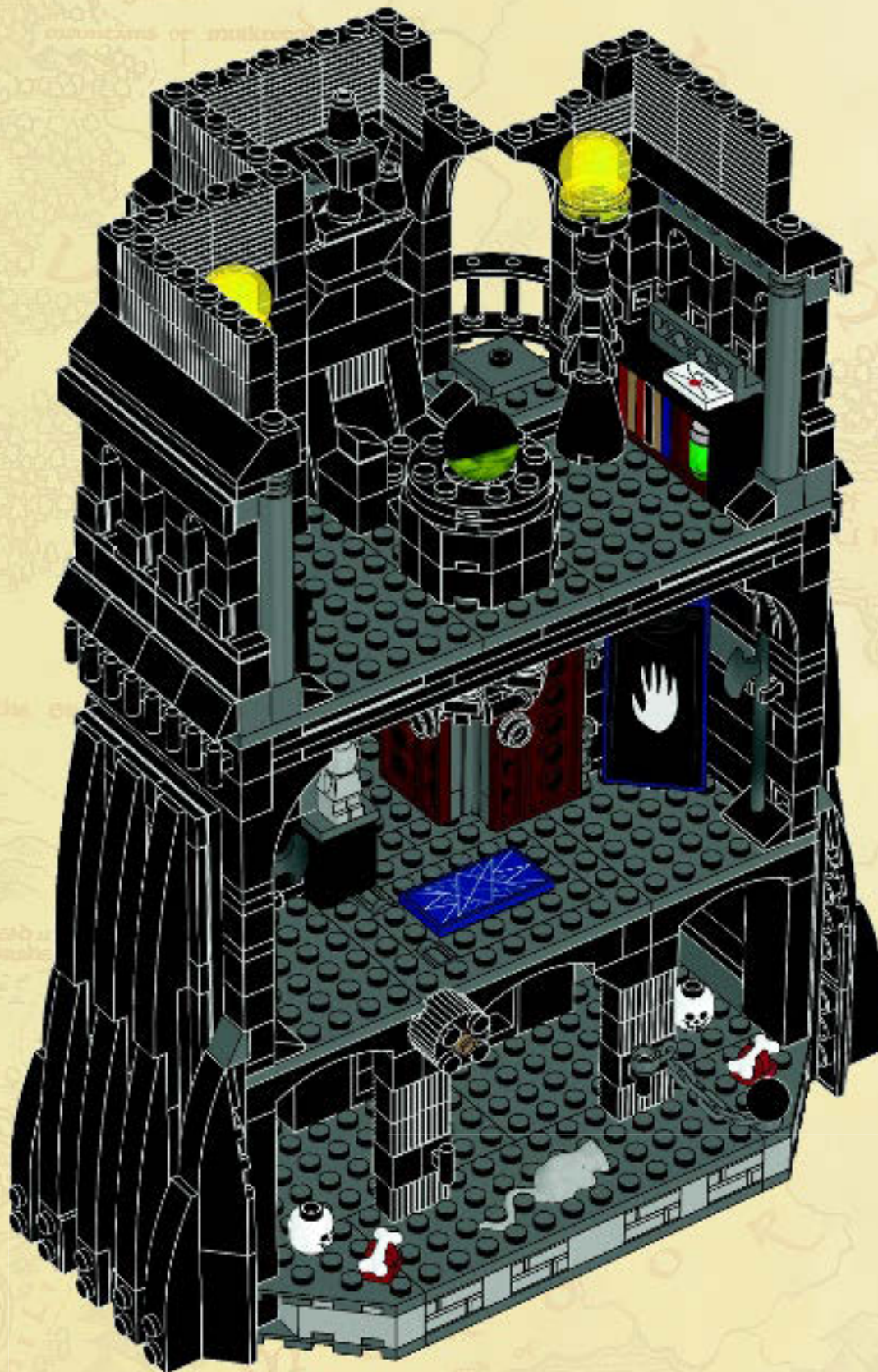

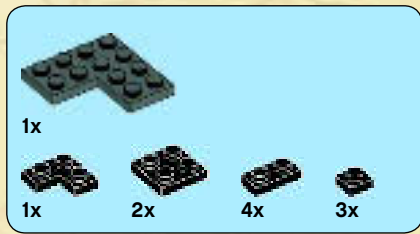

71

1



2



3

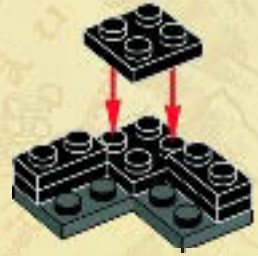

4

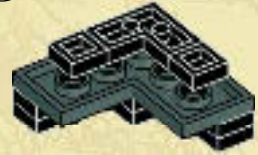
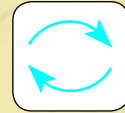

5

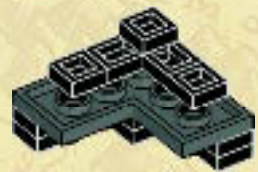

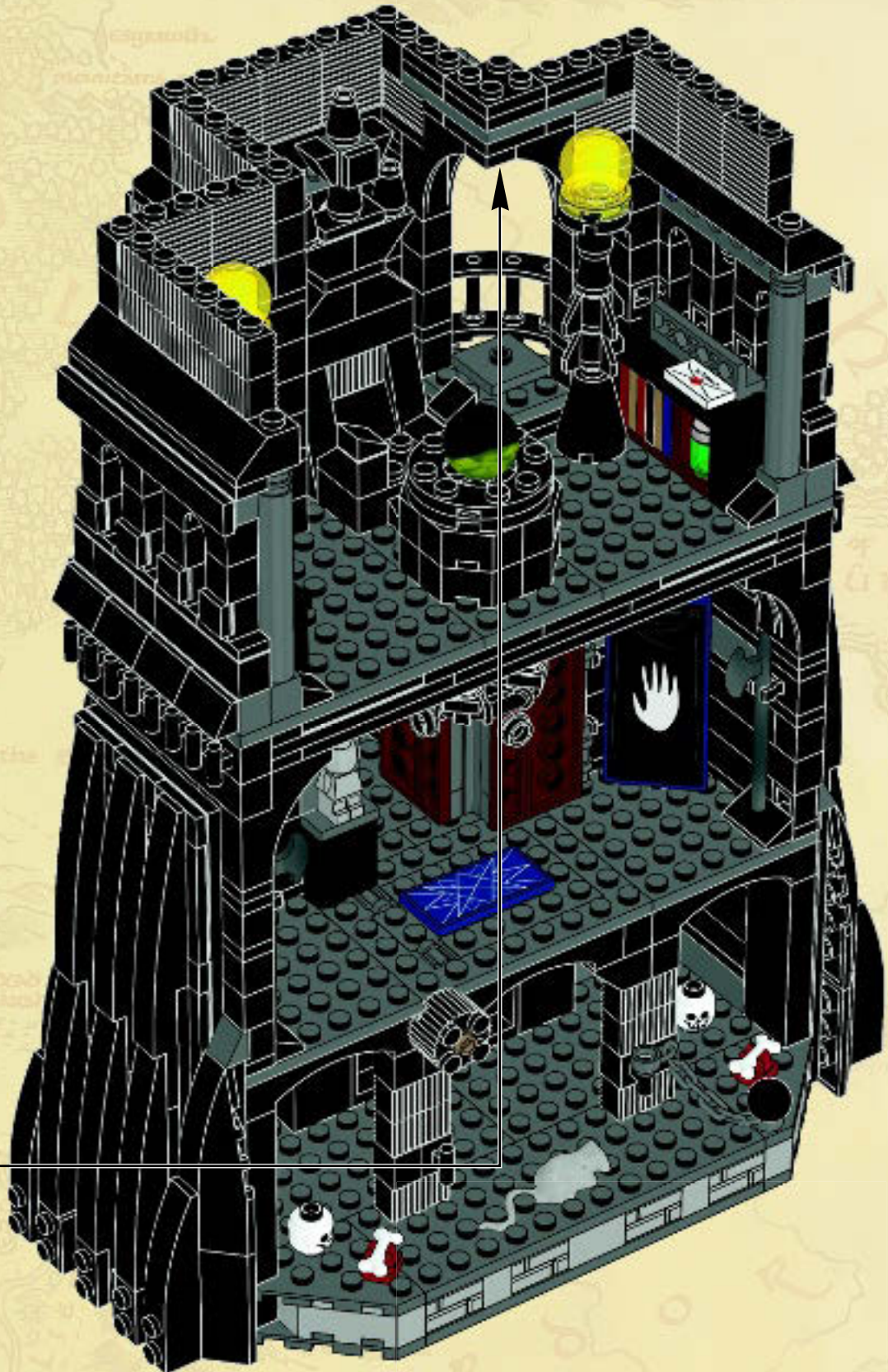

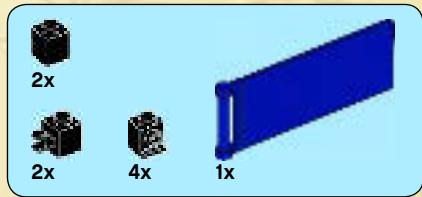

72

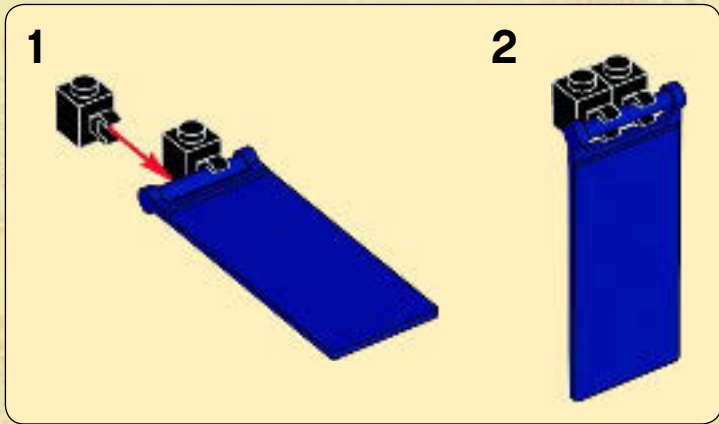

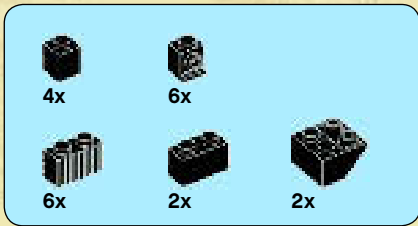

73

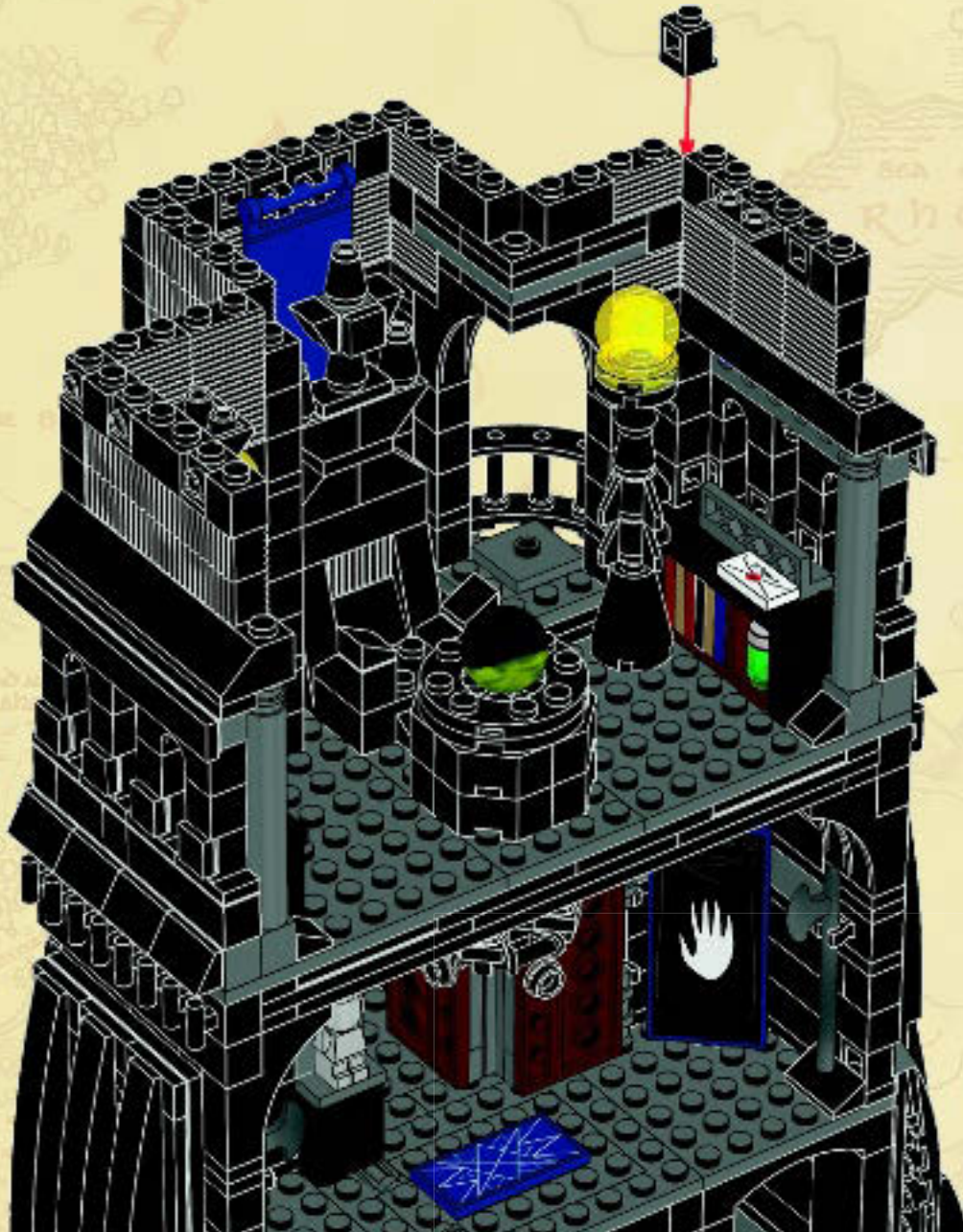

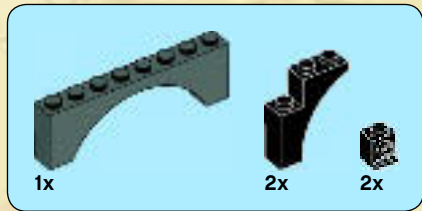

74

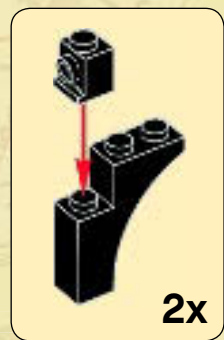

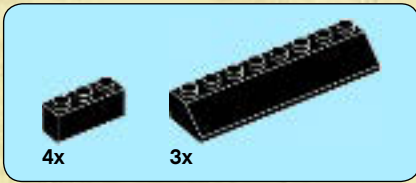

75



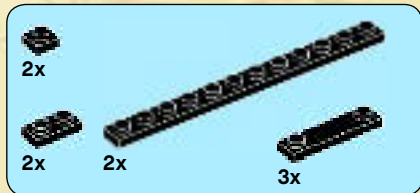

76

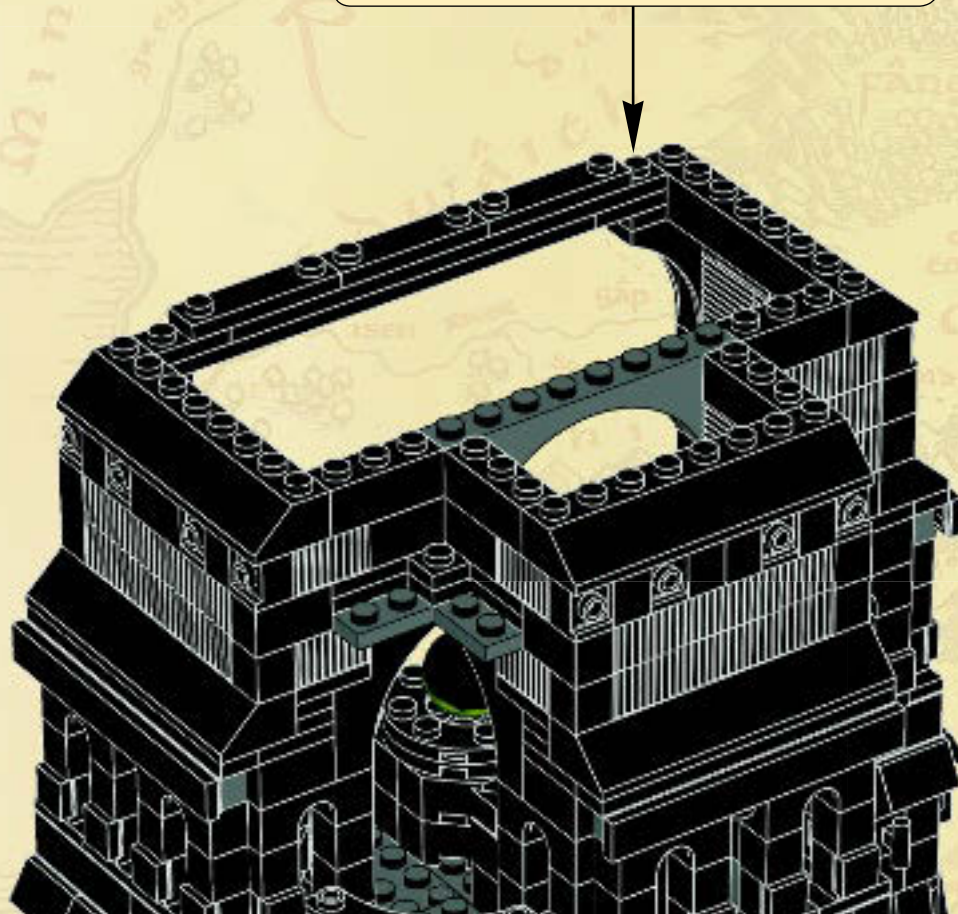
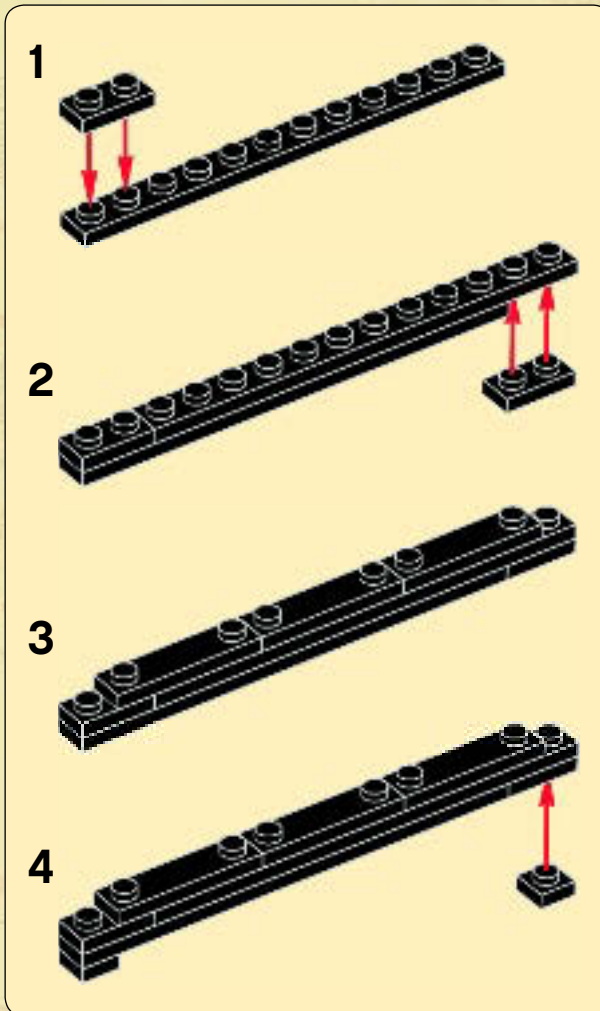



77



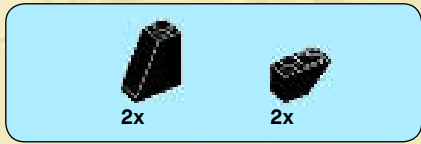

78

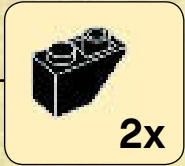

1x 3x 12x

79

1 2

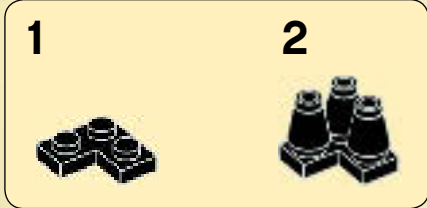

2 → 3



WIN!

Go to www.LEGOsurvey.com/product to fill out a survey for a chance to win a cool LEGO® Product.

No purchase necessary.

Open to all residents where not prohibited.



www.LEGOsurvey.com/product

GEWINNE!

Nimm an der Umfrage auf www.LEGOsurvey.com/product teil und hab die Chance ein cooles LEGO® Produkt zu gewinnen!

Die Teilnahme am Gewinnspiel führt zu keinerlei Kaufverpflichtungen. Teilnahme in allen nicht ausgeschlossenen Ländern möglich.

WIN!

Ga naar www.LEGOsurvey.com/product, vul een enquêteformulier in en maak kans op een cool LEGO® product.

Geen aankoopverplichting. Iedereen mag deelnemen, uitgezonderd ingezetenden van landen waar een enquêteverbod geldt.

GAGNE!

Visite www.LEGOsurvey.com/product pour répondre à un questionnaire et avoir une chance de gagner un produit LEGO® très cool!

Aucune obligation d'achat. Ouvert à tous les résidents des pays autorisés.

当てよう!

www.LEGOsurvey.com/product にアクセスして、アンケートにご記入ください。当選者にはレゴ製品を差し上げます。

お買い上げの必要はありません。禁止されていない限り、すべての皆様にご利用いただけます。

LEGO and the LEGO logo are trademarks of the/sont des marques de commerce de/son marcas registradas de LEGO Group.

©2013 The LEGO Group.

THE LORD OF THE RINGS: © NLP™ Middle-earth Ent. Lic. to New Line.
LE SEIGNEUR DES ANNEAUX: © NLP™ Middle-earth Ent. Lic. à New Line.
EL SEÑOR DE LOS ANILLOS: © NLP™ Middle-earth Ent.; uso autorizado a New Line.
(s13)