

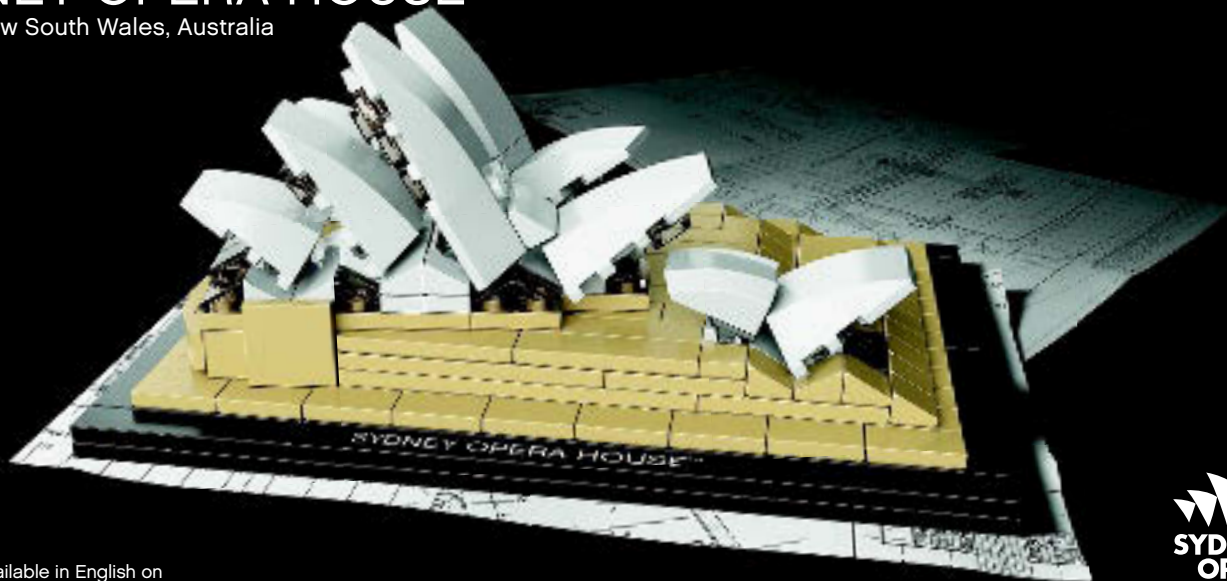





Architecture

SYDNEY OPERA HOUSE™

Sydney, New South Wales, Australia



-  Booklet available in English on
-  Livret disponible en français sur
-  Folleto disponible en español en [Architecture.LEGO.com](https://www.architecture.lego.com)



www.sydneyoperahouse.com

SYDNEY OPERA HOUSE™

Sydney Opera House is a masterpiece of late modern architecture and an iconic building of the 20th century. It is admired internationally and proudly treasured by the people of Australia. It was created by a young Danish architect, Jørn Utzon (1918-2008), who understood the potential provided by the site against the stunning backdrop of Sydney Harbour.



Sydney Opera House projects into the harbour, with the central business district of the city behind.
© Michael Moy Idea to Icon



The three groups of interlocking shells are set on a vast terraced platform.
© Michael Moy Idea to Icon

The massive concrete sculptural shells that form the roof of Sydney Opera House appear like billowing sails filled by the sea winds with the sunlight and cloud shadows playing across their shining white surfaces. Utzon envisaged it as being like to a Gothic cathedral that people would never tire of and never be finished with.

Today Sydney Opera House does not operate solely as a venue for opera or symphony, but also hosts a wide range of performing arts and community activities. These include classical and contemporary music, ballet, opera, theatre, dance, cabaret, talks and large scale public programs.

Since its opening in 1973 over 45 million people have attended more than 100 000 performances, and it is estimated that well over 100 million people have visited the site. It is one of Australia's most visited tourist attractions, being the most internationally recognized symbol of the nation. Today Sydney Opera House welcomes more than 8 million visitors and presents around 2400 events a year.

Opposite page: Sydney Opera House on Bennelong Point.
© WE-EF LIGHTING 2011 Photo Ralph Alfonso



History

The history of Sydney Opera House is as extraordinary and complex as the building itself. It is a story of vision, courage, dedication, challenge, controversy and triumph.

Its many remarkable elements include the submission of a visionary design that the judges courageously selected as the winner; the collaborative partnership of architect and engineer that produced ground-breaking construction solutions; the breach created by Jørn Utzon's departure from the project in 1966; and his re-engagement in 1999 to provide design principles to guide Sydney Opera House into the future.

It began in 1956 when the New South Wales (NSW) Government announced an international design competition and appointed an independent jury. The competition brief did not specify design parameters or

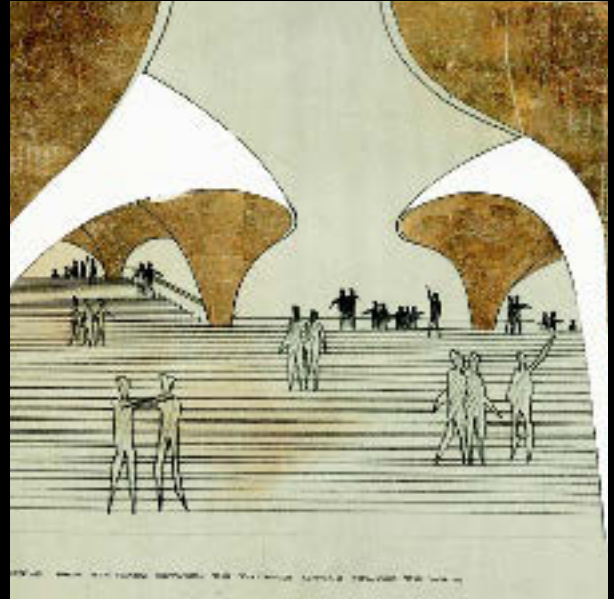

Competition drawings submitted by Jørn Utzon to the Opera House Committee; Perspective from the staircase between the two halls looking towards the north, 1956. © State Records NSW

set a cost limit. The only requirement was for a design of two performance halls: a Major Hall for grand opera and symphony; and a Minor Hall for drama. There was to be additional space for experimental theatre and rehearsals.

The combination of site and brief proved irresistible: 933 competitors from all over the world registered and 233 entries were received from 28 countries. Judging took place in January 1957 and the entry of the relatively unknown architect, Jørn Utzon, was the unanimous winner. Both the architectural fraternity and the public were amazed by the design and found it to be a spectacular response to the brief and the site.

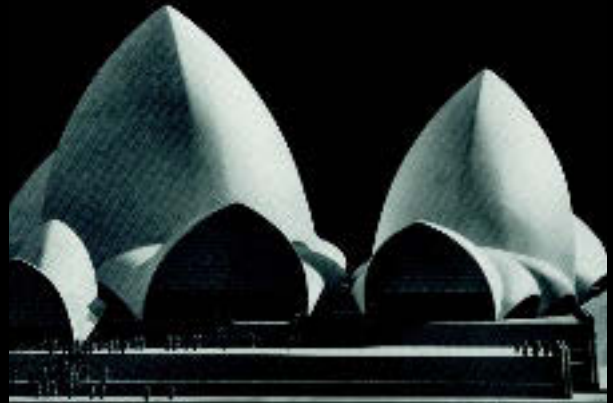

Model of Sydney Opera House. © State Records NSW

Construction

Utzon's distinct design was comprised of sets of interlocking vaulted 'shells' based upon a podium. Over three years Utzon gradually made changes from his original concept drawings in order to develop a way to construct the large roof shells. While the Podium was under construction, the geometry of the shells had not yet been resolved from an engineering perspective. Many options were explored, culminating in Utzon's 'spherical

solution', developed in collaboration with Ove Arup, using segments of a single sphere. This allowed cost effective prefabrication from a single set of moulds.

The scale of construction of Sydney Opera House was enormous. Over 30 000 cubic metres of rock and soil had to be removed from the site and the construction of the shell structure required the world's largest crane.

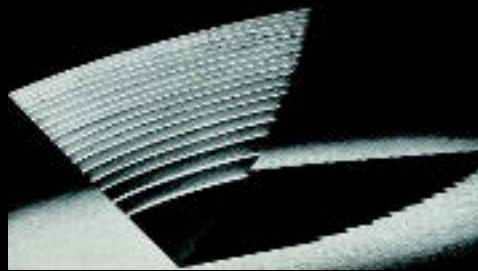

Models of shells. © State Records NSW

From 1964 the pre-cast rib vaults of the shells began to be erected on the completed podium. The construction of the roof brought together some of the world's best construction engineers and craftsmen for one of the most difficult engineering tasks ever attempted. It was also the first time computers were used to resolve some of the engineering/design problems.



The Podium takes shape at Bennelong Point. Photograph by Max Dupain and Associates



Sydney Opera house during construction. Photograph by Max Dupain and Associates



Sydney Opera House is a significant feat of engineering and technology involving ingenuity and creativity in many aspects of its design and construction. Photograph by Max Dupain and Associates

Although Utzon had spectacular plans for the interior of the shells, he would be unable to realize this part of his design. A change of government and growing criticism at cost overruns led to Utzon's withdrawal in February 1966. By April he had left Sydney, never to return.

The NSW Government appointed a team of local architects to complete the glass walls and interiors. The use of the main halls was revised. The Major Hall was dedicated to symphony and renamed the Concert Hall. The Minor Hall was dedicated to opera and dance and renamed the Opera Theatre. Three previously unplanned venues were added underneath the Concert Hall on the western side.

Sydney Opera House was formally opened by Her Majesty Queen Elizabeth II on 20 October 1973 in front of a large crowd. The opening was also televised and included fireworks and a performance of Beethoven's Symphony No. 9.

The opening of Sydney Opera House in 1973. Photograph by Max Dupain and Associates



It would be over 30 years before the architect would be reunited with his masterpiece. After a number of approaches, conversations and meetings, Utzon agreed in 1999 to be re-engaged to develop a set of Design Principles that would act as a guide for all future changes to the building.

The work as he saw it would be to “articulate the overall vision and detailed design principles for the site, and for the form of the building and its interior”.

His first major project was the refurbishment of the Reception Hall into a stunning, light filled space which highlights the original concrete 'beams' and a wall-length tapestry designed by him which hangs opposite the harbour outlook. The room was renamed the Utzon Room in his honour in 2004.

Utzon, in collaboration with his architect son Jan and Sydney-based architect Richard Johnson, would continue to work on a series of modern alterations right up to his death in 2008.



© Michael Moy Idea to Icon

Design

Sydney Opera House is an exceptional building. Its architectural form comprises three groups of interlocking vaulted 'shells', set upon a vast terraced podium and surrounded by flat broadwalks that function as pedestrian promenades.

The shells are clad in glazed off-white tiles while the podium is clad in earth-toned, reconstituted granite panels. The two main halls are arranged side by side, oriented North-South with their axes slightly inclined.



*The matt and glossy roof tiles took three years to develop with the manufacturer.
© Michael Moy Idea to Icon*

The auditoria are carved out of the high north end of the podium so that they face south, towards the city, with the stage areas positioned between them and the entrance foyers.

The north and south ends of the shells are hung with topaz coloured glass walls that project diagonally outwards to form foyers, offering views from inside and outside. The tallest shell reaches the height of a 20-storey building above the water. The shell structures cover nearly two hectares and the whole site is nearly six hectares.



The podium is clad in earth-toned panels © Michael Moy Idea to Icon

In 2007 Sydney Opera House was inscribed in the World Heritage List: "List, described as "a great" architectural work of the 20th century. It represents multiple strands of creativity, both in architectural form and structural design, a great urban sculpture carefully set in a remarkable waterscape and a world famous iconic building." The expert evaluation report to the World Heritage Committee stated: "...it stands by itself as one of the indisputable masterpieces of human creativity, not only in the 20th century but in the history of humankind."



*The powerful geometric forms of Sydney Opera House.
© Michael Moy Idea to Icon*



Glass walls projecting diagonally outwards. © Michael Moy Idea to Icon

Jørn Utzon

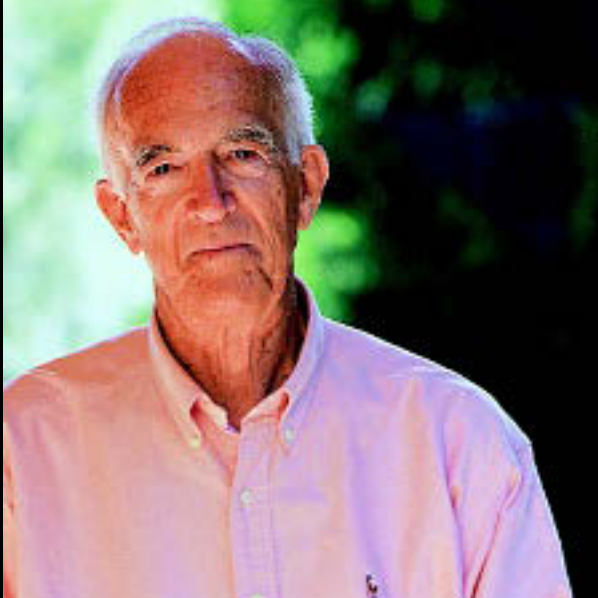

*[I like to be on the edge
of the possible.]*

Jørn Utzon

Jørn Utzon was born on April 9 1918 in Copenhagen, Denmark. He grew up in the town of Aalborg, where his father was a naval architect and engineer and director of the local shipyard. A keen sailor, Utzon originally intended to follow his father as a naval engineer, but opted to study Architecture at the Copenhagen Royal Academy of Arts.

On graduating in 1942, he worked in Sweden until the end of World War II. He was influenced by Gunnar Asplund and later Alvar Aalto, with whom he worked in Finland for a short period after the war. In 1949 he received a grant that enabled him and his wife Lis to travel extensively in USA and Mexico, coming into contact with some of the most influential architects of his day, including members of Frank Lloyd Wright's school at Taliesin, Mies van der Rohe, Ray and Charles Eames and Richard Neutra. He was also in Paris meeting with Le Corbusier and the sculptor Henri Laurens, whose influence taught him much about form.

A major project took him to Morocco; unfortunately the project was not realized, but he used the opportunity to walk along the Atlas mountain range, where he was very inspired by the indigenous adobe architecture. He returned to Copenhagen in 1950 to open his own architectural practice.

In 1956, after winning a number of smaller architectural competitions, Utzon submitted his vision for Sydney Opera

House to the New South Wales Government. He was as surprised as anyone when he actually won the competition.

His competition entry was a schematic design, clearly explaining the concept for the building. The sketches and 'geometrically undefined' curves of course needed to be developed for the building to be built. This is quite normal for competition projects. Utzon himself was sure it could be built and in the pioneering spirit present in Sydney at the time, construction went ahead.

It was Utzon's life and travels that had shaped his ideas for Sydney Opera House. Though he had never visited the site, he used his maritime background to study naval charts of Sydney harbour. His early exposure to shipbuilding provided the inspiration for the Sydney Opera House 'sails' and would also help him solve the challenges of their construction. From his travels to Mexico, he had the idea of placing his building on a wide horizontal platform.

After he was forced from the project by a new client in 1966, Utzon continued to push modern architecture

toward an era of freer experimentation. The principles behind his renowned Bagsværd Church (1976) in the suburbs of Copenhagen and his parliament building in Kuwait (1983) can be traced directly back to his original vision for Sydney Opera House.

The reconciliation with Sydney Opera House in 1999 brought Utzon great pleasure. In 2003, the same year the Opera House celebrated its 30th birthday, Jørn Utzon was awarded the Pritzker Prize for Architecture, the highest award in its field. A year later in 2004, the newly refurbished Reception Hall was renamed the Utzon Room in his honour. With its wide, bare spaces, its colourful tapestry (designed by himself), pale timbered floor and a ceiling of folded concrete beams, it was exactly as he had dreamed it.

Jørn Utzon passed away peacefully in his sleep in Copenhagen on 29 November 2008 aged 90. His legacy lives on through the World Heritage listed Sydney Opera House and his Design Principles as a permanent record of his vision for the place, as well as the many other magnificent structures he designed around the world.



© Michael Moy Idea to Icon

Facts about SYDNEY OPERA HOUSE™

Location:..... Bennelong Point, Sydney,
New South Wales, Australia

Architect:..... Jørn Utzon

Style:..... Expressionist

Materials:..... Concrete, ceramic, granite,
bronze and glass

Construction:..... Concrete frame & precast
concrete ribbed roof with ceramic
tiles and reconstituted granite
cladding to the base

Date:..... From 1959 to 1973

Footprint:..... 1.8 hectares (4.5 acres)

Height:..... 67 m. (220 ft.)

Sydney Opera House sits on Bennelong Point, where, for thousands of years prior to European settlement, local Aboriginal people of the group known as the Cadigal people occupied the land. The site was named Bennelong Point after a local Aboriginal man known as Bennelong, was captured and subsequently befriended by Governor Arthur Philip.

Sydney Opera House acknowledges the important history of the Bennelong Point site and the rich contribution Aboriginal



Sydney Opera House and the Harbour Bridge. © Michael Moy Idea to Icon

and Torres Strait Islander cultures make to the diversity of the Australian community.

Sydney Opera House has developed a Reconciliation Action Plan which sets measurable targets to work towards closing the gap between Aboriginal and Torres Strait Islander Australians and their fellow Australians. For more information please see www.sydneyoperahouse.com/rap

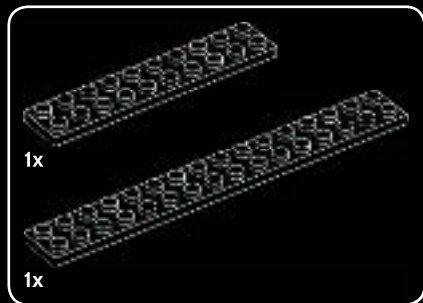

1

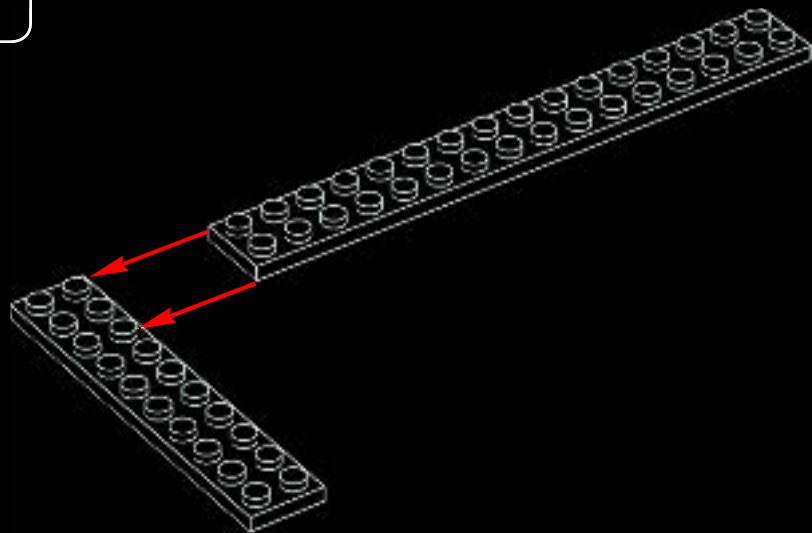

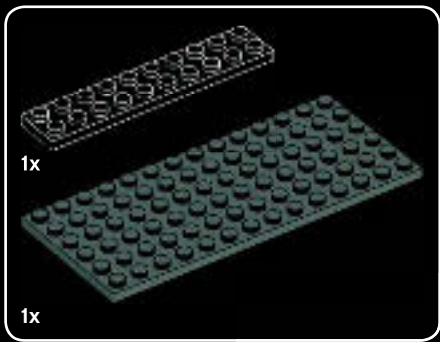

2

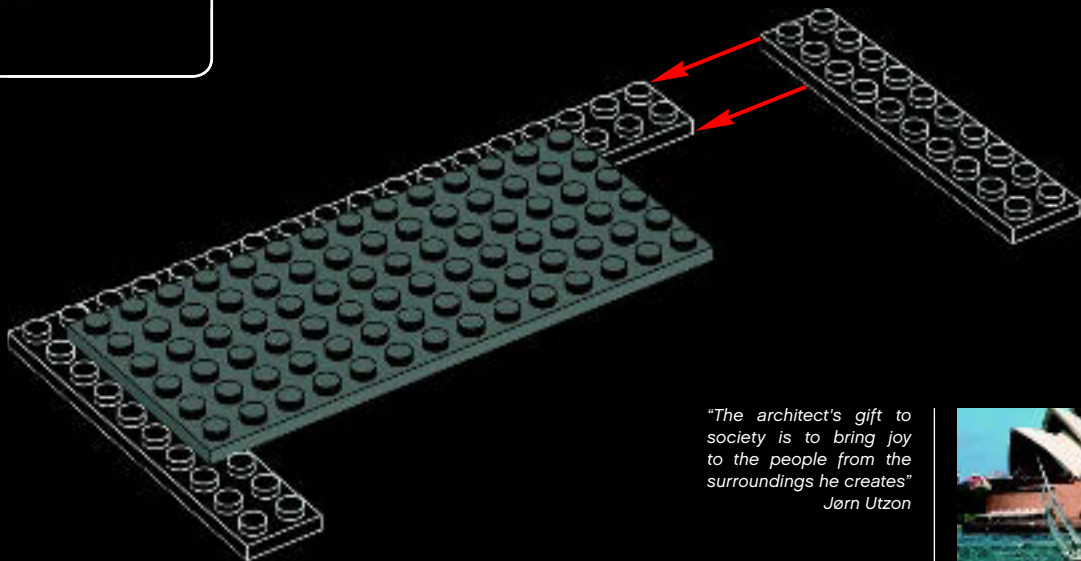

"The architect's gift to society is to bring joy to the people from the surroundings he creates"
Jørn Utzon



© Michael Moy, Idea to Icon

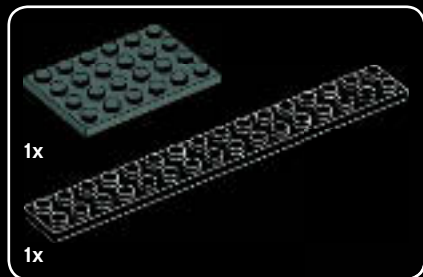

3

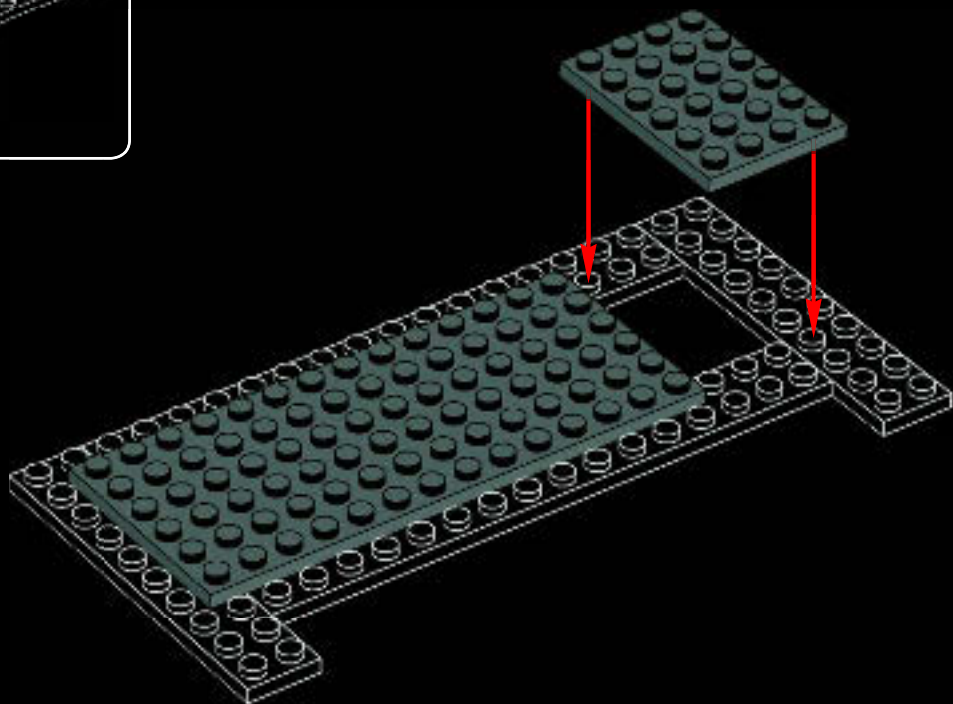



1x

4

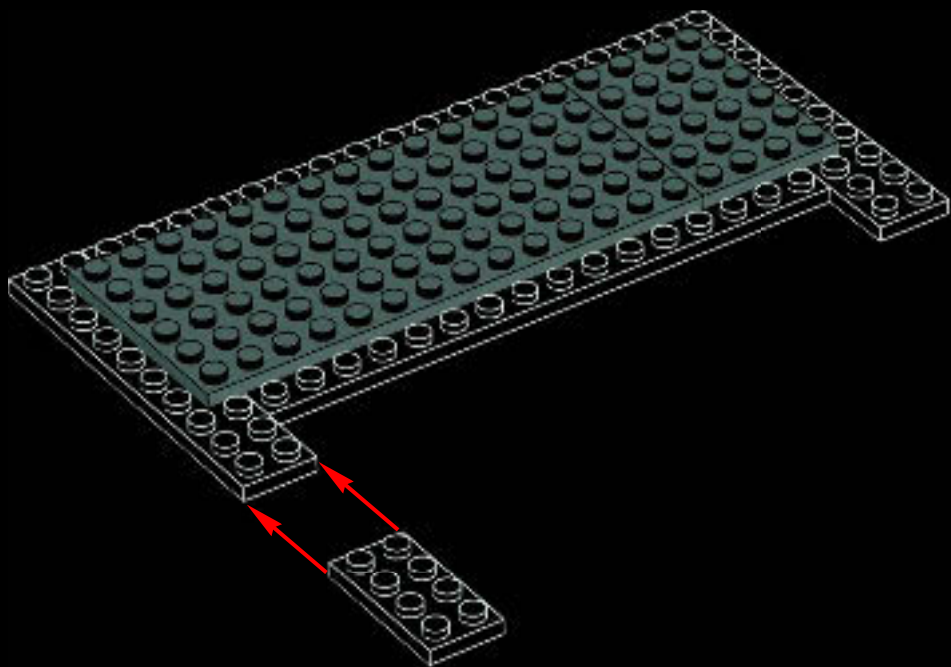



5

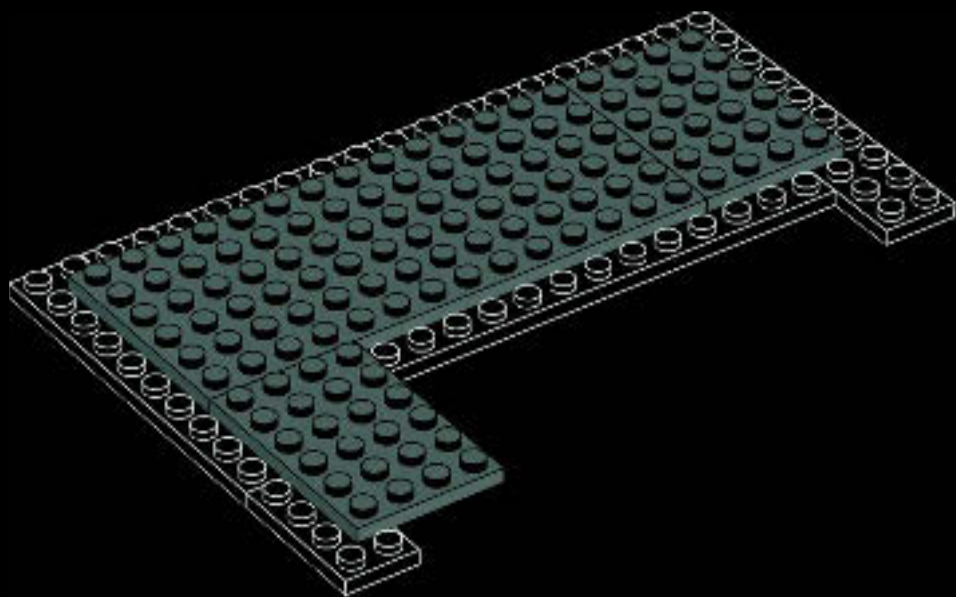

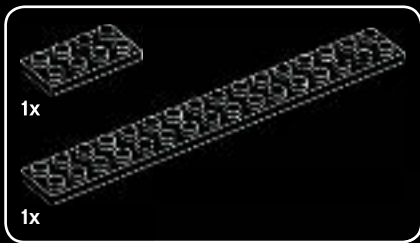

6

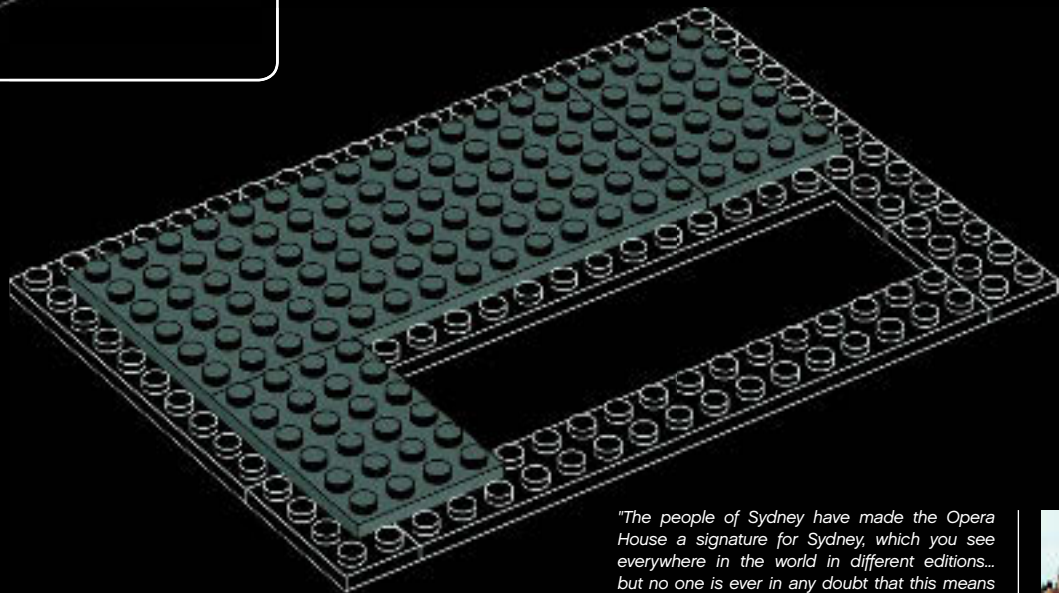

"The people of Sydney have made the Opera House a signature for Sydney, which you see everywhere in the world in different editions... but no one is ever in any doubt that this means Sydney and this means Australia... in my opinion, a situation such as this, where a building is having a great impact on a city is a rare thing"

Jørn Utzon



© Michael Moy, Idea to Icon



7

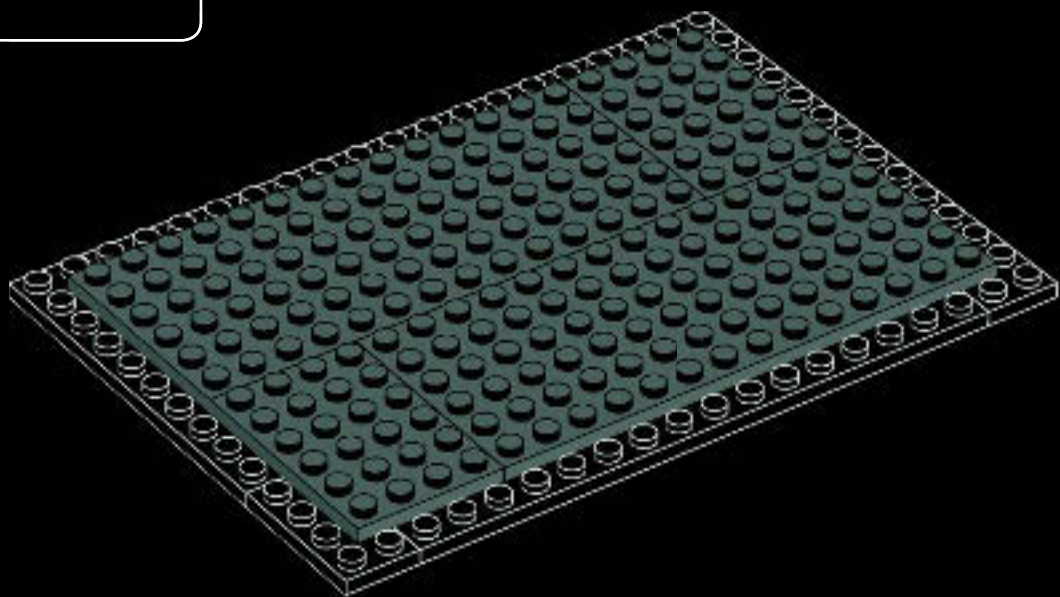



8x

8

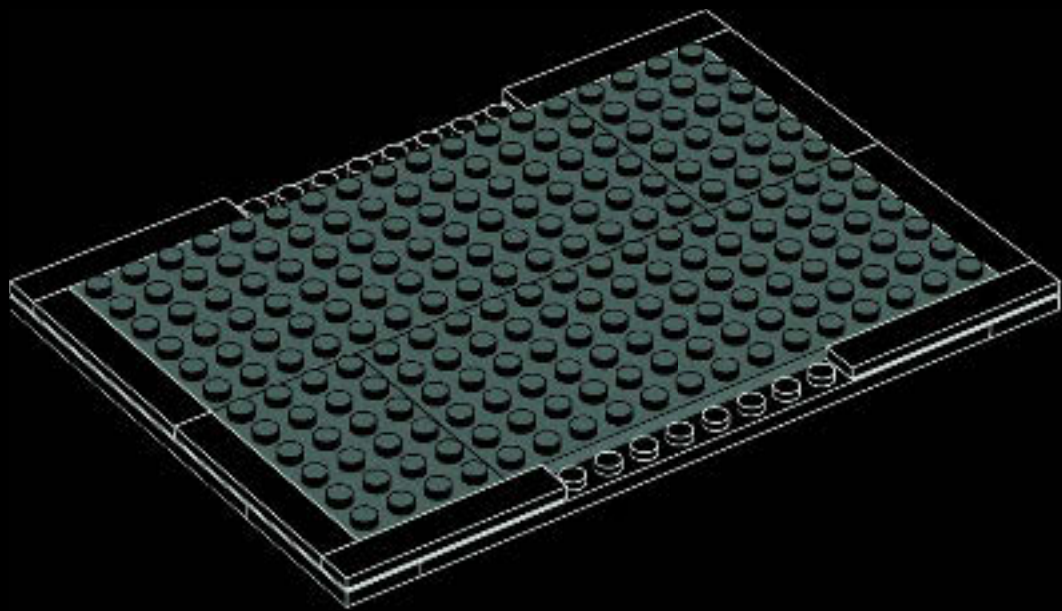

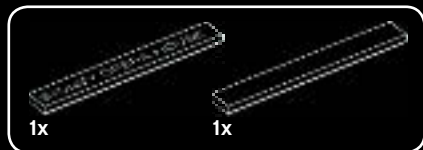

9

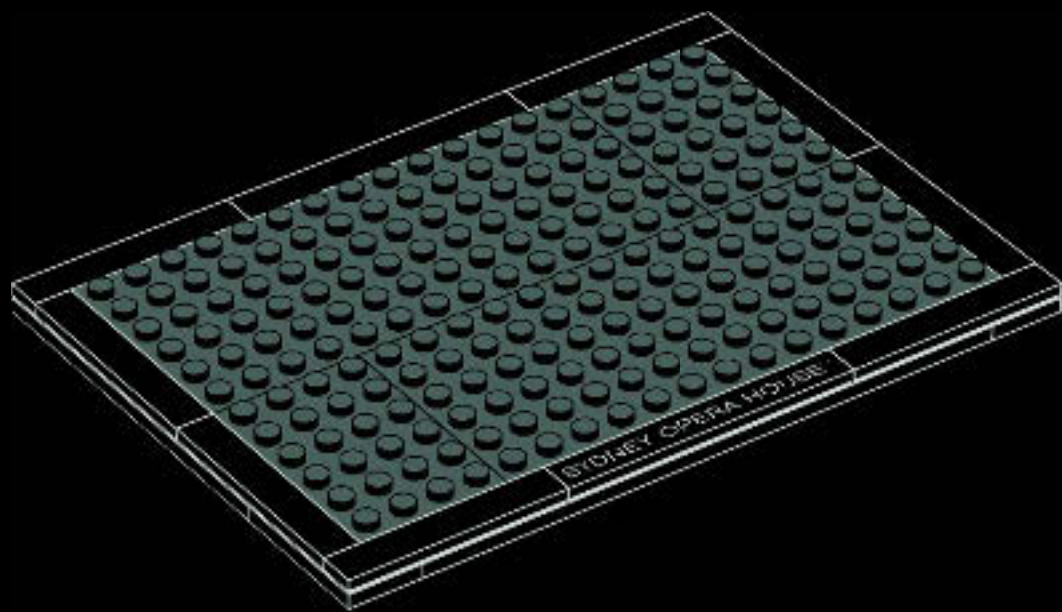



9x



1x

10

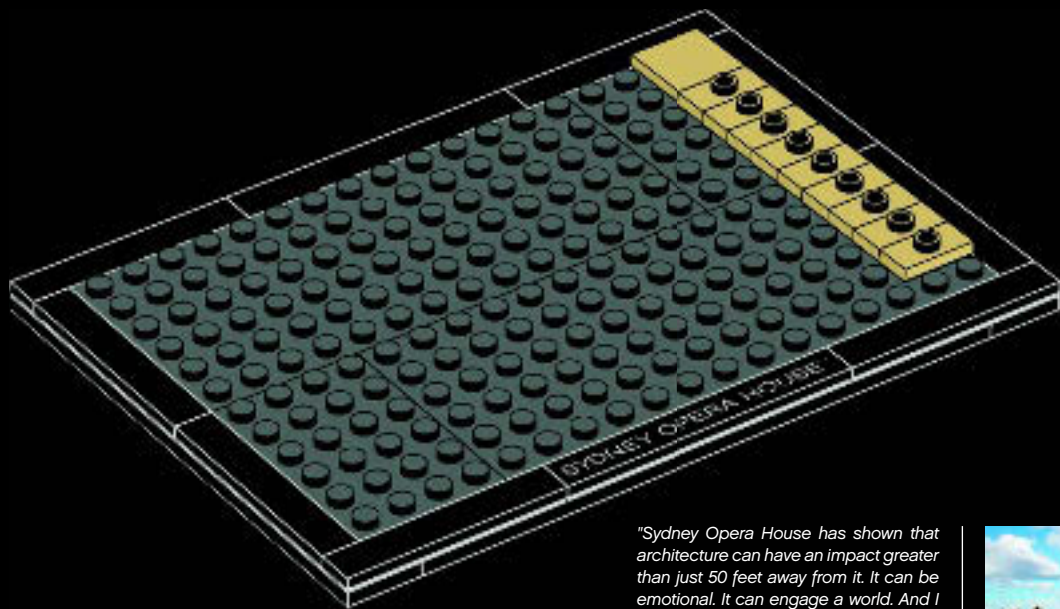

"Sydney Opera House has shown that architecture can have an impact greater than just 50 feet away from it. It can be emotional. It can engage a world. And I think we should all be grateful for that example in our time."

- Frank Gehry, architect of Walt Disney Concert Hall, Los Angeles



© Michael Moy, Idea to Icon



6x



2x

11

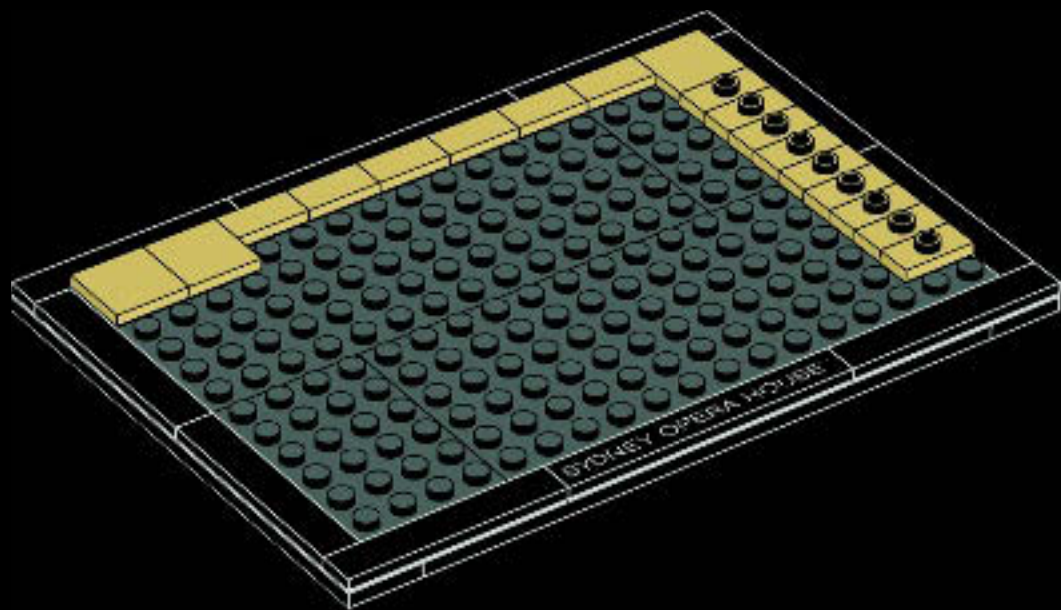



7x



2x

12

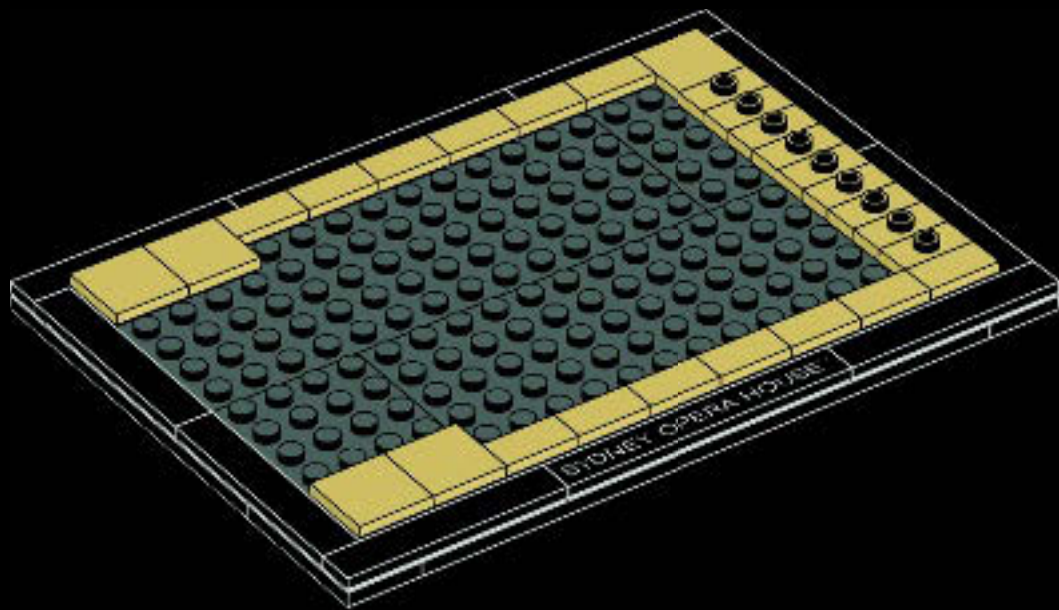



10x

13

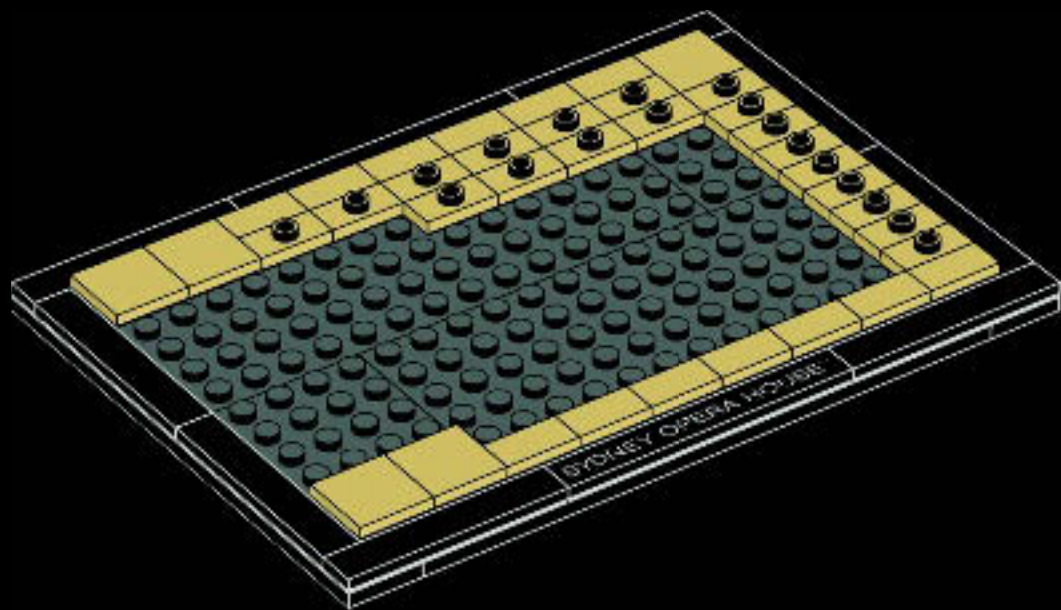



10x



1x

14

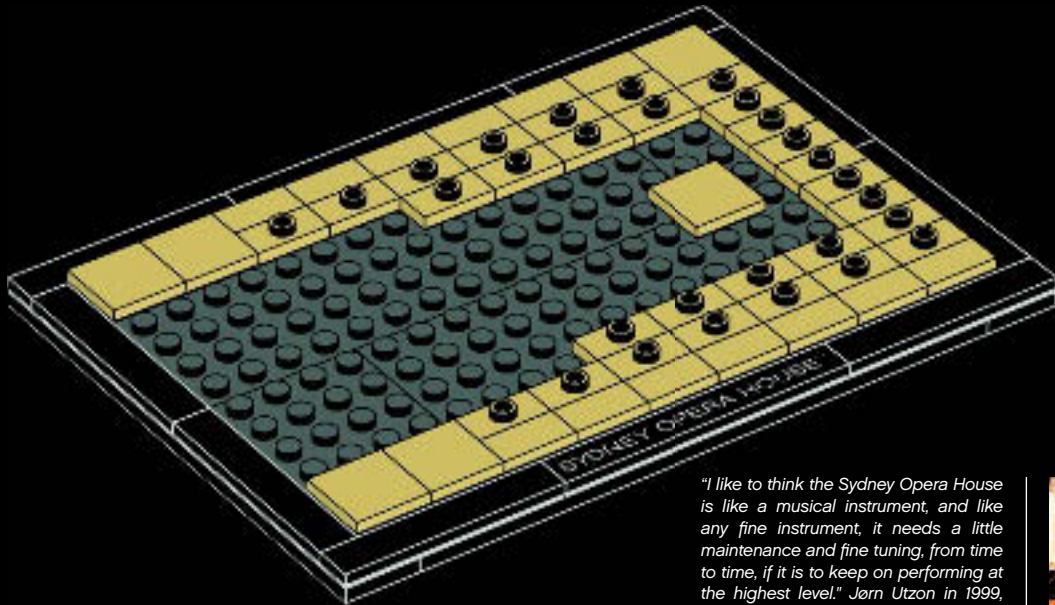

"I like to think the Sydney Opera House is like a musical instrument, and like any fine instrument, it needs a little maintenance and fine tuning, from time to time, if it is to keep on performing at the highest level." Jørn Utzon in 1999, when he agreed to act as the design guardian for the building.



© Michael Moy, Idea to Icon



1x



1x



2x

15

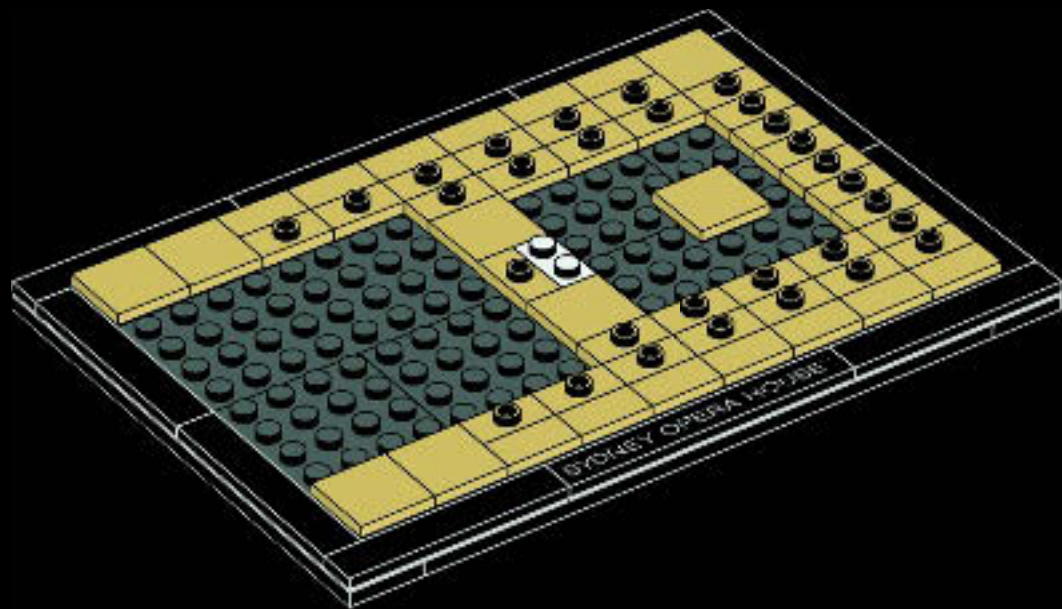



16

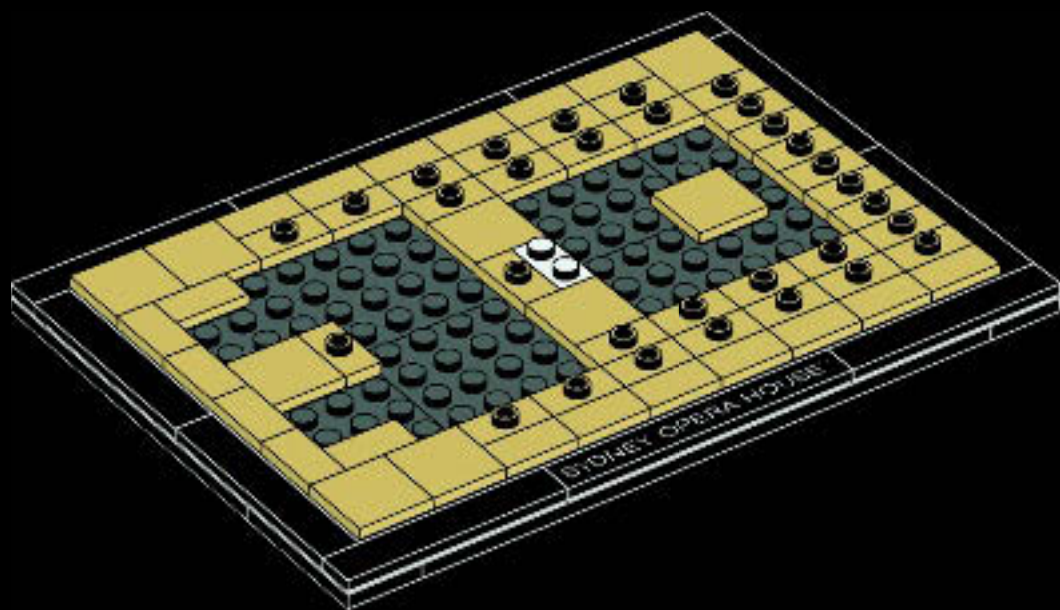



2x



2x

17

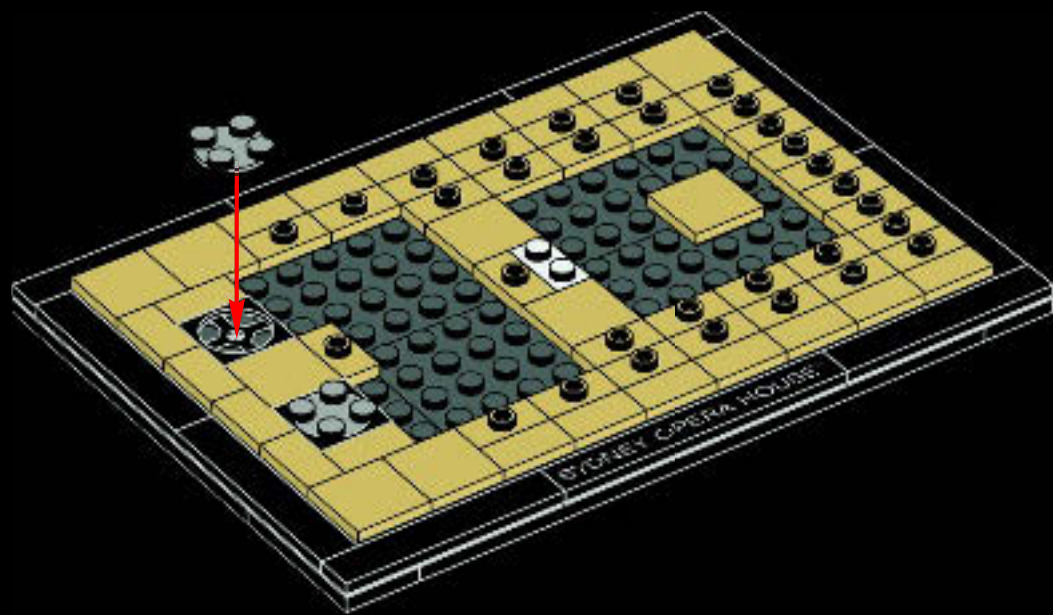



9x

18

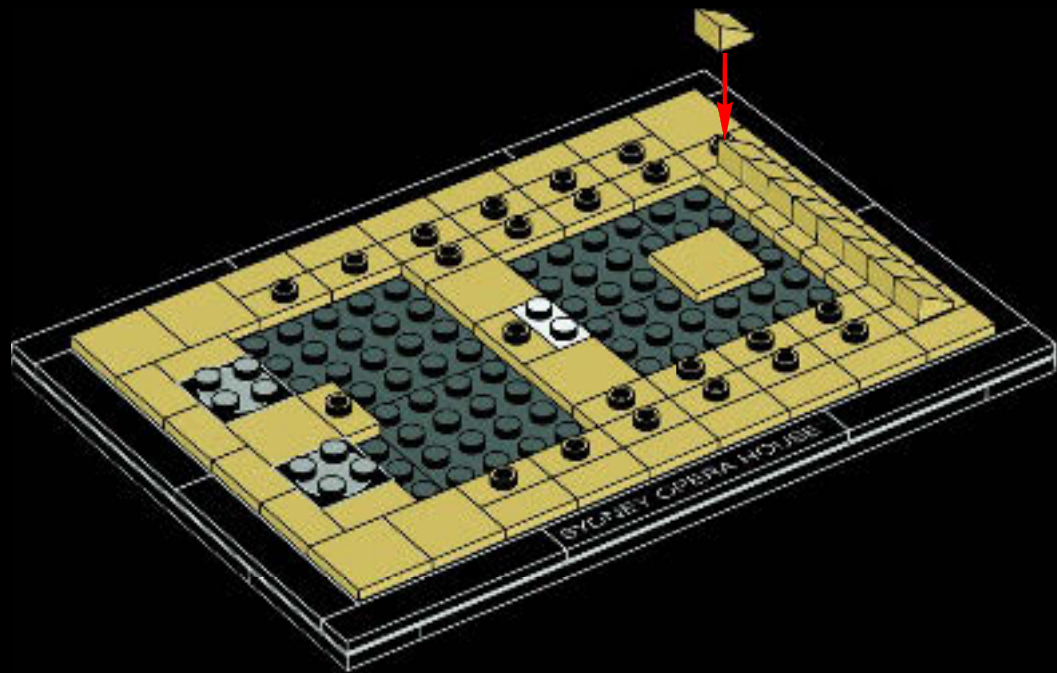

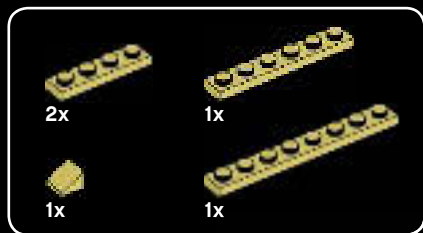

19

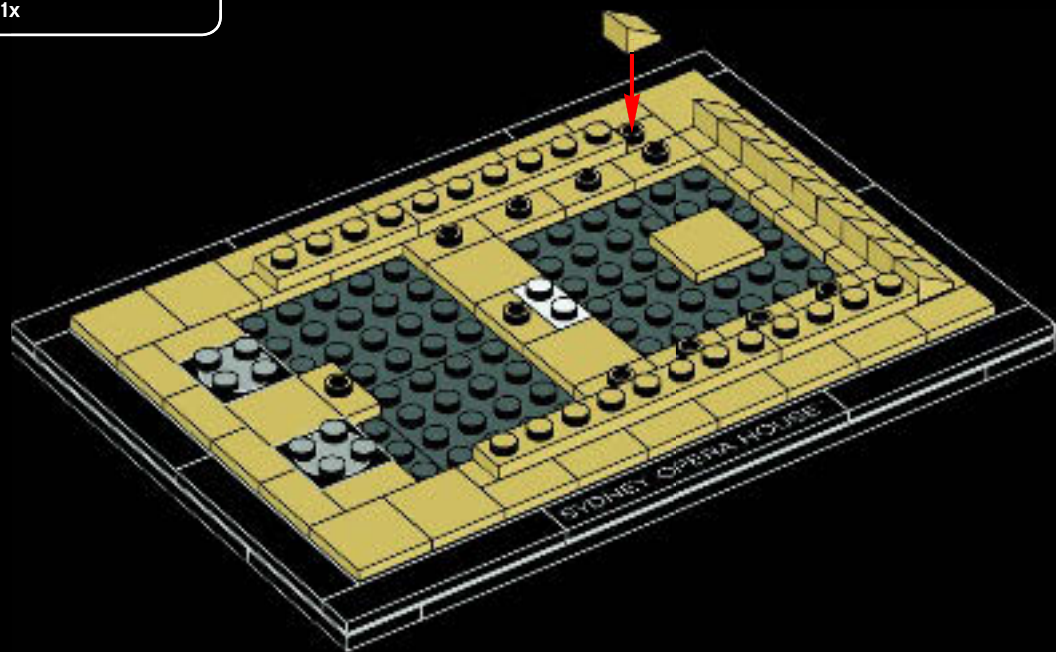

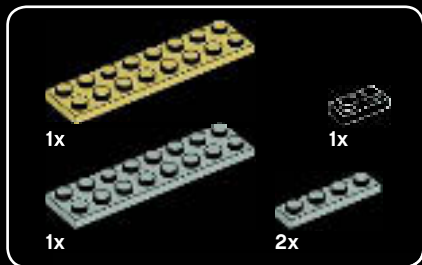

20

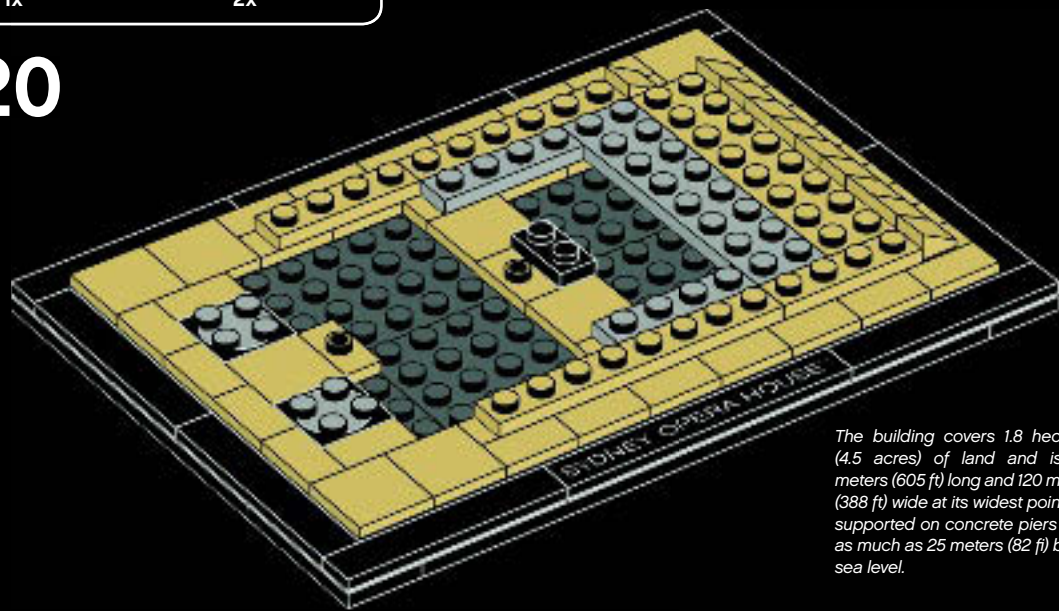

The building covers 1.8 hectares (4.5 acres) of land and is 183 meters (605 ft) long and 120 meters (388 ft) wide at its widest point. It is supported on concrete piers sunk as much as 25 meters (82 ft) below sea level.



© Michael Moy, Idea to Icon



1x



2x



1x

21

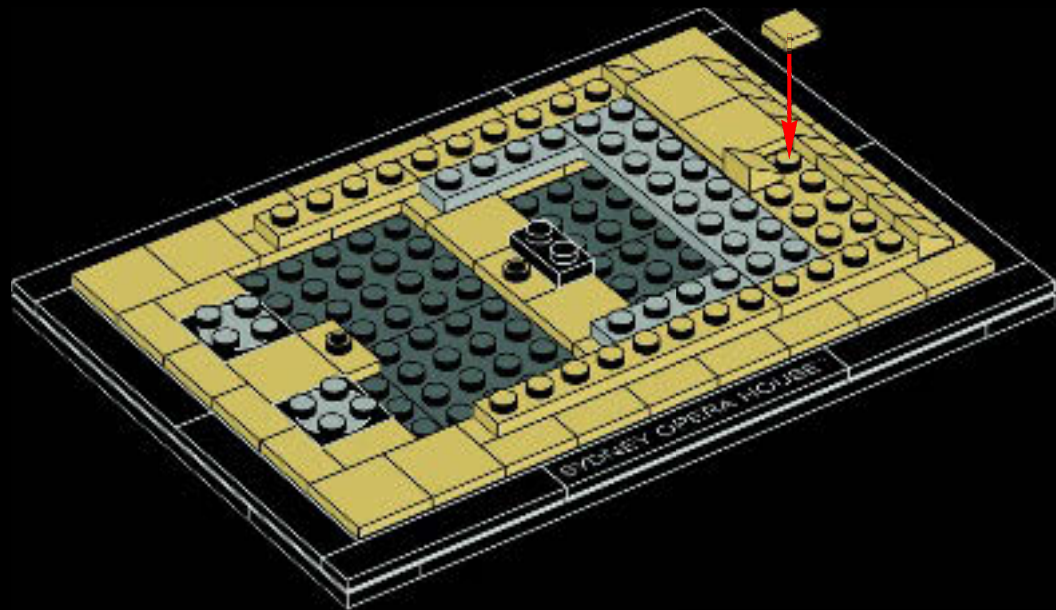



1x



2x

22

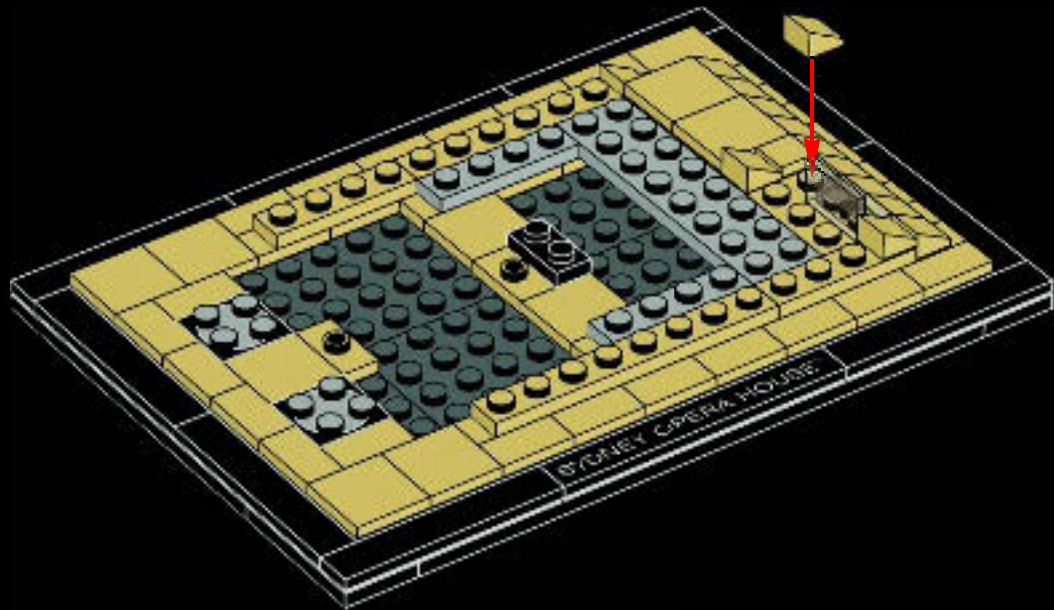



1x



2x

23

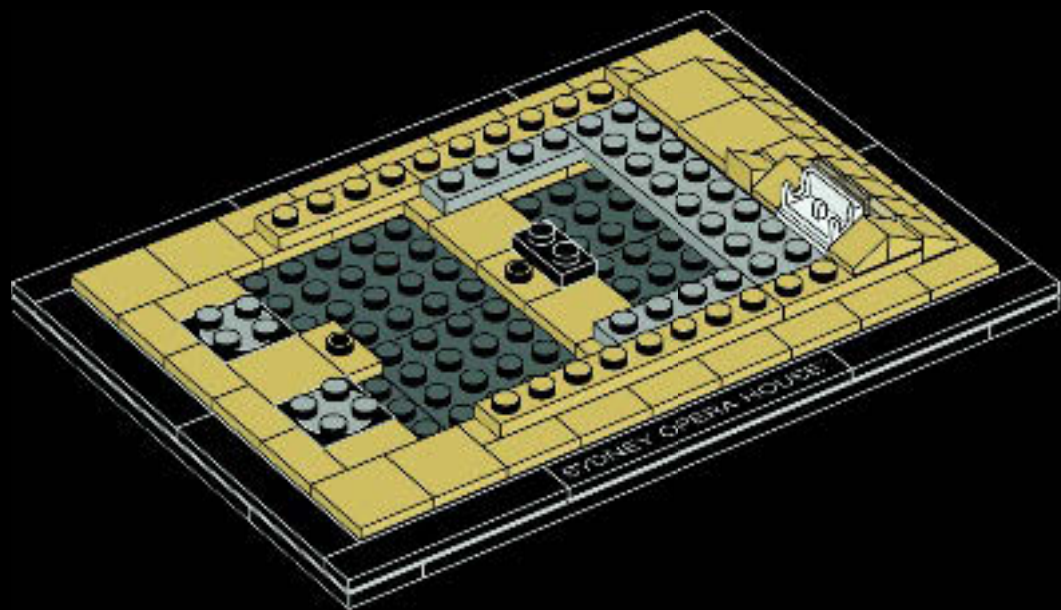



1x



2x



3x

24

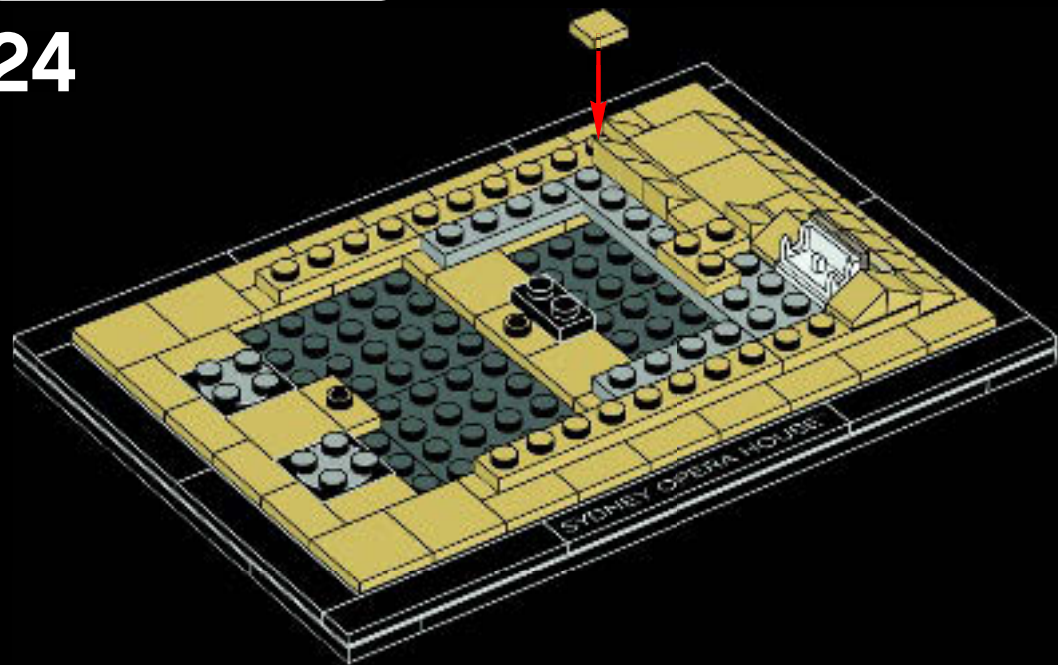



2x



1x

25

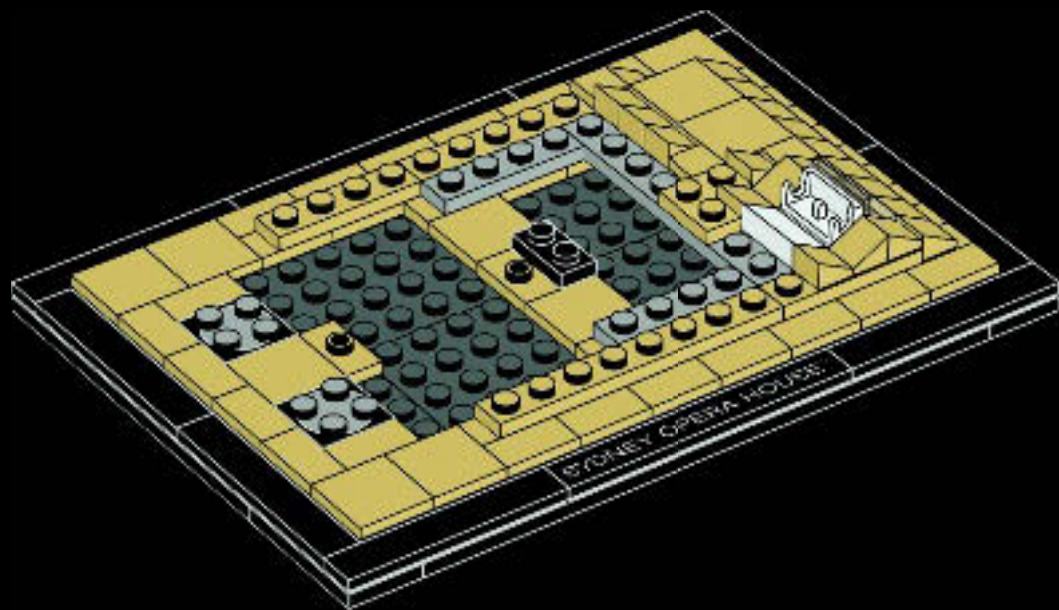



26

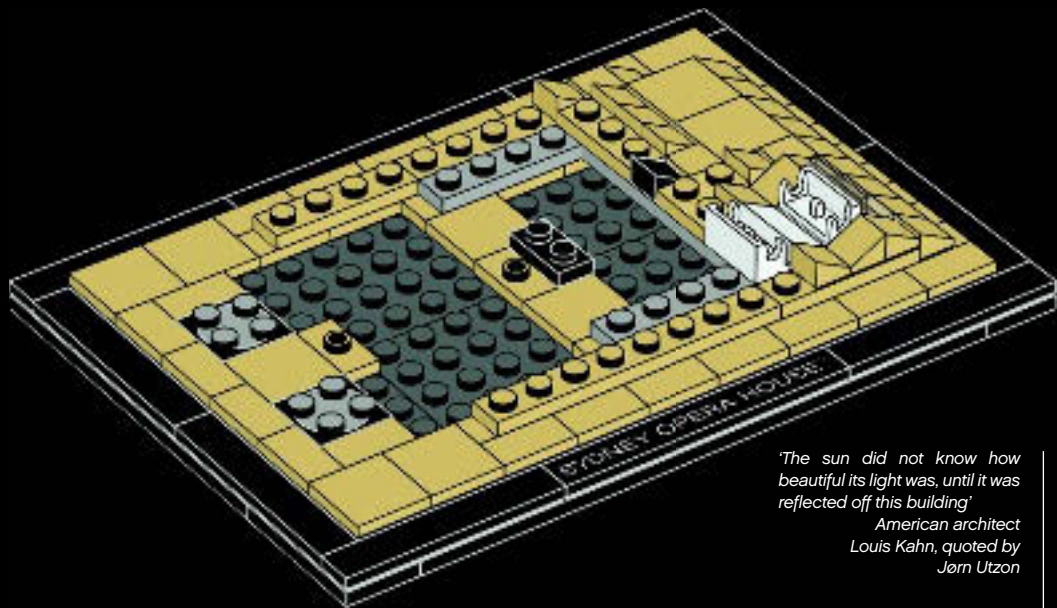

'The sun did not know how beautiful its light was, until it was reflected off this building'

American architect
Louis Kahn, quoted by
Jørn Utzon



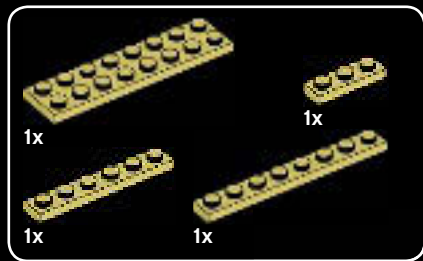

27

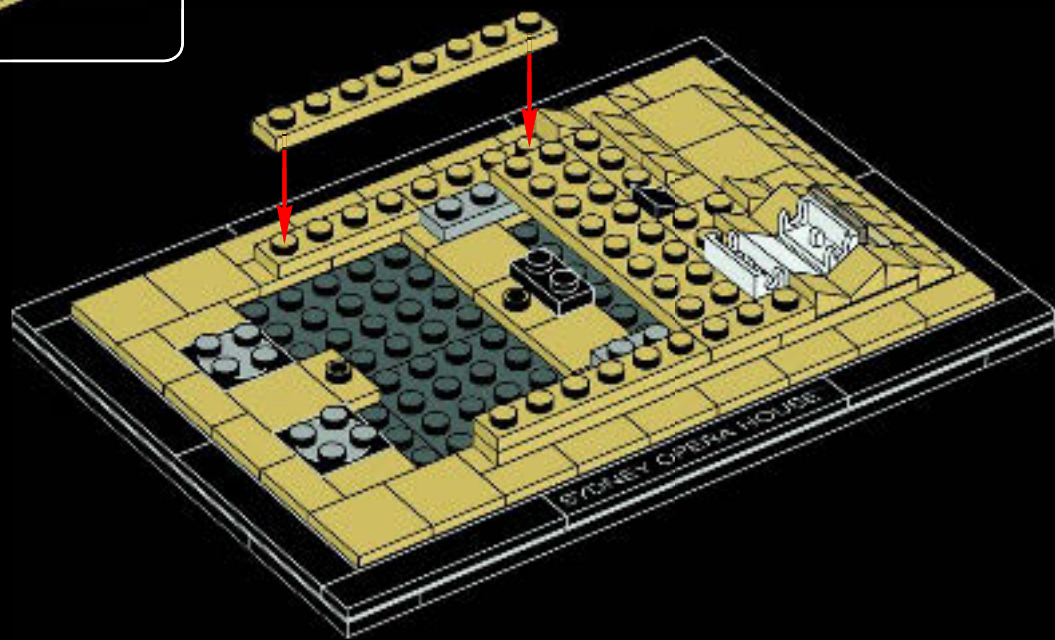



2x



1x

28

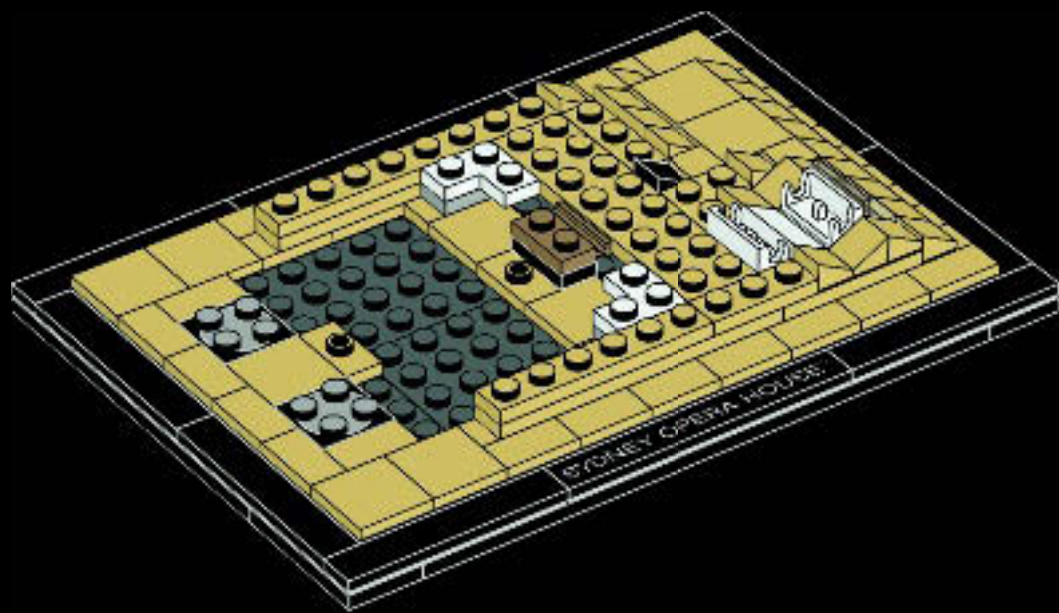

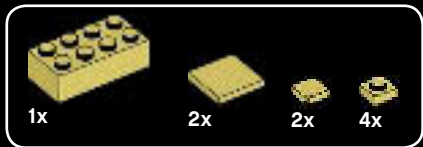

29

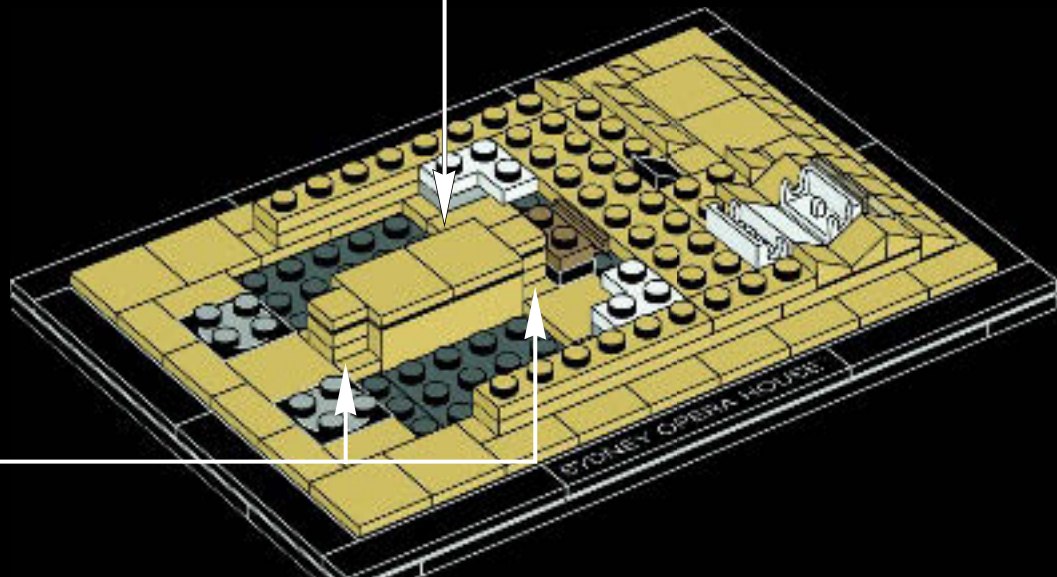
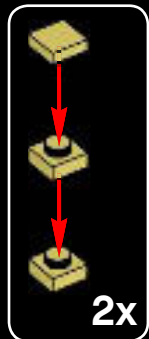
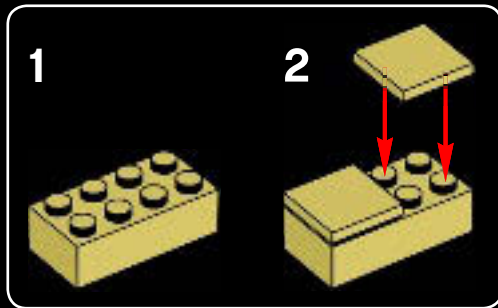



1x



4x

30

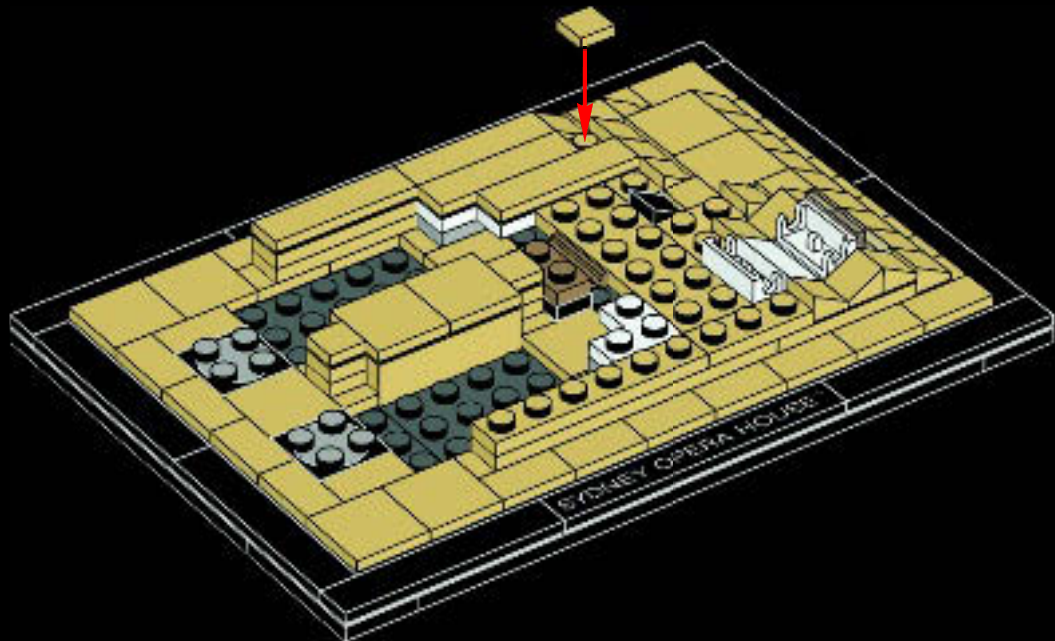



2x



1x



2x

31

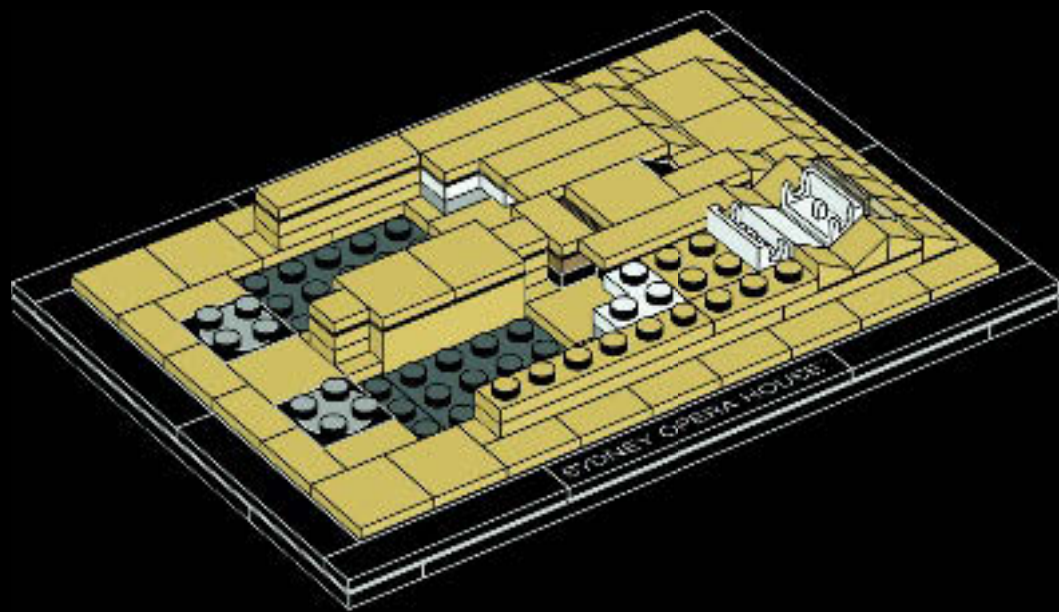



32

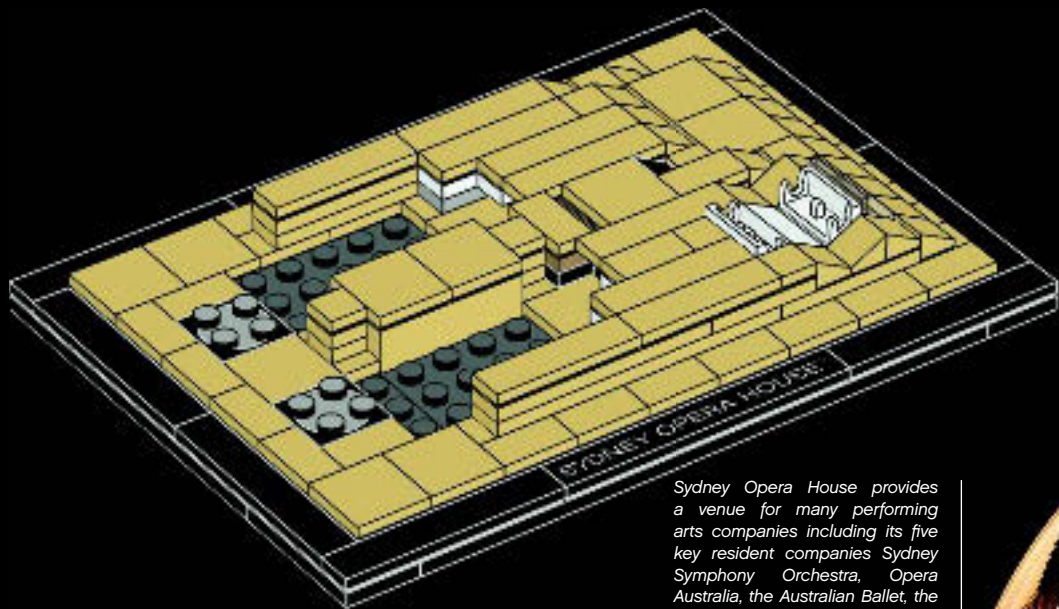

Sydney Opera House provides a venue for many performing arts companies including its five key resident companies Sydney Symphony Orchestra, Opera Australia, the Australian Ballet, the Sydney Theatre Company and Bell Shakespeare Company.



© Michael Moy, Idea to Icon



1x



1x

33

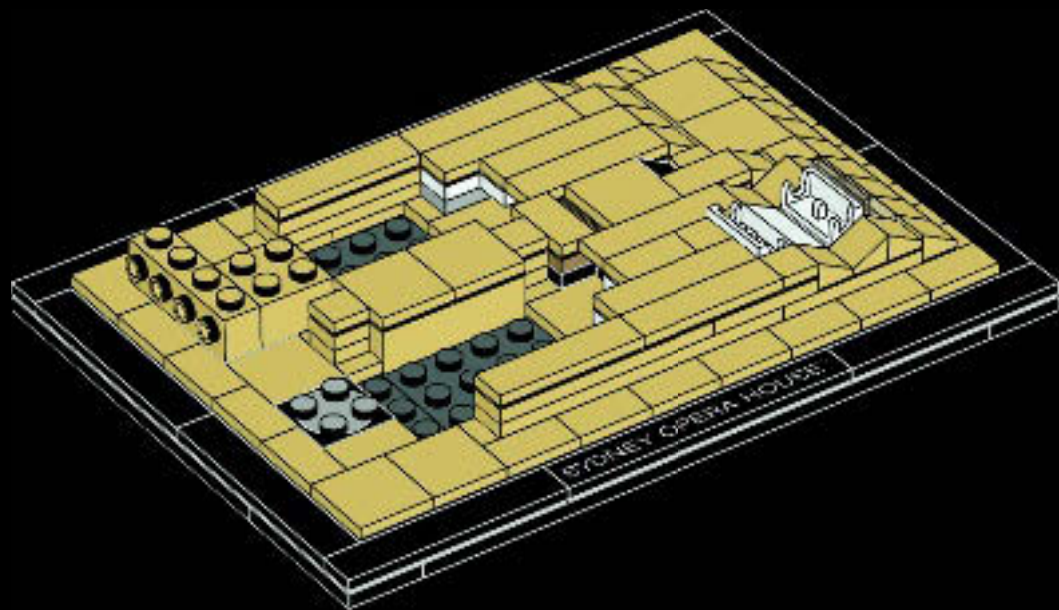

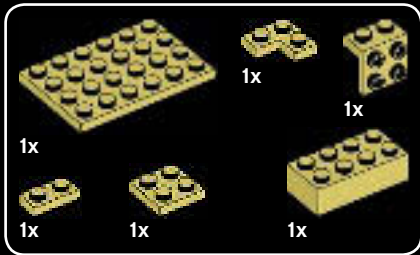
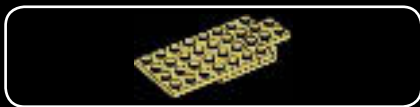

34

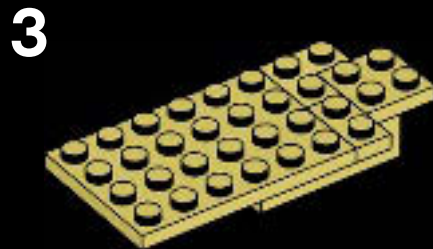
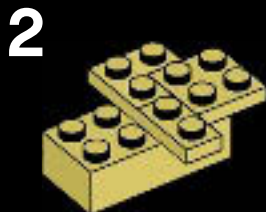
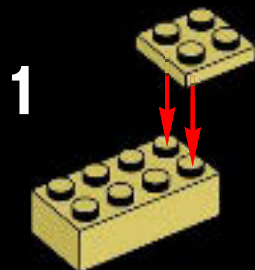



4

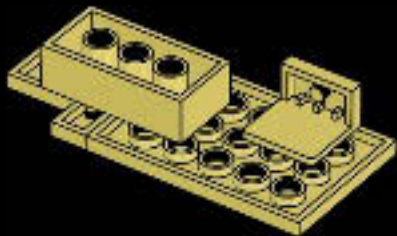

5



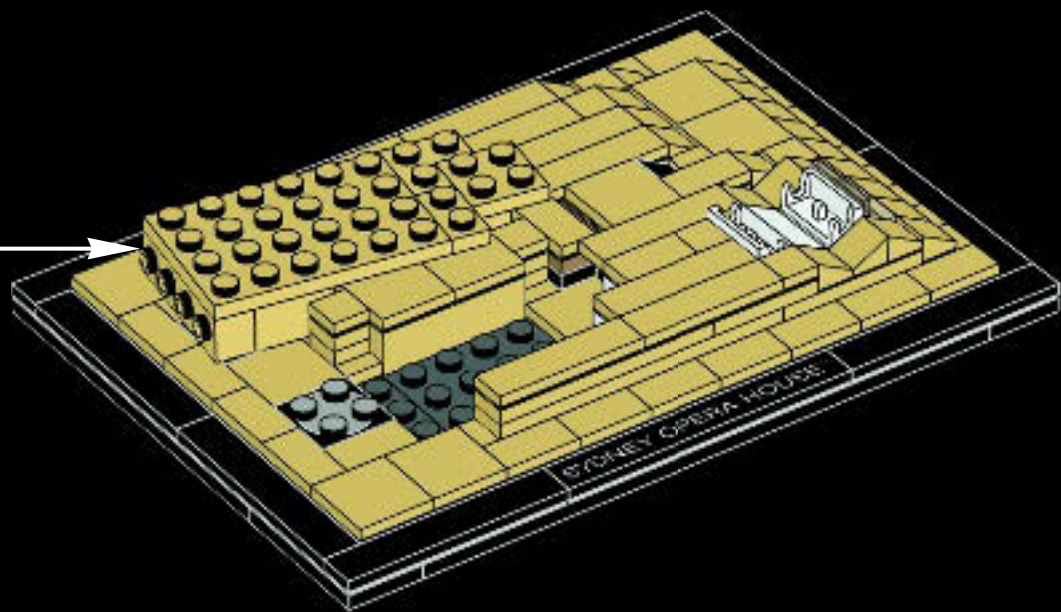



1x



1x



1x

35

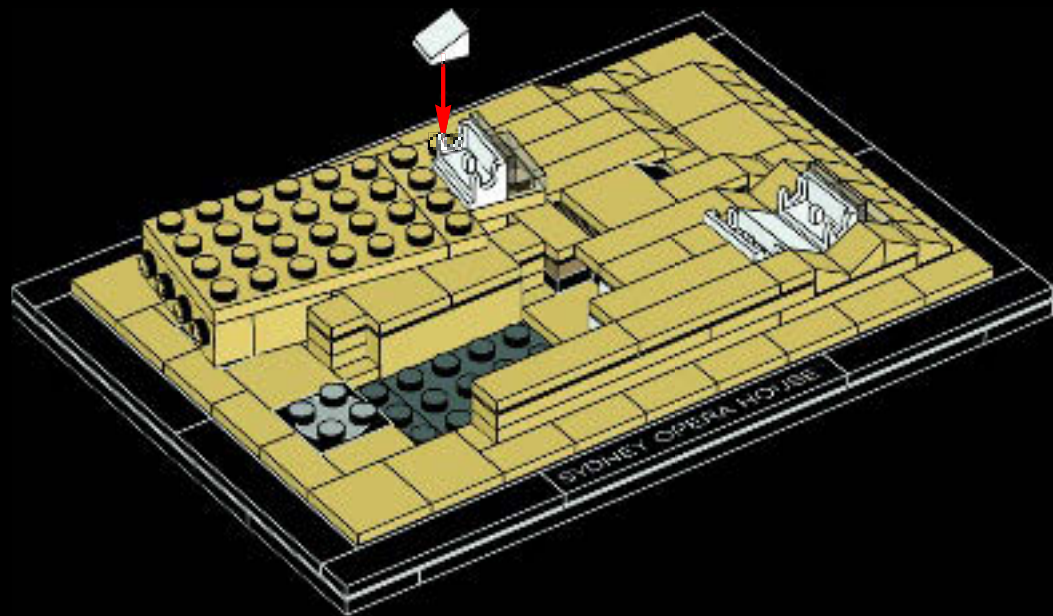



2x



2x

36

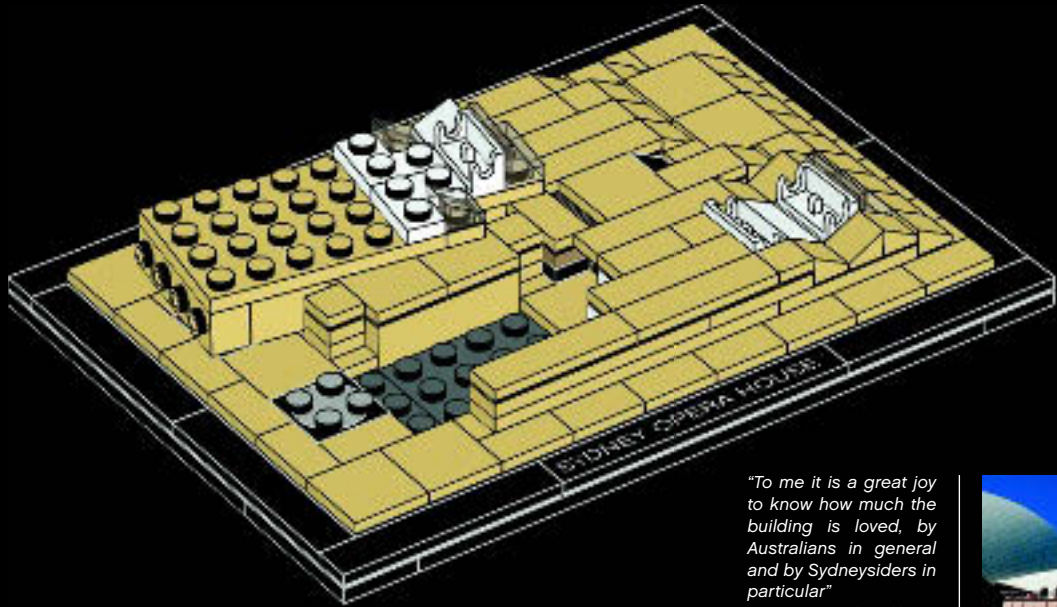

"To me it is a great joy to know how much the building is loved, by Australians in general and by Sydneysiders in particular"

Jørn Utzon



© Michael Moy, Idea to Icon



1x



2x

37

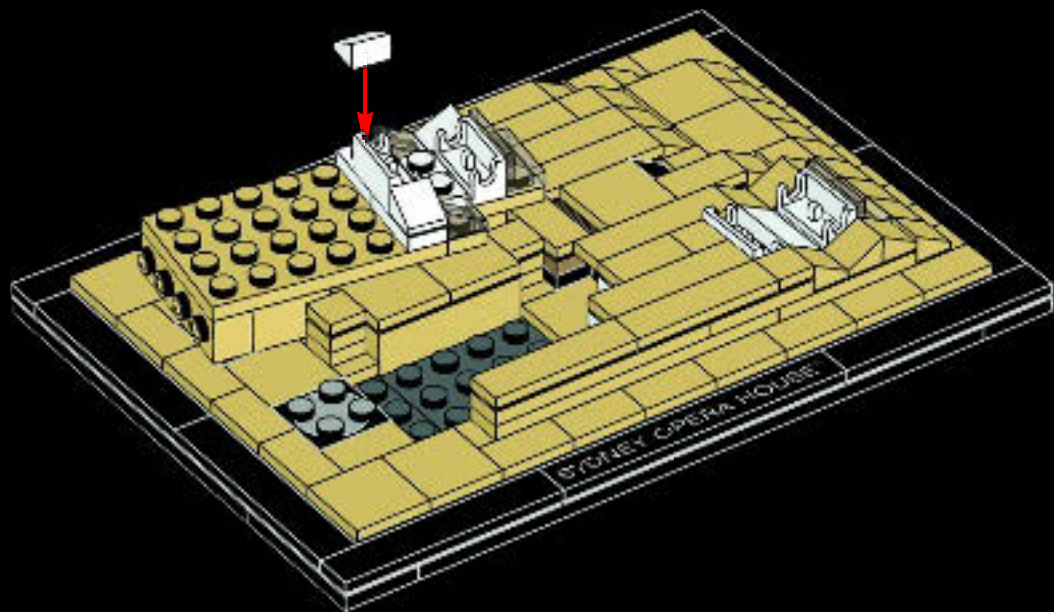



1x



2x



2x

38

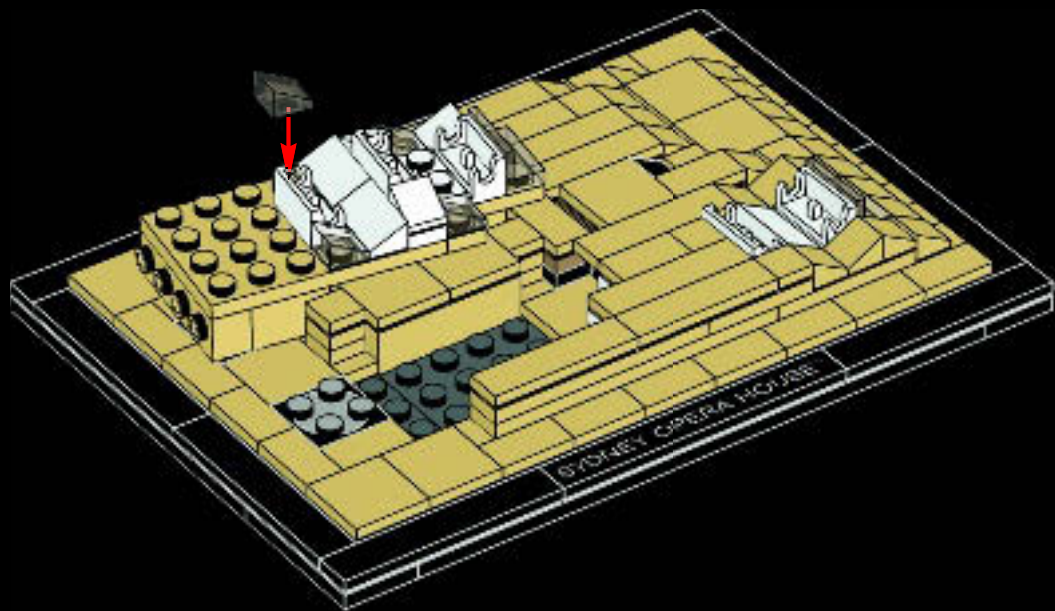



1x



2x



2x

39

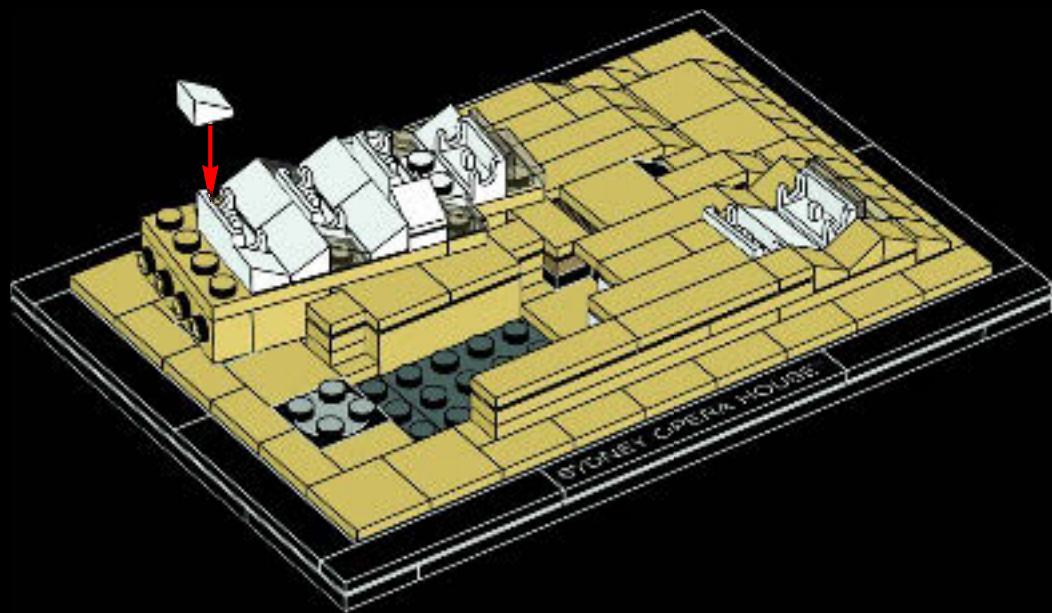

2x

1x

40

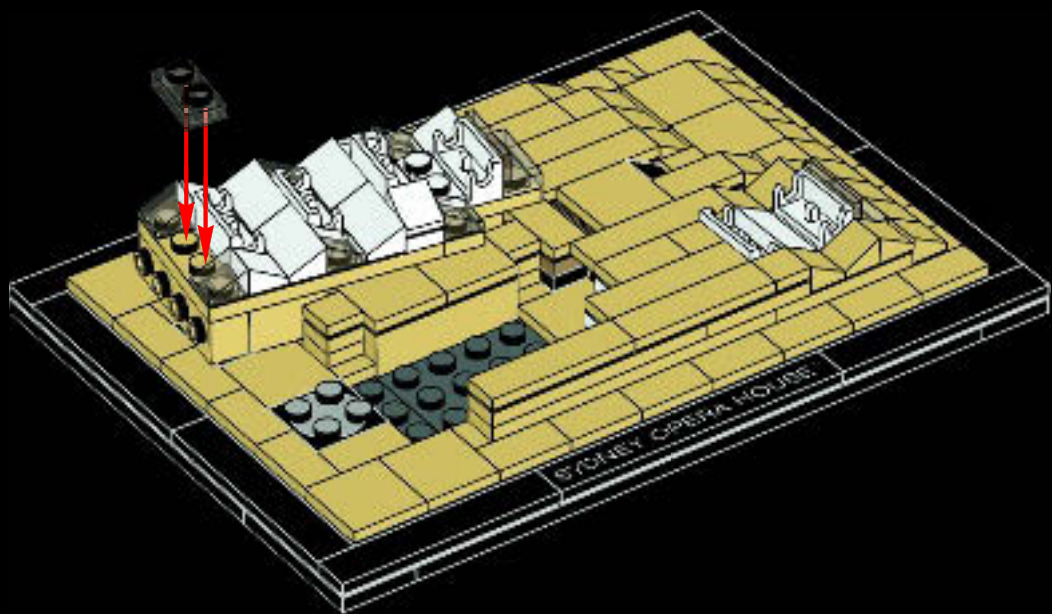



1x



2x



1x

41

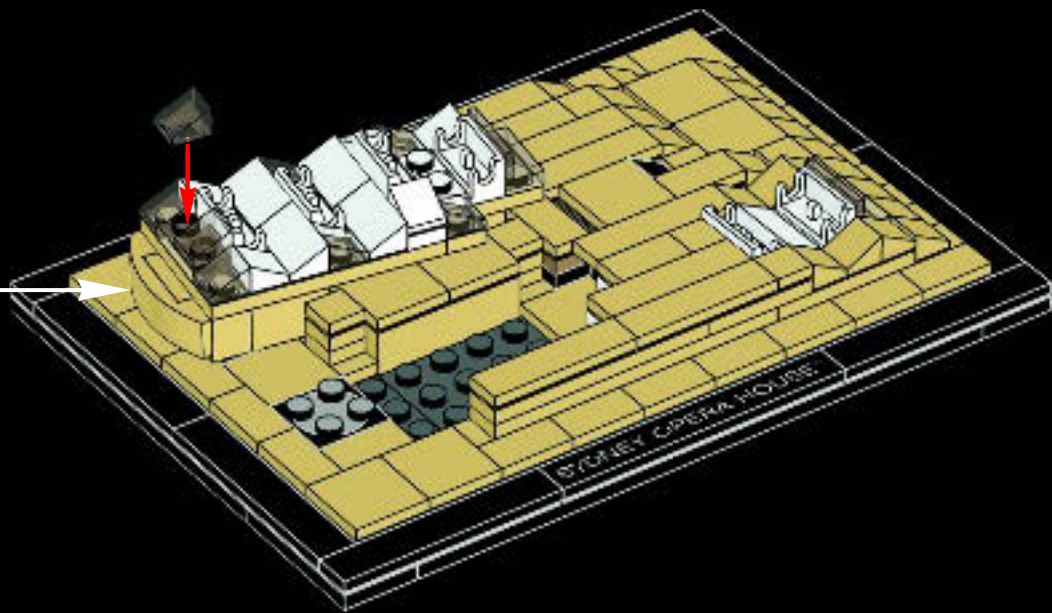
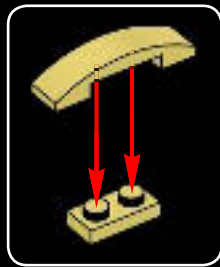



1x



1x

42

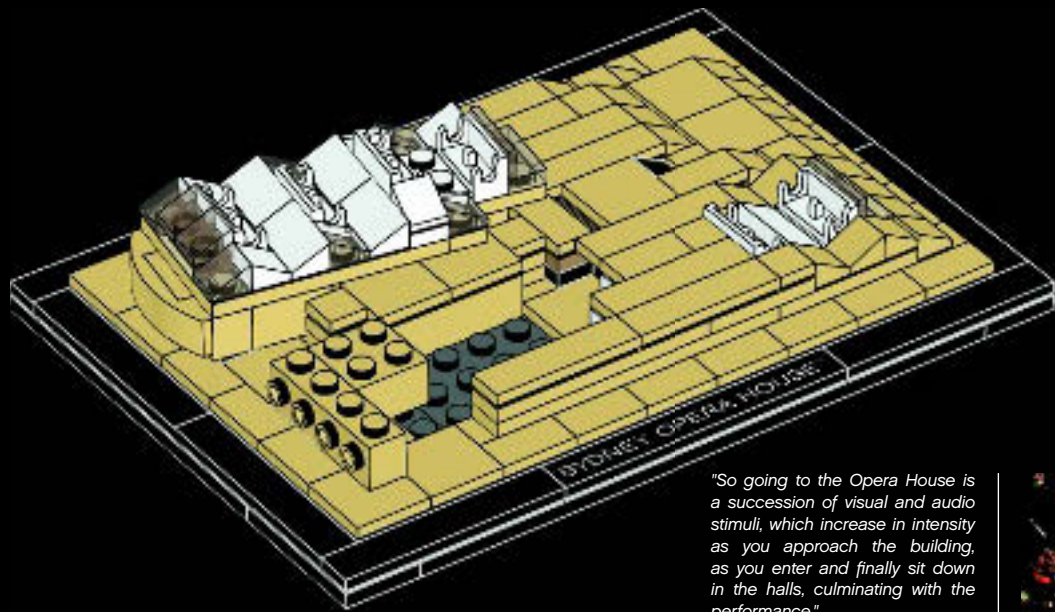

"So going to the Opera House is a succession of visual and audio stimuli, which increase in intensity as you approach the building, as you enter and finally sit down in the halls, culminating with the performance."

Jørn Utzon



© Michael Moy, Idea to Icon

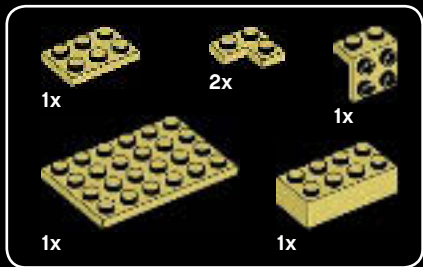

43

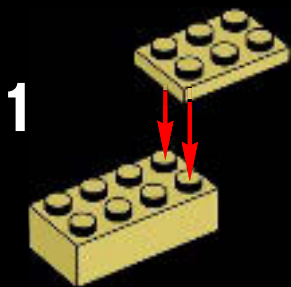

4

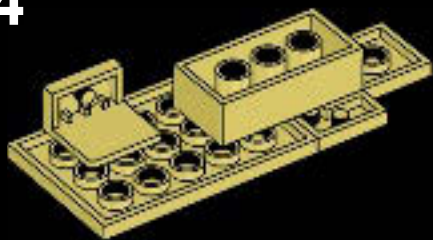

5

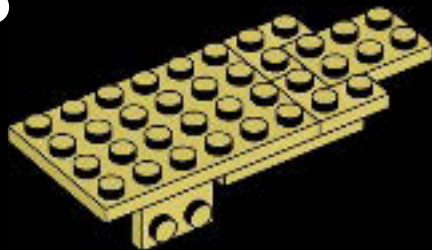

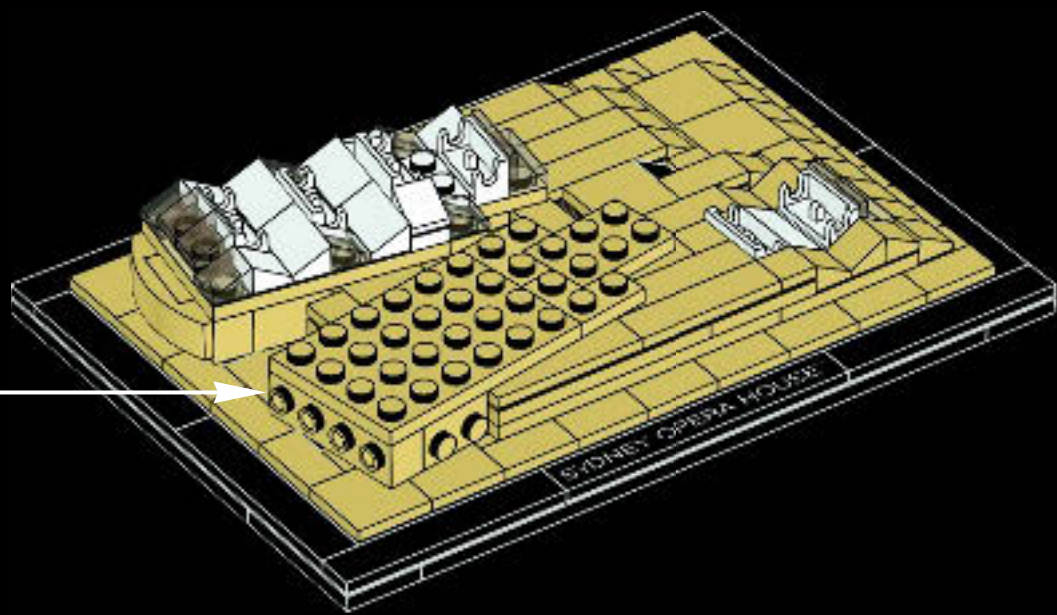



1x



1x

44

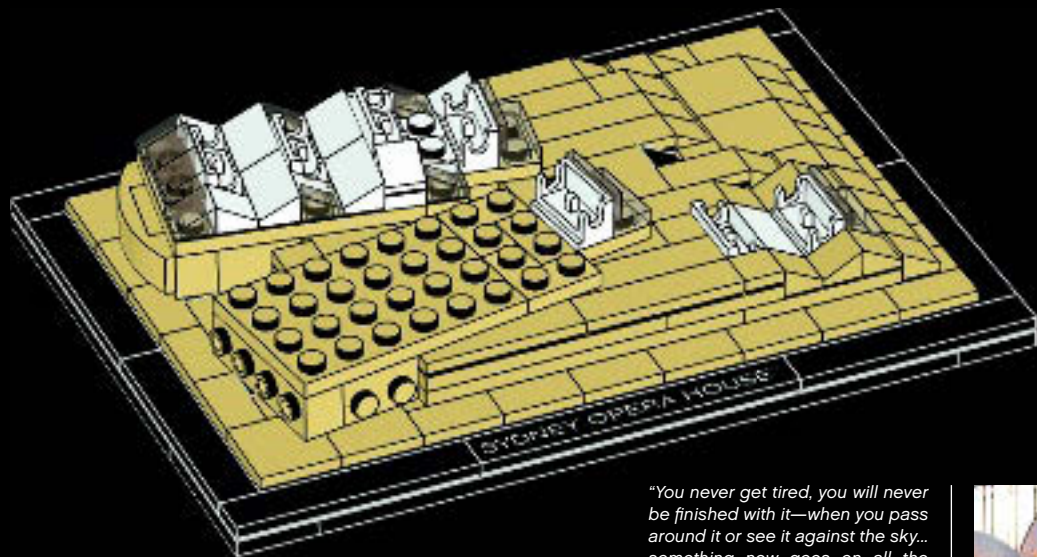

"You never get tired, you will never be finished with it—when you pass around it or see it against the sky... something new goes on all the time... together with the sun, the light and the clouds, it makes a living thing."

Jørn Utzon



© Michael Moy, Idea to Icon



4x



1x

45

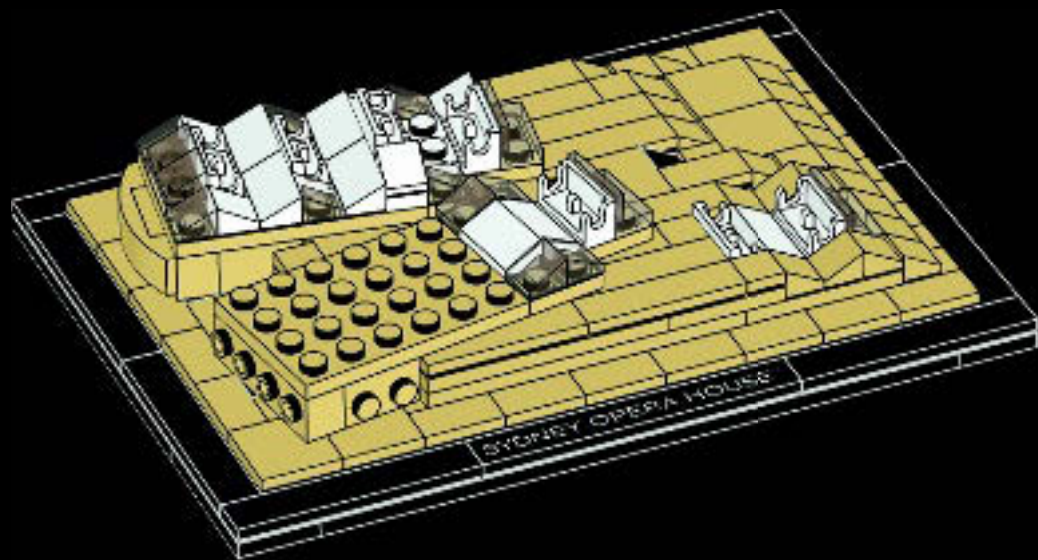



2x



2x



1x

46

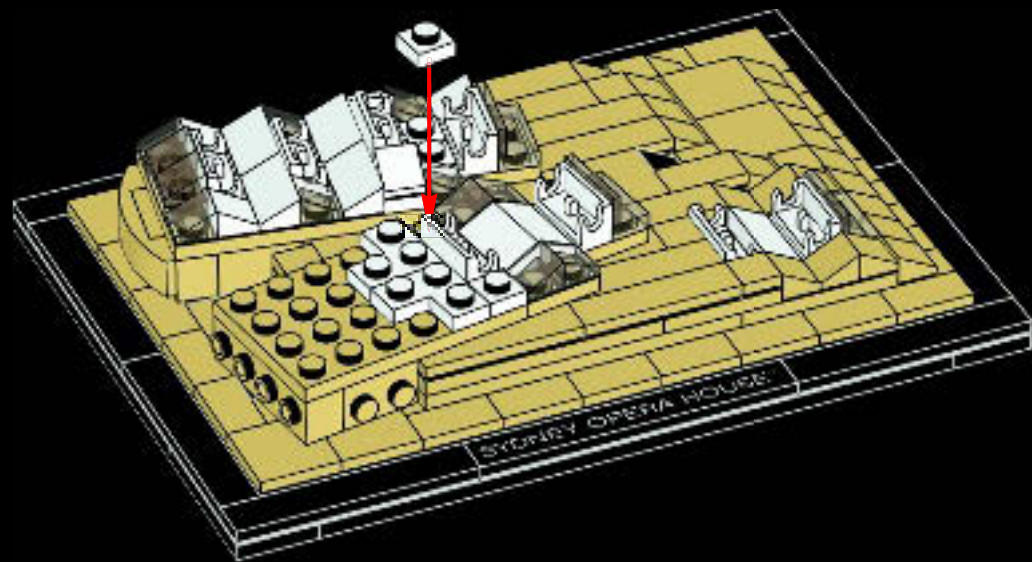



2x



2x

47

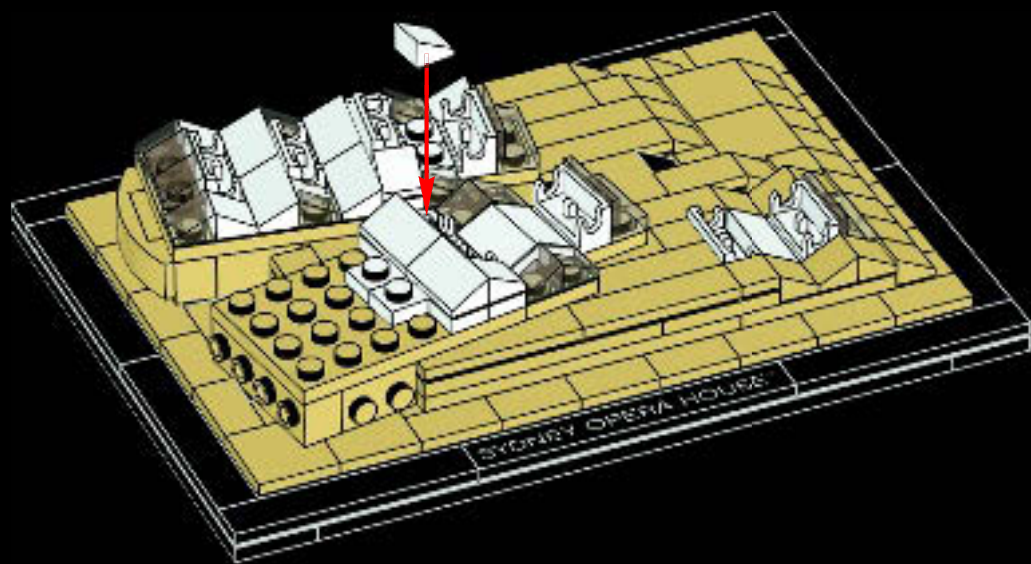



1x



2x



2x

48

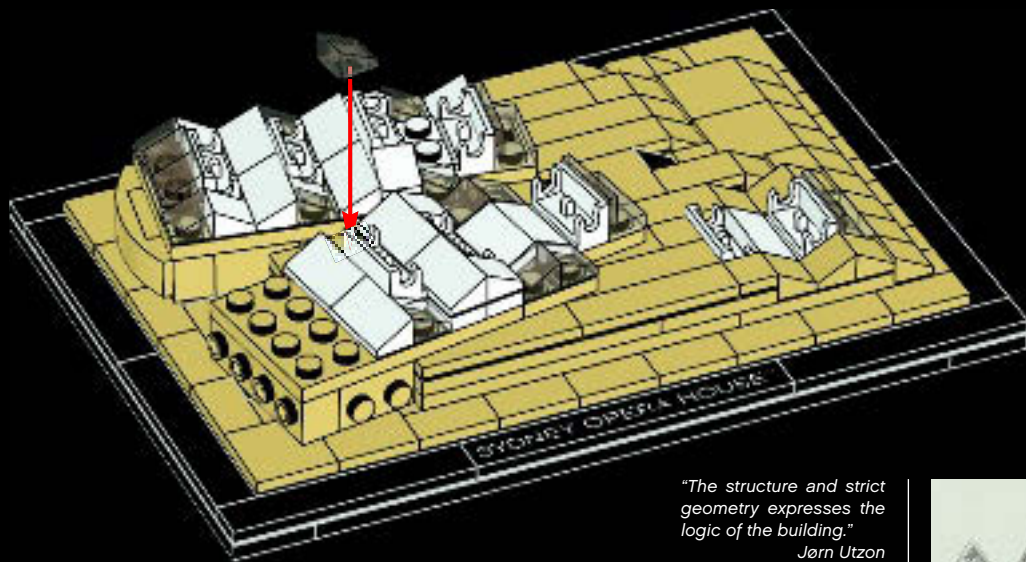

*"The structure and strict geometry expresses the logic of the building."
Jørn Utzon*



© State Records NSW



1x



2x



2x



1x

49

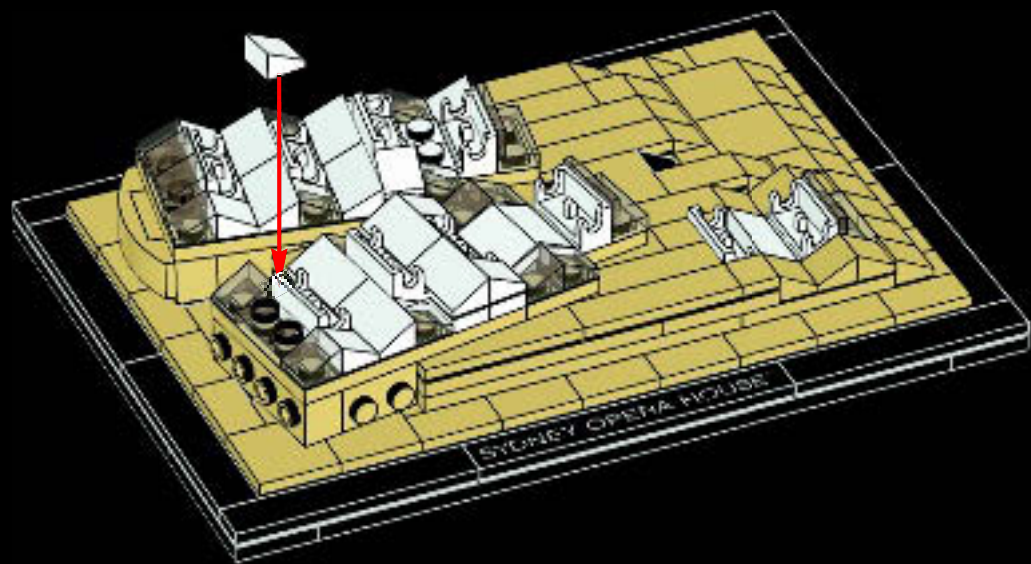



50

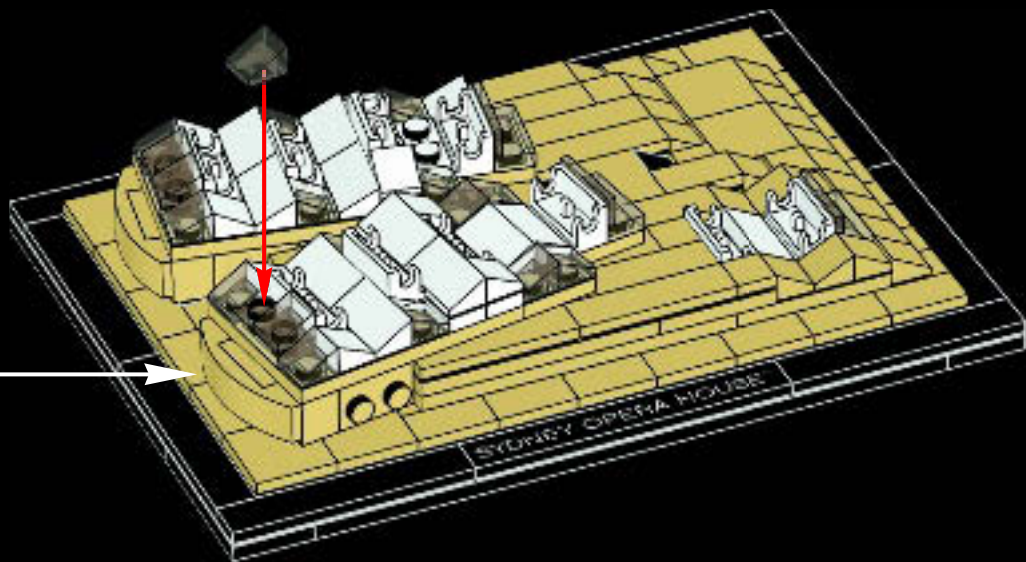
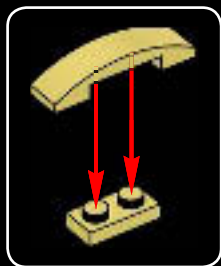



2x



2x

51

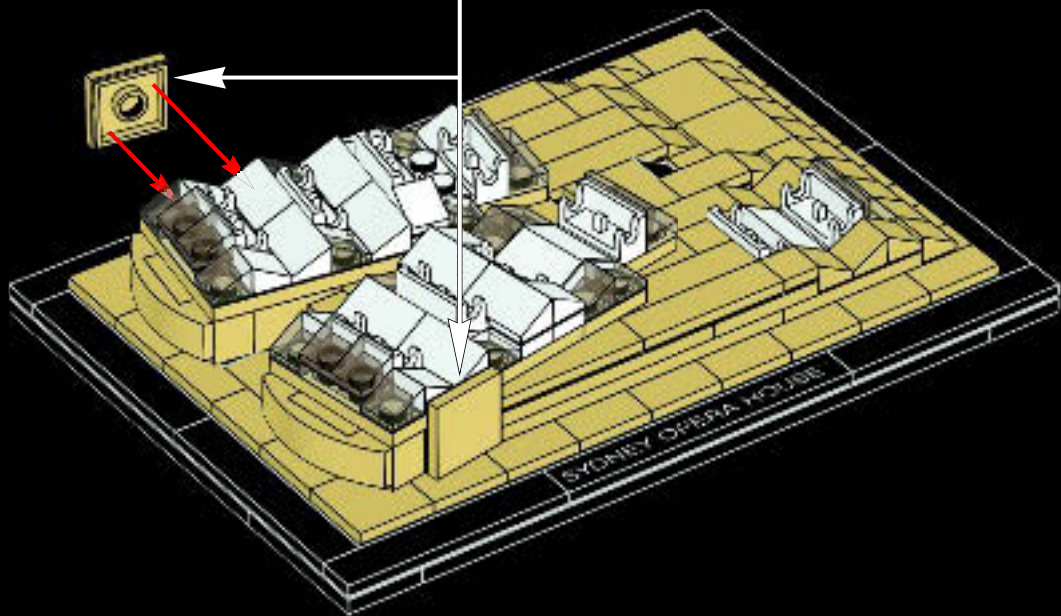



52

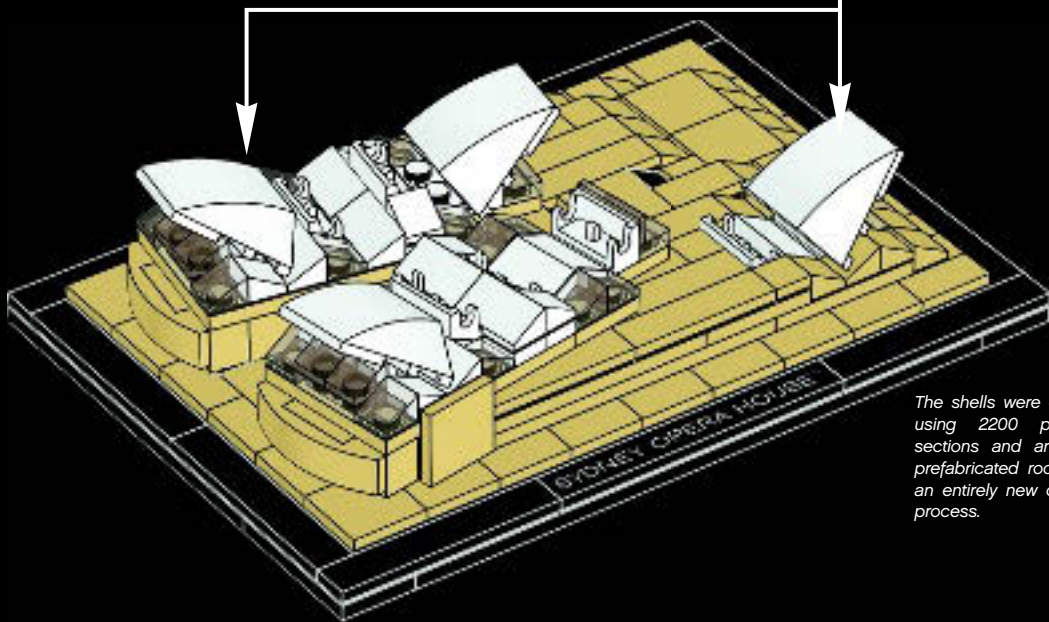
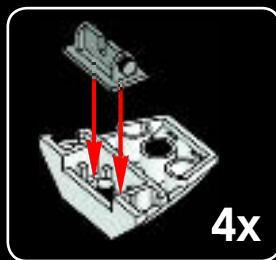

The shells were constructed using 2200 precast rib sections and around 4000 prefabricated roof panels in an entirely new construction process.



© Michael Moy, Idea to Icon



53

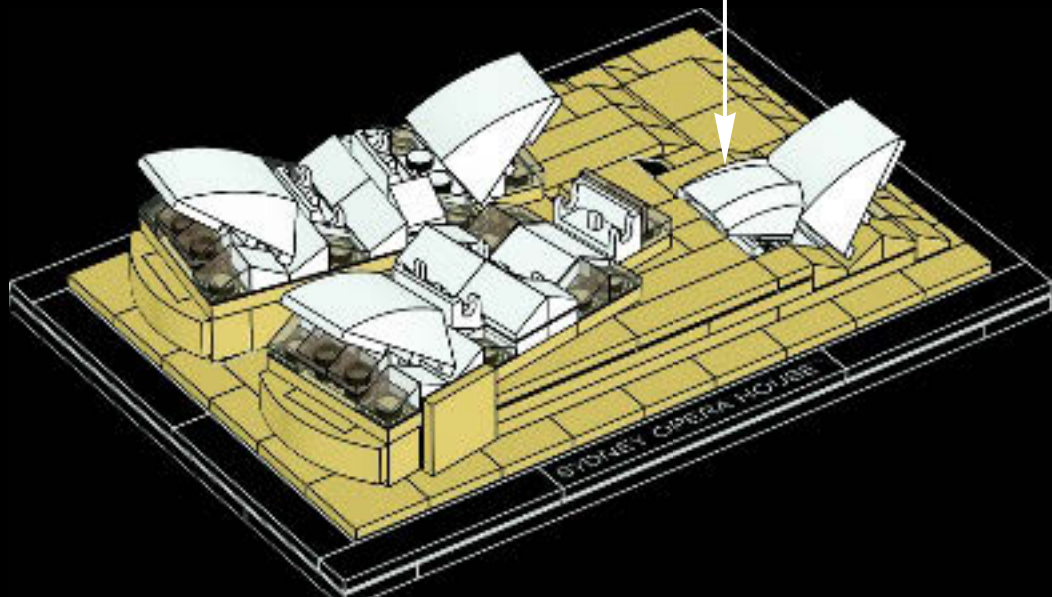
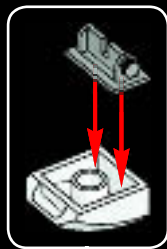



54

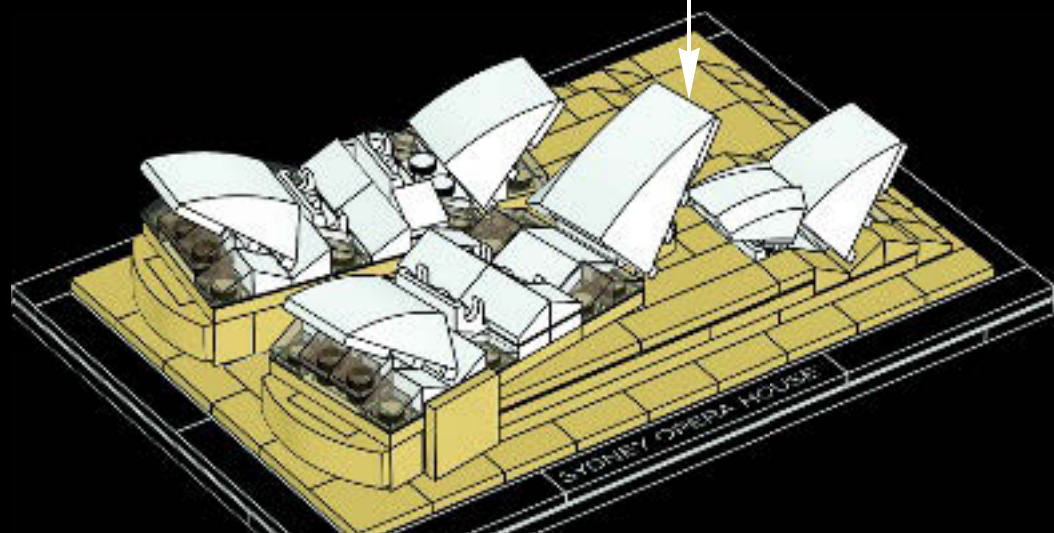
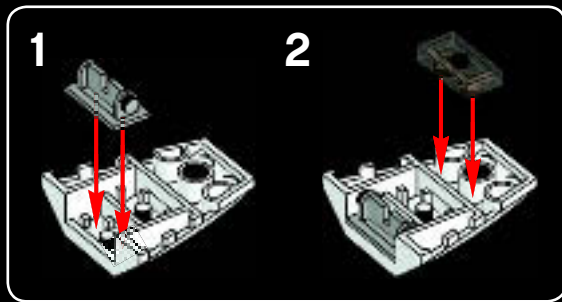

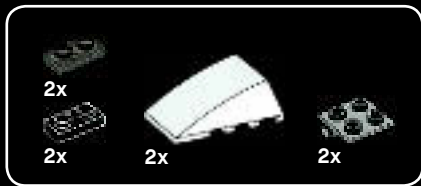

55

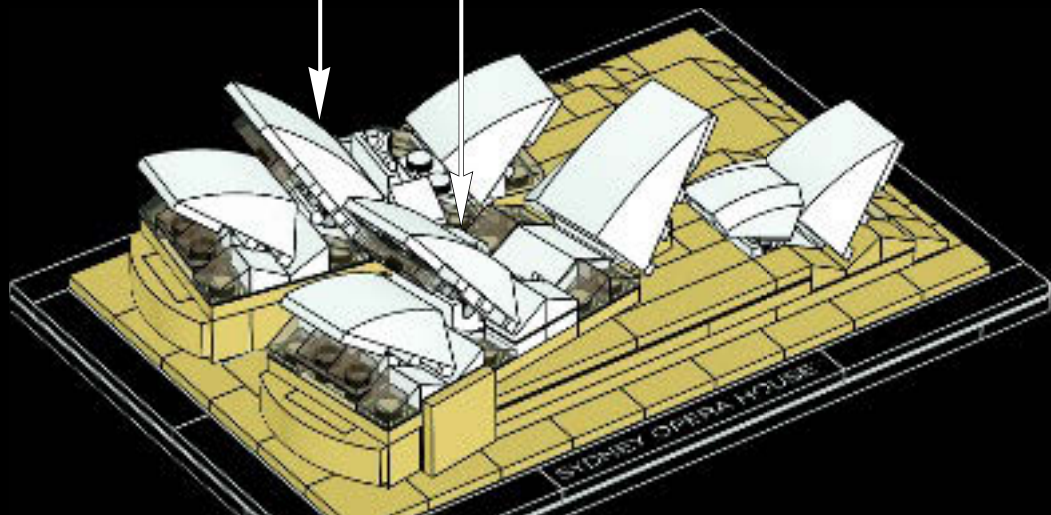
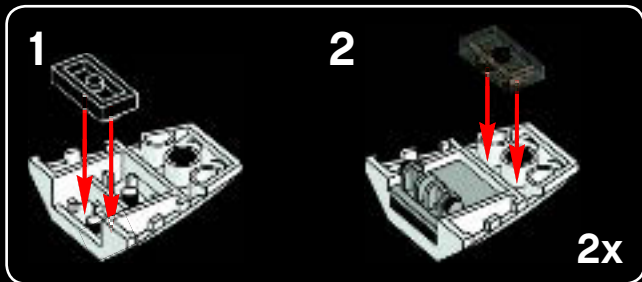



56

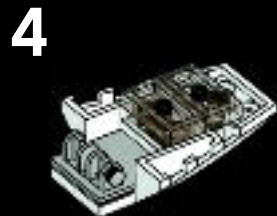
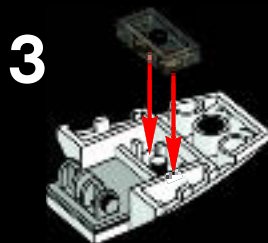
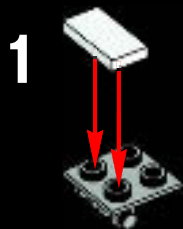

"and in the roofs, the large amount of white tiles subdivided into segments are like the structure of a leaf which, with its ribs and infill have an organic beauty of its own"

Jørn Utzon



© Michael Moy, Idea to Icon

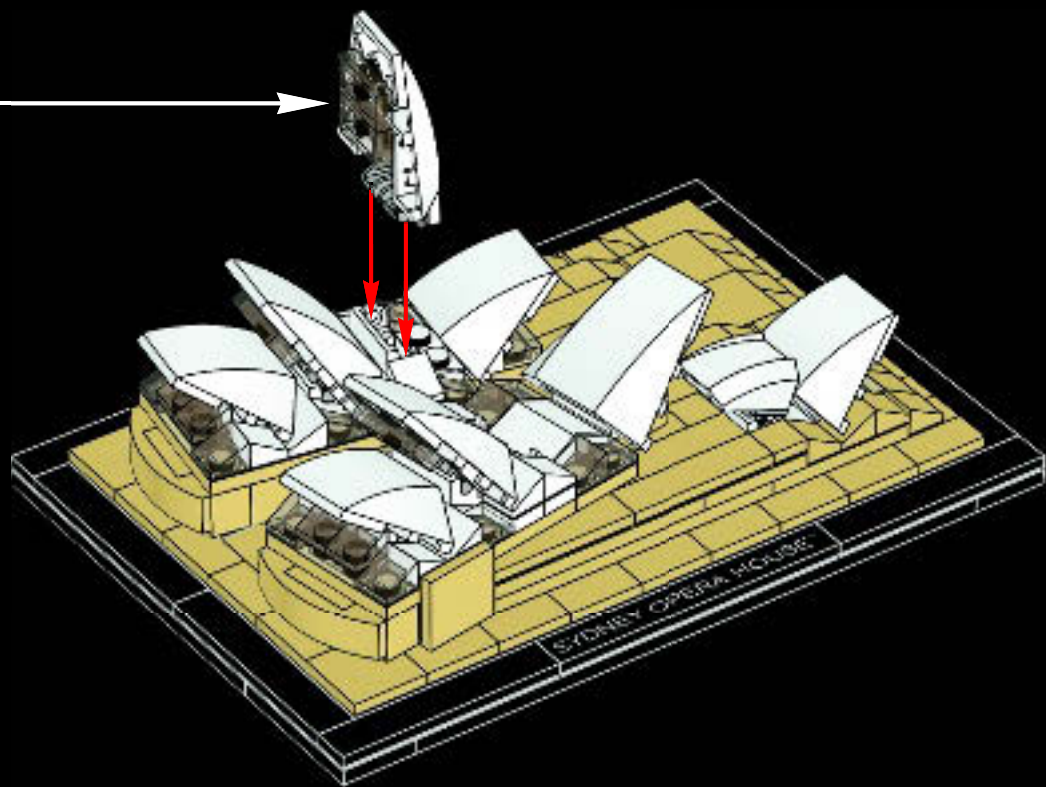

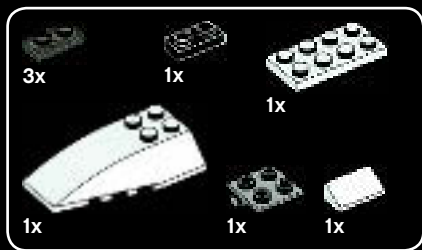



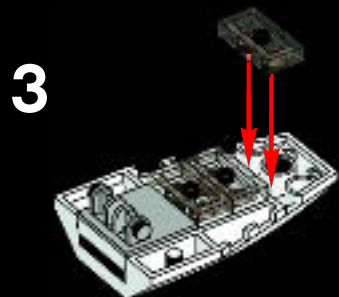
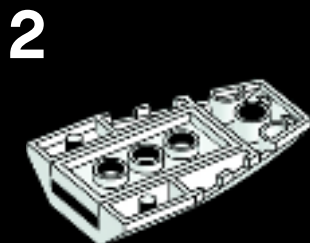
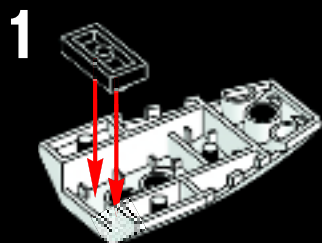



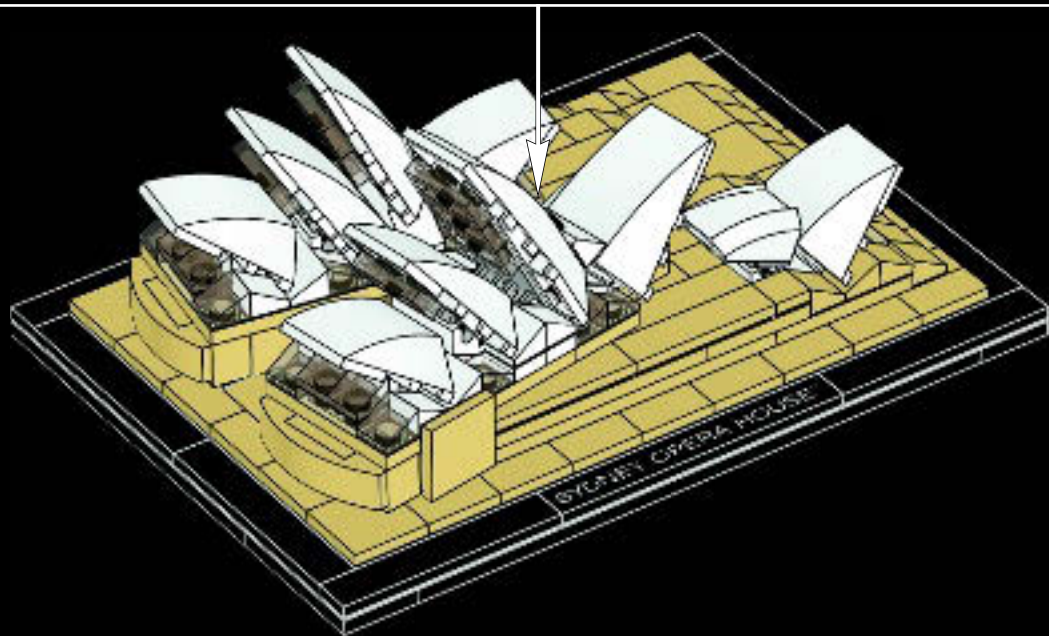











57

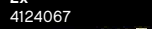

4

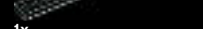

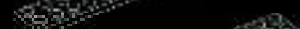
 9x 4504369	 1x 302001	 4x 4114077	 8x 4125253	 1x 4504382	 1x 4616711
 10x 4547489	 1x 306901	 1x 4114084	 4x 4159553	 4x 302326	 2x 4540203
 1x 4578606	 1x 4195869	 2x 4121921	 3x 4113917	 2x 368026	 6x 4211470
 4x 4567878	 10x 393701	 1x 4118790	 22x 4114026	 2x 302026	 4x 4211881
 4x 6002767	 2x 4114306	 2x 4113233	 2x 4278046	 8x 663626	 2x 4211445
 1x 4179869	 3x 4114319	 2x 4124067	 16x 4185177	 1x 416226	 1x 4211406
 2x 302401	 2x 4201062	 2x 4114324	 9x 4550324	 1x 6001533	 2x 4211115
 1x 302301	 21x 4516055	 2x 4114001	 18x 4244368	 2x 383226	 2x 4210720
 6x 242001	 2x 4666611	 2x 4113988	 11x 6001197	 3x 428226	
			 3x 4200798		

A Word from the Artist

As an Architectural Artist my desire is to capture the essence of a particular architectural landmark in its pure sculptural form. I first and foremost do not view my models as literal replicas, but rather my own artistic interpretations through the use of LEGO® bricks as a medium. The LEGO brick is not initially thought of as a material typically used in creating art or used as an artist's medium. However, I quickly discovered the LEGO brick was lending itself as naturally to my applications as paint to a painter or metal to a blacksmith. As I explore how to capture these buildings with the basic shapes of the bricks and plates, I find the possibilities and challenges they offer almost magical.

Sydney Opera House

The powerful form this iconic structure possesses creates unique and difficult challenges. With this being the 13th LEGO Architecture model I have designed in the series one would think that most every type of design situation would have been uncovered. Obviously not so since this structure's fluid form is truly one-of-a-kind. In previous models I was

equally concerned with the form, proportions, scale, color, texture, site transitions and overall composition. However, with this challenge I was solely concerned with those peaks, everything else could be a bit off here and there, but get those peaks wrong and the entire essence of the poetic form is compromised. Believe it or not the idea for capturing the form came to me while building a model of Buzz Lightyear™. His boots used these specialized curved elements which just happened to be white, requiring even less imagination to see these replicating those very identifiable peaks. A few hinges later, some creative staggering here & there and soon the model just built itself. This is a valuable example of how sometimes relying less on your pure imagination and utilizing something to generate inspiration instead can be just as successful.



— Adam Reed Tucker



The 'Scale Model' line – LEGO Architecture in the 1960s

The history of the current LEGO Architecture series can be traced back to the beginning of the 1960s when the LEGO brick's popularity was still steadily increasing. Godtfred Kirk Christiansen, the then owner of the company, began looking for ways to further expand the LEGO system, and asked his designers to come up with a set of new components that would add a new dimension to LEGO building.

Their answer was as simple as it was revolutionary: five elements that matched the existing bricks, but were only one third the height. These new building 'plates' made it possible to construct more detailed models than before.

This greater LEGO flexibility seemed to match the spirit of the age; where modernist architects were redefining how houses looked, and people were taking an active interest in the design of their dream home. It was from these trends that the LEGO 'Scale Model' line was born in early 1962.

The name itself was a direct link to the way architects and engineers worked, and it was hoped that they and others would build their projects 'to scale' in LEGO elements. As with LEGO Architecture today, the original sets were designed to be different from the normal brightly coloured LEGO boxes, and also included 'An Architectural Book' for inspiration.

Though the five elements remain an integral part of the LEGO building system today, the 'Scale Model' line was phased out in 1965 – it would be over 40 years before its principles would be revived in the LEGO Architecture series we know today.



Architecture series

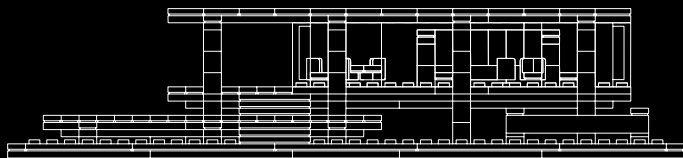
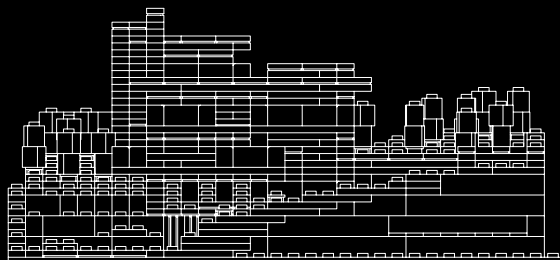
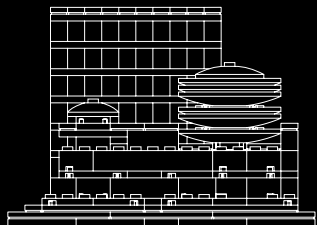

Landmark series

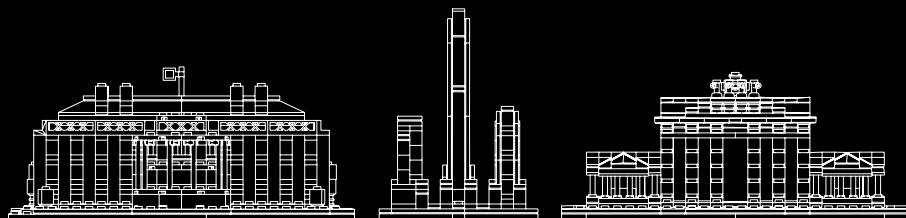

References

Text credits:

SYDNEY OPERA HOUSE™

Photo credits:

SYDNEY OPERA HOUSE™

Michael Moy

State Records NSW

Max Dupain and Associates

Ralph Alfonso

Customer Service
Kundenservice
Service Consommateurs
Servicio Al Consumidor
www.lego.com/service or dial



00800 5346 5555 :



1-800-422-5346 :





Architecture

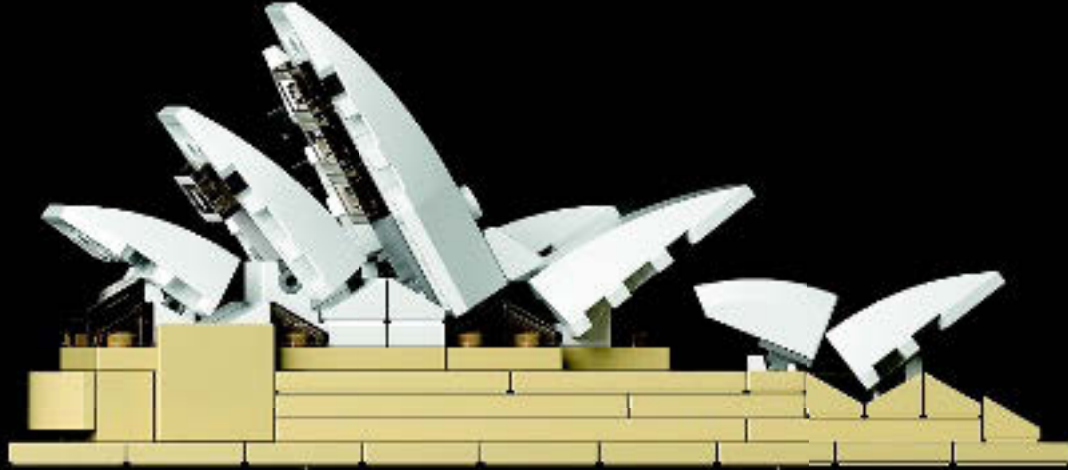

LEGO and the LEGO logo are trademarks of the/sont des marques de commerce de/
son marcas registradas de LEGO Group. ©2012 The LEGO Group. 6005713



www.LEGO.com