

The LEGO logo is displayed in its characteristic yellow font with a black outline, set against a red square background.

Architecture

The Leaning Tower of Pisa

Torre pendente di Pisa

Pisa, Italy

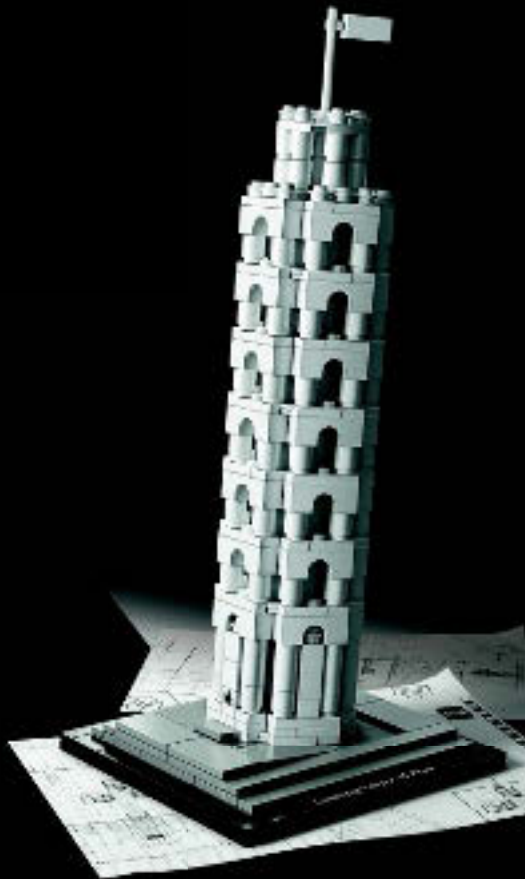

 Booklet available in English on

 Livret disponible en français sur

 Folleto disponible en español en [LEGO.com/Architecture](https://www.lego.com/Architecture)

The Leaning Tower of Pisa

The Leaning Tower of Pisa (Torre pendente di Pisa) took almost 200 years to complete and has stood beside the Cathedral of Pisa for over 600 years. Thanks to its famous tilt, it has become one of the world's most recognizable architectural landmarks. The story behind the bell tower spans over 800 years of European history and provides a fascinating glimpse into a miracle of medieval engineering.

La tour penchée de Pise

La construction de la tour penchée de Pise (Torre pendente di Pisa) dura presque 200 ans, et elle se tient à côté de la Cathédrale de Pise depuis plus de 600 ans. Grâce à sa célèbre inclinaison, elle est devenue l'un des monuments architecturaux les plus célèbres du monde. L'histoire de ce clocher couvre plus de 800 ans d'histoire européenne et offre un regard fascinant sur un miracle d'ingénierie médiévale.



History

The story of the tower of Pisa begins in January 1172 when the widow Berta of Bernado left 60 soldi (gold coins) in her will to purchase stones for the construction of a bell tower. A year later, in August 1173, the first foundations for the tower were laid in the ground behind the existing Pisa Cathedral.

At that time, Pisa was a rich, independent trading port and it was hoped that the new tower would become a symbol of a city at the height of its cultural and economic power. Therefore the circular, freestanding tower was designed to be one of the tallest in Europe and included finely elaborately carved columns and intricate bas-reliefs.

Within five years, and with only two floors completed, the builders faced a serious obstacle – a combination of shallow foundations and soft, unstable subsoil was causing the tower to lean. Construction was stopped, and with Pisa's prosperity and power on the decline, a hundred years would pass before building was resumed. Four more floors were added in 1272, the seventh floor in 1319 and the bell-chamber in 1372. On completion, the tower would stand 185 ft. (56.4 m) tall and consist of eight stories, including the bell-chamber. A total of seven bells, one for each note of the musical scale, were installed – adding even more weight to the already heavy structure. Throughout the construction period, and especially during the last one hundred years, many have tried to solve the tower's overriding structural problem, more often than not, making

the problem worse. It would be 2008 before engineers could confirm that the tower had stopped moving for the first time in its history.

© Shutterstock



Histoire

L'histoire de la tour de Pise commence en janvier 1172 lorsque la veuve Berta de Bernado légua 60 « soldi » (pièces d'or) dans son testament pour la construction d'un clocher. Un an plus tard, en août 1173, les premières bases de la tour furent posées sur le terrain à côté de la Cathédrale de Pise actuelle.

À ce moment, Pise était un riche port de commerce indépendant et espérait que sa nouvelle tour allait devenir le symbole d'une ville à l'apogée de sa puissance culturelle et économique. La tour circulaire autoportante était donc conçue pour être l'une des plus hautes d'Europe et incluait des colonnes savamment sculptées ainsi que des bas-reliefs sophistiqués.

Au bout de cinq ans, et avec seulement deux étages terminés, les constructeurs rencontrèrent un problème grave : la combinaison de bases trop peu profondes et d'un sous-sol mou et instable faisait en sorte que la tour commençait à pencher. Les travaux furent arrêtés et, la prospérité et la puissance de Pise déclinant lentement, cent ans passèrent avant que les travaux ne reprennent. Quatre étages supplémentaires furent ajoutés en 1272, le septième étage en 1319 et la salle des cloches en 1372. Une fois terminée, la tour devait mesurer environ 56,4 m et comprendre huit étages dont la salle des cloches. Un total de sept cloches, une pour chaque note de la gamme musicale, furent installées, augmentant le poids d'une structure déjà lourde. Pendant toute la durée de la construction, et surtout au cours des cent dernières années, beaucoup de gens ont essayé de résoudre le problème structurel de la tour, souvent en l'empirant. Ce n'est qu'en 2008 que les ingénieurs purent déclarer que la tour avait cessé de bouger pour la première fois de son histoire.

Construction

While the Tower of Pisa is most known for “leaning”, it would still be a remarkable architectural structure without this famous feature. Constructed at a time when there was very little building of this kind being carried out in Europe, the intelligent use of columns and arches demonstrates an in-depth understanding of weight and load characteristics that was way ahead of its time.

What the architect overlooked however, was the clay-based soil and the need for a foundation capable of supporting a bell tower that would eventually weigh 16,000 tons (14,500 metric tons).

The eight-story tower was built with limestone and lime mortar, with an exterior covering of marble. Interestingly, the limestone is probably why the tower has not cracked and collapsed – the rock is flexible enough to withstand the pressures placed on it by the tilt. The bottom story of the tower is an arcade of 15 closed marble arches. Each of the following six stories contains 30 arches, while the final story, or bell-chamber, has 16 arches.



© Shutterstock

Construction

Bien que la tour de Pise soit surtout célèbre pour son « inclinaison », elle resterait tout de même un monument architectural remarquable sans cette caractéristique notoire. En effet, elle fut construite à une époque où il y avait très peu de constructions de ce type en Europe. L'utilisation intelligente de colonnes et d'arches montre une compréhension des caractéristiques de poids et de charge très en avance sur son temps.

L'architecte n'a cependant pas tenu compte du sol à base d'argile et des fondations correctes nécessaires pour un clocher qui allait éventuellement peser 14 500 tonnes.

Cette tour de huit étages était construite en pierre calcaire et en mortier de chaux, avec une couverture extérieure en marbre. La pierre calcaire est probablement la raison pour laquelle la tour ne s'est pas cassée et n'est pas tombée, la pierre étant assez souple pour supporter les pressions imposées sur elle par l'inclinaison. L'étage inférieur de la tour est une arcade de 15 arches en marbre fermées. Chacun des six étages suivants contient 30 arches, tandis que le dernier étage, ou salle des cloches, contient 16 arches.



© Gettyimages

Many of the attempts to rectify the tower's leaning are just as interesting as the actual construction itself. After work resumed on the tower in 1272, engineers attempted to compensate for the tilt by building the upper floors with one side taller than the other. However, the weight of the extra floors caused the edifice to sink further and lean more.

In 1934, 362 holes were drilled in the base of the tower and filled with 99 tons (90 metric tons) of cement, with almost disastrous consequences. In the early 1990s, the tower was closed to the public and engineers anchored the tower to the ground using high tensile steel cable in an attempt to stabilize it. After two decades of corrective reconstruction and stabilization efforts, it was announced in 2008 that the tower had been stabilized to such a degree that it had actually stopped moving for the first time in its history. It is now claimed that the tower will remain stable for at least 200 years.

Prior to this final restoration work, the tower leaned at an angle of 5.5 degrees. It now leans at 3.99 degrees. This means that the top of the tower is displaced horizontally by 12 ft. 10 in (3.9 m).



© Gettyimages

Beaucoup de tentatives pour rectifier l'inclinaison de la tour sont tout aussi intéressantes que la construction elle-même. Après la reprise des travaux sur la tour en 1272, les ingénieurs ont essayé de compenser l'inclinaison en construisant les étages supérieurs avec un côté plus haut que l'autre. Cependant, le poids des étages supplémentaires fit que l'édifice s'enfonça davantage et pencha encore plus.

En 1934, 362 trous furent creusés à la base de la tour et remplis de 90 tonnes de ciment avec des conséquences presque désastreuses. Au début des années 1990, la tour fut fermée au public et les ingénieurs ancrèrent la tour au sol avec un câble d'acier à haute résistance pour essayer de la stabiliser. Après deux décennies de reconstruction corrective et d'efforts de stabilisation, il fut annoncé en 2008 que la tour avait été stabilisée et avait cessé de bouger pour la première fois de son histoire. Il est maintenant avancé que la tour restera stable pendant au moins 200 ans.

Avant les derniers travaux de restauration, la tour penchait à un angle de 5,5 degrés. Elle penche maintenant à environ 3,99 degrés. Ceci signifie que le haut de la tour est déplacé horizontalement de 3,9 m par rapport à l'endroit où il serait si la structure était parfaitement verticale.

Today

The Leaning Tower of Pisa remains an iconic architectural landmark and a true feat of medieval engineering. Though more famous for its tilt, the true wonder of the tower is that it still stands after 800 years.

In 1987, the entire Piazza del Duomo (Cathedral Square) – also known as Piazza Dei Miracoli (Field of Miracles) – including the tower as well as, the Cathedral, and baptistery was declared a Unesco World Heritage Site. This was an acknowledgement of the unique nature of the site and its importance as one of Italy's most popular tourist attractions.

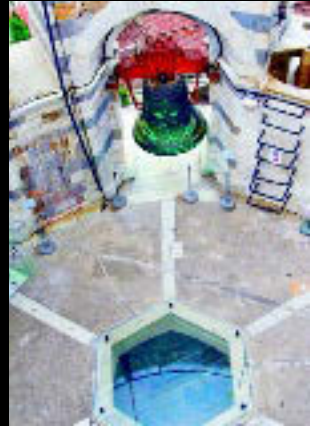

© Shutterstock

Architects

The identity of the Tower of Pisa's first architect remains a mystery. For many years, the initial phase of the design work was attributed to Bonanno Pisano, a well-known 12th-century resident artist of Pisa. However, recent studies appear to indicate that an architect named Diotisalvi, who designed the baptistery, was also responsible for the tower.

The second phase of construction is attributed to Giovanni di Simone, who added four floors to the tower in 1275. Architect Tommaso di Andrea Pisano (1350-1372) was the architect who finished the work and succeeded in harmonizing the Gothic elements of the bell-chamber with the Romanesque style of the tower.

Aujourd'hui

La tour penchée de Pise reste un bâtiment architectural emblématique et une véritable prouesse d'ingénierie médiévale. Elle est surtout célèbre pour son inclinaison, mais le réel prodige de la tour est qu'elle existe toujours après 800 ans.

En 1987, toute la Piazza del Duomo (Place de la cathédrale), aussi appelée Piazza Dei Miracoli (Place des miracles), incluant la tour, la cathédrale et le baptistère, a été déclarée site du patrimoine mondial de l'Unesco. Ceci reconnaissait la nature unique du site et son importance comme l'une des attractions les plus populaires d'Italie.

Architectes

La véritable identité du premier architecte de la tour de Pise demeure un mystère. Pendant de nombreuses années, la phase initiale de conception fut attribuée à Bonanno Pisano, un artiste résident de Pise célèbre au 12^e siècle. Cependant, des recherches récentes semblent indiquer qu'un architecte appelé Diotalalvi était responsable de la tour. On sait, par exemple, qu'il a conçu le baptistère de l'autre côté de la cathédrale.

La deuxième phase de construction est plus claire et est attribuée à Giovanni di Simone, qui a ajouté quatre étages à la tour en 1275. Tommaso di Andrea Pisano (1350-1372) est l'architecte qui termina le travail et parvint à harmoniser les éléments gothiques de la salle des cloches avec le style roman de la tour.

Facts about The Leaning Tower

Location:	Pisa, Italy
Architects:	Various
Date:	Started 1173 – Completed 1399
Construction type:	Bell Tower
Architectural Style:	Romanesque Tower/Gothic Bell Chamber
Materials:	Limestone, Lime mortar, Marble exterior
Height:	8 stories, 185 ft. (56.4 m)
Diameter of base:	50 ft. 9.6 in (15.484 m)
Weight:	16,000 tons (14,500 metric tons)
Angle of tilt:	3.97 degrees 12 ft. 10 in (3.9 m) from vertical

Informations sur la tour penchée

Lieu:	Pise, Italie
Architectes:	Divers
Date:	Commencée en 1173 - Terminée en 1399
Type de construction:	Clocher
Style architectural:	Tour romane/Salle des cloches gothique
Matériaux:	Pierre calcaire, mortier de chaux, extérieur en marbre
Hauteur:	8 étages (56,4 m)
Diamètre de base:	15 484 m
Poids:	14 500 tonnes
Angle d'inclinaison:	3,97 degrés (3,9 m) de la verticale



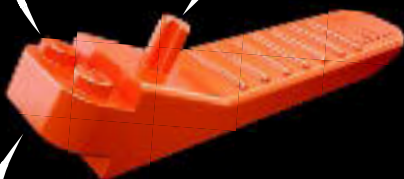
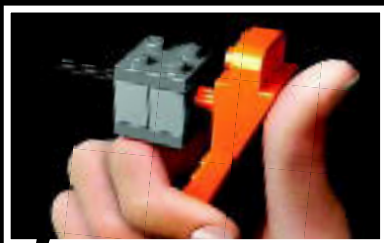

LEGO.com/brickseparator

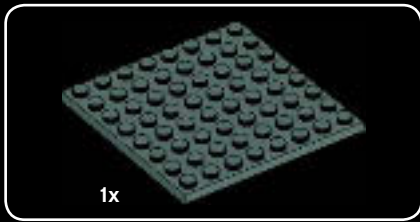

1



At only 185 ft. (56.4 m), the Leaning Tower of Pisa is the smallest "tower" to achieve worldwide recognition.

Avec une hauteur de seulement 56,4 m de haut, la tour penchée de Pise est la plus petite « tour » mondialement célèbre.



© Shutterstock



5x

2

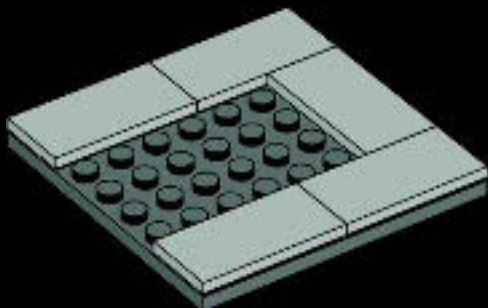

1x



2x



2x

3





1x



1x

4

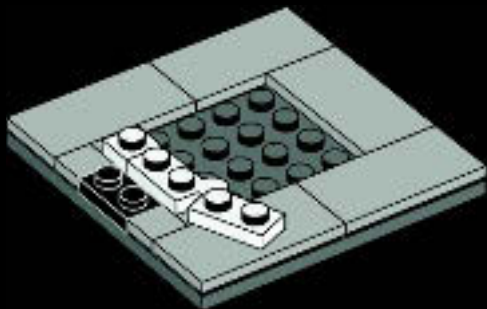

2x

5

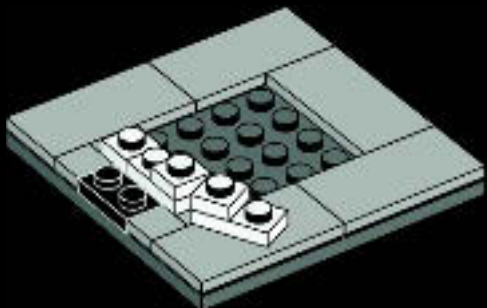



6

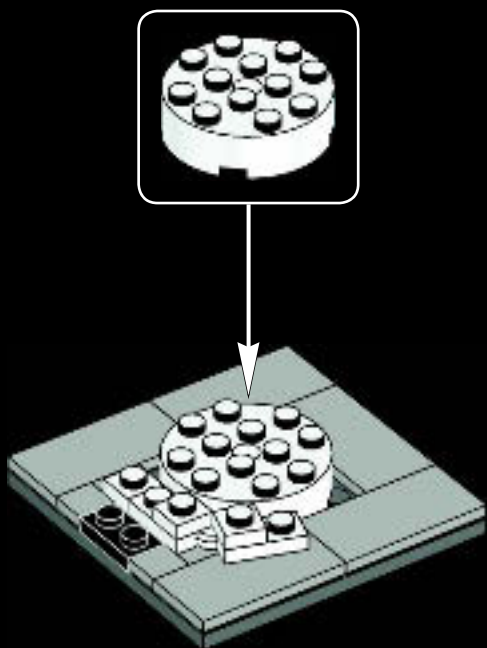



7

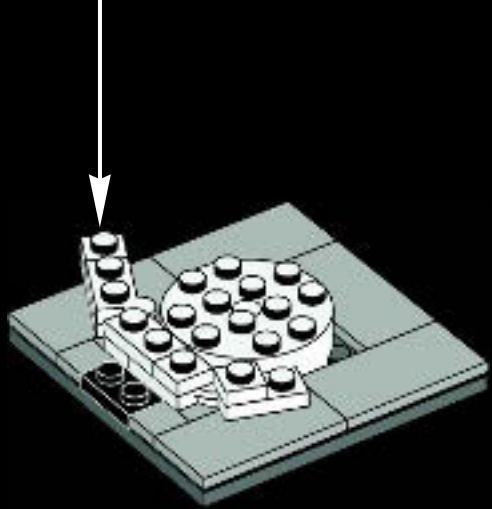
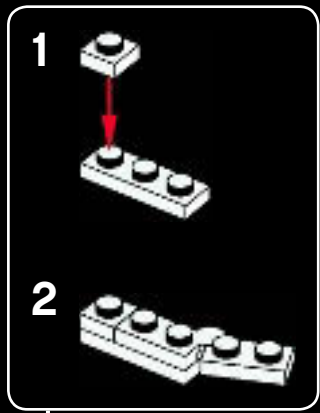



8

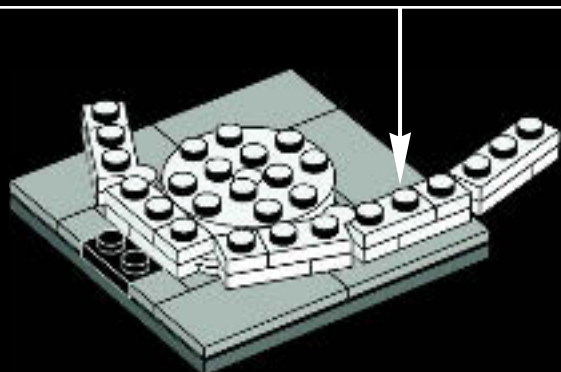
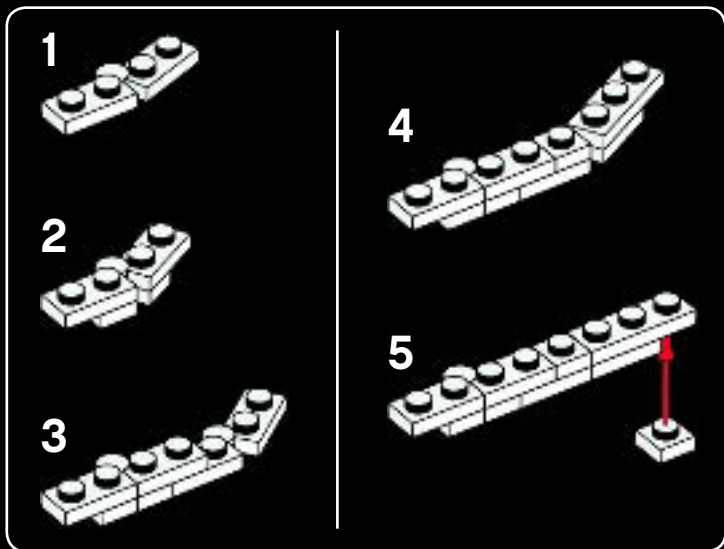

9

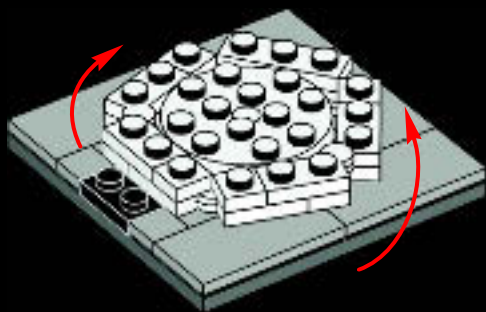

1x

10

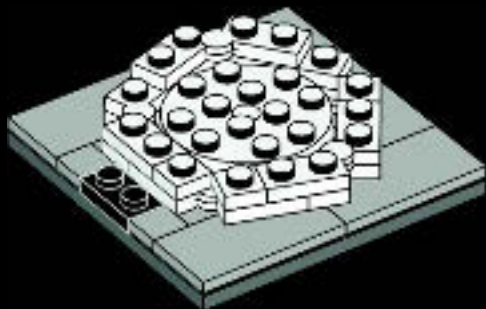



2x



2x

11

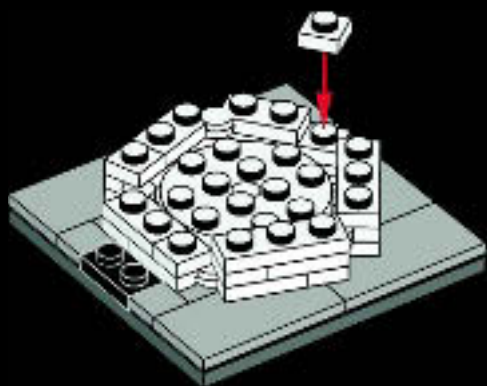



1x



1x

12

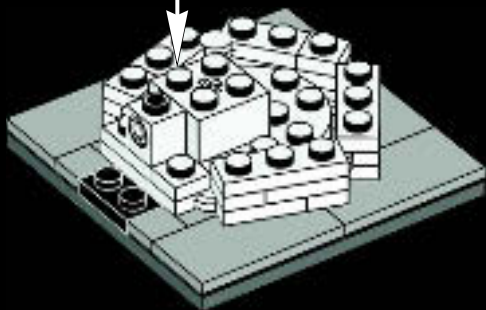
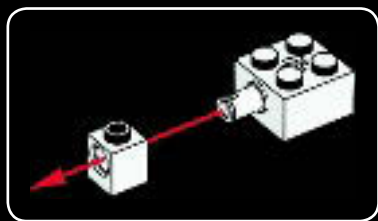



2x

13





2x

14

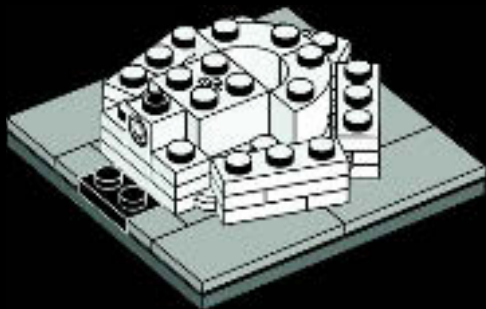

1x

15

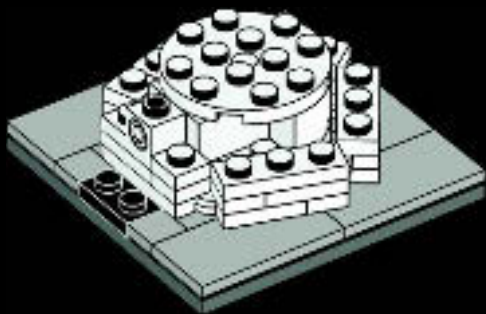



8x



8x

16

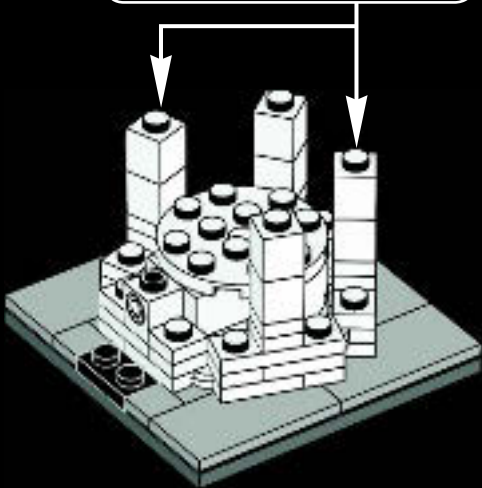
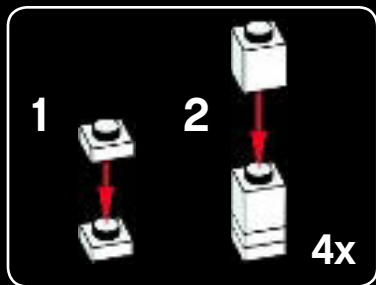



2x

17

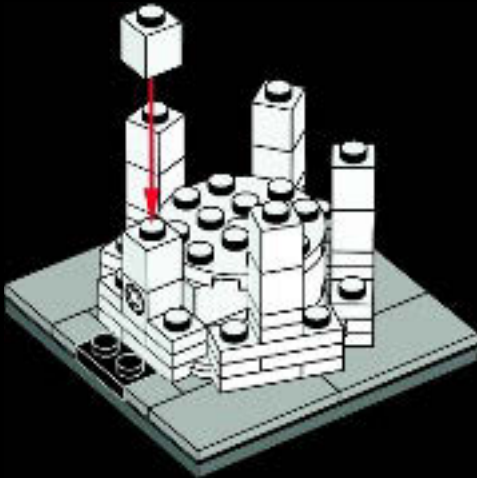

The first bell was placed in the tower in 1198.

La première cloche fut placée dans la tour en 1198.



© Shutterstock



5x

18

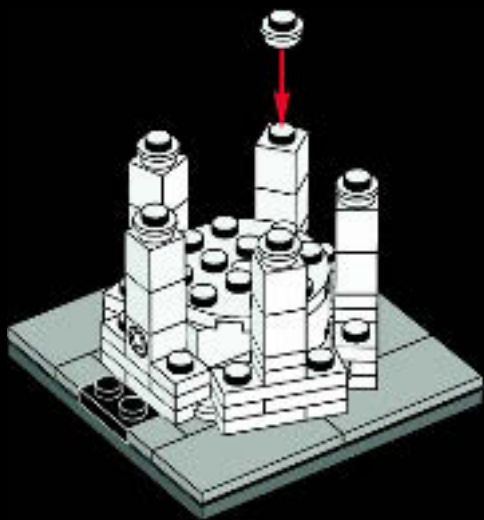



10x



10x



10x

19

1



2



10x

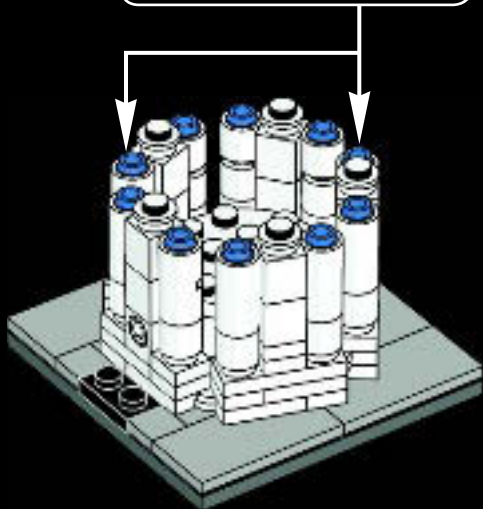



5x

20

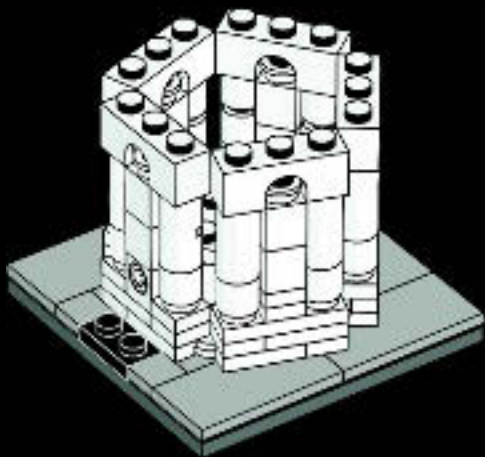



1x

21

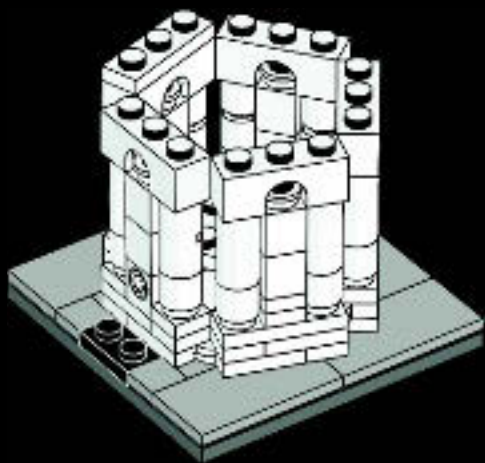



2x

22

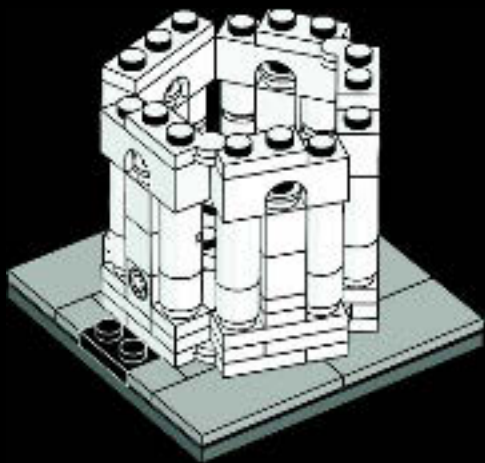



4x

23

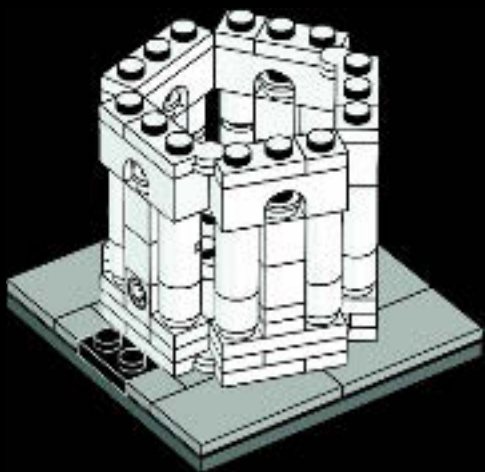



24

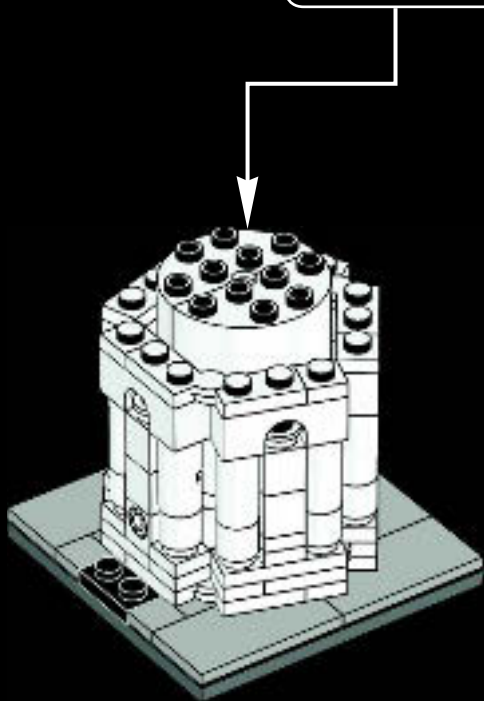



1x

25

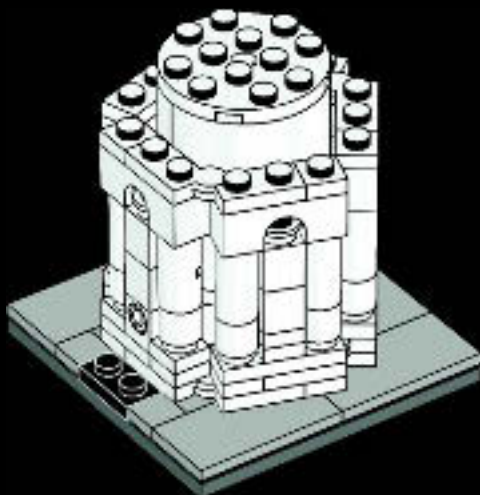

The tower has 296 or 294 steps; the seventh floor has two fewer steps on the north-facing staircase.

La tour a 296 ou 294 marches, le septième étage ayant deux marches de moins sur l'escalier nord.



© Shutterstock



10x

26

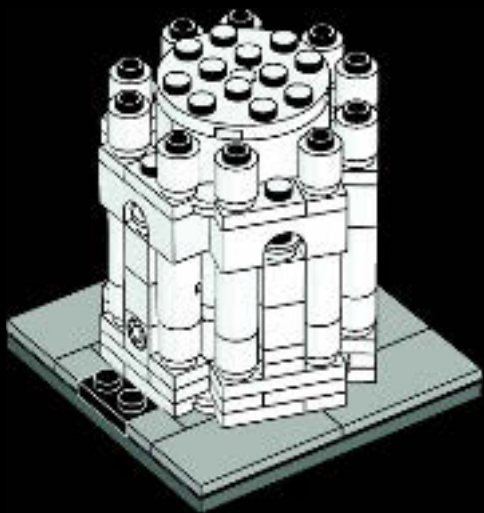



5x

27

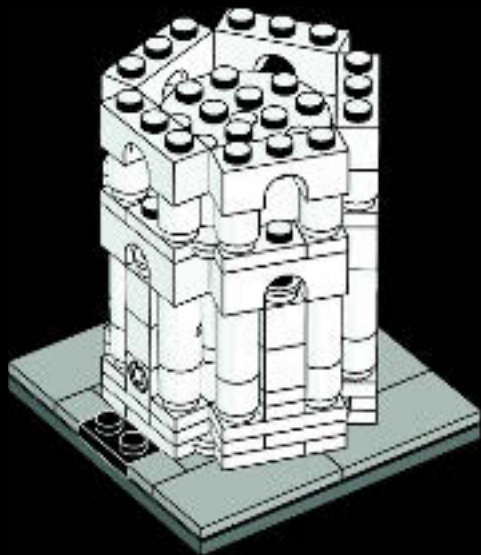



1x



2x

28

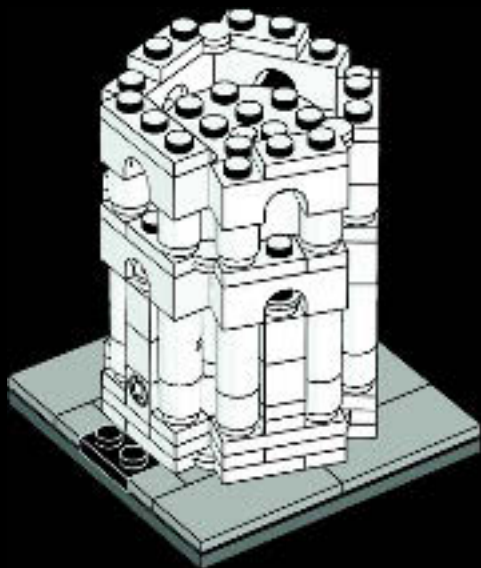



4x

29

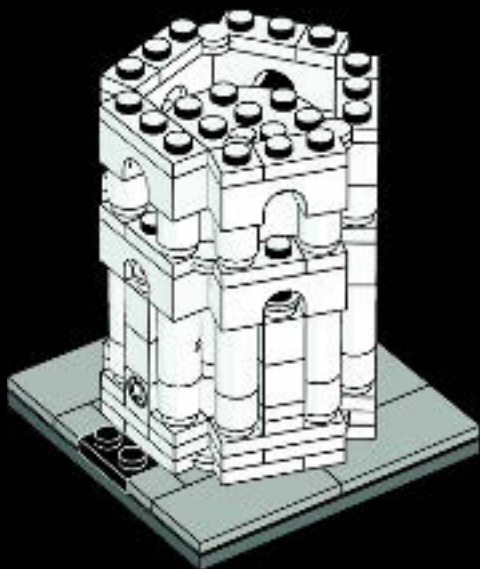



10x

30

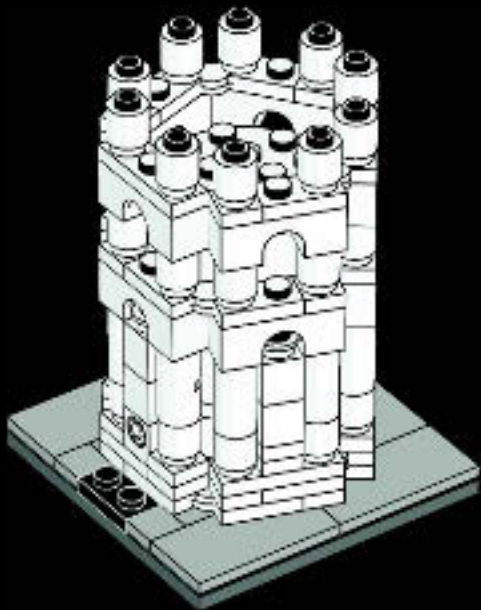



5x

31

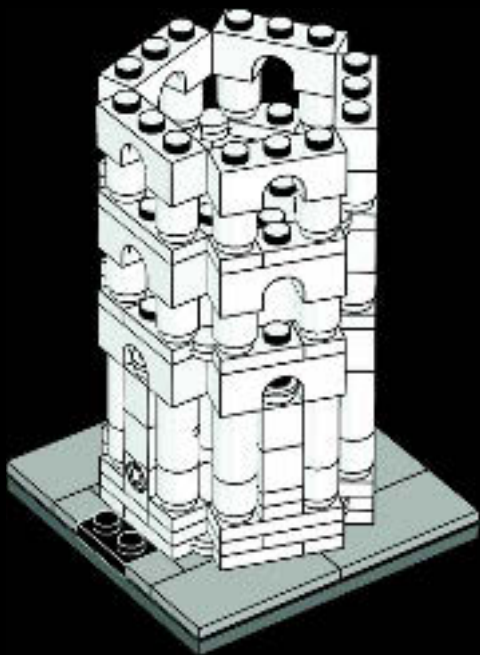



1x



2x

32

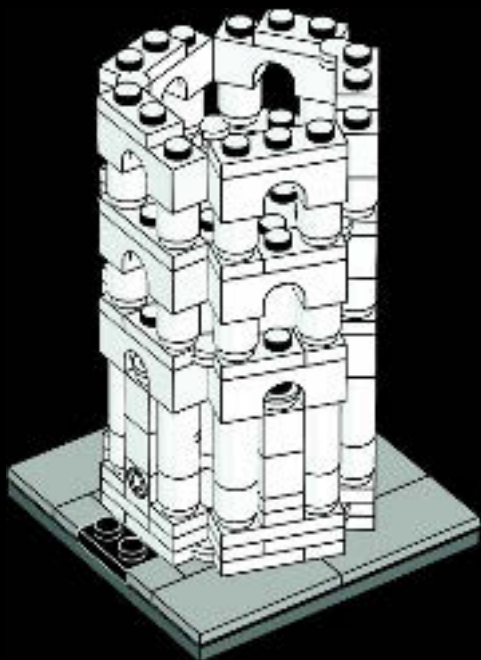



4x

33

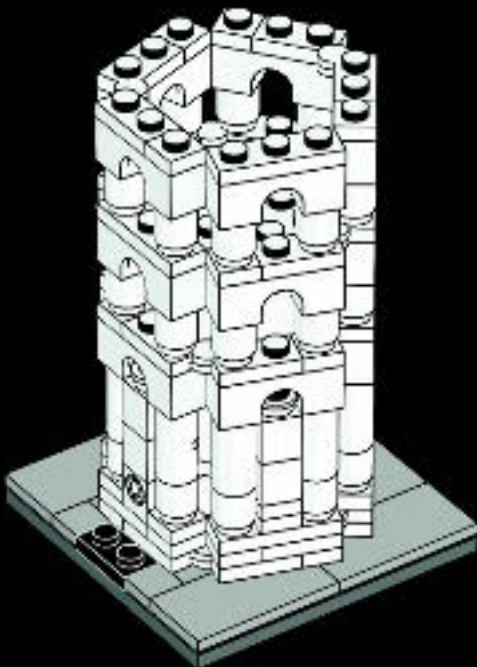

*There are 207 individual columns
ranged around the eight-story tower.*

*Il y a 207 colonnes individuelles
sur la tour de huit étages.*



© Shutterstock



2x

34

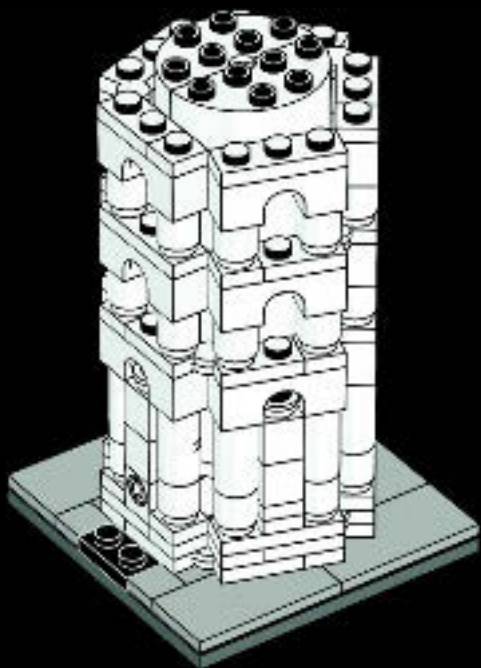



1x

35

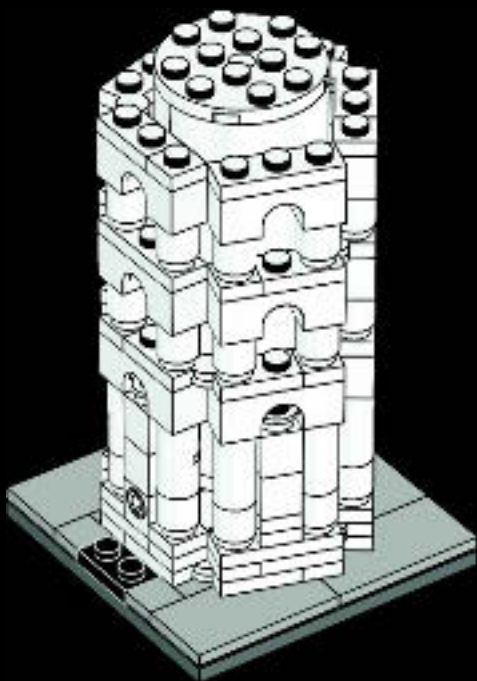



10x

36

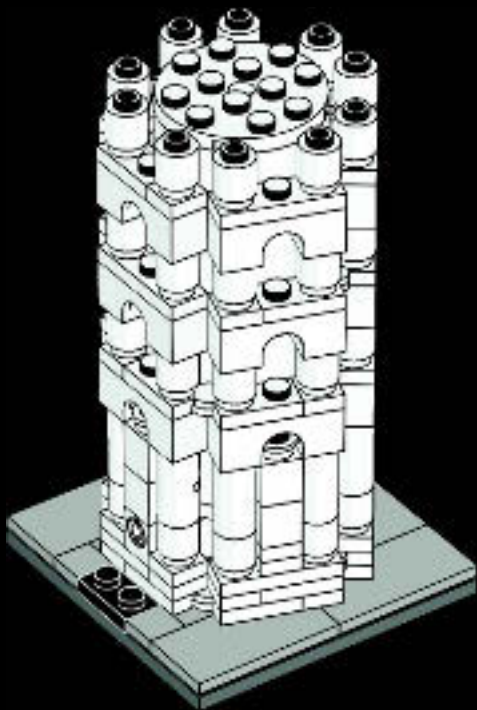



5x

37

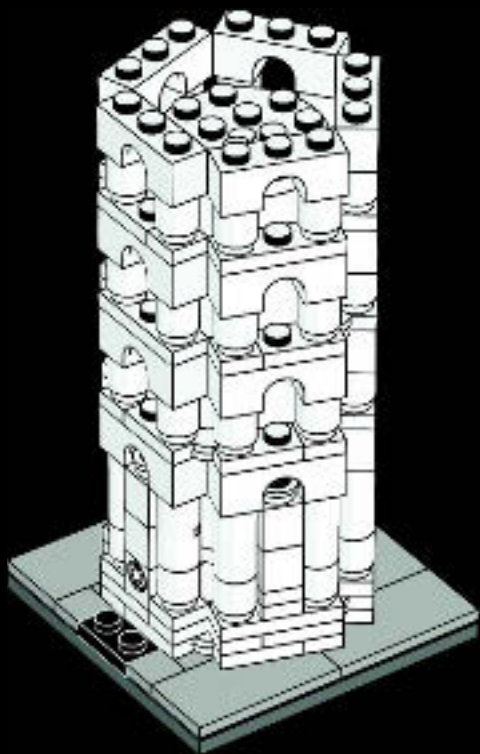



1x



2x



38

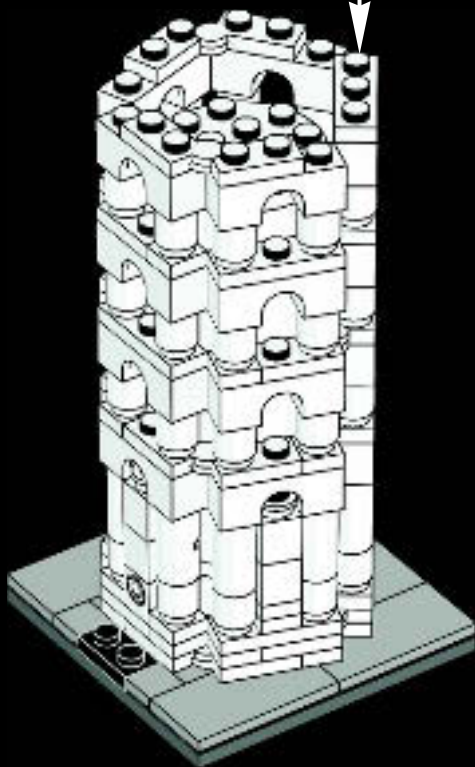



4x

39

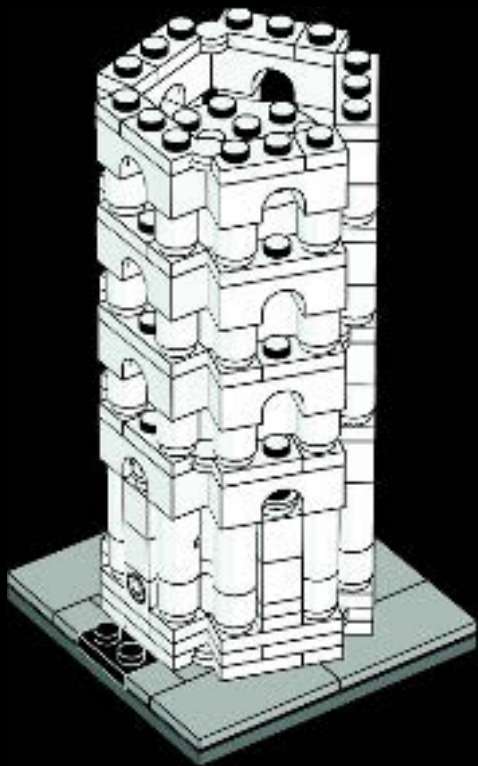



10x

40

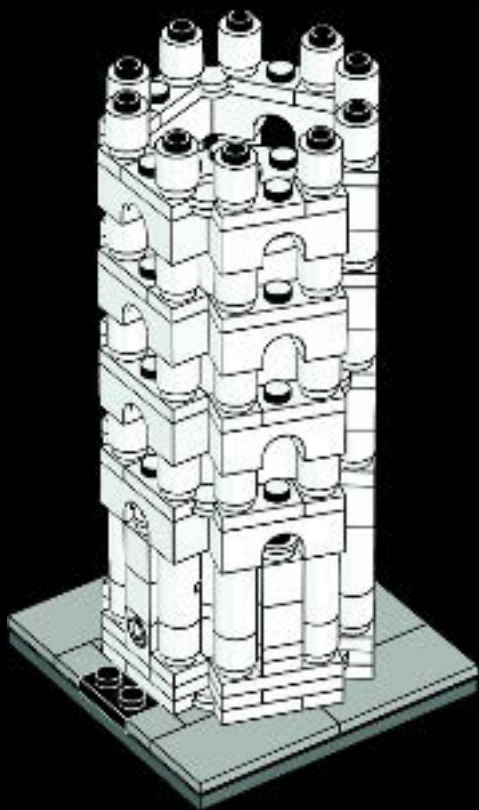



5x

41

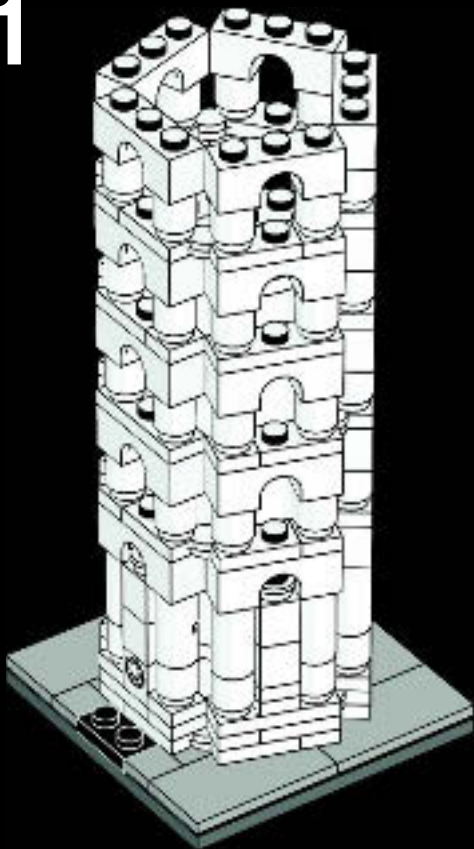

On the upper floors, one side is taller than the other. As a result, the tower is actually curved.

Aux étages supérieurs, un côté est plus haut que l'autre. La tour est donc courbe.



© Shutterstock



1x



2x

42

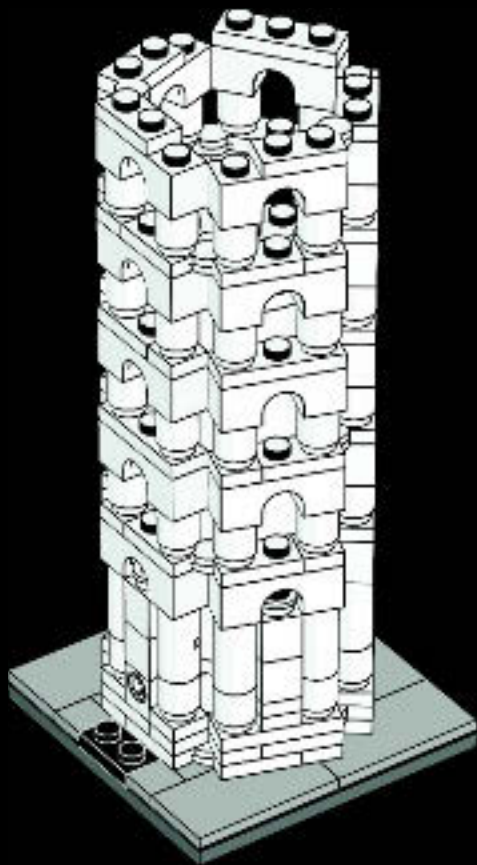



4x

43

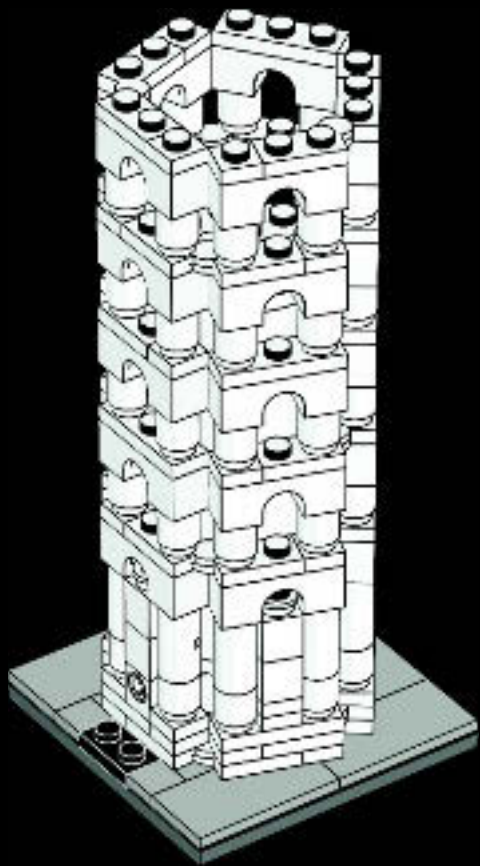



2x

44

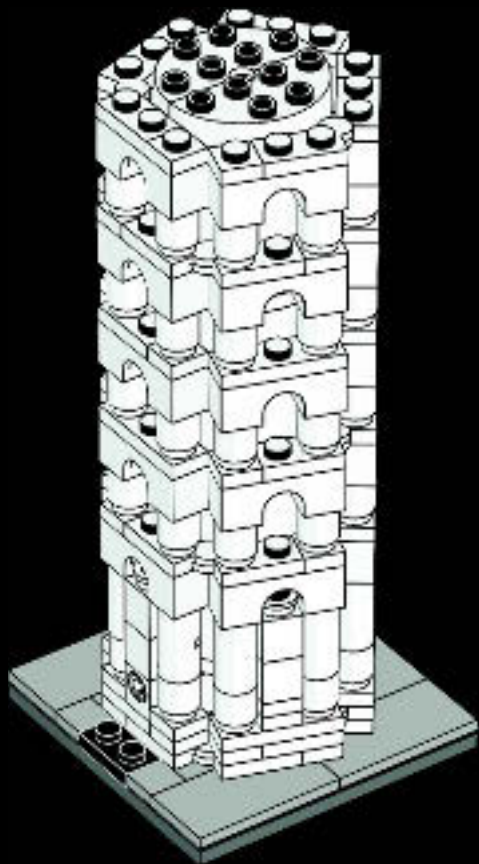



1x

45

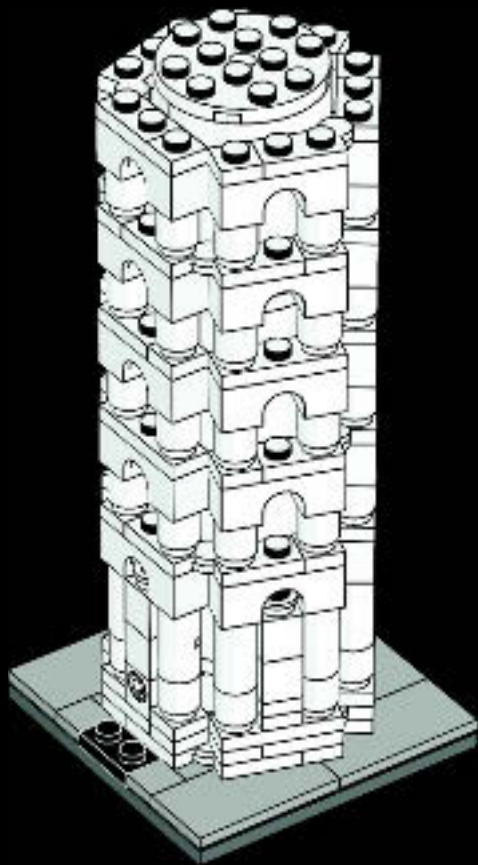



10x

46

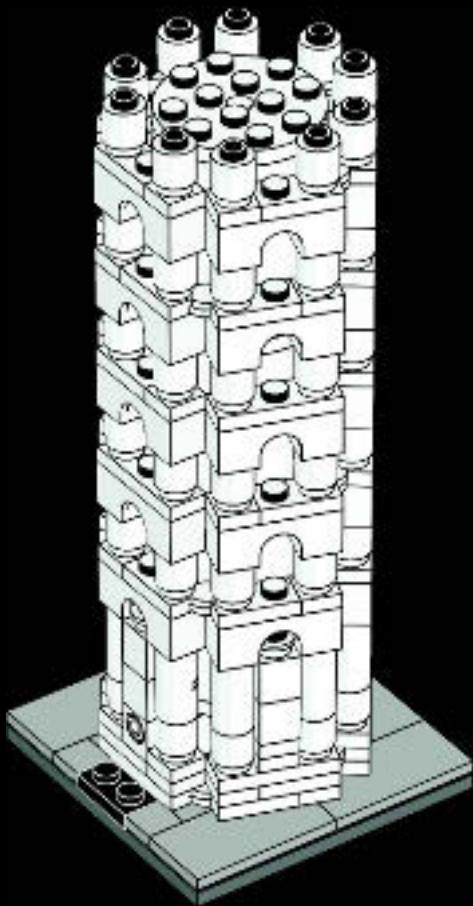



5x

47

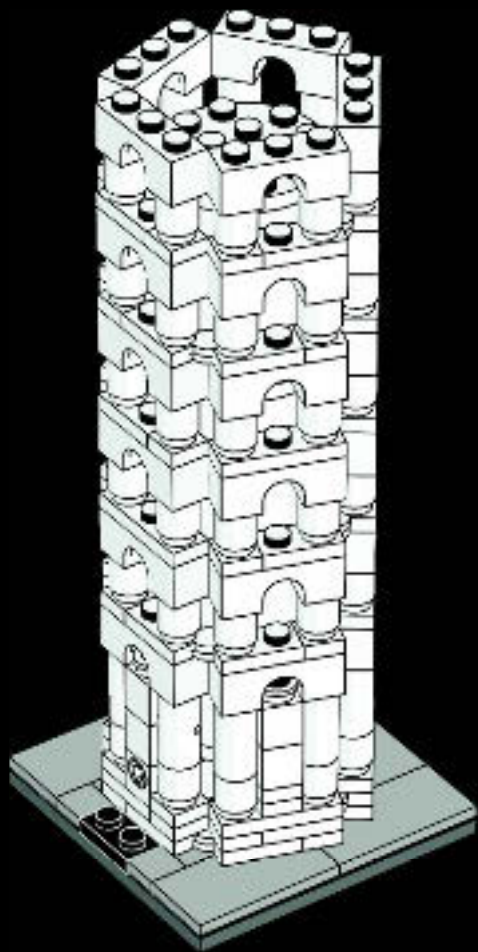



1x



2x

48

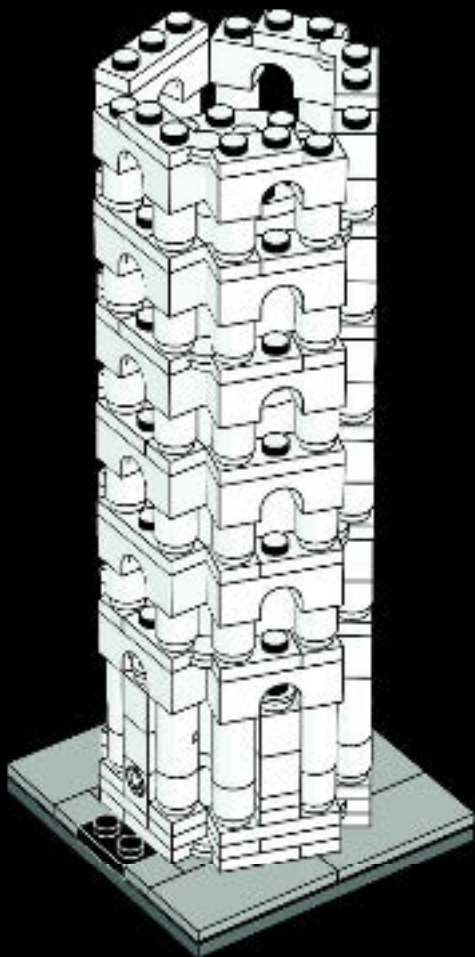



4x

49

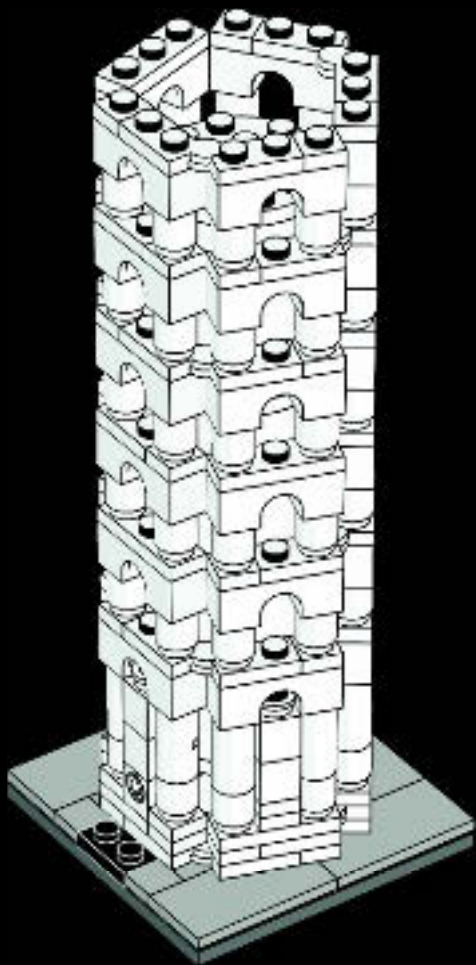



10x

50

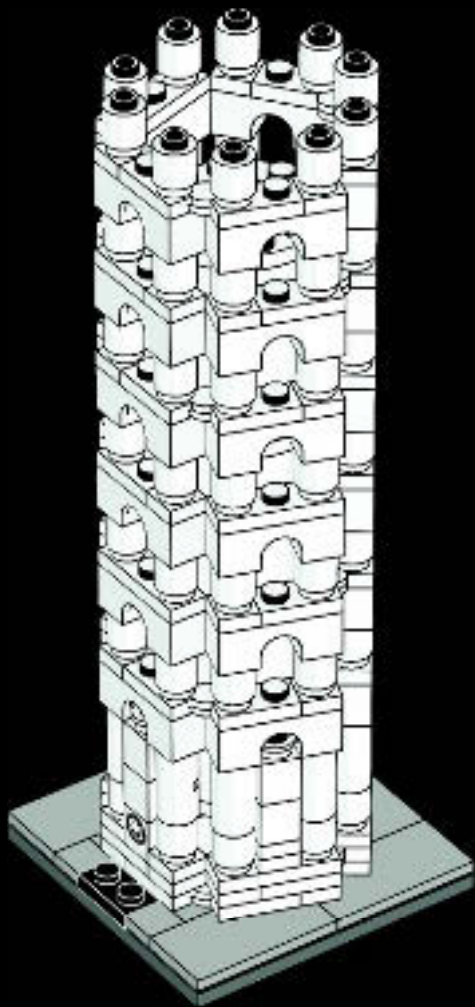

60



5x

51

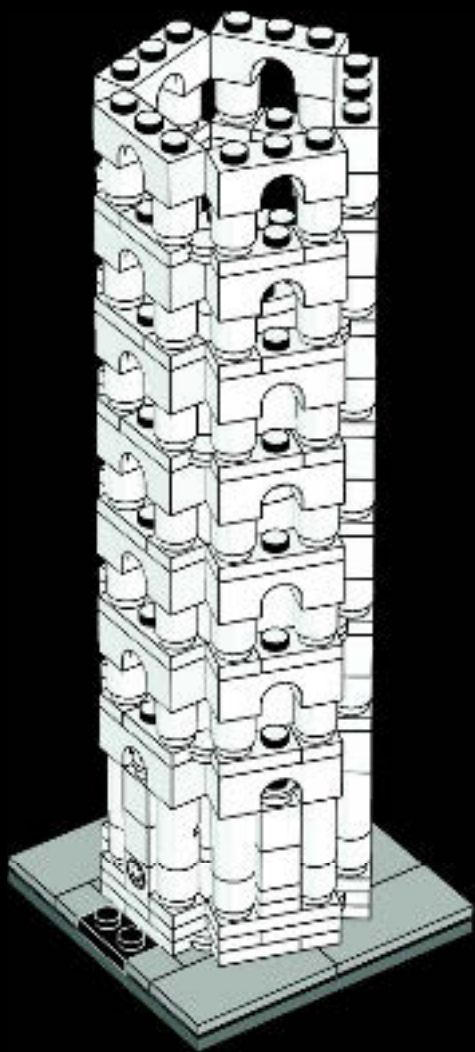



1x



2x

52

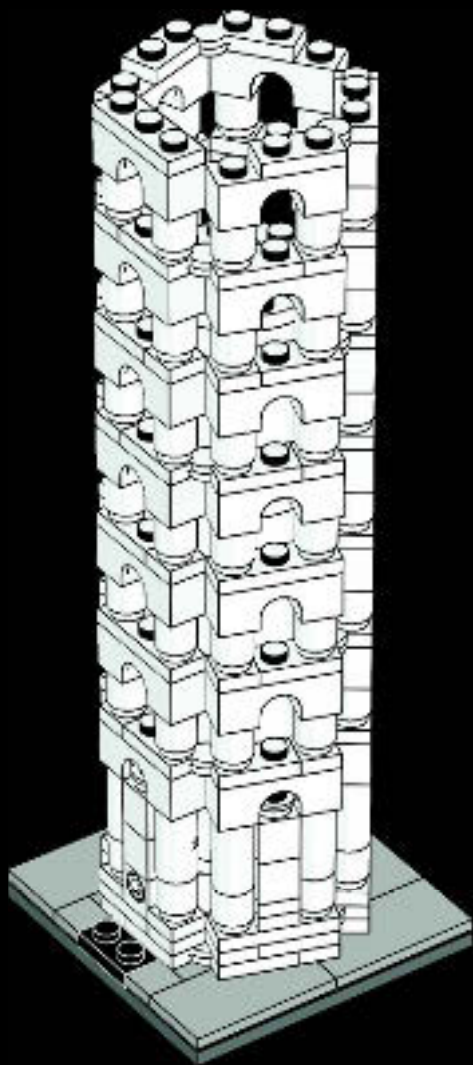



4x

53

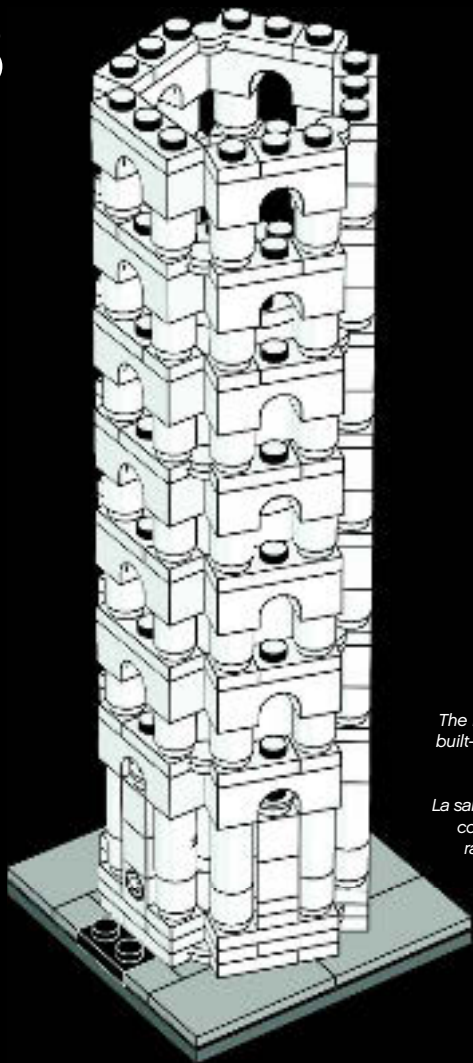

The bell-chamber incorporates a built-in 5.5 in (14 cm) correction in relation to the tower's lean.

La salle des cloches comprend une correction intégrée de 14 cm par rapport à l'inclinaison de la tour.



© Shutterstock



2x

54

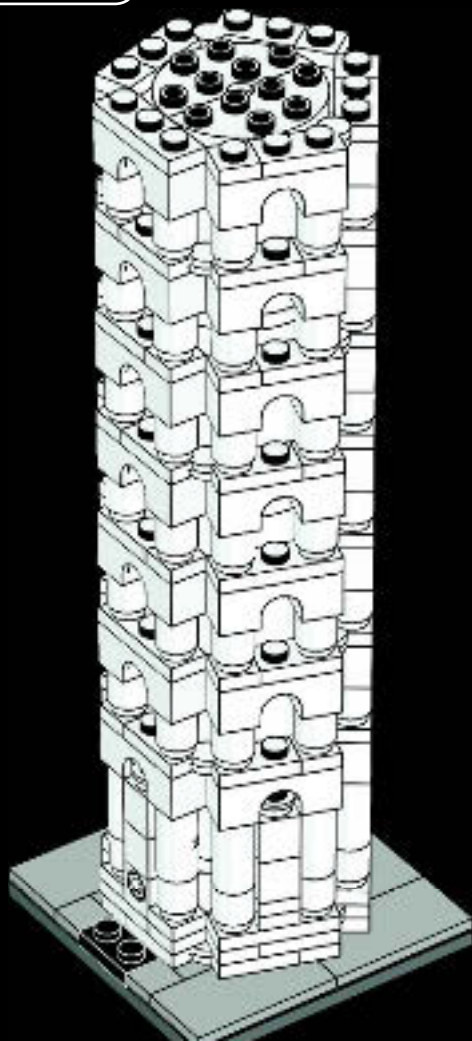



15x



1x

55

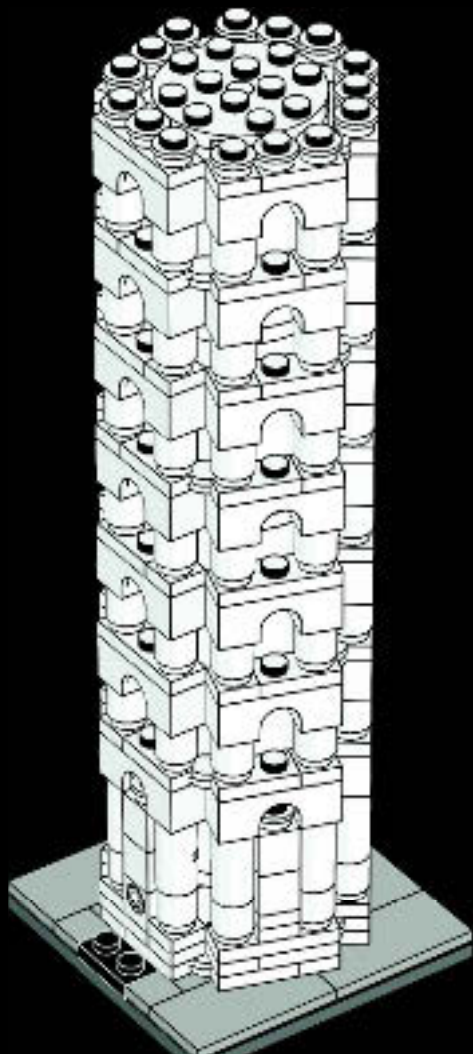



2x

56

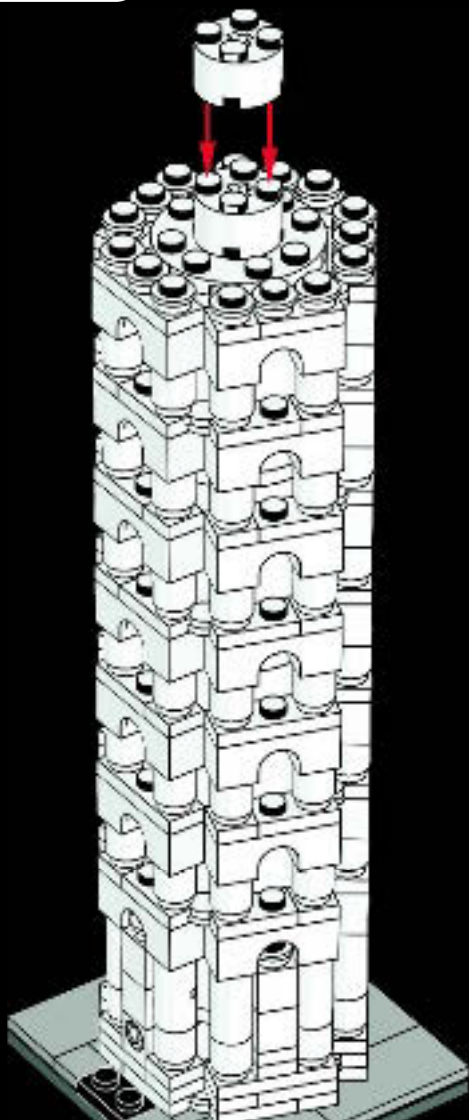



16x

57



8x

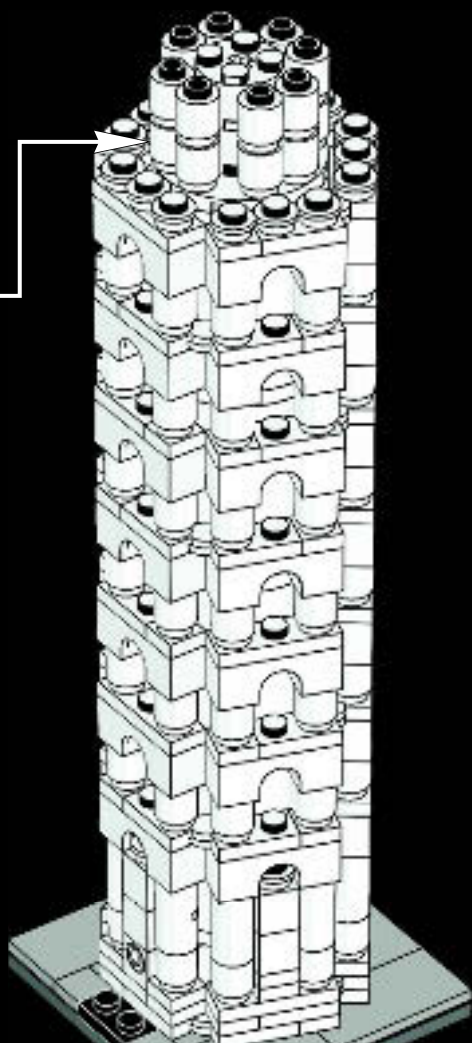



1x

58

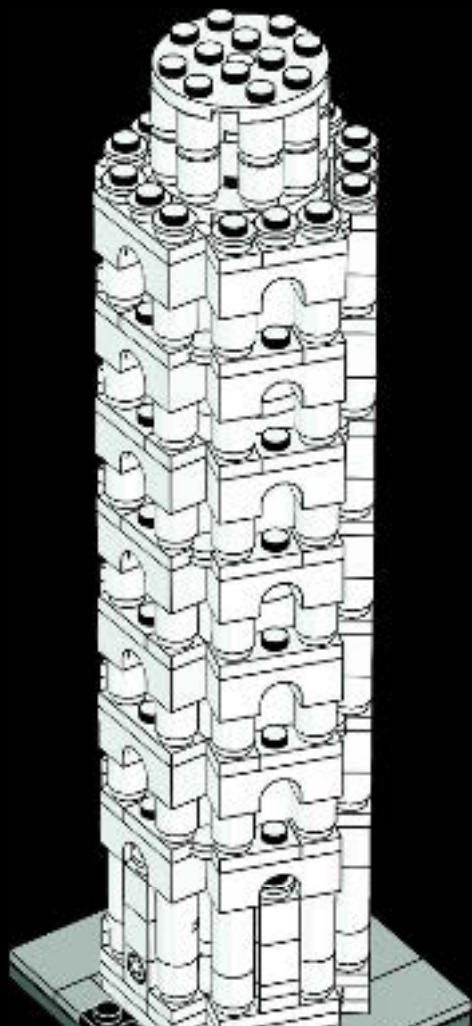



1x



8x

59

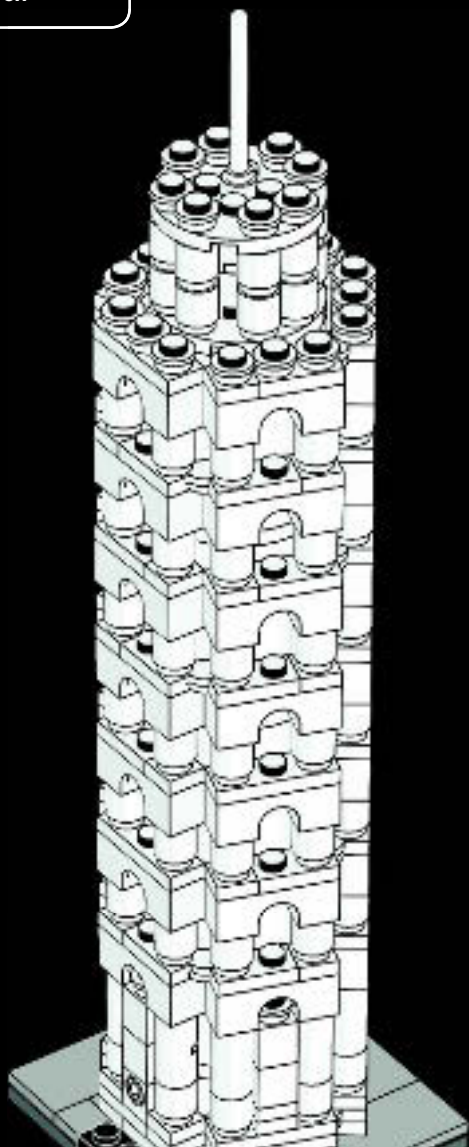



60

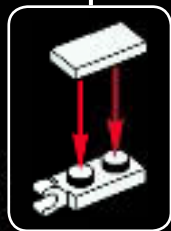
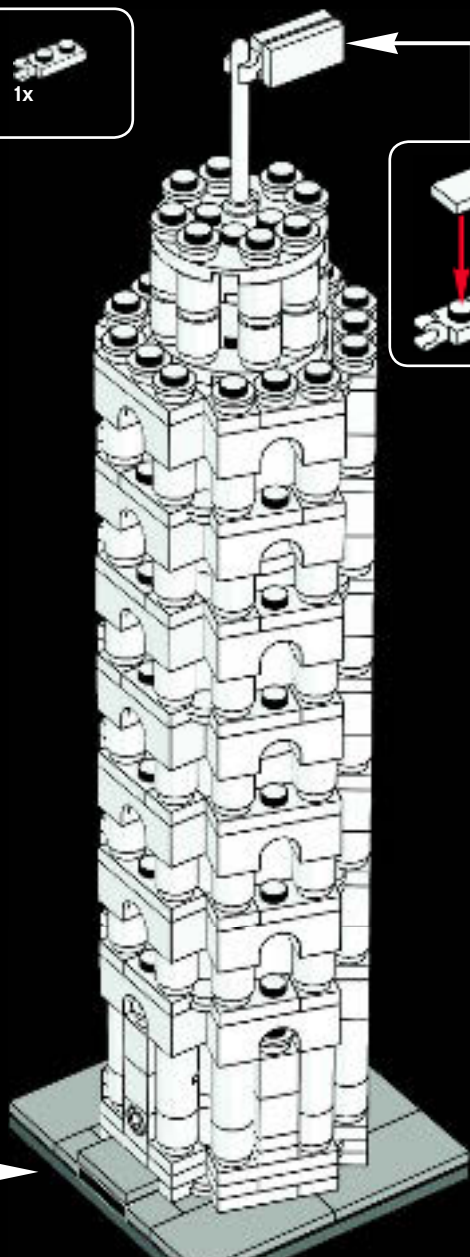

70



1x



2x

1

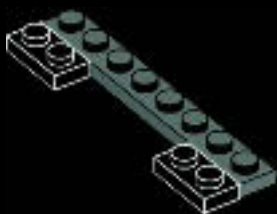

2x



2x

2

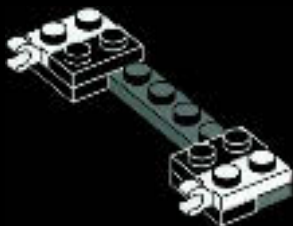



3

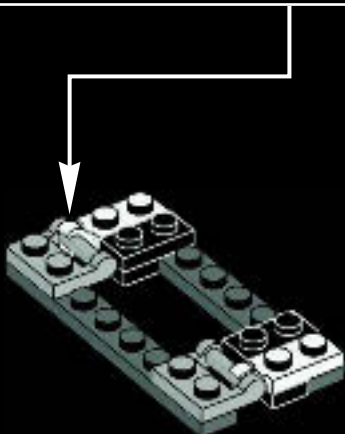
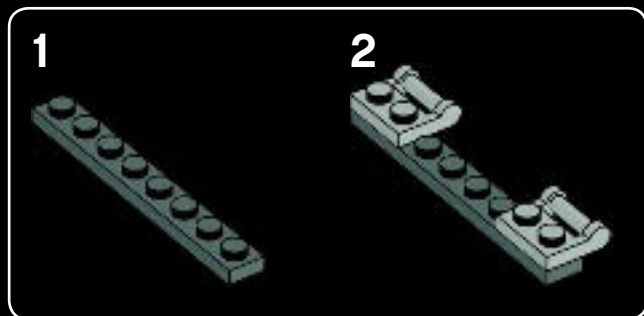

61

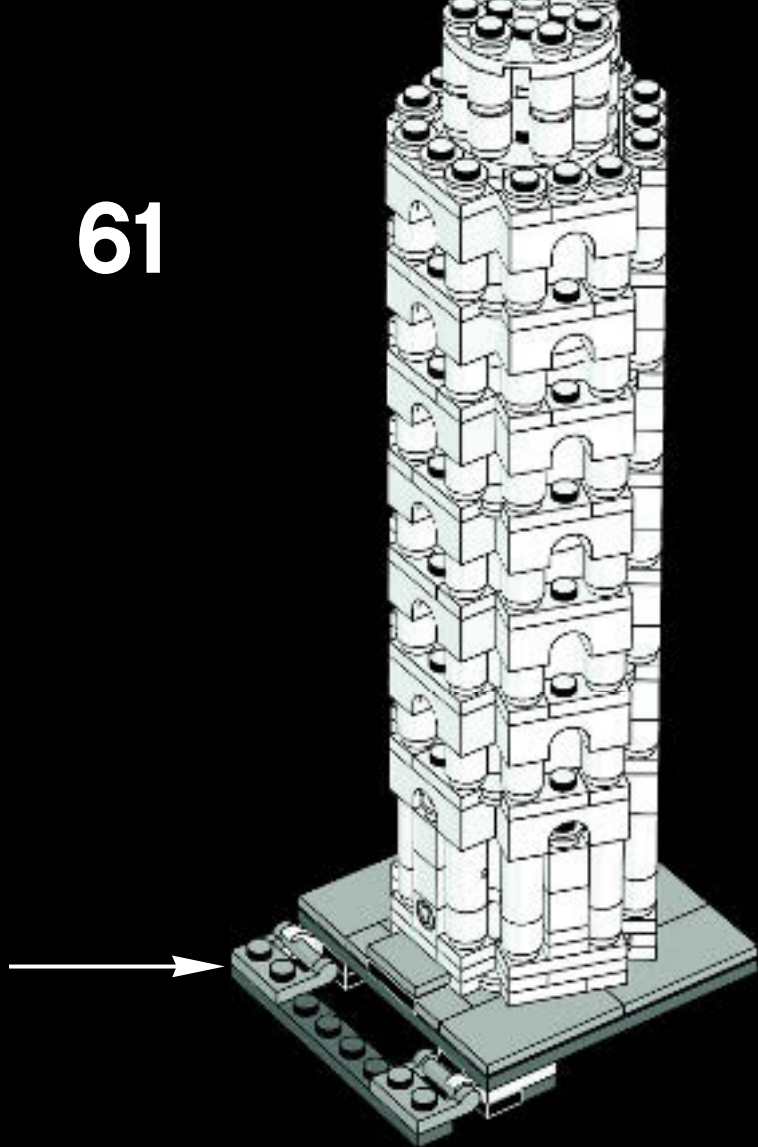

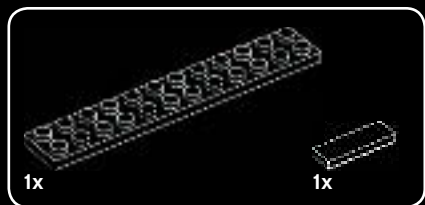
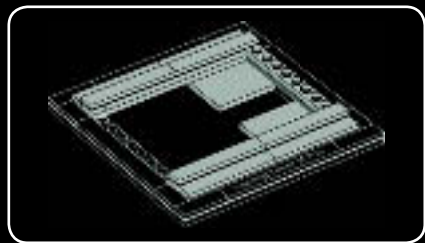

1

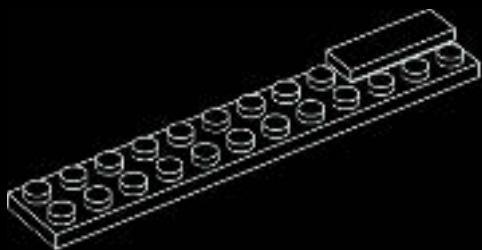

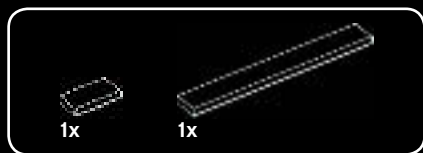

2

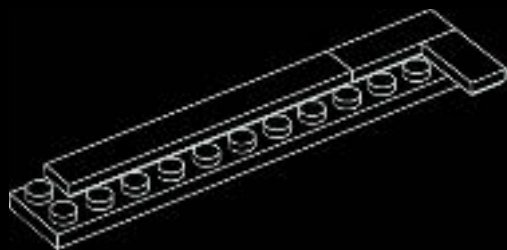

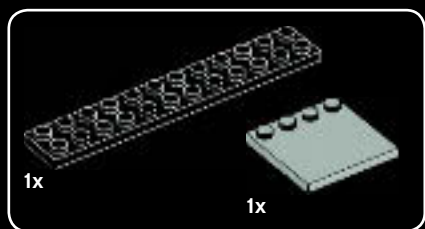

3

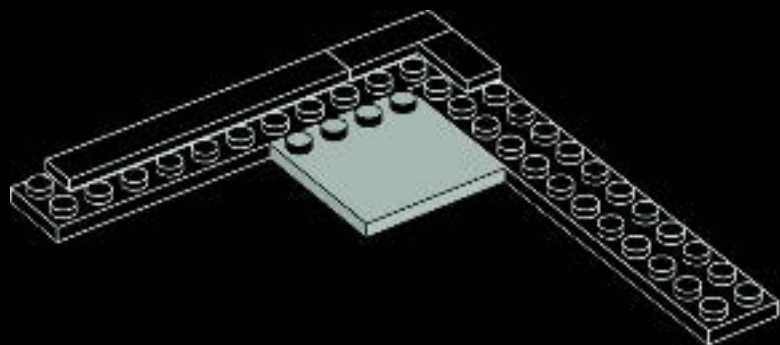

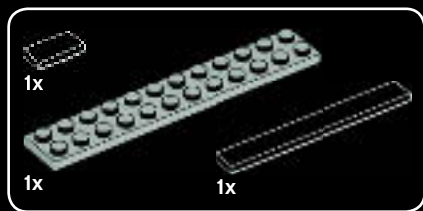

4

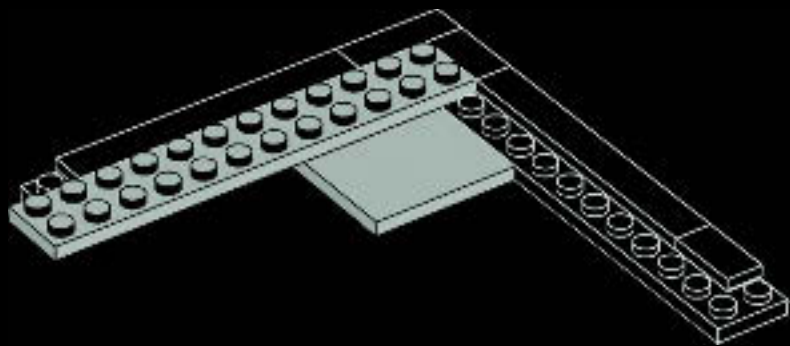

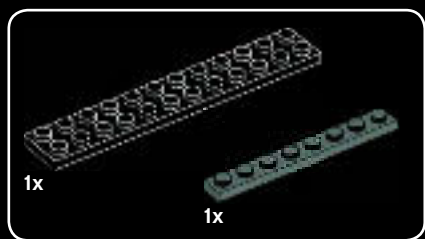

5

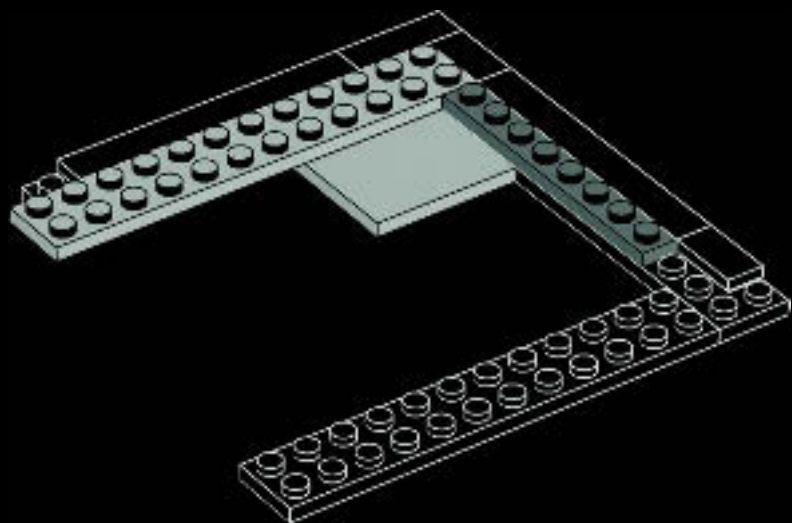

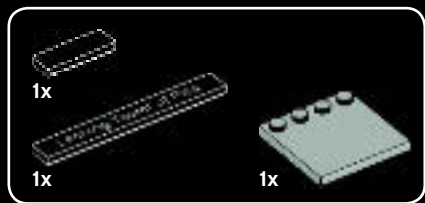

7

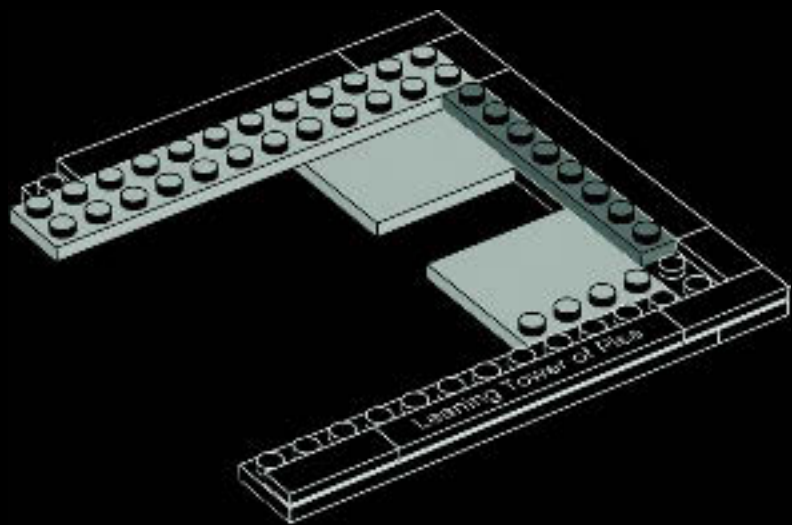

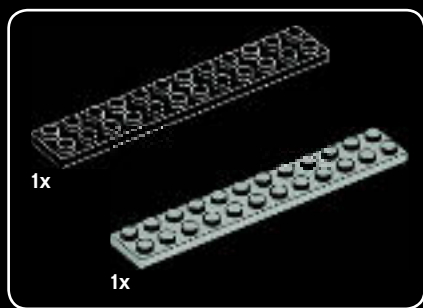

8

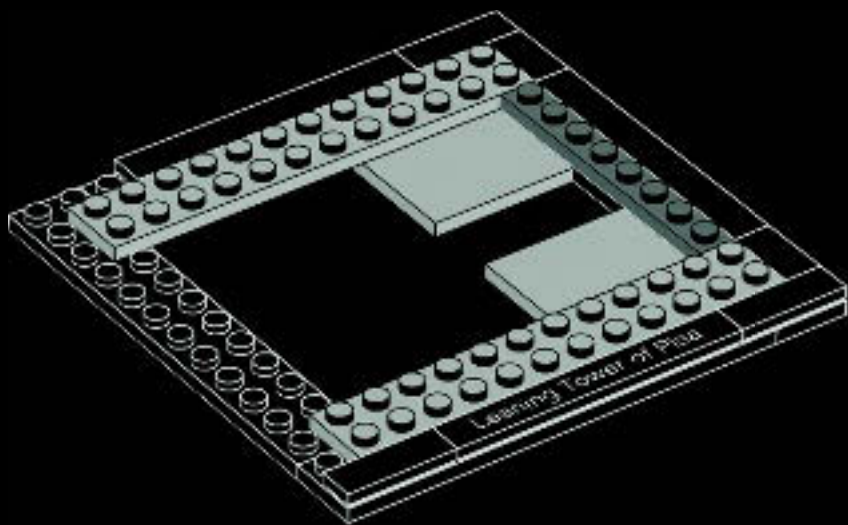

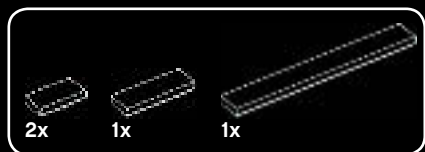

9

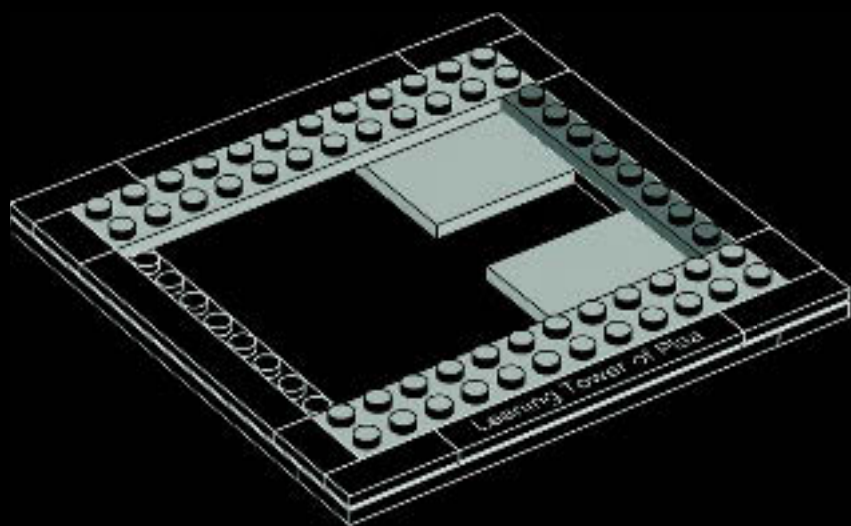

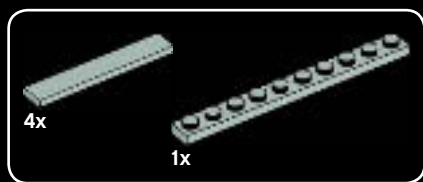

10

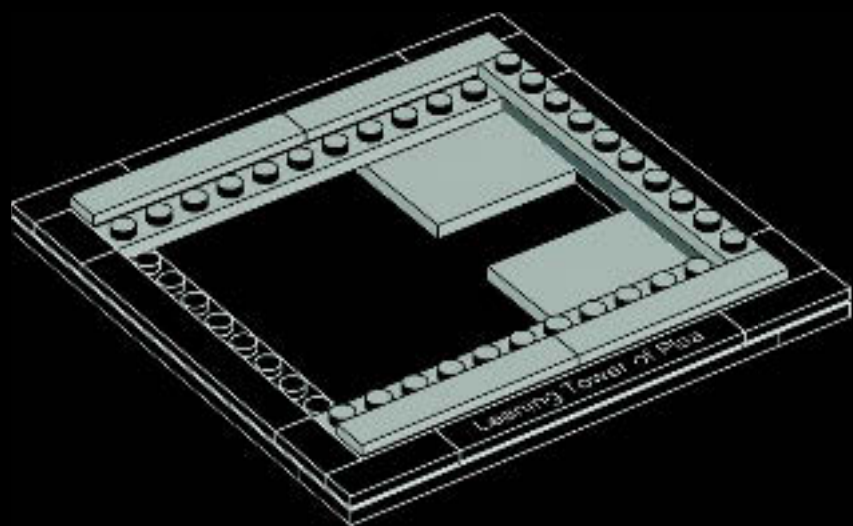

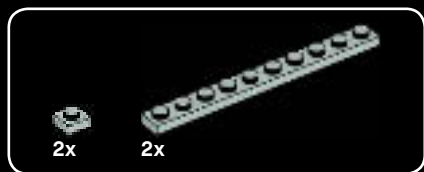

11

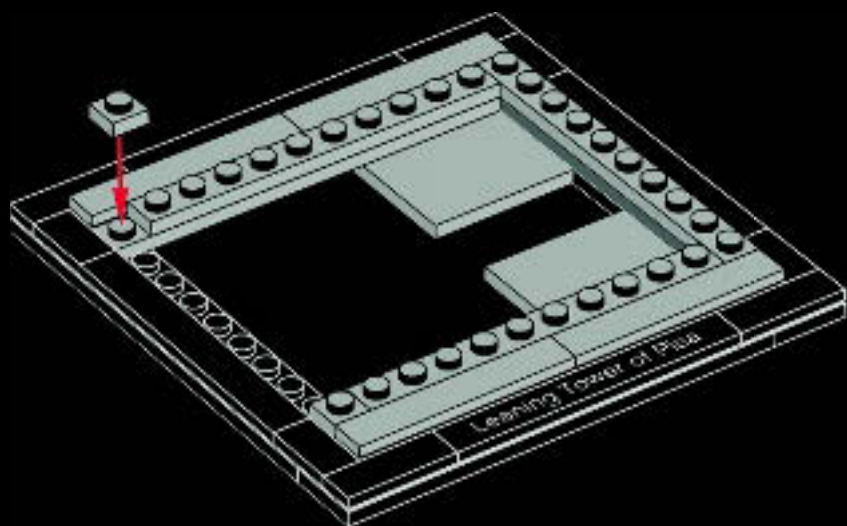

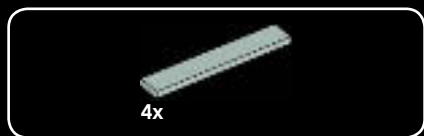

12

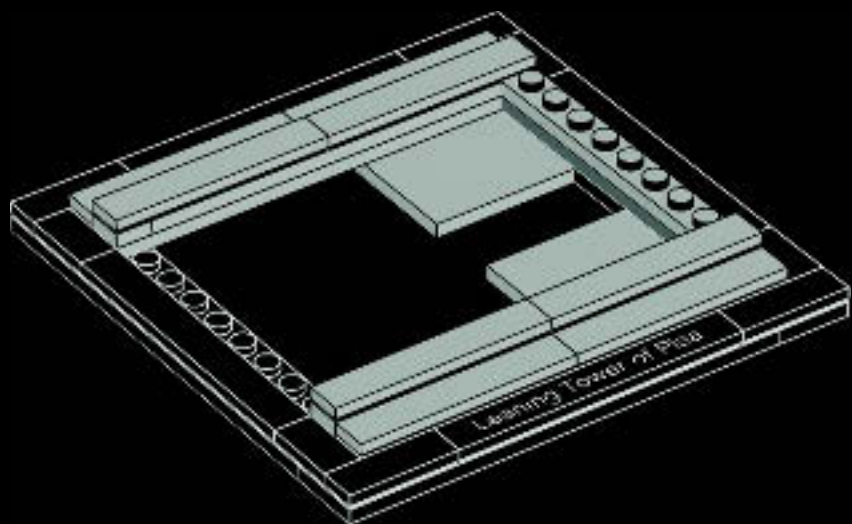

62

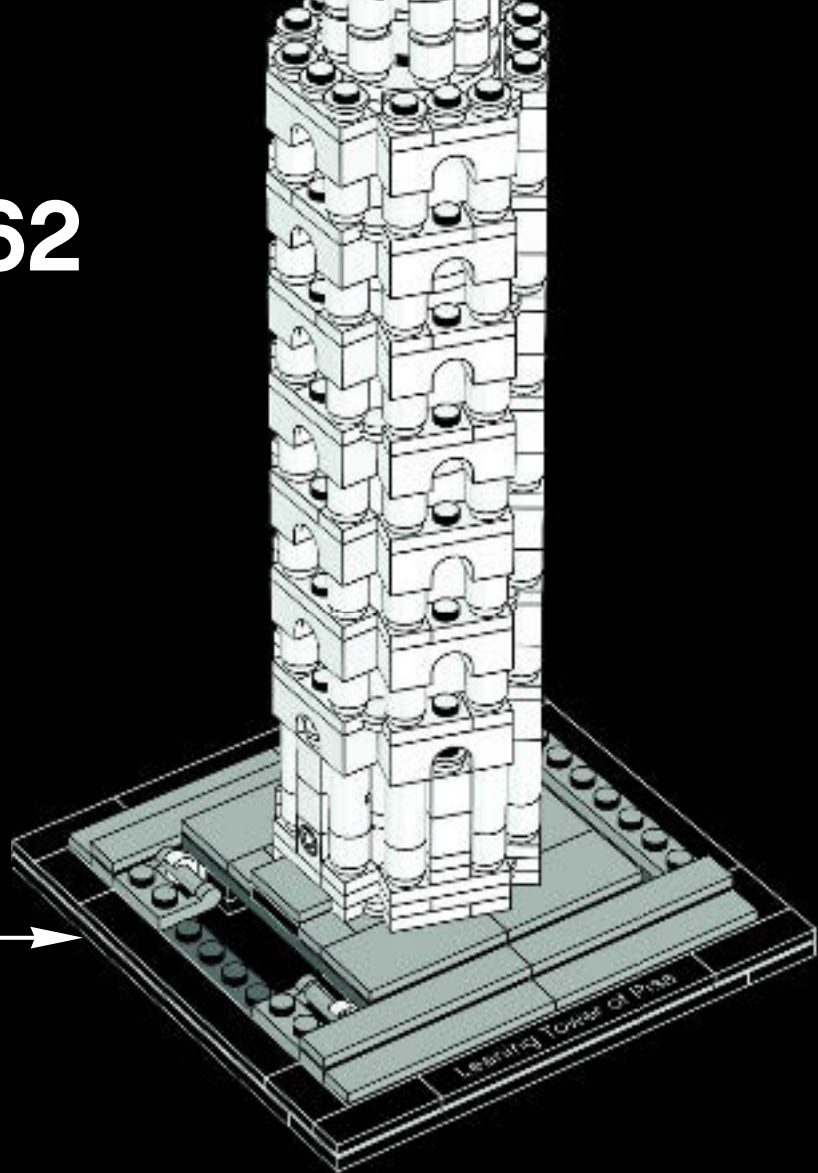



1x

63

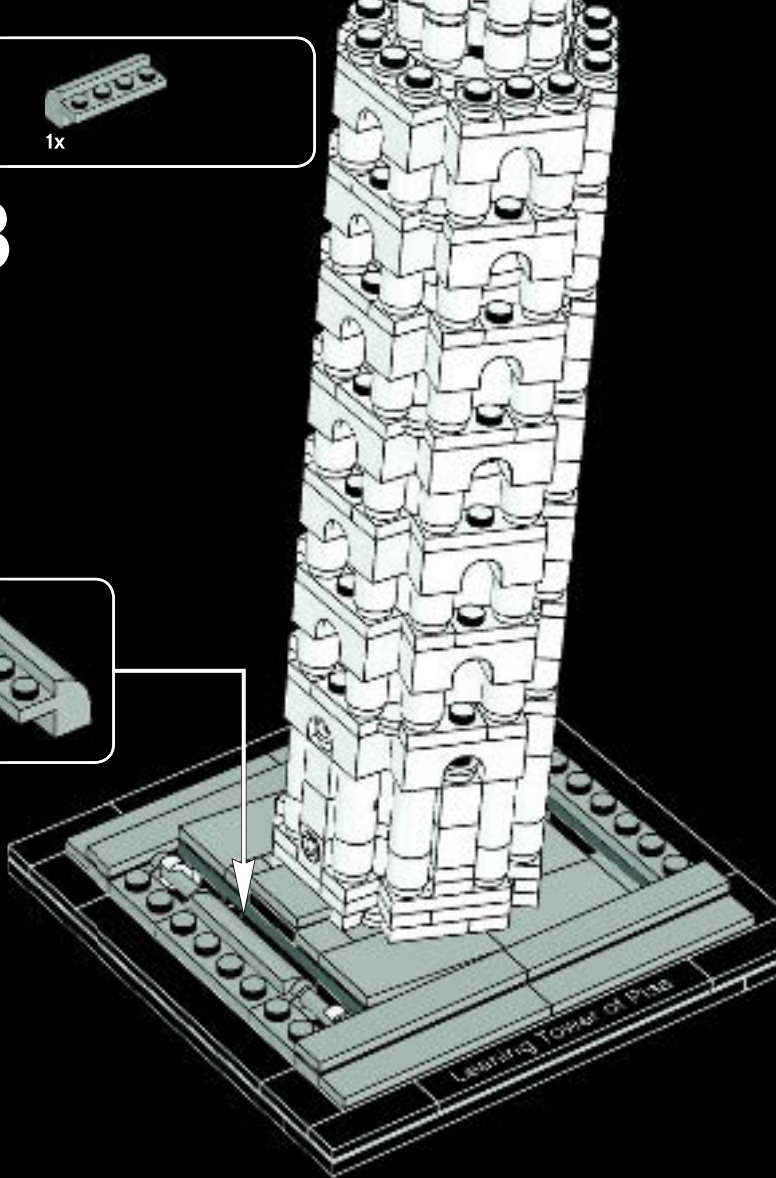



2x

64

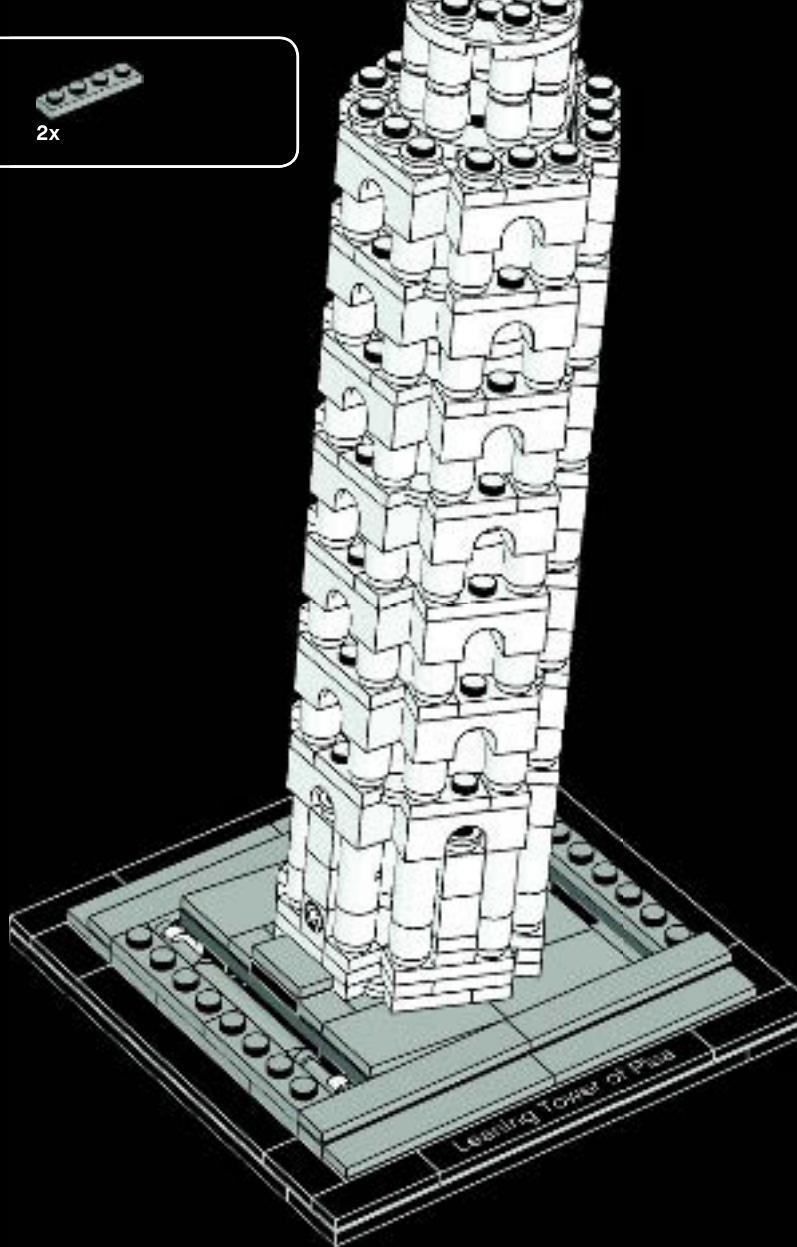



4x

65

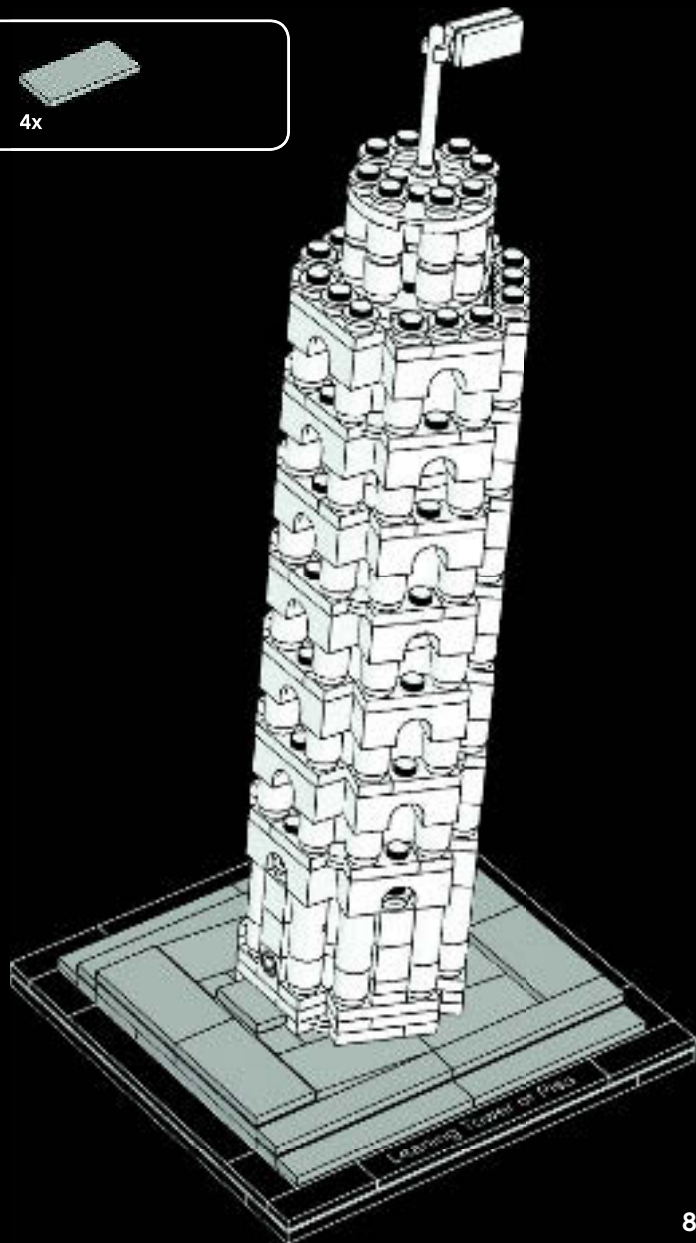

A Word from the Artist

“As an Architectural Artist, my desire is to capture the essence of a particular architectural landmark into its pure sculptural form. I first and foremost do not view my models as literal replicas, but rather my own artistic interpretations through the use of LEGO® bricks as a medium.

In an attempt to appeal to the vast admirers of the Leaning Tower of Pisa, our specific aim was to ensure that it could be both afforded and constructed by anyone looking to enjoy displaying a miniature Pisa they can call their own. To do so, I needed to adhere to a minimal element/part pallet, which would affect the model's scale, level of detail and construction techniques while maintaining structural integrity.

Exploring different, creative solutions and incorporating artistic license makes it possible to capture the essence of the structure without sacrificing its identity. Once the identifiable features, subtle details, and overall form were completed, I turned my attention to accomplishing the task of what color would best represent the building materials used in the real structure. The color selection turned out to be rather effortless since white was the clear choice for representing the tower's white Italian marble from Carrara.”

Adam Reed Tucker



The Leaning Tower of Pisa model was created in close collaboration with the LEGO design team. They look at the model from a LEGO building point of view and ensure the construction process is simple, logical, and a positive experience for the user.



Un mot de l'artiste

« En tant qu'artiste architecte, je veux capturer l'essence d'un monument architectural spécifique dans sa forme sculpturale la plus pure. Je ne vois pas mes maquettes comme des répliques exactes, mais plutôt comme ma propre interprétation artistique avec des briques LEGO® comme vecteur.

Afin d'attirer les nombreux admirateurs de la tour penchée, notre but spécifique fut d'assurer que le modèle était abordable et pouvait être construit par toute personne souhaitant exposer sa propre tour de Pise miniature. Pour ce faire, je devais utiliser un minimum d'éléments qui permette d'obtenir l'échelle, le niveau de détail et les techniques de construction du modèle tout en préservant l'intégrité structurelle.

Explorer différentes solutions créatives et incorporer une certaine liberté artistique permet de capturer l'essence de la structure sans sacrifier son identité. Une fois que les caractéristiques identifiables, les détails subtils et la forme d'ensemble furent terminés, j'ai tourné mon attention vers le choix de la couleur qui représenterait le mieux le matériau de construction utilisé dans la vraie structure. Le choix de la couleur fut relativement facile, car le blanc était le choix évident pour représenter le marbre blanc italien de Carrare de la tour. »

Adam Reed Tucker

A stylized, handwritten signature in black ink, appearing to read 'Adam Reed Tucker'.

Le modèle de la tour penchée de Pise fut créé en collaboration étroite avec l'équipe de design LEGO. Ils regardent le modèle du point de vue de la construction LEGO et s'assurent que le processus de construction est simple et logique, et constitue une expérience positive pour l'utilisateur.

The ‘Scale Model’ line – LEGO Architecture in the 1960s

The history of the current LEGO Architecture series can be traced back to the beginning of the 1960s, when the popularity of the LEGO brick was steadily increasing. Godtfred Kirk Christiansen, the then owner of the company, began looking for ways to further expand the LEGO system and asked his designers to come up with a set of components that would add a new dimension to LEGO building.

Their answer was as simple as it was revolutionary: five elements that matched the existing bricks, but were only one third the height. These new building “plates” made it possible to construct more detailed models than before.

This greater LEGO flexibility seemed to match the spirit of the age; modernist architects were redefining how houses looked, and people were taking an active role in the design of their dream homes. It was from these trends that the LEGO ‘Scale Model’ line was born in early 1962.

The name itself was a direct link to the way architects and engineers worked, and it was hoped that they and others would build their projects ‘to scale’ in LEGO elements. As with LEGO Architecture today, the original sets were designed to be different from the normal, brightly colored LEGO boxes, and also included ‘An Architectural Book’ for inspiration.

Though the five elements remain an integral part of the LEGO building system today, the ‘Scale Model’ line was phased out in 1965. Many of the principles from the series would re-emerge over 40 years later in the LEGO Architecture series we know today.



La gamme des « Maquettes à l'échelle » - LEGO Architecture dans les années 1960

L'histoire de l'actuelle série LEGO Architecture remonte au début des années 1960 lorsque la popularité de la brique LEGO augmentait toujours. Godtfred Kirk Christiansen, alors propriétaire de la société, commença à rechercher des façons d'étendre le système LEGO et demanda à ses designers de trouver un ensemble de nouveaux composants pour ajouter une nouvelle dimension à la construction LEGO.

Leur réponse fut aussi simple que révolutionnaire : cinq éléments qui correspondaient aux briques existantes, mais trois fois moins hauts. Ces nouvelles « plaques » de construction ont permis de construire des modèles plus détaillés que par le passé.

Cette plus grande flexibilité LEGO semblait correspondre à l'esprit de l'époque, alors que les architectes modernes redéfinissaient les maisons, et que les gens s'intéressaient activement à la conception de la maison de leurs rêves. C'est à partir de ces tendances que la gamme « Maquettes à l'échelle » vit le jour au début de 1962.

Le nom lui-même était un lien direct avec la façon dont les architectes et les ingénieurs travaillaient, en espérant qu'ils allaient, ainsi que d'autres, construire leurs projets « à l'échelle » avec des éléments LEGO. Comme avec LEGO Architecture aujourd'hui, les ensembles originaux étaient conçus pour être différents des boîtes LEGO normales aux couleurs vives, et incluaient aussi « un livret d'architecture » comme source d'inspiration.

Ces cinq éléments font toujours partie du système de construction LEGO actuel mais la gamme « Maquettes à l'échelle » fut interrompue en 1965. Il fallut 40 ans pour que ses principes reprennent vie dans la série LEGO Architecture que nous connaissons aujourd'hui.

Architect series

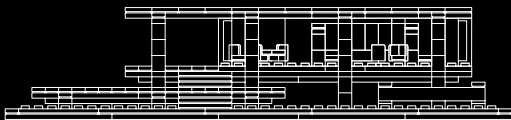
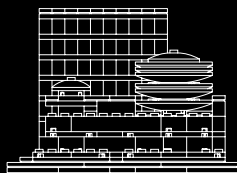
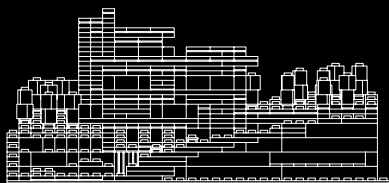

Série Architecture

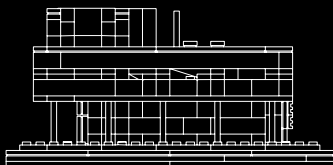
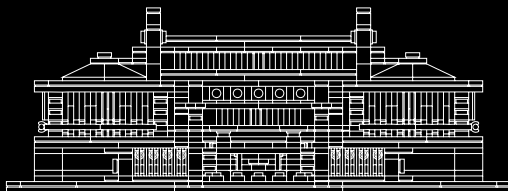

Landmark series

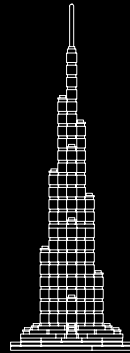
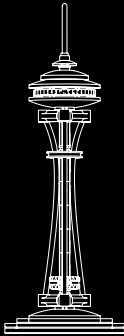
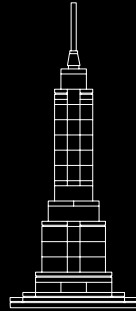
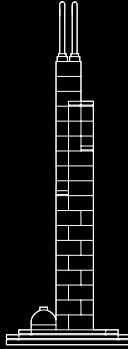
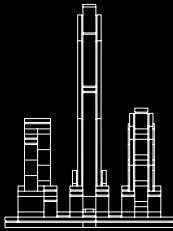

Série Édifices historiques

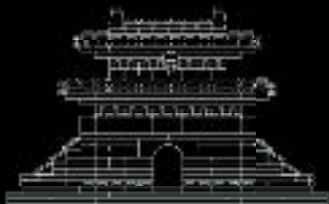
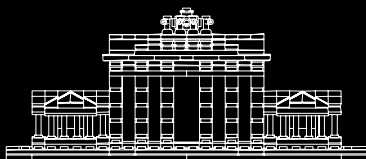
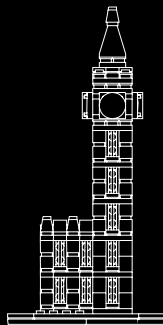
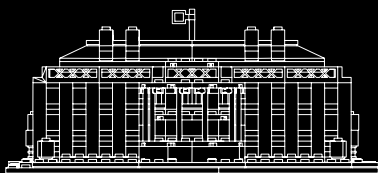

References

Text credits:

www.leaningtowerofpisa.net

www.towerofpisa.info

en.wikipedia.org

Photo credits:

www.shutterstock.com

www.gettyimages.com

en.wikipedia.org

Références

Crédits textes :

www.leaningtowerofpisa.net

www.towerofpisa.info

en.wikipedia.org

Crédits photos :

www.shutterstock.com

www.gettyimages.com

en.wikipedia.org

Customer Service
Kundenservice
Service Consommateurs
Servicio Al Consumidor

www.lego.com/service or dial



00800 5346 5555 : 

1-800-422-5346 : 



10x
300501



19x
4287153



2x
4211415



10x
4143005



1x
4143137



28x
614101



1x
4211414



5x
302326



86x
306201



1x
4558956



2x
4244627



4x
306926



2x
4567449



1x
4260409



4x
4558170



2x
614301



6x
4515347



2x
4211445



3x
416226



1x
654101



8x
4163987



9x
4560183



1x
6036556



35x
4520970



2x
4211837



4x
244526



48x
302401



1x
395701



8x
4211549



1x
4654448



11x
362301



10x
4526981



3x
4251149



3x
4210998



1x
306901



2x
4211399



2x
4211360



1x
4210802



3x
4535737



2x
4211451



Architecture

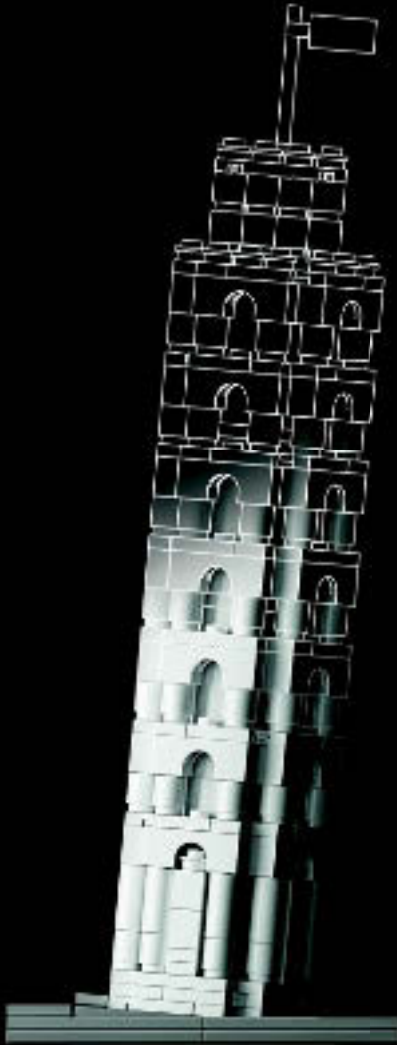

LEGO and the LEGO logo are trademarks of the/
LEGO et le logo LEGO sont des marques de commerce de/
son marcas registradas de LEGO Group. ©2013 The LEGO Group. 6049008



www.LEGO.com