



# Architecture

## Marina Bay Sands®

Republic of Singapore

滨海湾金沙®

新加坡共和国



## Marina Bay Sands®

Conceived by renowned architect Moshe Safdie and made possible by state-of-the-art construction engineering, the iconic Marina Bay Sands® is the new 10 million square-foot (929,000 m<sup>2</sup>) waterfront gateway to Singapore. Opened in early 2011, it's the centerpiece of the city-state's progressive urban renewal strategy.

## 滨海湾金沙®

滨海湾金沙®酒店由著名建筑师摩西·萨夫迪设计，利用最先进的建造技术打造而成，占地1000万平方英尺（929000 平米），是新加坡的全新滨海地标性建筑，同时也是通向新加坡的大门。酒店于2011年年初开业，属于新加坡积极的城市改造战略的核心构成。



# History

Located at Singapore's southern tip, the Marina Bay Sands® development was designed to seamlessly extend Singapore's downtown district and underline the city-state's continuing ambition to be Asia's major business and cultural hub.

The idea for an artificial bay was first raised in the late 1960s, but it was only made possible by an extensive program of land reclamation that took over 20 years to complete.

With Singapore's signature city skyline as a backdrop, Marina Bay was envisioned as a "Garden City by the Bay", a high-density development with a wide range of commercial and cultural offerings for business people, tourists and local Singaporeans.

After a highly competitive design competition in 2006, the bid from the Las Vegas Sands Corporation and the

innovative design by Boston-based Safdie Architects was declared the winner.

Moshe Safdie, an architect who is renowned for creating architecture that responds to human needs and aspirations, instinctively understood that the Marina Bay Sands project was more than just a collection of buildings: "Marina Bay Sands is really more than a building project, it is a microcosm of a city rooted in Singapore's culture, climate, and contemporary life."

It was clear to him that this development, on the most prominent site in Singapore, was also a project of great national pride. His ambition therefore was to create "an architecture that was so strong and memorable that it would represent Singapore."



© Marina Bay Sands

[ The centerpiece of our redevelopment of the city is Marina Bay... It will be a city in our image, a sparkling jewel, a home for all of us to be proud of,

a home that will belong to all of us. ]

Lee Hsien Loong, Singapore Prime Minister, 2005

# 历史

滨海湾金沙<sup>®</sup>位于新加坡南端，其开发是为了无缝扩展中心市区，突显新加坡不断努力建设成为亚洲主要商务与文化中心的决心。

建造一个人工海湾的想法在 20 世纪 60 年代首次提出，不过却是在一项大规模的土地围垦计划制定后付诸实施，该计划费时 20 余年方完成。

滨海湾以新加坡著名的城市天际线为背景，被誉为“海湾上的花园城市”，其高密度的开发为商务人士、游客和本地新加坡人提供一系列商业和文化服务。

2006 年，经过一个竞争激烈的设计大赛后，来自拉斯维加斯金沙集团的投标和波士顿萨夫迪建筑公司的创新性设计脱颖而出。

摩西·萨夫迪是一位著名建筑师，注重在建筑中加入满足人类需求和渴望的元素，他本能地明白滨海湾金沙项目绝不仅仅是一堆建筑的组合而已：“滨海湾金沙不仅仅是一个

建筑项目；它是植根于新加坡文化、气候和现代生活的城市缩影。”

萨夫迪也很清楚，既然这个开发项目选址于新加坡最显著的位置，它也会成为激发民族自豪的大工程。于是，他的目标就是打造“一处风格独特，具有纪念意义，可代表新加坡的建筑物。”

[城市重新开发的核心构成是滨海湾。...它将成为一座我们心中理想的城市区，一颗璀璨的明珠，一个所有人为之骄傲同时属所有人的家。]

新加坡总理李显龙，2005年

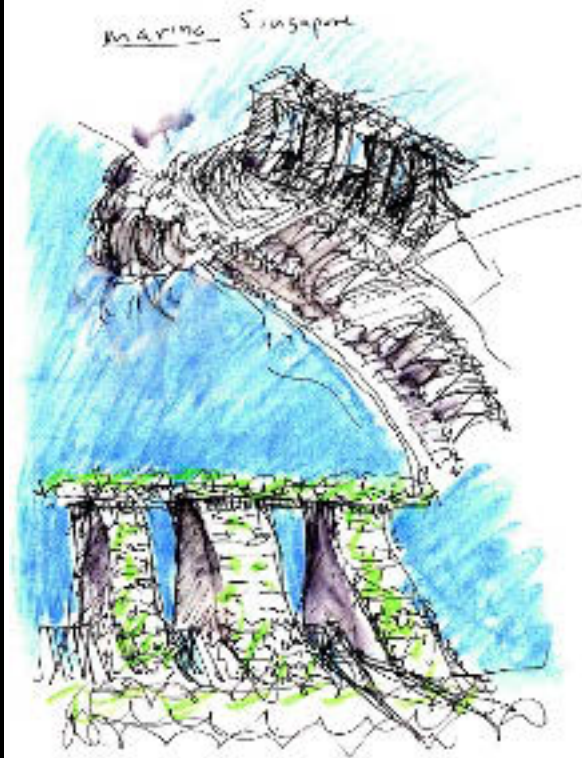

# Design & Construction

From the outset, the goal for the Marina Bay Sands development was to create a new form of urban center. It would be a dynamic setting for a vibrant public life: connected with nature, climatically sustainable and on a human scale.

The first decision was to create a promenade that extended along the waterfront, opening up the whole development to the pedestrian. As well as 800,000 sq.ft. (74,000 m<sup>2</sup>) of retail arcades, a network of public paths would connect two theaters, a casino and a 96,000 sq.ft. (9,000 m<sup>2</sup>) convention and exhibition center. A 54,000 sq.ft. (5,000 m<sup>2</sup>) hydraulically adjustable public piazza was also created to provide a platform for a wide array of public activities.

A series of layered gardens were designed to provide ample green space throughout Marina Bay Sands development. Every level of the district has green areas

that are accessible to the public and at least half of the roofs of the hotel, convention center, shopping mall and casino complex are planted with trees and gardens.

The two architectural signature pieces of the development are the hotel complex and the ArtScience Museum. While it would have been more efficient to build a single hotel tower, the architect team recognized that such a building would form a wall-like barrier between the downtown and the sea across to the east. Seen from incoming cruise liners, a single tower would also have blocked the view of the city, so it was quickly decided to split the hotel into three 55-storey towers.

Running out of space for parks, gardens and swimming pools, the architects invented the idea of a SkyPark, a 2.5 acre (1 hectare) engineering marvel that connects the three towers at a height of 656 ft. (200 m) and cantilevers 213 ft. (65 m) out at one end.



## 设计与建设



© Marina Bay Sands

从一开始，滨海湾金沙<sup>®</sup>开发项目的目标就是打造一个全新形式的市中心。它将为城市公共生活提供一处动态环境：融入自然、气候上可持续并充满人性化特色。

首先就决定了建设一个散步区，一直延伸到海滨，将整个开发项目向所有行人开放。除了 800,000 平方英尺 (74,000 平米) 的零售商场外，由各条小路组成的网络将连接两座剧院、一家赌场、一座 96,000 平方英尺 (9,000 平米) 的会议与展览中心。同时还建设了一处 54,000 平方英尺 (5,000 平米) 的液压可调节式公共广场，可为众多公共活动提供平台。

设计了多处分层花园，为整个滨海湾金沙项目提供葱葱的宽敞空间。每一个分区均有公众可进入的绿地；酒店、会议中心、购物中心、赌场综合体的楼顶至少一半将植上绿树，设置花园。

整个项目的两大建筑区块分别为酒店综合体和艺术科学博物馆。虽然建设一个单一的酒店大楼效率会更高，但建筑师团队意识到那样做将在市中心和大海之间直接竖起一座高墙

The SkyPark accommodates a public observatory, gardens, a 495 ft. (151 m) long swimming pool, restaurants and jogging paths, and offers sweeping panoramic views, a valuable resource in a dense city like Singapore. Shielded from the winds and lavishly planted with hundreds of trees, the SkyPark celebrates the original vision of Marina Bay Sands as the Garden City.

At the center of the Marina Bay Sands promenade experience stands the iconic ArtScience Museum. Designed to represent the spirit of Singapore, it explores the creative processes at the heart of art and science and their role in shaping modern society. Dubbed “the hand of welcome” by some and “the lotus” by others, the boldly designed structure houses 21 gallery spaces and has become a major venue for international touring exhibitions.



© Marina Bay Sands

似的屏障。从入港的邮轮上望过来，单个大厦也会阻挡城市风景，因此设计团队迅速决定将酒店分为 3 座 55 层的大厦。

公园、花园和游泳池占去了很多空间，建筑师想到了设计一个 SkyPark——一个 2.5 英亩 (1 公顷) 的工程奇观在 656 英尺 (200 米) 的高度将三座大厦连接起来，在一端还有 213 英尺 (65 米) 的悬臂。

SkyPark 内有一座公共观景台、花园、495 英尺 (151 米) 长的游泳池、餐厅和慢跑小径，在上面可纵览宏大的全景风光，是如新加坡这样高度密集城市内的宝贵资源。SkyPark 不受大风影响，种植了成百上千棵树木，为滨海湾金沙®打造原汁原味的花园城市景观。

在滨海湾步行体验中心树立著一座标志性艺术科学博物馆。其设计代表新加坡的精神，在艺术和科学的中心探索其创作过程及其在塑造现代社会中的作用。有人称博物馆为“迎客手”或“莲花”，其设计大胆出众，拥有 21 个展览空间，已成为国际巡回展览的重要场所。



## Marina Bay Sands® & Singapore

The Marina Bay Sands® development has placed Singapore on the world's architectural map. Since officially opening in early 2011, it has become a popular tourist destination and is expected to contribute an extra \$2.7 bn to the city-state's economy by 2015.

More importantly it has also proved popular with local Singaporeans who flock to the area to enjoy the relaxed garden city atmosphere, shop, or take part in the many cultural activities. For the architect, Moshe Safdie, this is the real success of the project:

“With Marina Bay Sands, I wanted to create a mixing bowl between Singapore and the world, a place that Singaporeans and tourists alike would enjoy and be inspired by. It appears that the design has succeeded in achieving this objective.”

## 滨海湾金沙® 与新加坡

滨海湾金沙®开发项目建成之后，新加坡即位列世界顶级建筑地图中。自 2011 年正式开放以来，它已成为广受欢迎的旅游目的地，到 2015 年预计可为新加坡经济再贡献 27 亿美元的收入。

更重要的是，该项目还受到本地新加坡人的青睐，他们到此享受花园城市的轻松氛围、购物或是参加众多的文化活动。对于建筑师摩西·萨夫迪而言，这才是该项目真正的成功之处：

“我想借助滨海湾金沙打造一个连接新加坡和世界的‘搅拌桶’，让新加坡人和游客都能够欣赏并喜爱。现在看来，我的设计已成功实现了这一目标。”

# The Architect

Moshe Safdie is a renowned architect, urban planner, educator, theorist, and author. Embracing a humane design philosophy, Safdie is committed to architecture that is defined by the geographic, social, and cultural elements of an area and that responds to human needs and aspirations.

Born in Haifa, Israel, in 1938, Safdie moved to Canada with his family at a young age. He graduated from McGill University in 1961 with a degree in architecture. After apprenticing with Louis I. Kahn in Philadelphia, Safdie

returned to Montreal to oversee the master plan for the 1967 World Exhibition. In 1964 he established his own firm to realize the iconic Habitat '67, an adaptation of his thesis at McGill, which was the central feature of the World's Fair and a groundbreaking design in the history of architecture. Safdie has completed a wide range of projects, such as cultural, educational, and civic institutions; neighborhoods and public parks; mixed-use urban centers and airports; and master plans for existing communities and entirely new cities around the world.

[ Through nature, the nature of the universe and the nature of man, we shall seek truth.

If we seek truth we shall find beauty. ]

Moshe Safdie



## 建筑师简介

摩西·萨夫迪是一位著名的建筑师、城市规划师、教育家、理论家和作家。萨夫迪秉承符合人文的设计理念，致力于在建筑物中融入地理、社会和文化元素，满足人们的需求和渴望。

1938 年萨夫迪出生在以色列的海法，很小的时候就随家人移民至加拿大。1961 年，他毕业于麦吉尔大学，获得了建筑学学位。在跟著宾夕法尼亚州费城的路易·卡恩实习了一段时间后，萨夫迪回到蒙特利尔负责 1967 年世界博览会的总体规划。1964 年他成立了自己的公司，根据在麦吉尔大学所写的论文打造了标志性建筑 Habitat ' 67，这是当年世界博览会最吸引人的场馆，是建筑史上具有突破性的设计。萨夫迪完成过无数项目，包括文化、教育和市政机构，住宅楼和公园，多用途城市中心和机场，以及世界各地已有社区和全新城市的总体规划。

[我们将在自然中，在宇宙和人类的本质中寻找真理。

找到了真理，就发现了美。]

摩西·萨夫迪



© Stephen Kelly

Moshe Safdie

# Facts about Marina Bay Sands®

Location: .....	Singapore
Architects: .....	Moshe Safdie, Safdie Architects, Boston
Client: .....	Marina Bay Sands Pte. Ltd. (a subsidiary of the Las Vegas Sands Corporation)
Site Area: .....	1,668,000 sq.ft. (154,938 m <sup>2</sup> )
Gross Floor Area: .....	6,258,000 sq.ft. (581,400 m <sup>2</sup> )
Total Area: .....	9,096,000 sq.ft. (845,000 m <sup>2</sup> )
Height: .....	57 stories / 640 ft. (195 m)
Total Cost: .....	US \$5.7 billion, including land cost

## 滨海湾金沙®相关情况

地点: .....	新加坡
建筑师: .....	波士顿萨夫迪建筑公司，摩西·萨夫迪
客户: .....	滨海湾金沙私人有限公司（拉斯维加斯金沙集团子公司）
占地面积: .....	1,668,000 平方英尺（154,938 平方米）
建筑面积: .....	6,258,000 平方英尺（581,400 平方米）
总面积: .....	9,096,000 平方英尺（845,000 平方米）
高度: .....	57 层/640 英尺（195 米）
总成本: .....	57 亿美元，包括土地费用





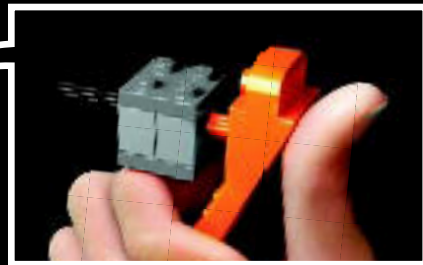
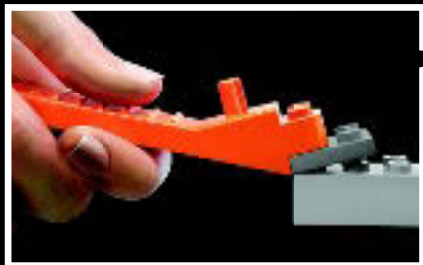

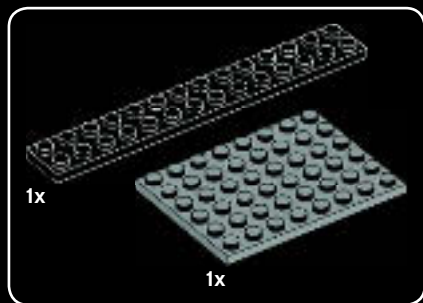

1

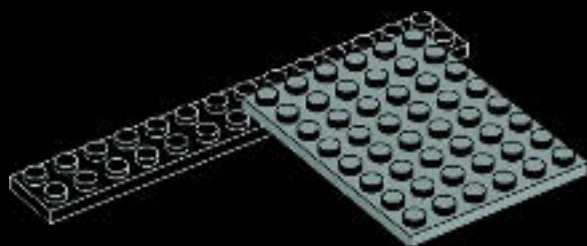

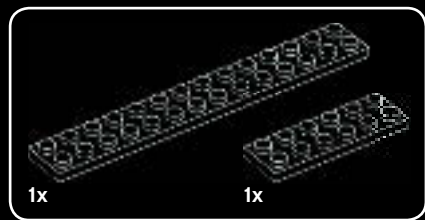

2

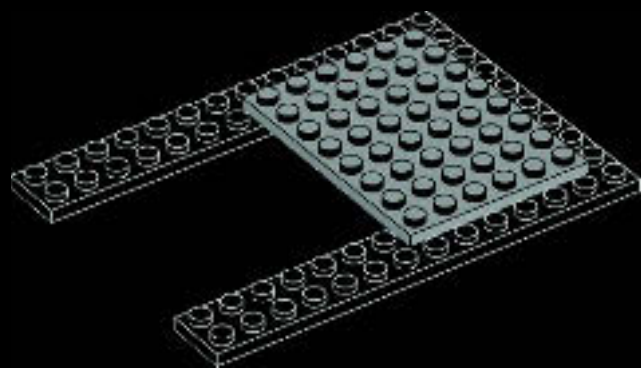

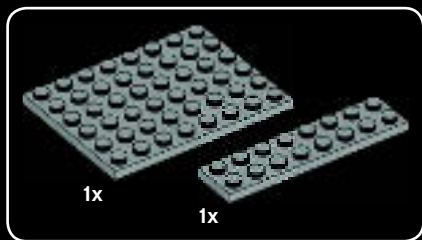

3

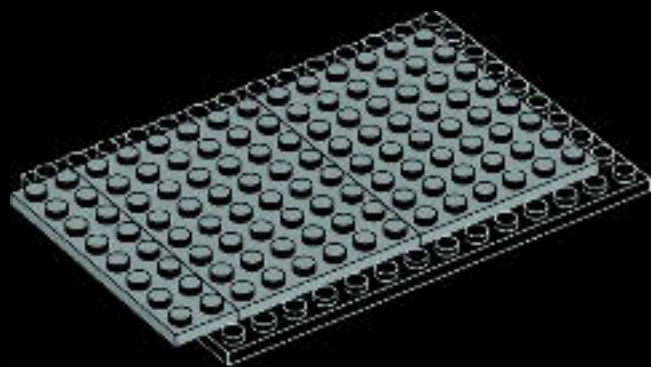

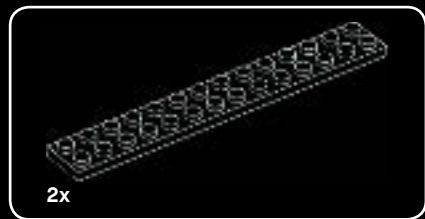

4

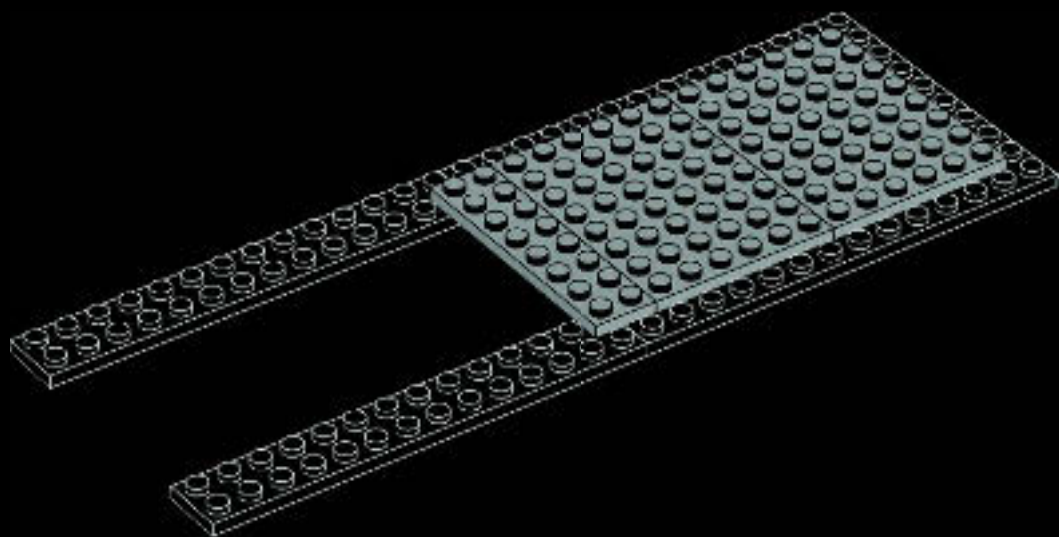

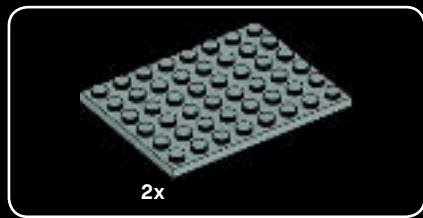

5

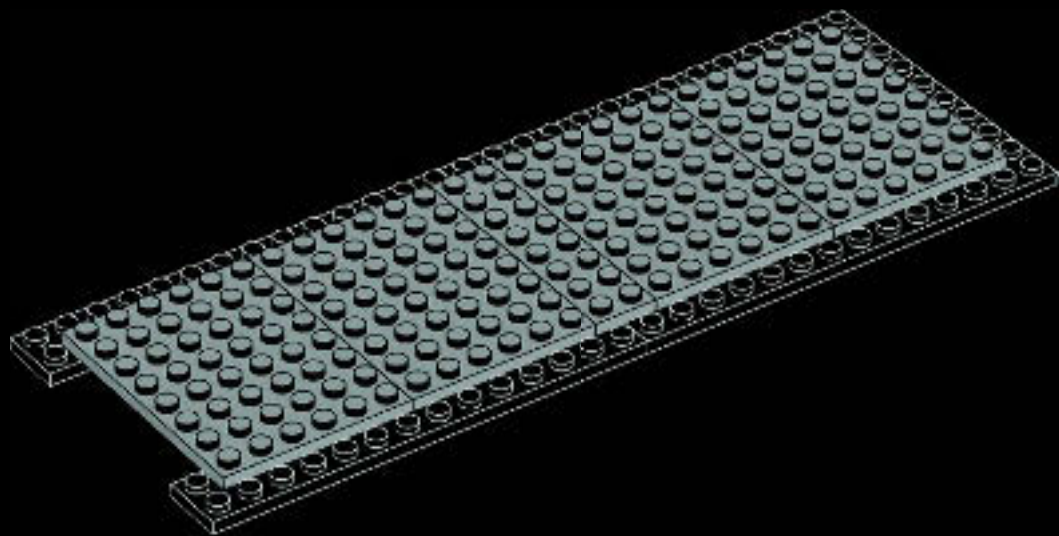



1x

6

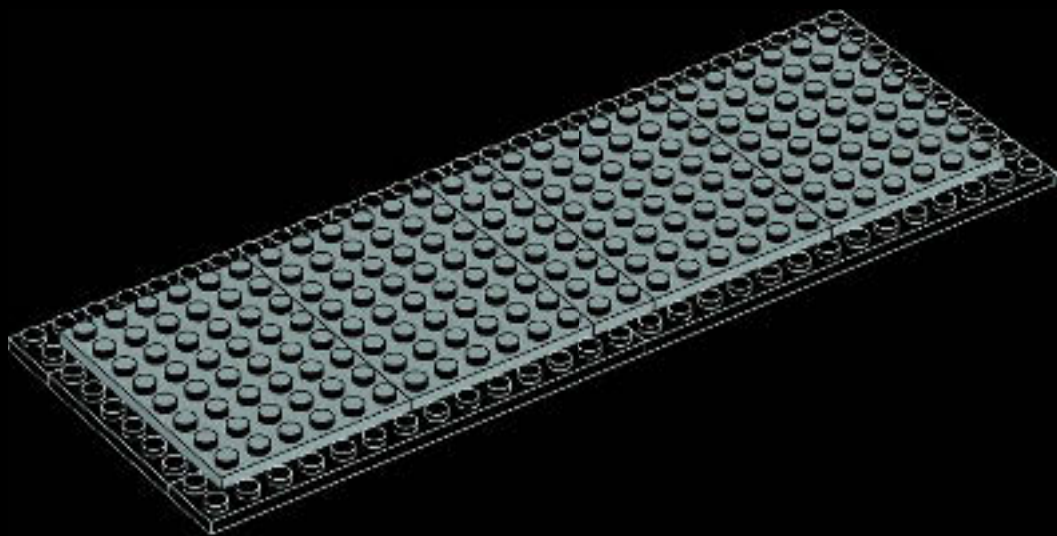



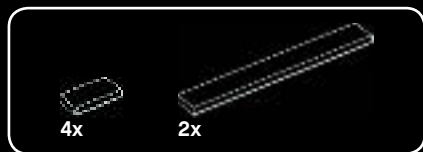

7

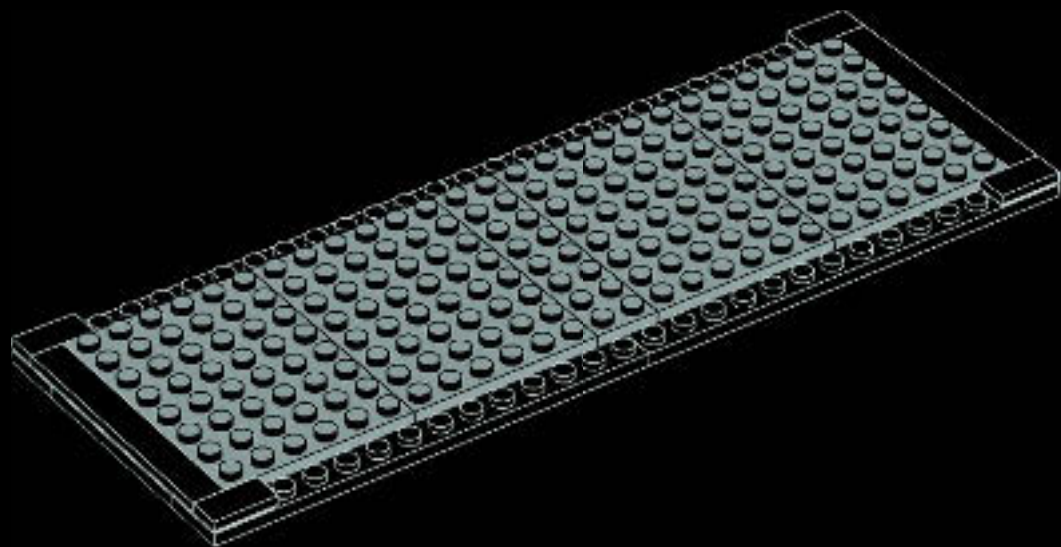

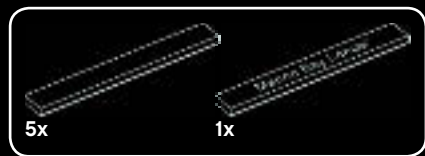

8

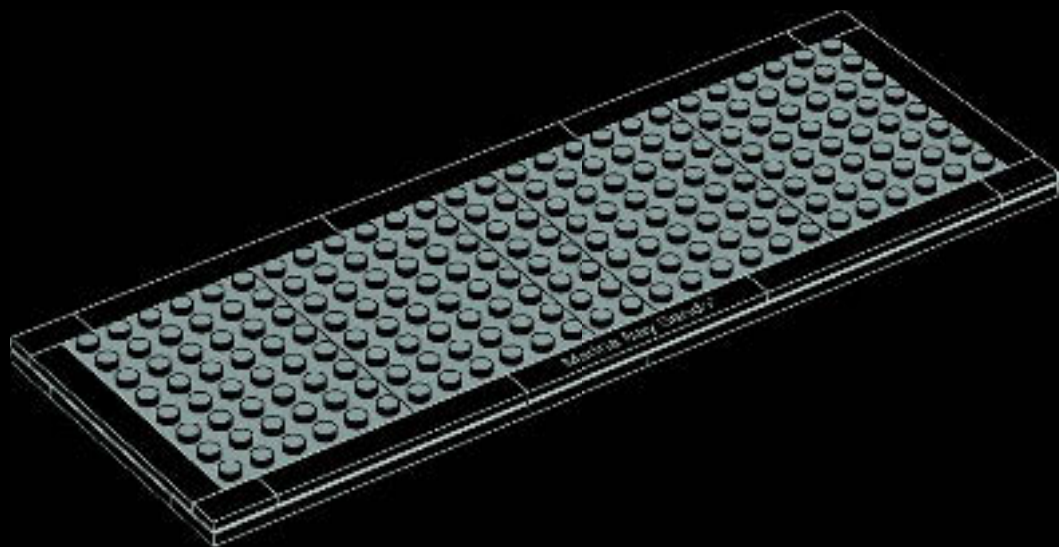



14x

9

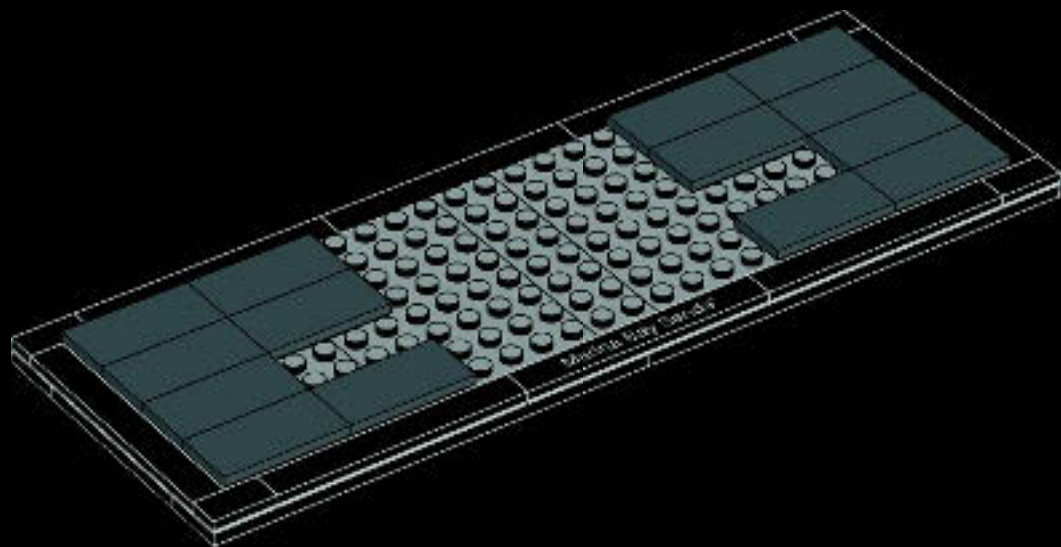



2x



2x

# 10

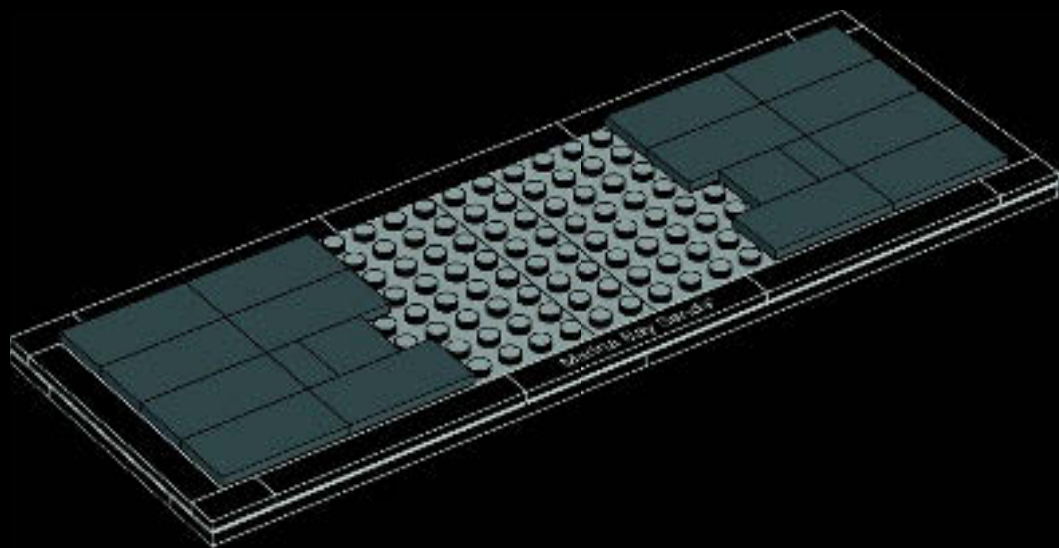



4x



4x

# 11

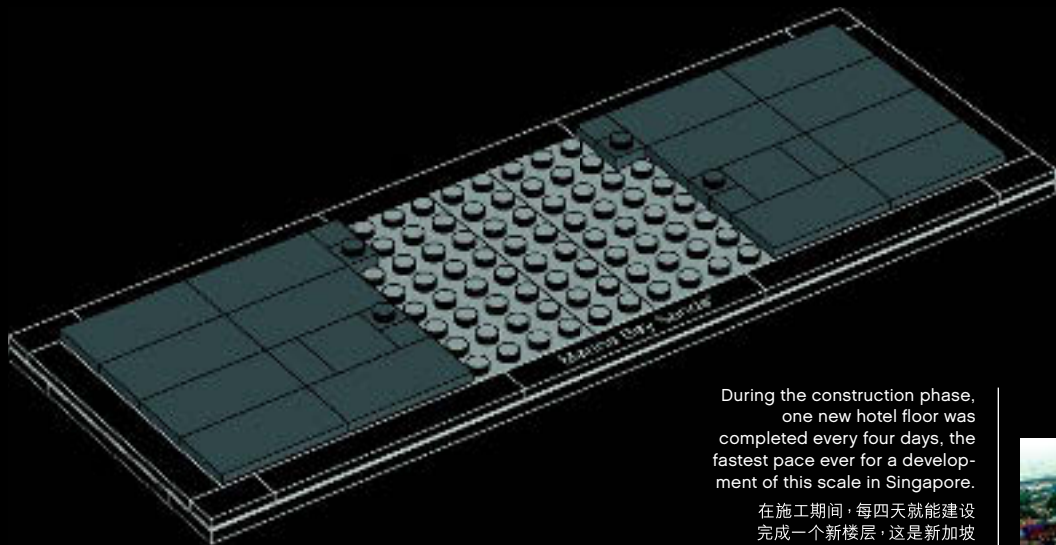

During the construction phase, one new hotel floor was completed every four days, the fastest pace ever for a development of this scale in Singapore.

在施工期间，每四天就能建设完成一个新楼层，这是新加坡同等规模的开发项目中建设速度最快的。



© Marina Bay Sands



6x

12

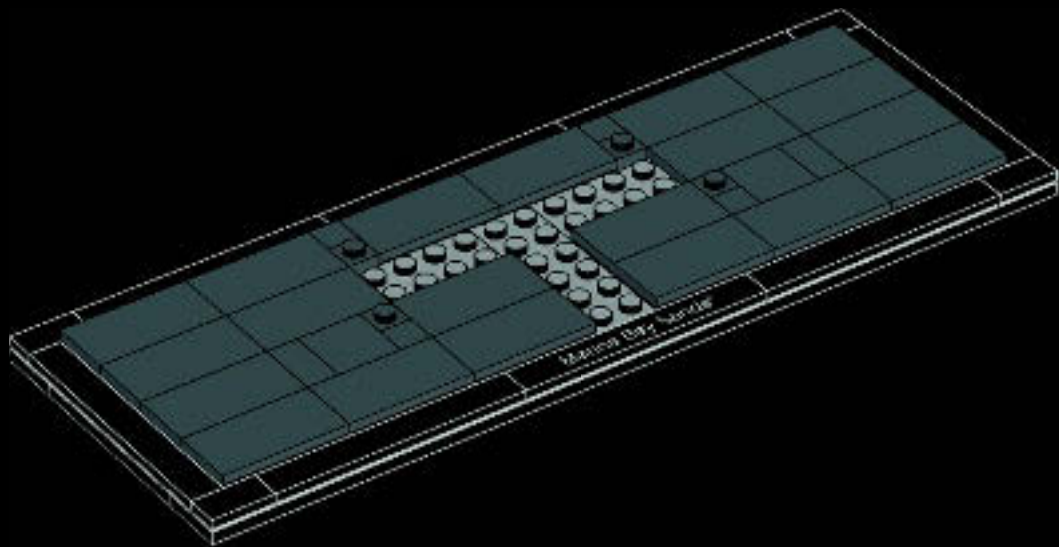



# 13

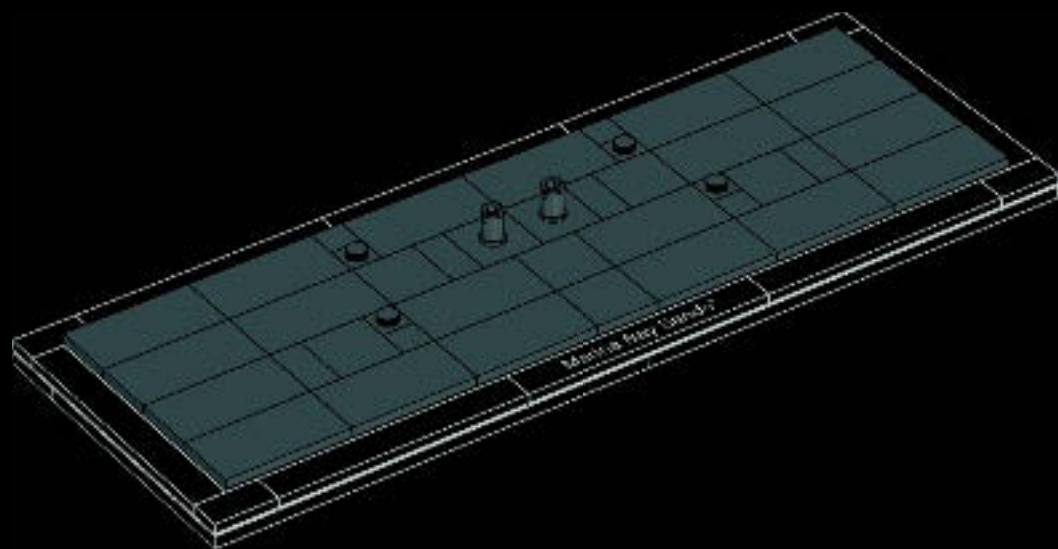

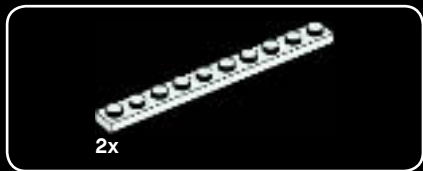
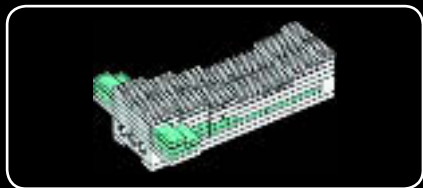

2x

1



1x

2x

2







3

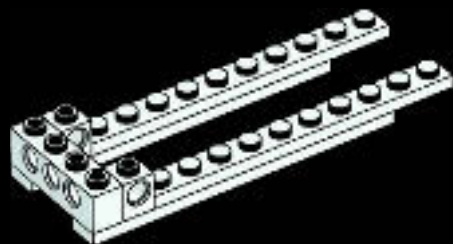

4

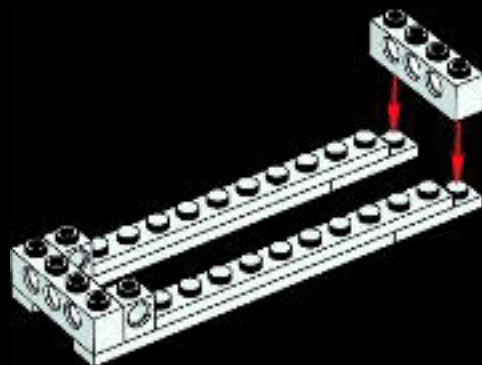



10x

5

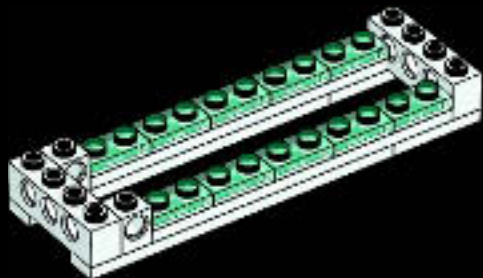



6

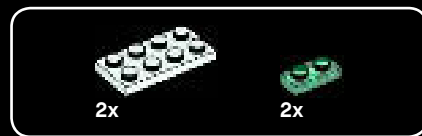
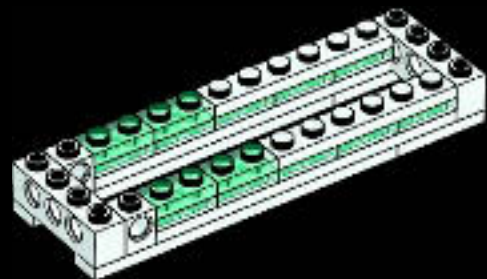

7

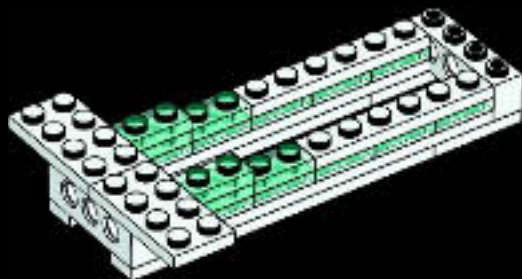



8

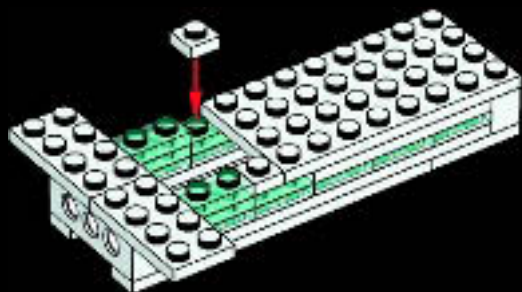

9

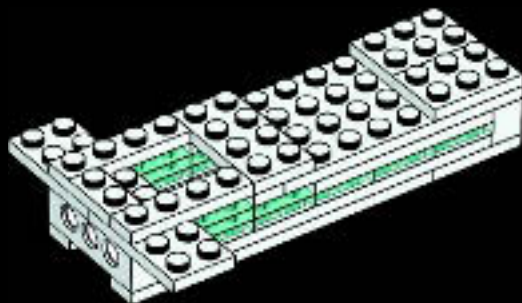



4x

10

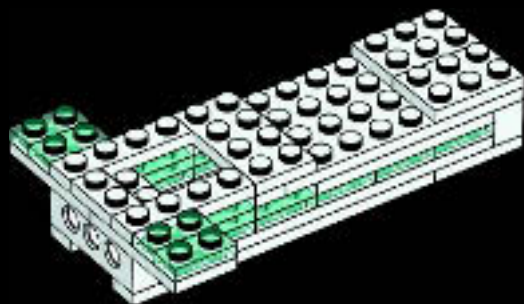

2x



3x



1x



1x

11

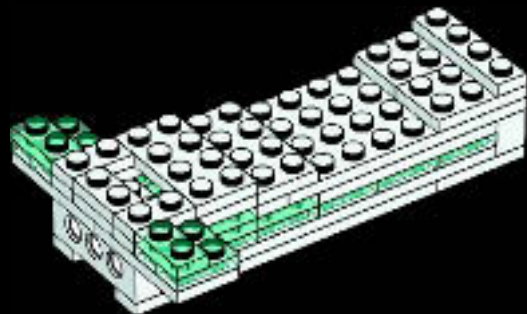



12

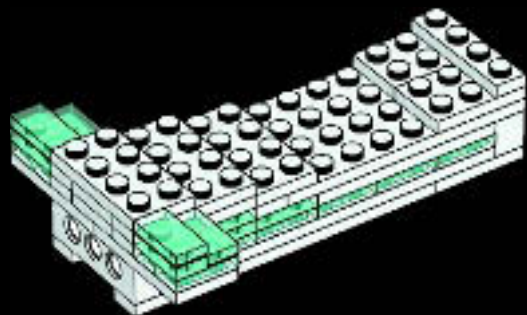

13

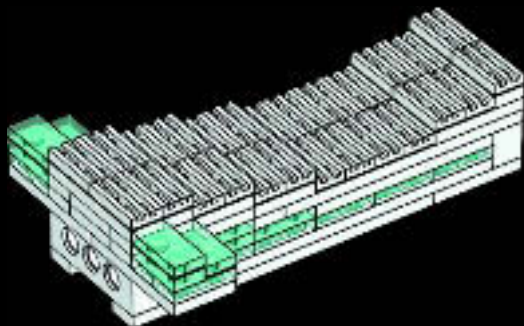

14

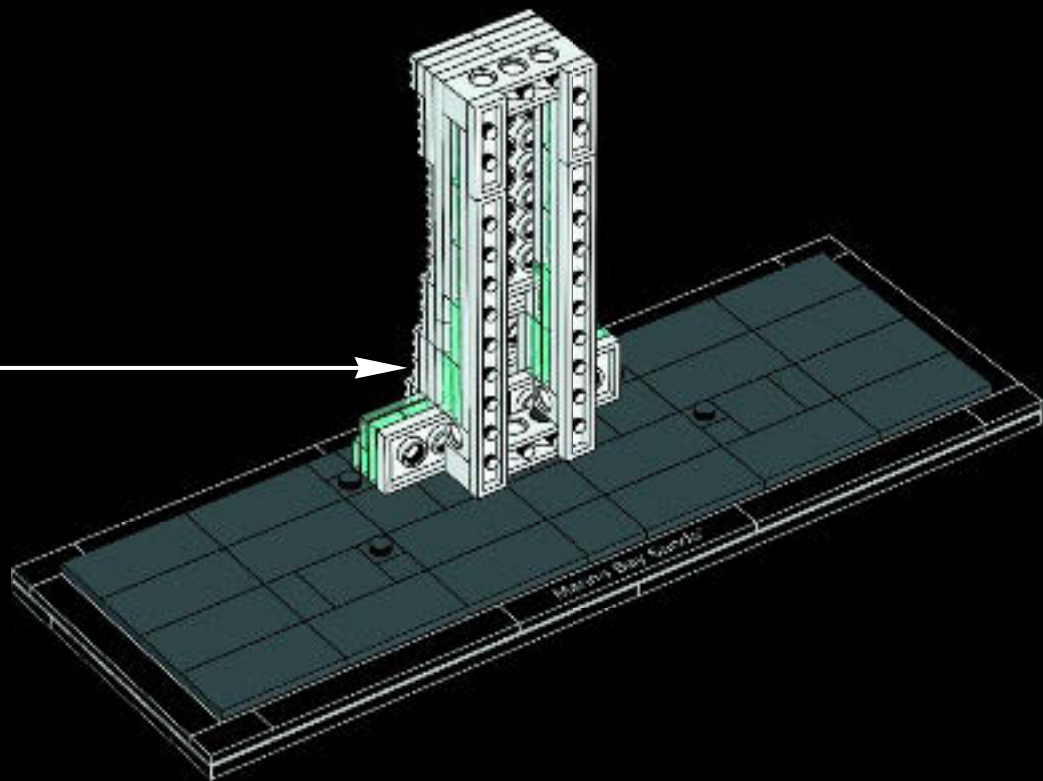



# 15

## 1



## 2

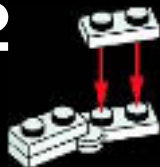

## 3



## 4

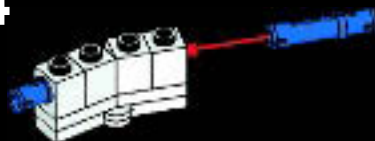

# 2x



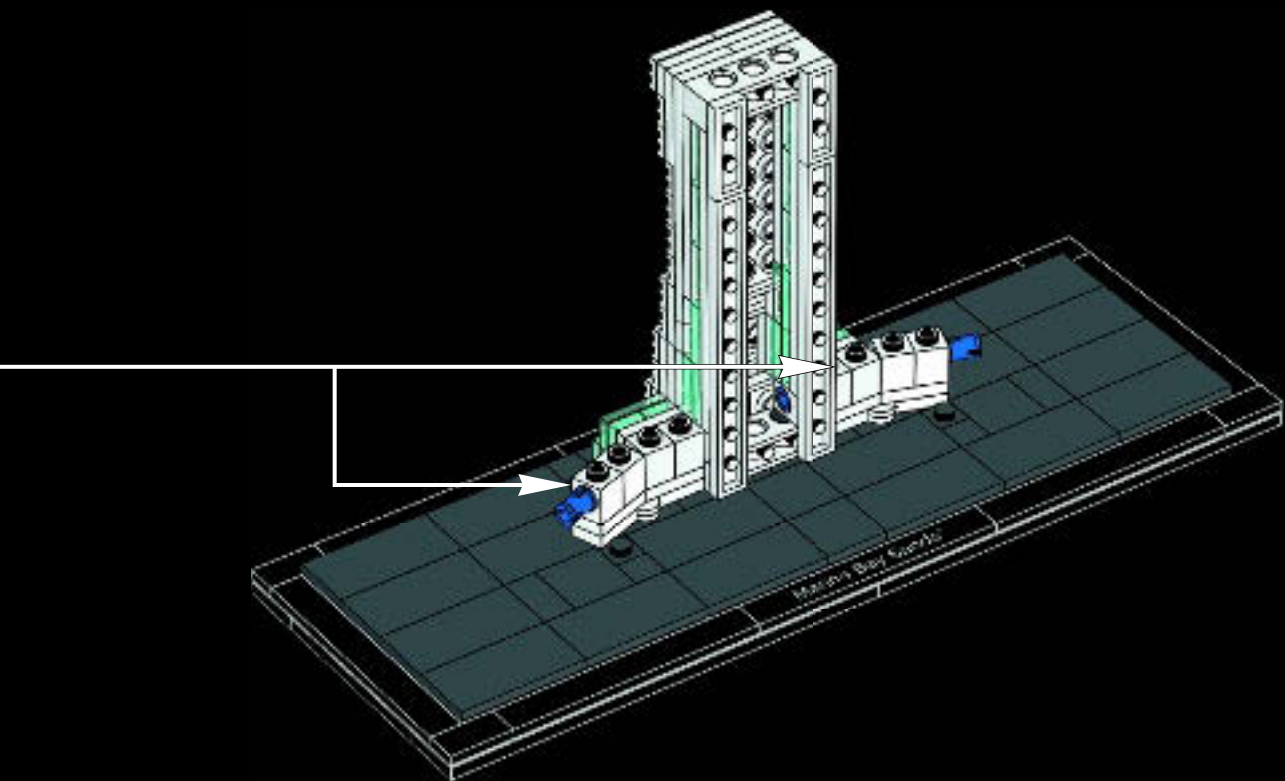

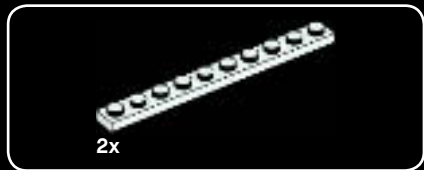
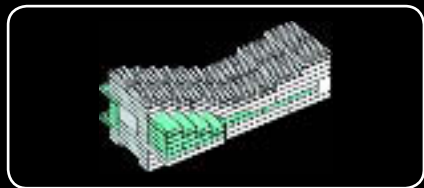

2x

1



1x

1x

1x

2

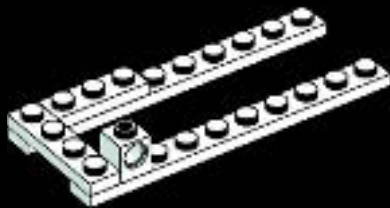

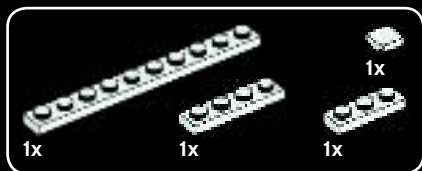

3

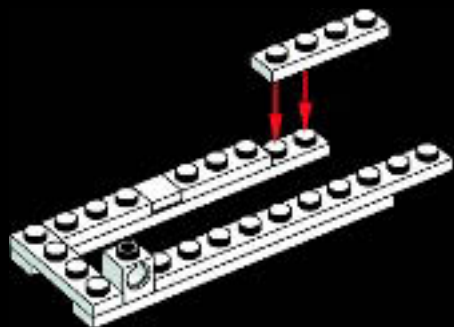

4

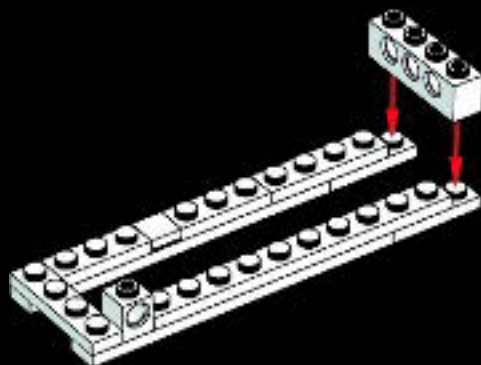



3x



1x

5

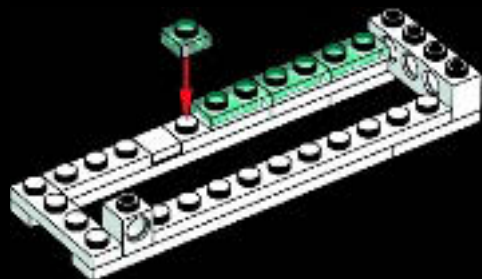

1x



8x

6

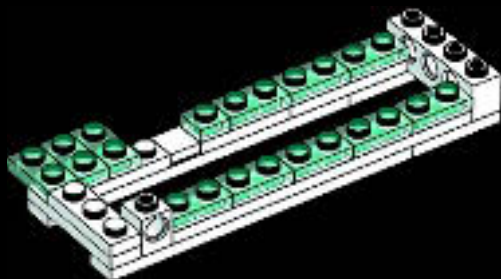



7

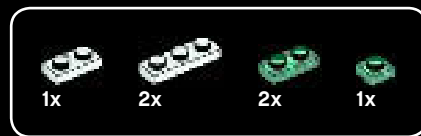
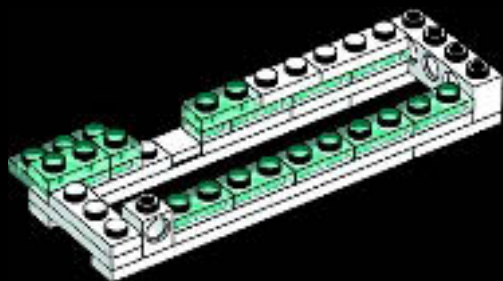

8

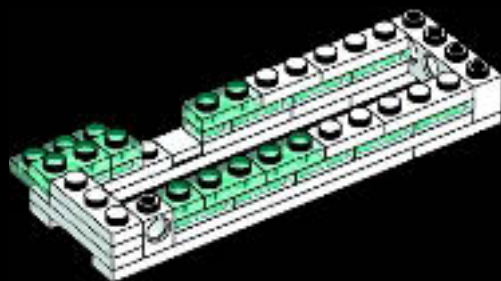

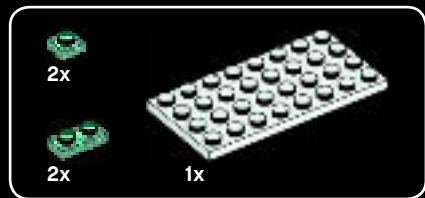

9

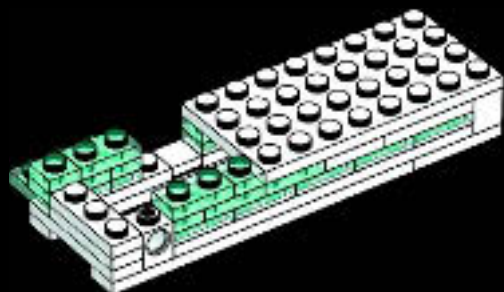



# 10

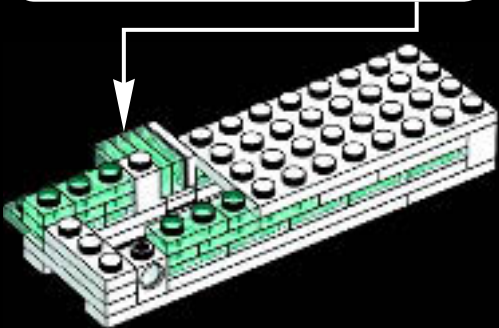
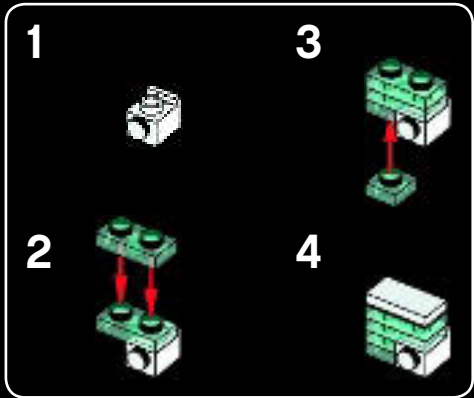



1x



1x

11

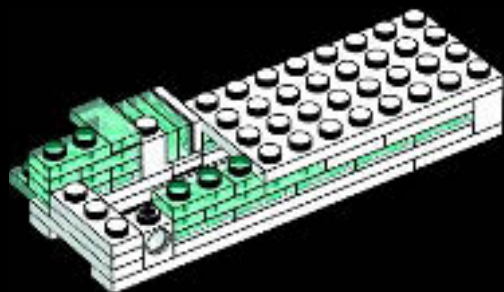





1x



1x

# 12

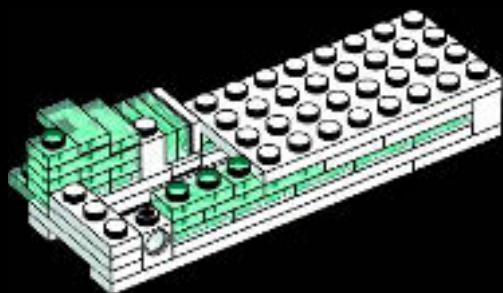

1x



1x

# 13

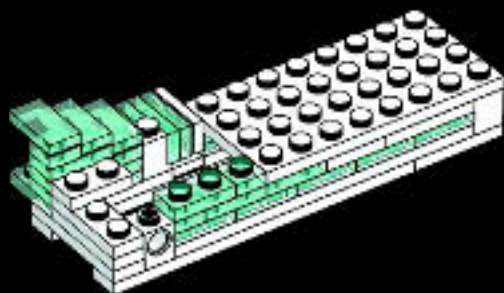

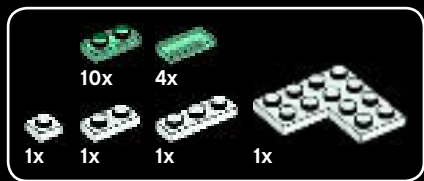

14

1



2



3



4



5



6

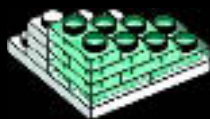

7

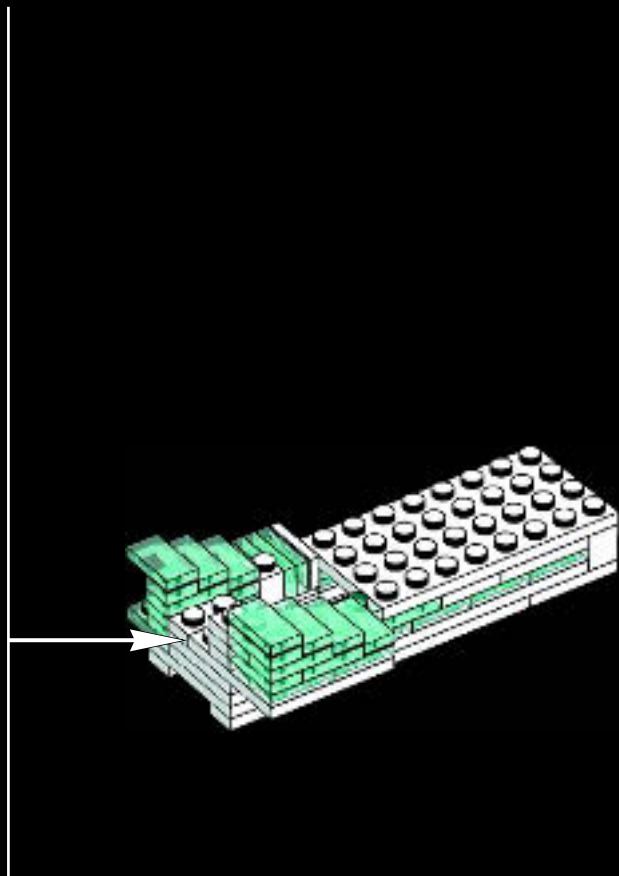
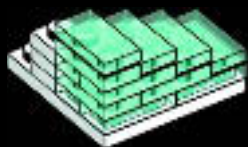



1x



2x

# 15

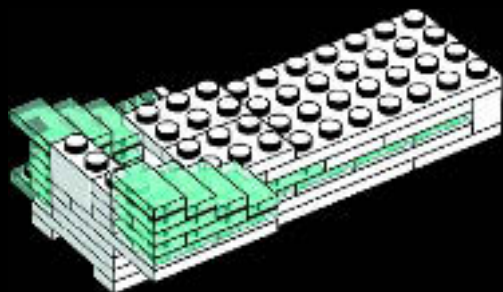

2x

# 16

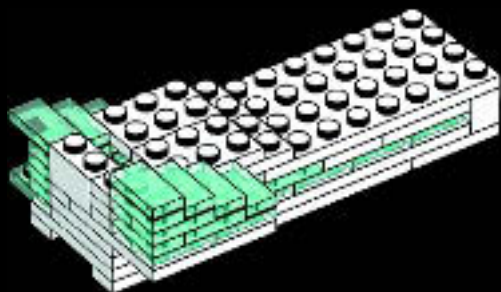



2x

17

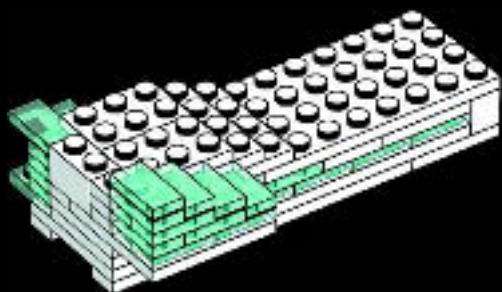

2x

18

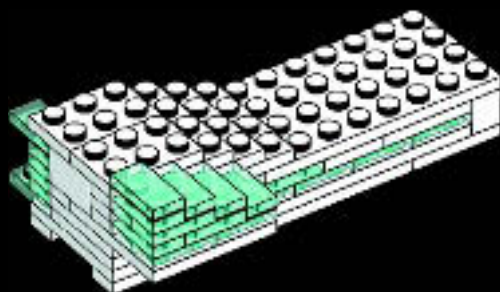



3x

19

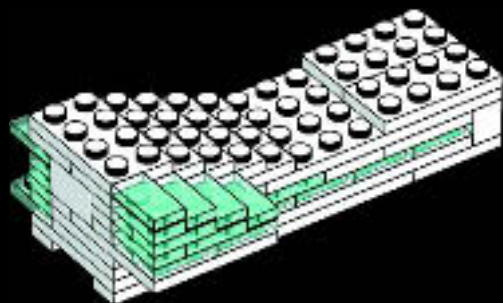

1x



1x

20

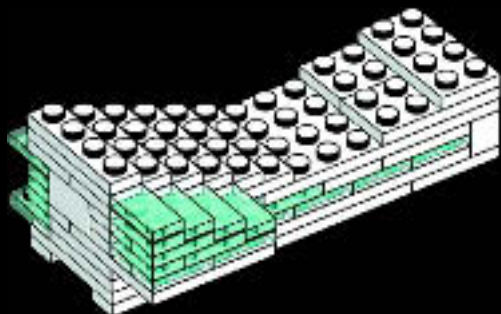



26x

21

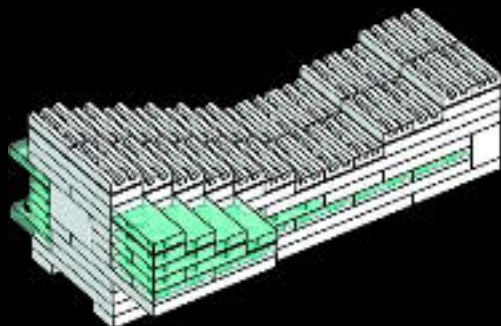

16

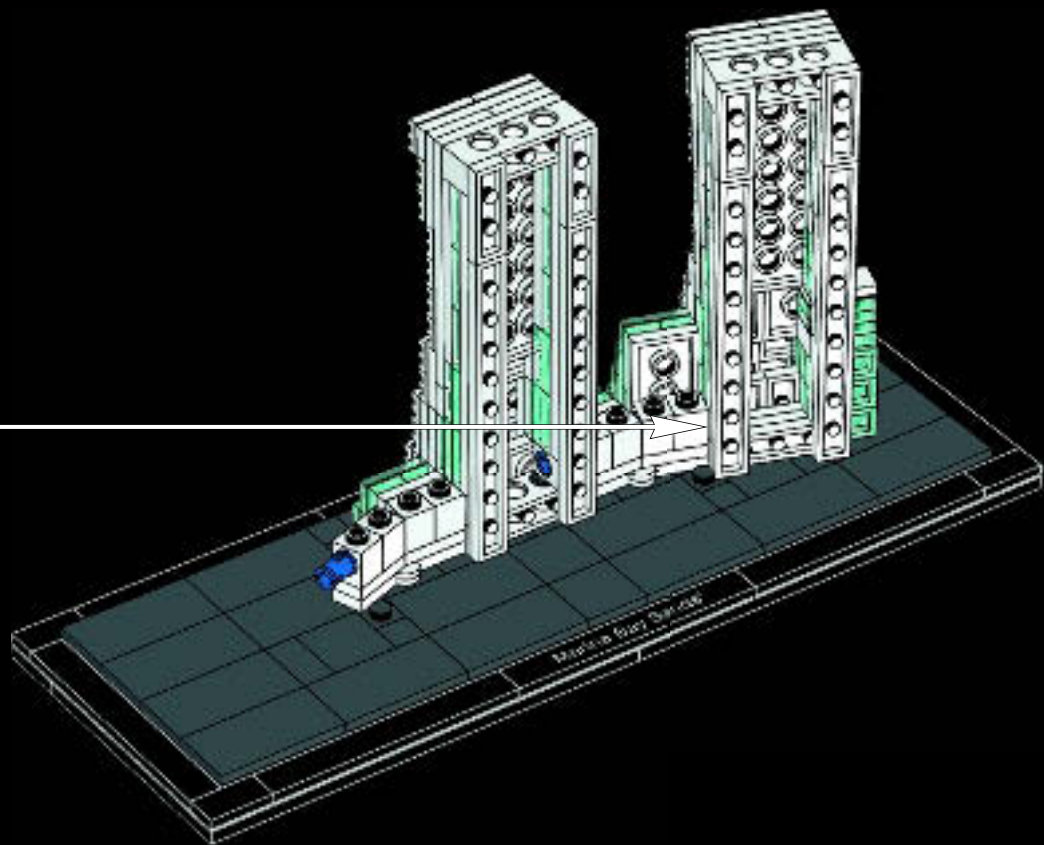

56



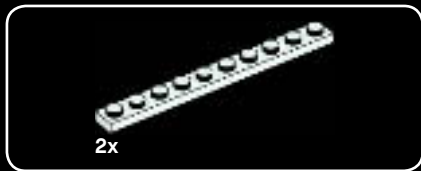
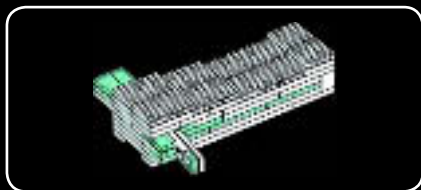

1



2

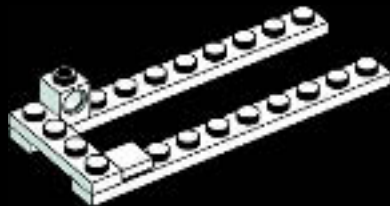

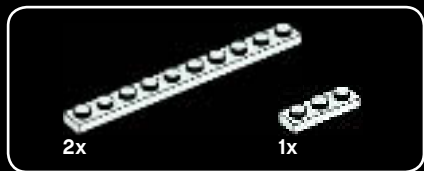

3

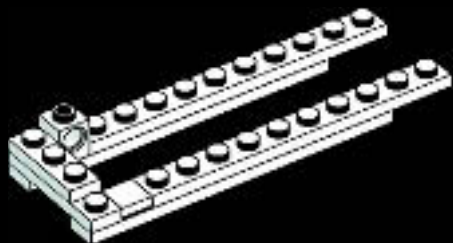

4

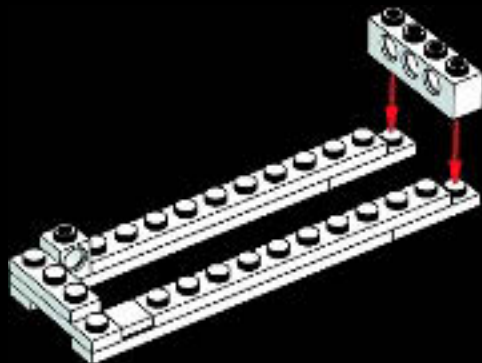



10x

5

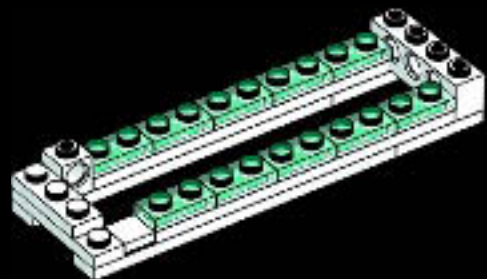

3x



2x



2x



2x

6

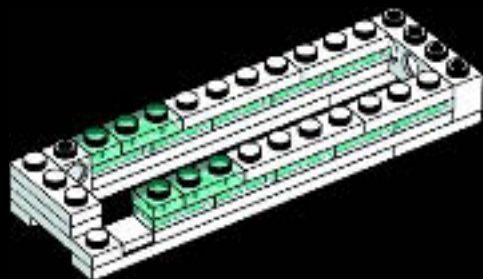



7

1



2



3



4



5

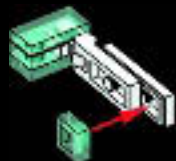

6

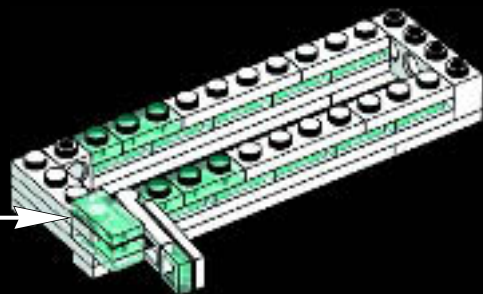

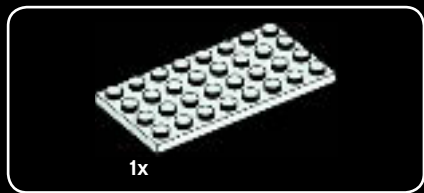

8

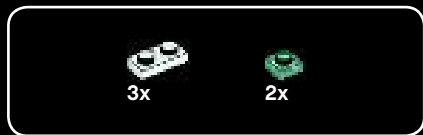
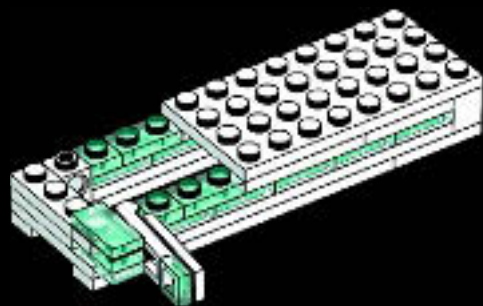

9

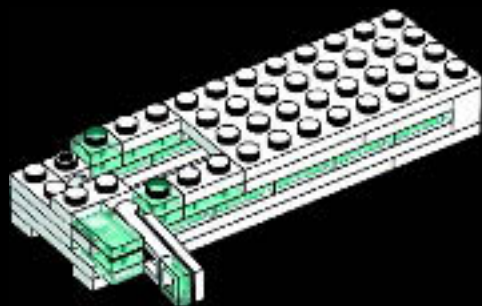



10

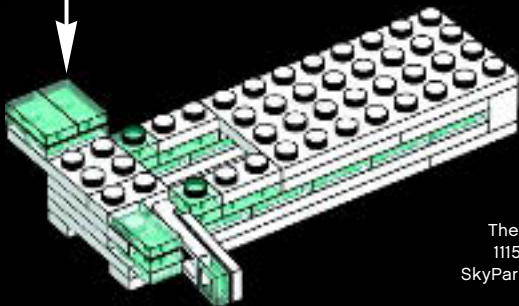

The 125 ft. (38 m) wide and 1115 ft. (340 m) long Sands SkyPark is the world's longest habitable cantilevered observation deck.

125 英尺宽 (38 米)、1,115 英尺长 (340 米) 的金沙 SkyPark 是世界上最长的适合居住的悬臂式观景台。



© Marina Bay Sands



4x

11

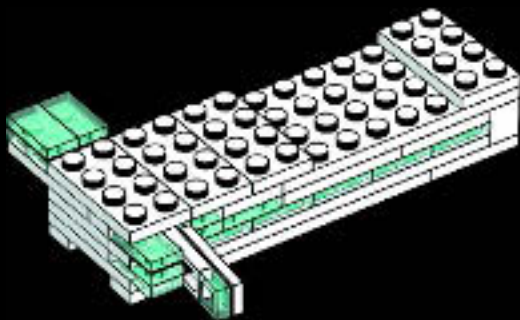





2x

12

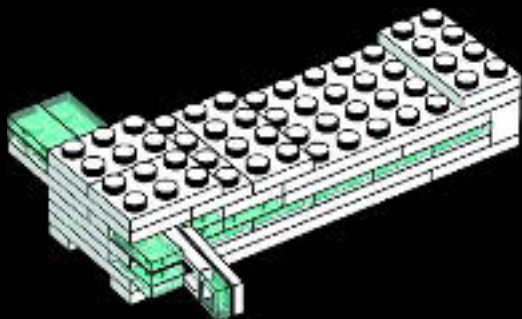

26x

13

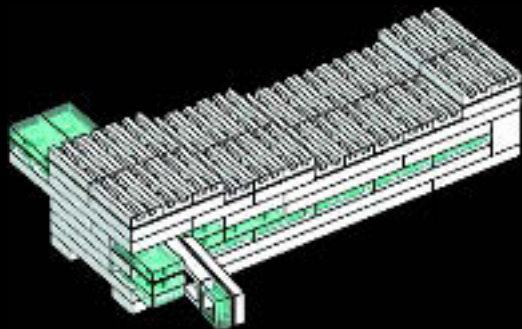

17





18

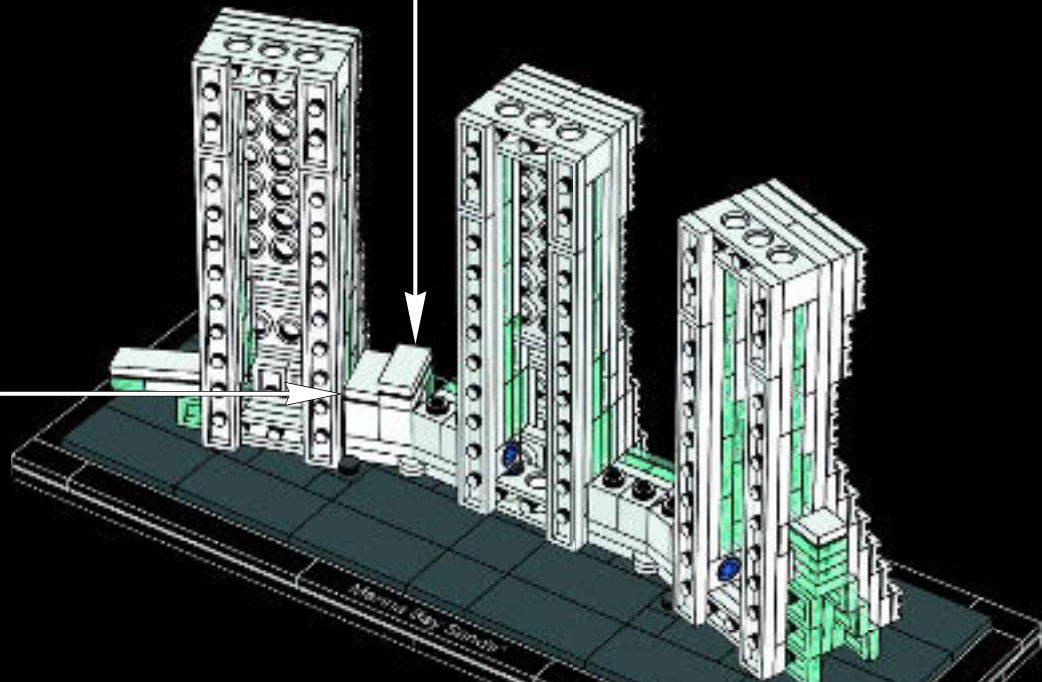



# 19

1



2



3



4







# 20



2



3



4



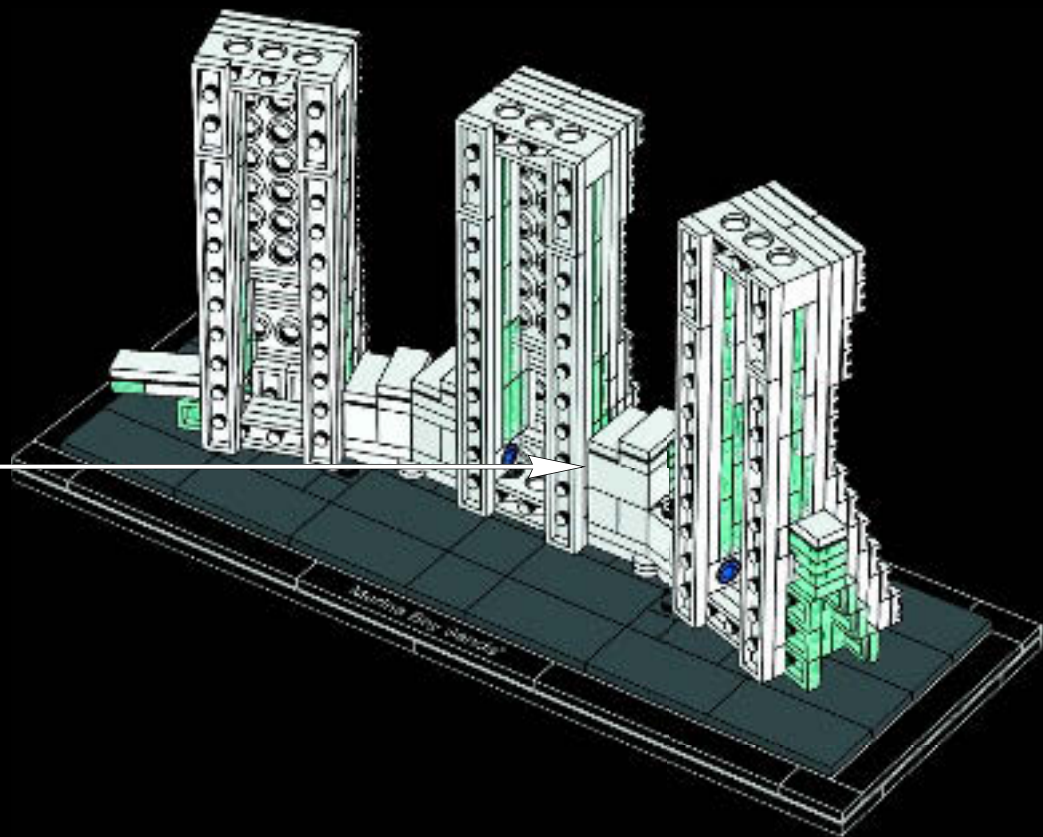

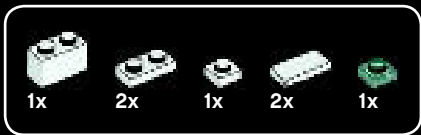

# 21

1



2



3



4

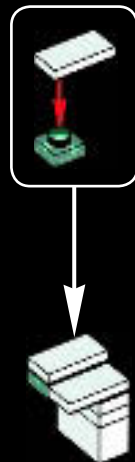





Each of the three 55-storey hotel towers has its unique geometry, with varying curvatures on their east sides.

这三座 55 层的酒店大厦有著各自独特的几何图形，其东侧的弯曲度均不相同。





# 22

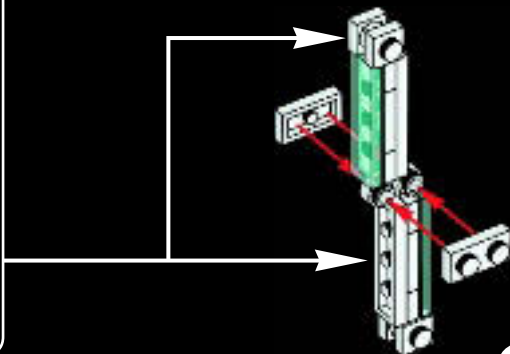
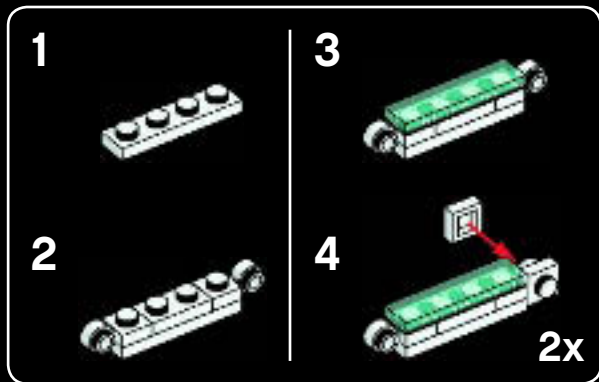

# 3x

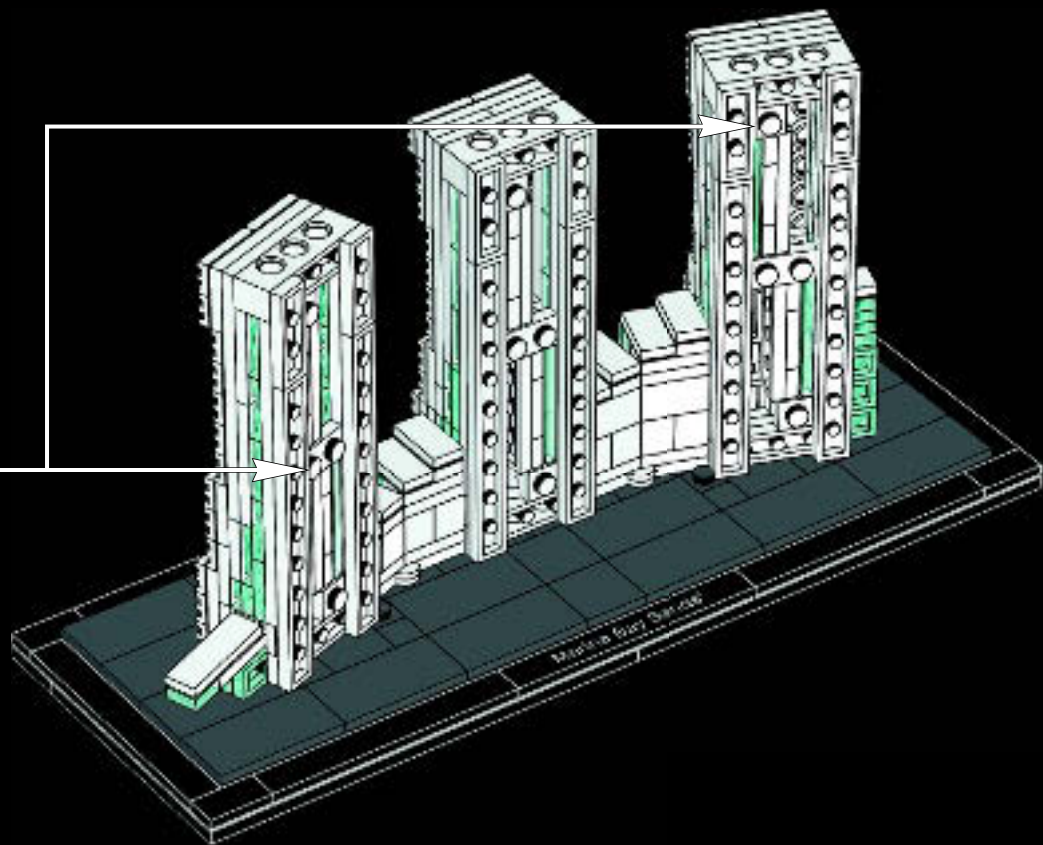

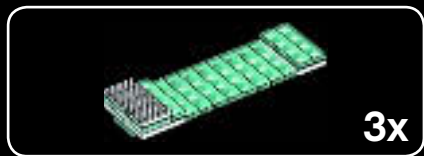

1



2

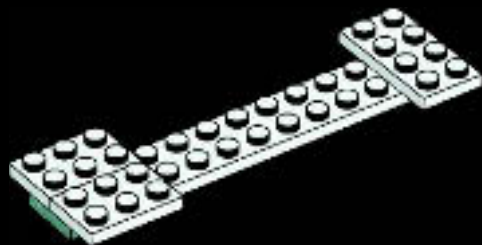



4x

3

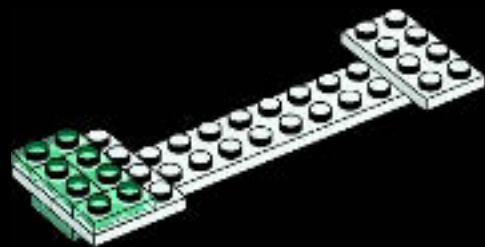

4x

4

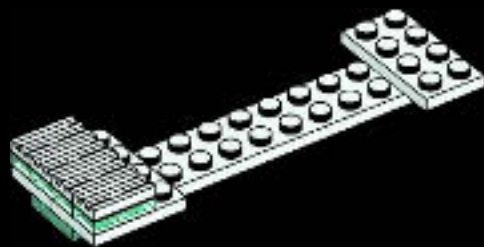



5

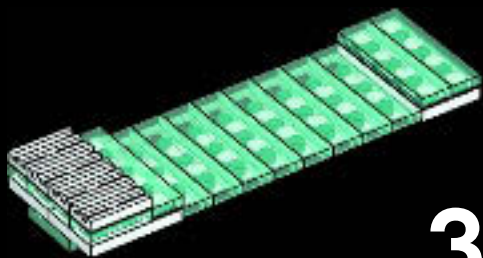

3x

# 23



The hotel towers rise from their base in two halves before merging some 20 stories above.

三座酒店大厦各自从底座开始分两部分建设，到 20 多层时合二为一。



© Marina Bay Sands



9x

24

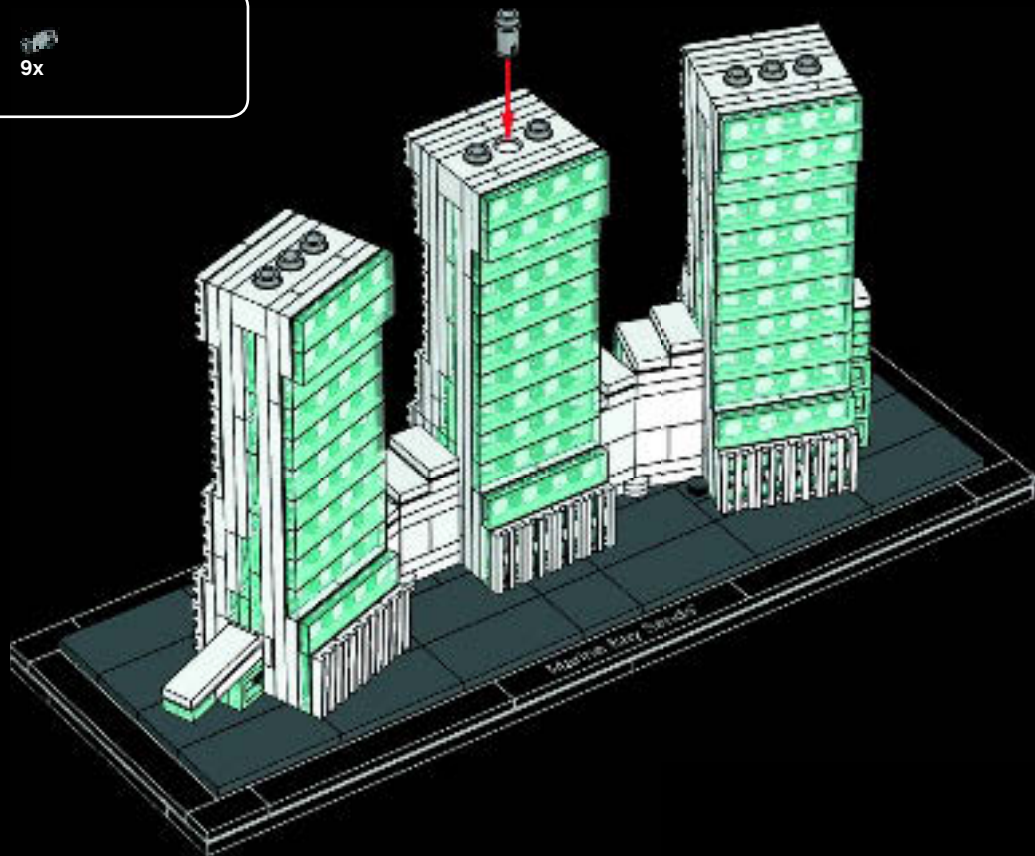



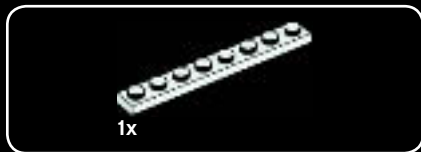
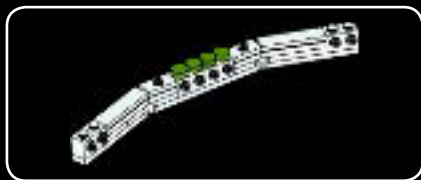

1x

1



2x

2x

2

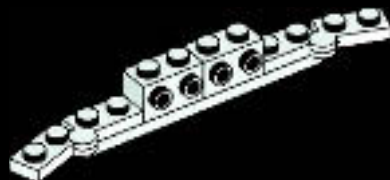



2x

3

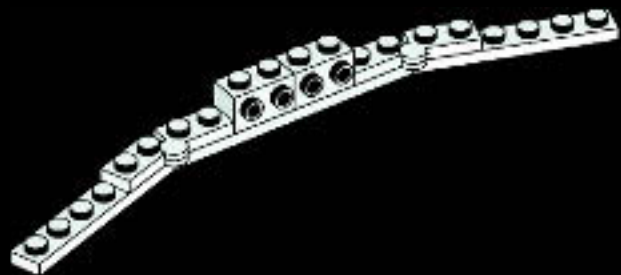

2x



2x

4

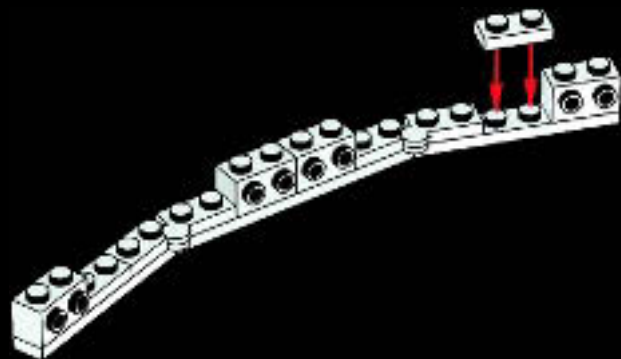



2x



2x

5

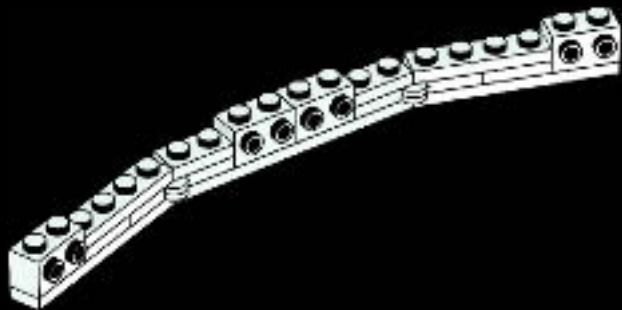

2x



2x

6

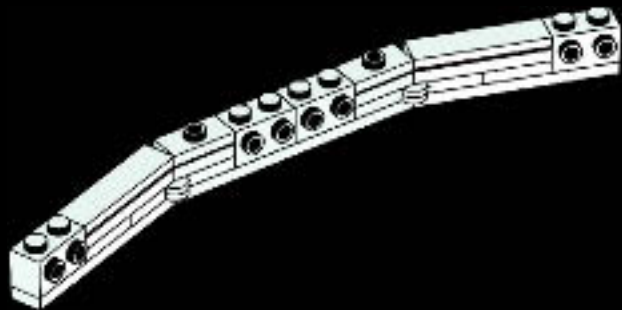



4x

7

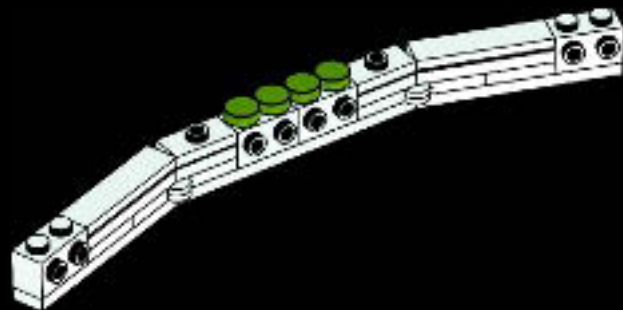

25

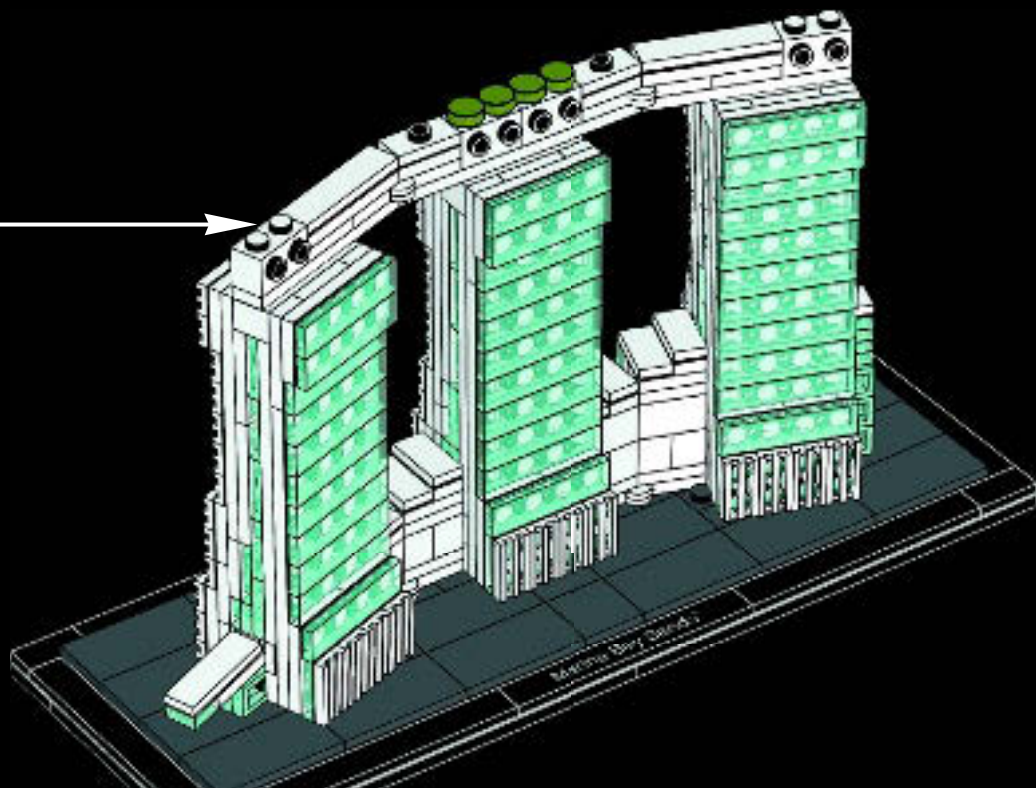



26

1



2



3



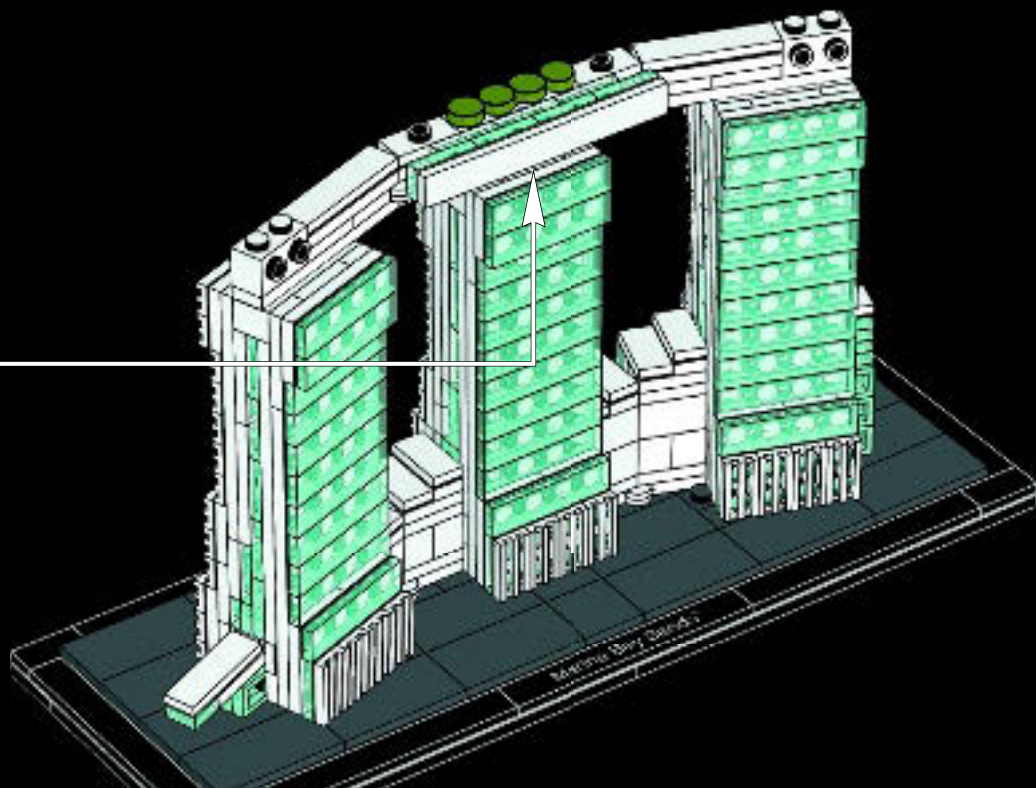

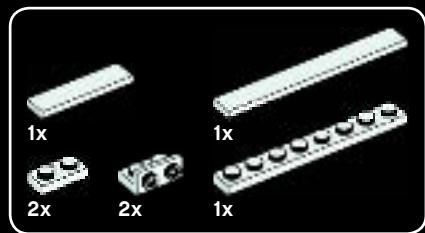

27

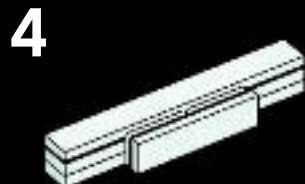
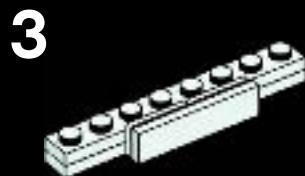
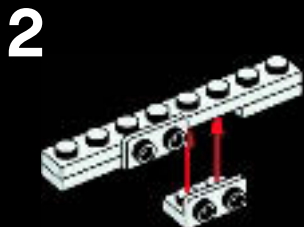
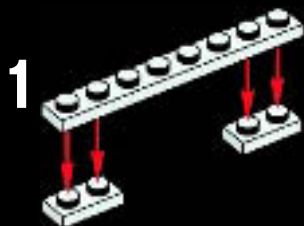



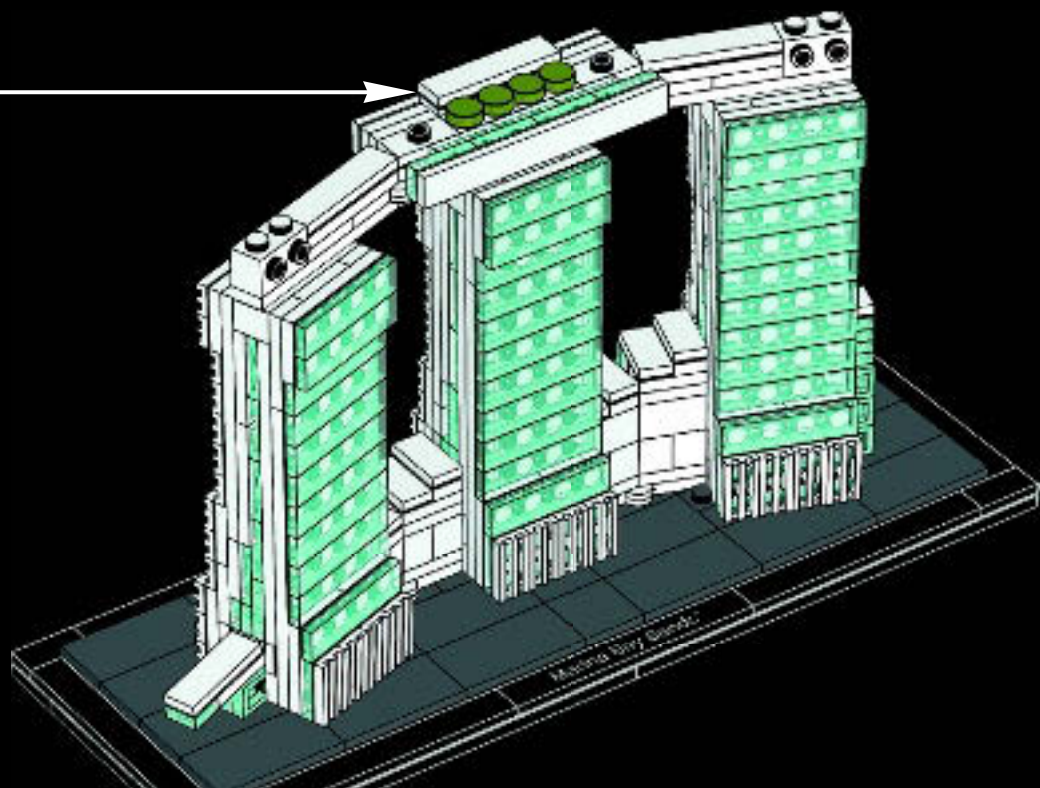

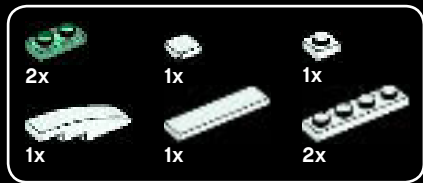

# 28

## 1



## 2



## 3



## 4

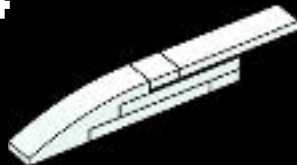

## 5

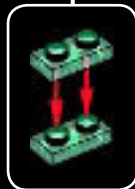
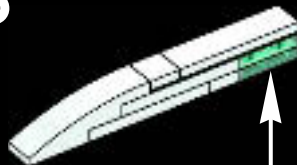

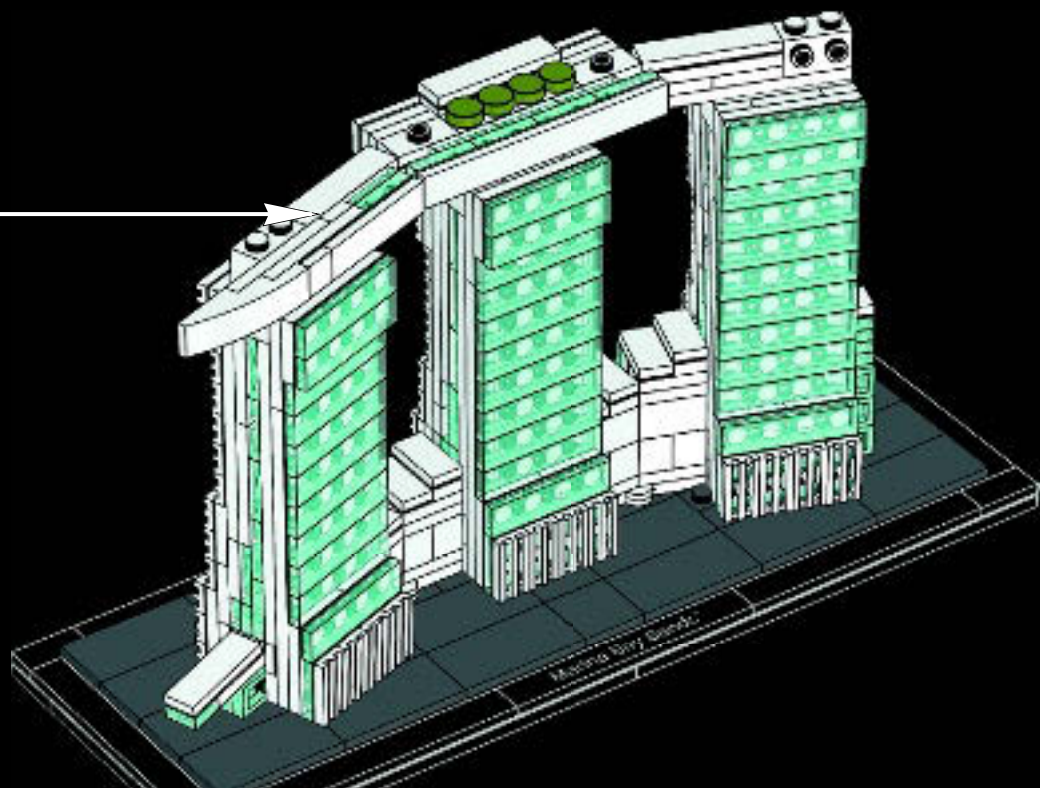



1x



1x



1x



1x

# 29

1



2



3





The 125 ft. (38m) wide and 1115 ft. (340m) long Sands SkyPark is the world's longest habitable cantilevered observation deck.

125 英尺宽 (38 米)、1,115 英尺长 (340 米) 的金沙 SkyPark 是世界上最长的适合居住的悬臂式观景台。



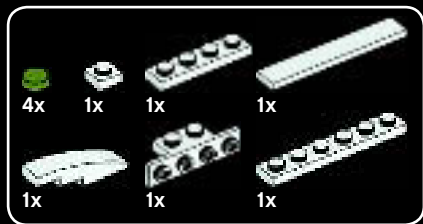

30

1

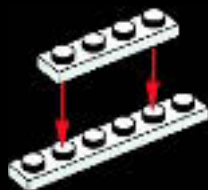

2



3



4



5



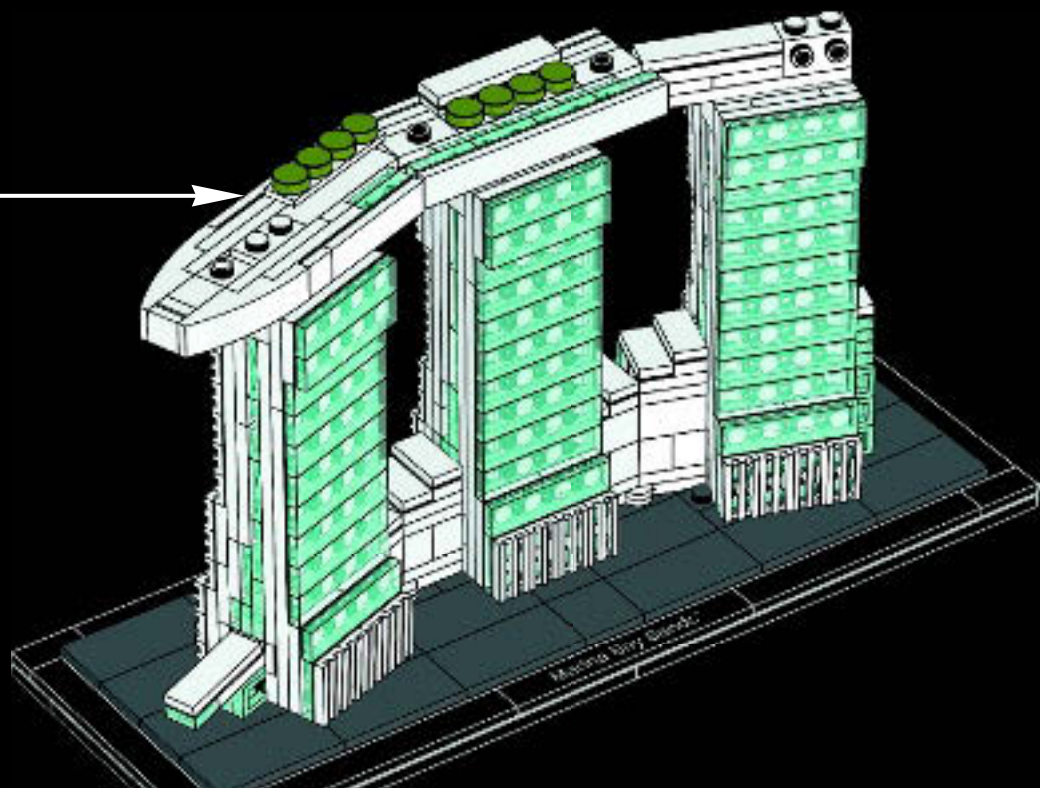



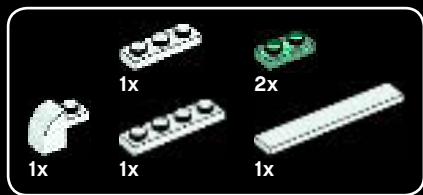

**31**

**1**



**2**

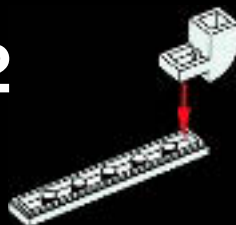

**3**

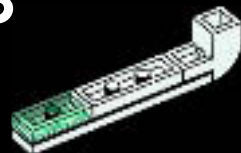

**4**

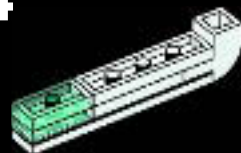





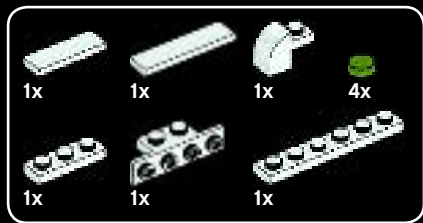

32

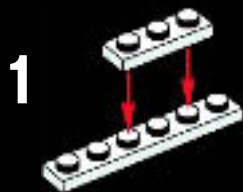

2



3



4

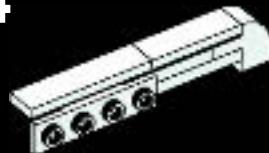

5



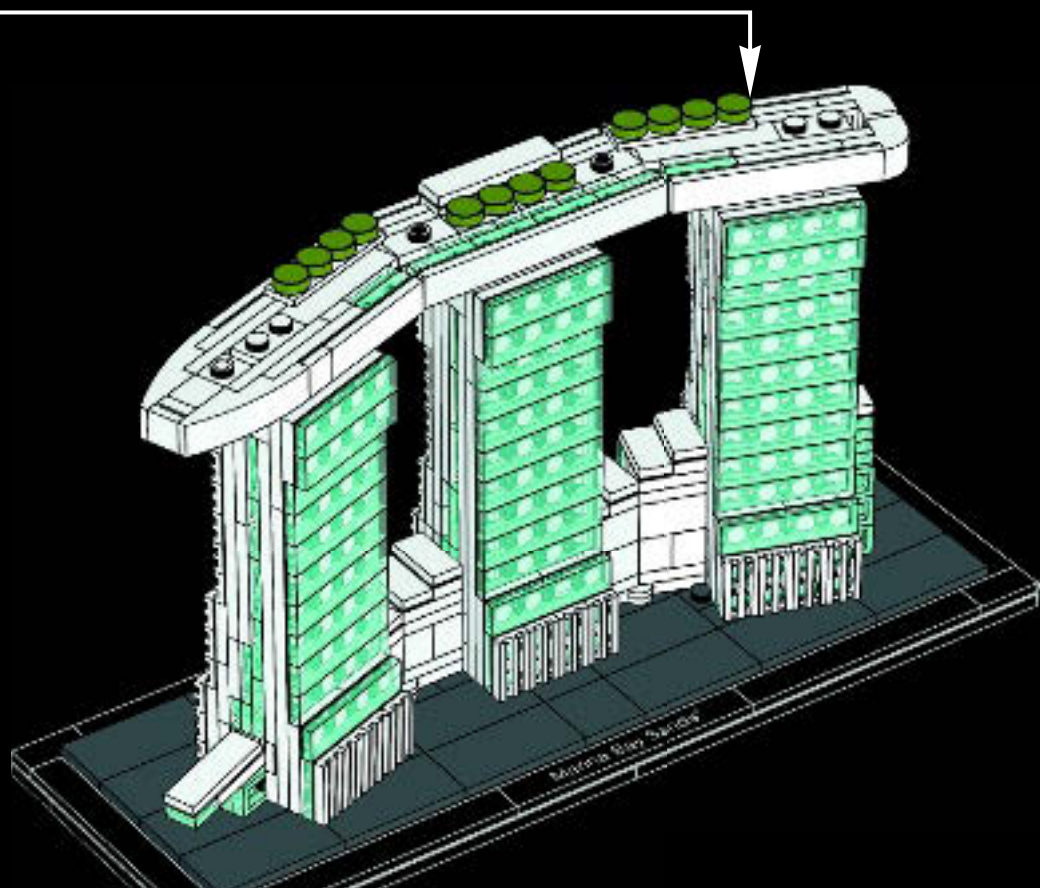



33





2x

34





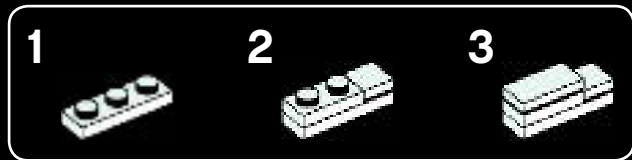
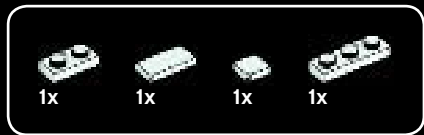

35

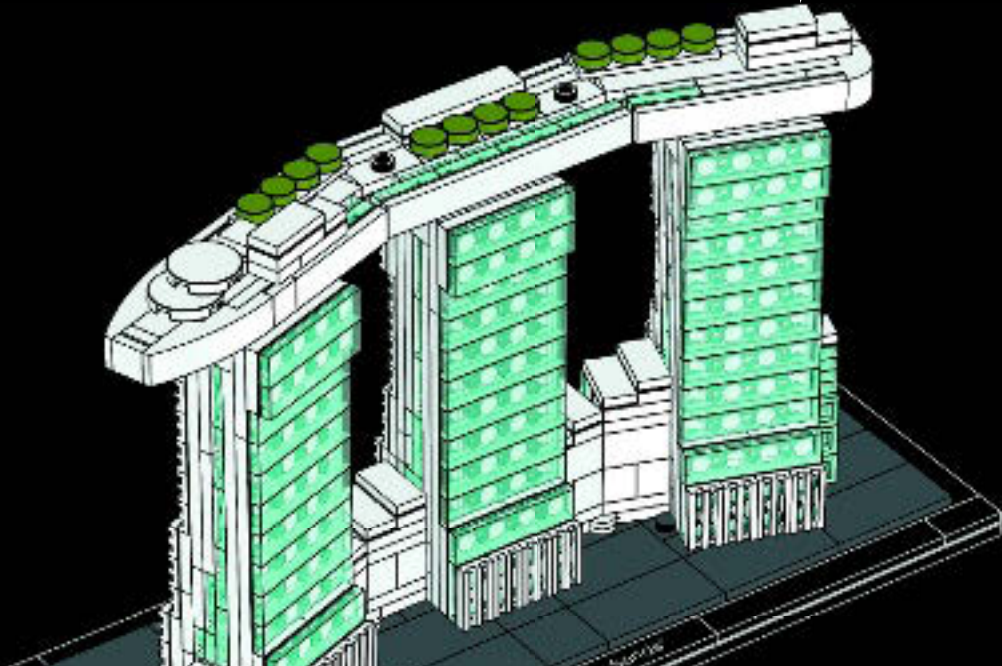



2x



2x

# 36



2x

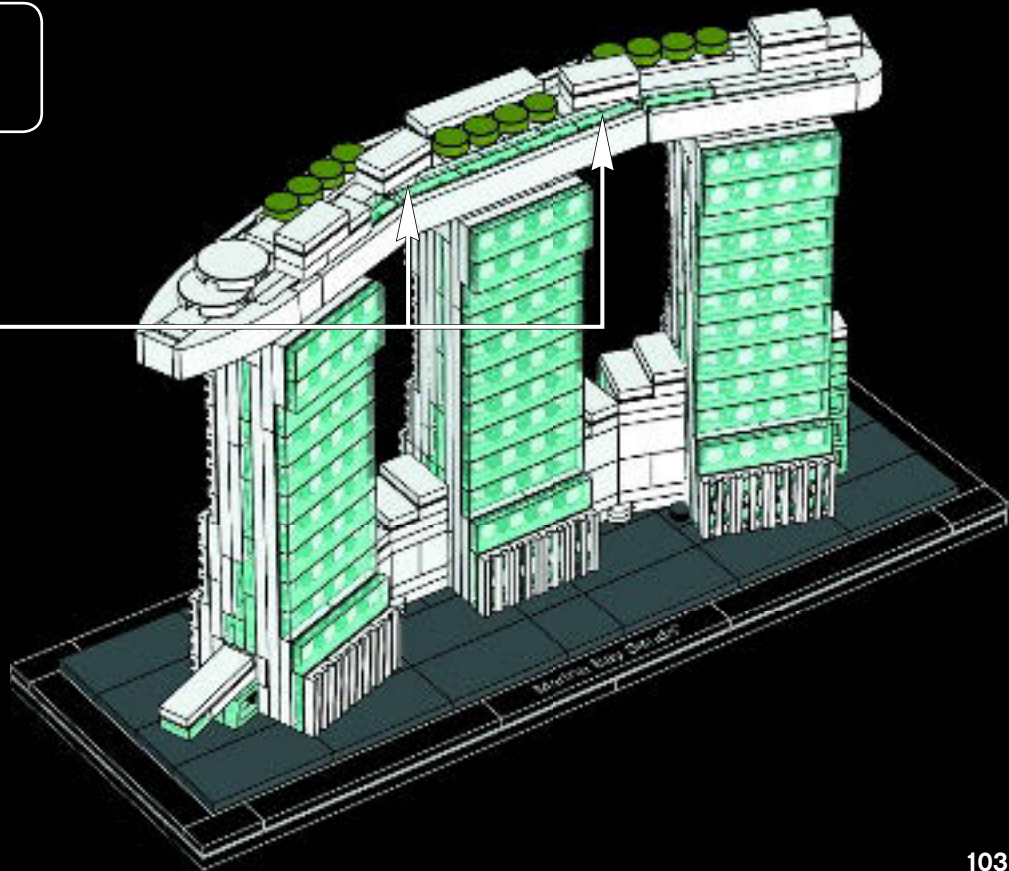

## A Word from the Artist

The LEGO® reproduction of Marina Bay Sands® complex forms - a design with hardly any straight lines - required a solution beyond the single perpendicular grid floor plan usually favored in LEGO building, with two additional rotated grids on the sides.

While it is challenging to create architecture of such enormous size, the opposite is true when designing in LEGO elements - the smaller the scale the bigger the challenge. In this model the height of a single brick represents five stories in real-life.

Sideways building with LEGO elements allows for more gradual changes on the concaved sides of the three hotel towers; the double-glazed curtain walls with reflective glass on the west façades are recreated with transparent blue 1x4 bricks, while the 1x2 LEGO grilles mimic the balconies on the sloping eastern facades.

A strong design element of the complex is the vegetation.

The lush trees and plants of the SkyPark are abstracted here by olive green round LEGO 1x1 bricks.

Rok Žgalin Kobe

A handwritten signature in black ink that reads "Rok Kobe". The letters are stylized and connected, with a cursive feel.

The Marina Bay Sands model was created in close collaboration with the LEGO design team. They look at the model from a LEGO building point of view and ensure the construction process is simple and logical, and a positive experience for the user.



# 艺术家打造的世界

滨海湾金沙®建筑形状比较复杂，几乎没有一条直线，乐高建筑中常用的单个垂直方格地板和每侧的两个附加旋转方格已然无法解决这个问题。

打造如此巨大的建筑物非常具有挑战性——而与之相反的是，在使用乐高组件进行设计时，规模越小，挑战越大。在该模型中，单块积木的高度代表现实生活中的五层楼。

使用乐高组件进行横向拼砌时，允许三座酒店大厦的凹面有更多的渐进改变；西面的双层玻璃幕墙使用蓝色透明的1x4瓷砖打造而成，而东侧斜面的阳台则使用1x2乐高隔板模拟而成。

综合体中最显著的设计元素就是植物。圆形橄榄绿乐高1x1积木代表了 SkyPark 中苍翠繁茂的绿树和植被。

Rok Žgalin Kobe

滨海湾金沙模型是在与乐高设计团队的紧密合作中打造而成。他们从乐高拼砌的角度审视该模型，确保建筑过程简单且符合逻辑，为用户带来积极体验。



# The ‘Scale Model’ line – LEGO® Architecture in the 1960s

The history of the current LEGO® Architecture series can be traced back to the beginning of the 1960s, when the popularity of the LEGO brick was steadily increasing. Godtfred Kirk Christiansen, the then owner of the company, began looking for ways to further expand the LEGO system and asked his designers to come up with a set of components that would add a new dimension to LEGO building.

Their answer was as simple as it was revolutionary: five elements that matched the existing bricks, but were only one third the height. These new building “plates” made it possible to construct more detailed models than before.

This greater LEGO flexibility seemed to match the spirit of the age; modernist architects were redefining how houses looked and people were taking an active interest in the design of their new homes. It was these trends that led to the introduction of the LEGO ‘Scale Model’ line in early 1962.

The name itself was a direct link to the way architects and engineers worked, and it was hoped that they and others would build their projects ‘to scale’ in LEGO elements. As with LEGO Architecture today, the original sets were designed to be different from the normal, brightly colored LEGO boxes, and also included ‘An Architectural Book’ for inspiration.

Though the five elements remain an integral part of the LEGO building system today, the ‘Scale Model’ line was phased out in 1965. Many of the principles from the series would re-emerge over 40 years later in the LEGO Architecture series.



## “比例模型”系列——乐高®建筑，始于 20 世纪 60 年代

现在的乐高®建筑系列可追溯到 20 世纪 60 年代初，当时乐高积木的受欢迎度正在稳步上升。古德弗烈（Godtfred Kirk Christiansen）是当时的公司所有人，他寻求进一步扩展乐高体系的办法，要求设计师设计出可为乐高拼砌添加全新尺寸的组件。

设计师给出的解决方案即简单又具有革新性：五个组件匹配现有积木，但高度仅为原来的三分之一。使用这些全新的“盘子”能够建造更加详实的模型。

乐高的灵活性更强，更符合时代精神；现代的建筑师重新定义房屋的外观，人们对设计新家的兴趣越来越浓。为顺应这个潮流，乐高“比例模型”系列于 1962 年年初面世了。

该名字本身就与建筑师和工程师的工作方式直接相关，大家都希望他们以及其他人士可使用乐高组件“按比例”拼砌项目。如今的乐高建筑系列组件与亮色的普通乐高盒子不同，还包含一部“建筑大全”来激发用户的想像力。

“比例模型”于 1965 年下线，不过五个组件至今仍是乐高拼砌体系不可或缺的组成部分。系列中的众多建筑原理将在 40 年后的乐高建筑系列中重现。

# Architect Series

## 建筑系列

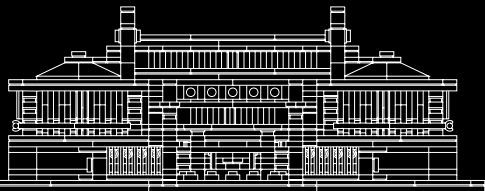

21017  
Imperial Hotel  
帝国酒店

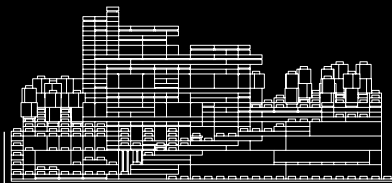

21005  
Fallingwater®  
流水别墅®

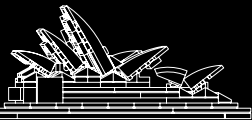

21012  
Sydney Opera House™  
悉尼歌剧院

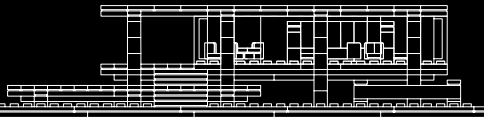

21009  
Farnsworth House™  
范斯沃斯宅邸

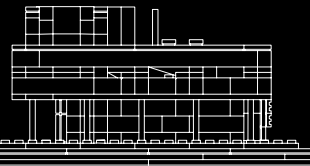

21014  
Villa Savoye  
萨瓦别墅

# Landmark Series

## 地标系列

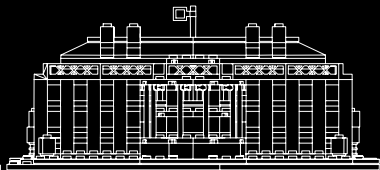

21006  
The White House  
白宫

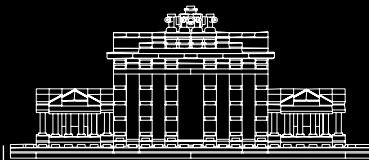

21011  
Brandenburg Gate  
勃兰登堡大门

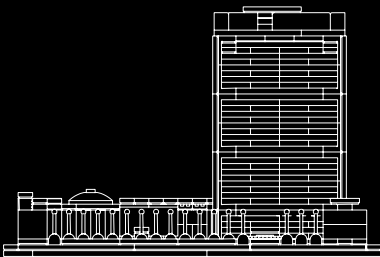

21018  
United Nations Headquarters  
联合国总部大楼

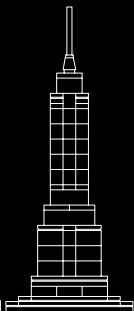

21002  
Empire State Building  
帝国大厦

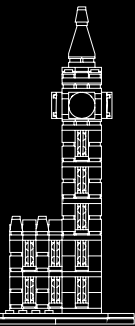

21013  
Big Ben  
大笨钟

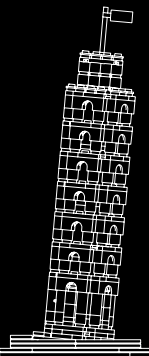

21015  
The Leaning Tower of Pisa  
比萨斜塔



21003  
Seattle Space Needle  
西雅图太空针塔

# References 参考

[www.designsingapore.org](http://www.designsingapore.org)

<http://www.msafdie.com>

<http://www.marinabaysands.com>

[www.arup.com](http://www.arup.com) (Arup Journal 1, 2012)

Customer Service  
Kundenservice  
Service Consommateurs  
Servicio Al Consumidor  
LEGO.com/service or dial



00800 5346 5555 :

1-800-422-5346 :



3x  
300401



1x  
40700



1x  
4111971



4x  
4667575



13x  
654101



4x  
370101



2x  
609101



2x  
6045936



22x  
302401



7x  
307001



2x  
6051511



42x  
302301



90x  
241201



13x  
306901



1x  
242001



20x  
362301



2x  
4558168



18x  
302101



5x  
243101



2x  
663601



1x  
4508662



2x  
346001



2x  
416201



11x  
447701



3x  
303501



3x  
244501



21x  
371001



17x  
302001



6x  
366601



1x  
4613256



12x  
4632566



2x  
6070698



1x  
4515364



2x  
4282737



2x  
6044691



4x  
4287153



4x  
4514553



4x  
306926



2x  
379526



1x  
6070233



7x  
416226



4x  
6001494



1x  
4211406

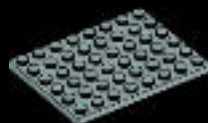

4x  
4211408



1x  
4654448



9x  
4211483



4x  
4210848



4x  
4210719



4x  
4211052



6x  
4211055



20x  
4560184



2x  
4211129



12x  
6047015



18x  
6051920



98x  
6051918



14x  
4667222



39x  
4586557

