



Architecture

21031

Burj Khalifa

Dubai, United Arab Emirates

Dubai, Émirats arabes unis

Dubái (Emiratos Árabes Unidos)



LEGO.com/architecture

Инструкция Лего (LEGO) 21031

Burj Khalifa

Described as both a 'Vertical City' and 'A Living Wonder', Burj Khalifa, at the heart of downtown Dubai, is also the world's tallest building.

Developed by Dubai-based Emaar Properties PJSC, Burj Khalifa rises gracefully from the desert and honors the city with its extraordinary union of art, engineering and meticulous craftsmanship.

At 2,716.5 ft. (828 m), the equivalent of a 200-story building, Burj Khalifa has 160 habitable levels, the most of any building in the world. The tower was inaugurated on January 4, 2010, to coincide with the fourth anniversary of the Accession Day of His Highness Sheikh Mohammed Bin Rashid Al Maktoum, Vice President and Prime Minister of the UAE and Ruler of Dubai.

Arguably the world's most interesting construction project, Burj Khalifa is responsible for a number of world firsts. The tower became the world's tallest man-made structure just 1,325 days after excavation work started in January 2004.





© Emaar Properties PJSC

Burj Khalifa utilized a record-breaking 430,000 cubic yds. (330,000 m³) of concrete; 42,990 tons (39,000 metric tons) of steel reinforcement; 1.1 million sq. ft. (103,000 m²) of glass; and 167,000 sq. ft. (15,500 m²) of embossed stainless steel. The tower took 22 million man-hours to build.

With a total built-up area of 5.67 million sq. ft. (526,000 m²), Burj Khalifa features 1.85 million sq. ft. (170,000 m²) of residential space, over 300,000 sq. ft. (28,000 m²) of office space, with the remaining area occupied by a luxury hotel. In 2003, as a result of an international design



© Emaar Properties PJSC

competition, Skidmore, Owings & Merrill LLP (SOM) was selected from a group of five international competitors to carry out the architecture and engineering of the Burj Khalifa.

With famous architecture in the Haj Terminal at Jeddah Airport and National Commercial Bank, SOM is no stranger to Middle Eastern design. SOM incorporated patterns and elements from traditional Islamic architecture, but the most inspiring muse was a regional desert flower, the Hymenocallis, whose harmonious structure is one of the organizing principles of the tower's design. Three 'petals' are arranged in a triangular

shape and unified at the center, and instead of repeated identical patterns, the architectural plan appoints successively receding and rotated stories.

The Y-shaped plan is ideal for residential and hotel usage, with the wings allowing maximum outward views and inward natural light. Viewed from above or from the base, the tips of the Y-shaped plan evoke the onion domes of Islamic architecture. During the design process, engineers rotated the building 120 degrees from its original layout to reduce stress from prevailing winds.

Architecturally, the building transforms itself from a solid base expression to a vertically expressed middle section of polished stainless steel, projected metal fins, and glass. Only vertical elements were used here, as the fine dust in Dubai's air would build up on any horizontal projecting elements.

© Emaar Properties PJSC



DESERT FLOWER

© Emaar Properties PJSC

© Emaar Properties PJSC



DOME SHAPE

© Emaar Properties PJSC

The Architects

With the design and engineering of Burj Khalifa, Skidmore, Owings & Merrill LLP (SOM) joined forces with Dubai based developers Emaar Properties PJSC, to redefine what was possible with supertall buildings.

With a portfolio that includes some of the most important architectural accomplishments of the 20th and 21st centuries, including the John Hancock Center and Willis (formerly Sears) Tower, SOM was perfectly placed to carry out this challenging task.

To create Burj Khalifa—a building that shatters all previous height records at 2,716.5 ft. (828 m)—a team of more than 90 designers and engineers combined cutting edge technology and culturally-influenced design to create a global icon that will serve as a model for future urban centers.



© Emaar Properties PJSC

Construction Highlights

Burj Khalifa is truly the product of international collaboration; over 60 consultants including 30 on-site contracting companies from around the world were involved in the project.

At the peak of construction, over 12,000 professionals and skilled workers from more than 100 countries were on site every day. The world's fastest high-capacity construction hoists, with a speed of up to 6.5 ft./sec (2 m/sec or 120 m/min), were used to move men and materials.

Over 1.59 million cubic ft. (45,000 m³) of concrete, weighing more than 121,254 tons (110,000 metric tons), were used to construct the concrete and steel foundations, which feature 192 piles, buried more than 164 ft. (50 m) deep. Burj Khalifa employs a record-breaking 11.6 million cubic ft. (330,000 m³) of concrete; 42,990 tons (39,000 metric tons) of reinforced steel; 1.1 million sq. ft. (103,000 m²) of glass; 166,800 sq. ft. (15,500 m²) of embossed stainless steel; and the tower took 22 million man-hours to build. The amount of reinforced steel used at the tower would, if laid end to end, extend over a quarter of the way around the world. The concrete used is equivalent to a sidewalk 1,200 miles (1,900 km) in length, and the weight of 110,000 elephants. The weight of the empty building is 551,156 tons (500,000 metric tons).



© Emaar Properties PJSC

The tower accomplished a world record for the highest installation of an aluminum and glass facade, at a height of 1,679.8 ft. (512 m). The total weight of aluminum used on Burj Khalifa is equivalent to that of five A380 aircraft, and the total length of stainless steel bull nose' fins is 293 times the height of the Eiffel Tower in Paris.

Facts about Burj Khalifa

Location:..... Downtown Dubai, Dubai, United Arab Emirates

Architect:..... Skidmore, Owings & Merrill LLP (SOM)

Building type: Supertall skyscraper

Materials:..... Reflective glazing, aluminum
and textured stainless steel

Construction: Reinforced concrete and steel

Date: From 2004 to 2010

Floor area: 5.67 million sq. ft. (464,511 m²)

Height:..... 2,716.5 ft. (828 m)

Stories: 160+ stories



Burj Khalifa

Décrite à la fois comme une « ville à la verticale » et une « merveille vivante », la tour Burj Khalifa, située au cœur du quartier commerçant de Dubaï, est également la plus haute du monde.

Construite par Emaar Properties PJSC, une société immobilière basée à Dubaï, cette tour, qui combine majestueusement art, ingénierie et savoir-faire de grande qualité, s'élève gracieusement au cœur du désert et fait honneur à la ville.

Culminant à 828 mètres, soit l'équivalent d'un bâtiment de 200 étages, la Burj Khalifa compte 160 étages habitables, soit le plus grand nombre parmi tous les gratte-ciel du monde. La tour a été inaugurée le 4 janvier 2010, date du 4^e anniversaire de prise de fonction de Son Altesse Sheikh Mohammed Bin Rashid Al Maktoum, vice-président et premier ministre des Émirats arabes unis et gouverneur de Dubaï.

La tour Burj Khalifa, que l'on pourrait qualifier de projet de construction le plus intéressant du monde, a donné lieu à un grand nombre de premières. La tour est devenue la plus haute structure au monde réalisée par l'homme, seulement 1 325 jours après le début des travaux de terrassement, en janvier 2004.





© Emaar Properties PJSC

La tour Burj Khalifa a battu tous les records, utilisant 330 000 m³ de béton, 39 000 tonnes de poutres en acier, 103 000 m² de verre et 15 500 m² d'acier inoxydable gaufré. La construction de la tour a également exigé 22 millions d'heures de travail.

Avec une zone bâtie totale de 526 000 m², la tour Burj Khalifa comprend 170 000 m² d'espace résidentiel, plus de 28 000 m² d'espace de bureaux alors que le reste est réservé à un luxueux hôtel. En 2003, fruit d'une compétition architecturale internationale, l'agence d'architectes



© Emaar Properties PJSC

SOM (Skidmore, Owings & Merrill LLP) a été sélectionnée parmi cinq concurrents internationaux pour la mise en œuvre de la Burj Khalifa, selon les plans d'architecture et d'ingénierie.

De par l'architecture de la National Commercial Bank et du terminal Haj de l'aéroport de Jeddha, SOM n'est pas novice en matière de conception architecturale au Moyen-Orient. SOM a intégré des éléments et des motifs de l'architecture islamique traditionnelle, mais elle s'est principalement inspirée d'une fleur du désert local, l'Hymenocallis, dont la structure harmonieuse est l'un des principes d'organisation ayant été

utilisés pour la conception de la tour. Trois « pétales » réunis au centre constituent une forme triangulaire et, plutôt que de répéter des motifs identiques, le plan architectural alterne des étages en retrait et en rotation.

Le plan en forme de Y est idéal pour les zones hôtelière et résidentielle, les ailes permettant des panoramas exceptionnels ainsi qu'un passage optimal de la lumière naturelle. Vues du dessus ou des fondations, les branches du Y évoquent les coupoles en forme d'oignon de l'architecture islamique. Les ingénieurs ont notamment fait pivoter le bâtiment de 120 degrés par rapport à son emplacement d'origine pendant le processus de conception afin de réduire l'impact des vents dominants sur celui-ci.

D'un point de vue architectural, le bâtiment passe d'une base solide à une section médiane exprimée verticalement, avec verre et ailettes métallisées projetées faites d'acier inoxydable poli. Seuls des éléments verticaux ont été utilisés dans la conception de la tour car sinon, la fine poussière contenue dans l'air de Dubaï se déposerait sur tout élément horizontal.

© Emaar Properties PJSC



FLEUR DU DÉSERT

© Emaar Properties PJSC

© Emaar Properties PJSC

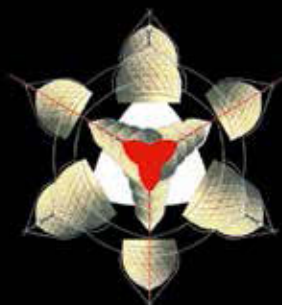

FORME DE LA COUPOLE

© Emaar Properties PJSC

Les architectes

Pour l'architecture et l'ingénierie de la Burj Khalifa, l'agence d'architectes SOM (Skidmore, Owings & Merrill LLP) a collaboré avec les développeurs d'Emaar Properties PJSC, basés à Dubaï, pour redéfinir les possibilités à l'égard des gratte-ciel géants.

Dotée d'un portfolio comprenant quelques-unes des plus importantes réalisations architecturales des 20^e et 21^e siècles, notamment le centre John Hancock et la tour Willis (précédemment appelée Sears), l'agence SOM était en parfaite position pour relever ce défi.

Pour créer la Burj Khalifa, un bâtiment battant tous les records de hauteur précédents avec ses 828 mètres, une équipe de plus de 90 concepteurs et ingénieurs ont allié technologie de pointe et conception culturellement inspirée pour produire une icône mondiale qui servira de modèle aux futurs centres urbains.



© Emaar Properties PJSC

Points forts de la construction

La tour Burj Khalifa est réellement le fruit d'une collaboration internationale : plus de 60 entreprises consultantes dont 30 entreprises de sous-traitance sur place venues du monde entier, ont participé au projet.

Au plus fort de la construction, plus de 12 000 professionnels et ouvriers qualifiés provenant de plus de 100 pays étaient à l'œuvre sur le site, chaque jour. Les engins de levage de haute capacité les plus rapides au monde, dont la vitesse peut atteindre les 2 m/s, soit 120 m/min, ont été utilisés pour déplacer les hommes et les matériaux.

Plus de 45 000 m³ de béton, soit plus de 110 000 tonnes, ont été utilisés pour construire les fondations en béton et acier, comptant 192 pieux, enterrés à plus de 50 mètres de profondeur. La tour Burj Khalifa a battu tous les records, utilisant 330 000 m³ de béton, 39 000 tonnes de poutres en acier, 103 000 m² de verre et 15 500 m² d'acier inoxydable gaufré. La construction de la tour a également exigé 22 millions d'heures de travail. Les poutres en acier utilisées pour la construction de la tour, mises bout à bout, mesureraient plus du quart du tour de la Terre. Le béton utilisé équivaut à un trottoir de 1 900 km de long et au poids de 110 000 éléphants. La tour vide pèse 500 000 tonnes.



© Emaar Properties PJSC

La tour détient le record mondial de l'installation la plus haute d'une façade en verre et en aluminium, à une hauteur de 512 mètres. Le poids total d'aluminium utilisé pour la tour Burj Khalifa est équivalent à celui de cinq avions A380, et la longueur totale des ailettes à chanfrein arrondi en acier inoxydable représente 293 fois la hauteur de la tour Eiffel à Paris.

Informations sur la Burj Khalifa

Lieu : Quartier commerçant de Dubaï, Dubaï, Émirats arabes unis

Architecte : Skidmore, Owings & Merrill LLP (SOM)

Type de bâtiment : Gratte-ciel géant

Matériaux : Glace réfléchissante, aluminium
et acier inoxydable texturé

Construction : Béton armé et acier

Date : De 2004 à 2010

Surface au sol : 464 511 m²

Hauteur : 828 mètres

Étages : Plus de 160 étages



Burj Khalifa

Situado en el centro de la ciudad de Dubái, ha sido descrito como «una ciudad vertical» y «una maravilla viviente». Es el Burj Khalifa: el edificio más alto del mundo.

Construido por la compañía dubaití Emaar Properties PJSC, el Burj Khalifa surge con elegancia de la arena del desierto para honrar a la ciudad con una extraordinaria mezcla de arte, ingeniería y exquisita artesanía.

La altura del Burj Khalifa, de 828 m y equivalente a la de un edificio de 200 pisos, alberga 160 plantas habitables (más que cualquier otro edificio del mundo). La torre se inauguró el 4 de enero de 2010, coincidiendo con el cuarto aniversario del día de la coronación de su alteza el jeque Mohammed Bin Rashid Al Maktoum, vicepresidente y primer ministro de EAU y soberano de Dubái.

El Burj Khalifa no sólo es, casi indiscutiblemente, el proyecto de construcción más interesante del mundo, sino también el objeto de un buen número de récords. La torre se convirtió en la estructura más alta del mundo fabricada por el hombre tan sólo 1.325 días después de que comenzaran las tareas de excavación en 2004.





© Emaar Properties PJSC

La construcción del Burj Khalifa supuso el uso de 330.000 m³ de concreto, 39.000 toneladas métricas de armazones de acero, 103.000 m² de vidrio, 15.500 m² de acero inoxidable gofrado y 22 millones de horas de mano de obra, cifras todas ellas sin precedentes en el sector.

Los 526.000 m² de superficie útil con los que cuenta el Burj Khalifa se dividen en 170.000 m² de espacio residencial, más de 28.000 m² de espacio para oficinas y un hotel de lujo que ocupa el espacio restante. El estudio de arquitectura Skidmore, Owings & Merrill LLP (SOM) fue,



© Emaar Properties PJSC

tras su elección como resultado de un concurso de diseño internacional celebrado en 2003 en el que participaron cinco estudios de todo el mundo, el responsable de ejecutar las tareas de arquitectura e ingeniería que fueron precisas para hacer realidad el Burj Khalifa.

Tras haber diseñado con éxito la terminal Haj del aeropuerto Jeddah y el edificio de la entidad bancaria National Commercial Bank, podría decirse que el estilo arquitectónico de Oriente Próximo no era un campo por explorar para SOM. Aunque el estudio de arquitectura incorporó patrones y elementos característicos de la arquitectura tradicional

islámica, su auténtica musa fue una flor del desierto muy popular en la región (la *Hymenocallis*), cuya armoniosa estructura empleó como principio organizativo en el diseño de la torre. Este se fundamenta en tres «pétalos» dispuestos en forma triangular y unidos por la parte central que, en lugar de seguir patrones idénticos, descienden en altura y rotan sus plantas sucesivamente.

La planta del edificio, en forma de Y, resulta ideal para el uso residencial y hotelero, ya que maximiza las vistas al exterior y fomenta la penetración de luz natural. Vistas desde la parte superior o desde la base, las puntas de la Y evocan cúpulas bulbosas, tan características en la arquitectura islámica. Durante el proceso de diseño, los ingenieros optaron por girar el edificio 120 grados en relación con su posición original con objeto de reducir la resistencia a los vientos preponderantes.

En términos arquitectónicos, el edificio parte de una sólida base cuya manifestación se funde en una sección intermedia vertical expresada empleando placas de metal proyectado (acero inoxidable pulido) y vidrio. Esta sección contiene exclusivamente elementos verticales con el fin de evitar que la fina arena que viaja suspendida en el aire de Dubái pueda acumularse en las superficies horizontales.

© Emaar Properties PJSC



© Emaar Properties PJSC



FLOR DEL DESIERTO

© Emaar Properties PJSC



© Emaar Properties PJSC



FORMA DE CÚPULA

Los arquitectos

Para las actividades de diseño e ingeniería del Burj Khalifa, Skidmore, Owings & Merrill LLP (SOM) decidió contar con la constructora dubaití Emaar Properties PJSC, junto a la que pondría nuevos límites a lo que hasta entonces había sido posible en relación con los rascacielos de gran altura.

SOM, que contaba con una diversa cartera de logros arquitectónicos alcanzados durante los siglos XX y XXI (entre ellos el Centro John Hancock y la Torre Willis, antes conocida como Torre Sears), era el estudio de arquitectura perfecto para ejecutar esta desafiante tarea.

En el Burj Khalifa –cuyos 828 m pulverizaron todas las alturas alcanzadas hasta entonces–, el equipo, formado por más de 90 diseñadores e ingenieros, combinó la más avanzada tecnología con un diseño de influencias culturales para crear un icono internacional que serviría como modelo a futuros centros urbanos.



© Emaar Properties PJSC

Datos de interés acerca de la construcción

El Burj Khalifa es un auténtico producto de la colaboración internacional: más de 60 expertos y 30 contratistas de todo el mundo participaron activamente en el proyecto.

En el momento álgido de la construcción acudían diariamente a trabajar más de 12.000 profesionales y especialistas procedentes de más de 100 países. El desplazamiento de personal y materiales se llevó a cabo empleando las grúas de construcción de alta capacidad más rápidas del mundo; su velocidad alcanza los 2 m/s (120 m/min).

Los cimientos, de concreto y acero, compuestos por 192 pilares y enterrados a más de 50 m de profundidad, exigieron el uso de 45.000 m³ de concreto y su peso asciende a más de 110.000 toneladas métricas. El Burj Khalifa supuso el uso de 330.000 m³ de concreto, 39.000 toneladas métricas de armazones de acero, 103.000 m² de vidrio, 15.500 m² de acero inoxidable gofrado y 22 millones de horas de mano de obra, un auténtico récord en el sector de la construcción. Si se colocara en línea recta todo el acero reforzado que contiene la torre, se alcanzaría una distancia equivalente a más de la cuarta parte de la circunferencia del planeta. El concreto empleado permitiría construir un andén de 1.900 km de longitud y su peso es igual al de 110.000 elefantes. El peso del edificio vacío es de 500.000 toneladas métricas.



© Emaar Properties PJSC

Con 512 m, la torre ostenta el récord mundial de instalación de una fachada de aluminio y vidrio a mayor altura. El peso total del aluminio instalado en el Burj Khalifa equivale al de cinco aviones A380; la longitud total de las placas del remate de acero inoxidable cubriría 293 veces la altura de la Torre Eiffel de París.

Ficha de características del Burj Khalifa

Situación:..... Centro de Dubái, Dubái (Emiratos Árabes Unidos)

Arquitecto: Skidmore, Owings & Merrill LLP (SOM)

Tipo de edificio: Rascacielos de gran altura

Materiales:..... Vidrio reflectante, aluminio y
acero inoxidable con textura

Construcción:..... Concreto reforzado y acero

Fecha:..... 2004-2010

Superficie útil: 464.511 m²

Altura:..... 828 m

Plantas:..... Más de 160



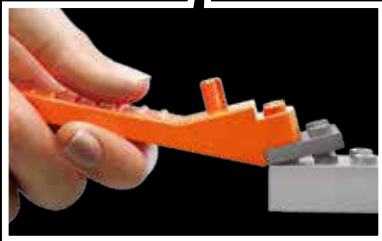
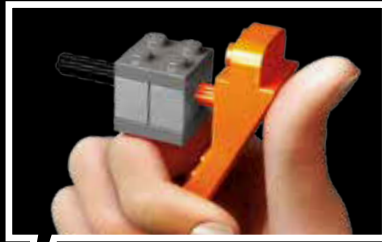
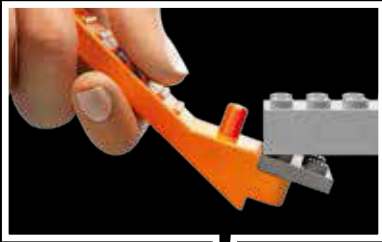

LEGO.com/brickseparator

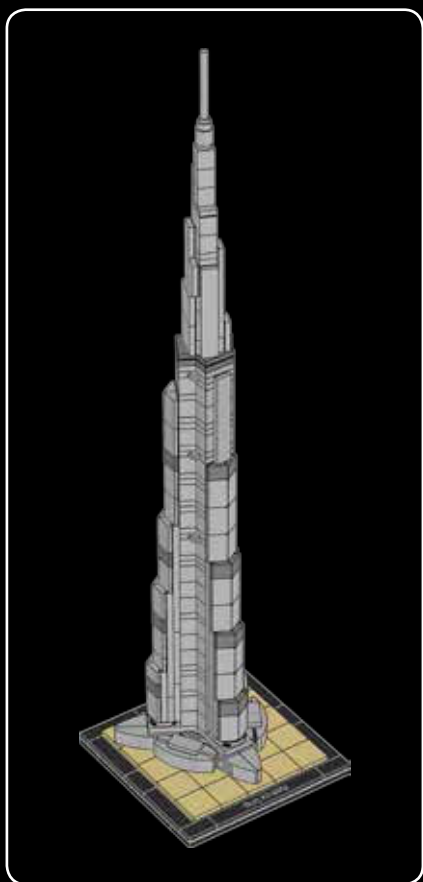



1

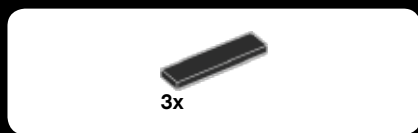
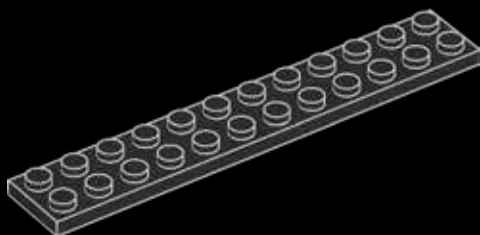

2

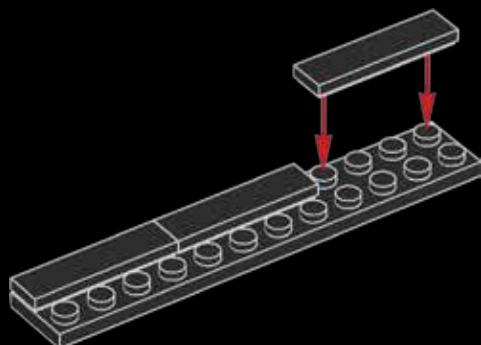



3

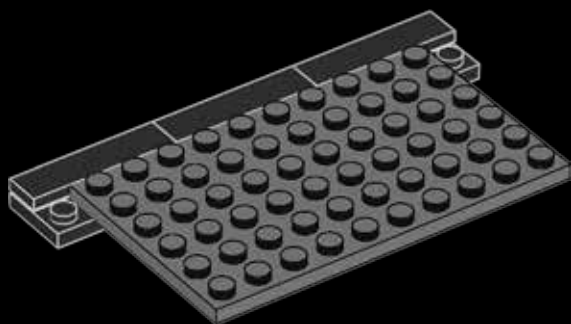



3x

4

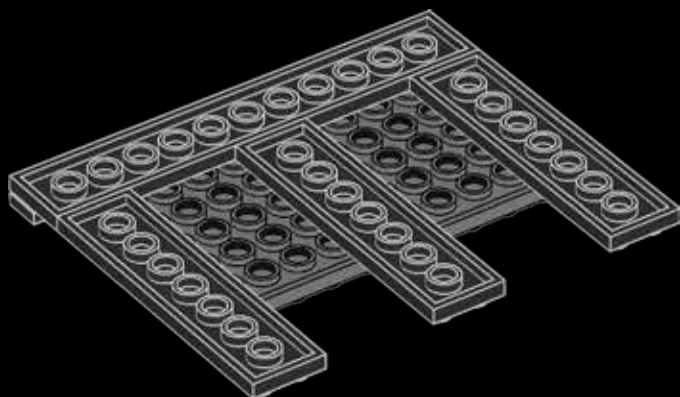



5

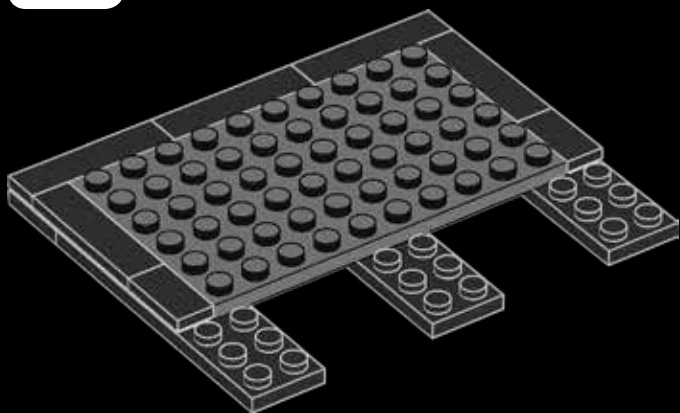

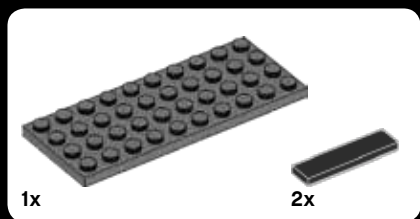

6

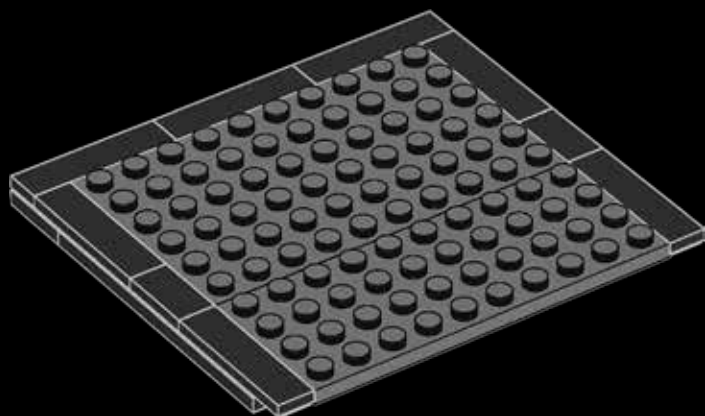



7

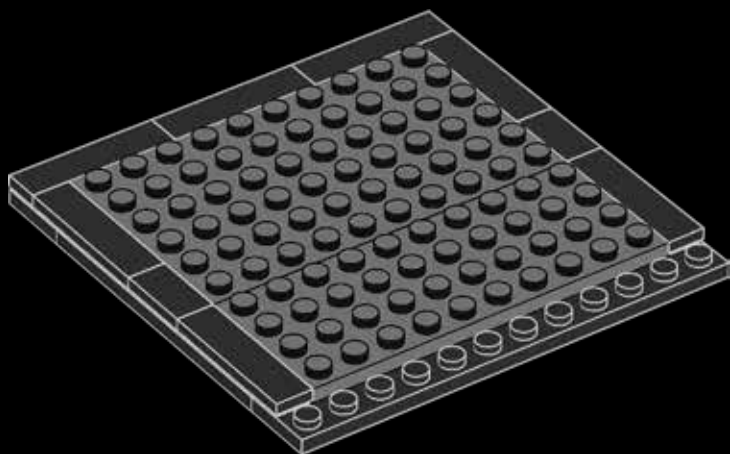

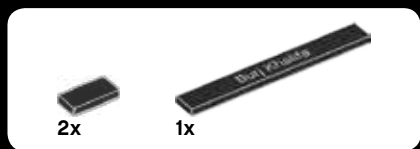

8

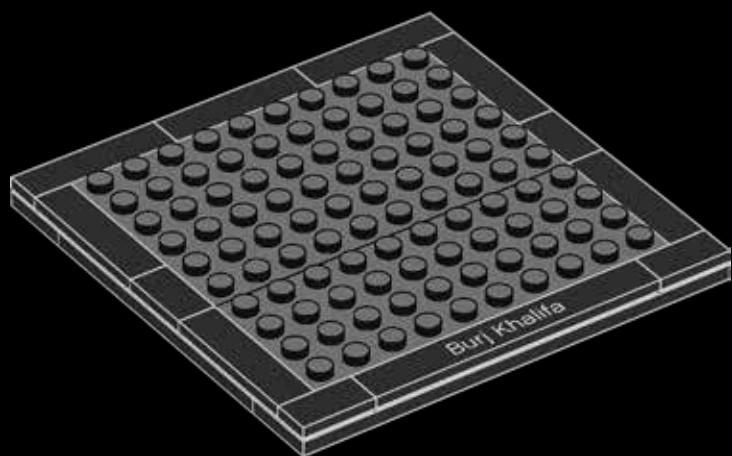

The interior is inspired by local culture while staying mindful of the building's status as a global icon and residence. The design features glass, stainless steel and polished dark stones, together with silver travertine flooring, Venetian stucco walls, handmade rugs and stone flooring.



8x



2x



1x

9

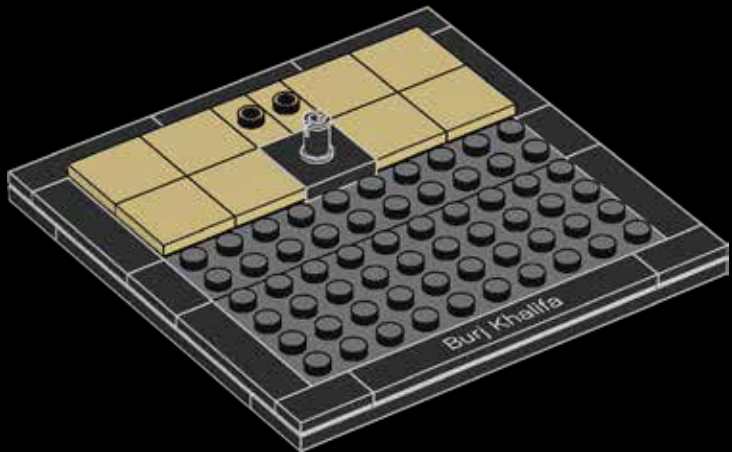

L'intérieur s'inspire de la culture locale tout en restant respectueux du statut du bâtiment comme résidence et icône mondiale. La conception allie le verre, l'acier inoxydable et les pierres sombres polies avec des sols en travertin argenté, des murs en stuc vénitien, des tapis faits à la main et des sols en pierre.



2x



2x



1x



2x

10

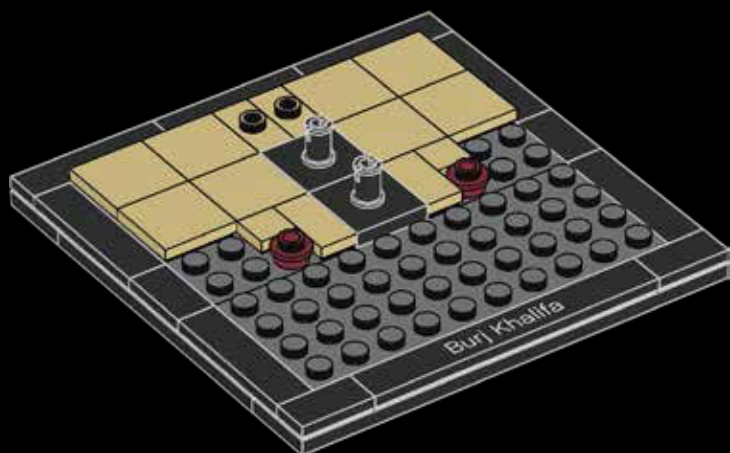

El interior se inspira en la cultura local, respetando el carácter residencial e internacional del edificio. Su diseño se compone de vidrio, acero inoxidable y piedra pulida de colores oscuros, elegantemente combinados con piso de travertino gris, paredes de estuco veneciano, alfombras hechas a mano y piso de piedra.



12x

11

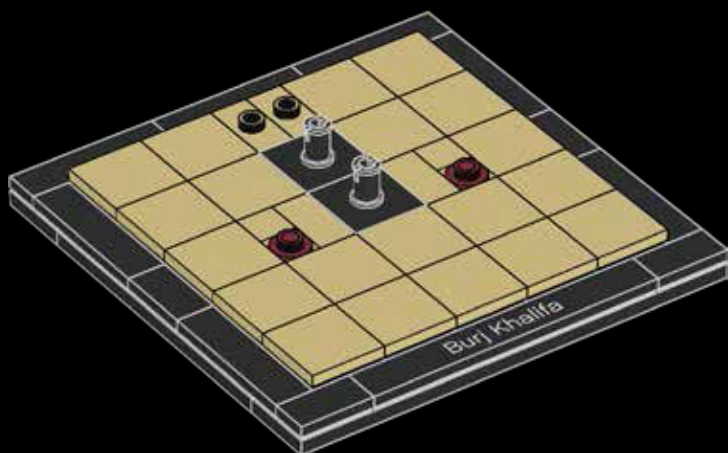



1x

12

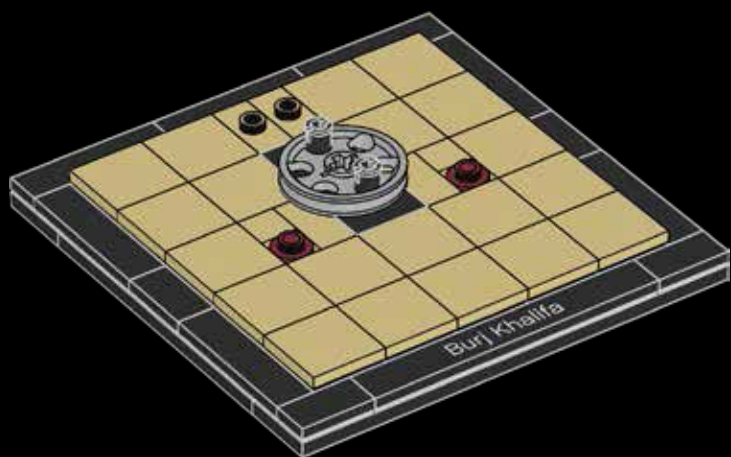



1x

13

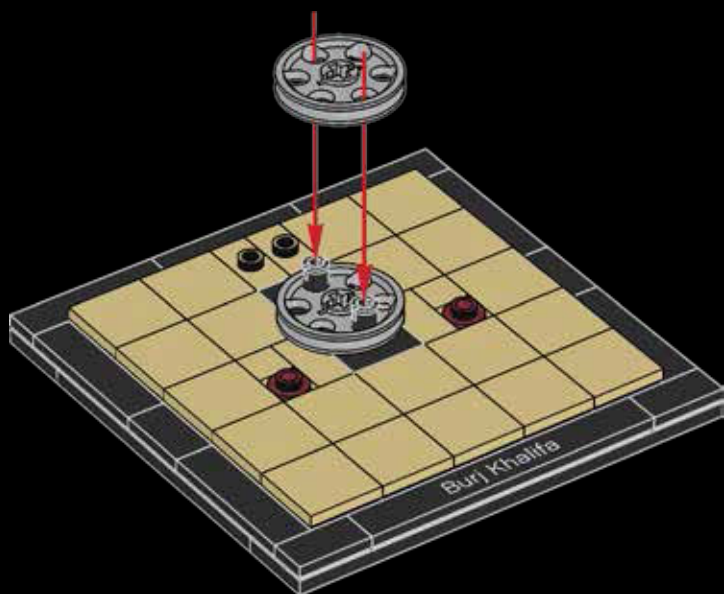

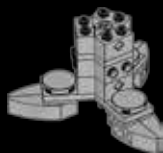

1x

1



3x

2

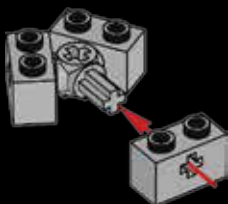



3

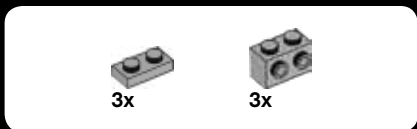
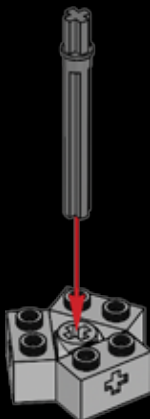

4

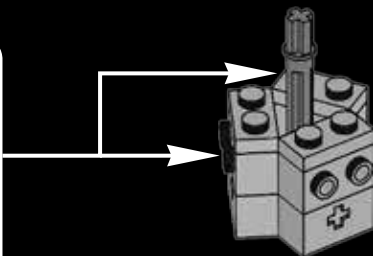
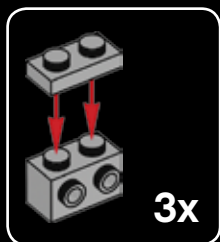



3x



1x

5

1



2

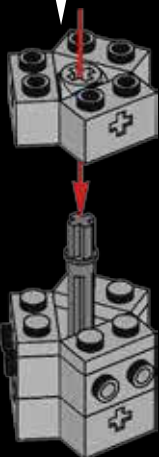
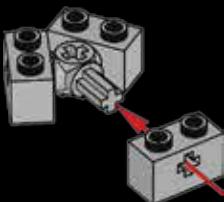

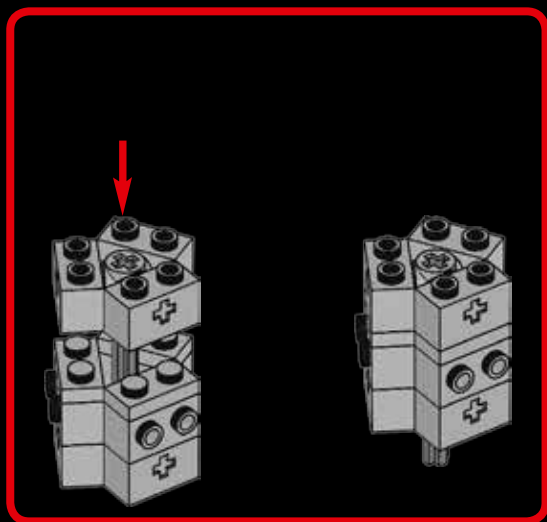



3x



1x



1x

1

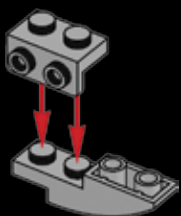

1x

2

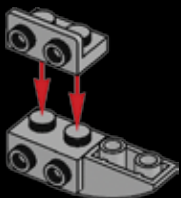



1x



1x

3

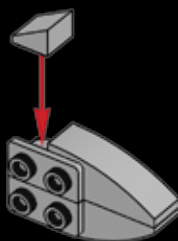

1x



1x

4

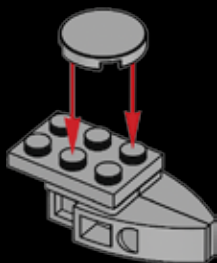

3x
45

6

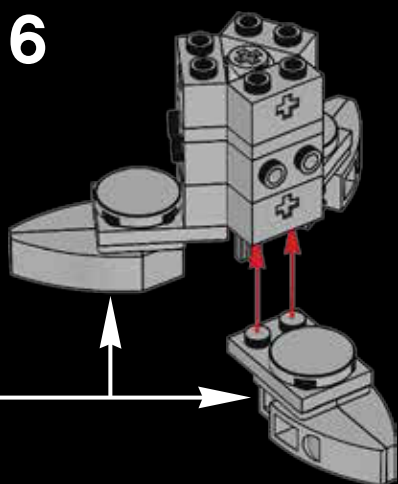

14

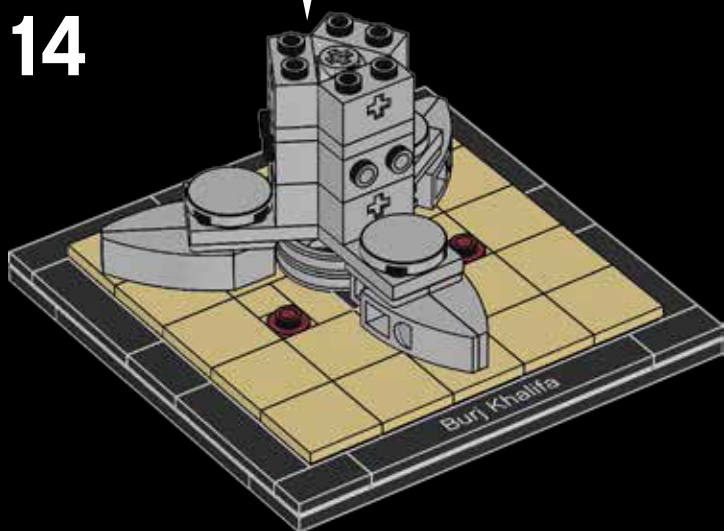



15

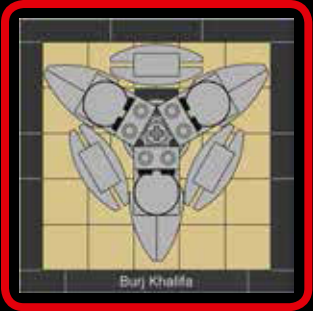
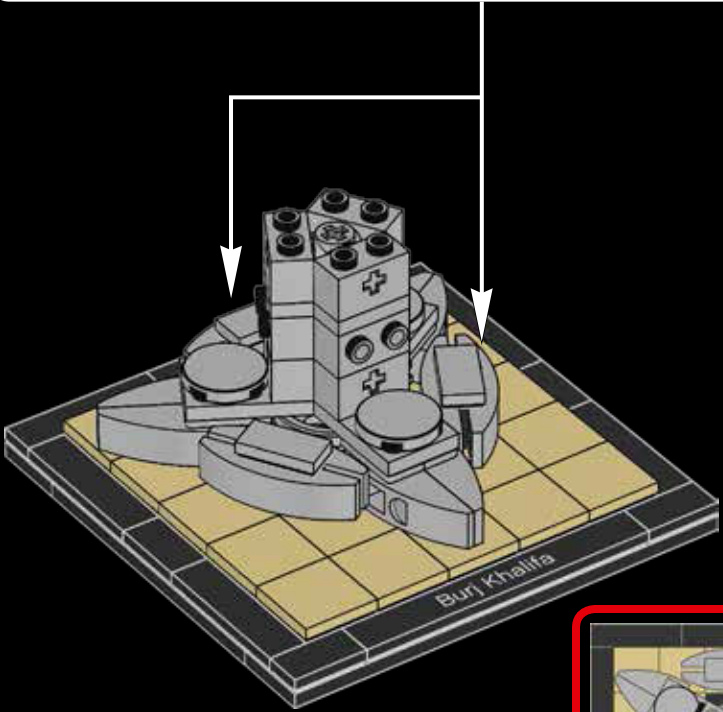
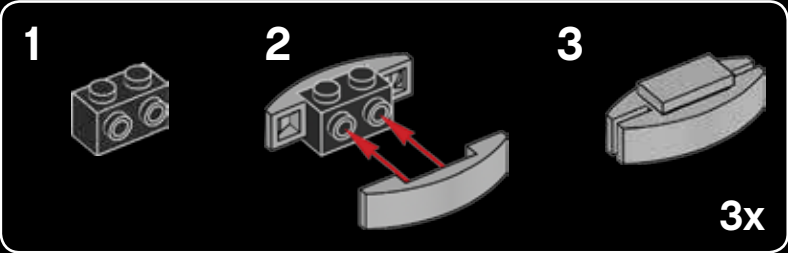



3x



6x

16

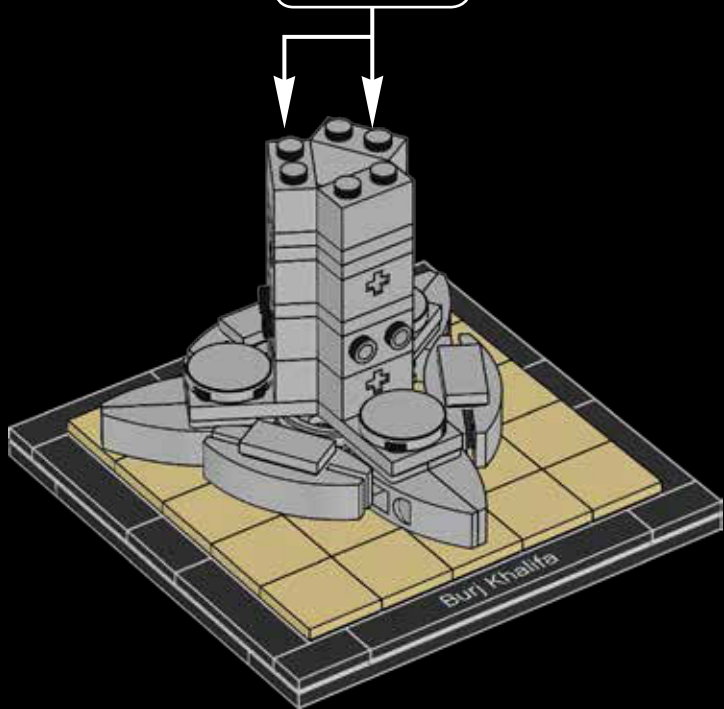
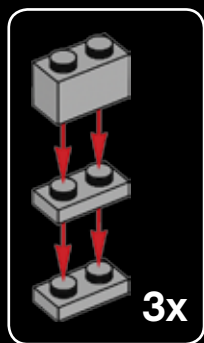



3x



1x

17

1



2

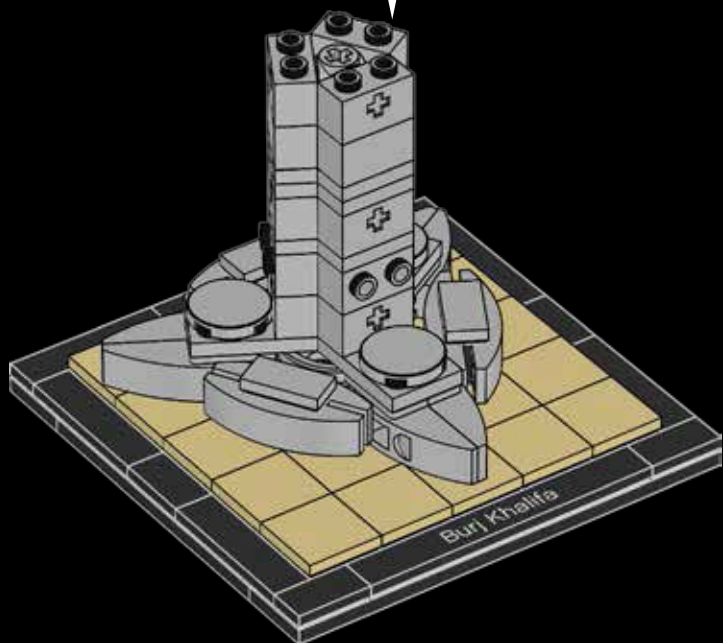
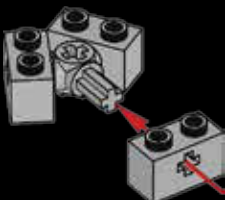

Over 26,000 glass panels were used in the exterior cladding of Burj Khalifa. Over 300 cladding specialists from China were brought in for the cladding work on the tower.



3x



3x



3x

18

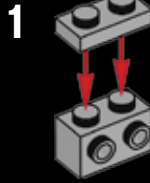

1

2



3x

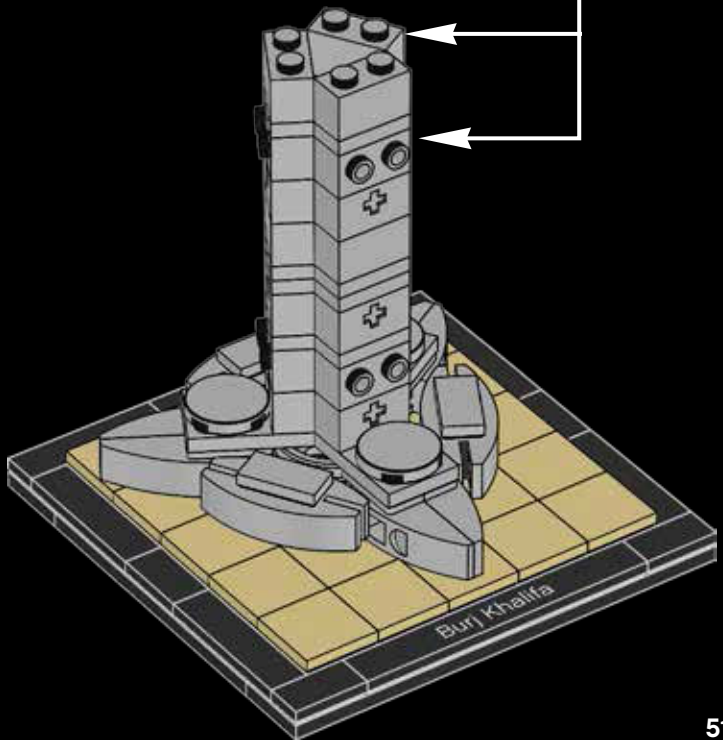

Plus de 26 000 panneaux de verre ont été utilisés pour le gainage extérieur de la tour Burj Khalifa. Plus de 300 spécialistes du gainage sont venus de Chine pour effectuer les travaux de gainage de la tour.



3x



1x

19

1



2

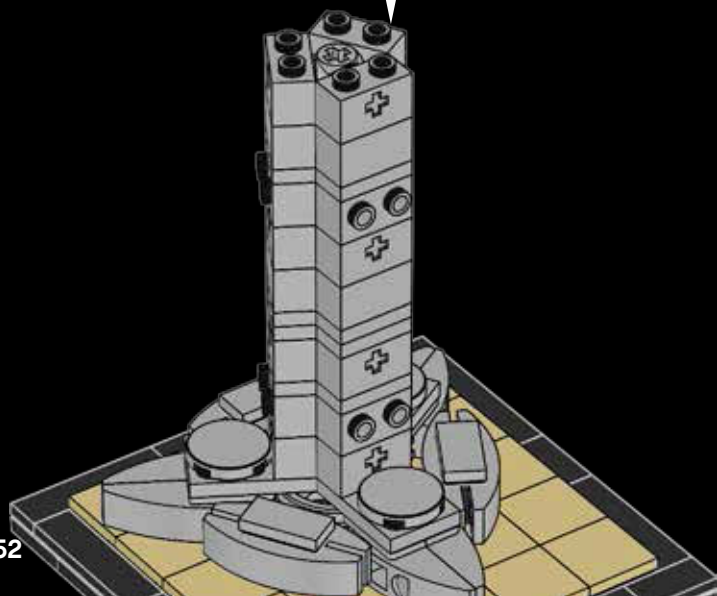
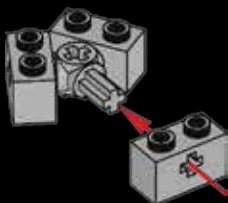

Se emplearon más de 26.000 paneles de vidrio para crear el revestimiento exterior del Burj Khalifa. La tarea estuvo a cargo de más de 300 especialistas en revestimiento procedentes de China que fueron contratados específicamente para supervisar las tareas de revestimiento de la torre.



20

1

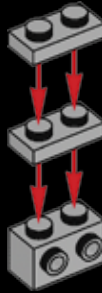

2



3x

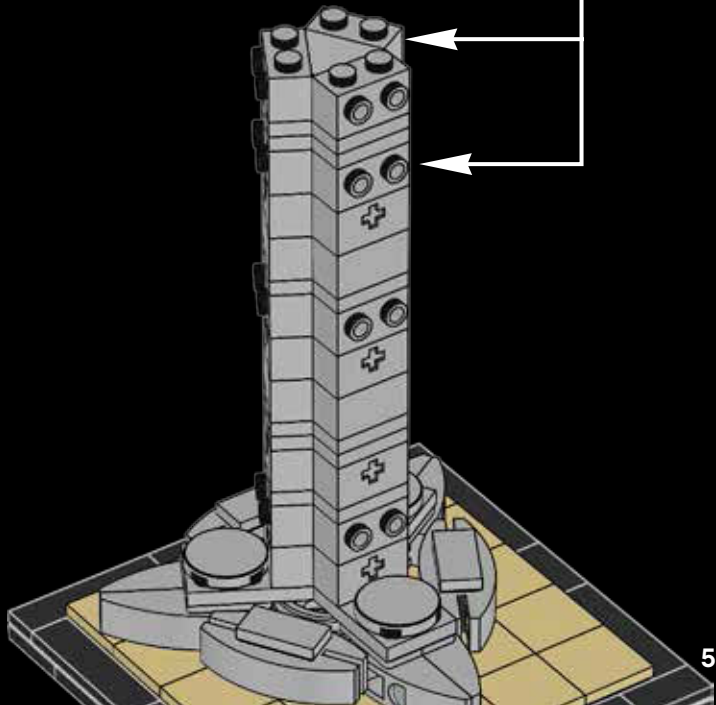



1x



1x

21

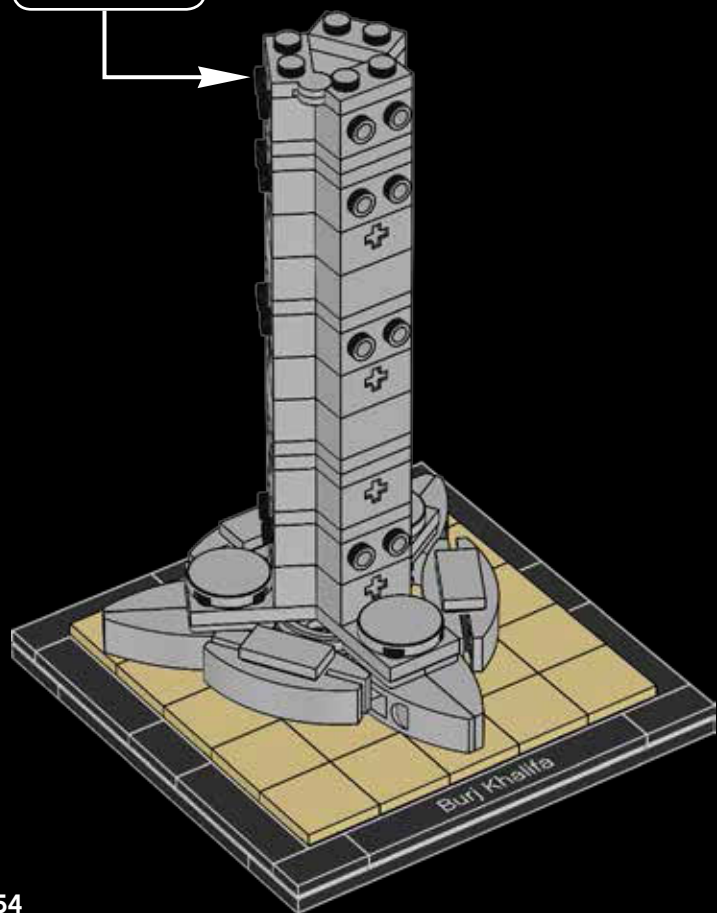
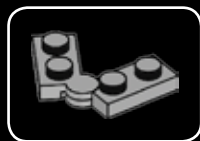
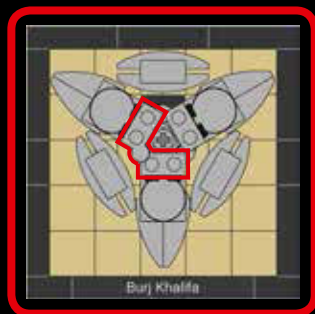



1x



1x

22

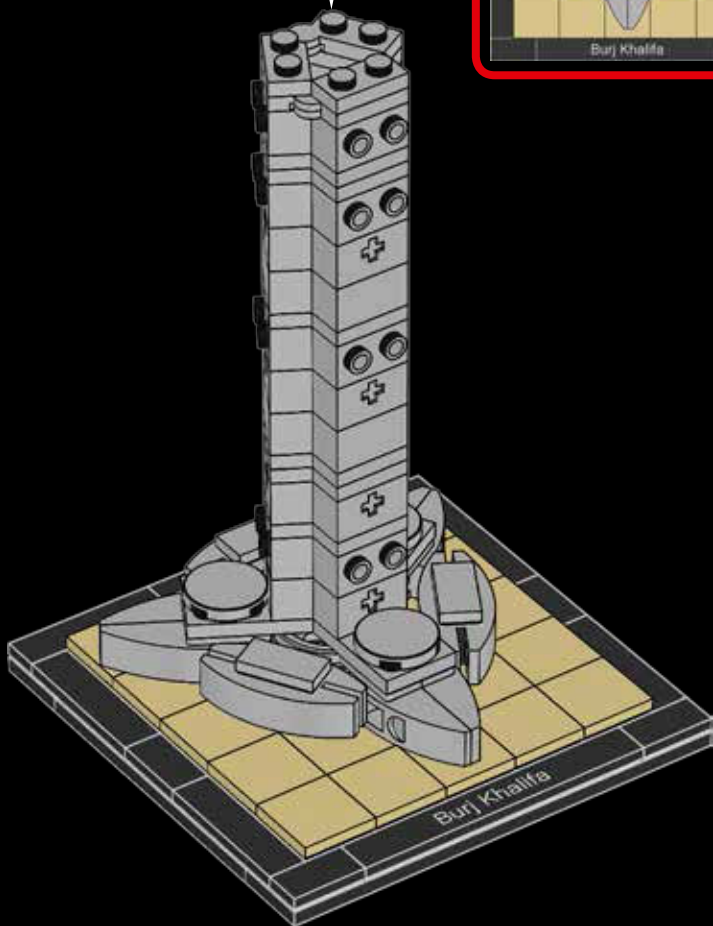
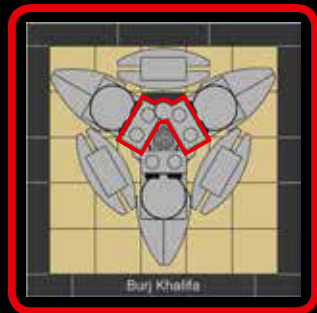



3x

23

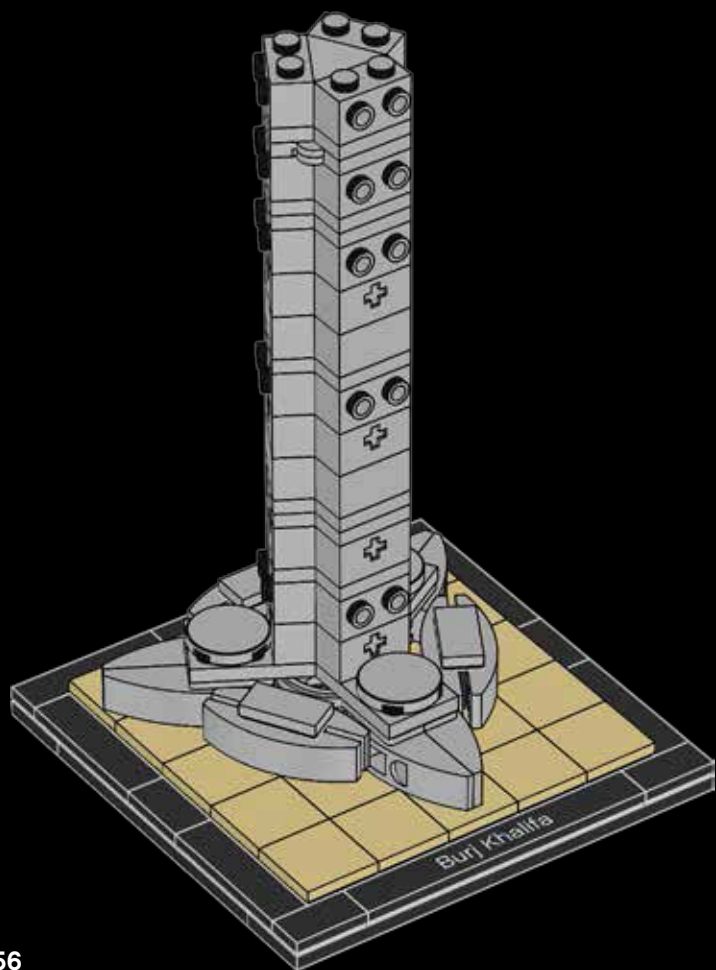



1x



1x

24

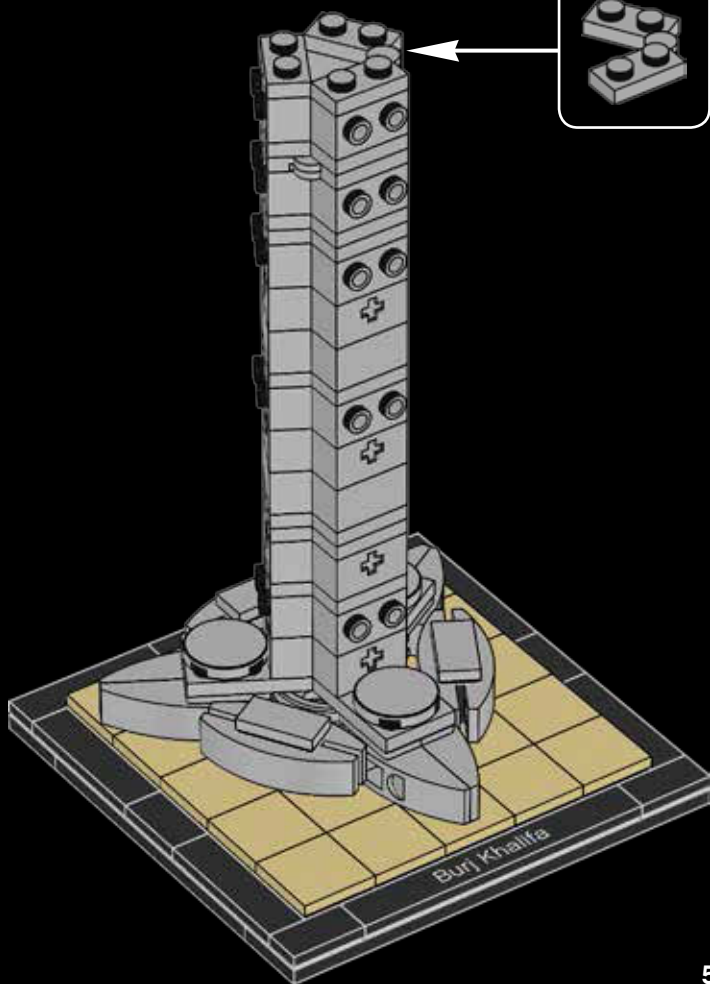
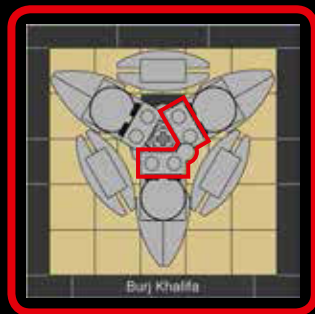



9x



3x

25

1

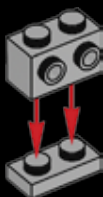

2

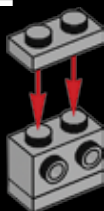

3

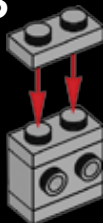

3x

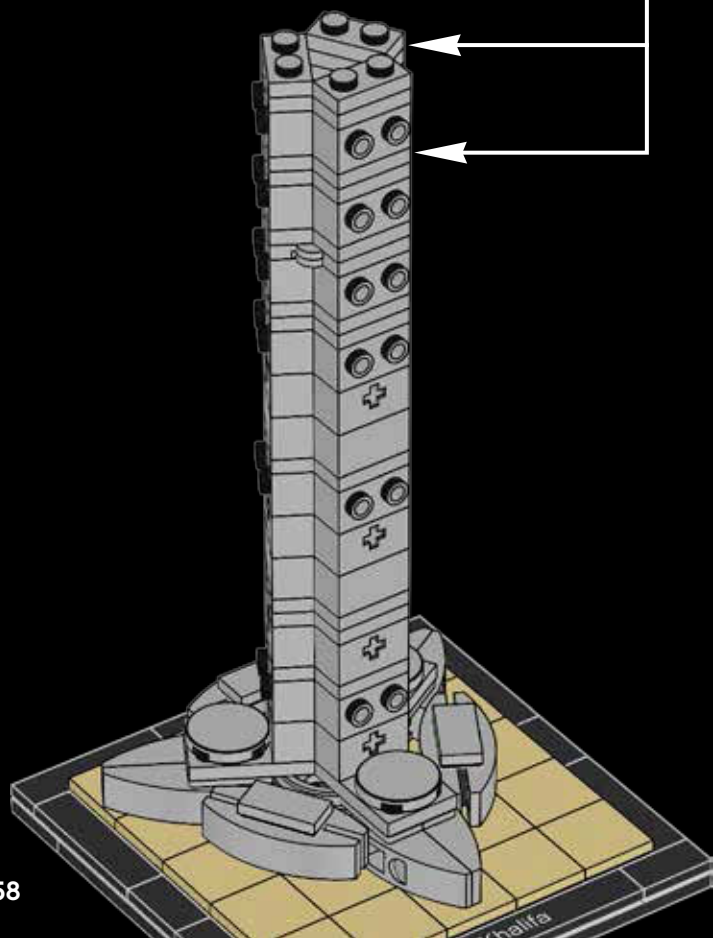



3x

26

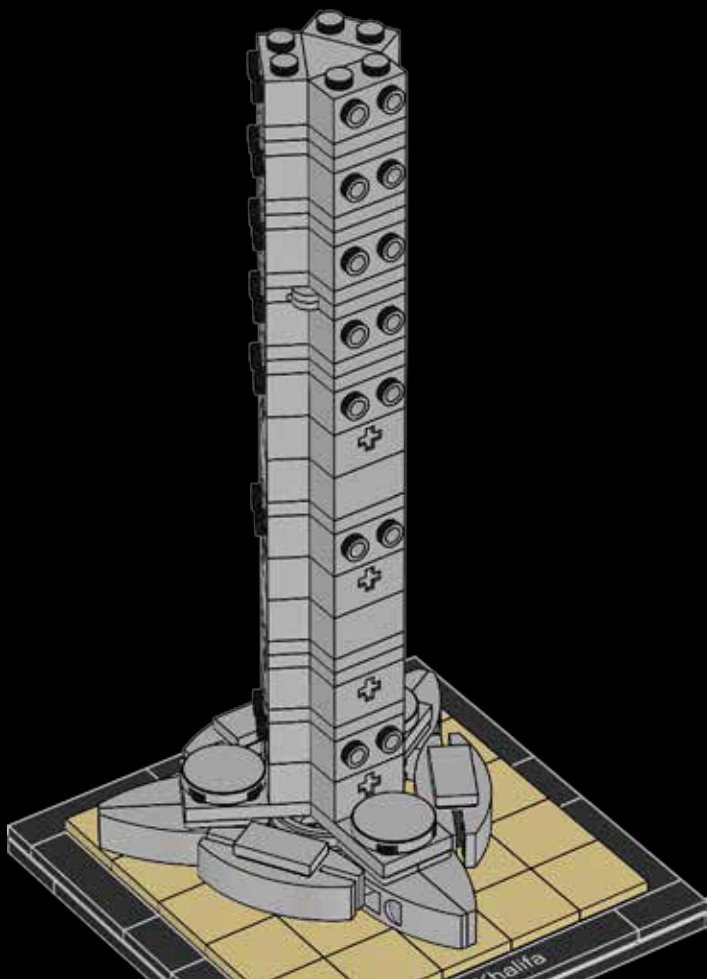



1x



1x

27

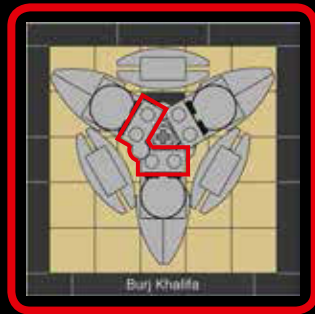
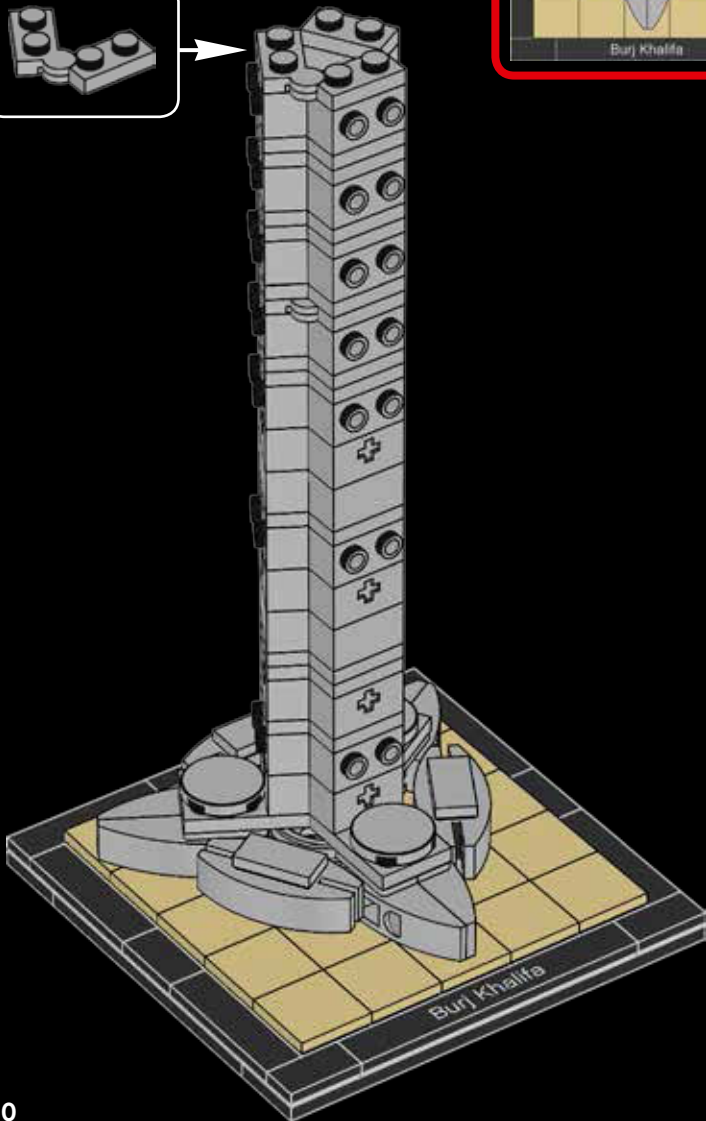



1x



1x

28

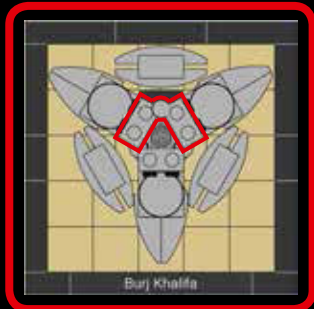

Burj Khalifa

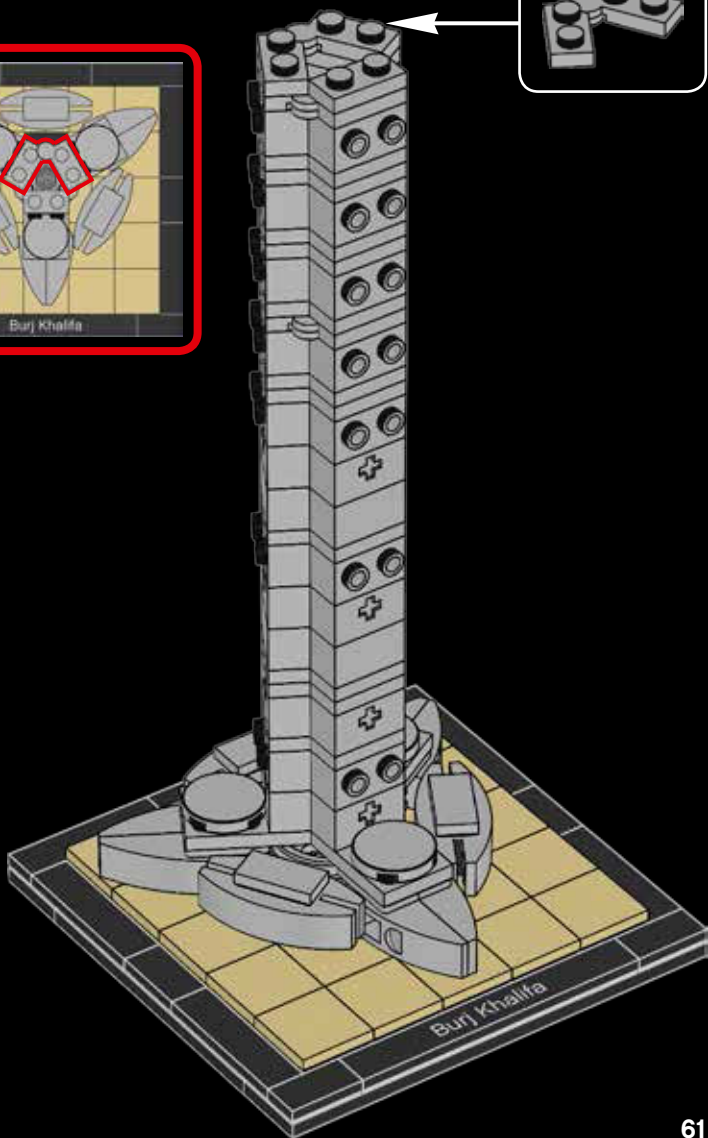
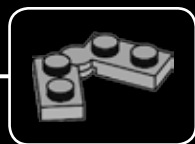



1x



2x

29



2x

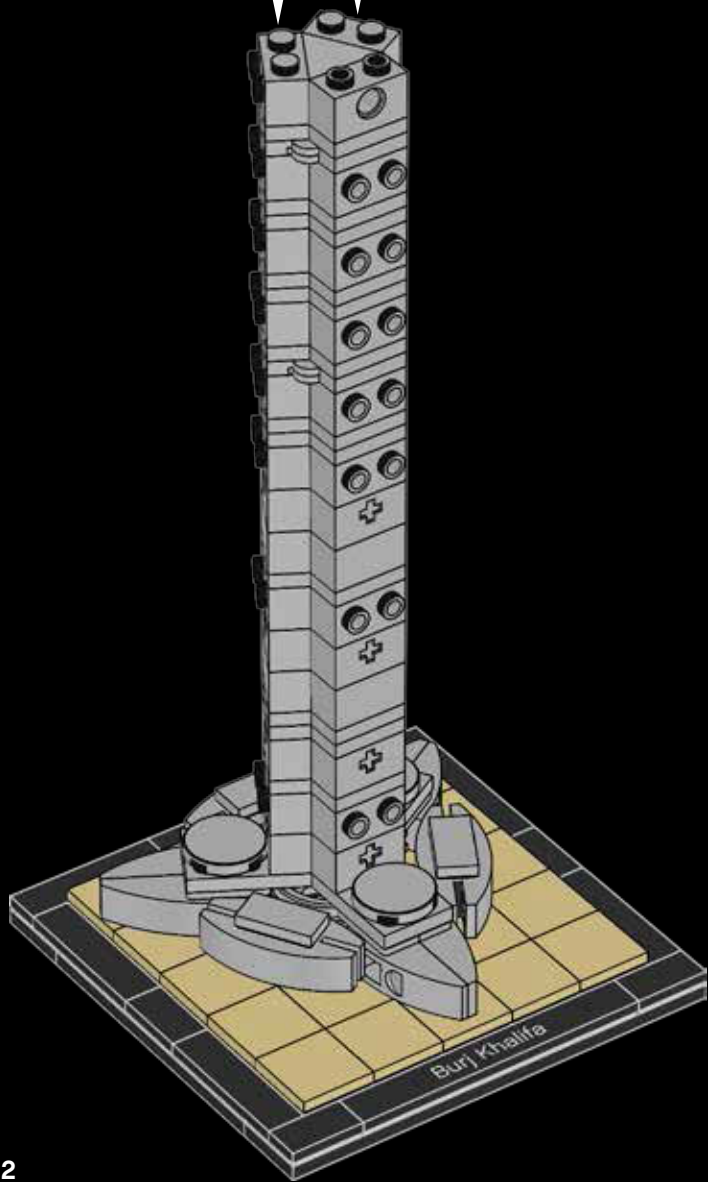



1x



1x

30

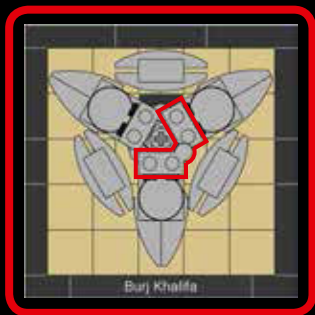
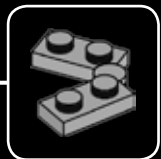
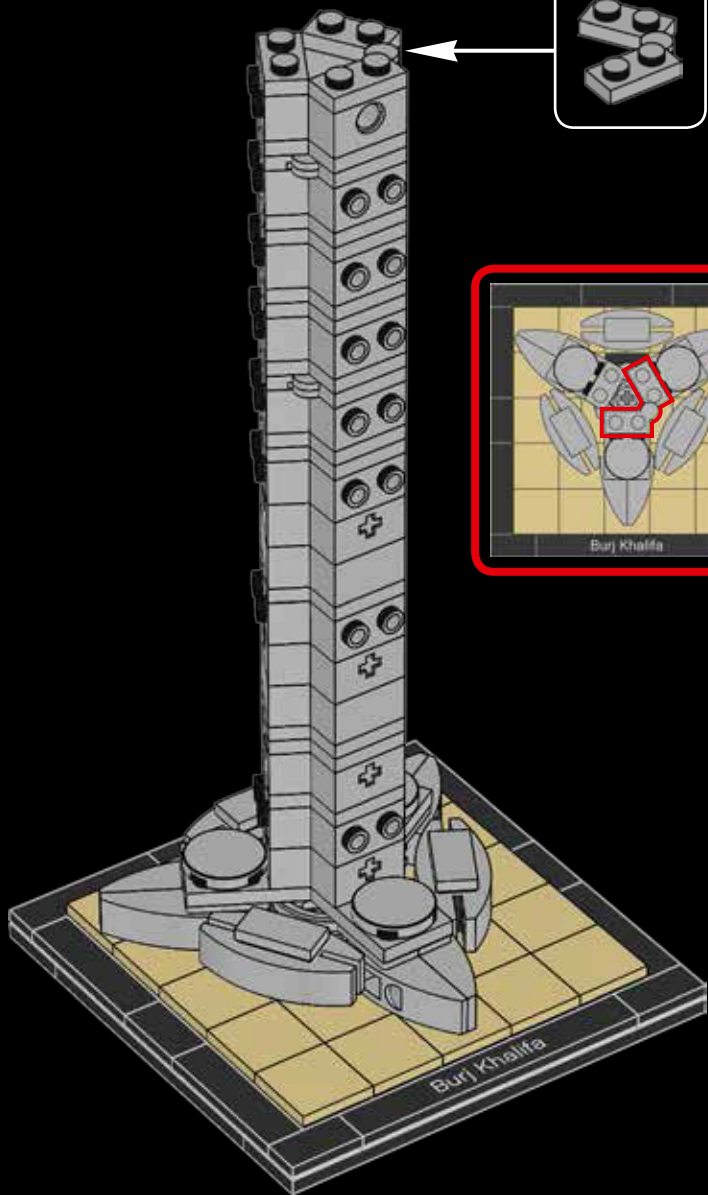



3x

31

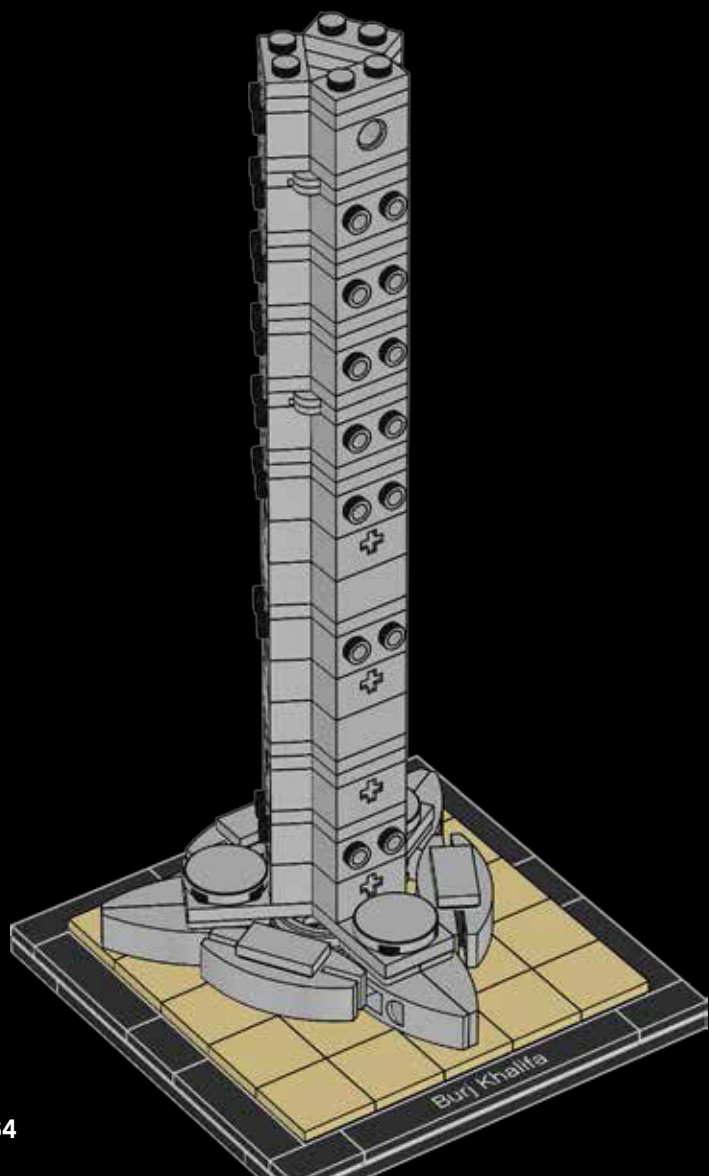



2x

32



2x

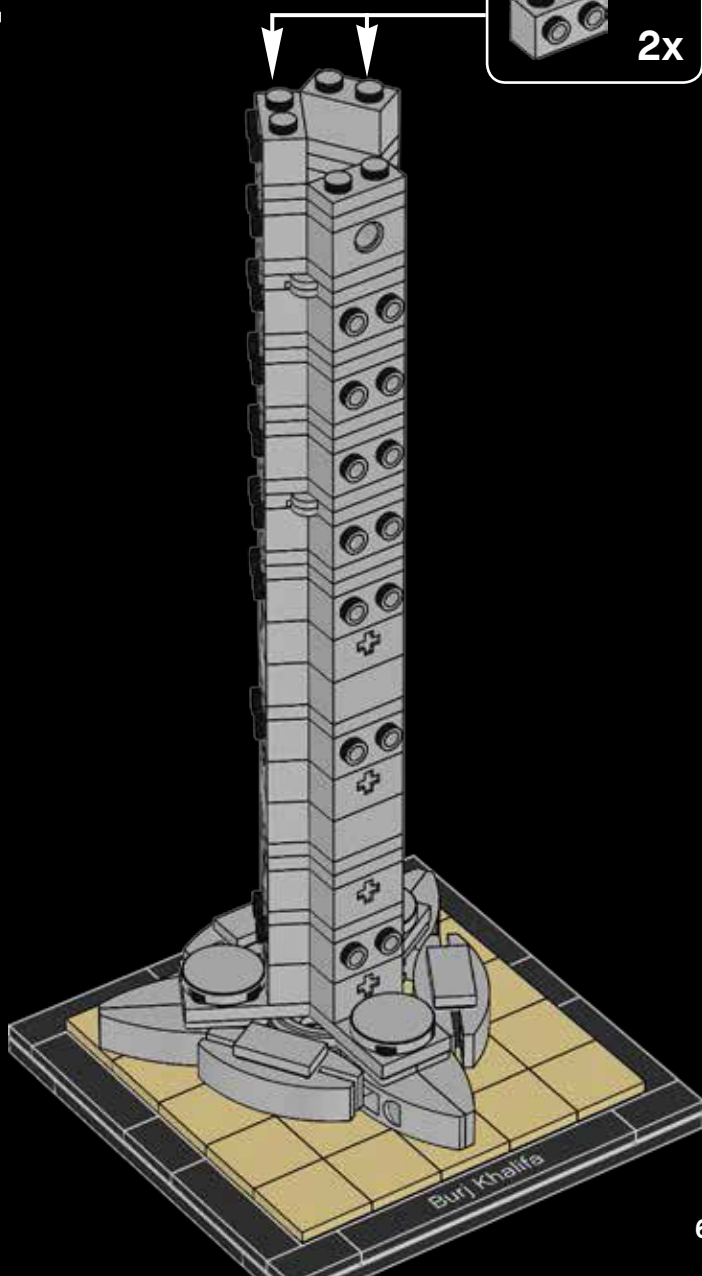

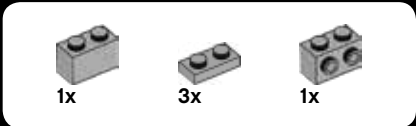

34

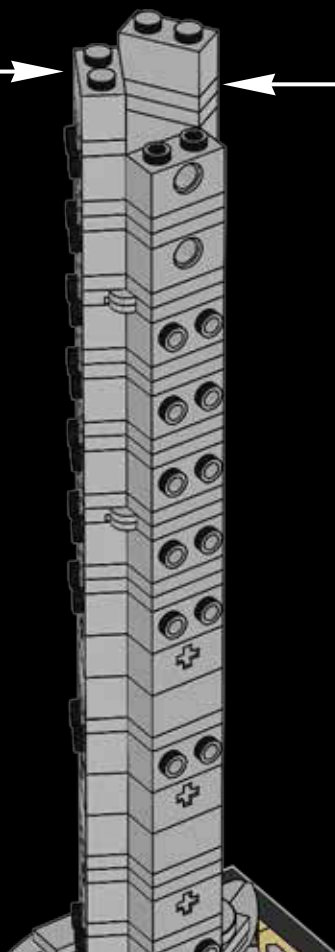
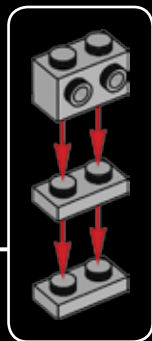
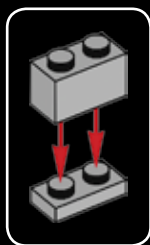

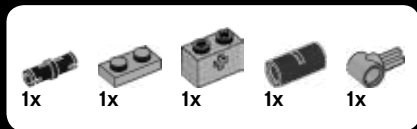

35

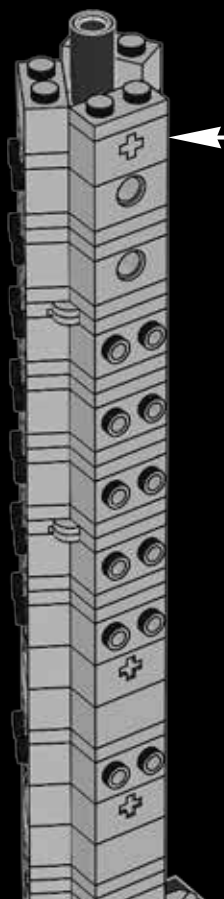
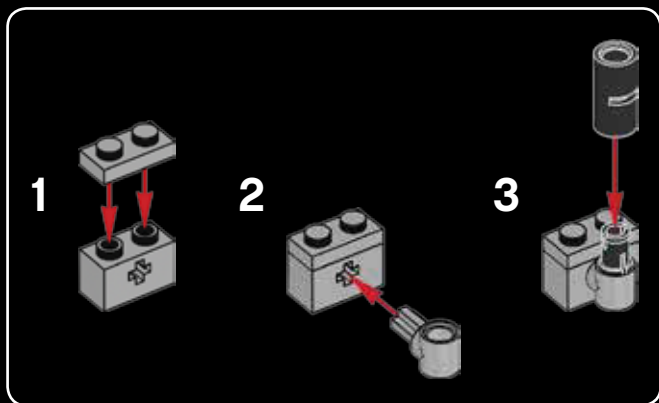



1x

36

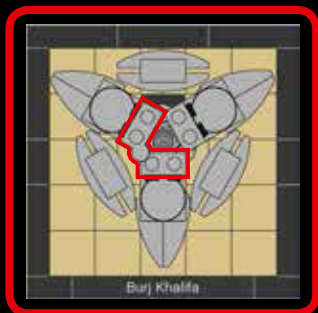
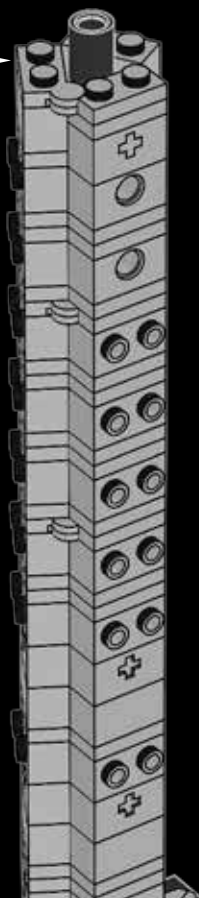
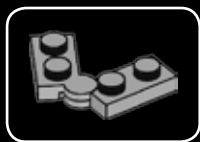



1x



1x

37

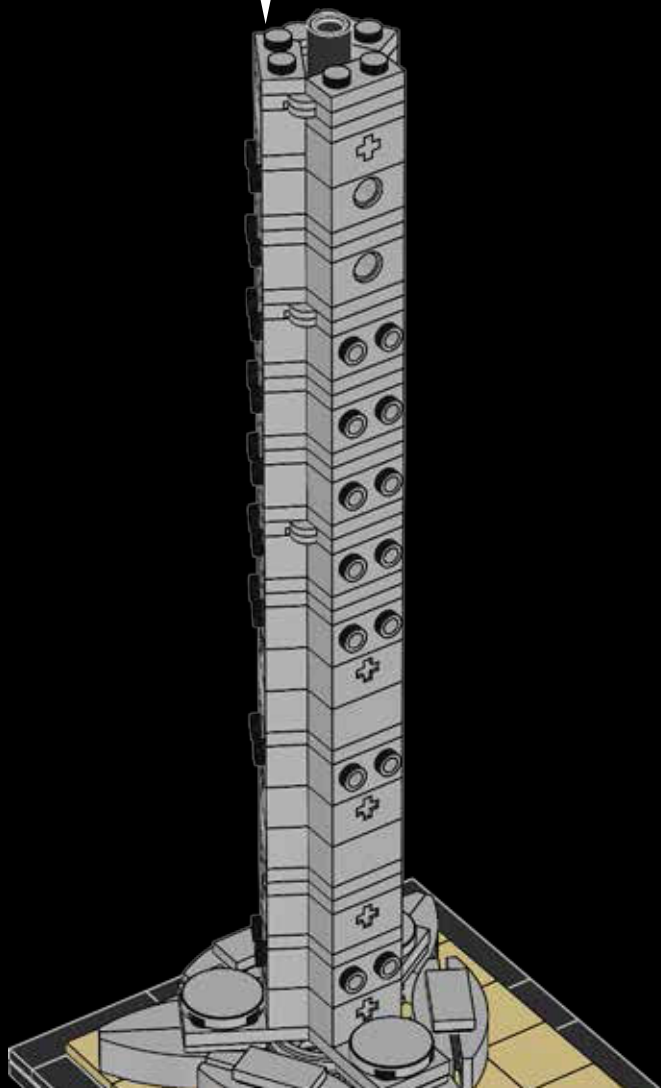
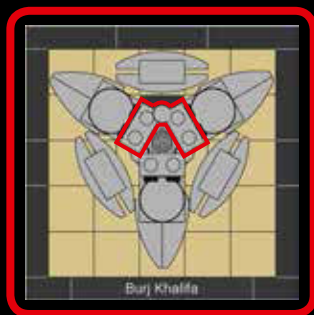



1x



1x

38

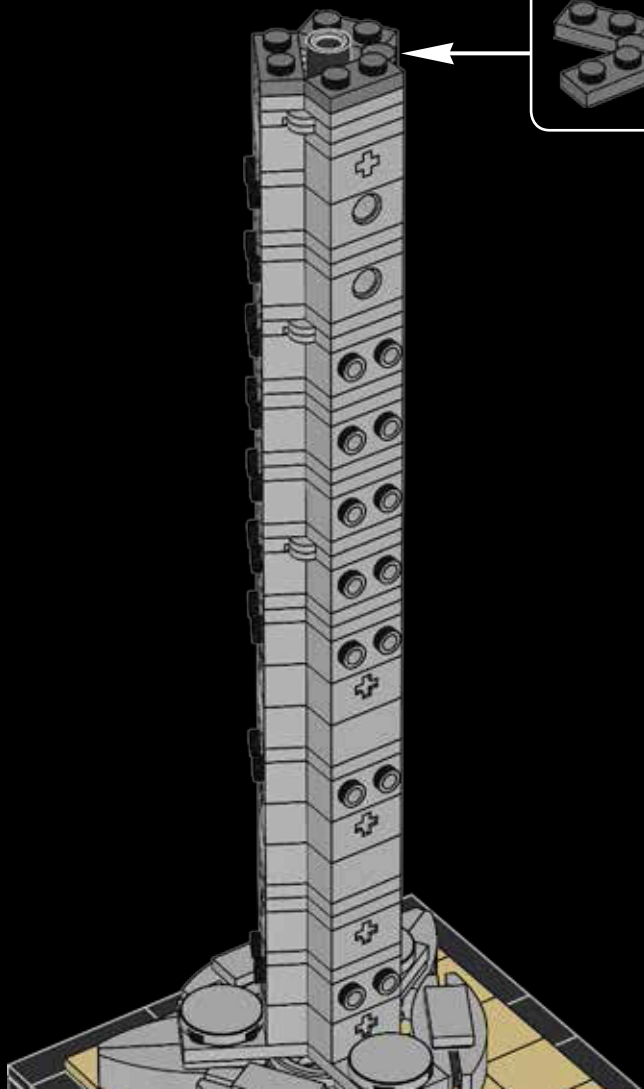
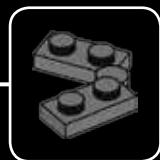
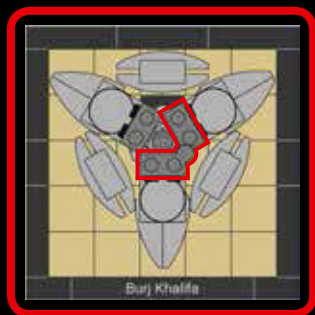



2x



3x

39

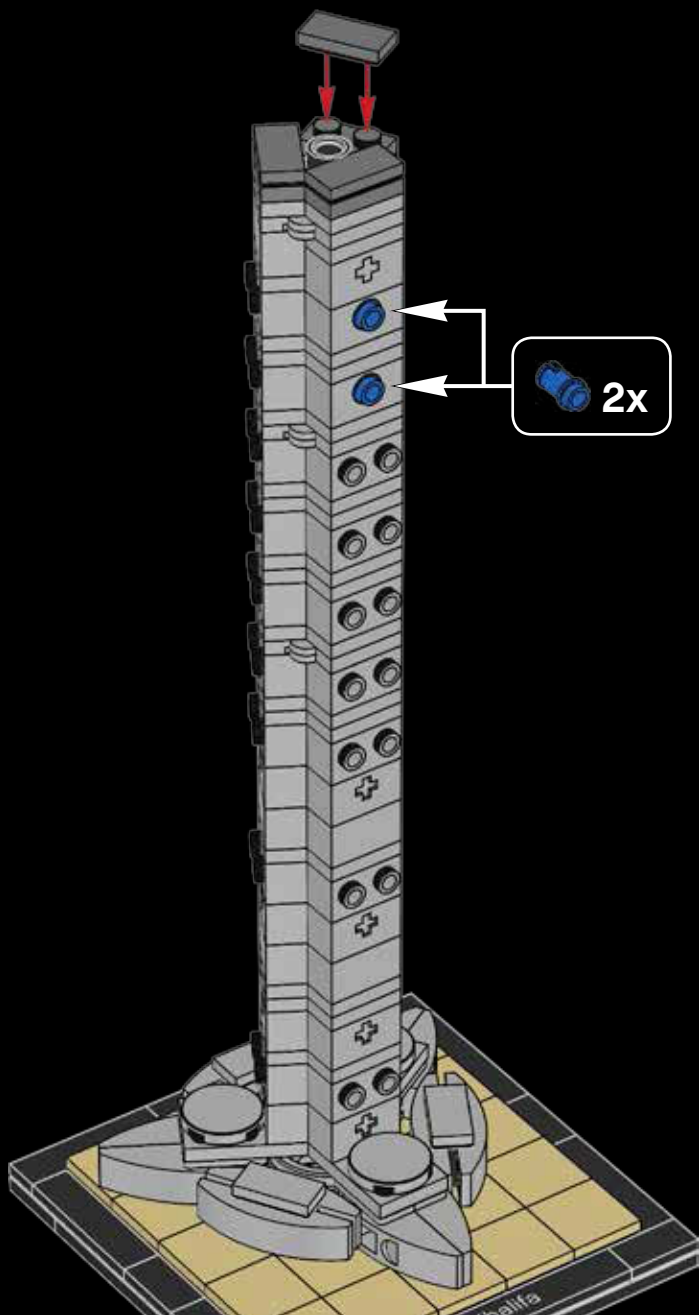



1x

40

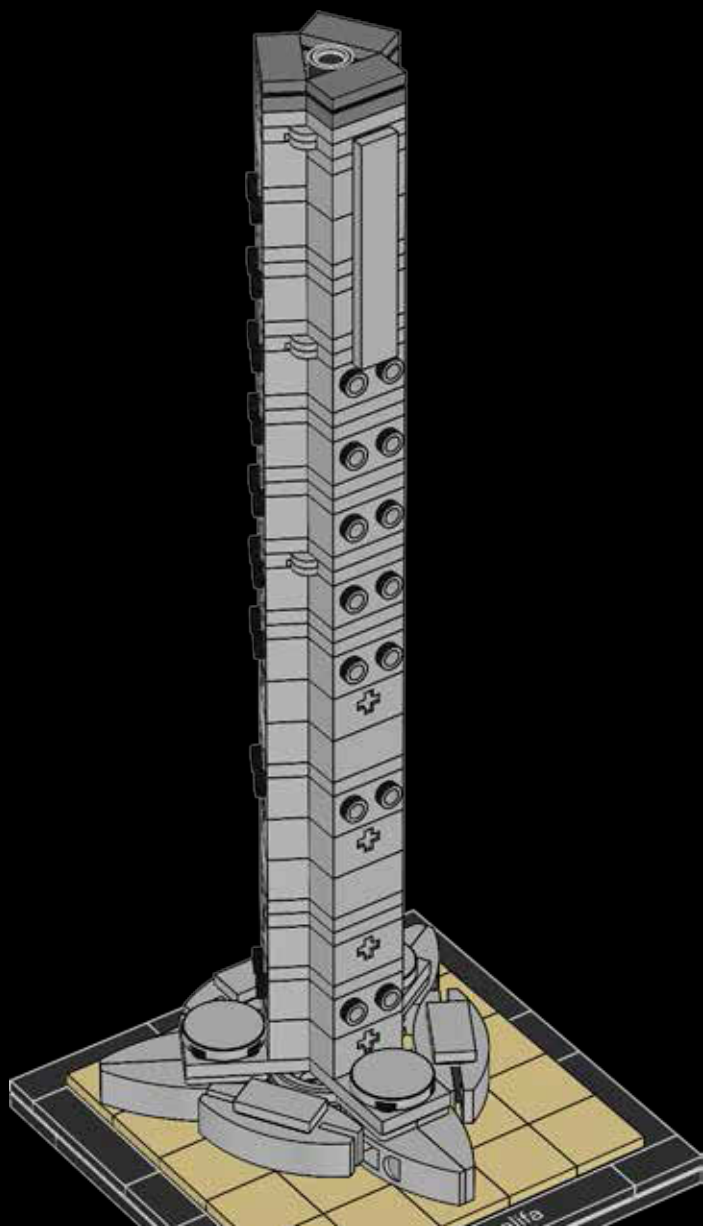

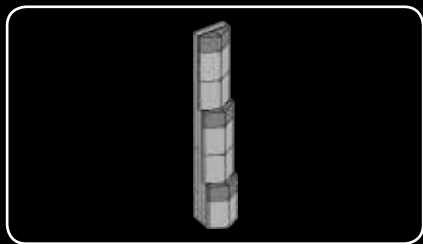

1x



1x

1

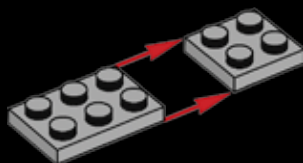

1x

2

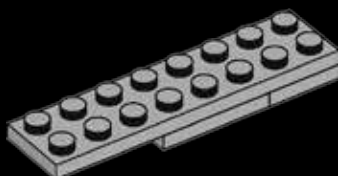



3

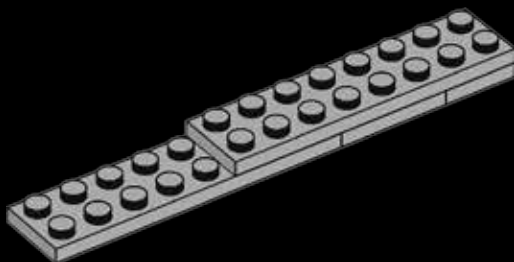

4

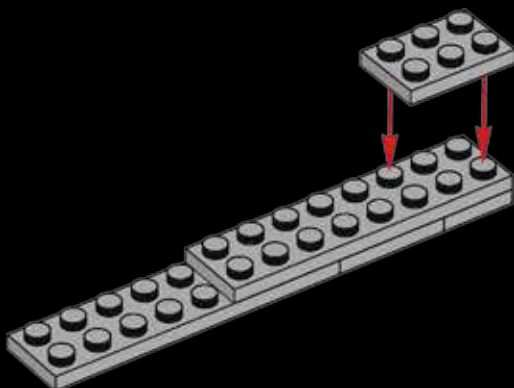



2x



2x

5

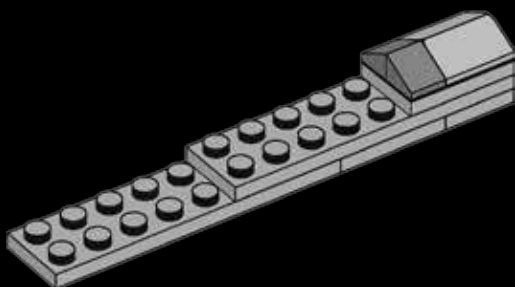

2x



4x

6

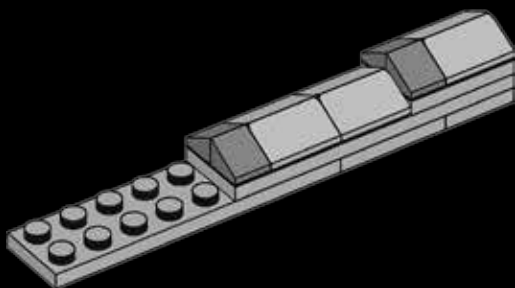



2x



4x

7

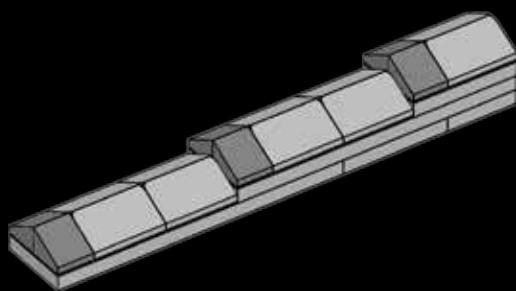

41

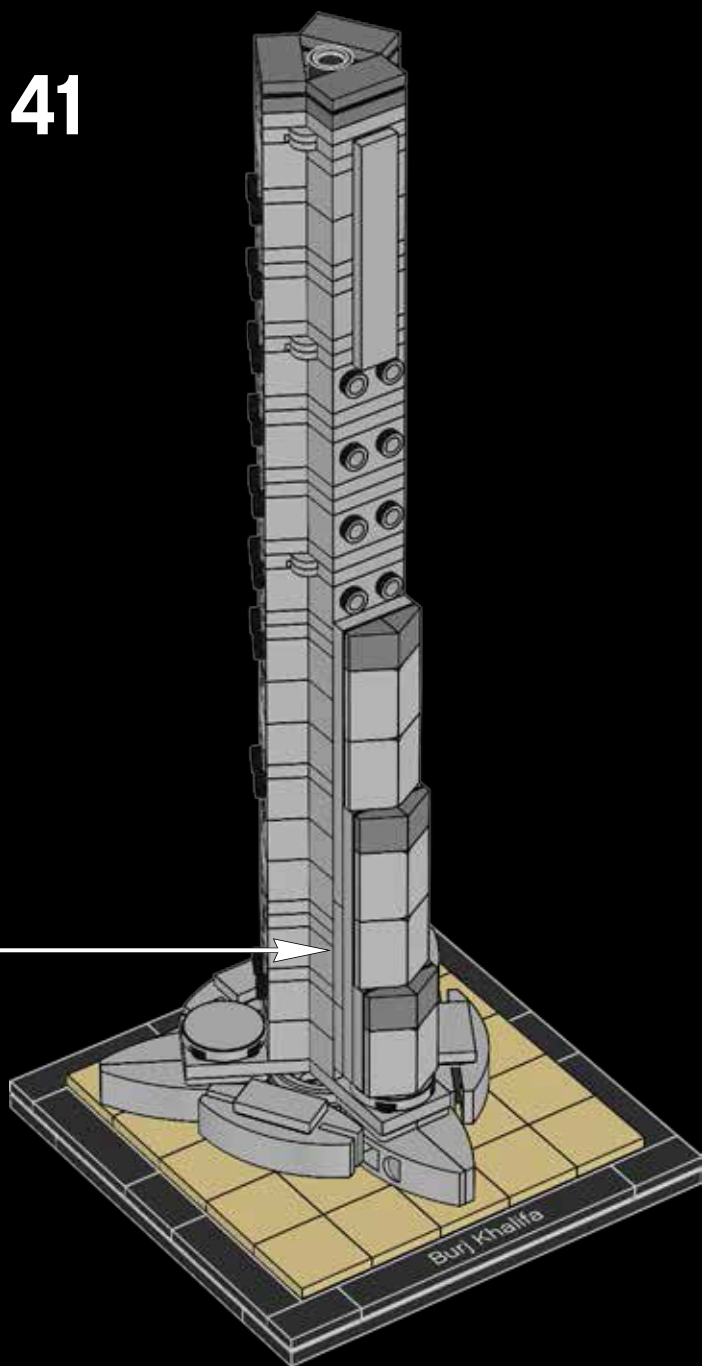

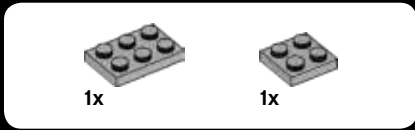
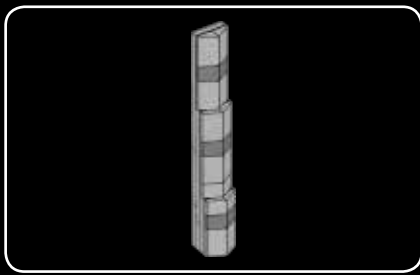

1

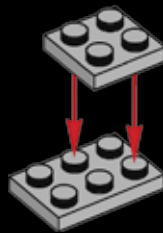

2

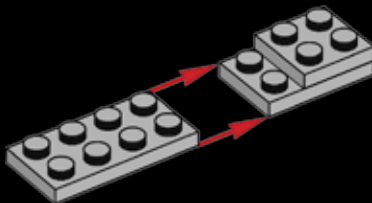



1x

3

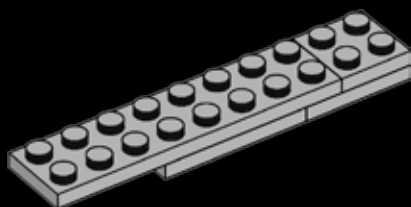

1x

4

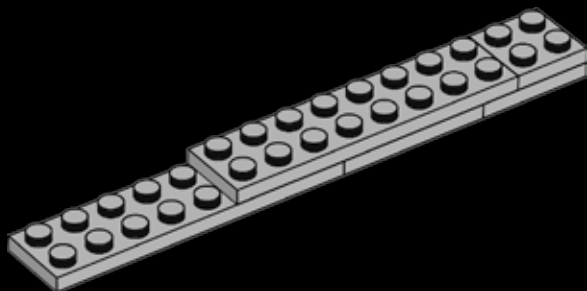



1x

5

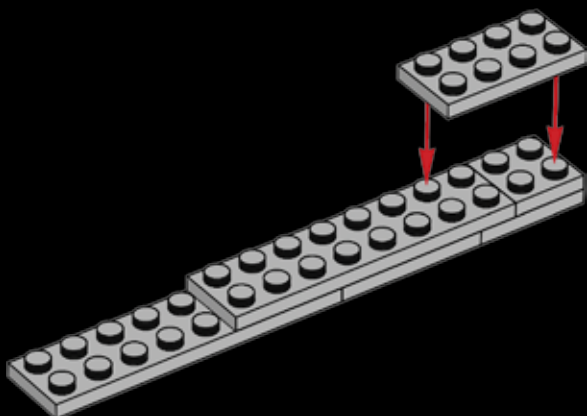

2x



2x



2x

6

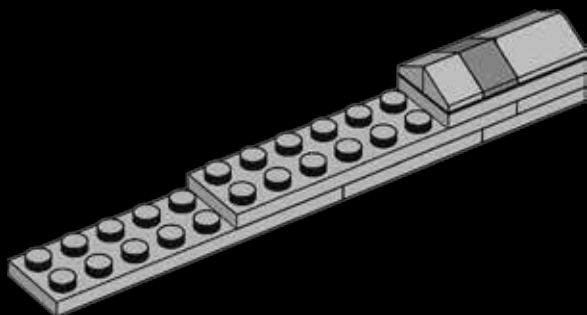



2x



2x



4x

7

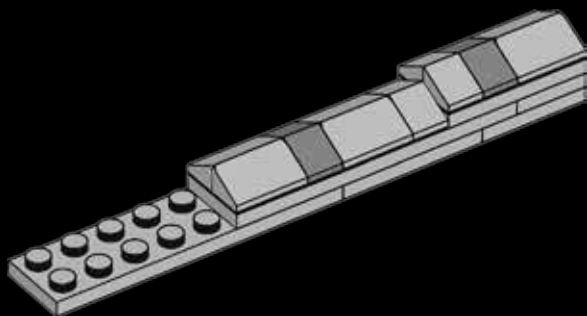

2x



4x

8

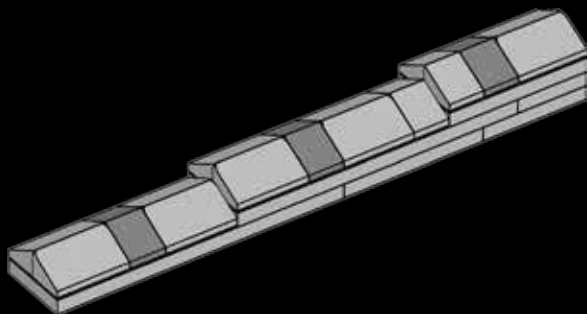

It will take 36 workers three to four months to clean the entire exterior façade using all building maintenance units.



42

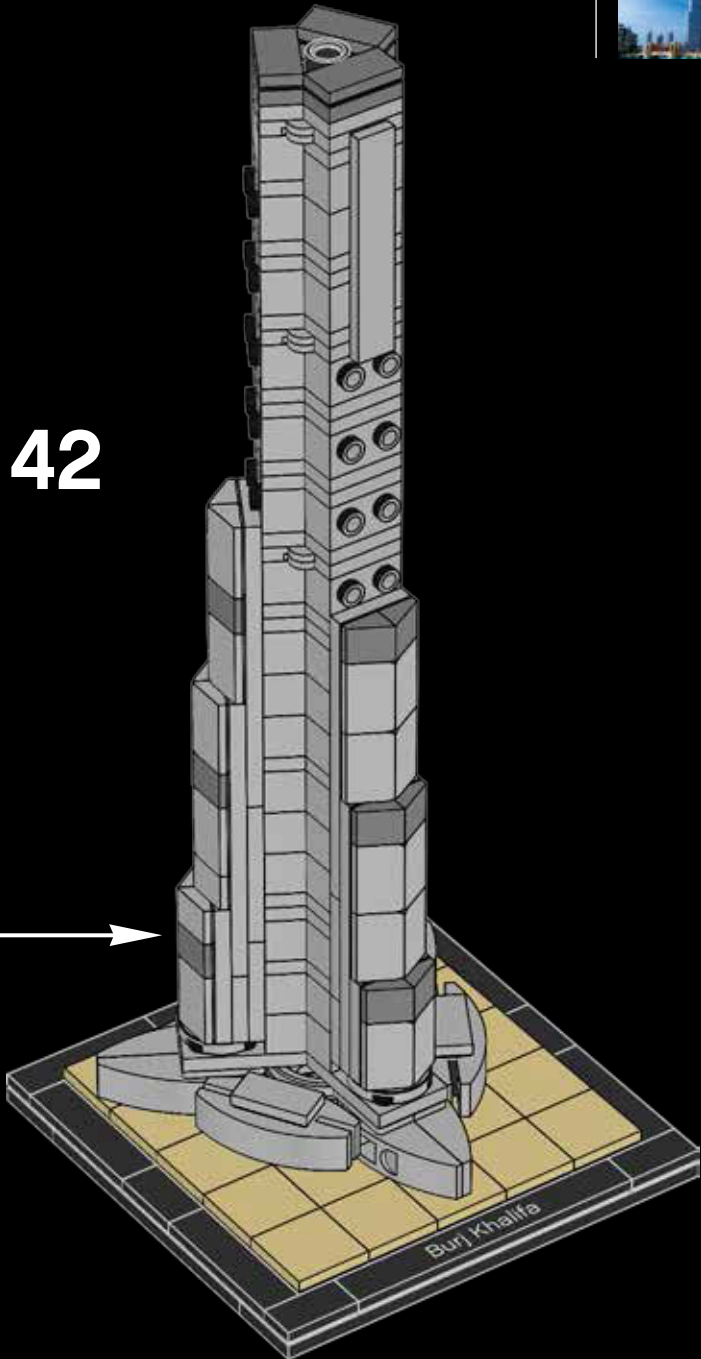

Il faudra environ trois à quatre mois à 36 ouvriers de toutes les unités d'entretien du bâtiment pour nettoyer l'ensemble de la façade extérieure.

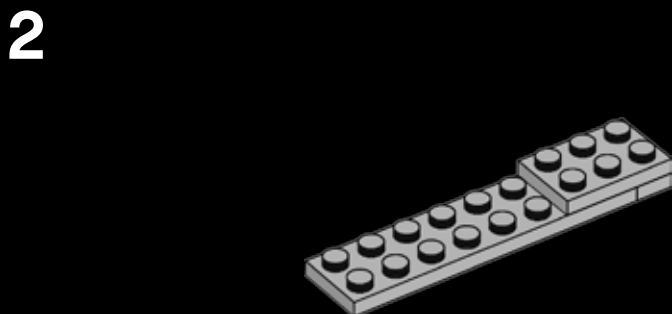
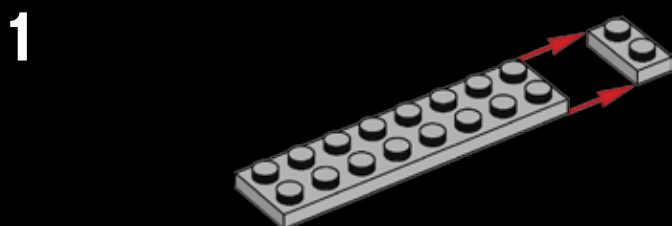
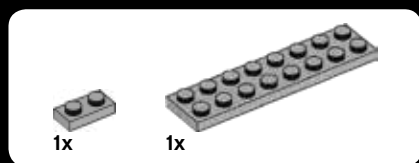
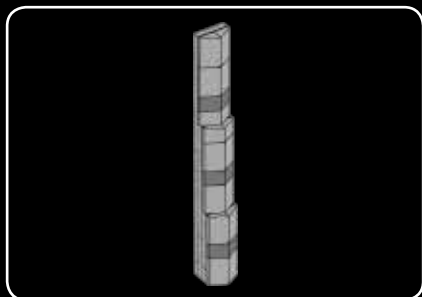

36 trabajadores necesitan entre tres y cuatro meses para limpiar la totalidad de la fachada exterior empleando todos los equipos de mantenimiento del edificio.



1x

3

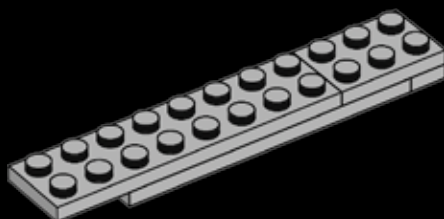

1x



1x

4

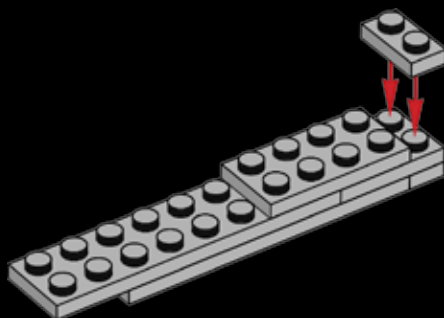



1x

5

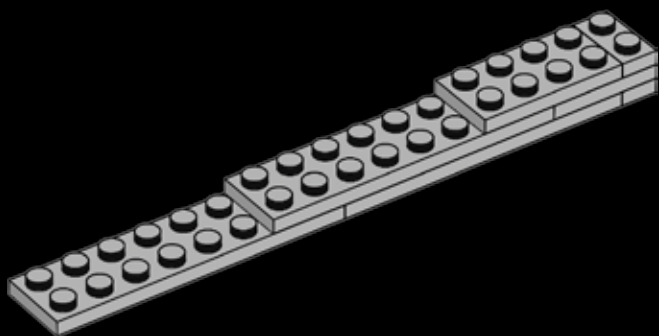

2x



4x

6

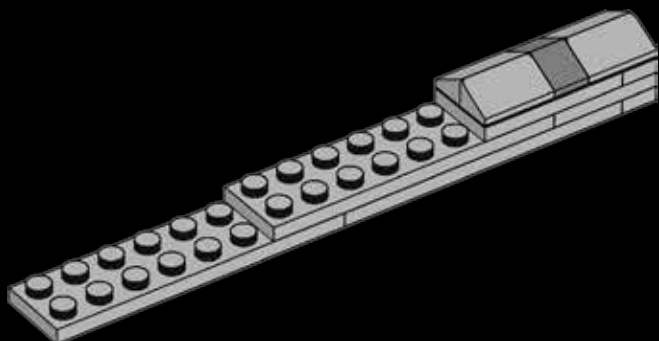



2x



2x



4x

7

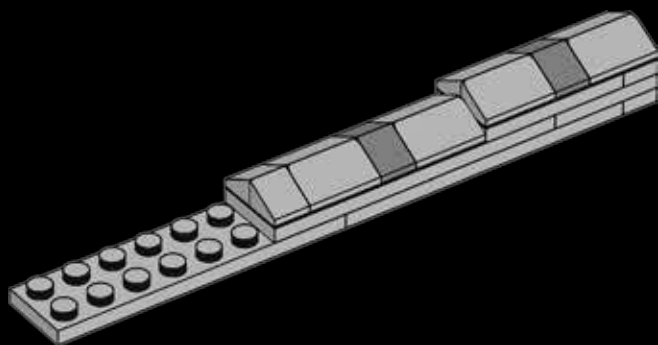

2x



2x



4x

8

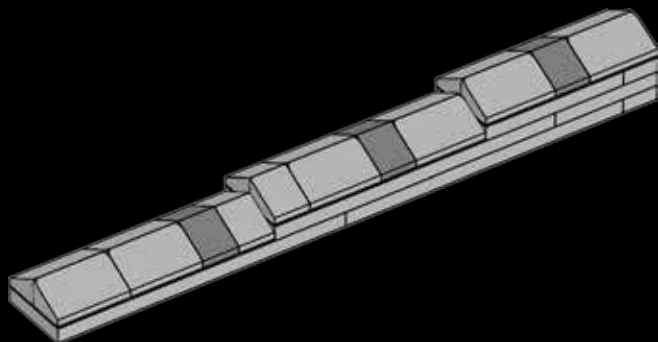

43

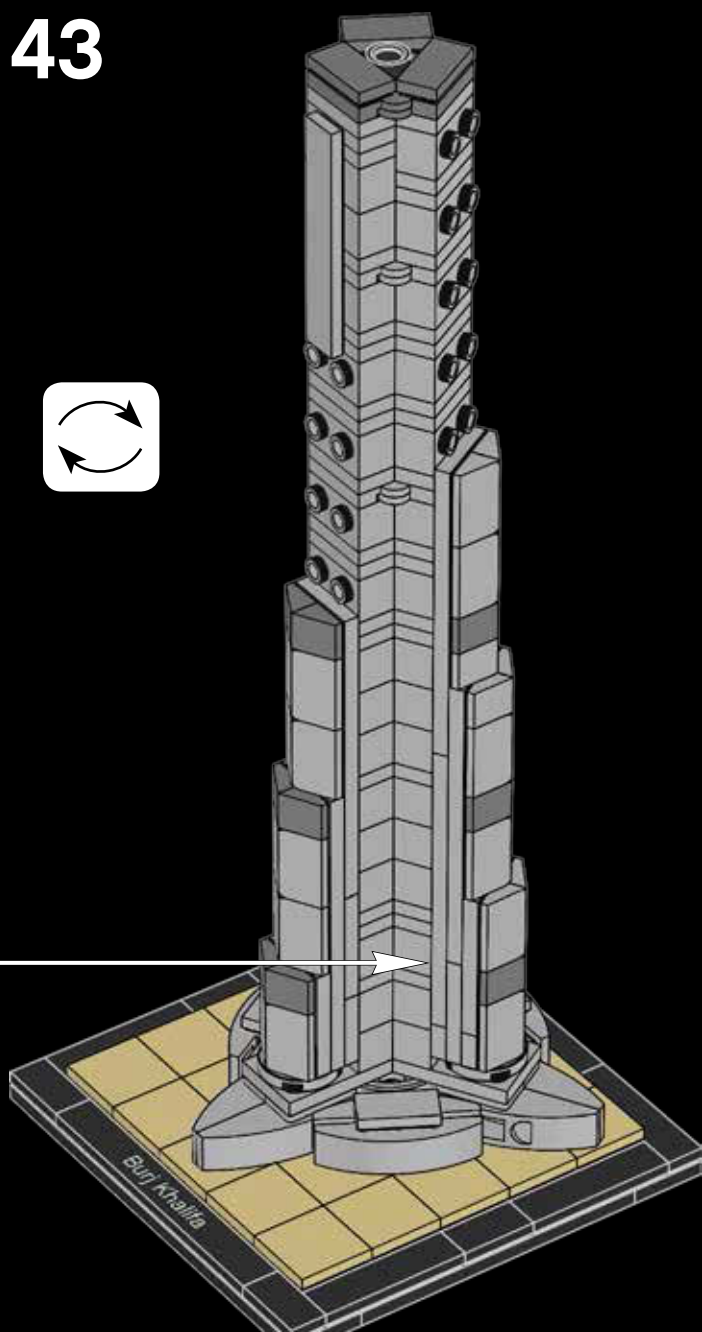



2x



6x

44

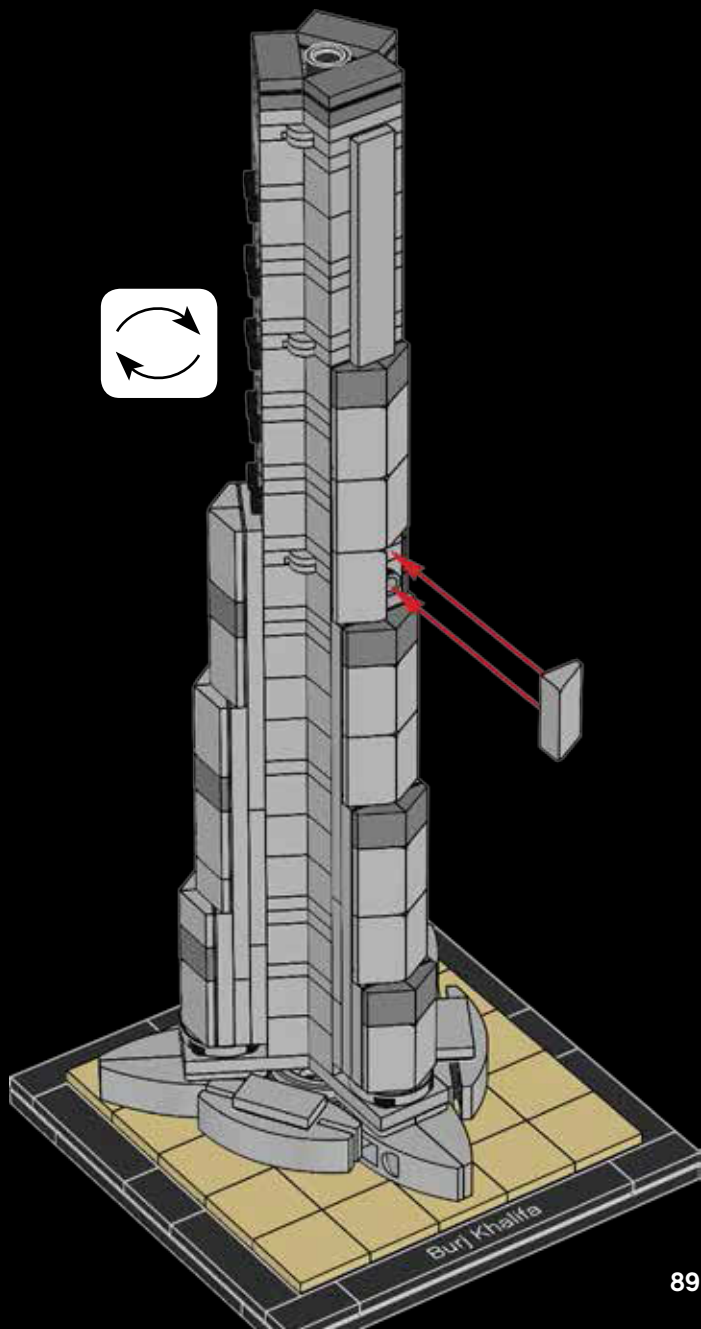



2x



8x

45

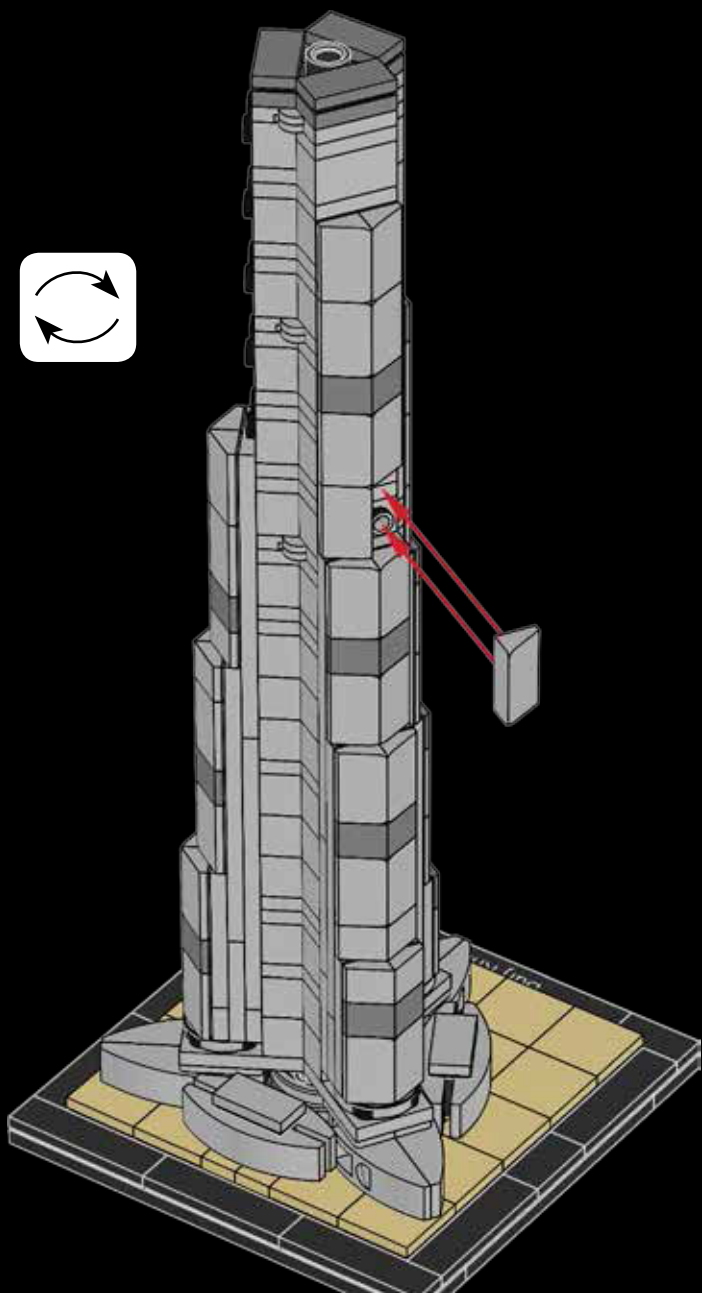



2x



8x

46

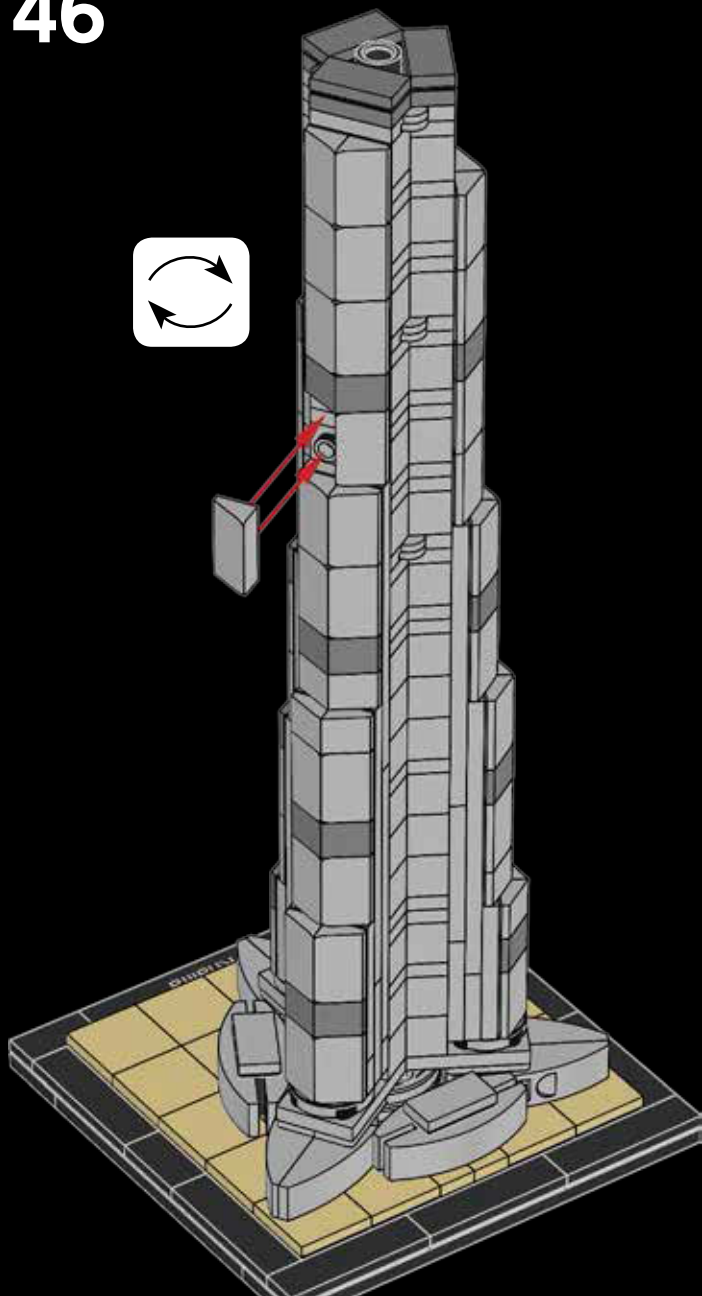

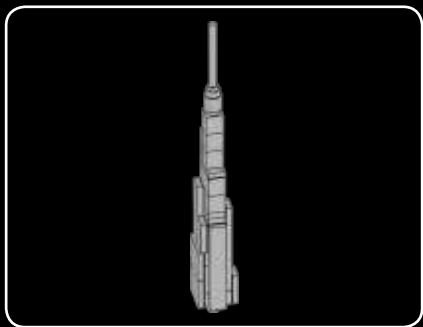

1x



1x

1

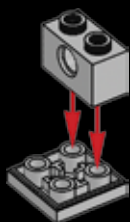

2x

2





1x

3

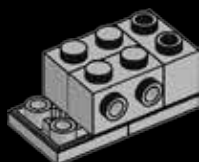

1x

4

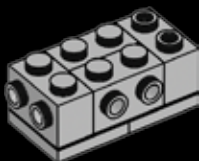



1x



1x

5

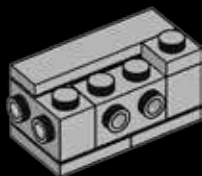

2x

6

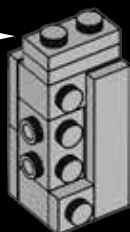
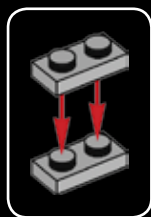

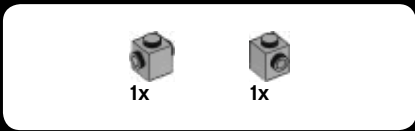

7

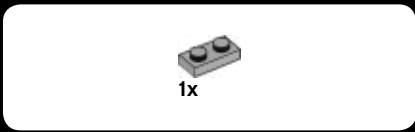
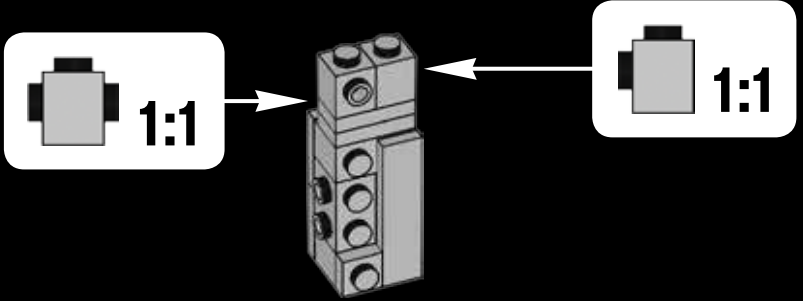

8

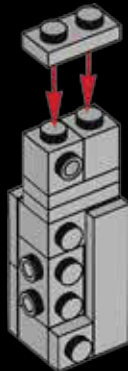



2x

9

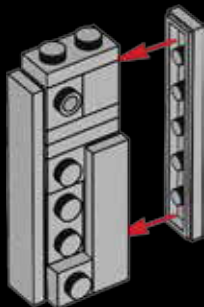

1x

10





1x

11

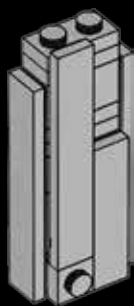

1x

12

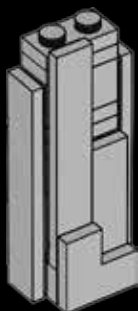



1x



1x

13

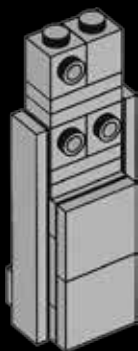

1x

14

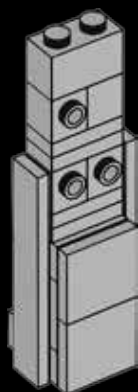



1x



1x

15

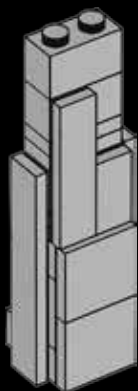



2x



1x

17

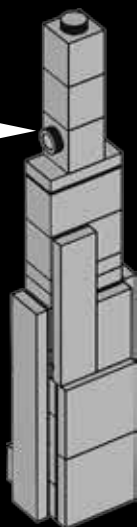
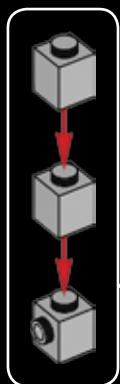



1x

18

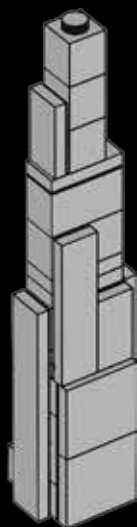

The opening ceremony of Burj Khalifa featured a display of 10,000 fireworks, light beams and further sound, light and water effects. Using 868 powerful stroboscope lights that are integrated into the façade and spire, different lighting sequences were choreographed, together with more than 50 different combinations of the other effects.



1x



1x

19

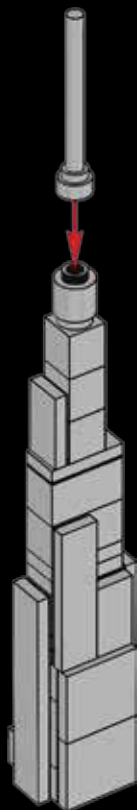

L'inauguration de la Burj Khalifa a été marquée par un spectacle combinant 10 000 feux d'artifice, faisceaux lumineux et autres jeux d'eau, de son et de lumière. Utilisant 868 puissantes lumières stroboscopiques intégrées à la façade et à l'aiguille, différentes séquences lumineuses ont ainsi été chorégraphiées, avec plus de 50 combinaisons différentes des autres effets.



1x

20

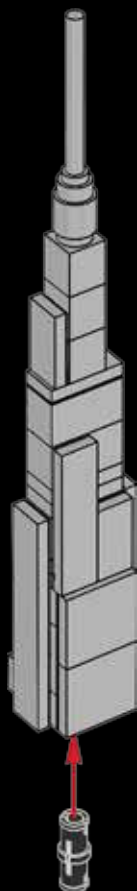

La ceremonia de inauguración del Burj Khalifa contó con un espectáculo en el que se emplearon 10.000 juegos pirotécnicos, rayos luminosos y efectos de sonido, luz y agua. Las 868 potentes luces estroboscópicas integradas en la fachada y la espiral reprodujeron una coreografía luminosa en la que participaron más de 50 combinaciones diferentes de efectos de otros tipos.



47

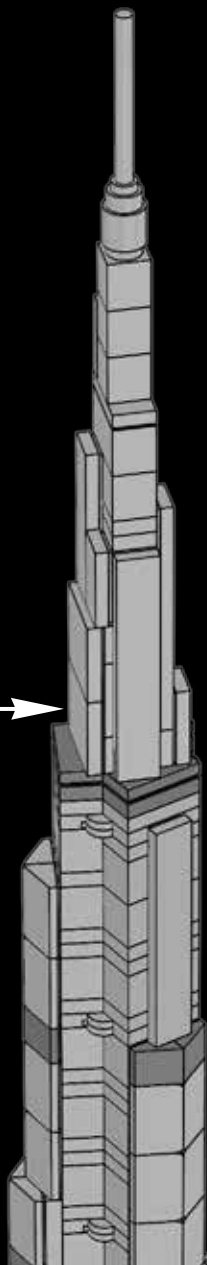

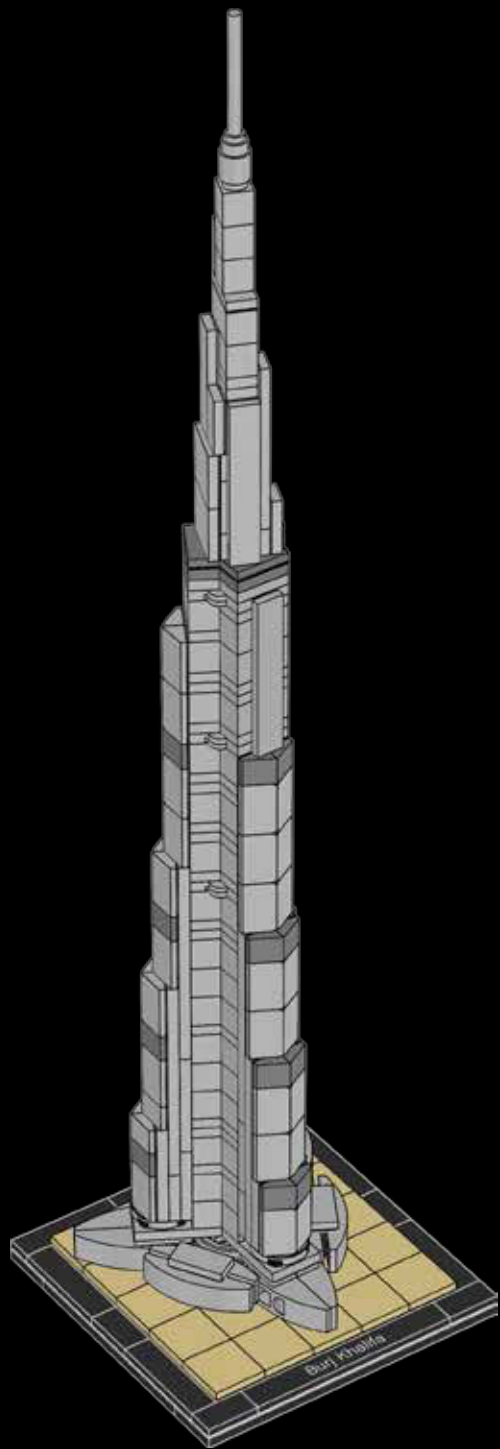



LEGO® Architecture—then and now

There has always been a natural connection between the LEGO® brick and the world of architecture. Fans who build with LEGO elements instinctively develop an interest in the form and function of the structures they create. At the same time, many architects have discovered that LEGO bricks are the perfect way of physically expressing their creative ideas.

This connection was confirmed in the early 1960s with the launch of the LEGO 'Scale Model' line. It matched the spirit of the age where modern architects were redefining how houses look and people were taking an active interest in the design of their new homes. These sets were designed to be different from the normal, brightly colored LEGO boxes; they also included a book on architecture as a source of inspiration.

Decades later, architect and LEGO fan Adam Reed Tucker revived the idea of expressing architecture using LEGO bricks and in partnership with the LEGO Group, launched the LEGO Architecture line that we know today. His first models, and the original sets in the current LEGO Architecture series, were interpretations of famous skyscrapers from his hometown of Chicago. Since then LEGO Architecture has developed and evolved, first with well-known buildings from other cities in the United States, and now with iconic structures from Europe, the Middle East and Asia.

The introduction of our LEGO Architecture Studio set echoes the ambitions of the earlier LEGO 'Scale Model' line and widens the potential of the LEGO Architecture series. Now you can enjoy building and learning about specific landmark buildings, or create exciting architectural models from your own fantasy. An inspiring 270-page book, featuring a number of renowned architects from around the world, guides you through the principles of architecture and encourages you in your own creative building.

LEGO® Architecture – Hier et aujourd'hui

Il y a toujours eu une connexion naturelle entre la brique LEGO® et le monde de l'architecture. Les fans qui construisent avec des éléments LEGO développent instinctivement un intérêt pour la forme et la fonction des structures qu'ils créent. De nombreux architectes ont quant à eux découvert que les briques LEGO sont la façon idéale de matérialiser leurs idées de création.

Cette connexion a été confirmée au début des années 1960 avec le lancement de la gamme « Maquettes à l'échelle » LEGO. Cette gamme correspondait à l'esprit de l'époque, alors que les architectes modernes redéfinissaient les maisons, et que les gens s'intéressaient activement à la conception de leur résidence. Ces ensembles originaux étaient conçus pour être différents des boîtes LEGO habituelles aux couleurs vives, et incluaient aussi un livret d'architecture comme source d'inspiration.

Quelques décennies plus tard, l'architecte et fan de LEGO Adam Reed Tucker a fait revivre l'idée d'exprimer l'architecture en utilisant des briques LEGO. En partenariat avec le Groupe LEGO, il lança la gamme LEGO Architecture que nous connaissons aujourd'hui. Ses premiers modèles, et les ensembles originaux de la gamme LEGO Architecture actuelle, étaient des interprétations de célèbres gratte-ciel de sa ville natale de Chicago. La gamme LEGO Architecture a depuis évolué et s'est élargie, tout d'abord avec des bâtiments célèbres d'autres villes des États-Unis, puis avec de célèbres monuments d'Europe, du Moyen-Orient et d'Asie.

L'introduction de notre ensemble LEGO Architecture Studio fait écho aux ambitions de la précédente gamme « Maquettes à l'échelle » LEGO et accroît le potentiel de la gamme LEGO Architecture. Vous pouvez maintenant découvrir et construire des monuments célèbres ou créer de passionnants modèles architecturaux nés de votre imagination. Un livret d'inspiration de 270 pages, présentant plusieurs architectes célèbres du monde entier, vous guide parmi les principes de l'architecture et vous encourage dans votre propre construction créatrice.

LEGO® Architecture: entonces y ahora

Siempre ha existido una conexión natural entre el brick LEGO® y el mundo de la arquitectura. Los fans que construyen con elementos LEGO desarrollan instintivamente un interés por la forma y las funciones de las estructuras que crean. Al mismo tiempo, muchos arquitectos han descubierto que los bricks LEGO son una forma perfecta de expresar físicamente sus ideas creativas.

Esta relación se confirmó a principios de la década de 1960, con el lanzamiento de la línea «Scale Model» de LEGO. Encajaba bien con el espíritu de la época: un tiempo en el que los arquitectos modernos redefinían el aspecto de las casas y la gente se interesaba cada vez más por el diseño de su nuevo hogar. Los sets se diseñaron para que se diferenciaban de los normales, que se comercializaban en cajas de brillantes colores, e incluían un libro sobre la arquitectura que proporcionaba inspiración a sus usuarios.

Décadas más tarde, el arquitecto y fan de LEGO Adam Reed Tucker reavivó la idea de expresar la arquitectura usando bricks LEGO y, en colaboración con The LEGO Group, lanzó la línea LEGO Architecture que hoy conocemos. Sus primeros modelos, y los sets originales de la actual serie LEGO Architecture, eran interpretaciones de los rascacielos más famosos de su ciudad natal, Chicago. Desde entonces, LEGO Architecture se ha desarrollado y ha evolucionado, primero incorporando edificios célebres de otras ciudades de Estados Unidos y, ahora, estructuras emblemáticas de Europa, Oriente Próximo y Asia.

La introducción del set LEGO Architecture Studio recupera las ambiciones de la antigua línea «Scale Model» de LEGO y amplía el potencial de la serie LEGO Architecture. Hoy puedes disfrutar mientras construyes y aprendes sobre edificios célebres, o crear tus propios modelos arquitectónicos a partir de tu imaginación. Un instructivo libro de 270 páginas con materiales creados por arquitectos internacionales de gran reputación te guiará a través de los principios de la arquitectura y te animará a dar tus primeros pasos en el mundo de la construcción creativa.



21050
Studio

Celebrate the world of architecture
Célébrez le monde de l'architecture
Celebra el mundo de la arquitectura

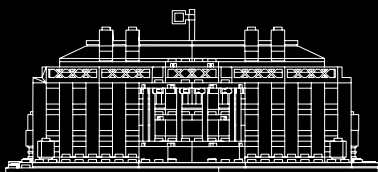

21006
The White House
La Maison-Blanche
La Casa Blanca

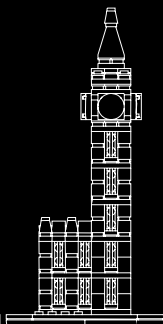

21013
Big Ben

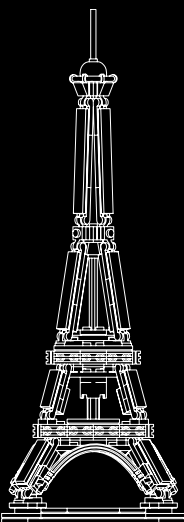

21019
The Eiffel Tower
La tour Eiffel
La torre Eiffel

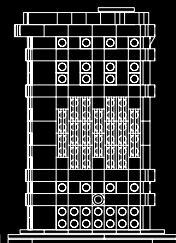

21023
Flatiron Building
Le Flatiron Building
Edificio Flatiron



21024
Louvre

and collect all the models
et collectionnez tous les modèles
y colecciona todos los modelos



21020
Trevi Fountain
La fontaine de Trevi
Fontana de Trevi

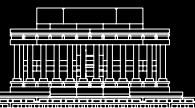

21022
Lincoln Memorial
Le monument de Lincoln
Monumento a Lincoln



21027
Berlin
Berlín



21028
New York City
New York
Nueva York

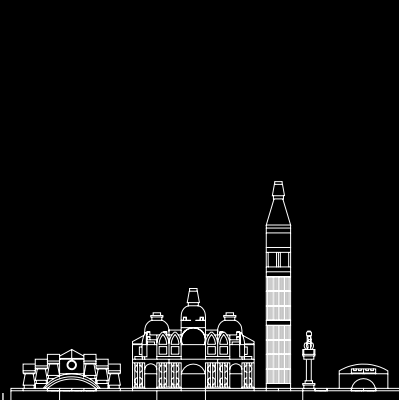

21026
Venice
Venise
Venecia

References

Text credits:

Emaar Properties PJSC
Skidmore, Owings & Merrill LLP

Photo credits:

© *Emaar Properties PJSC*

Références

Crédits textes :

Emaar Properties PJSC
Skidmore, Owings & Merrill LLP

Crédits photos :

© *Emaar Properties PJSC*

Referencias

Redacción:

Emaar Properties PJSC
Skidmore, Owings & Merrill LLP

Fotografías:

© *Emaar Properties PJSC*

2x
4125253

2x
4114026

2x
6092587

20x
4185177

2x
4143005

3x
4253815

4x
306926

7x
243126

1x
6132837

3x
303426

2x
244526

2x
4258354

2x
4121715

1x
4526982

2x
6073031

3x
4211389

8x
4211388

3x
4558953

1x
4213567

29x
6015344

1x
4211412

13x
4233493

3x
4211440

11x
4521921

54x
4568637

3x
4251163

3x
6132872

6x
4622803

1x
4211399

1x
6066097

47x
4211398

5x
4211414

2x
4211397

1x
6065824

7x
4211396

2x
4211356

3x
4211395

4x
4211549

7x
4211406

3x
4654582

3x
6004990

2x
6132886

3x
6052200

1x
4211473

8x
6102769

2x
4494222

1x
6123815

4x
4502595

24x
4504378

3x
4211052

1x
4211063

1x
4211122

1x
4211114

1x
6102774

1x
4508553

1x
4654448

Customer Service
Kundenservice
Service Consommateurs
Servicio Al Consumidor

LEGO.com/service or dial

00800 5346 5555 : 

1-800-422-5346 : 