



NINJAGO

Masters of Spinjitzu



2505



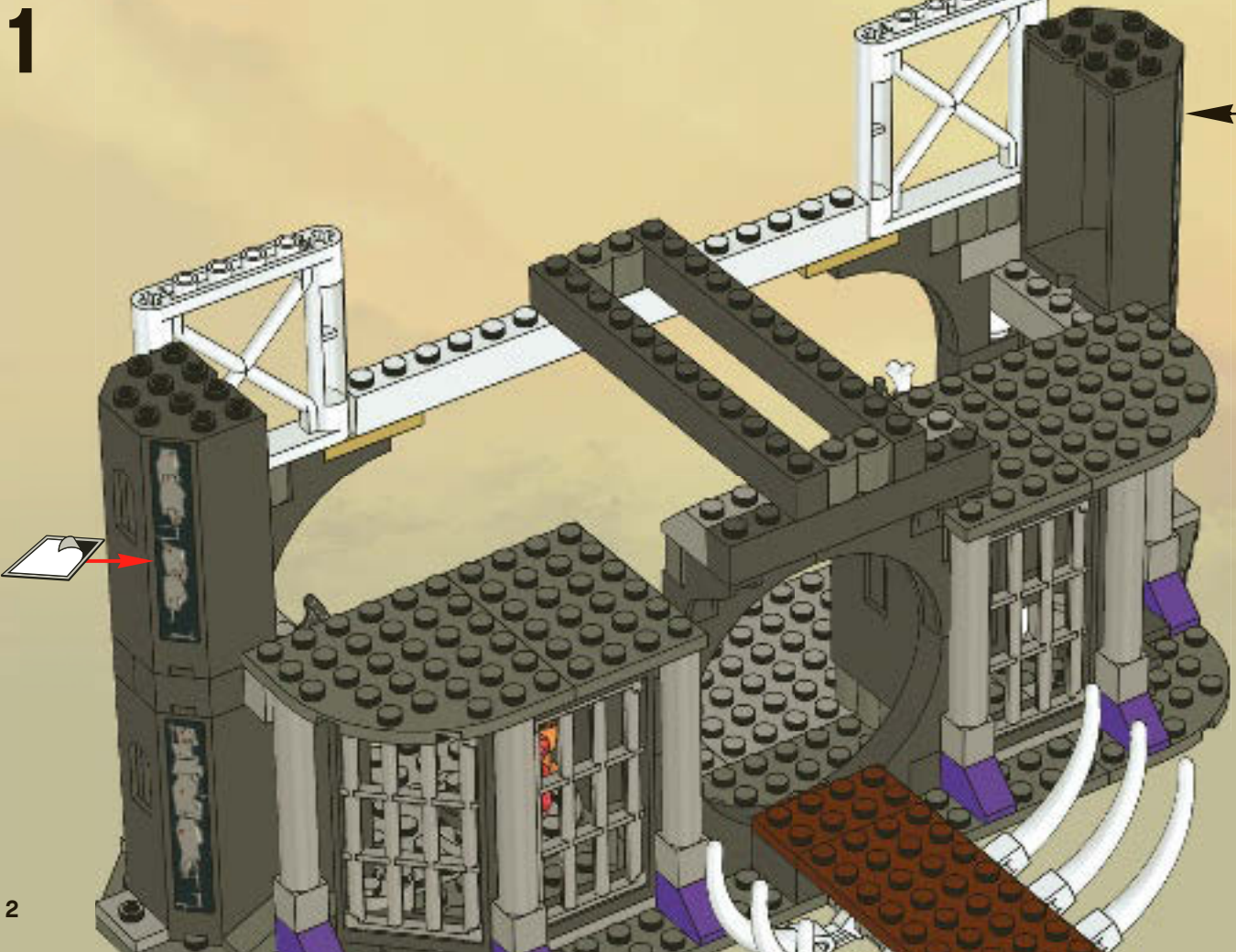
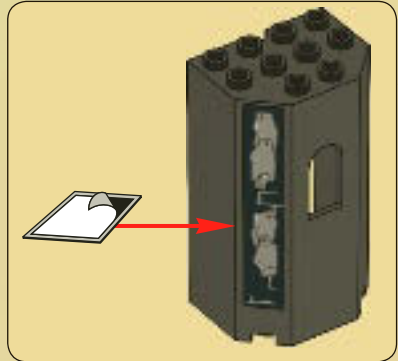
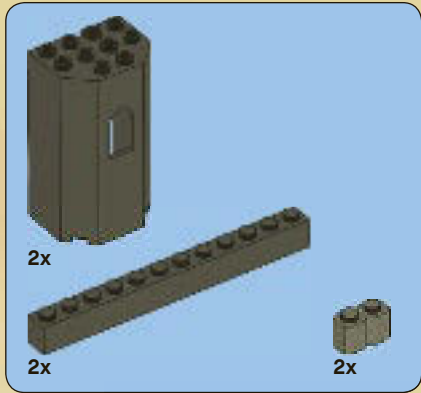
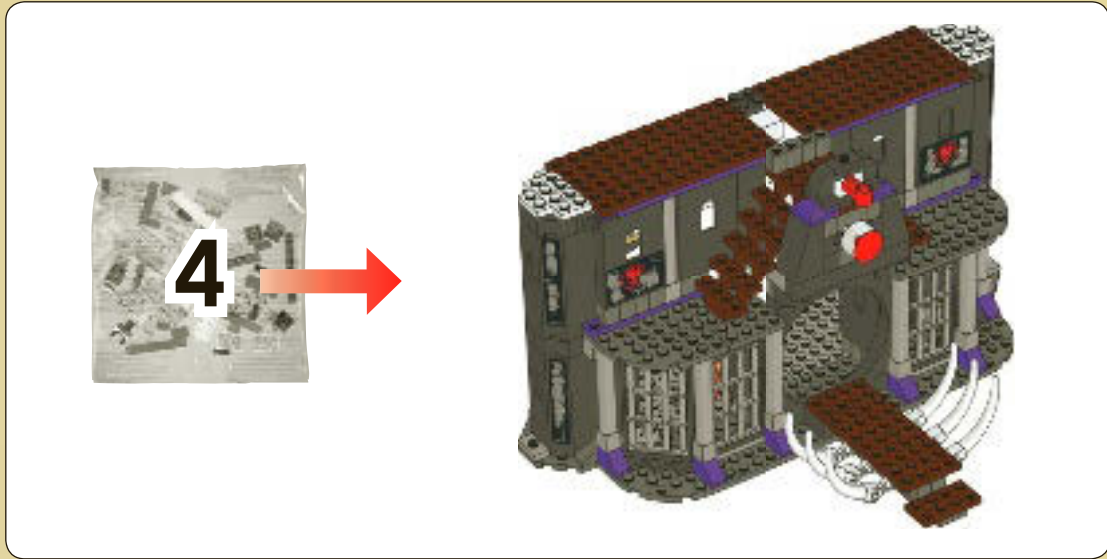

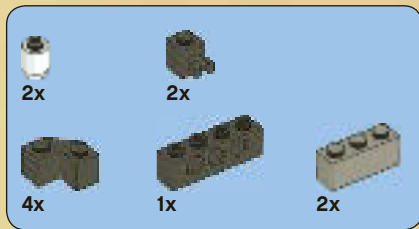

2

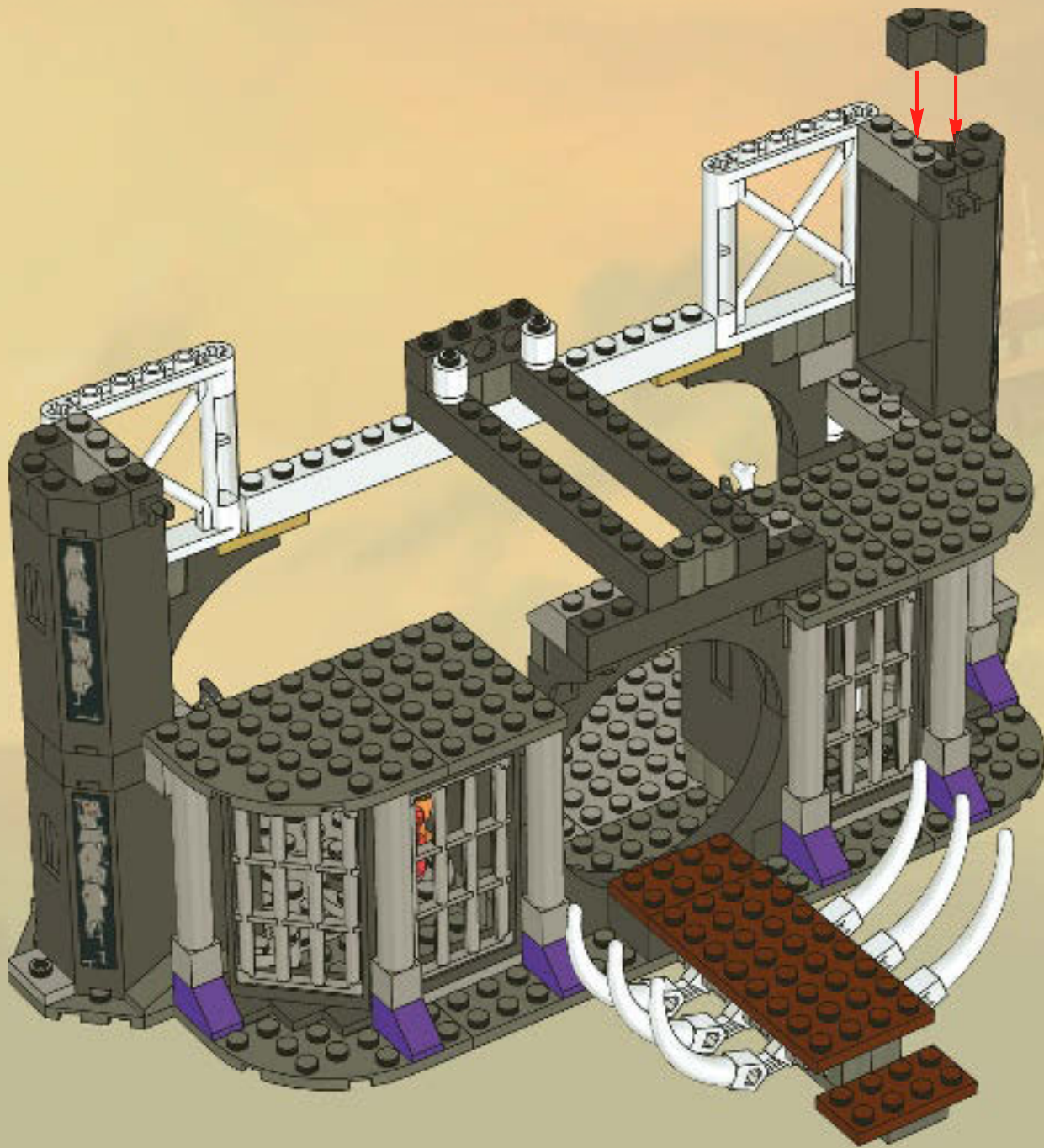

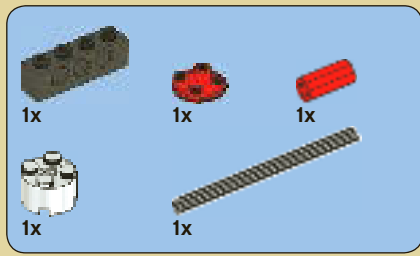

3

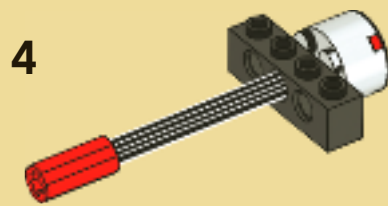
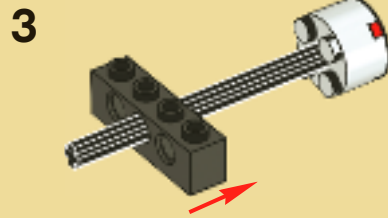
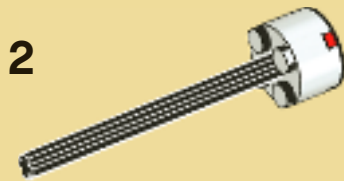
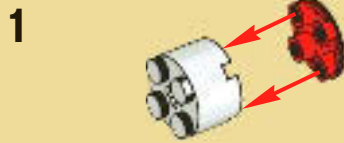

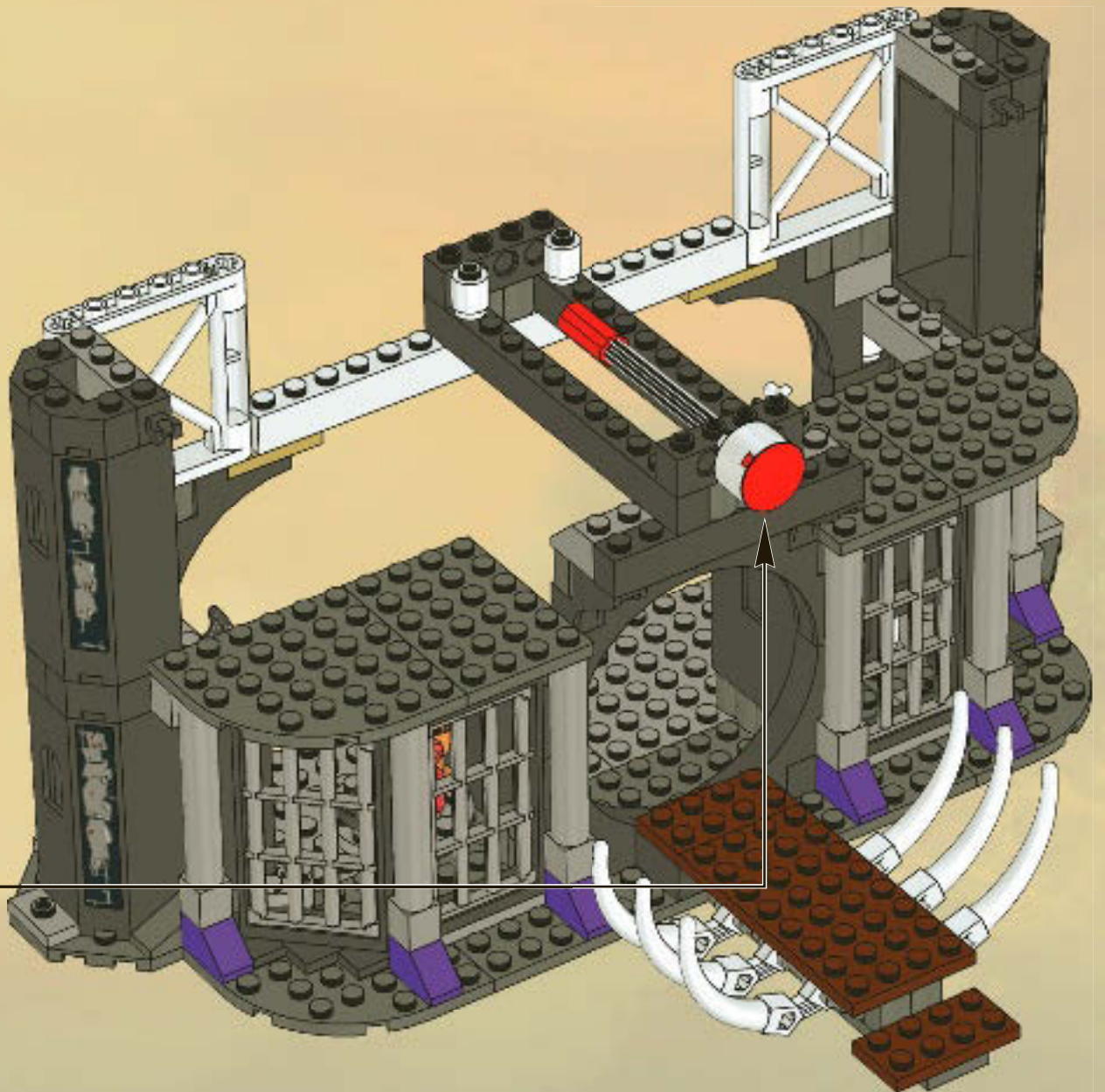

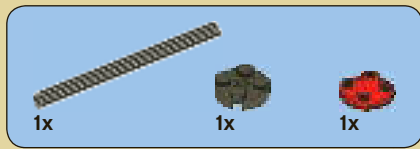

4

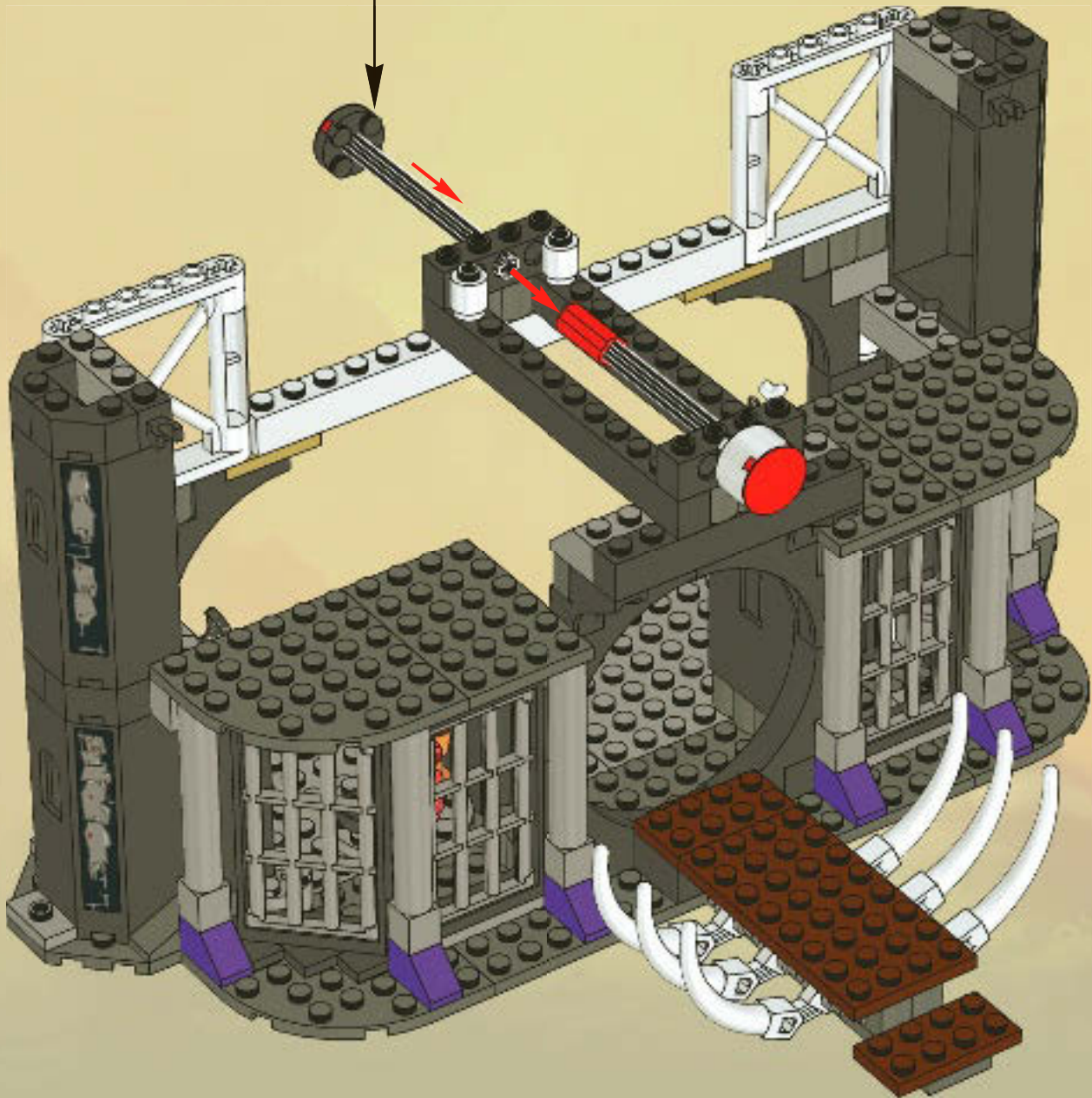
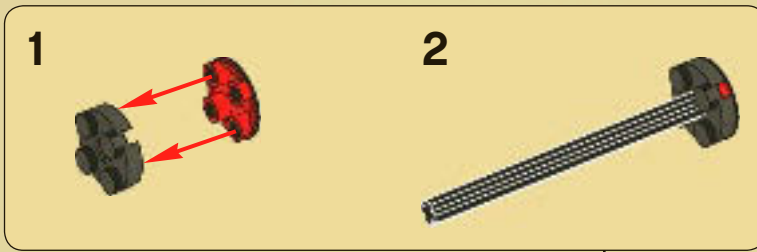

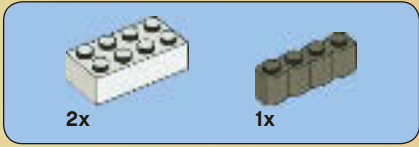

5

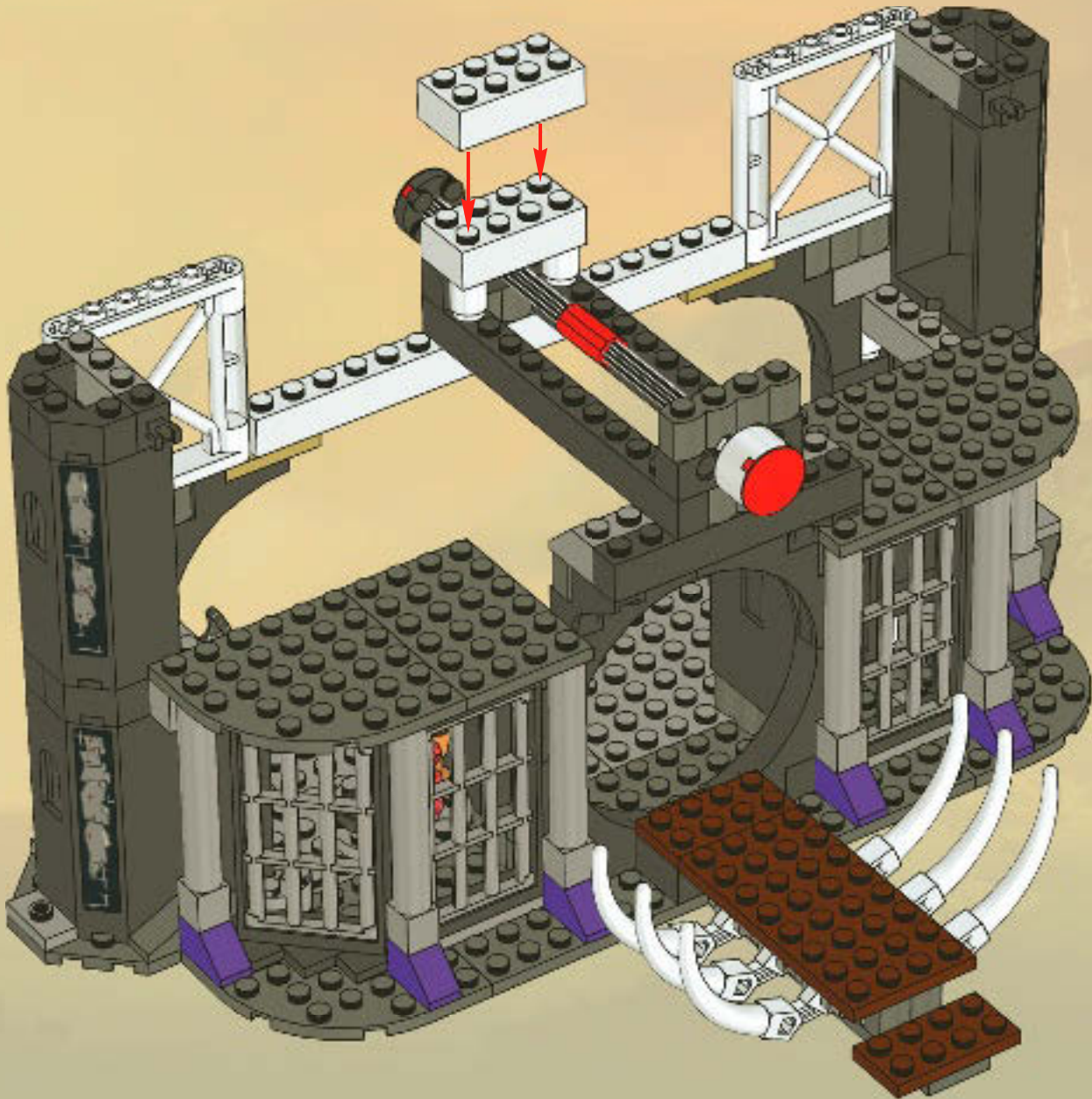

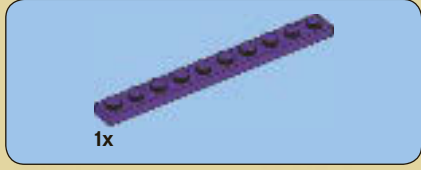
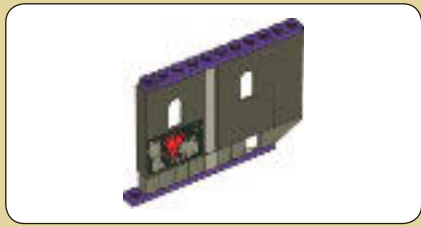

1

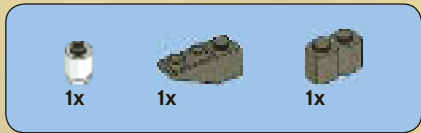
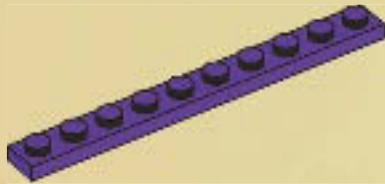

2

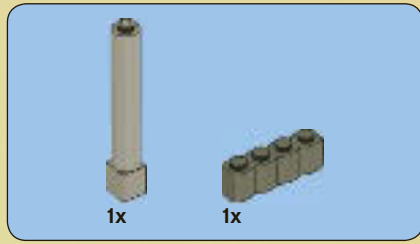
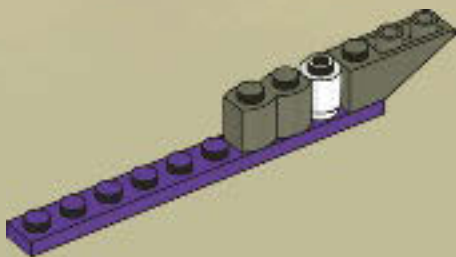

3

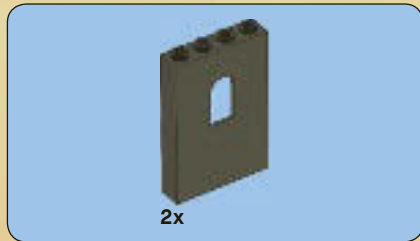
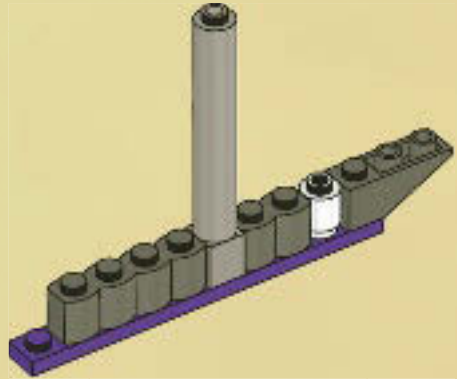

4

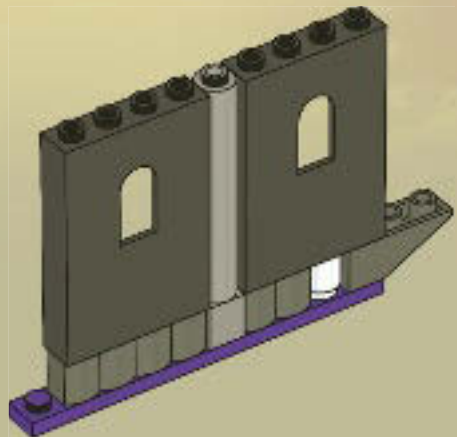

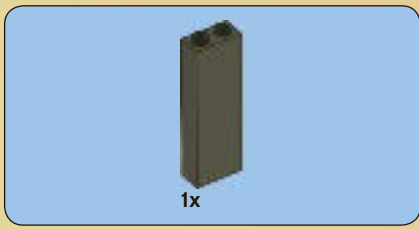

5

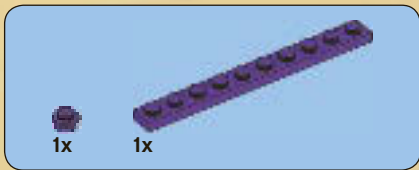
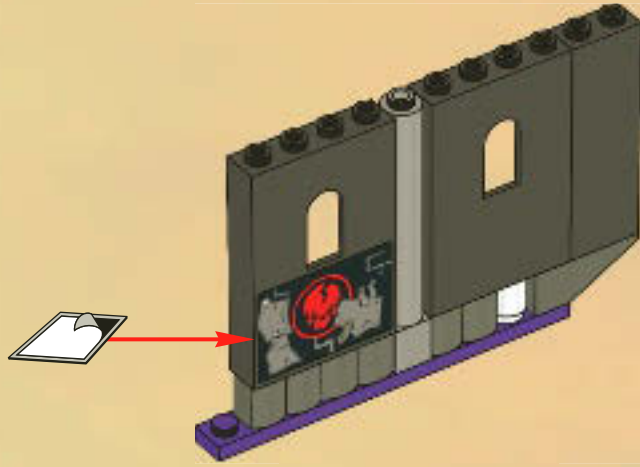

6

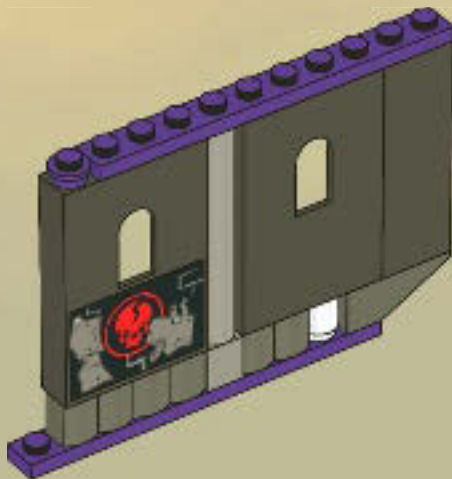

66

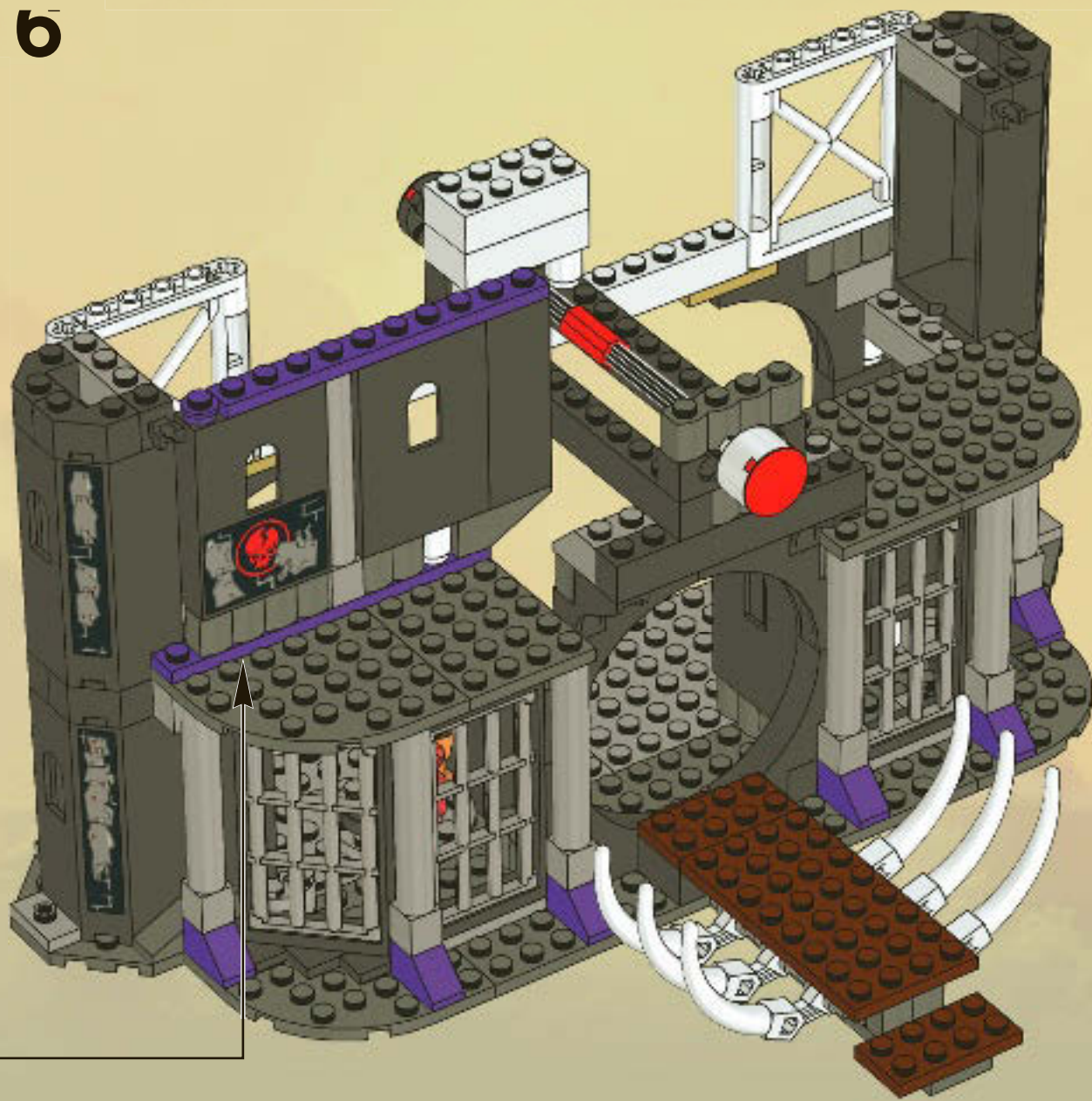



1

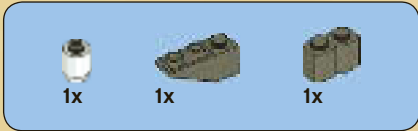
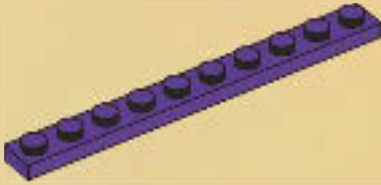

2

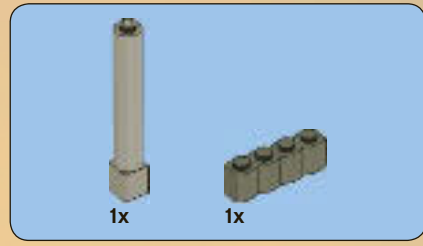
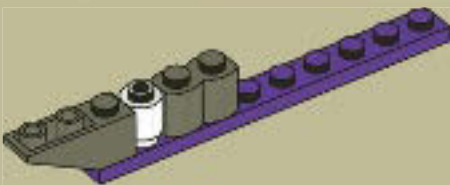

3

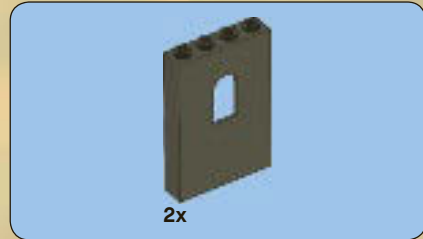
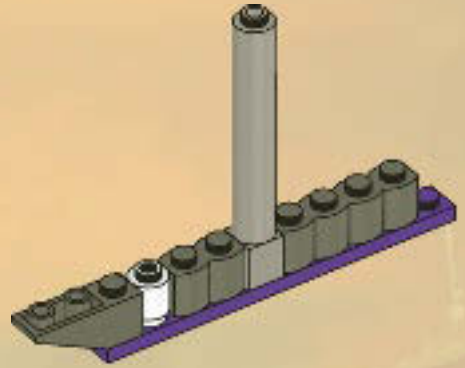

4

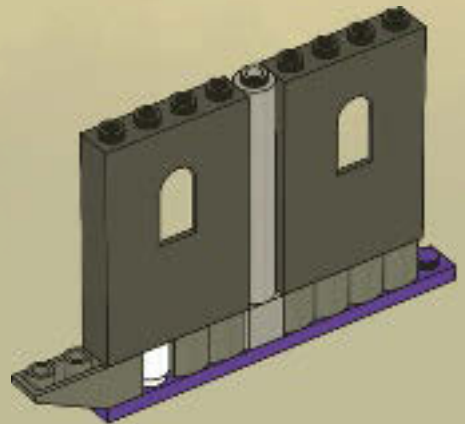

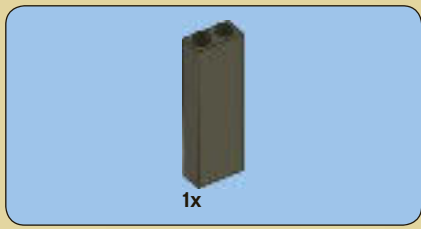

5

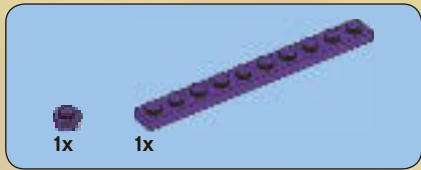
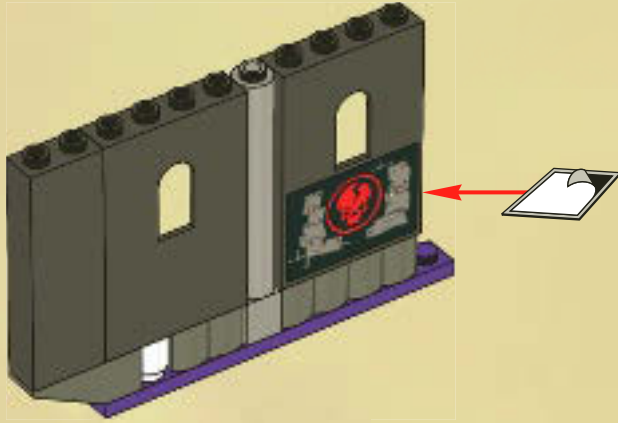

6

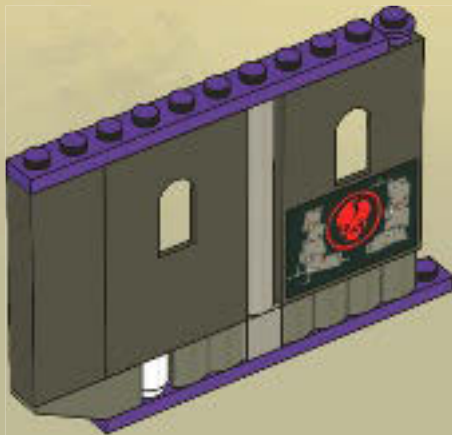

7

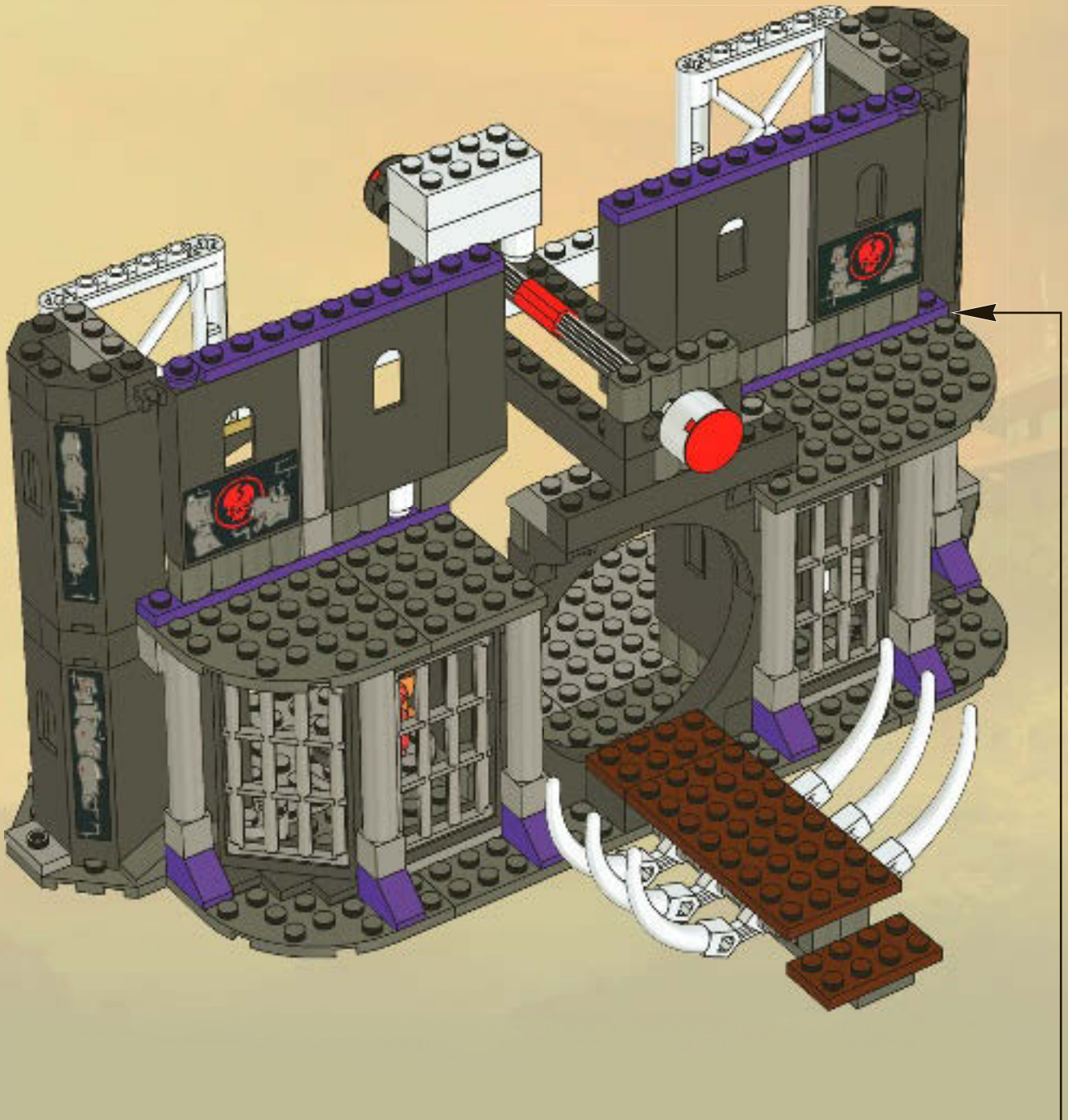

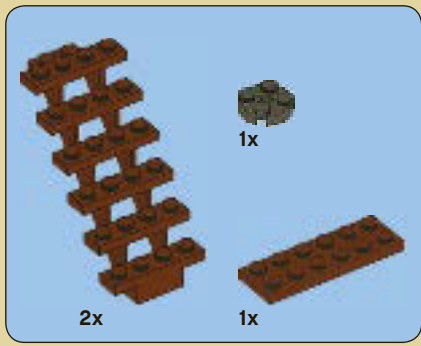

8

1



3

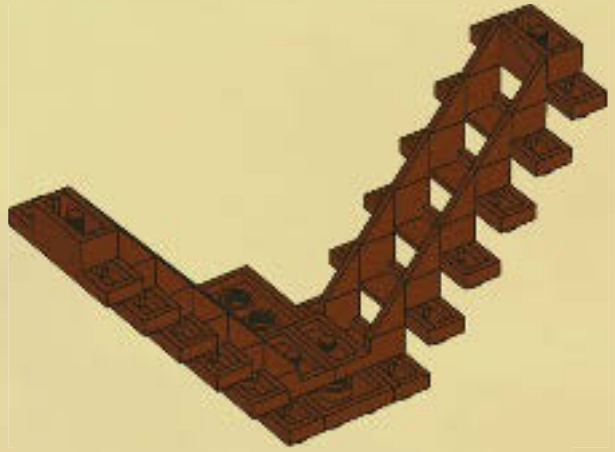

2

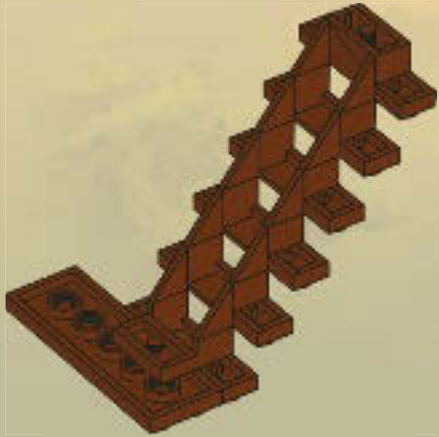

4

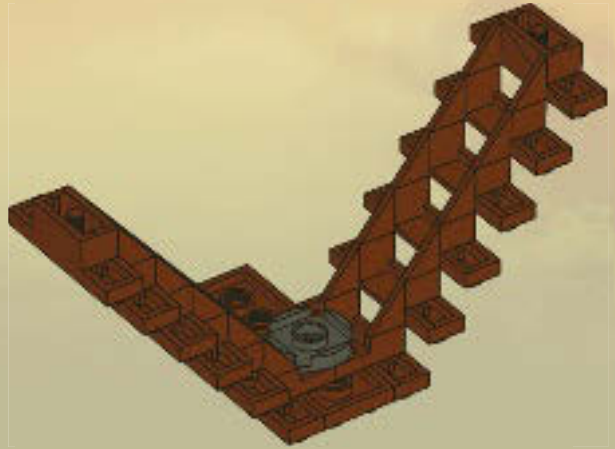

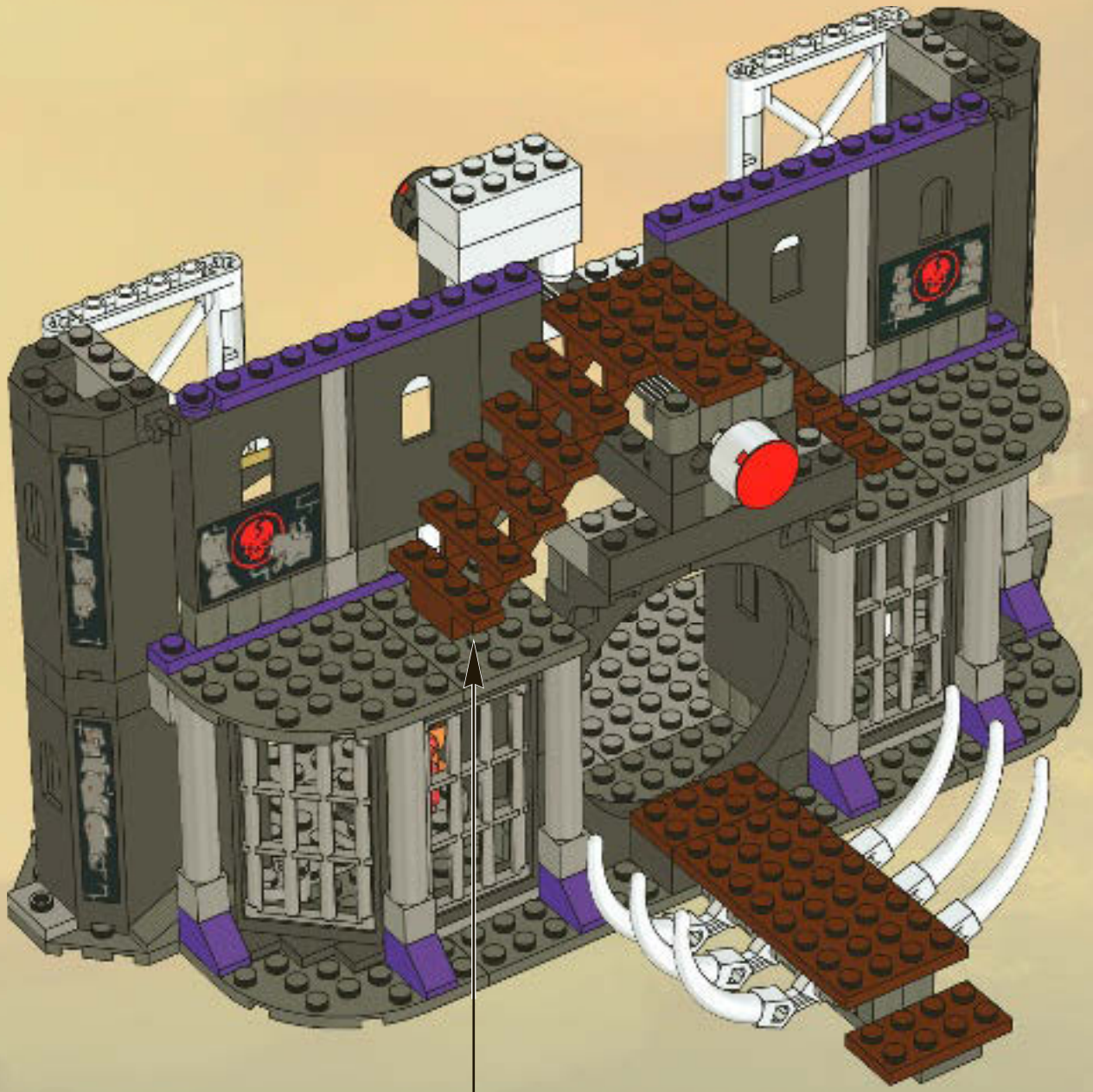

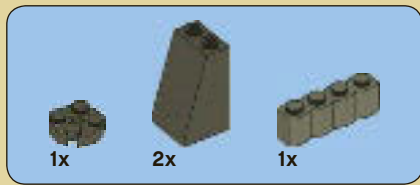

9

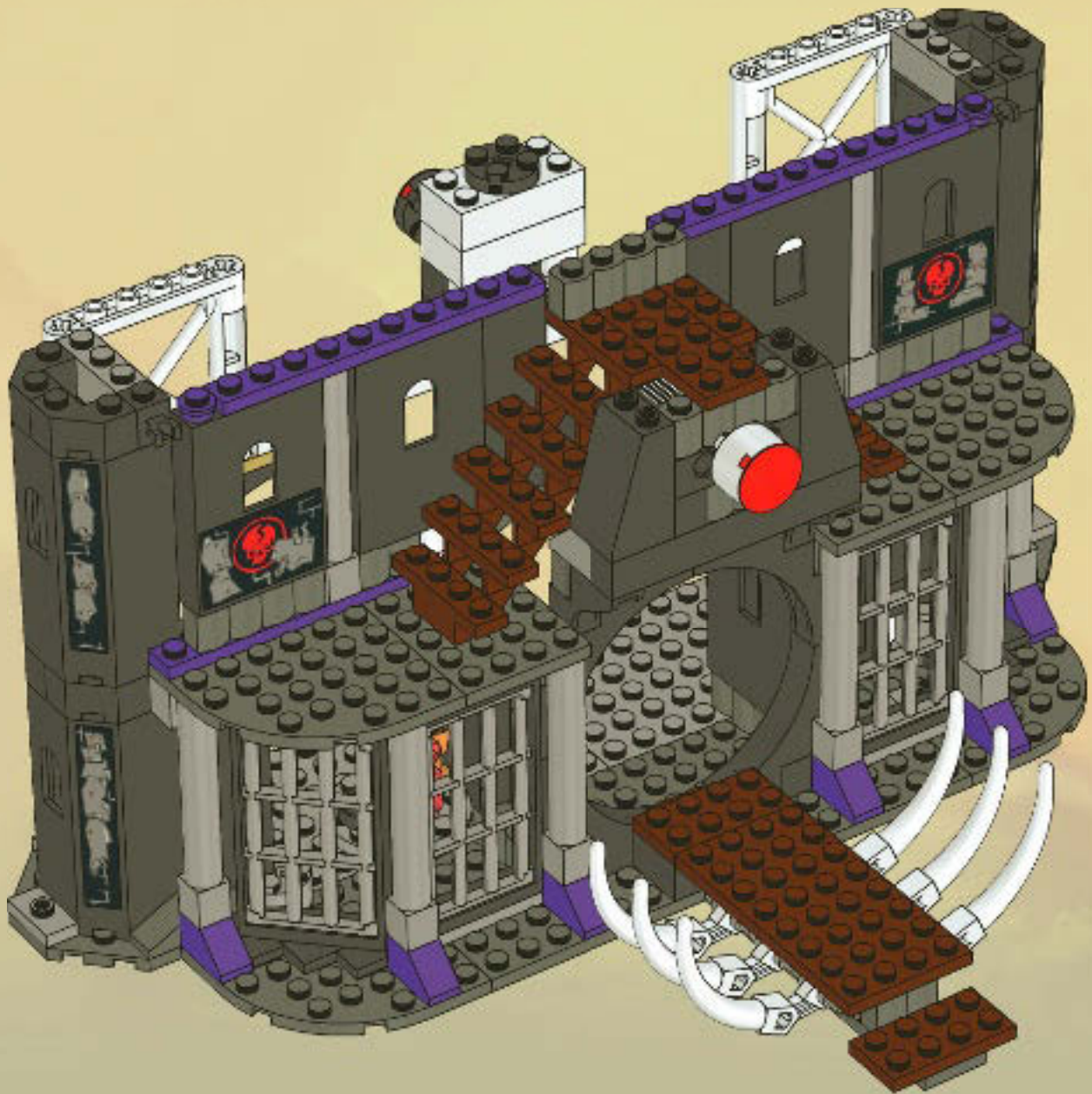



10

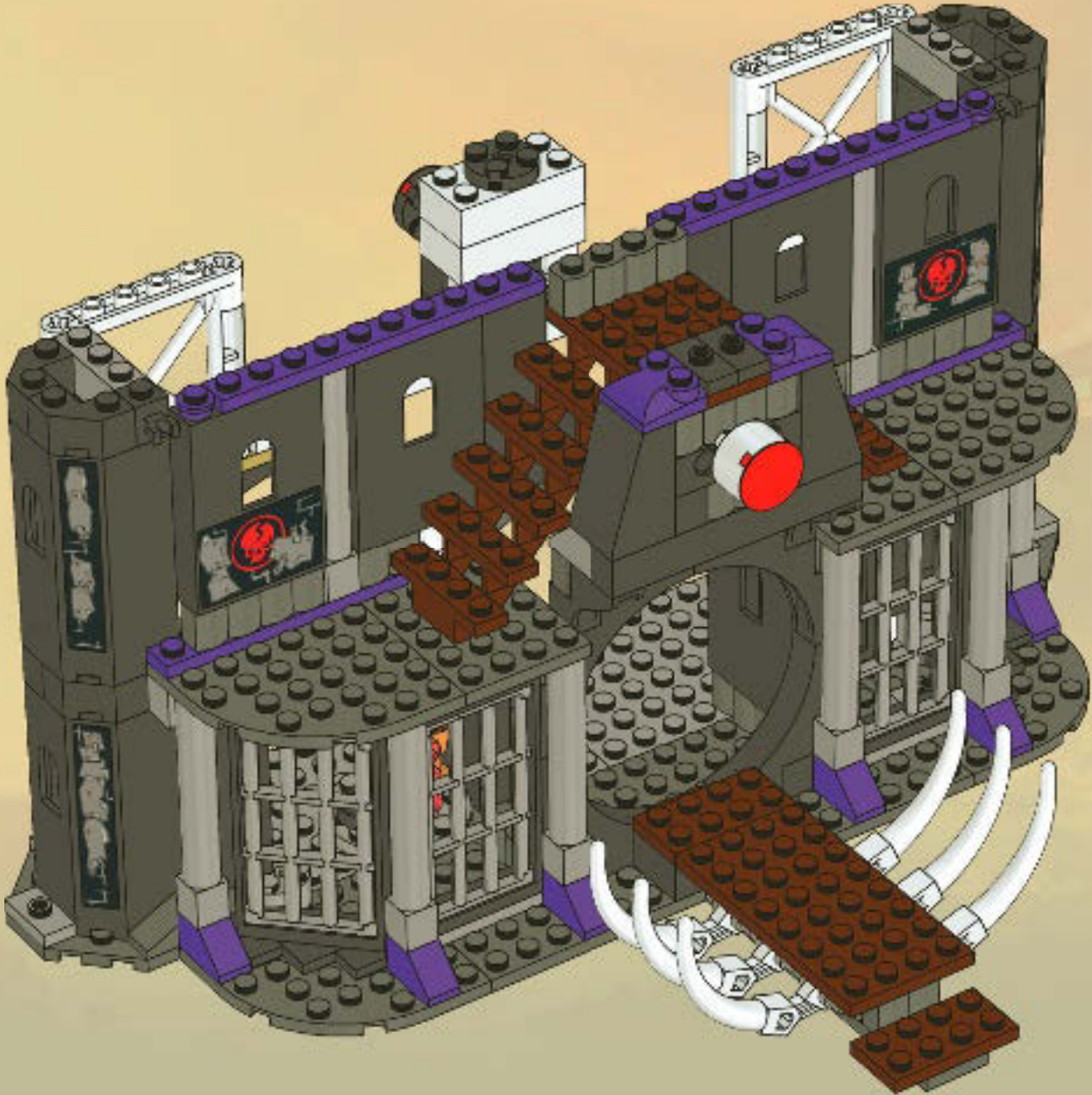

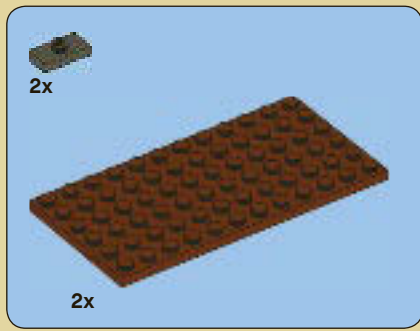

11

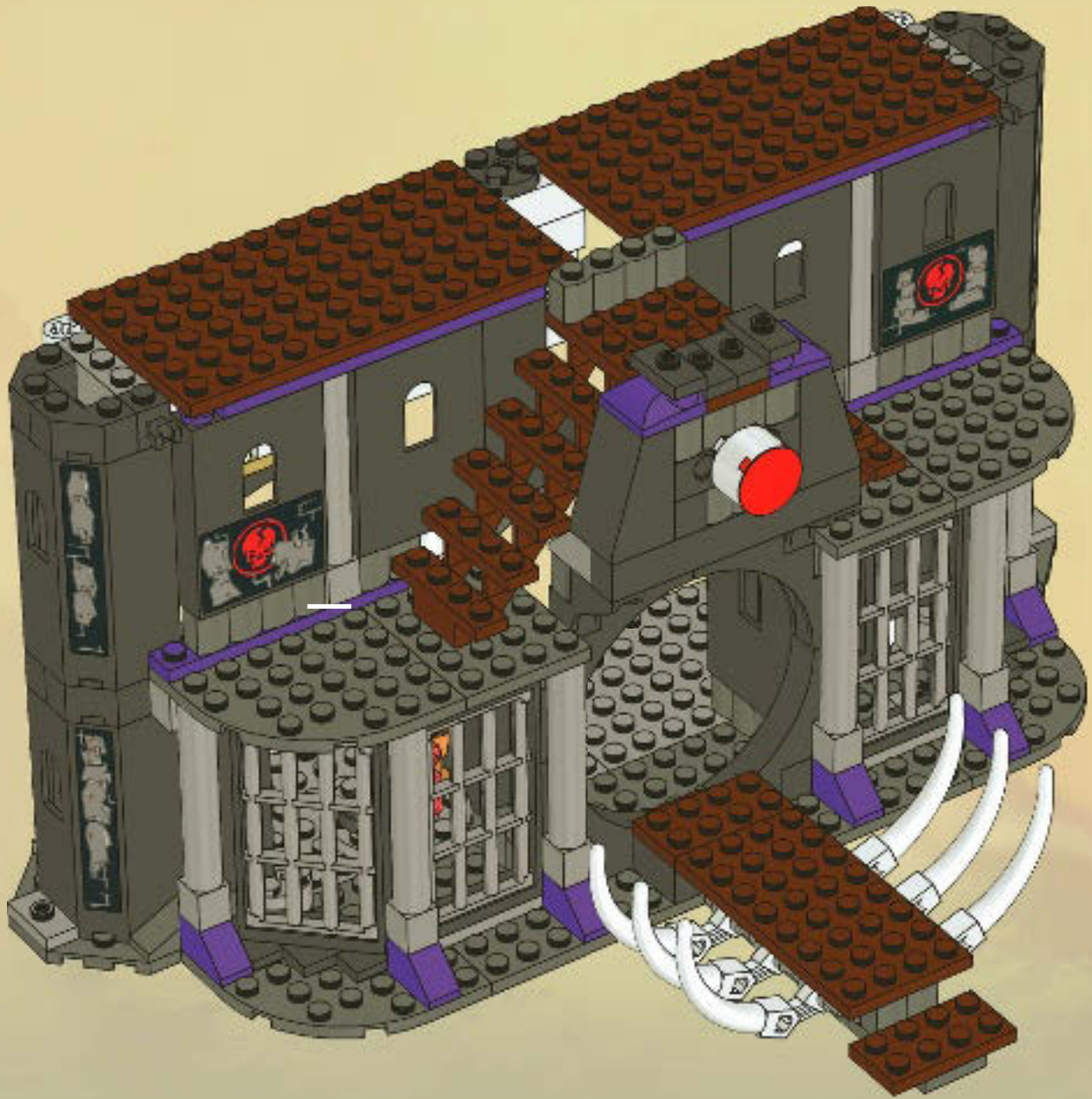

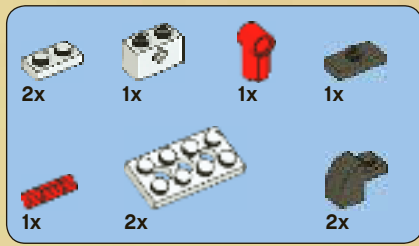

12

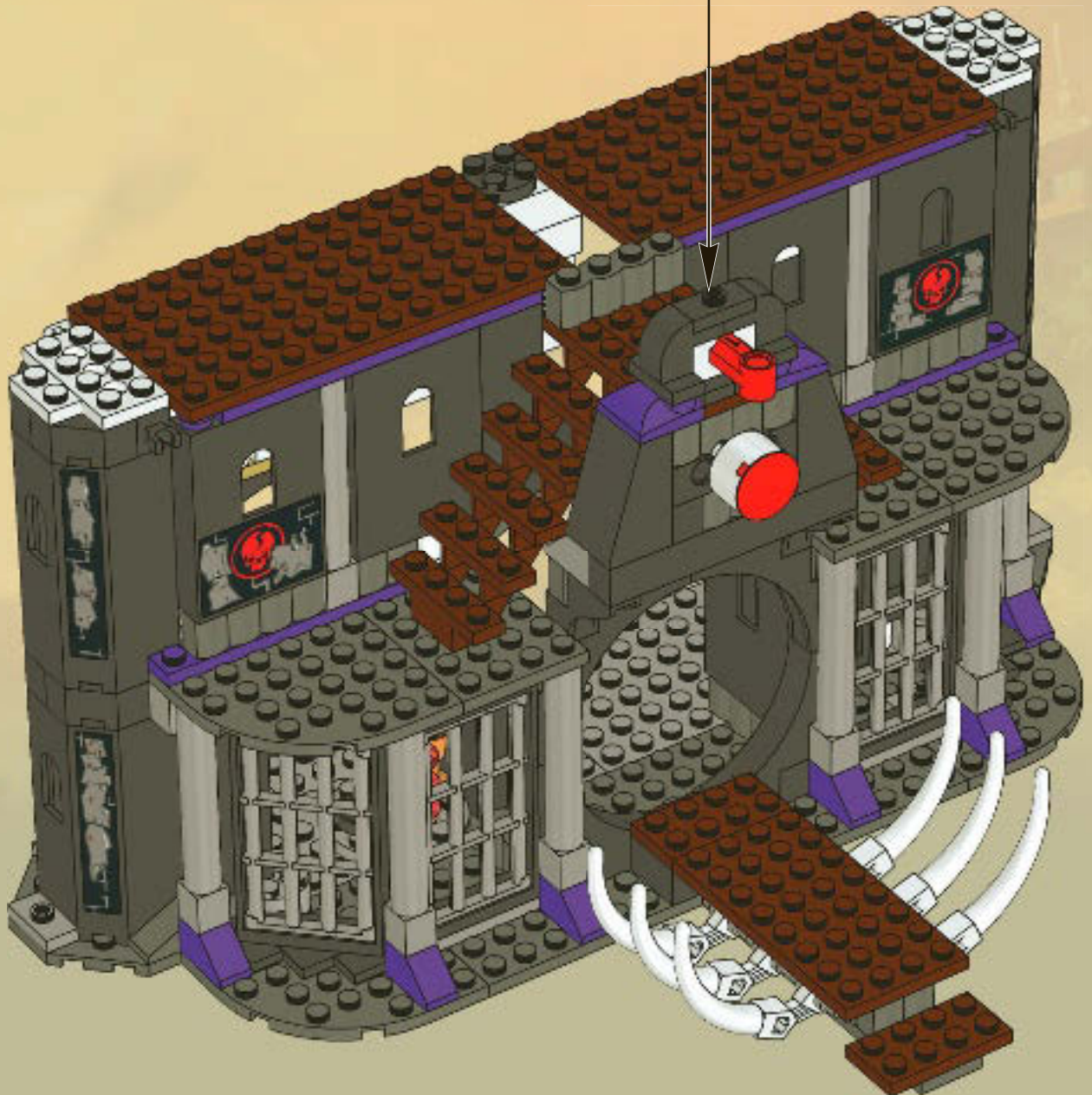
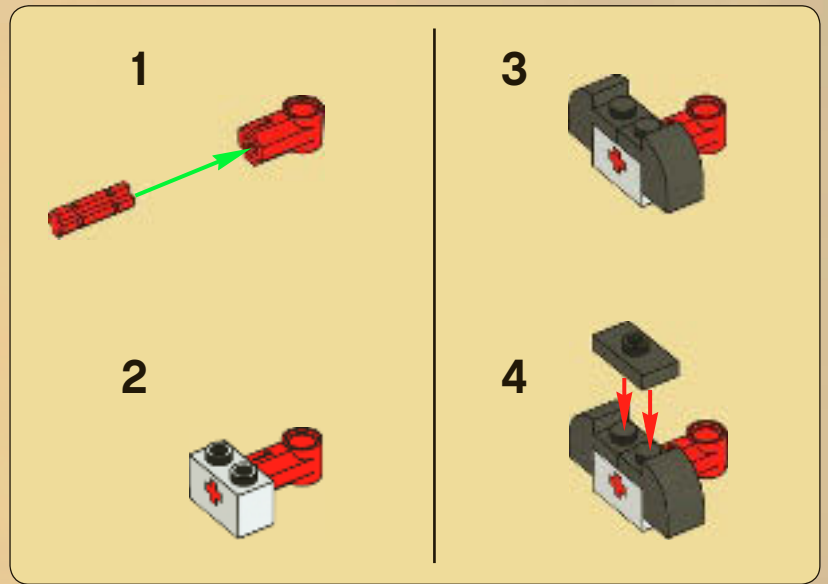

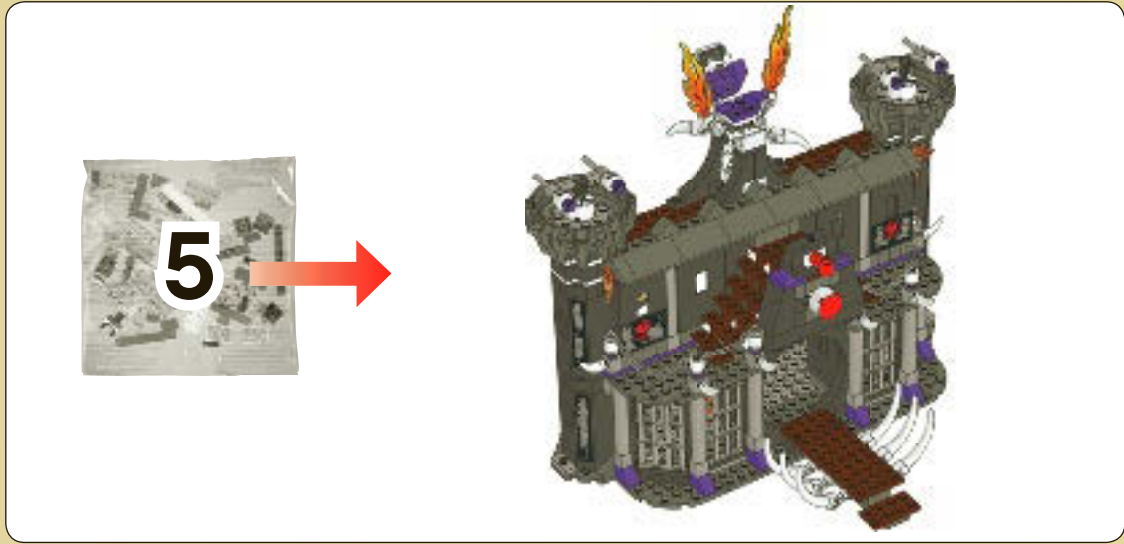

13

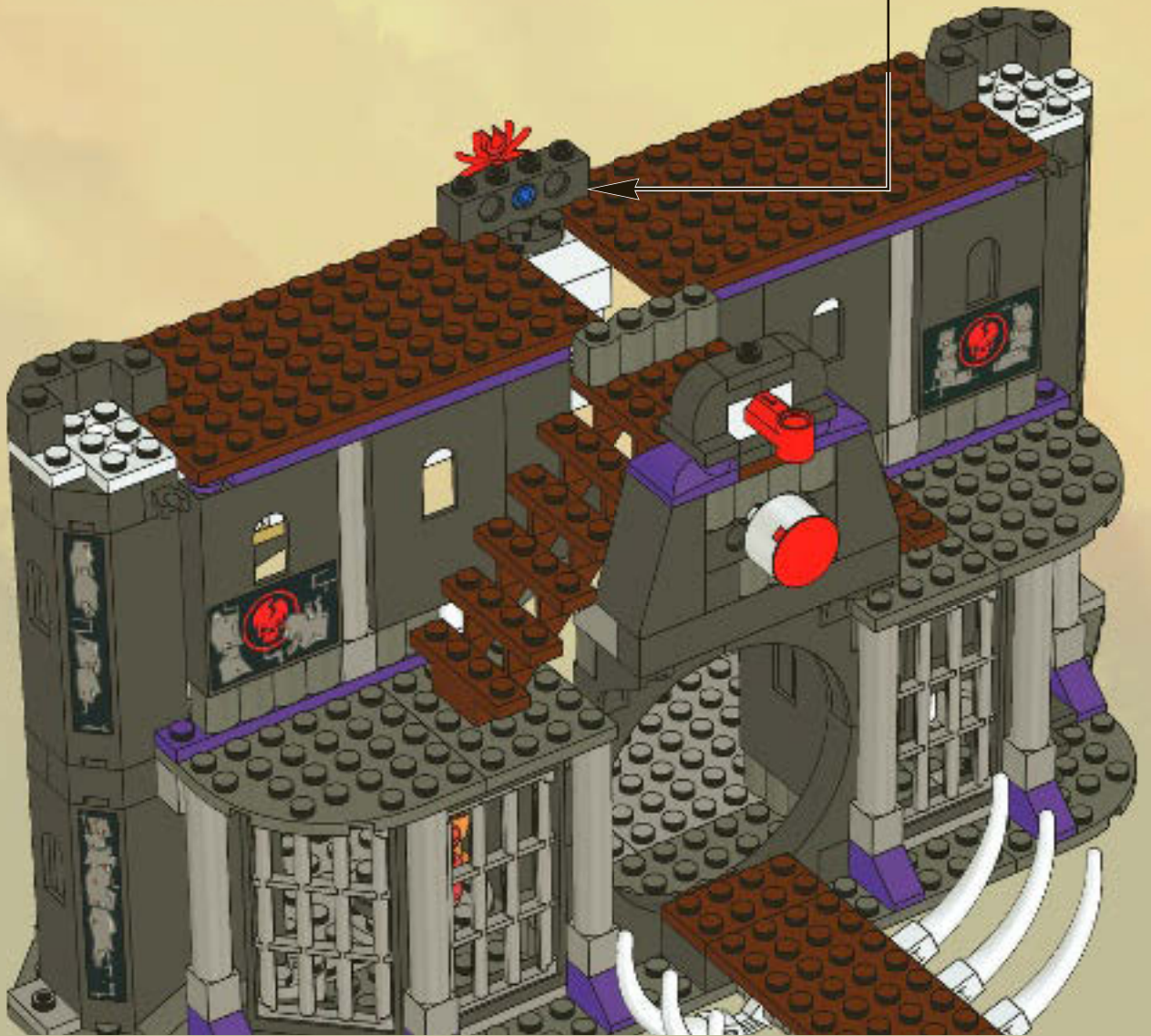



14

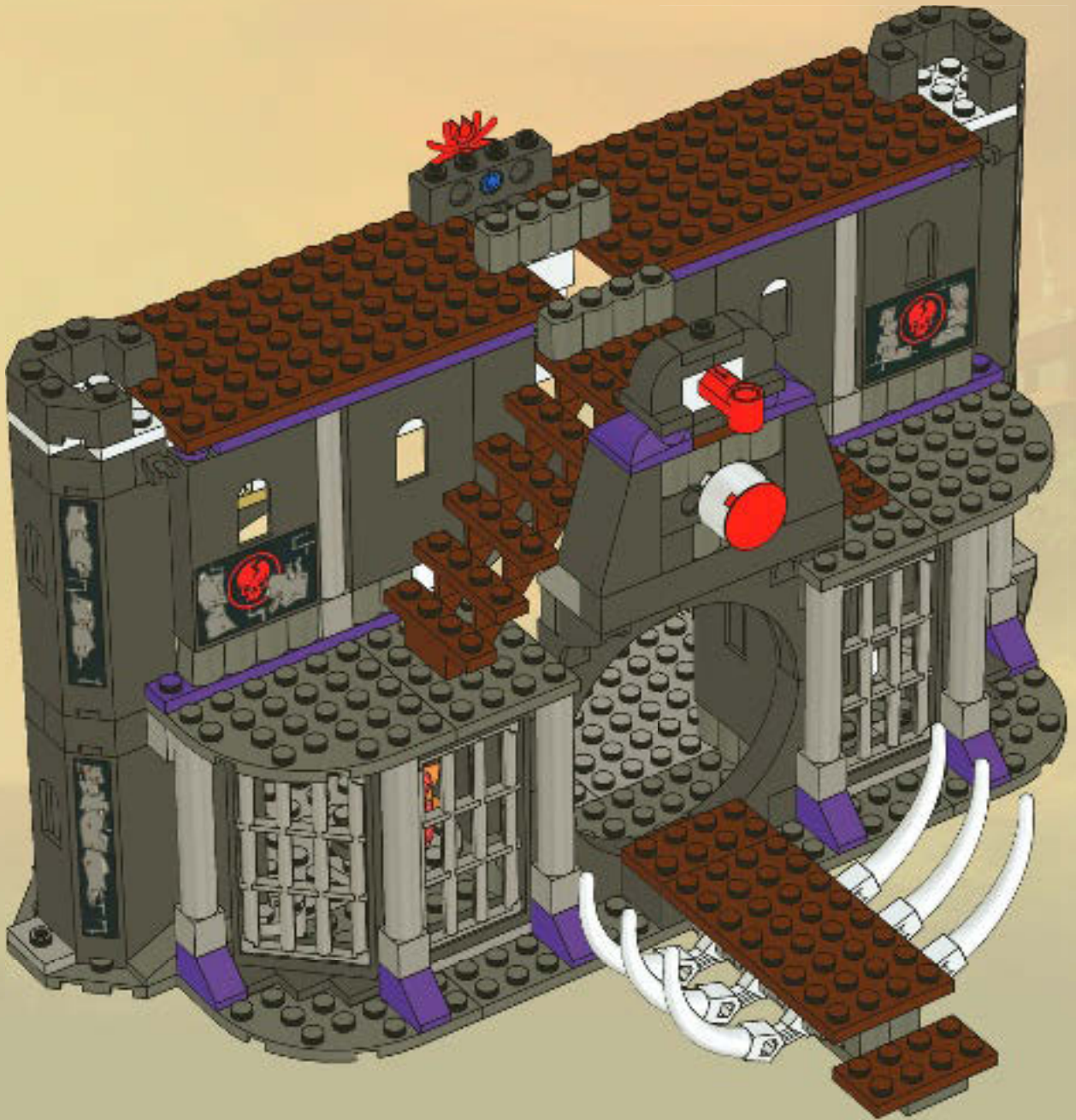



15

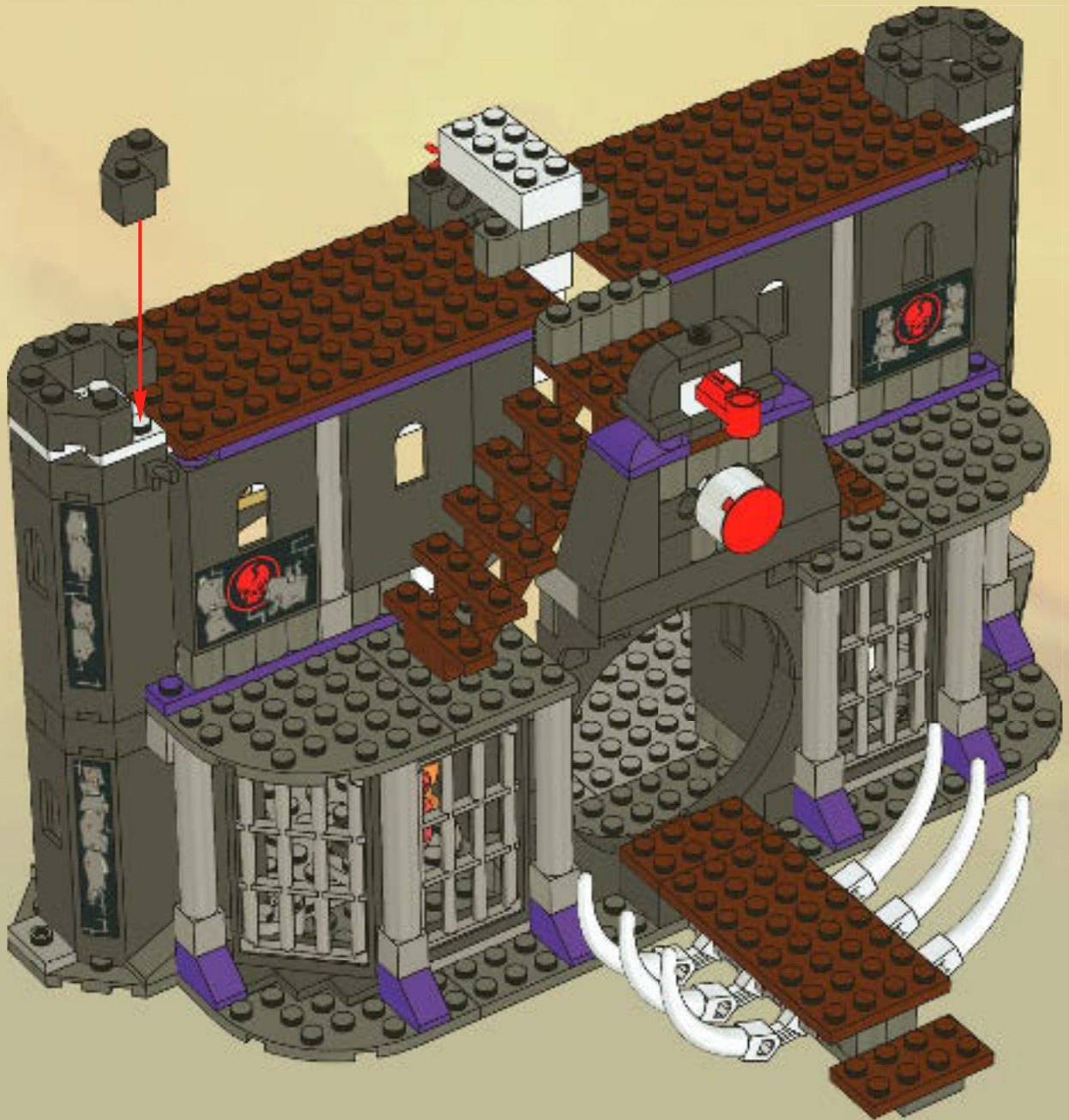

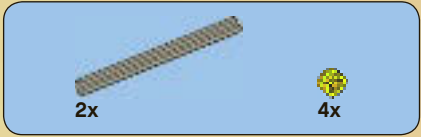

16

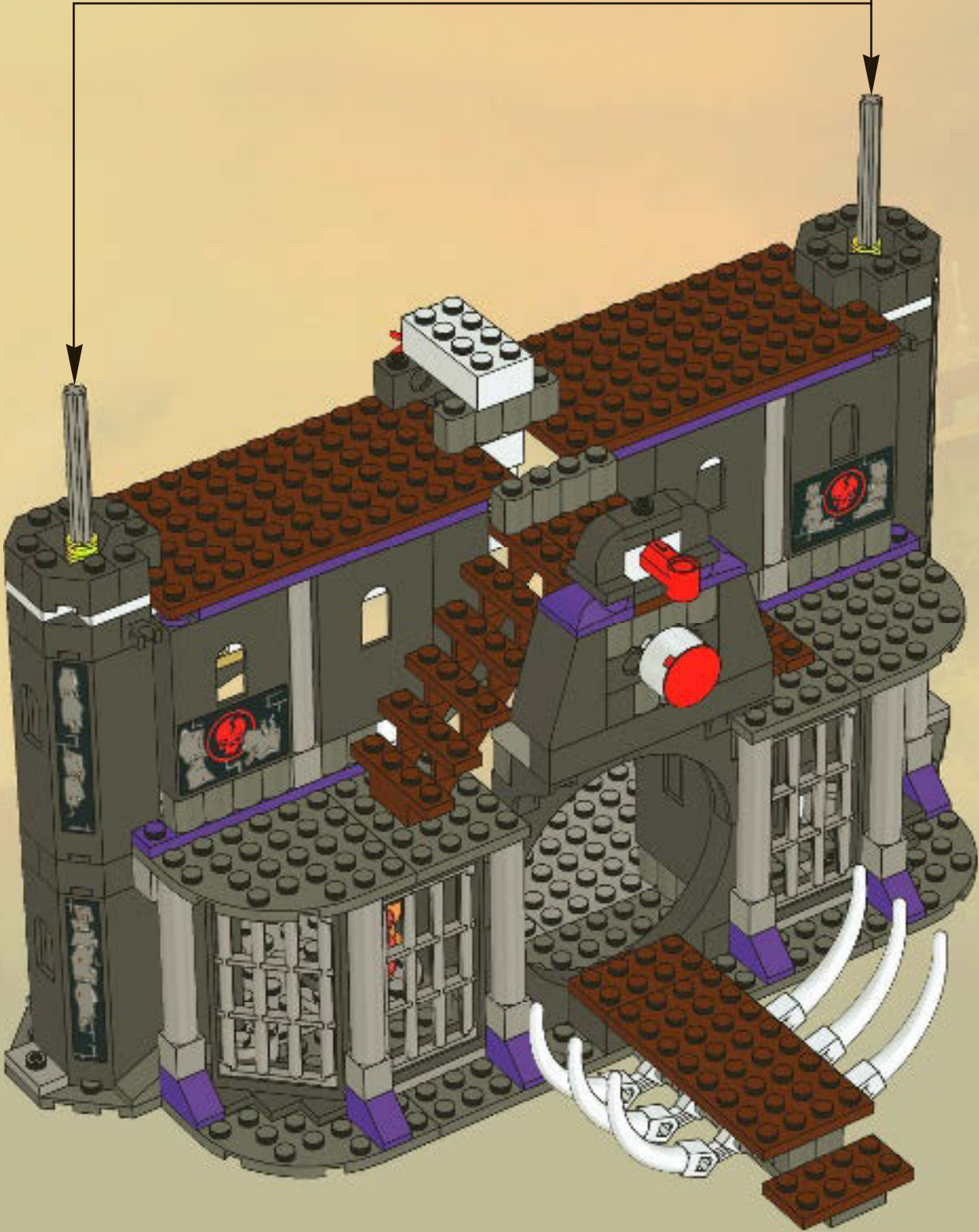
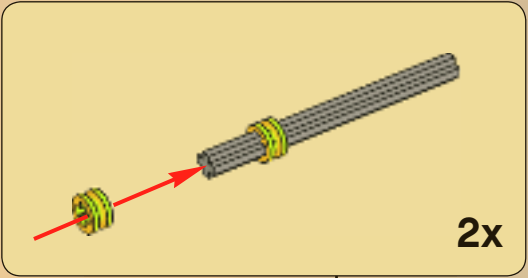

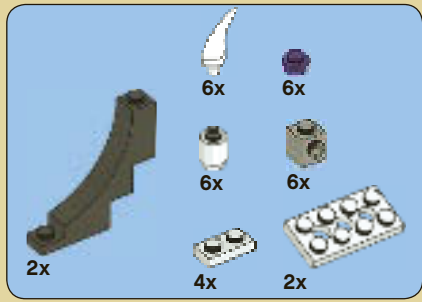

17

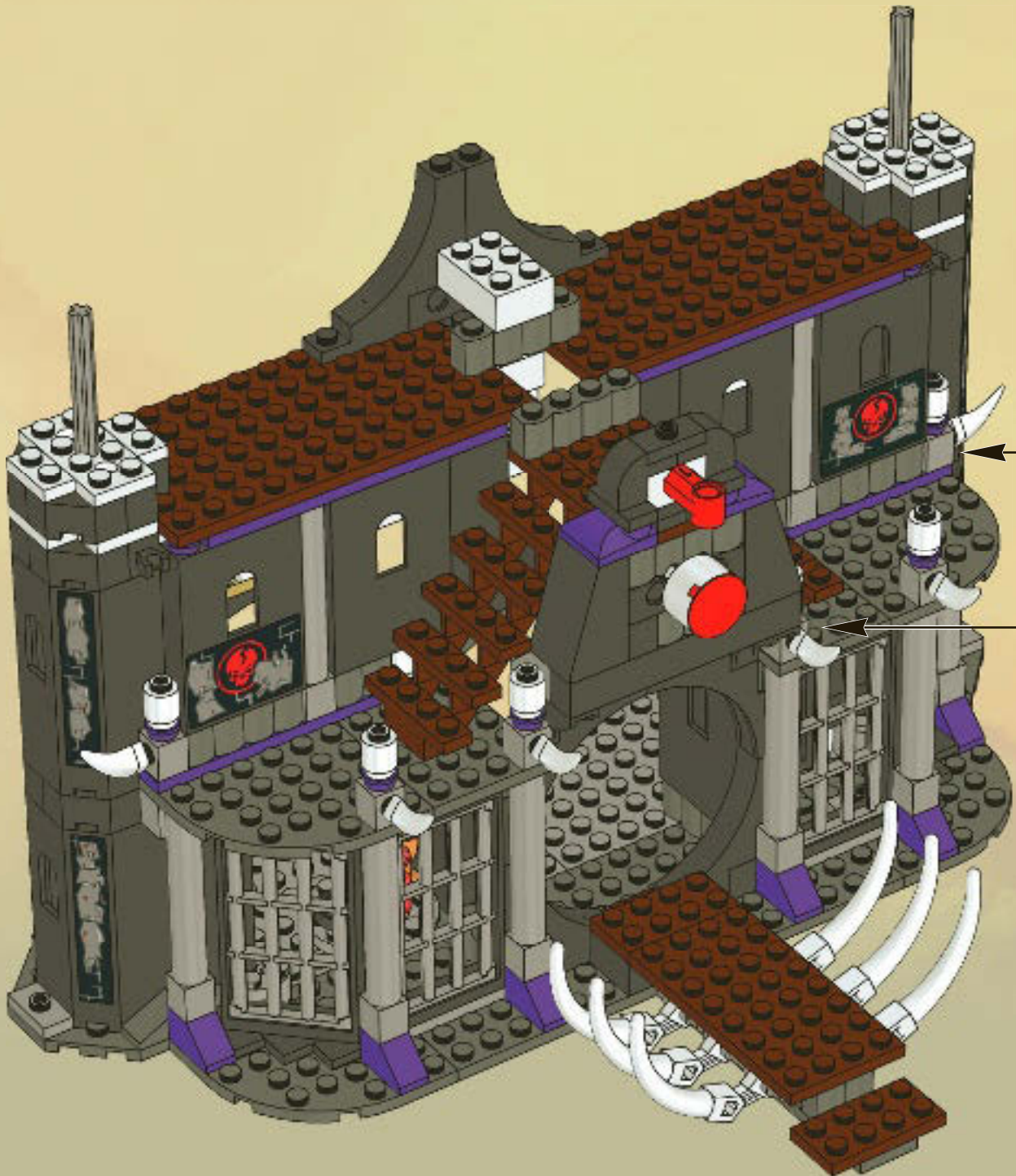
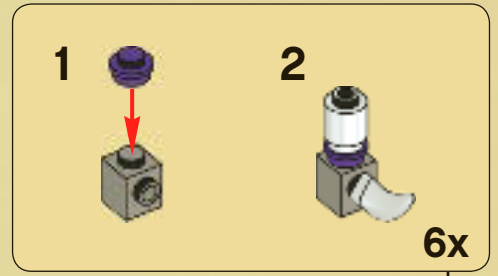

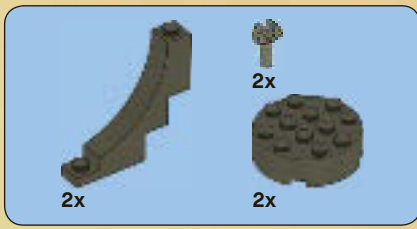

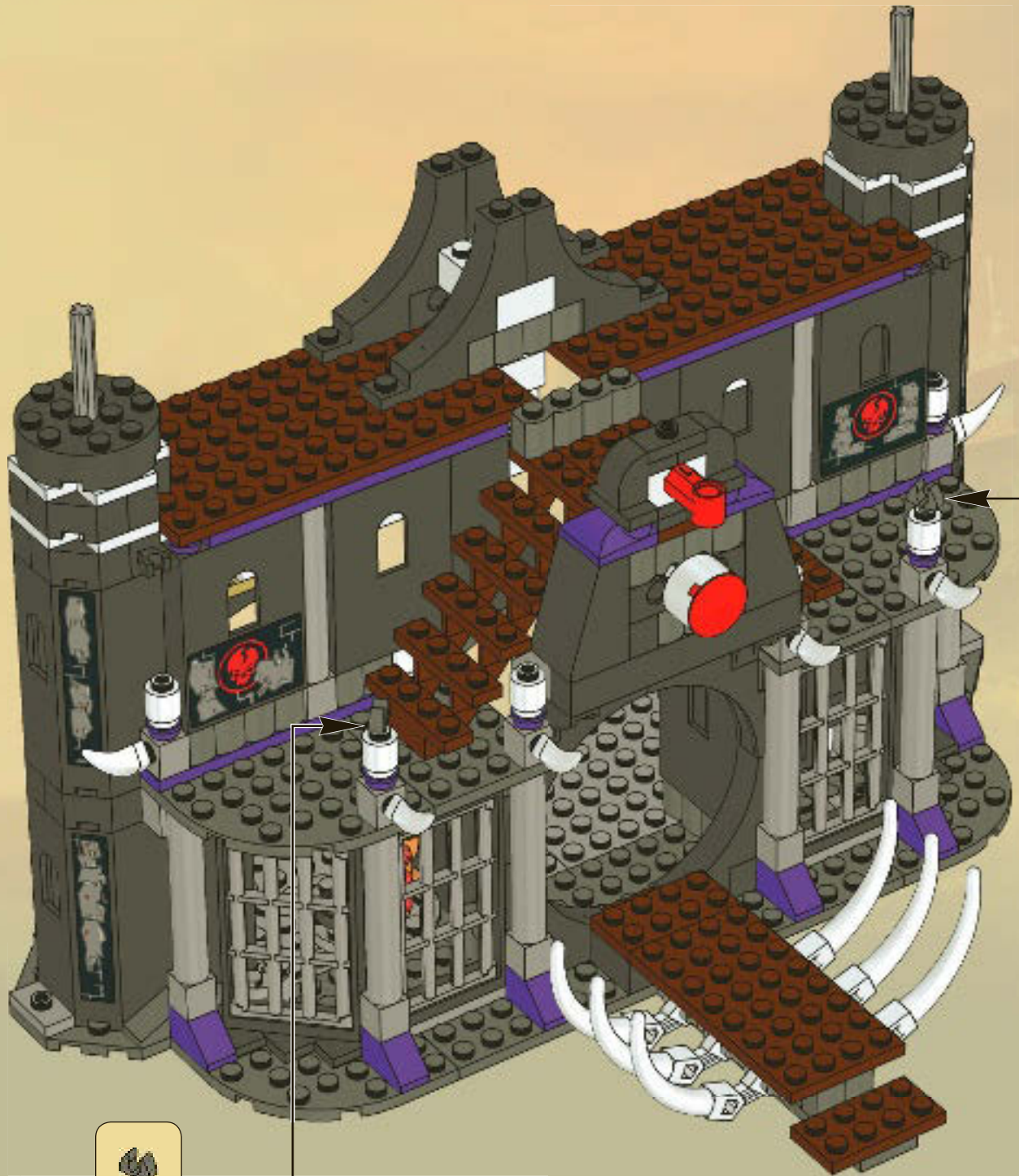

18

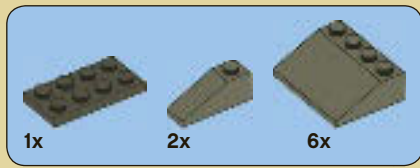

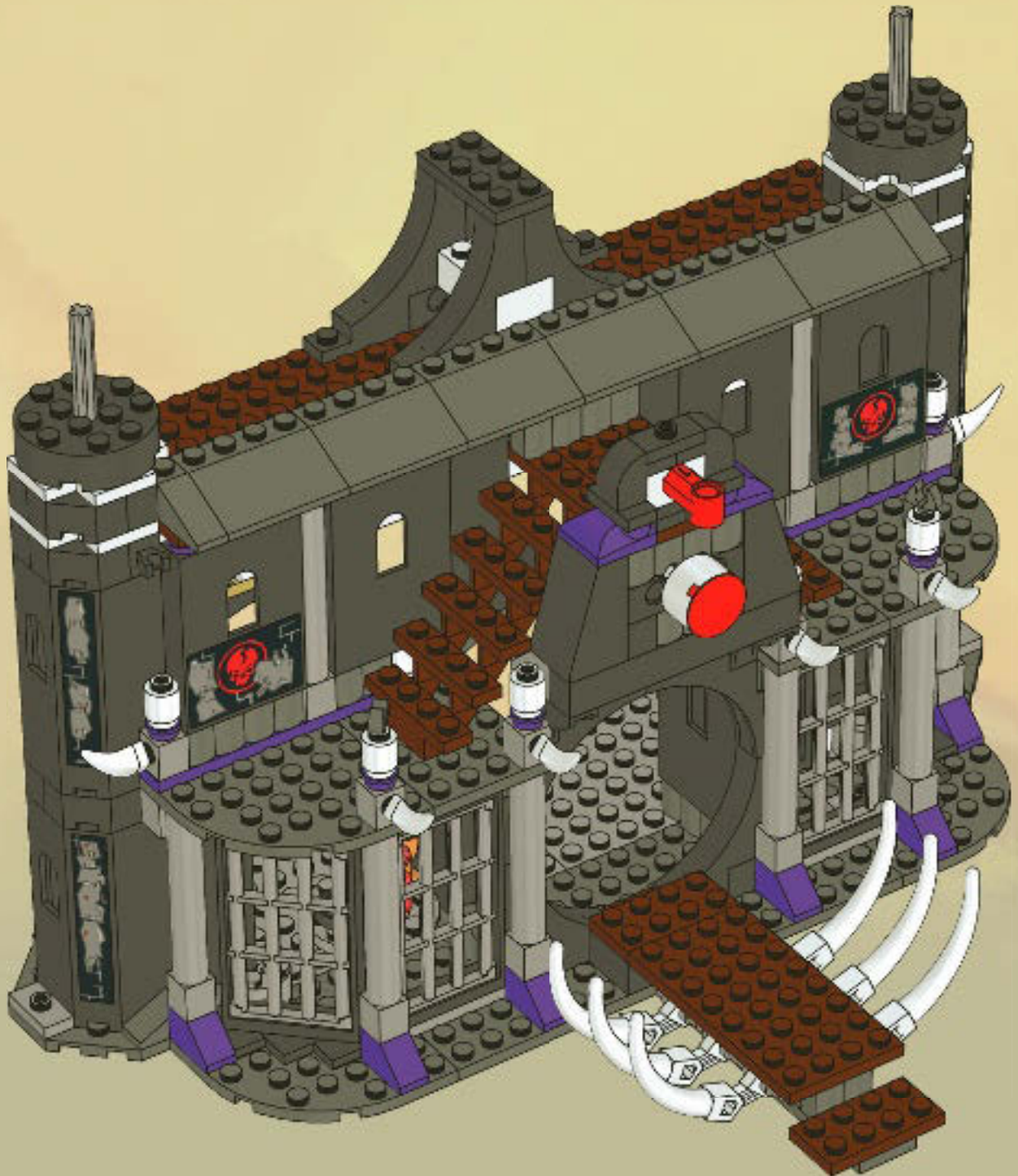

19



	
1x	2x
	
2x	5x
	
	2x



2x

20

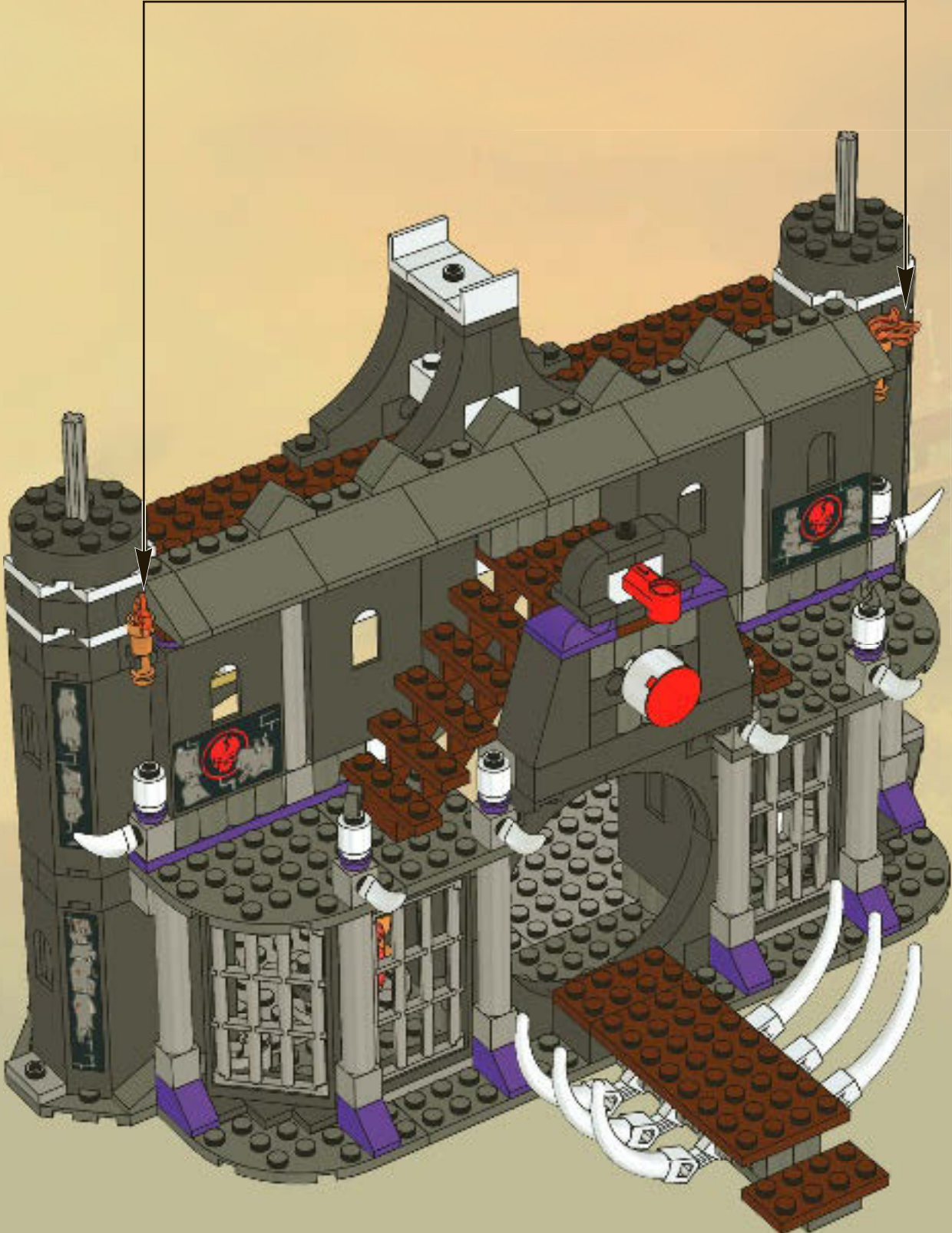

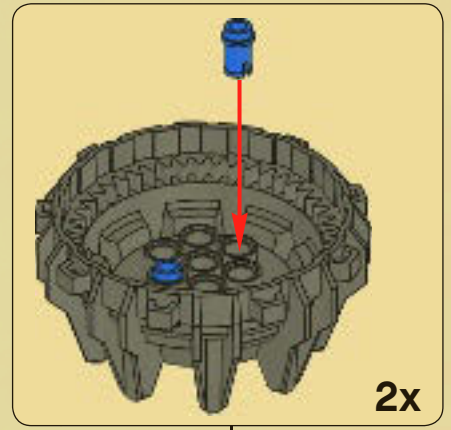
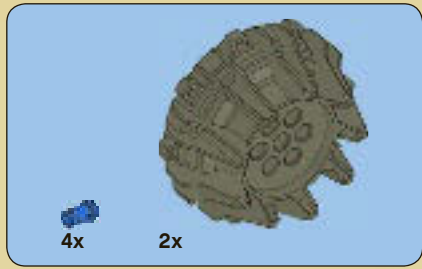

21

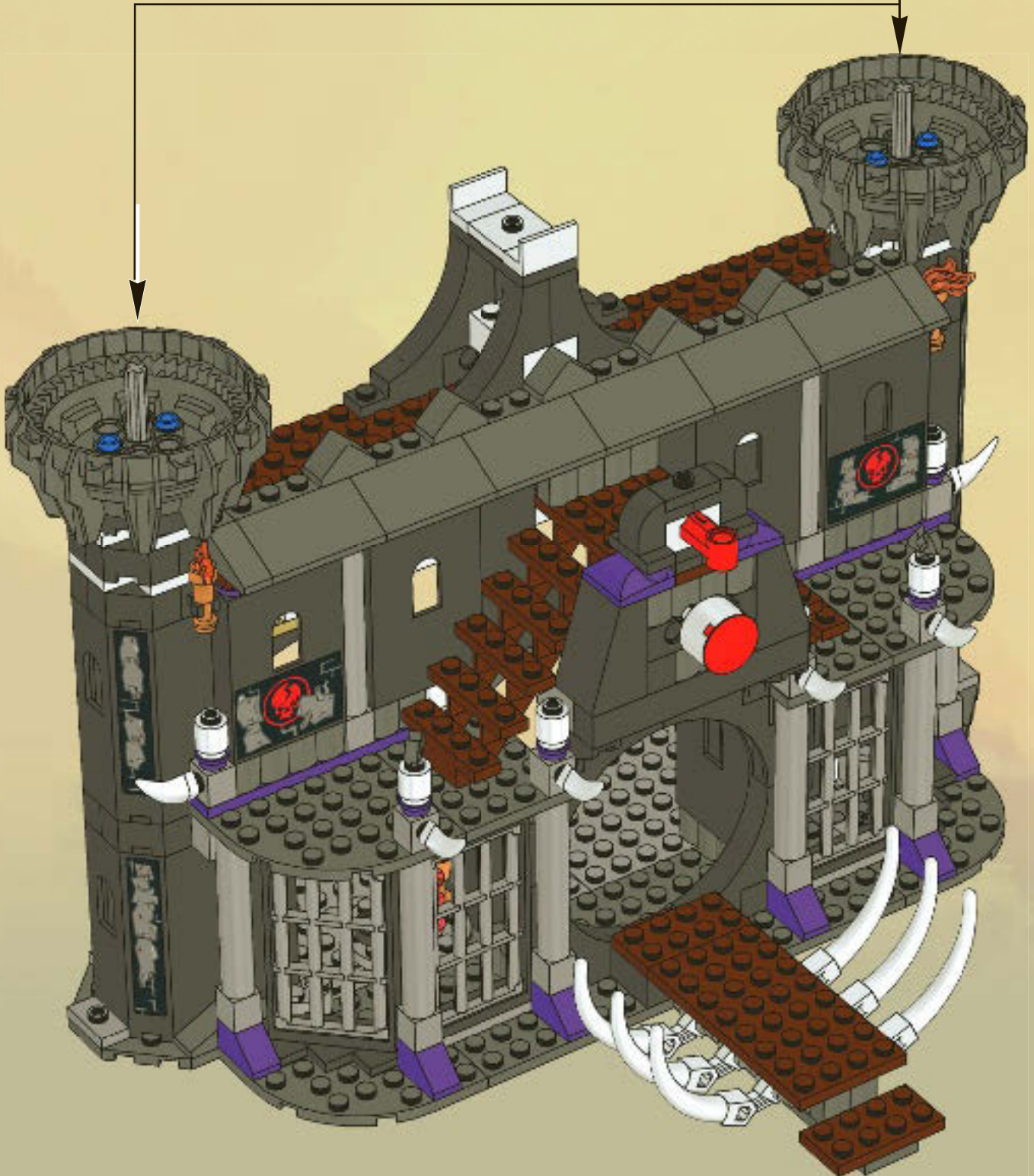

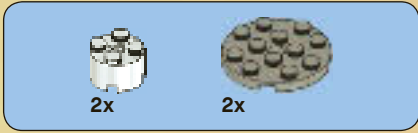

22

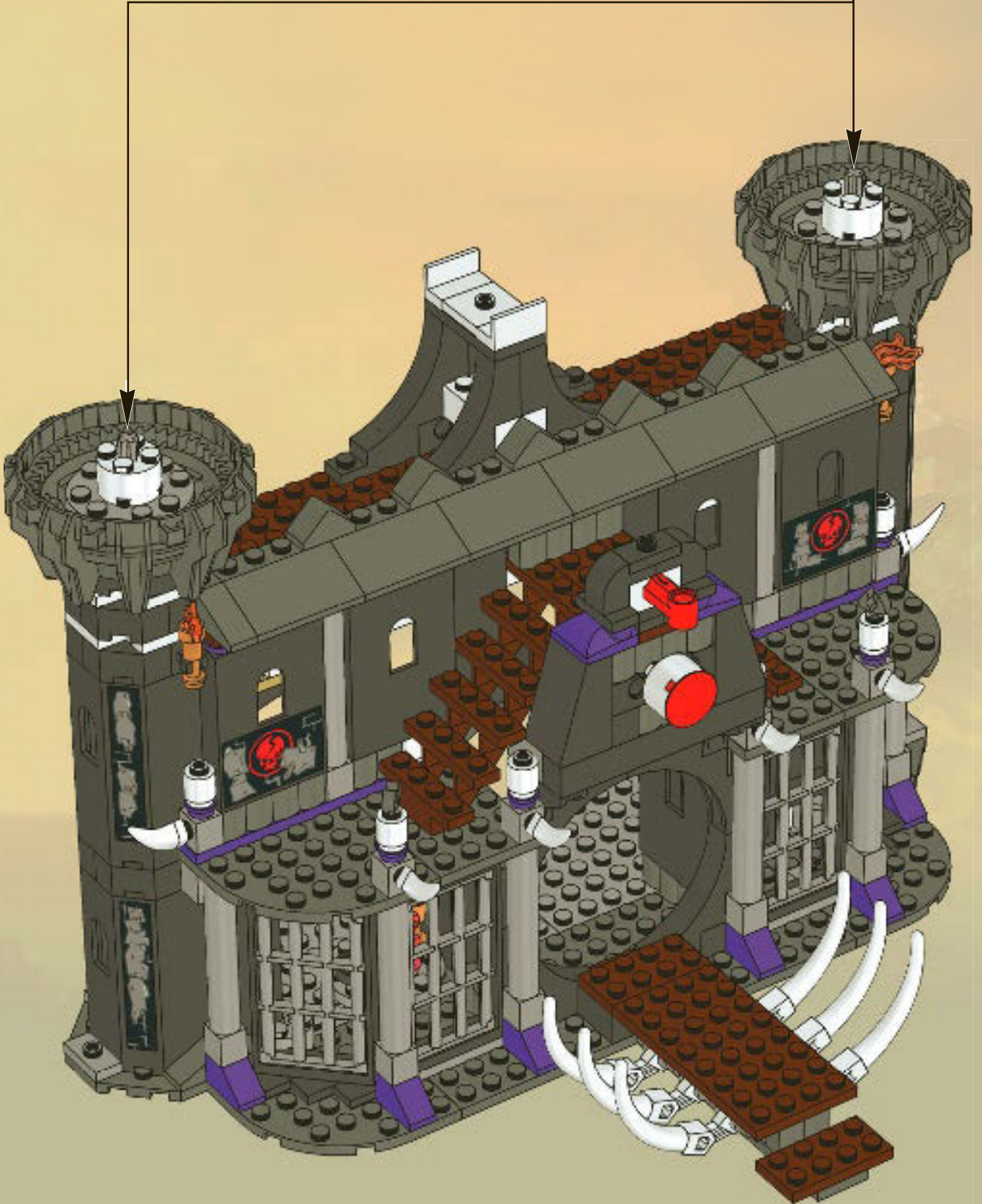

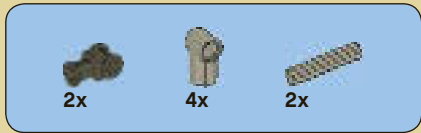

23

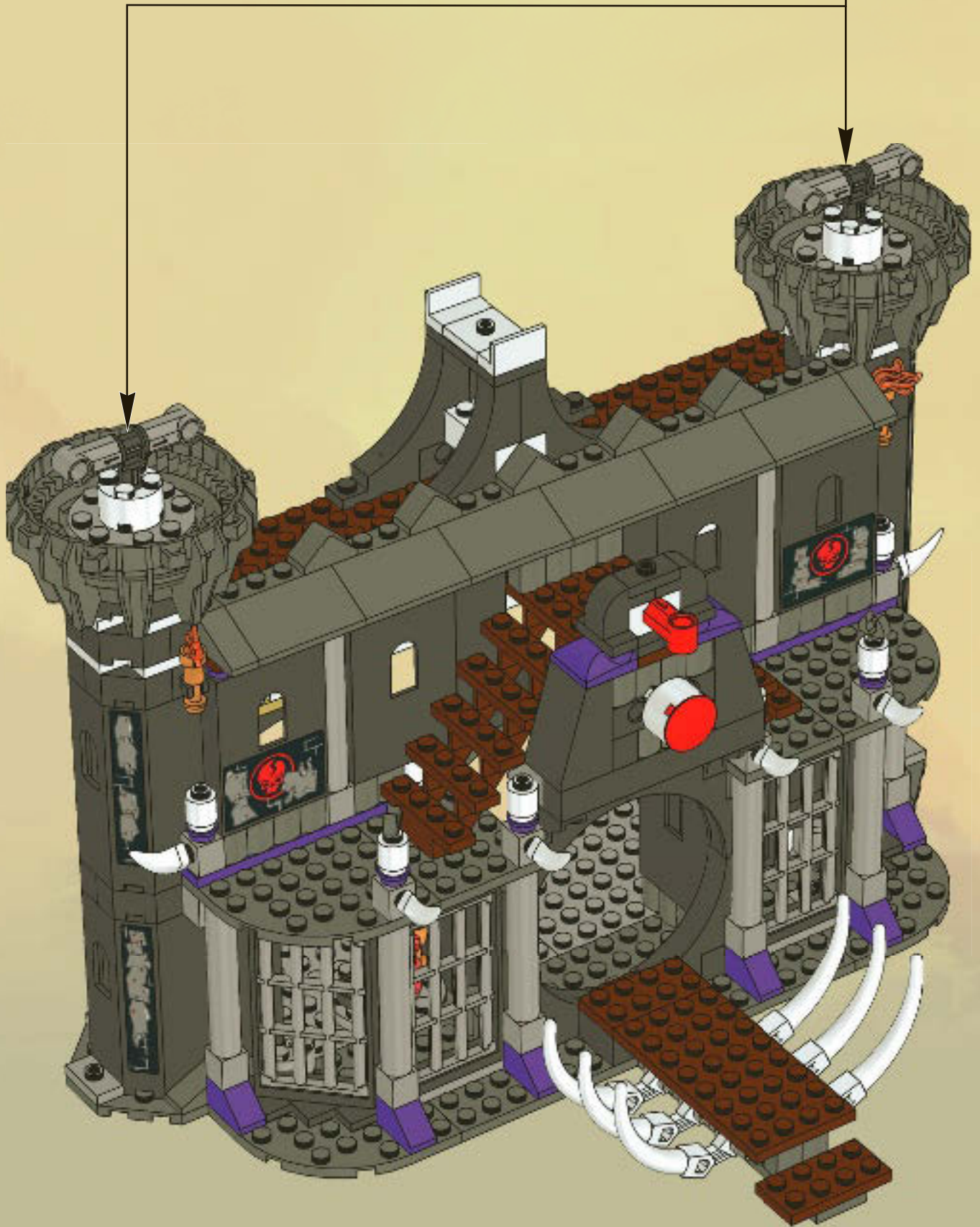

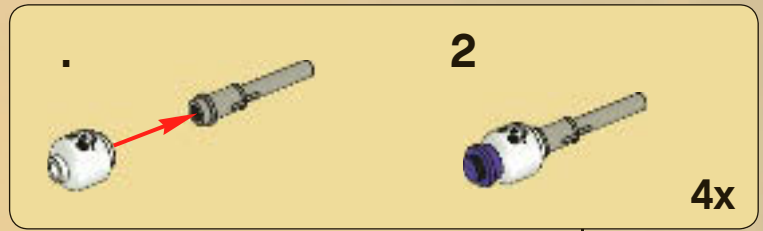
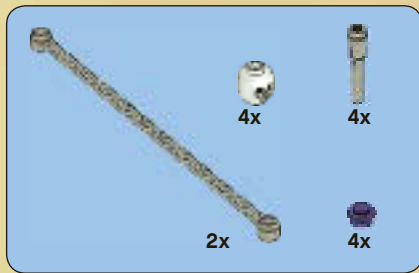

24

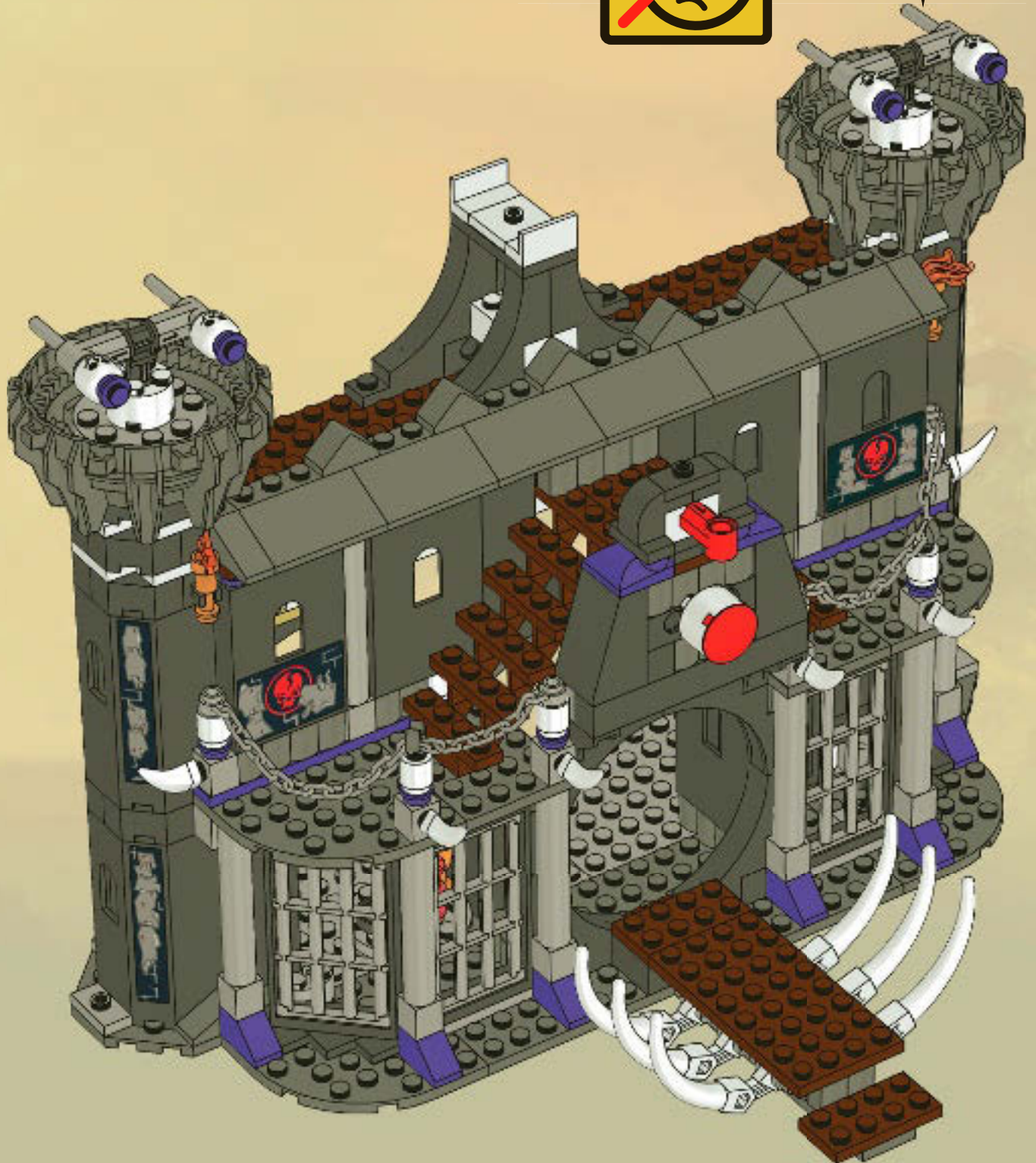



1

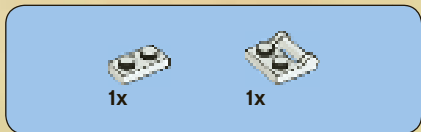
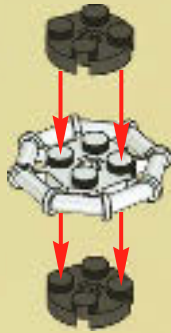

2



3





4

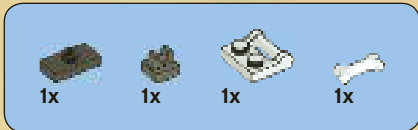
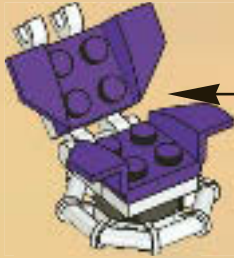
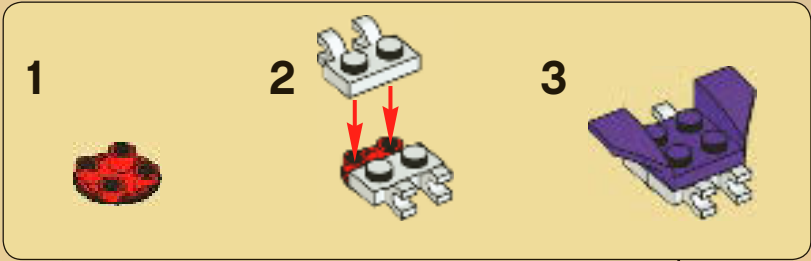

5

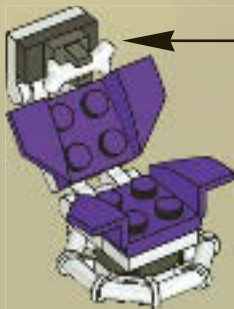



4x



4x

6

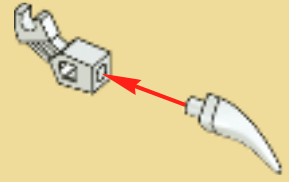
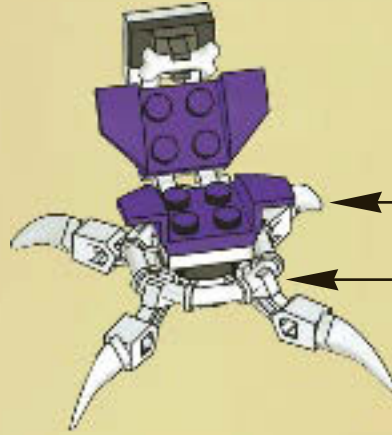

4x



2x



2x

7

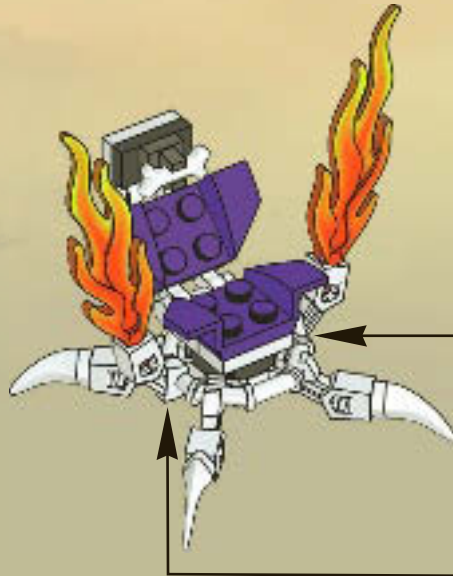

2x

25

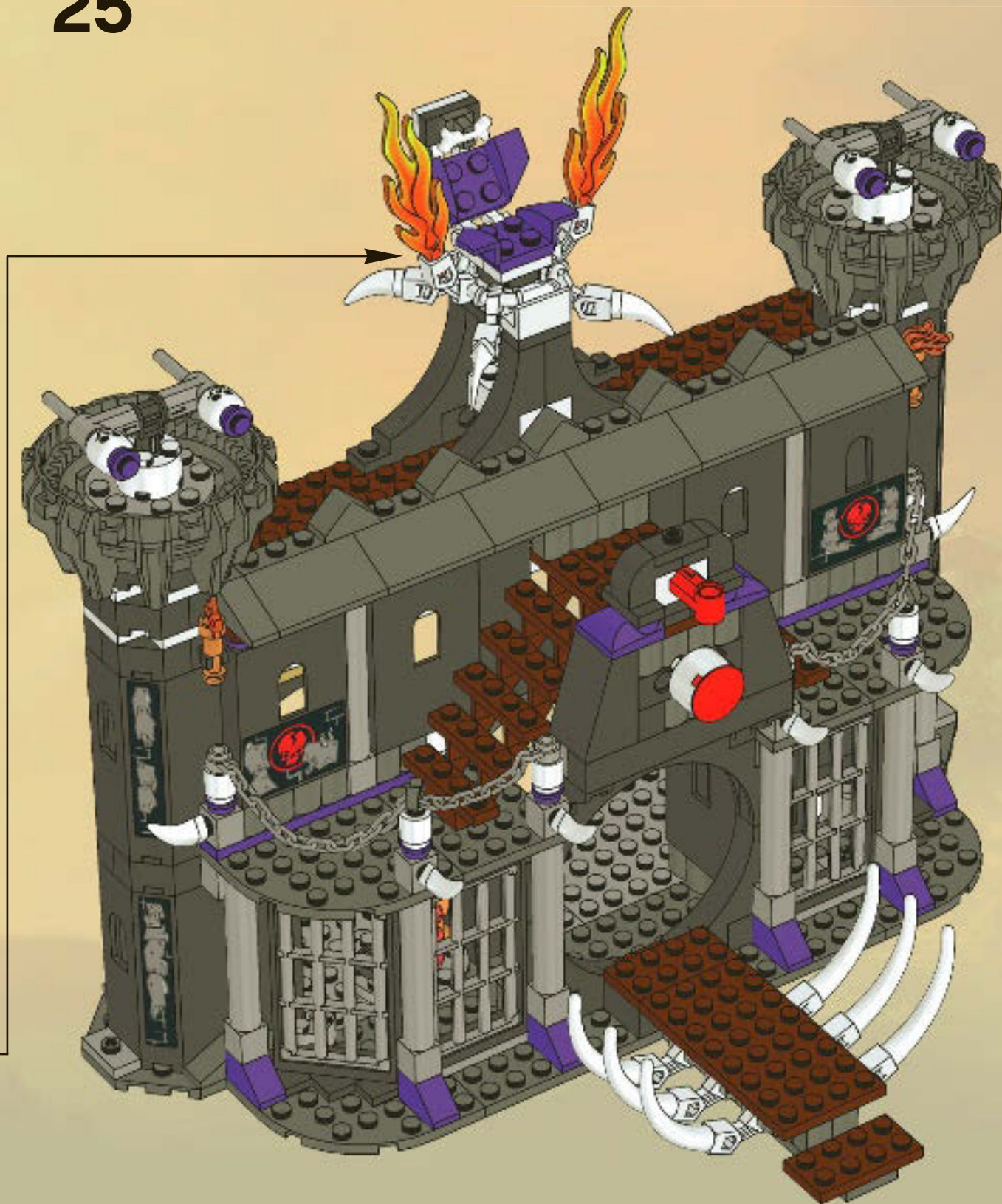

1

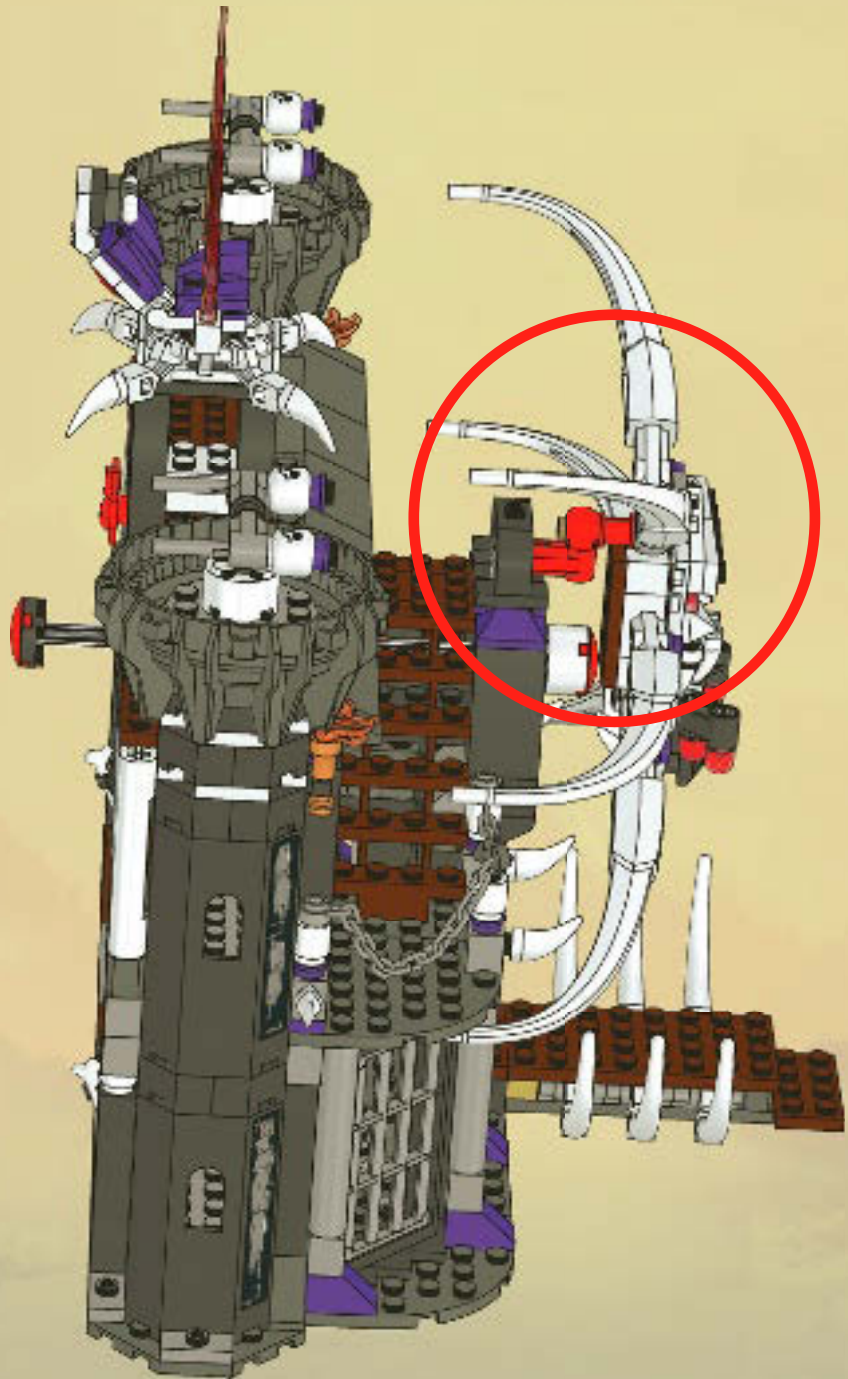

2

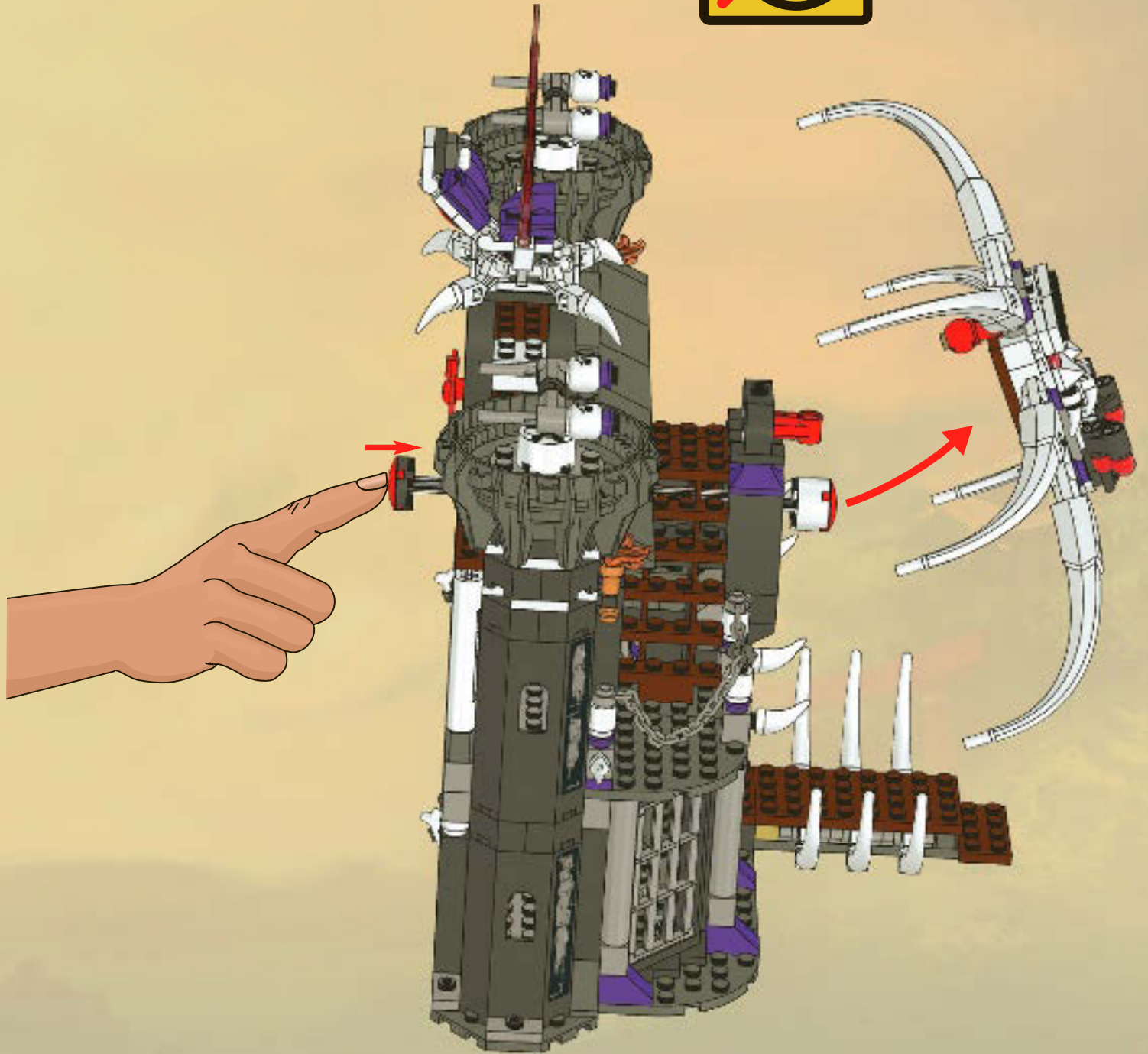



NINJAGO

Masters of Spinjitzu





NINJAGO

Masters of Spinjitzu



2260



2504



2258



2259



2263



2516



NINJAGO

Masters of Spinjitzu

NINJAGO.COM



JAY



KAI



ZANE



COLE



NYA



ZANE DX



SENSEI WU



GARMADON



NUCKAL



FRAKJAW



KRAZI



CHOPOV



BONEZAI



SAMUKAI



LEGO

NINJAGO

Masters of Spinjitzu

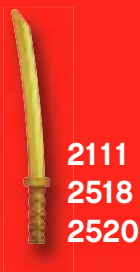

2111
2518
2520



2111
2113
2263
2516



2111



2112



2112
2259
2504
2505
2516
2519
2520



2112



2113
2504
2505
2260



2113
2257
2258
2263
2504
2505
2519
2520



2114
2520



2114
2257
2504



2114
2257



2115



2115



2115
2505
2258



2116



2116



2116



2257



2257



2257
2504



2505
2263
2258



2505
2259
2520



2505



2504
2519



2516

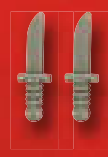

2516



2259



2518



2518



2519



2520



2520



2504
2520



2520



NINJAGO

Masters of Spinjitzu



2111



2257



2112



2113



2114



2115



2116

NINJAGO

Masters of Spinjitzu





NINJAGO

Masters of Spinjitzu



NINJAGO.COM

NINJAGO

THE BOARD GAME

3856

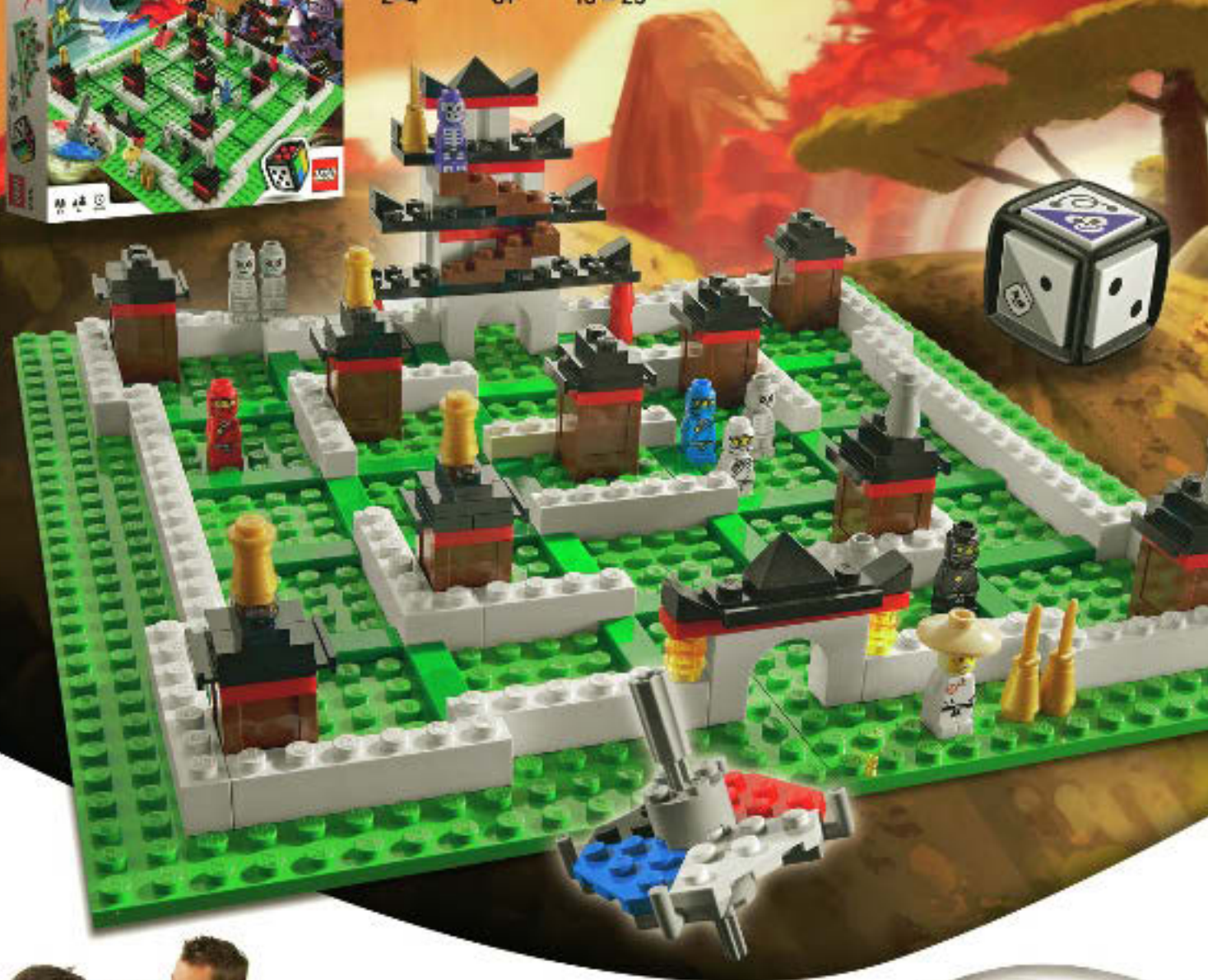

www.LEGO.com/LEGOGames



UNIVERSE

www.LEGOuniverse.com

7™

www.pegi.info



**MASSIVELY MULTIPLAYER ONLINE GAME
MEHRSPIELER ONLINE SPIEL
JEU EN LIGNE MASSIVEMENT MULTIJOUEUR
VIDEOJUENGO MULTIJUGADOR MASIVO EN LÍNEA
JOGO MULTIJOGADOR ONLINE EM MASSA
NAGYON SOK SZEREPLŐS ONLINE JÁTÉK**



Einstufung
ausstehend

USK

Rating pending



NINJAGO

Masters of Spinjitzu





WIN!

Go to www.LEGOsurvey.com/product to fill out a survey for a chance to win a cool LEGO® Product. No purchase necessary. Open to all residents where not prohibited.

 www.LEGO.com



www.LEGOsurvey.com/product

GEWINNE!

Nimm an der Umfrage auf www.LEGOsurvey.com/product teil und hab die Chance ein cooles LEGO® Produkt zu gewinnen!

Die Teilnahme am Gewinnspiel führt zu keinerlei Kaufverpflichtungen. Teilnahme in allen nicht ausgeschlossenen Ländern möglich.

6000617 / 6000620

WIN!

Ga naar www.LEGOsurvey.com/product, vul een enquêteformulier in en maak kans op een cool LEGO® product.

Geen aankoopverplichting. Iedereen mag deelnemen, uitgezonderd ingezetenden van landen waar een enquêteverbod geldt.

GAGNE !

Visite www.LEGOsurvey.com/product pour répondre à un questionnaire et avoir une chance de gagner un produit LEGO® très cool !

Aucune obligation d'achat. Ouvert à tous les résidents des pays autorisés.

当てよう!

www.LEGOsurvey.com/product にアクセスして、アンケートにご記入ください。当選者にはレゴ製品を差し上げます。

お買い上げの必要はありません。禁止されていない限り、すべての皆様にご利用いただけます。

LEGO and the LEGO logo are trademarks of the LEGO Group. ©2011 The LEGO Group. © 2011 Lucasfilm Ltd. & TM. All rights reserved.