



NINJAGO

Masters of Spinjitzu



2507



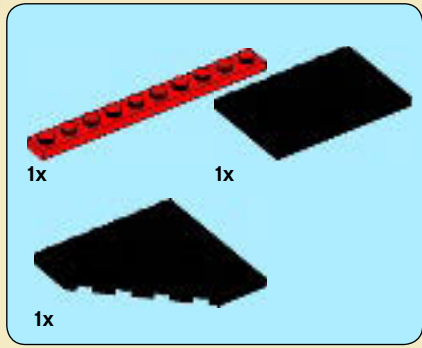

84

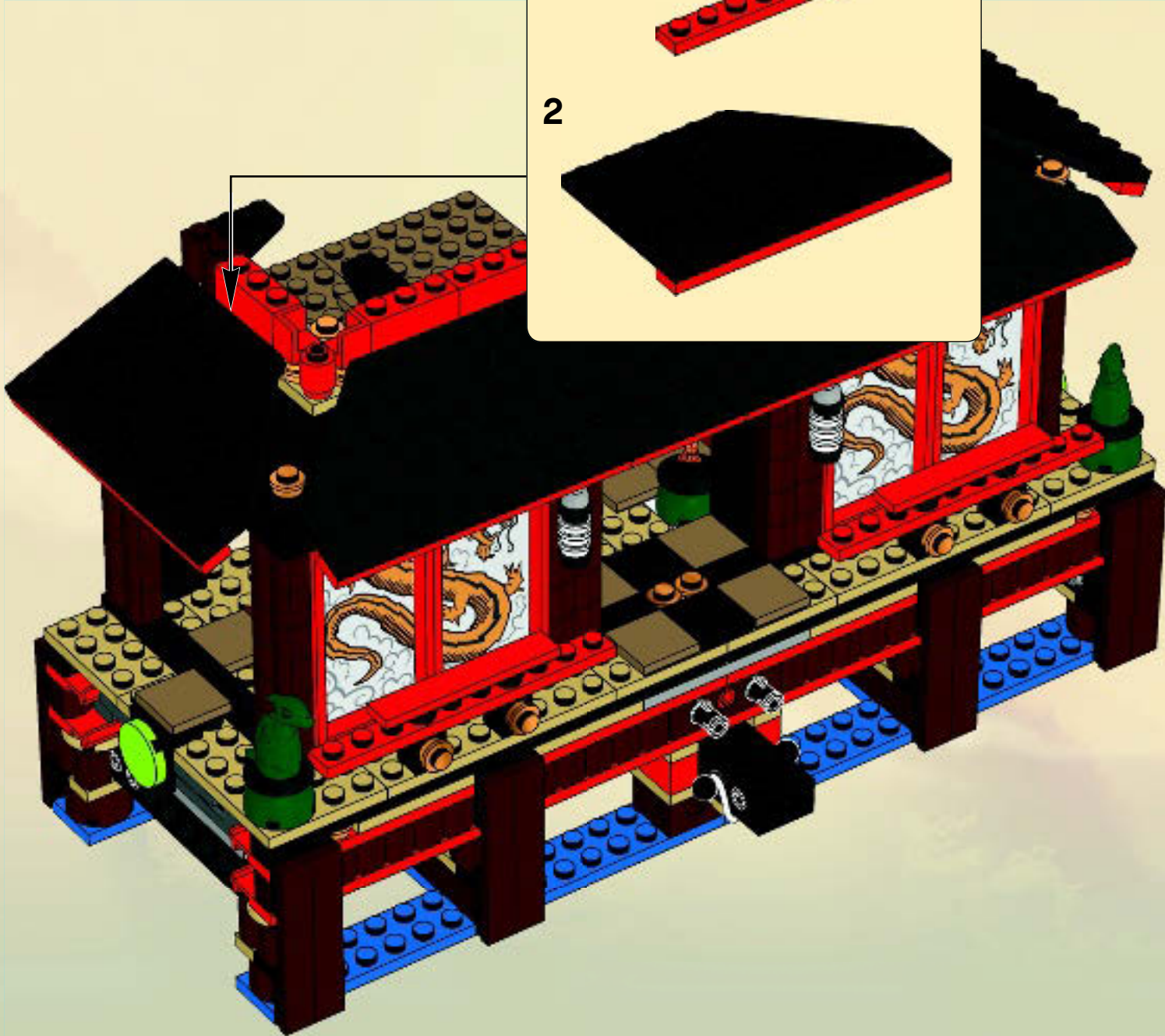
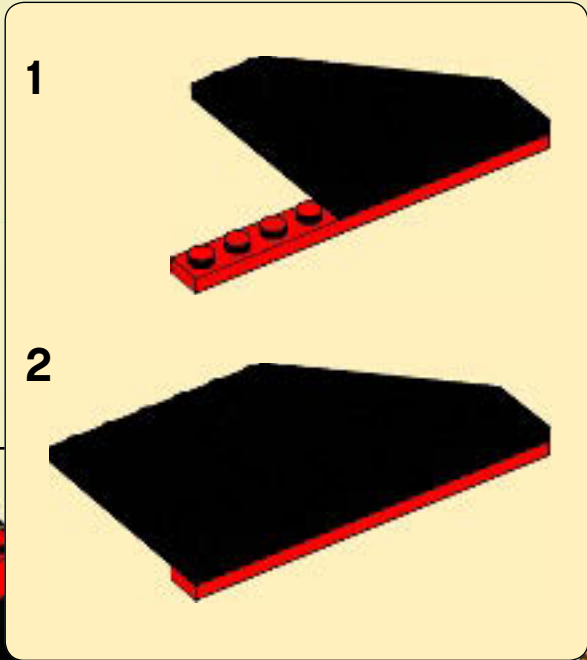

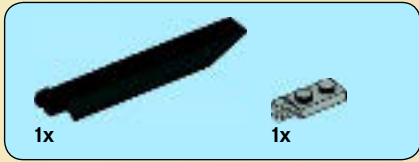

1

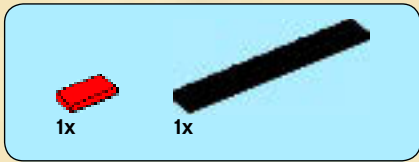
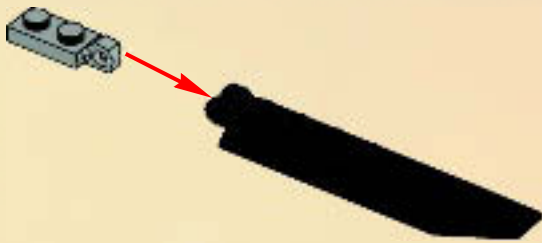

2

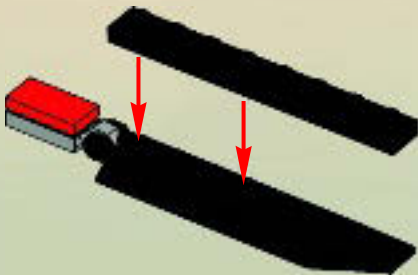

3

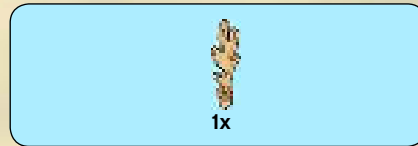

4



2x

85

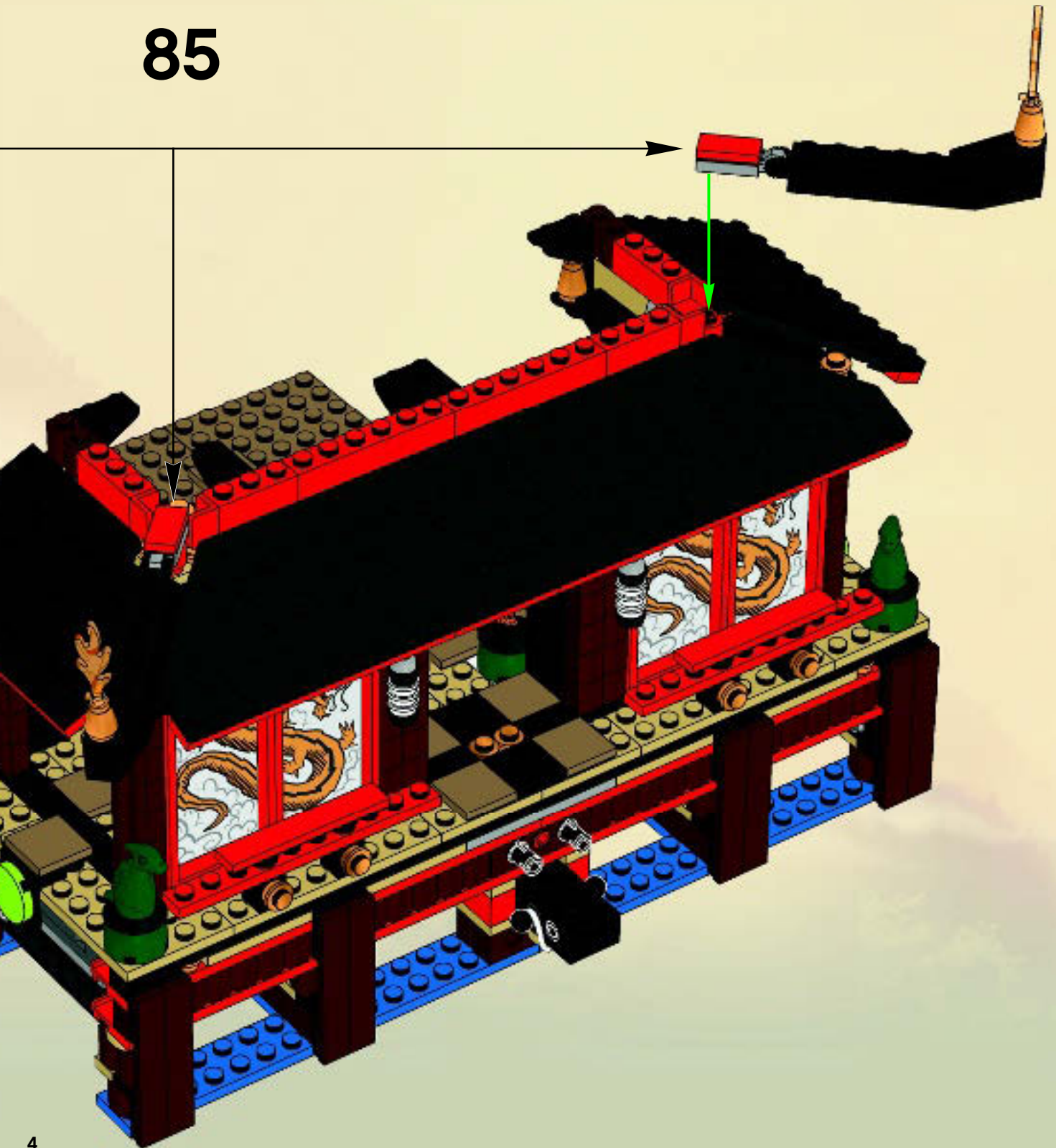



86

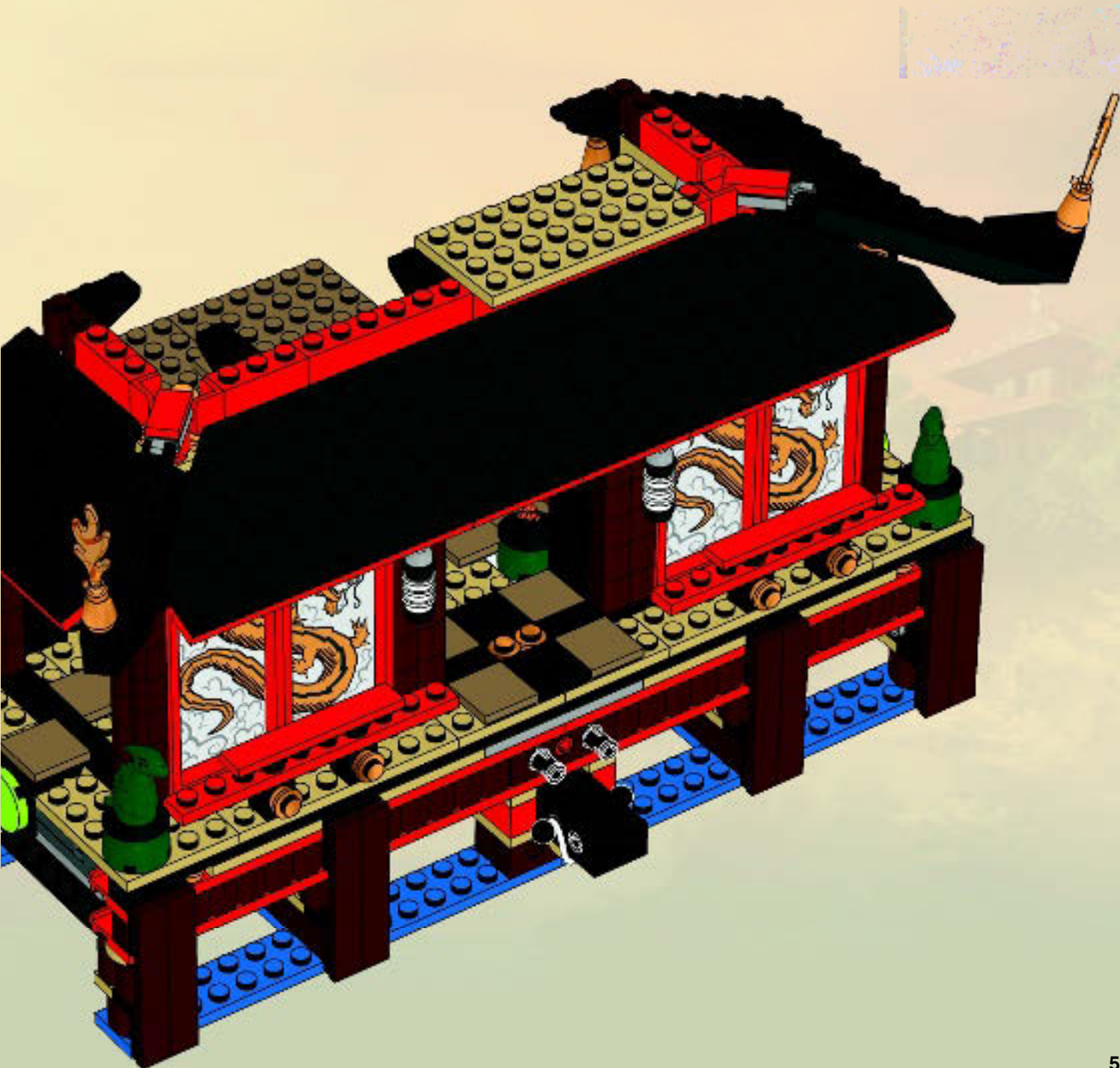



87

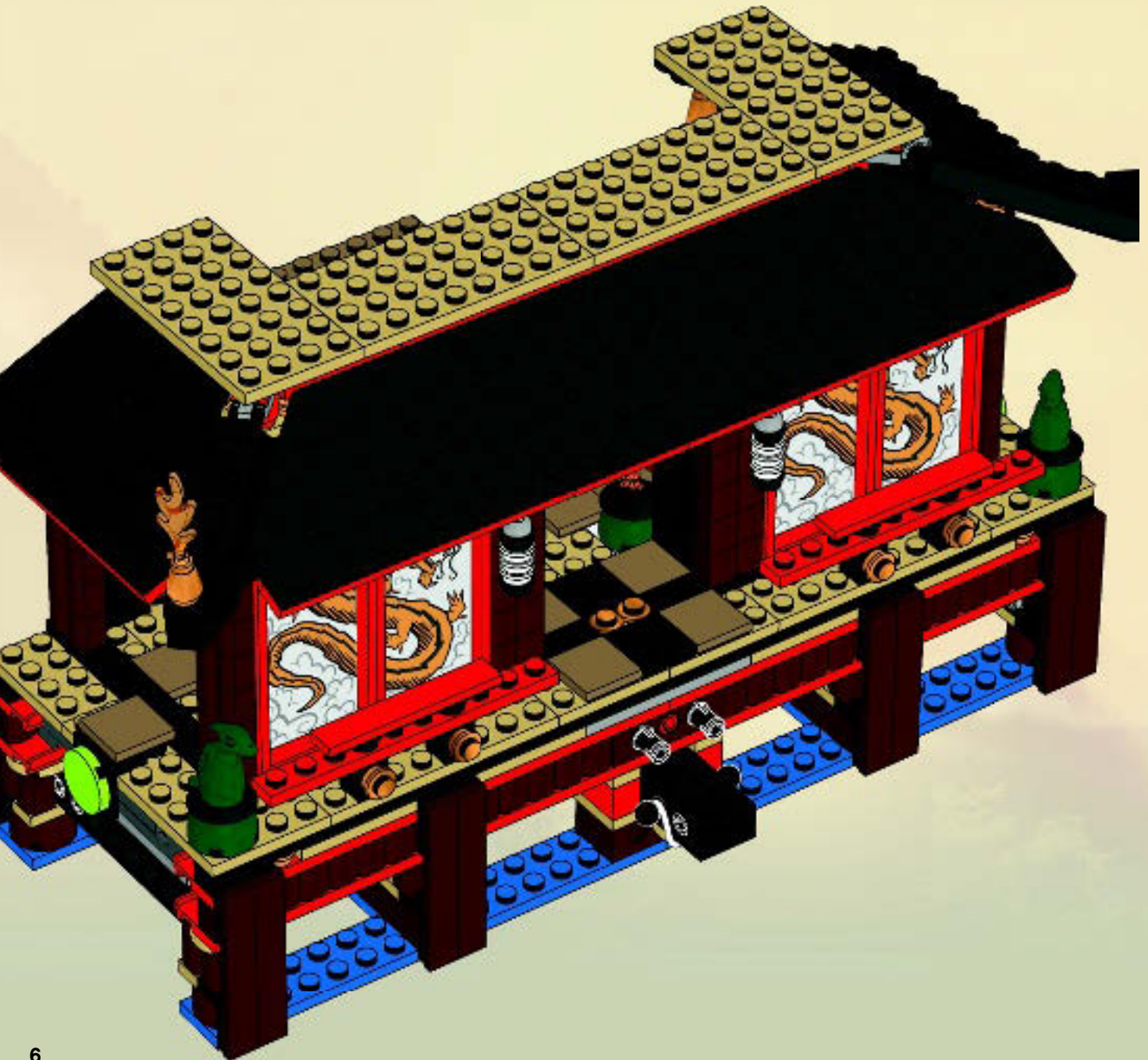

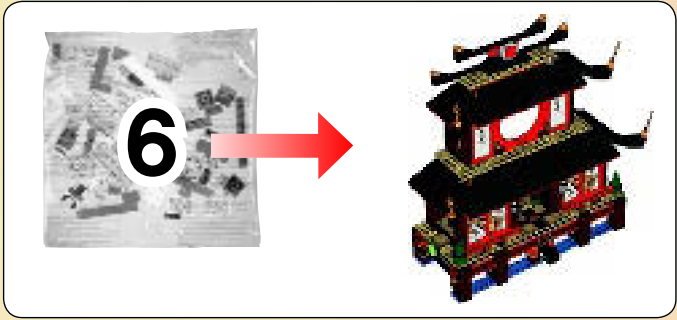

88



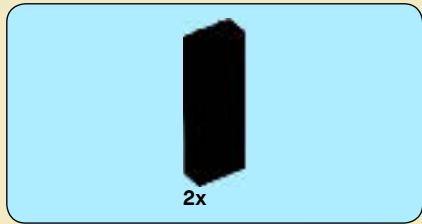

89





12x

90

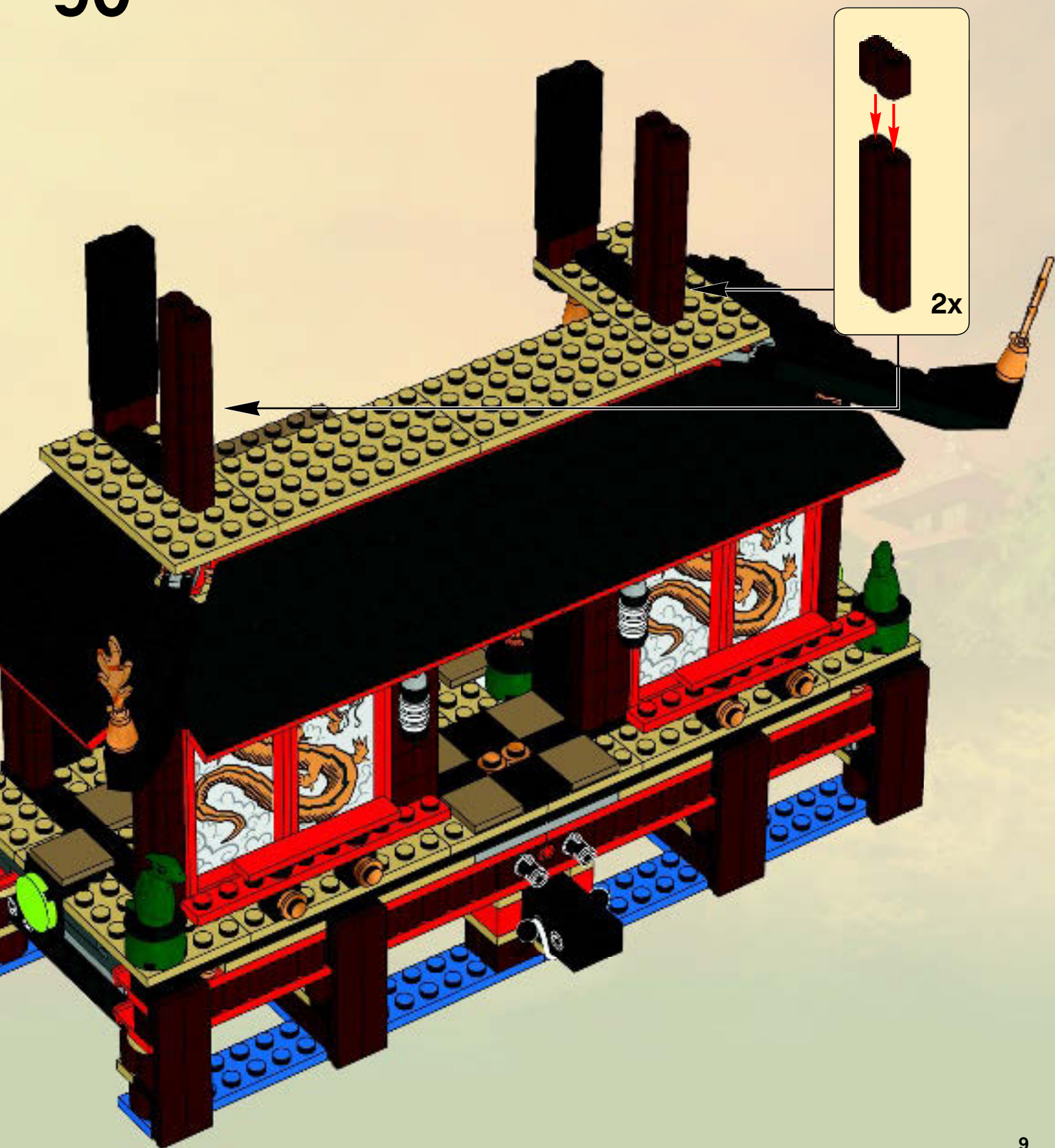

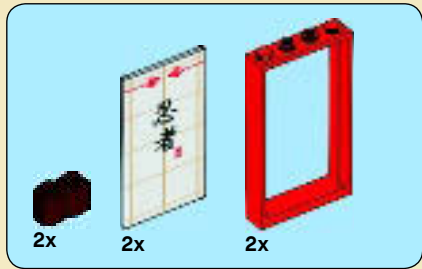

91

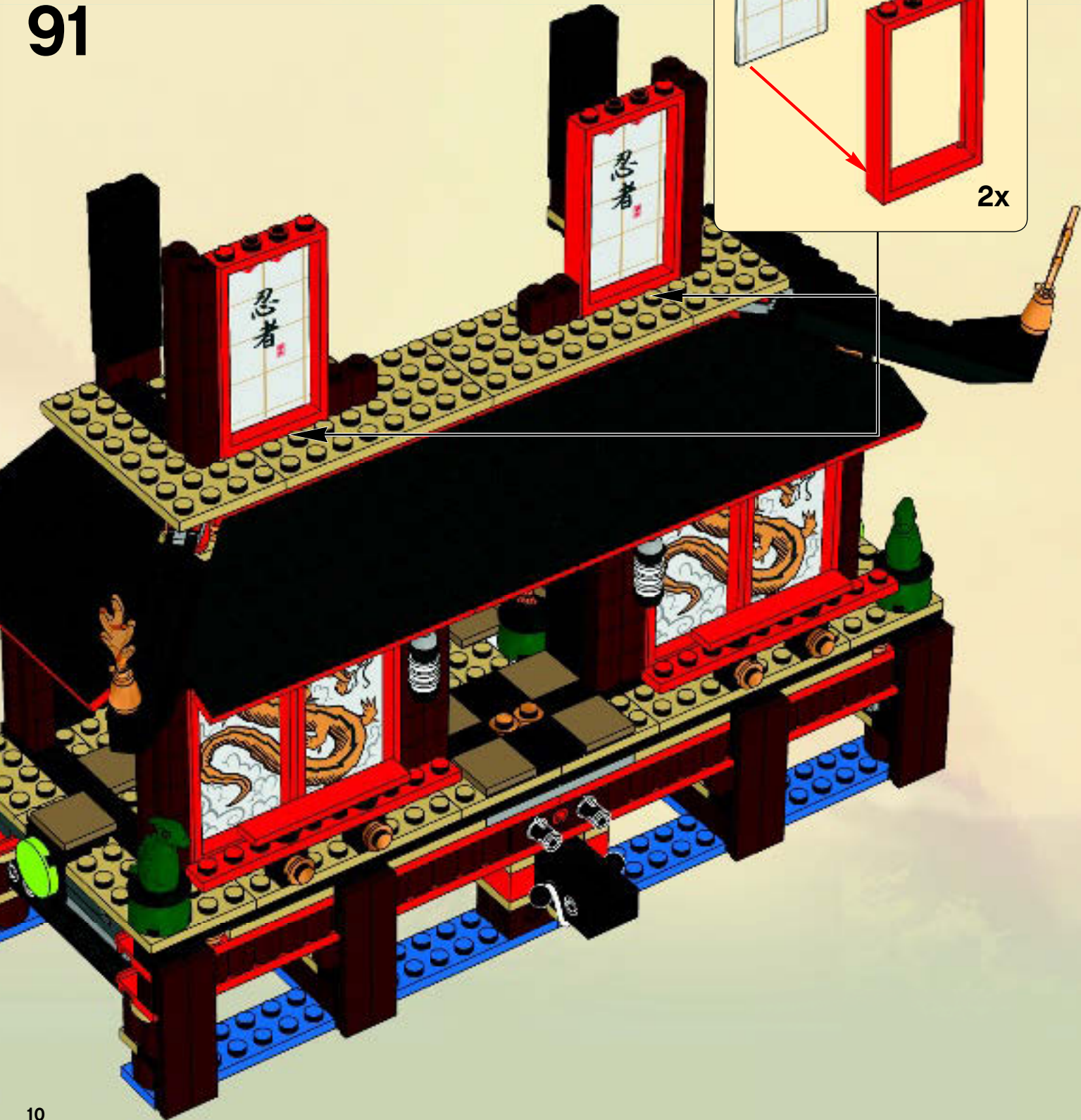
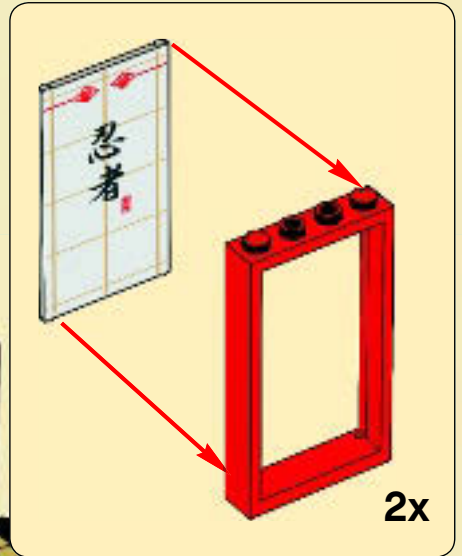



2x



2x

92

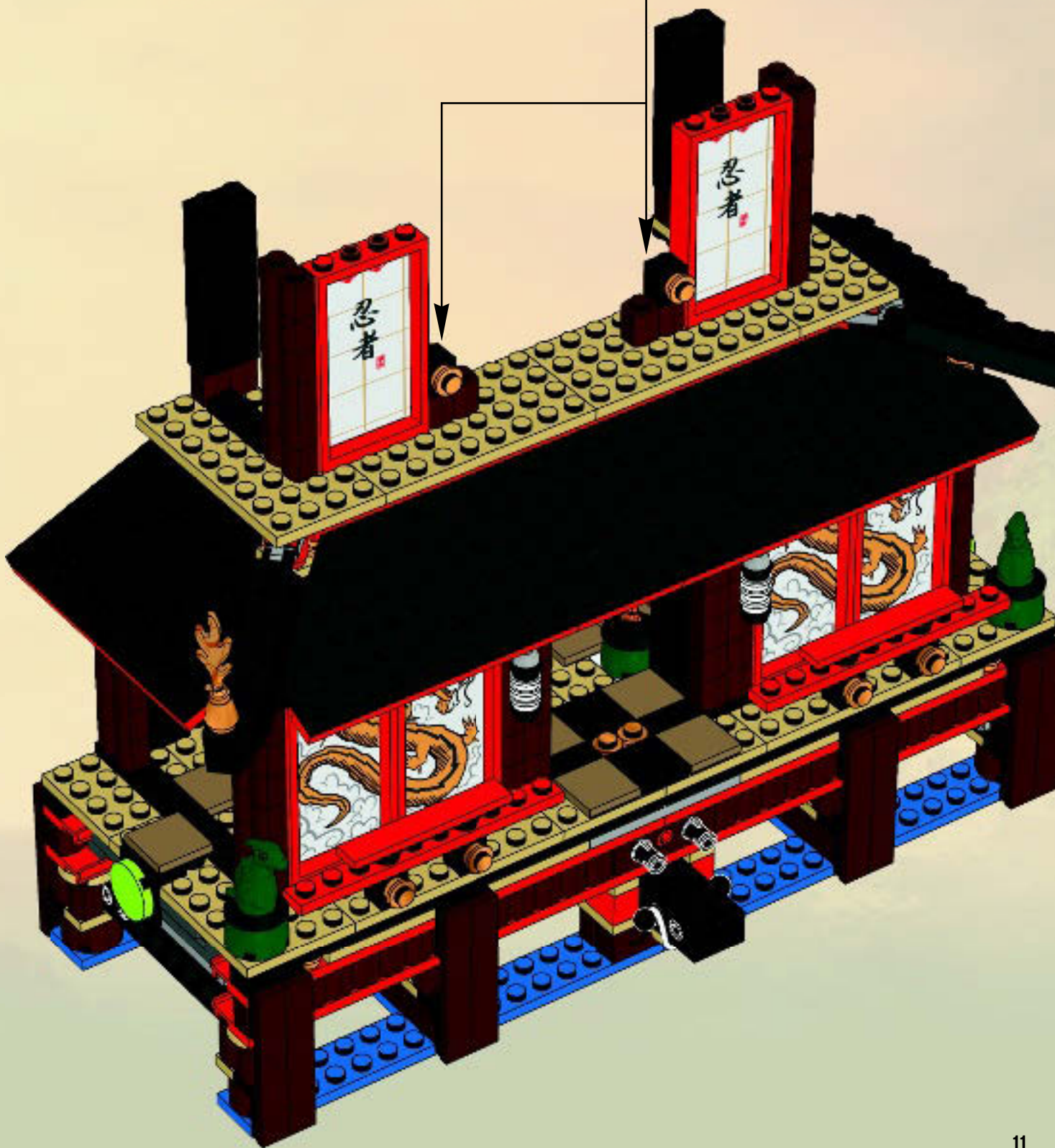
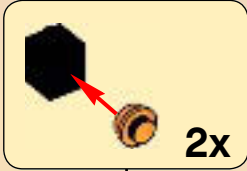

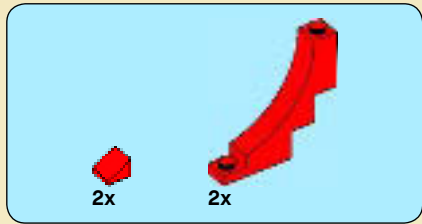

93



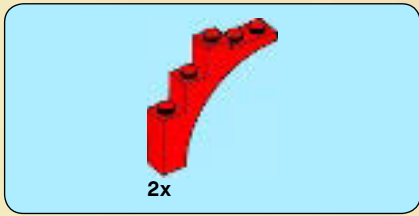

94





95

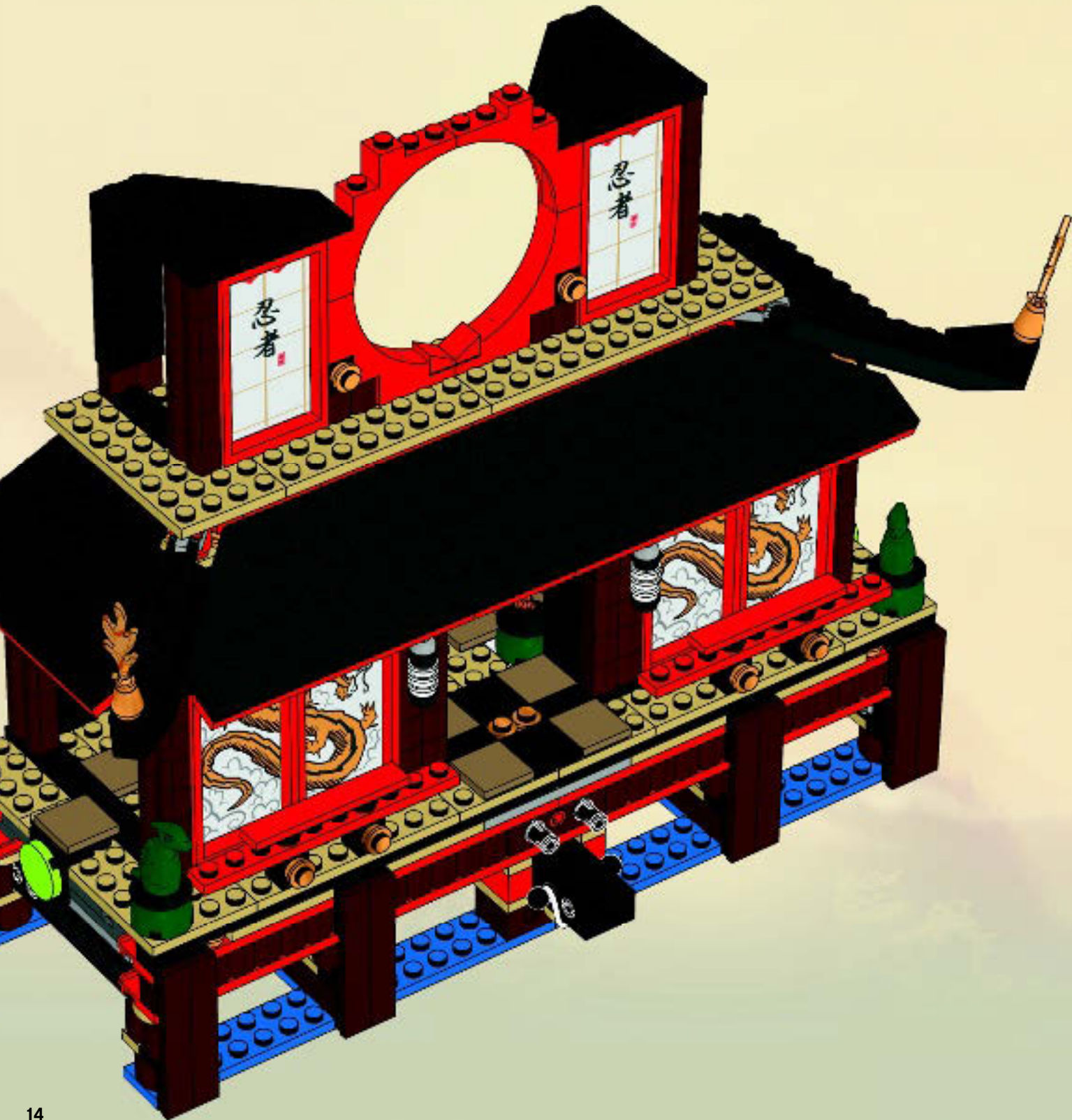

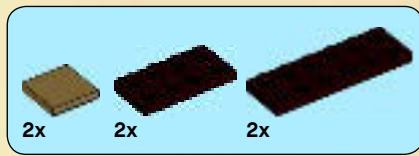

96





2x



2x

97

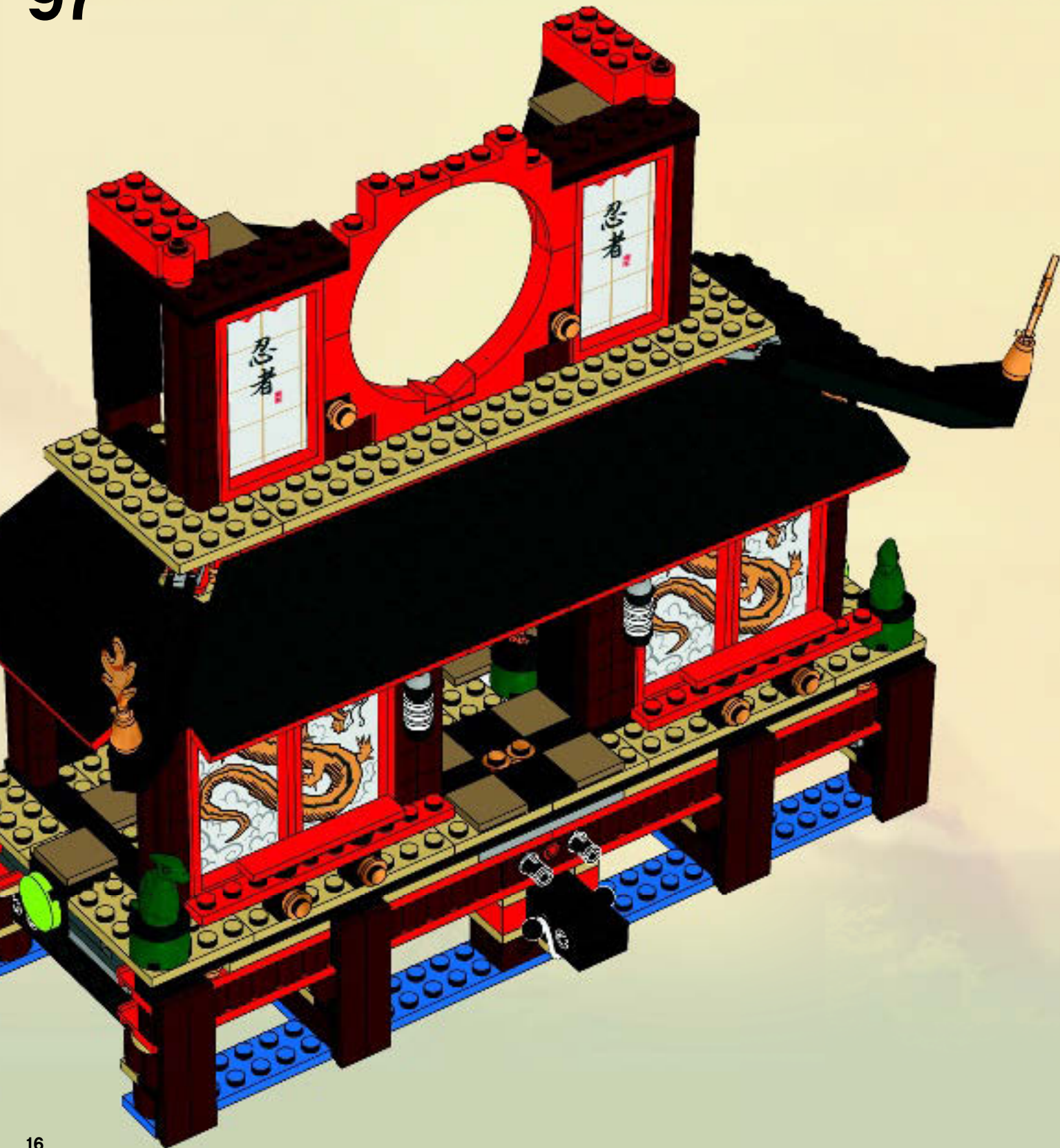

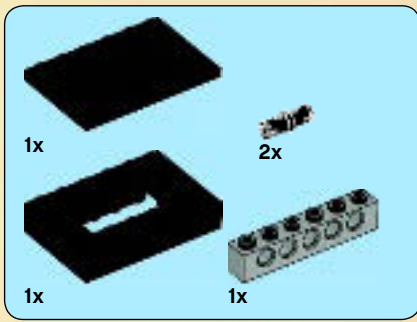

98

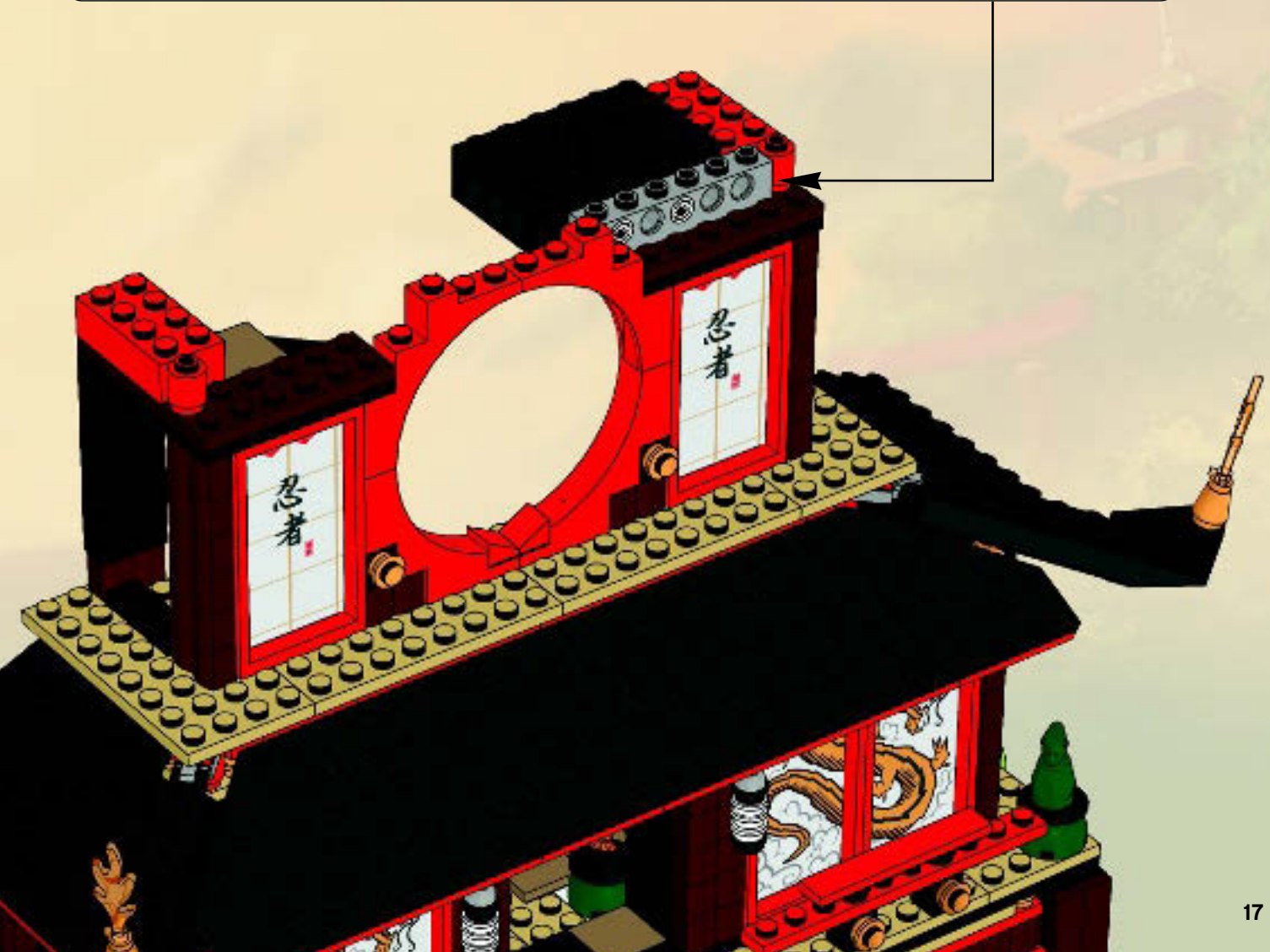
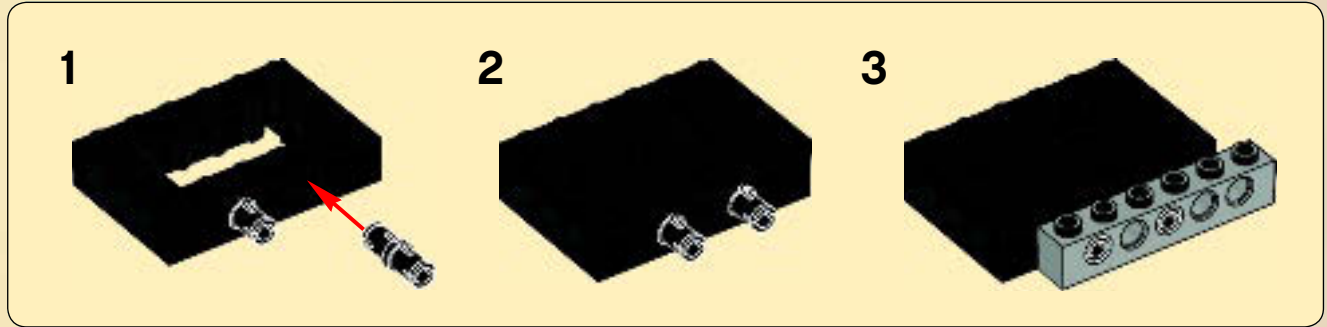

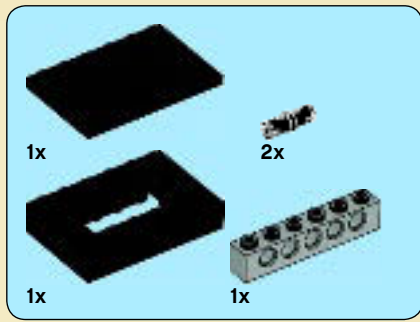

99

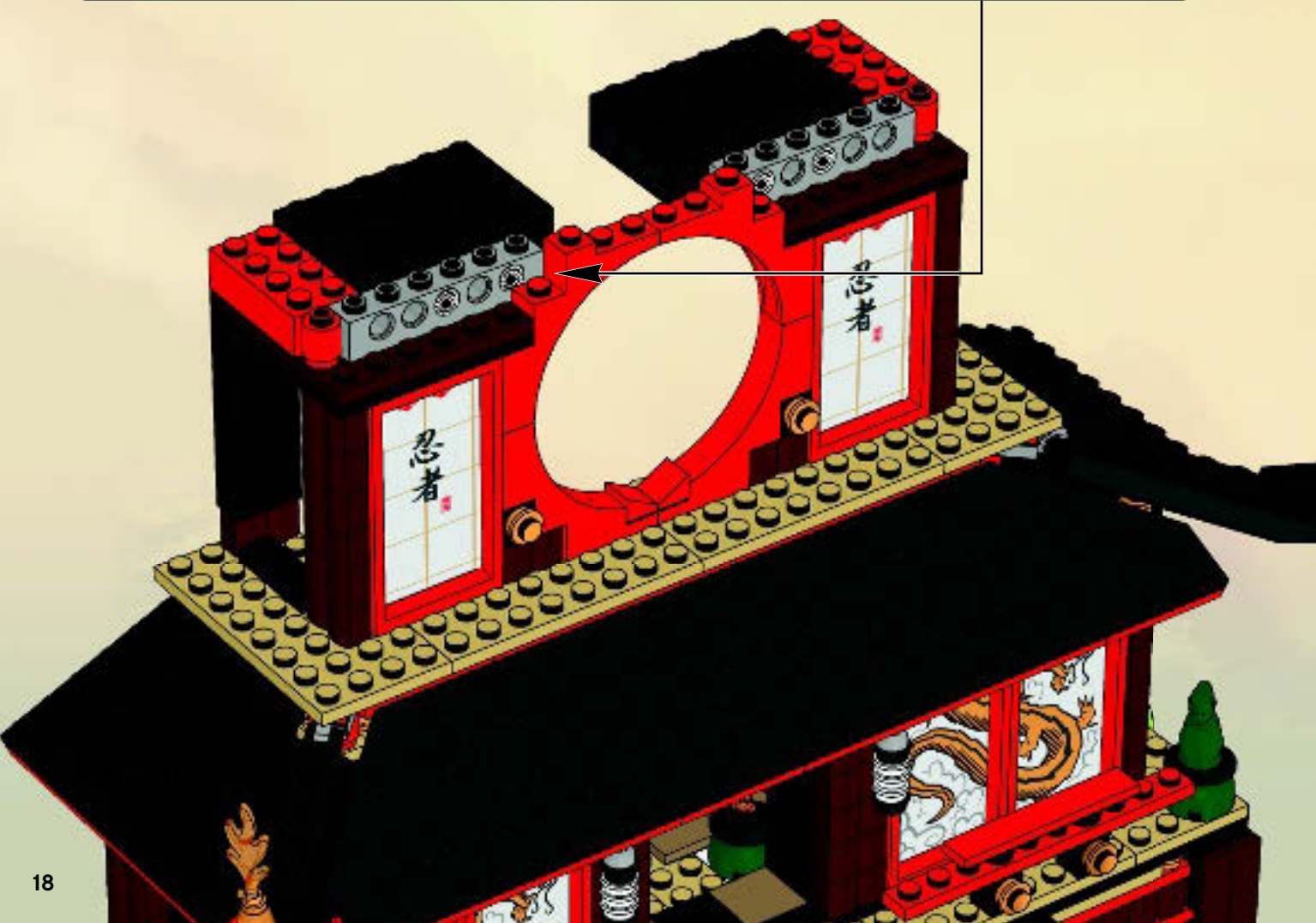
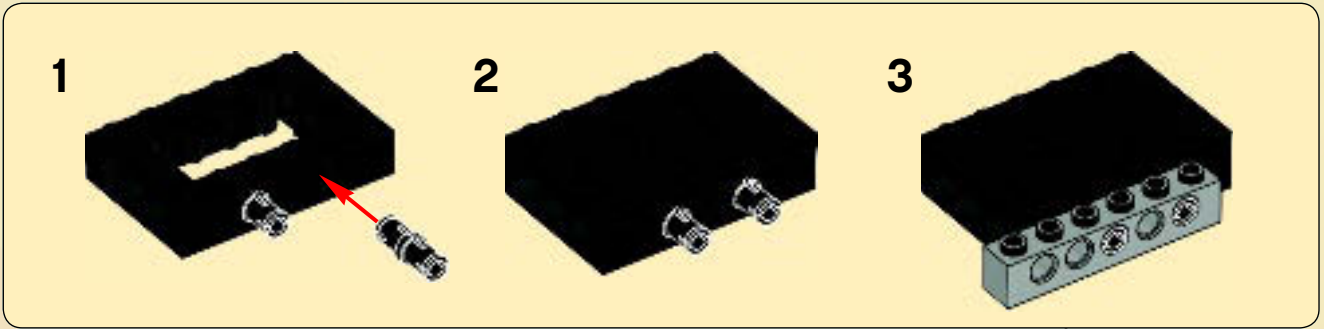

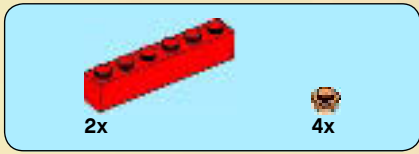

100

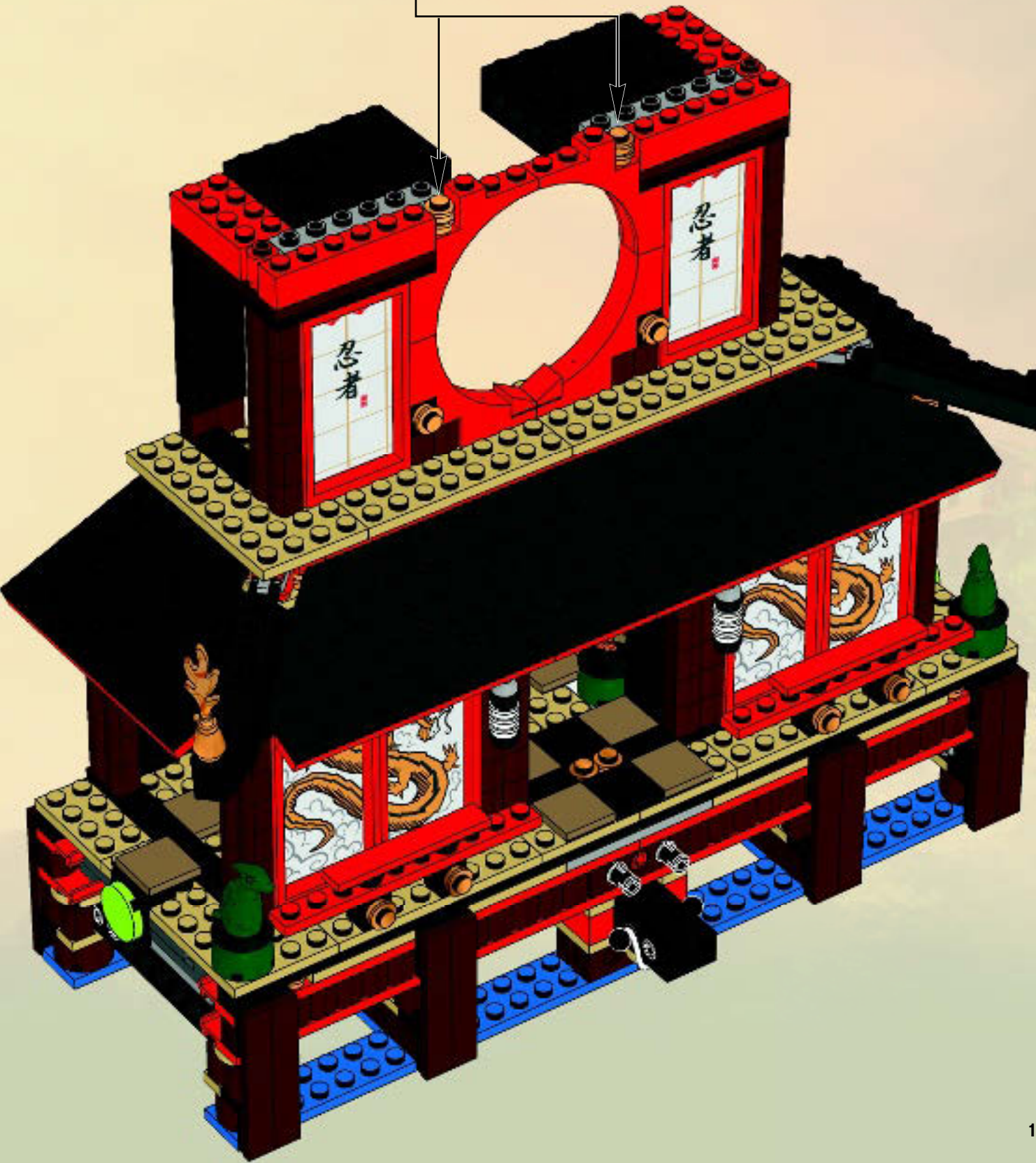



4x

101

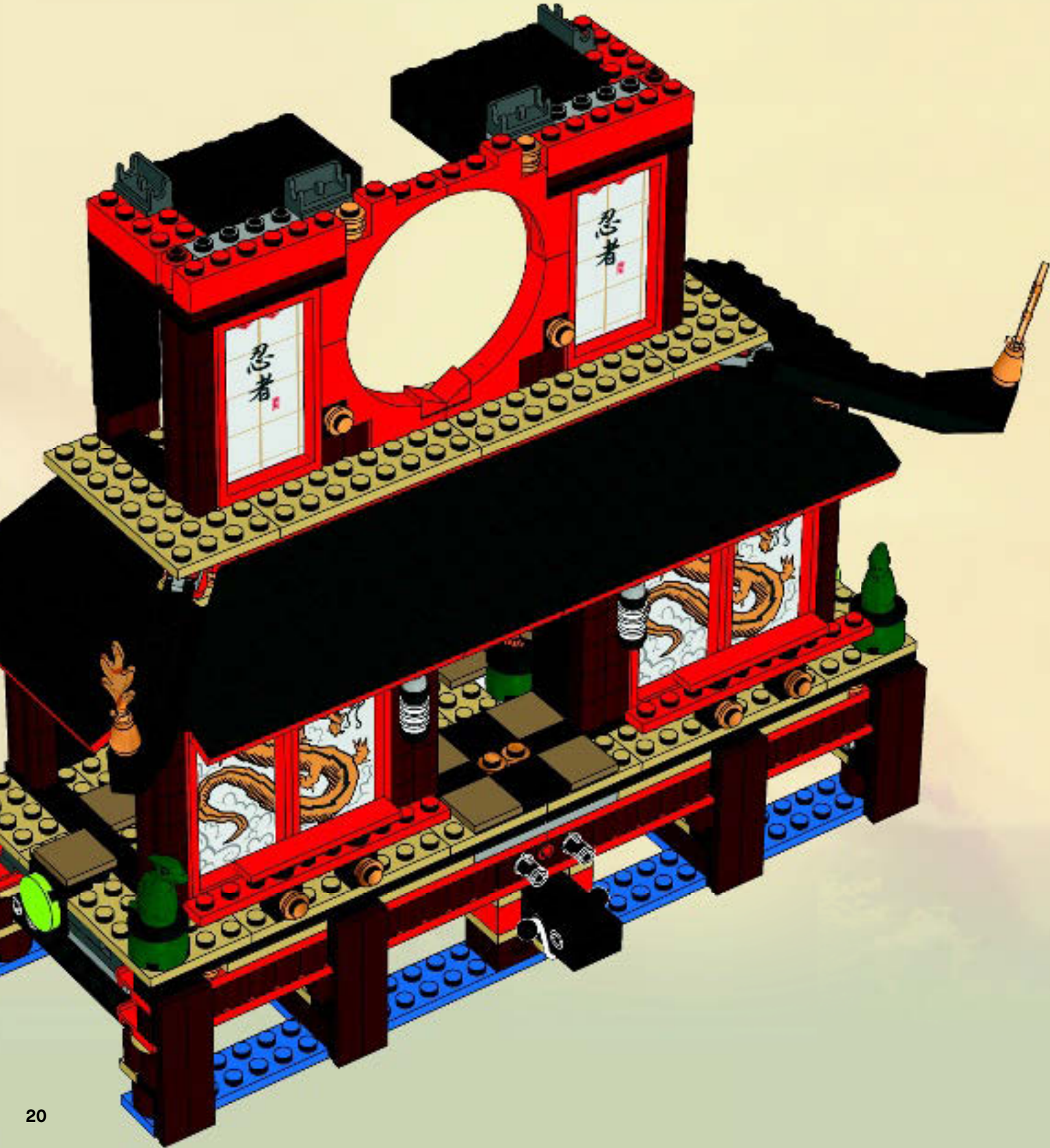



2x



4x

102

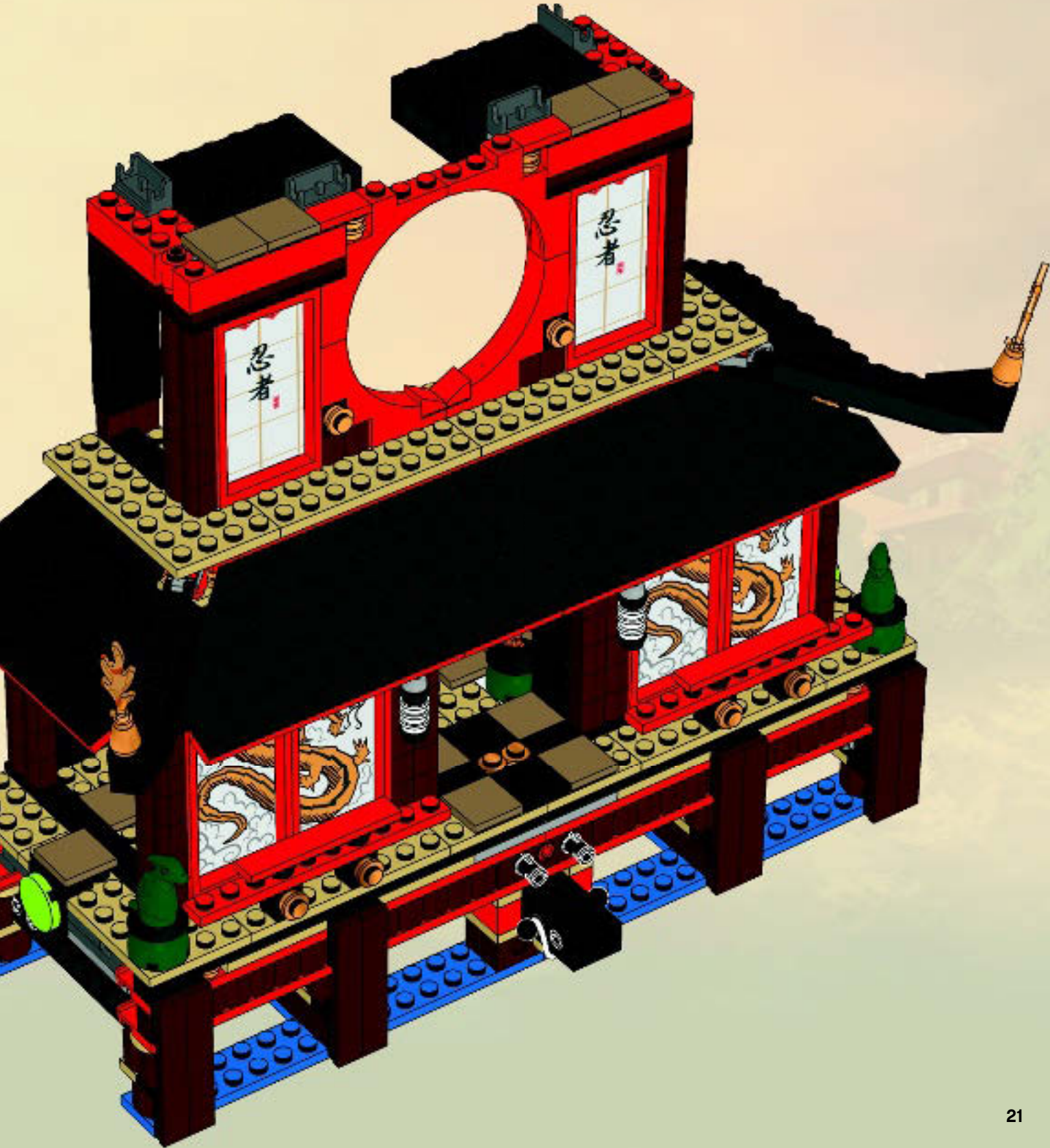



2x



2x

103

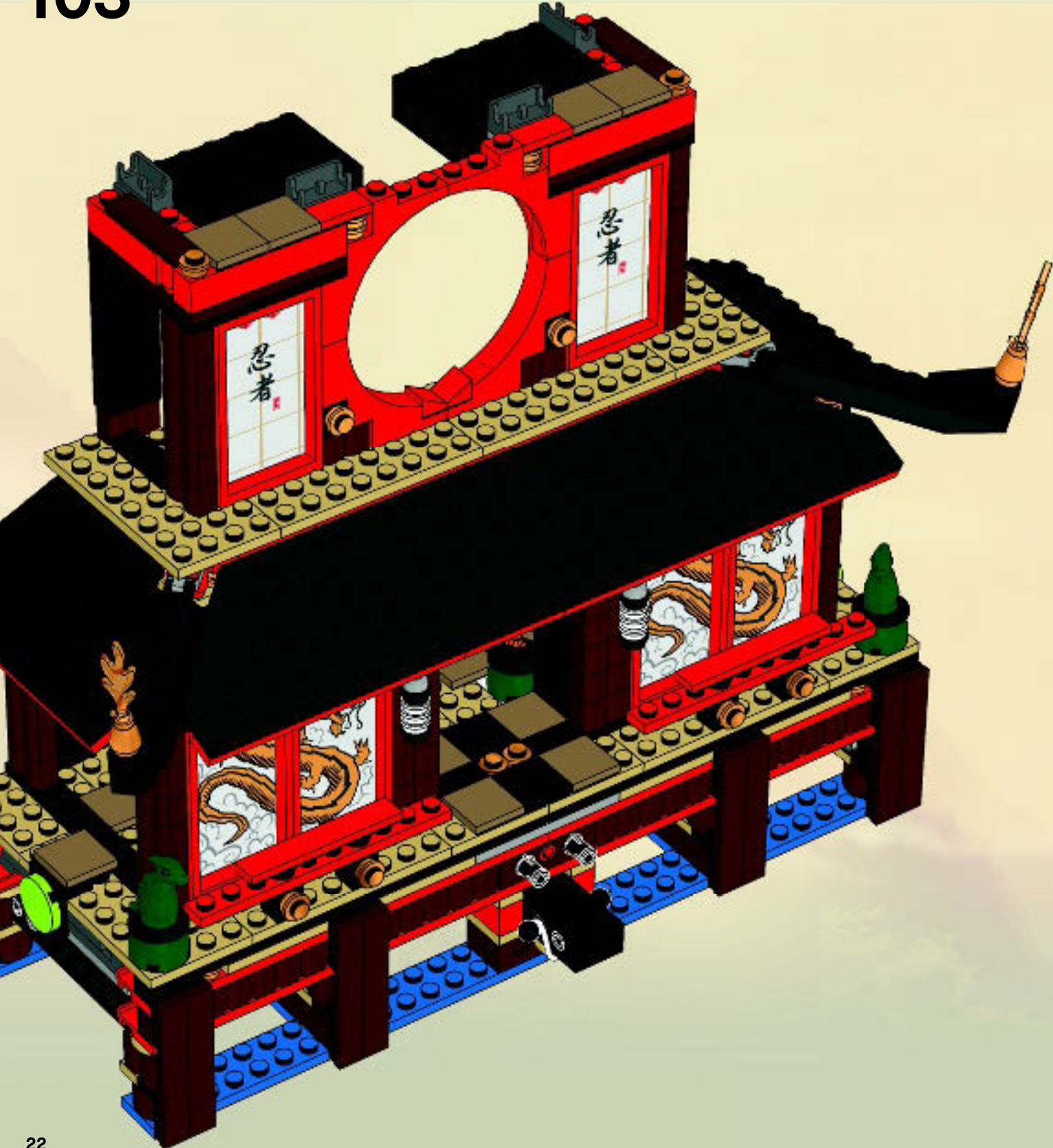



104

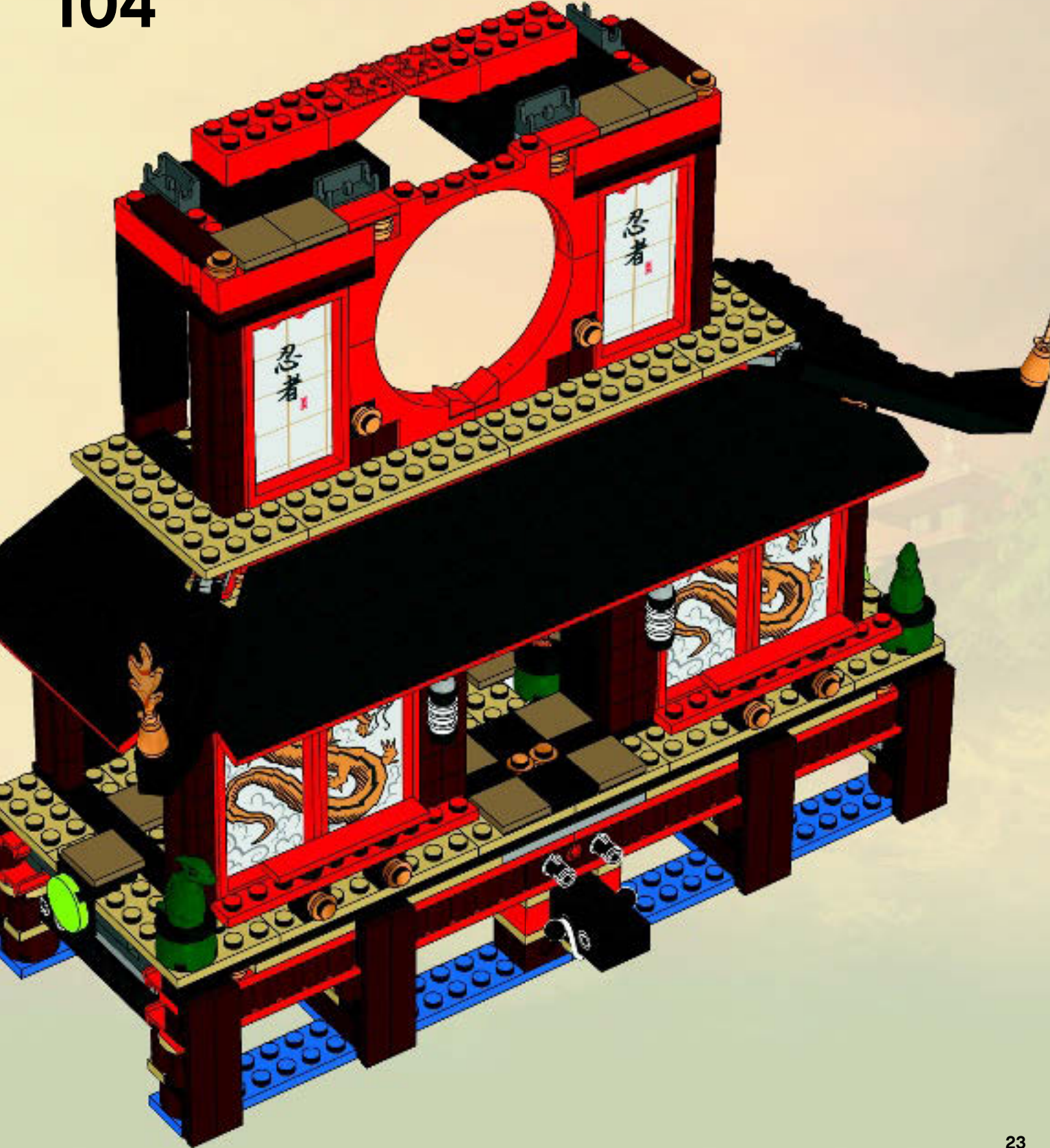

2x  2x 

105

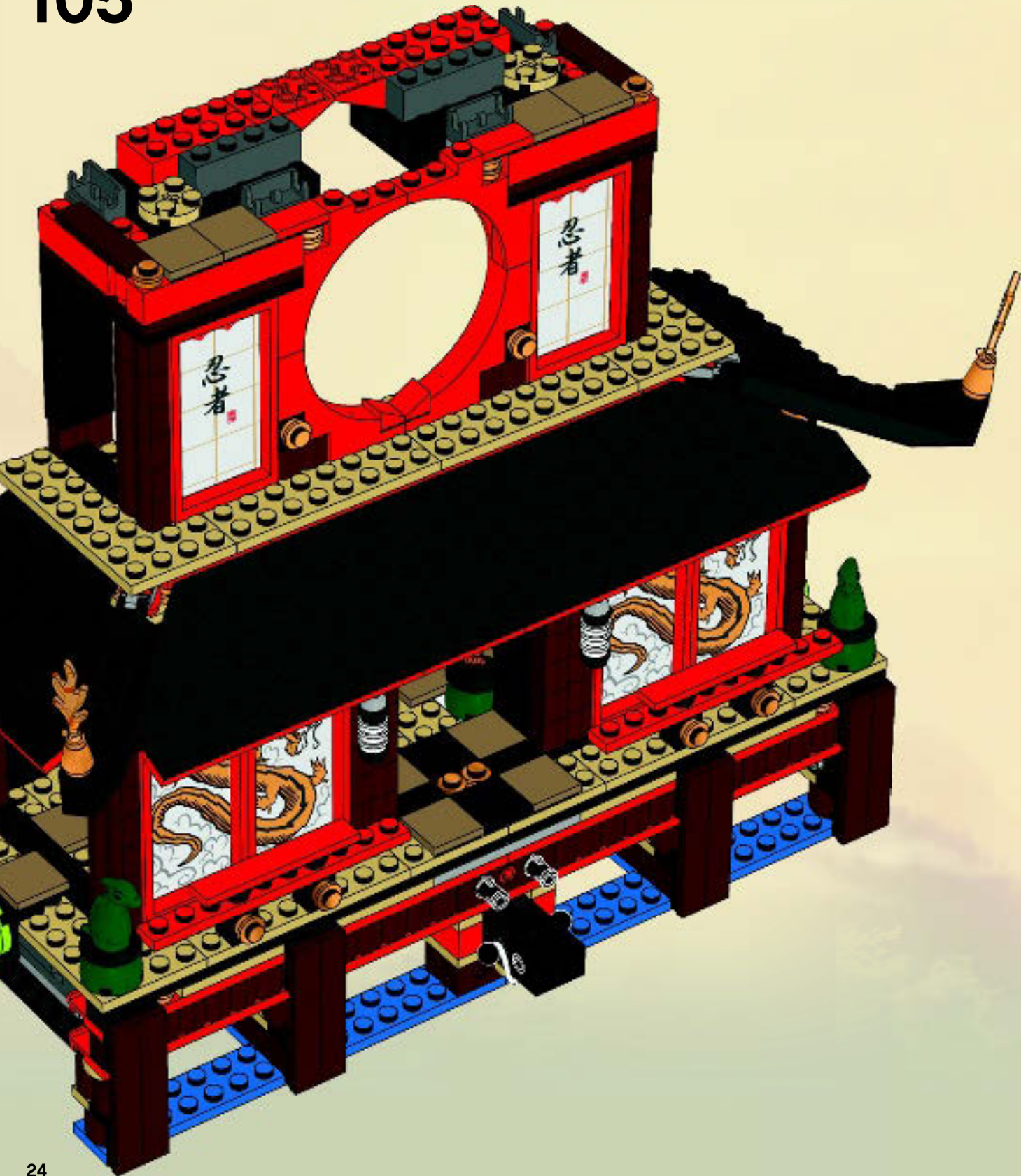



2x



2x

106

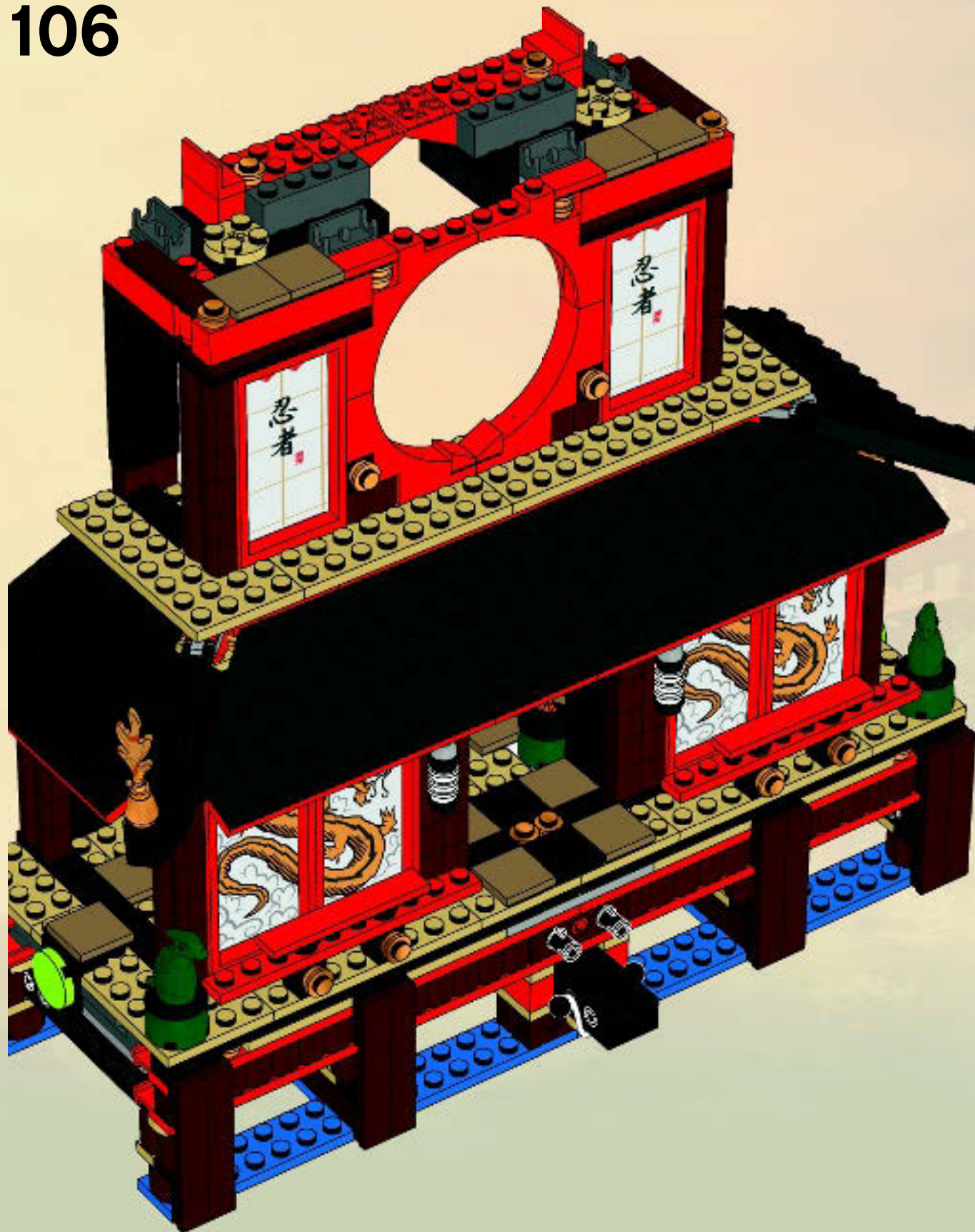

2x 2x

107

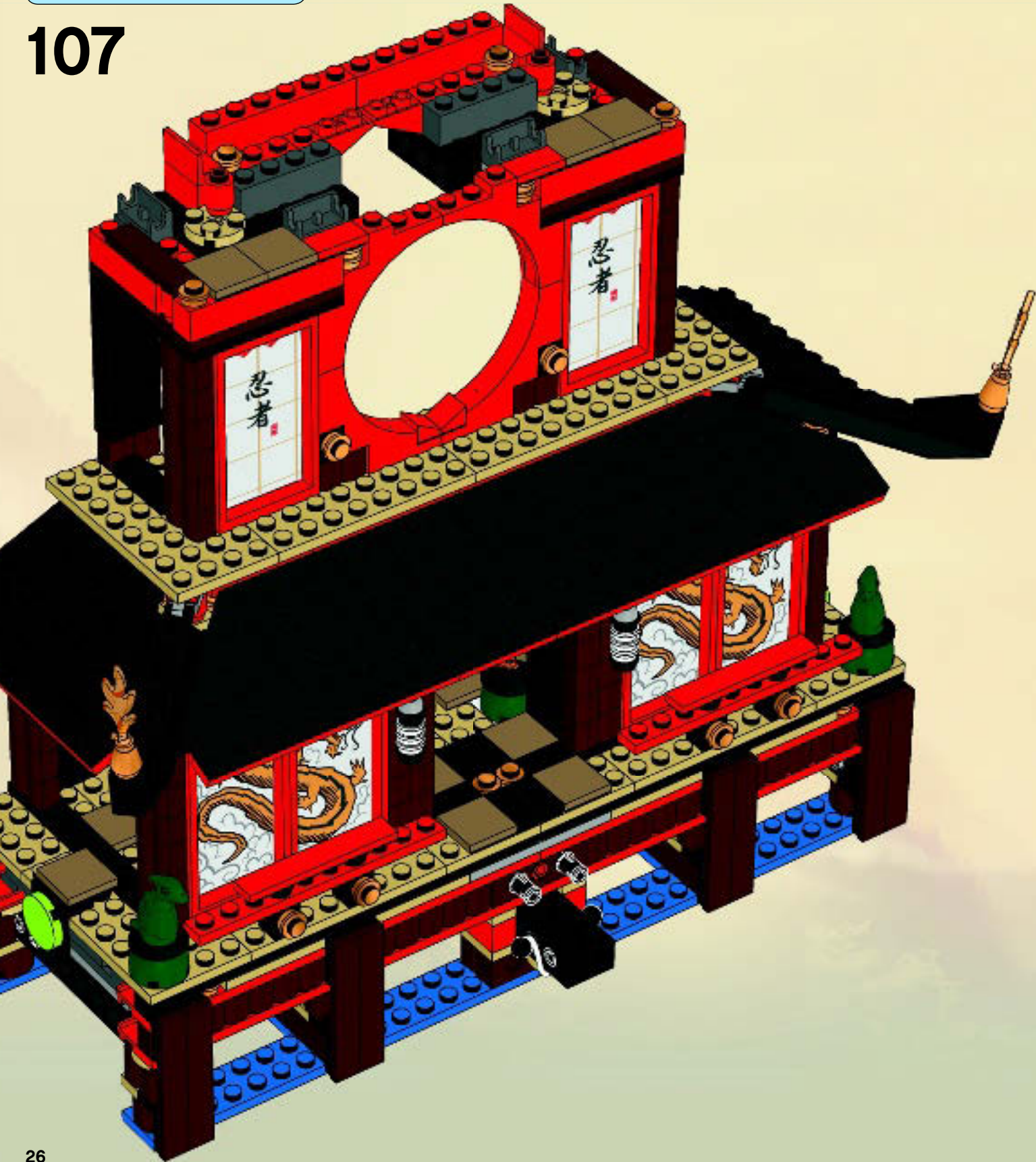



108

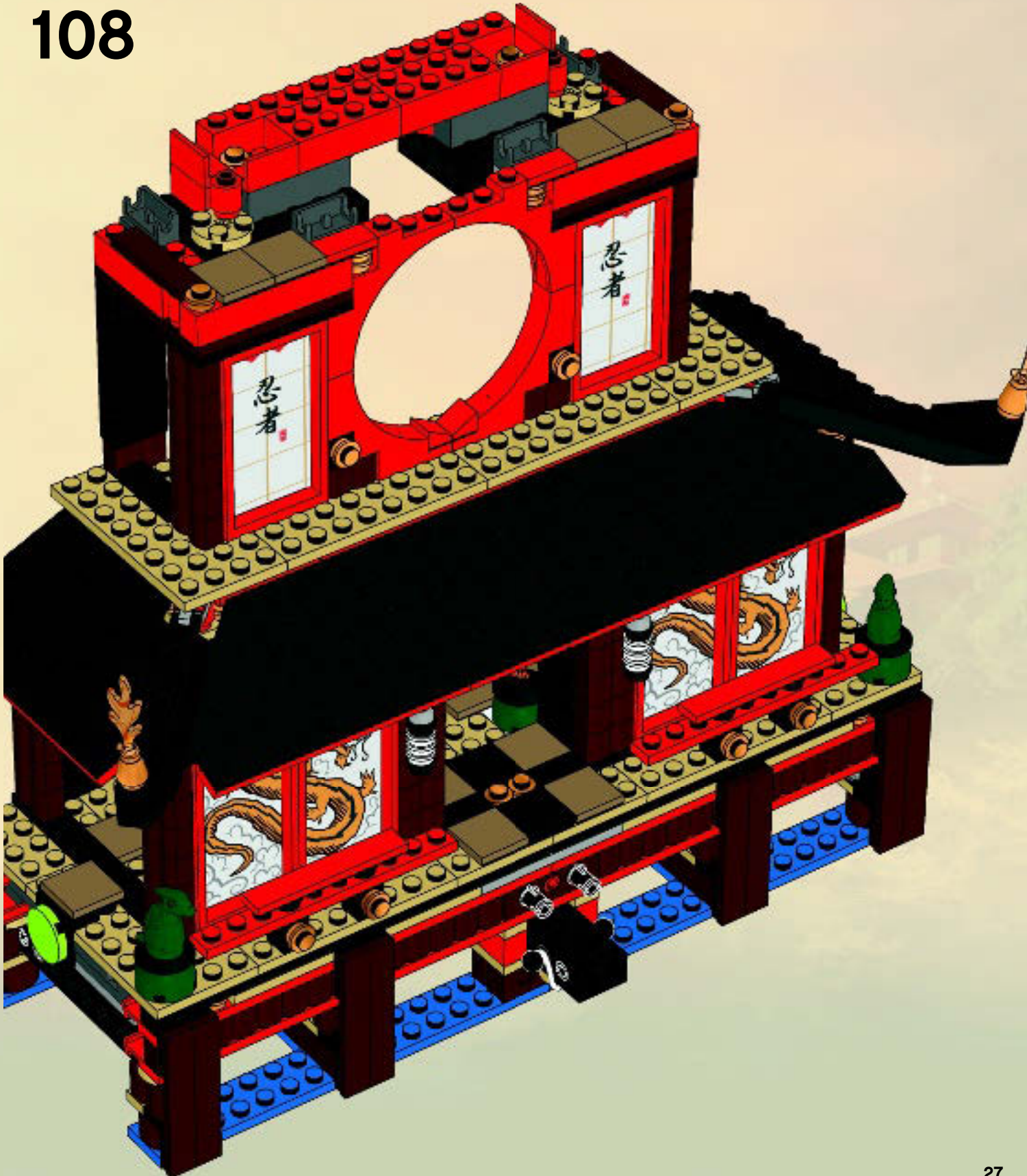

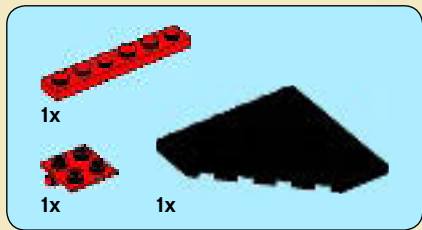

109

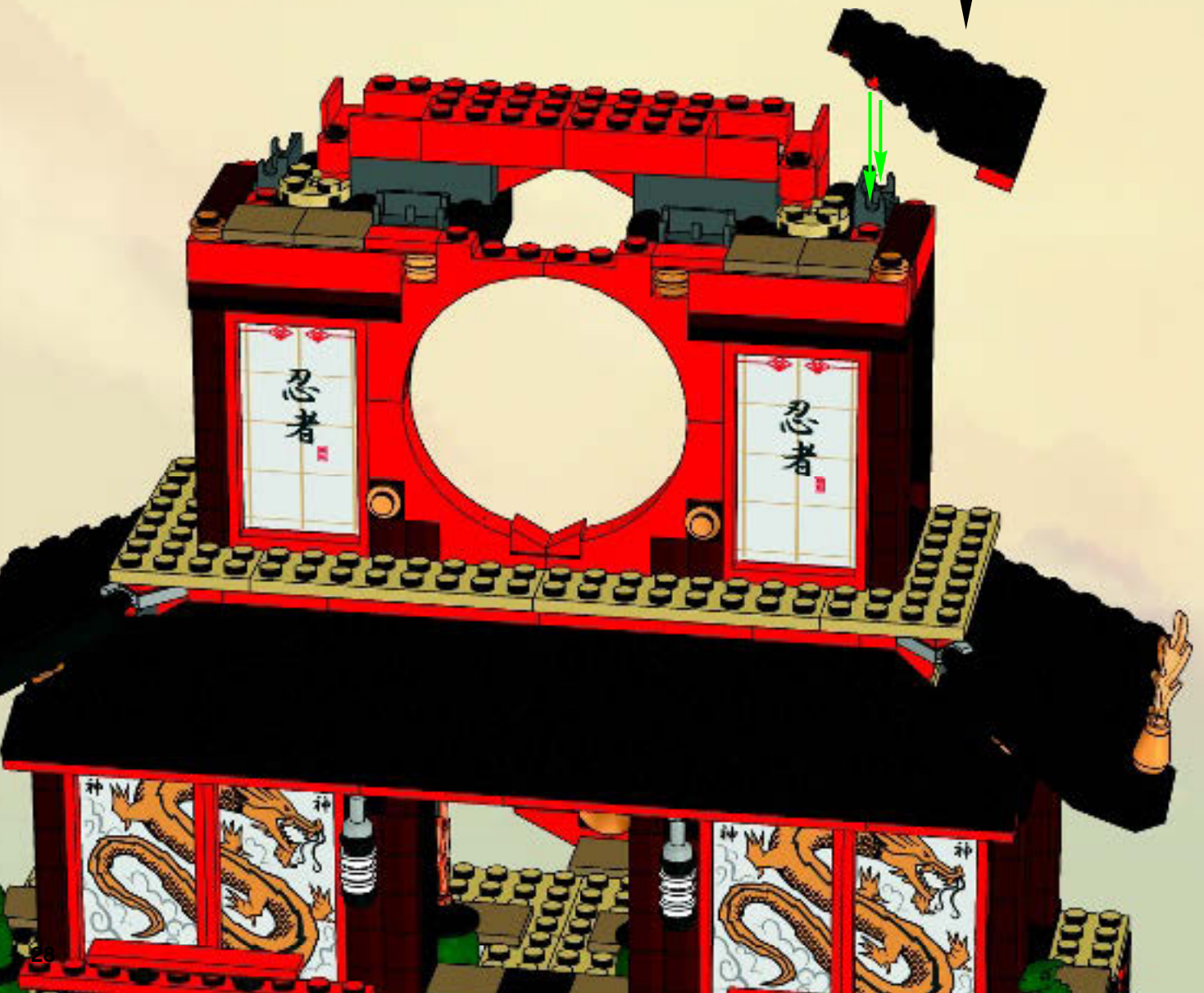
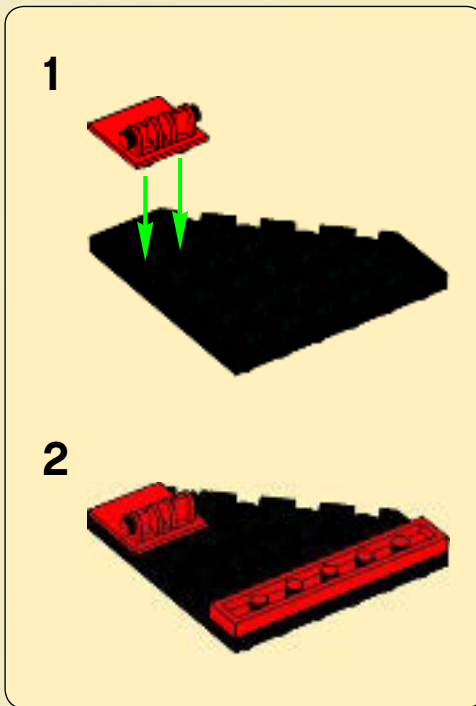

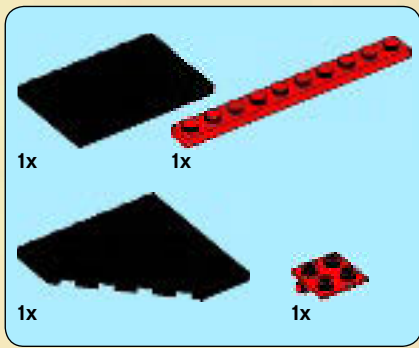

110

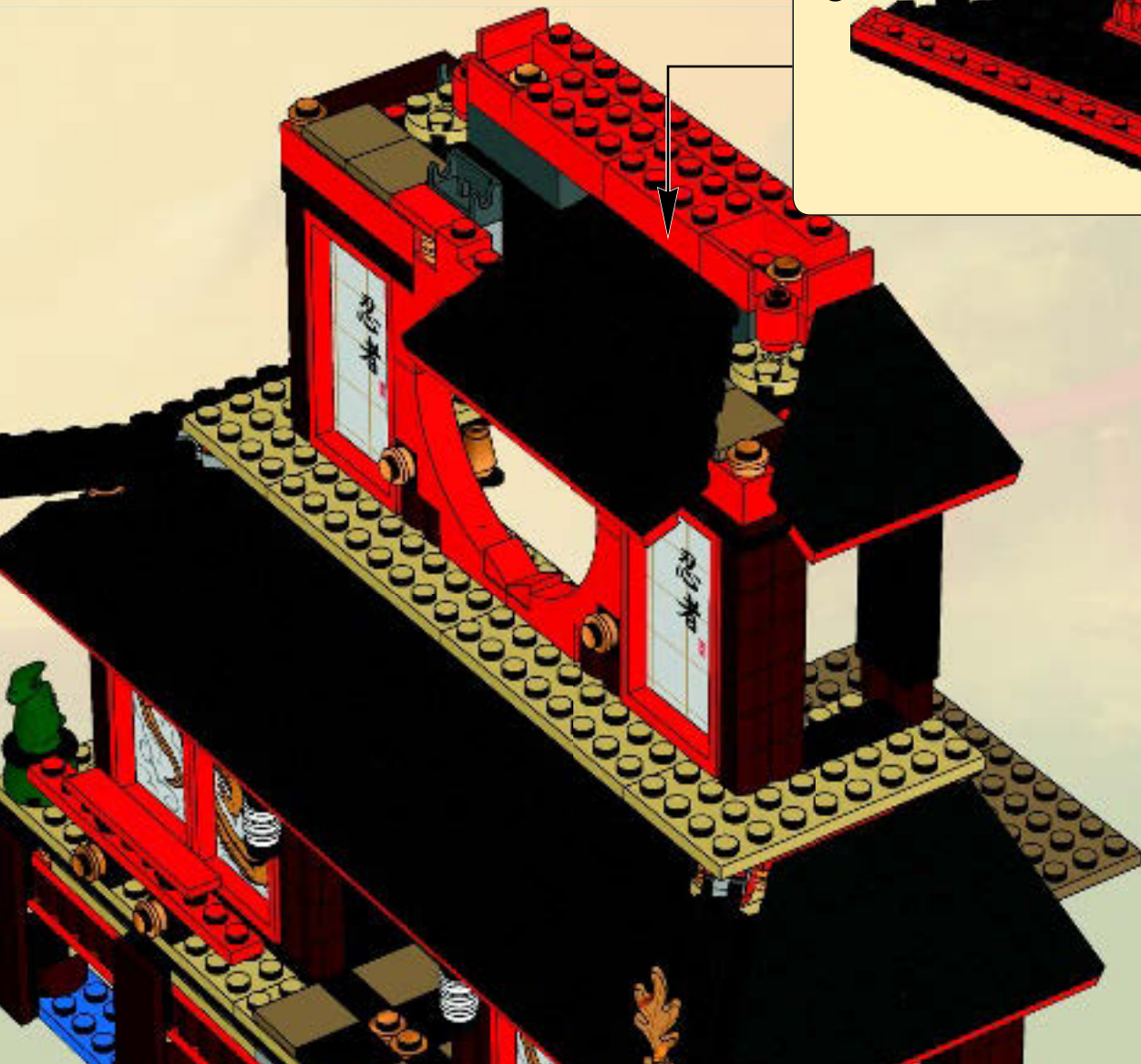
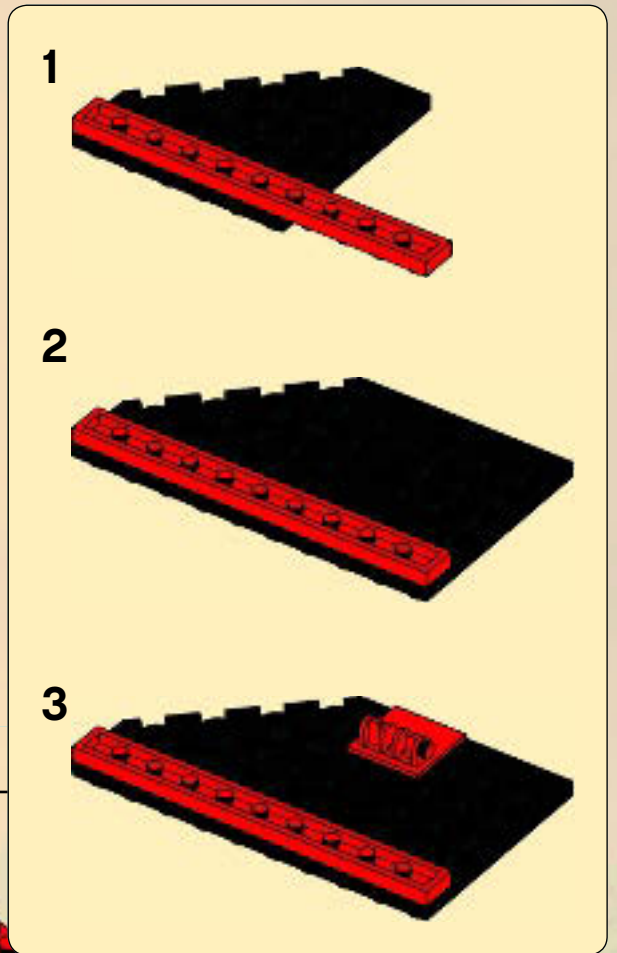

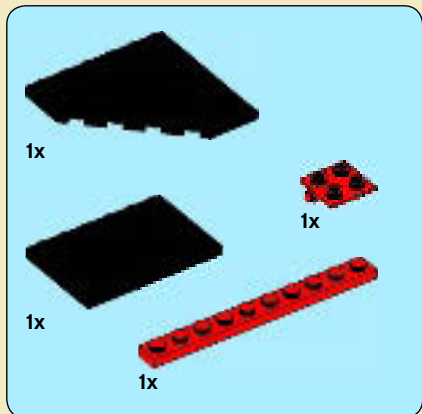

111

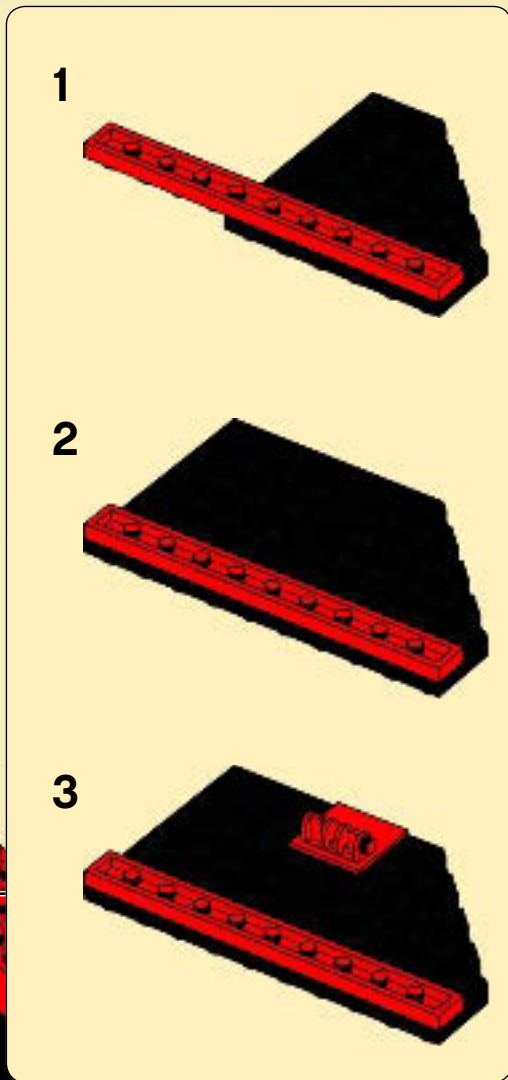

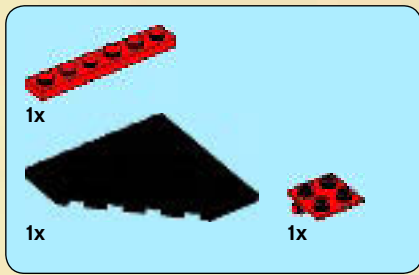

112

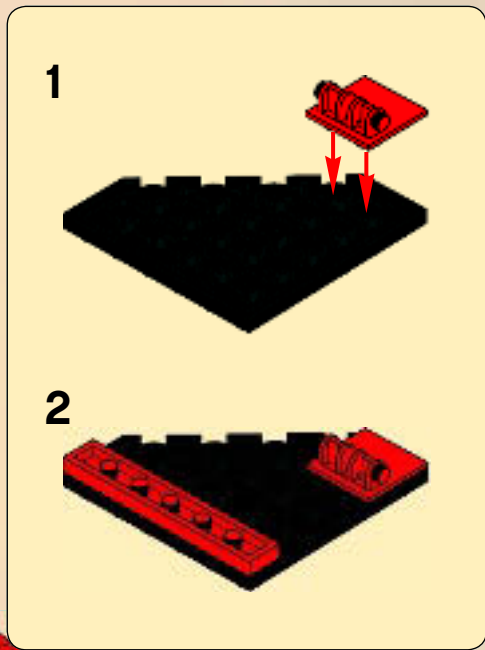

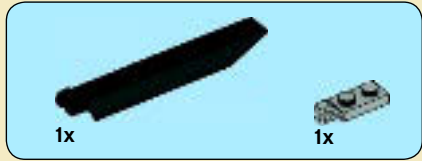

1

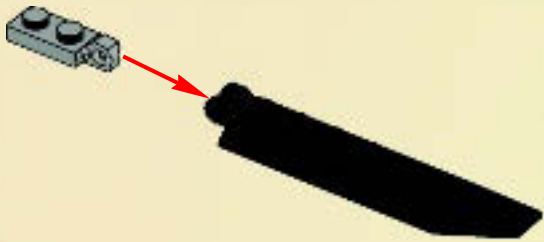

2

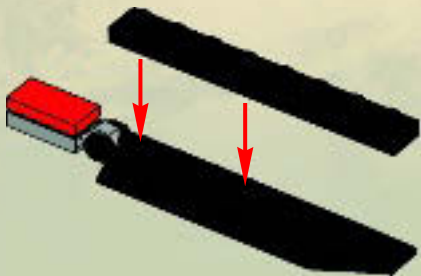

3

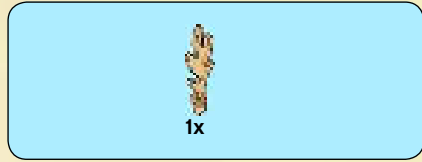

4



2x

113

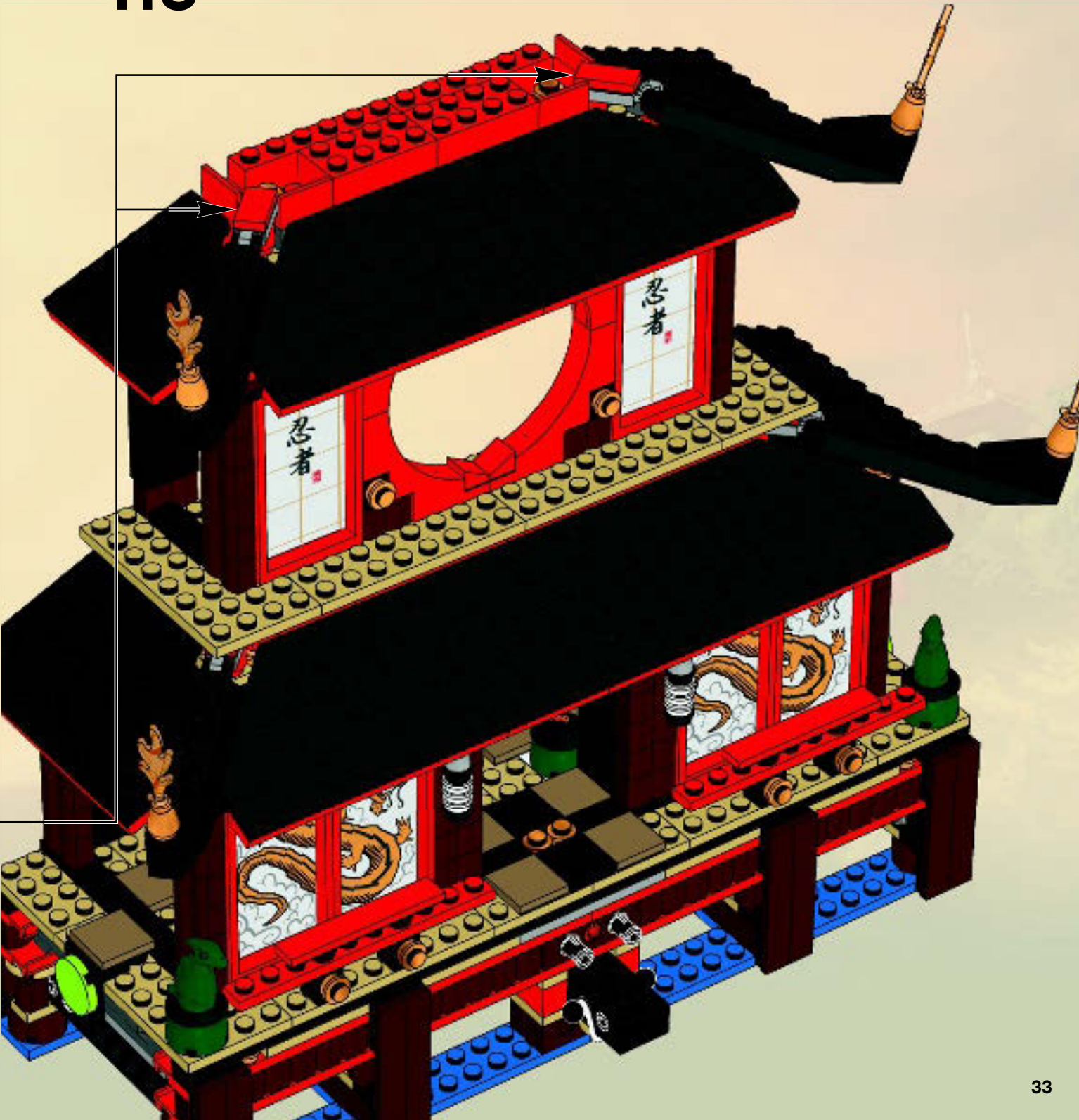

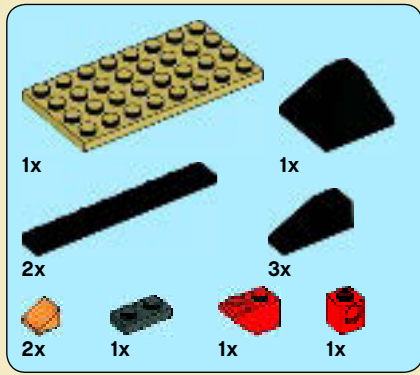

114

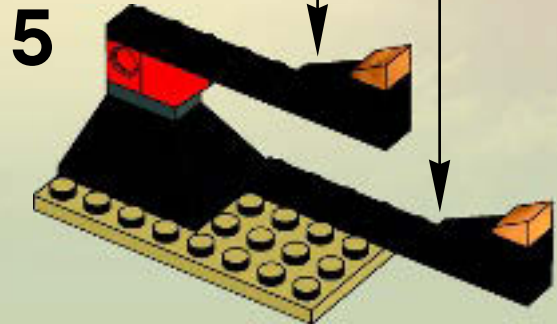
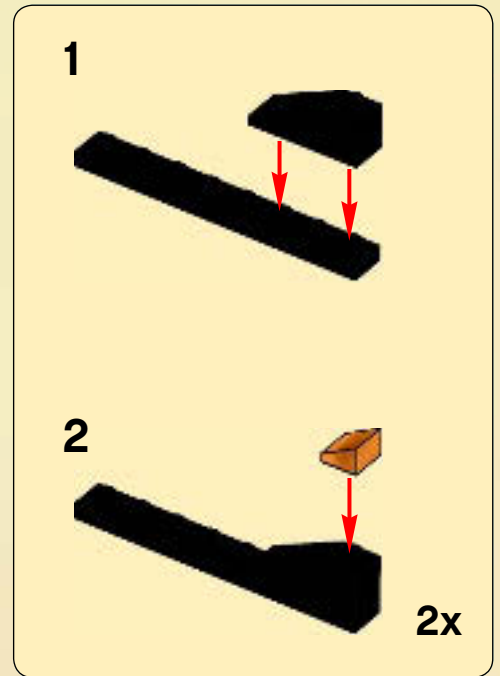
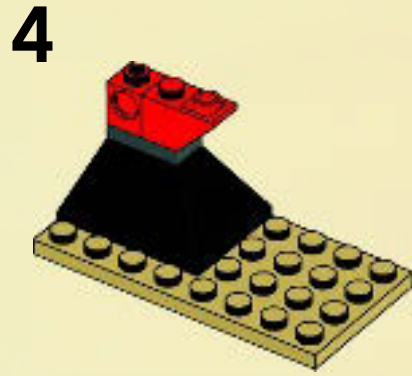
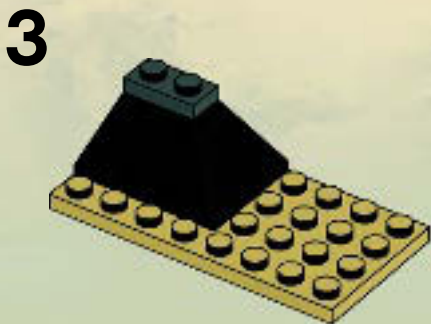
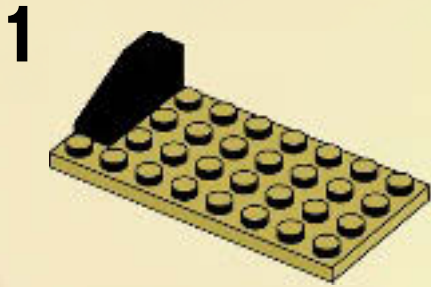

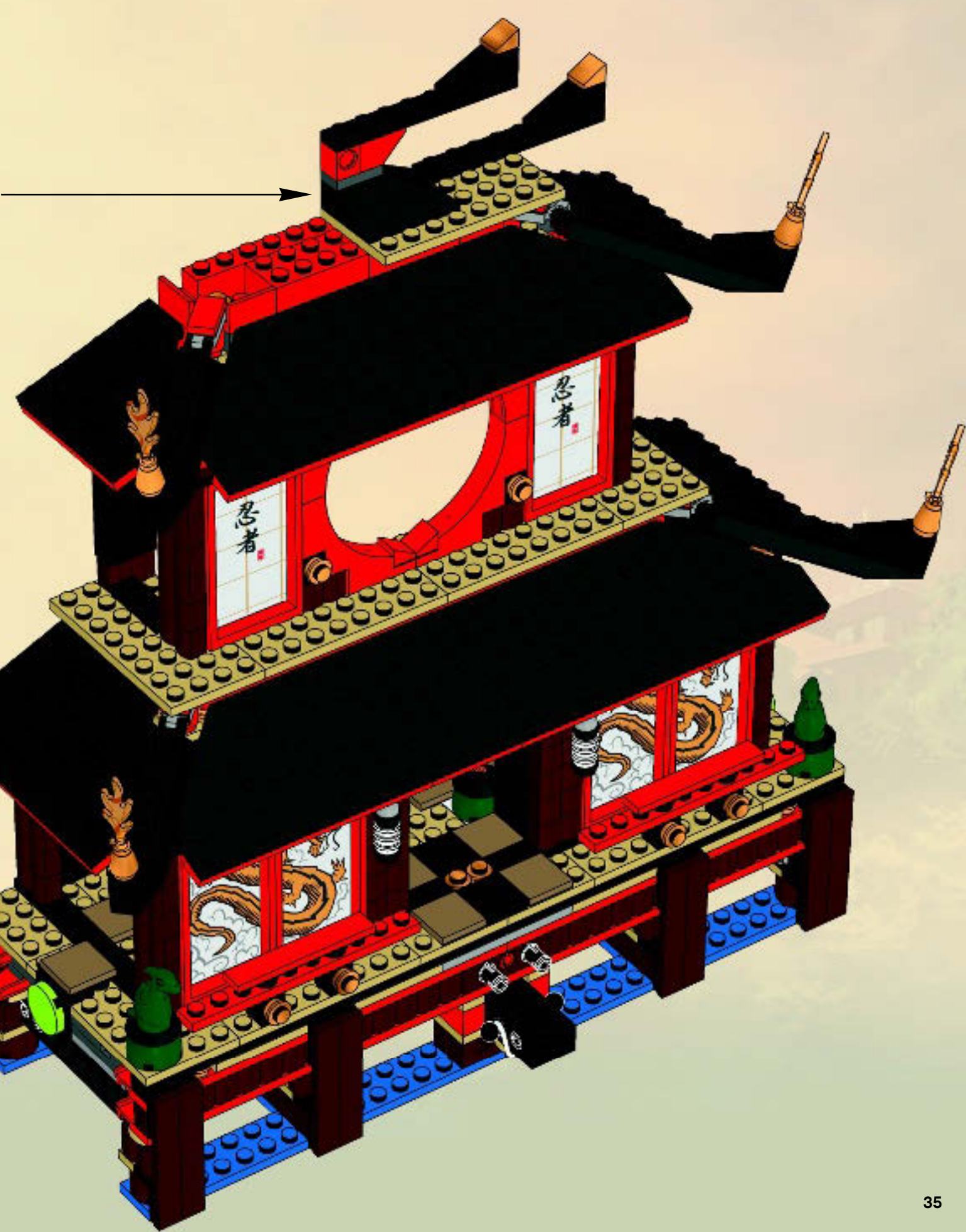

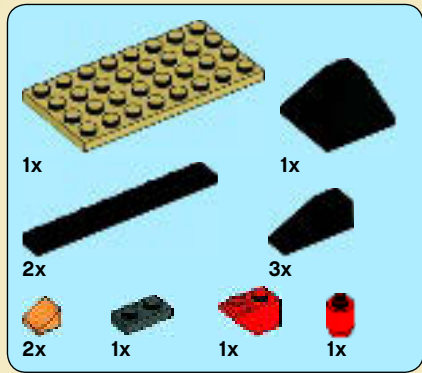

115

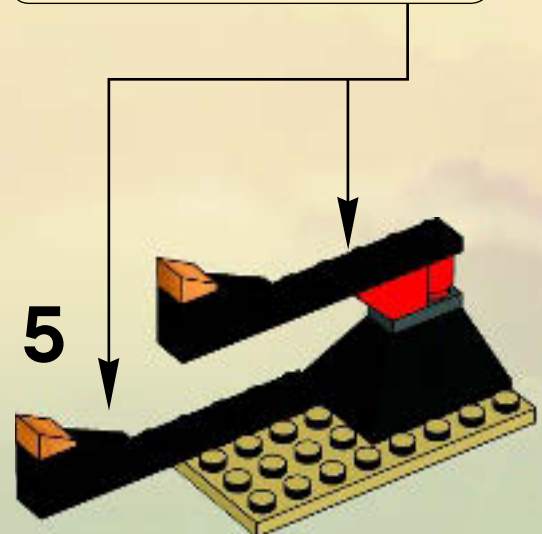
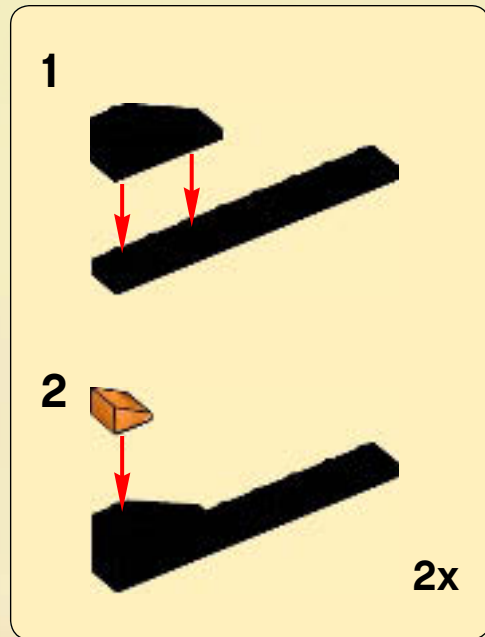
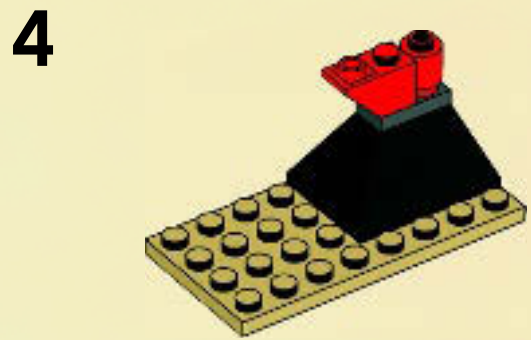
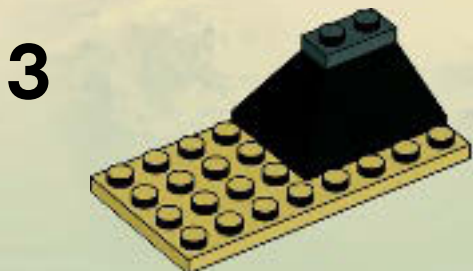



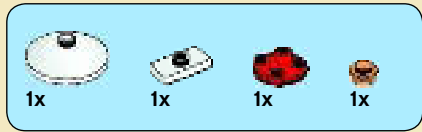

116

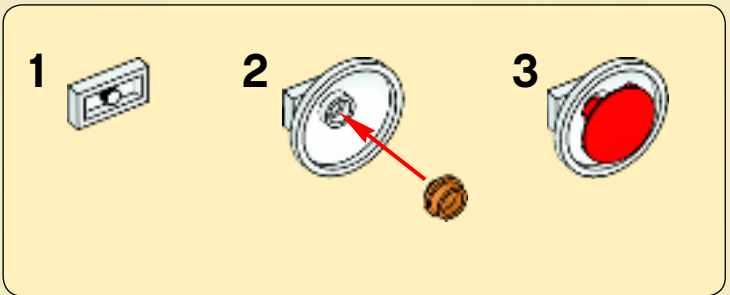

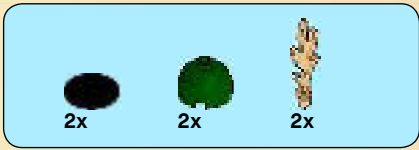

117

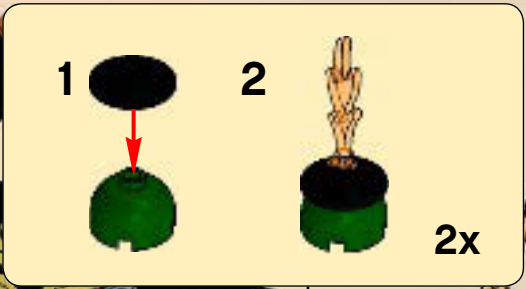

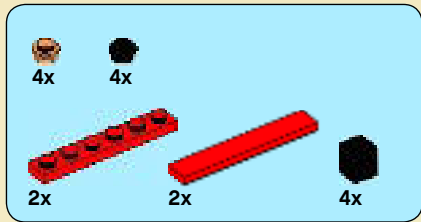

118

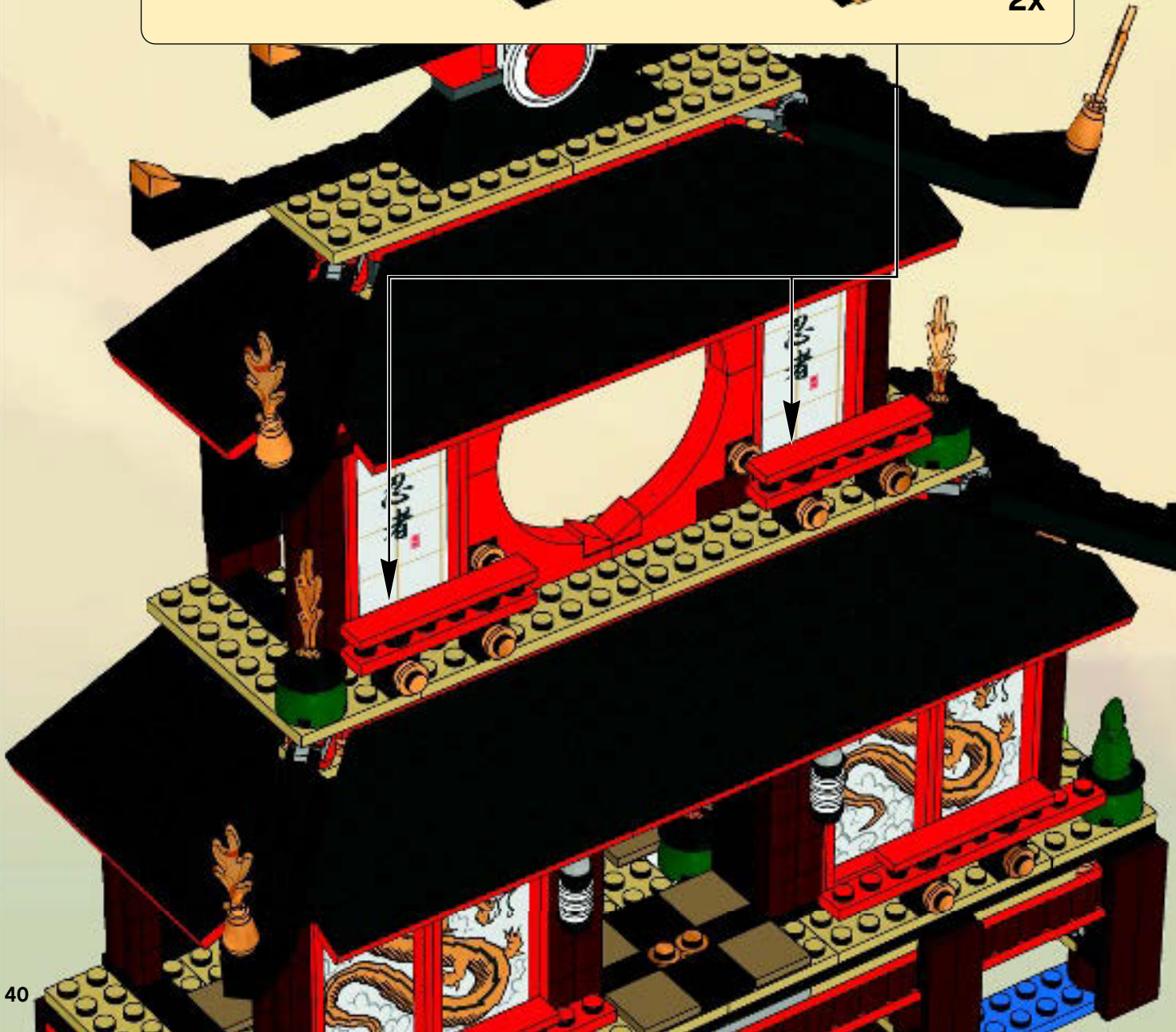
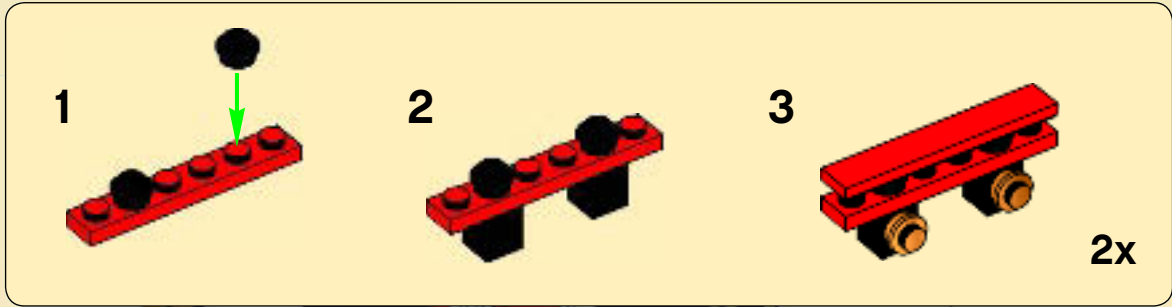

7



1x

1



1x

2

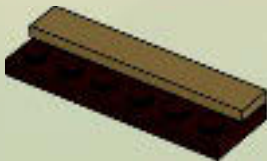

1x

3



1x

4

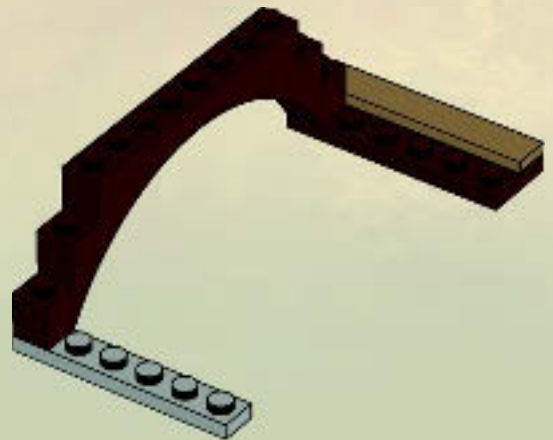

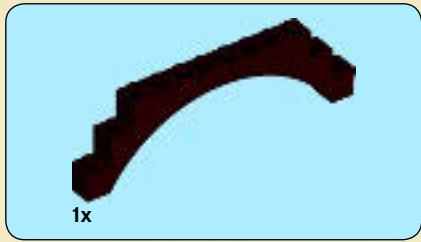

5

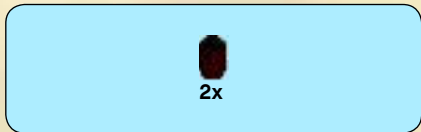
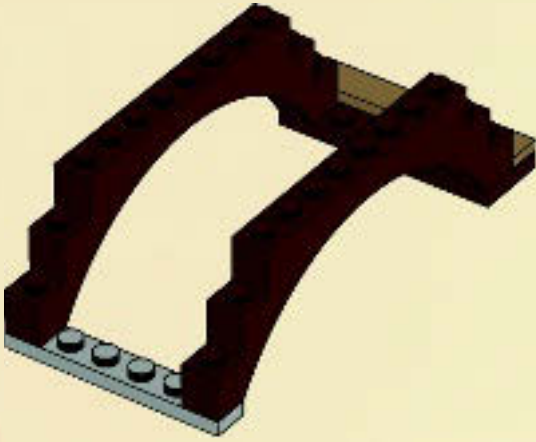

6

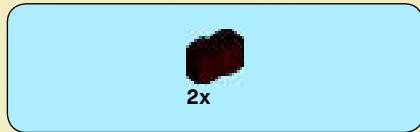
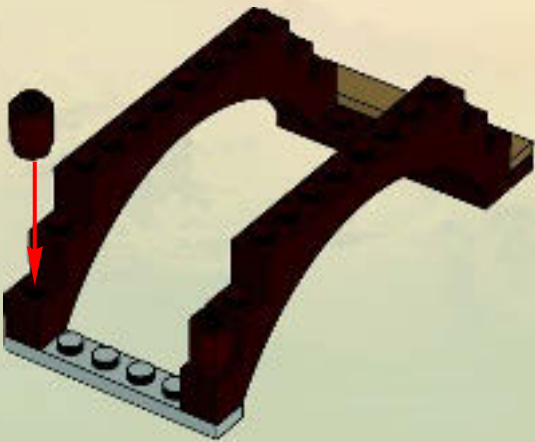

7

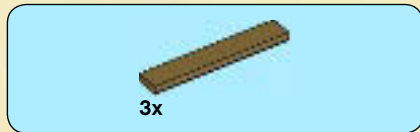
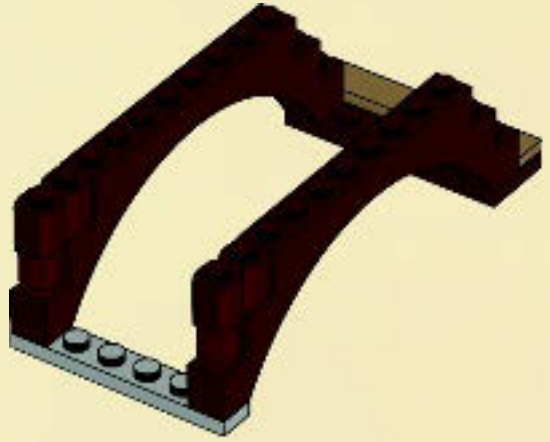

8

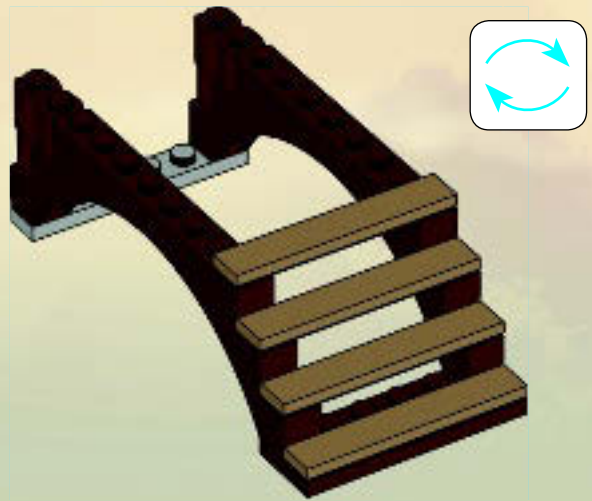

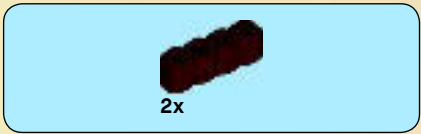

9

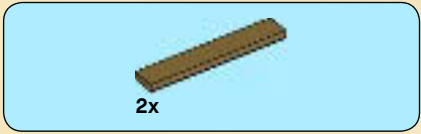
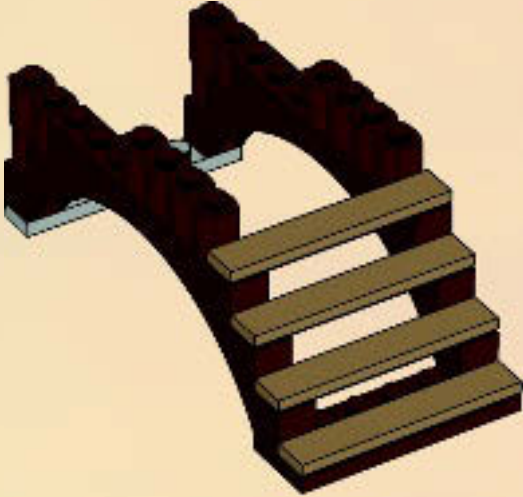

10

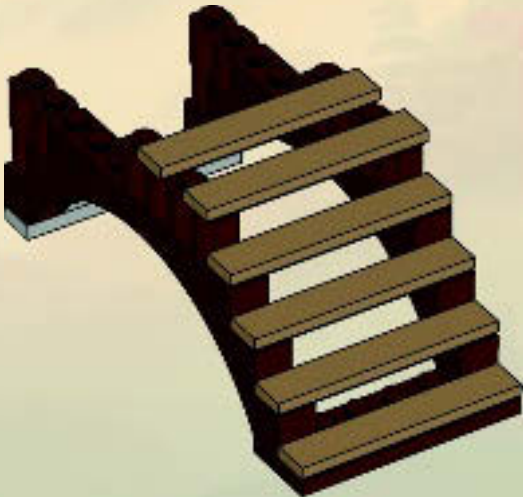

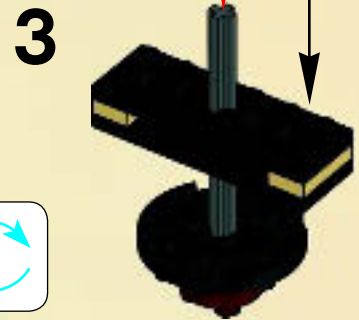
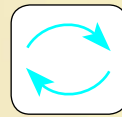
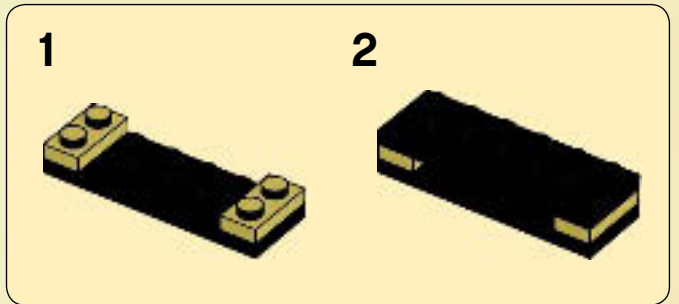
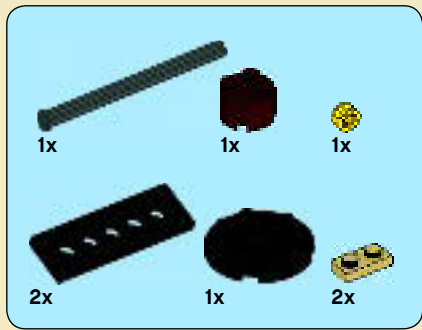

11

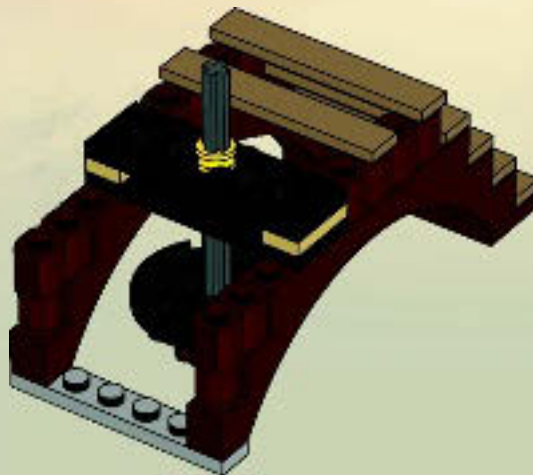
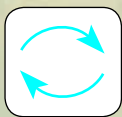

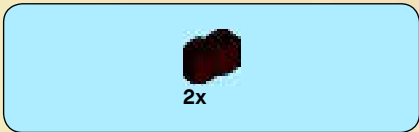

12

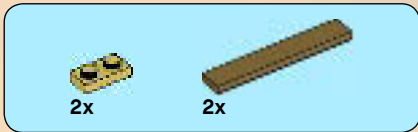
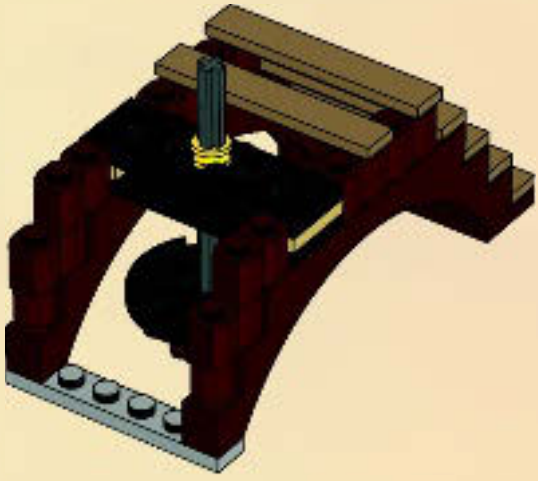

14

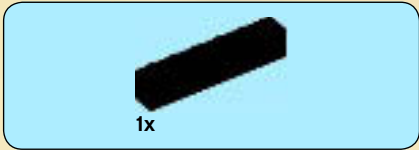
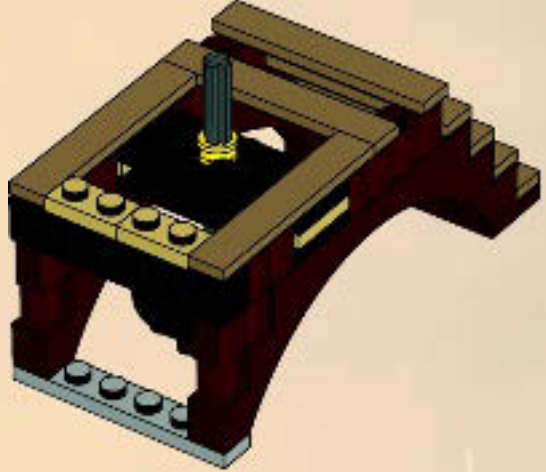

13

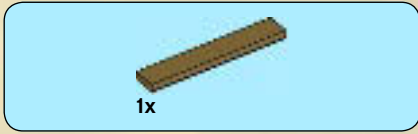
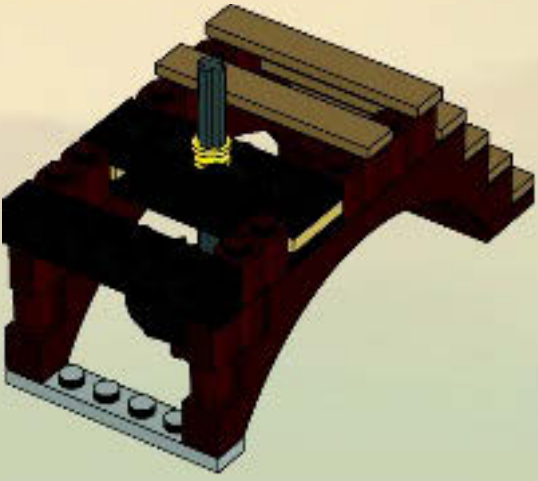

15

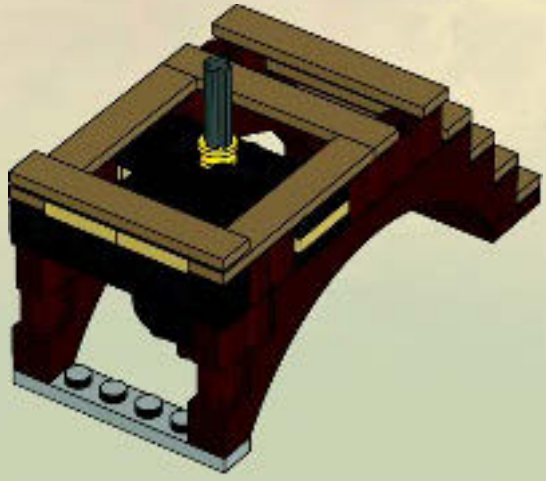

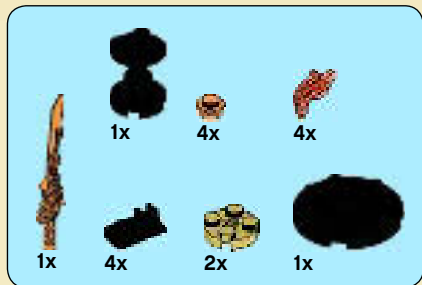

16

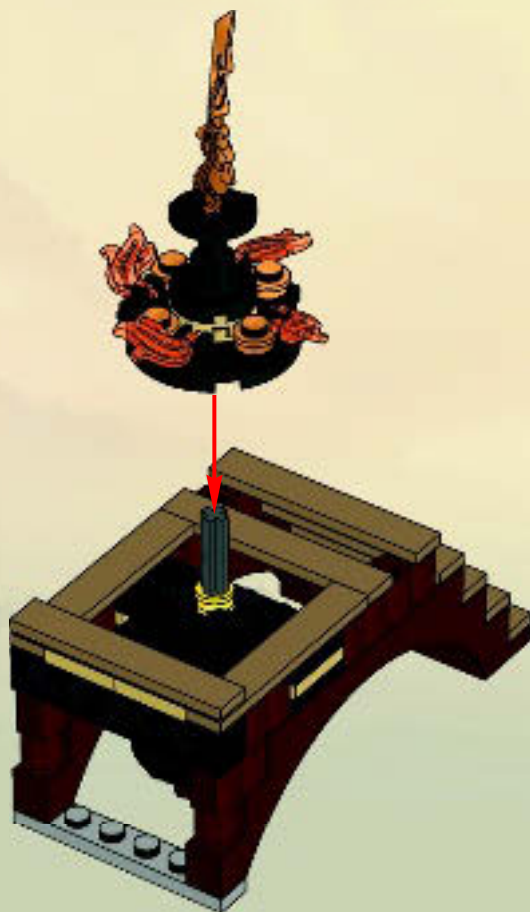
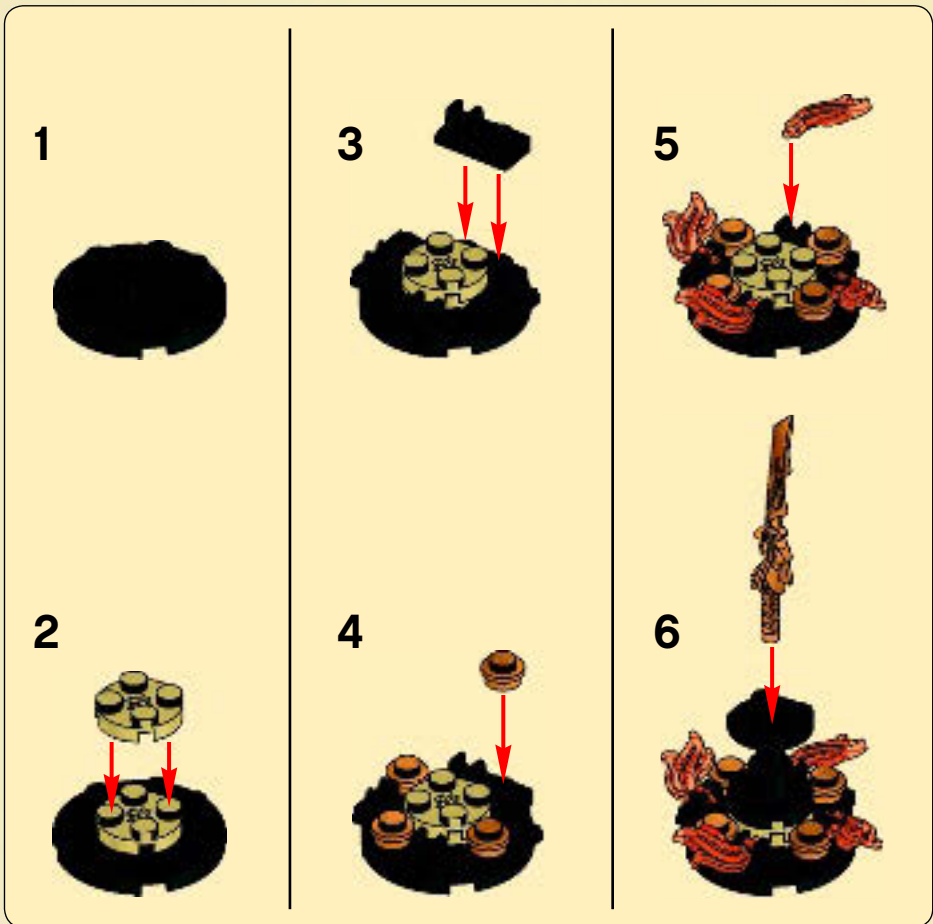



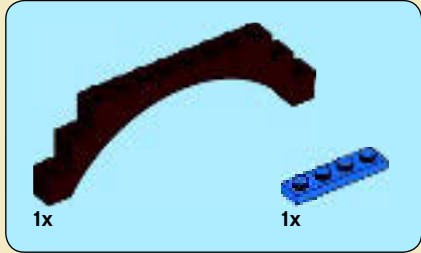

1



2

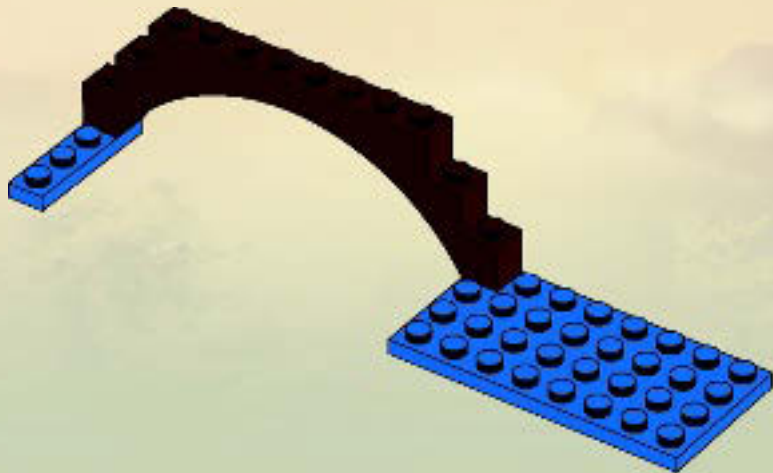

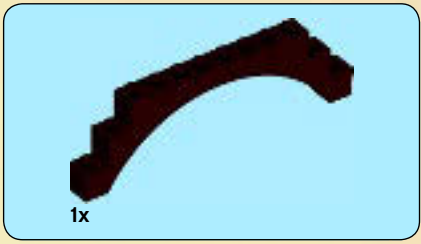

3

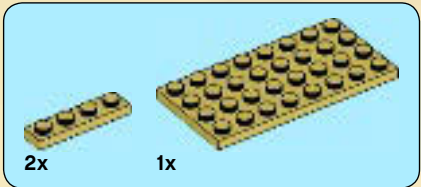
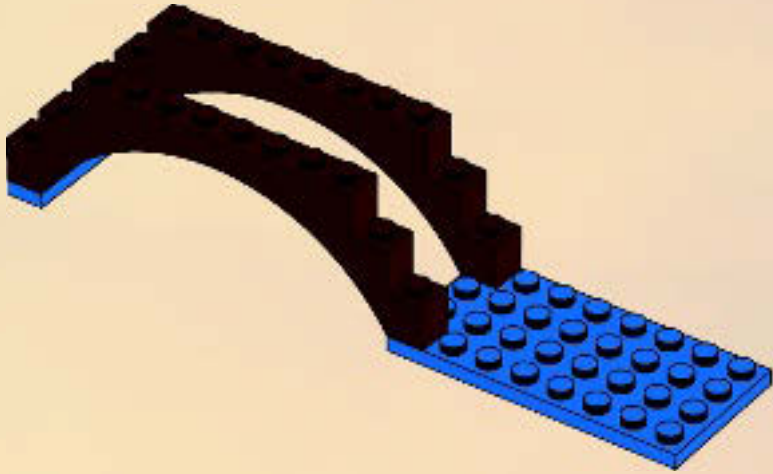

4

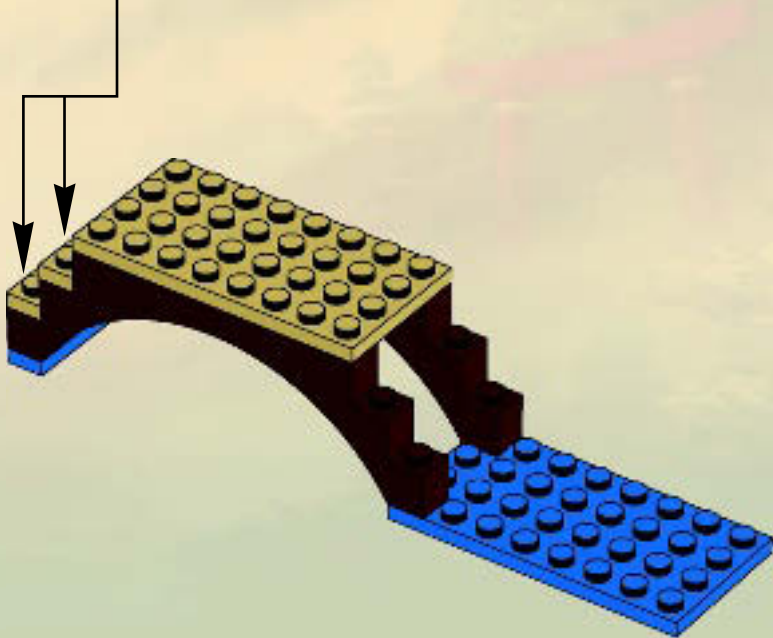
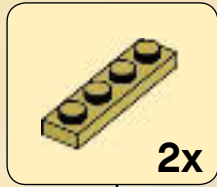



5

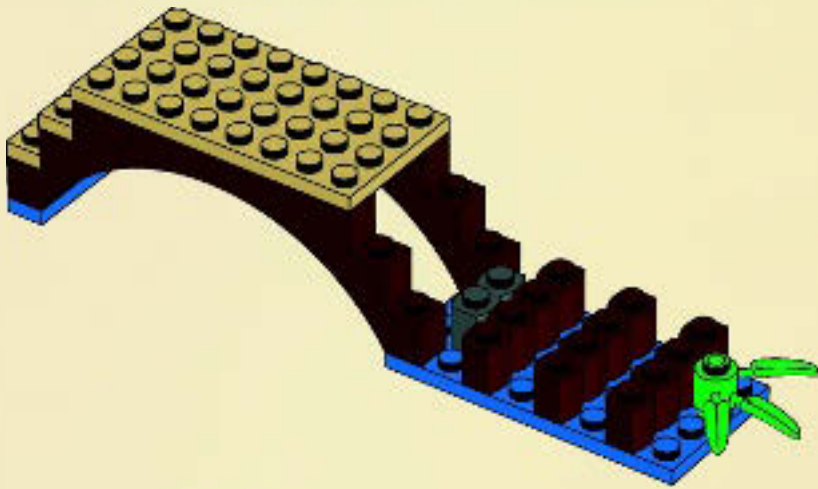

6

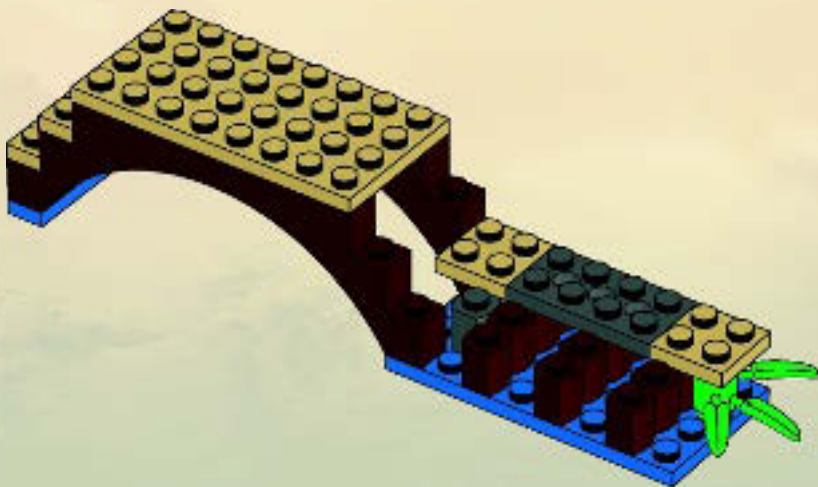

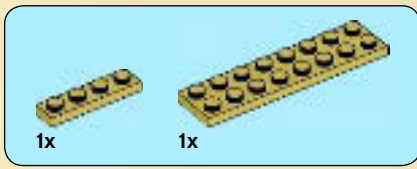

7

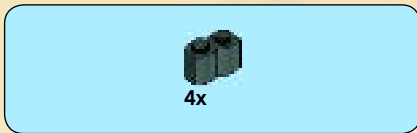
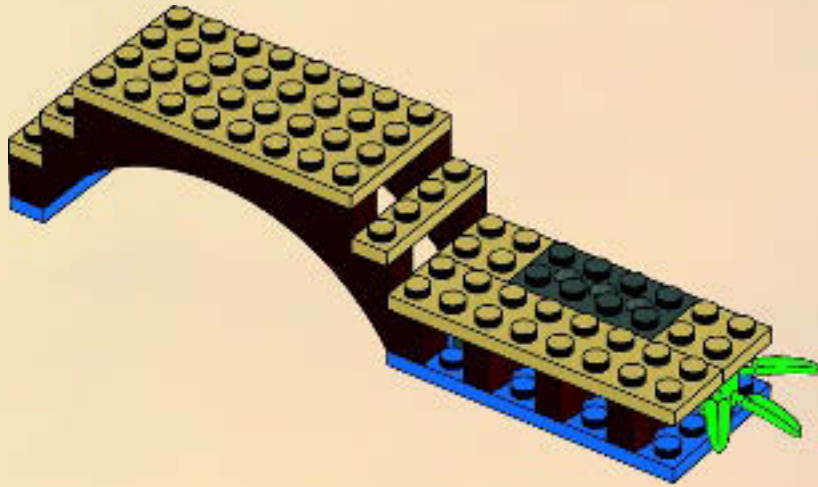

8

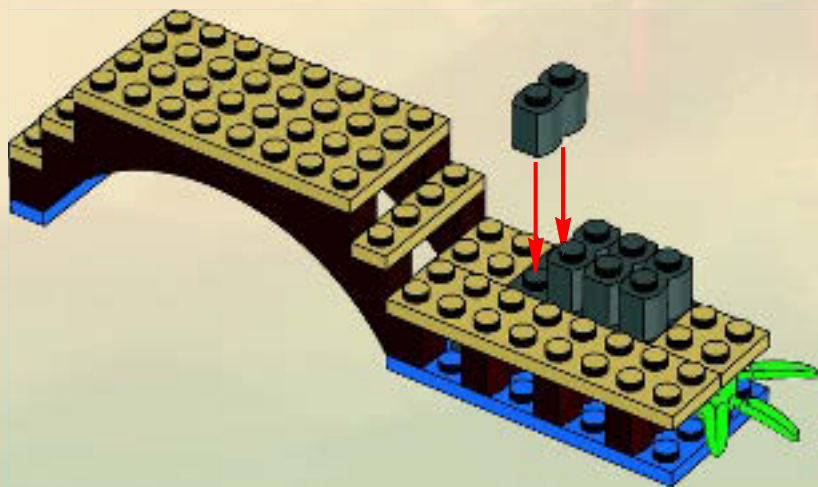

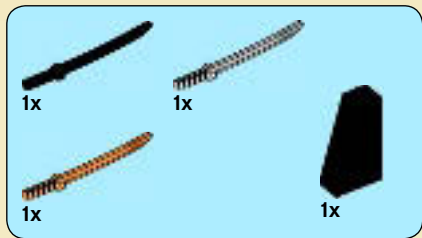

9

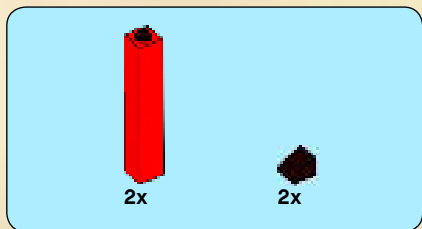
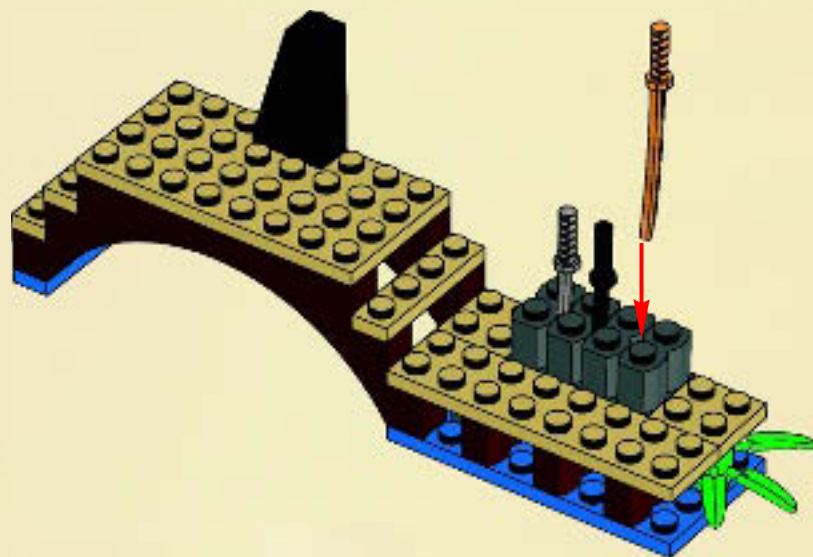

10

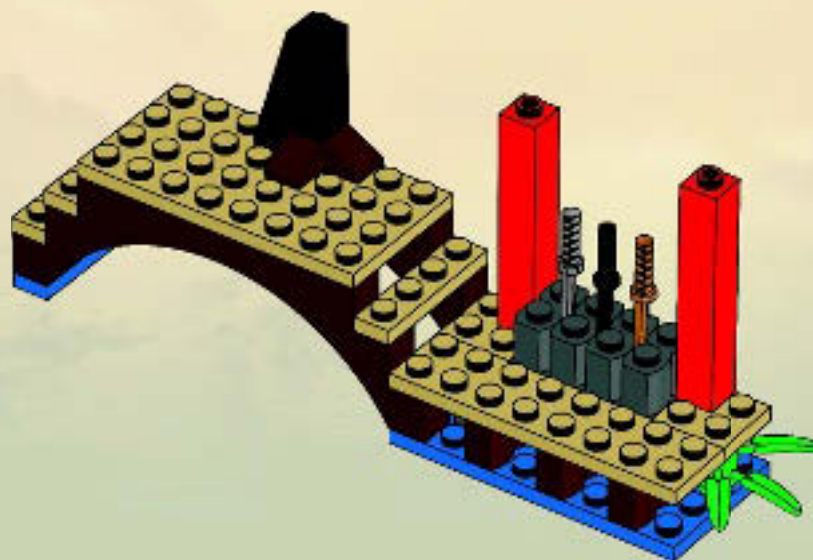

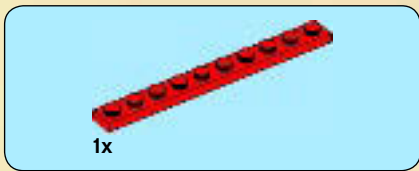

11

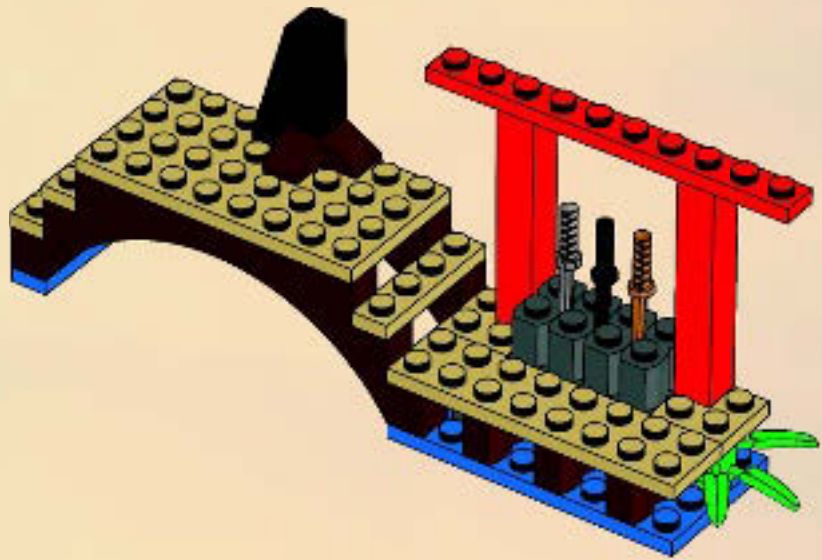

12

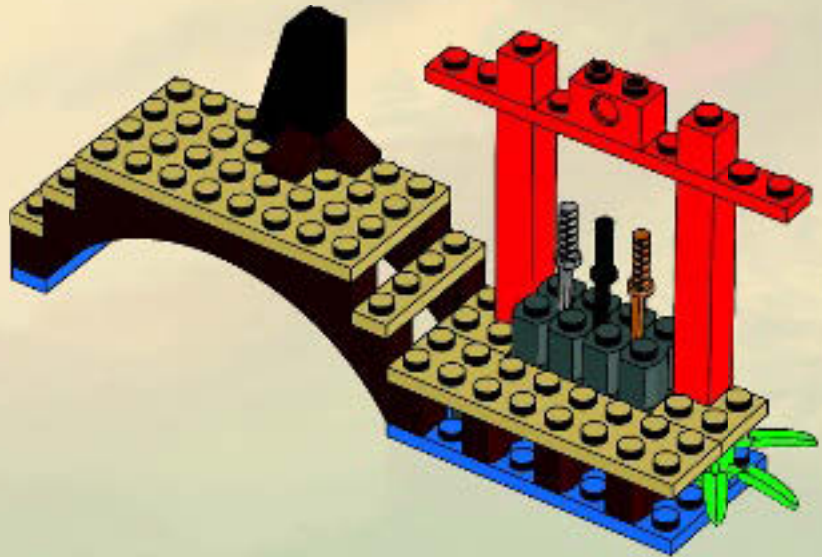



13

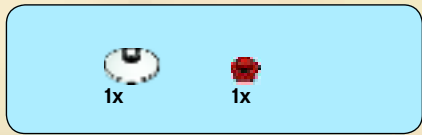
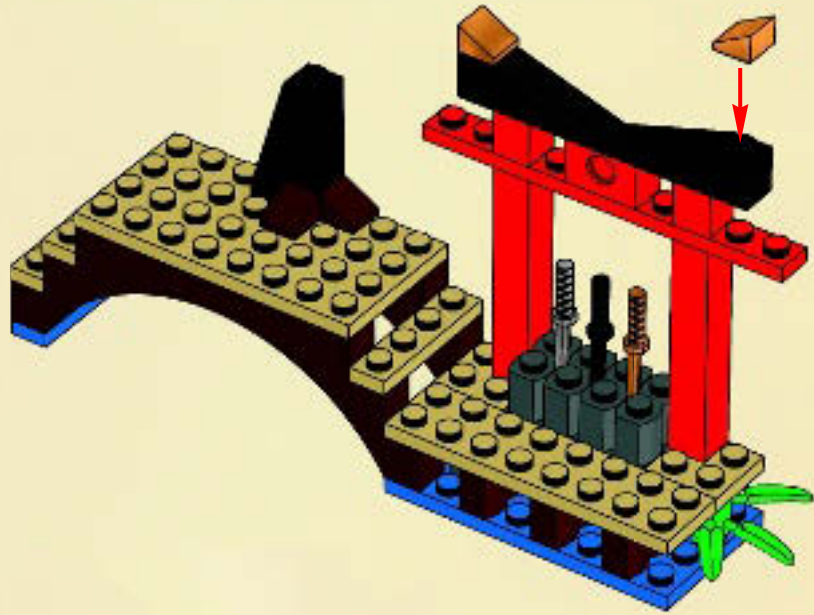

14

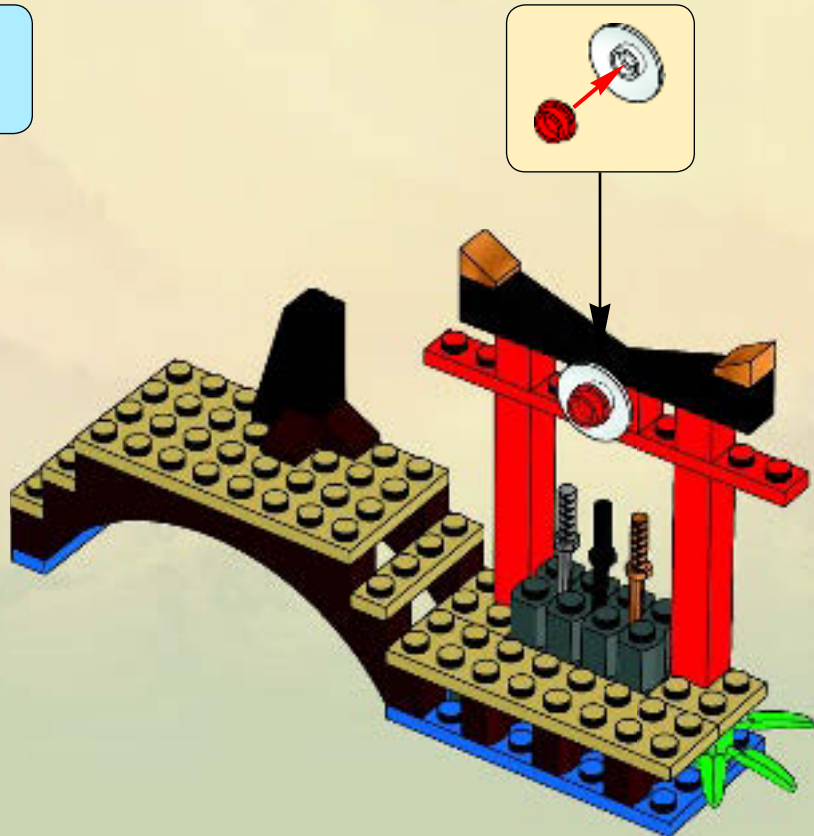

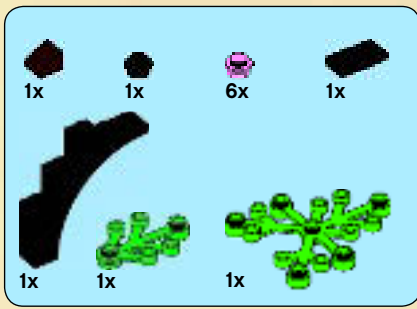

1



2

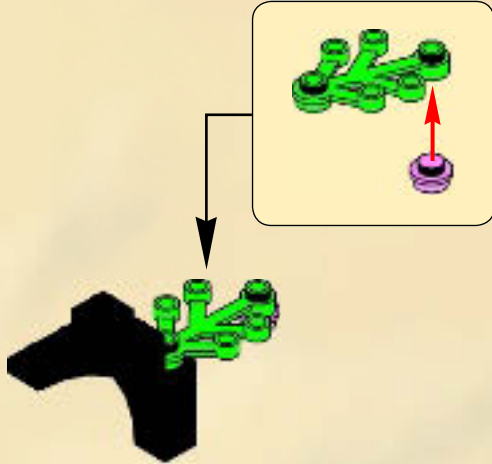

3

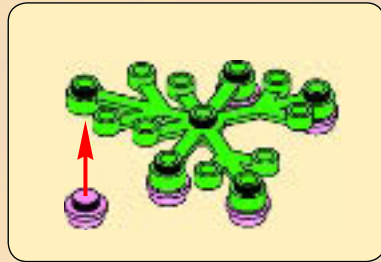

4

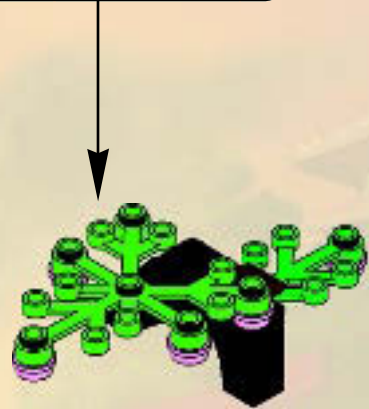

5



15

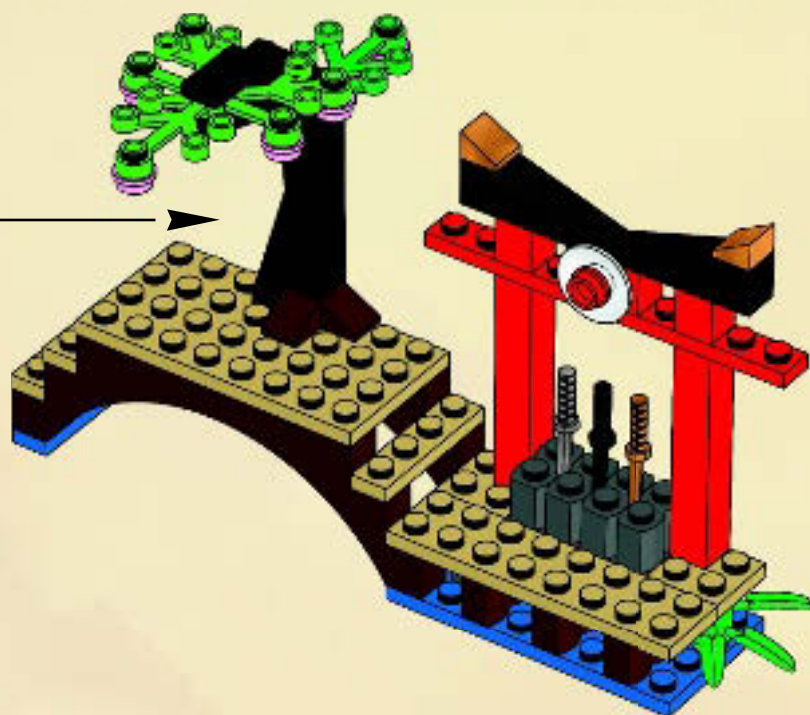

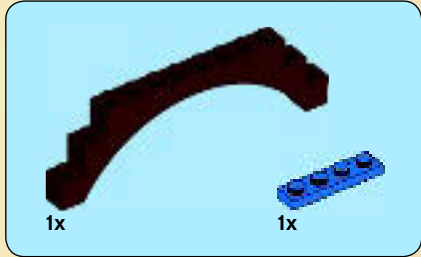
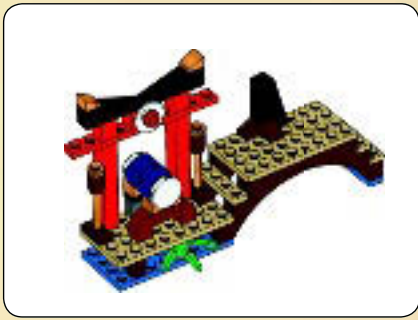

1

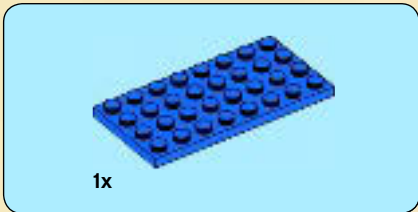

2

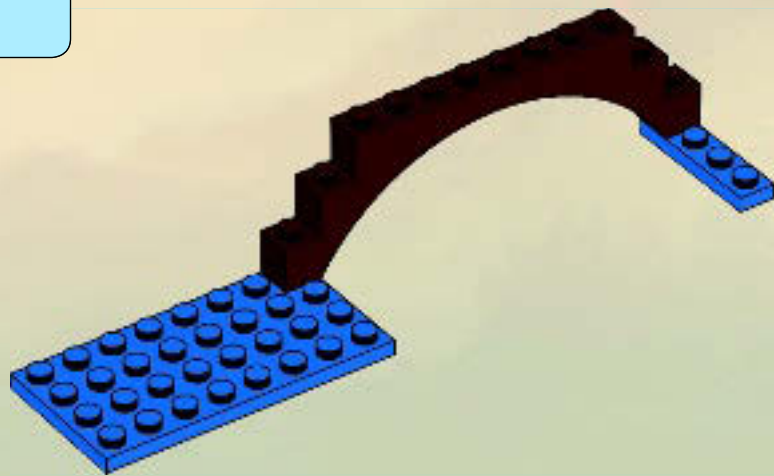

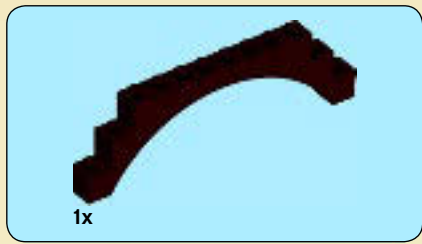

3

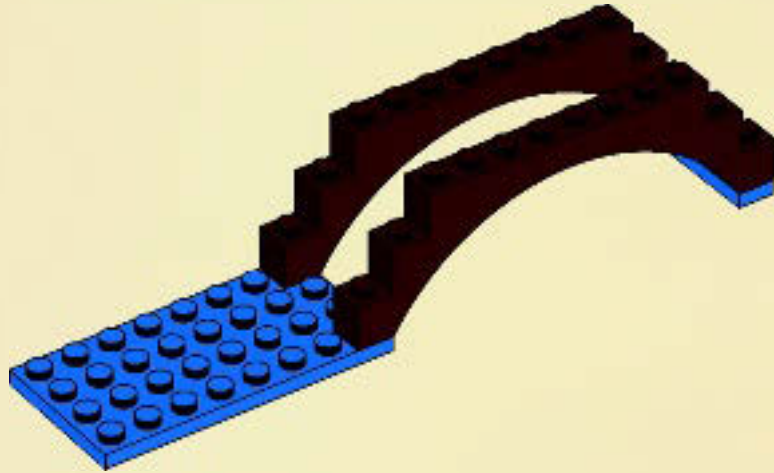

4

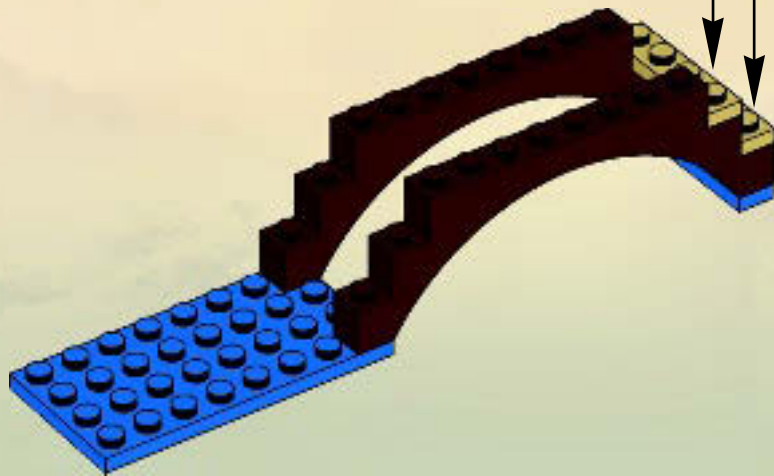
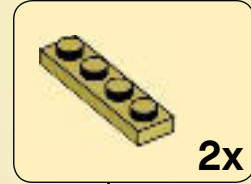

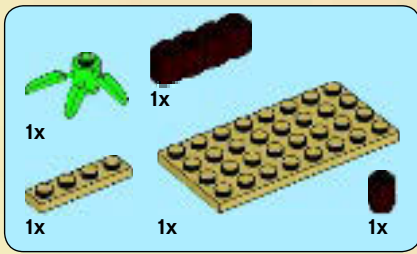

5

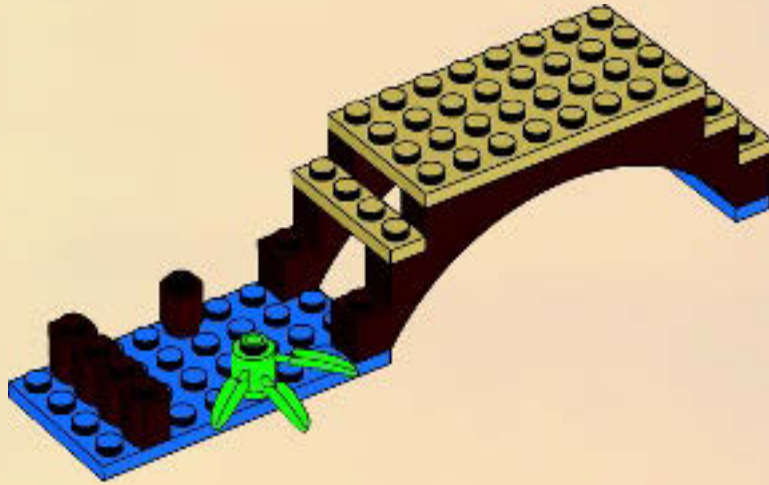

6

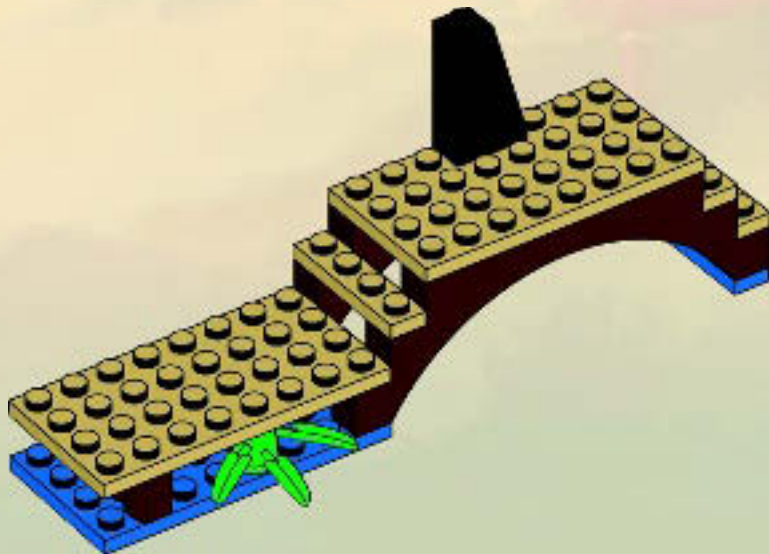



7

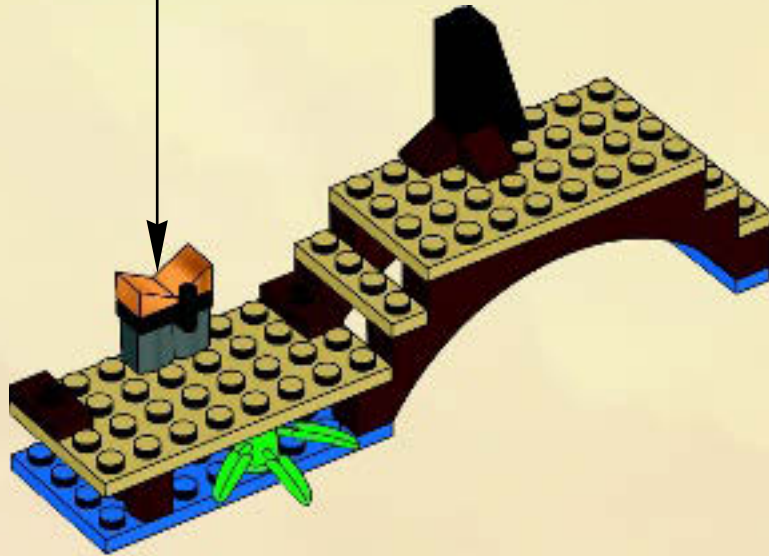

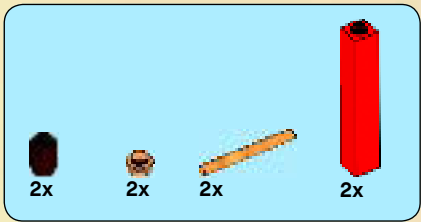

8

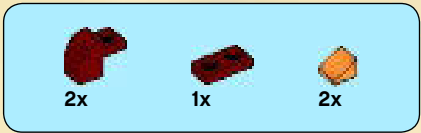
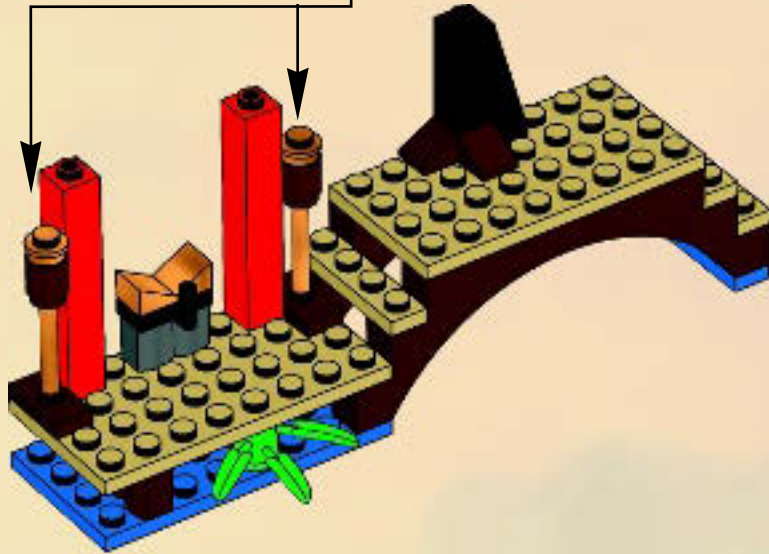
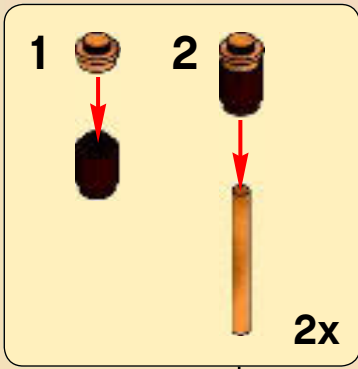

9

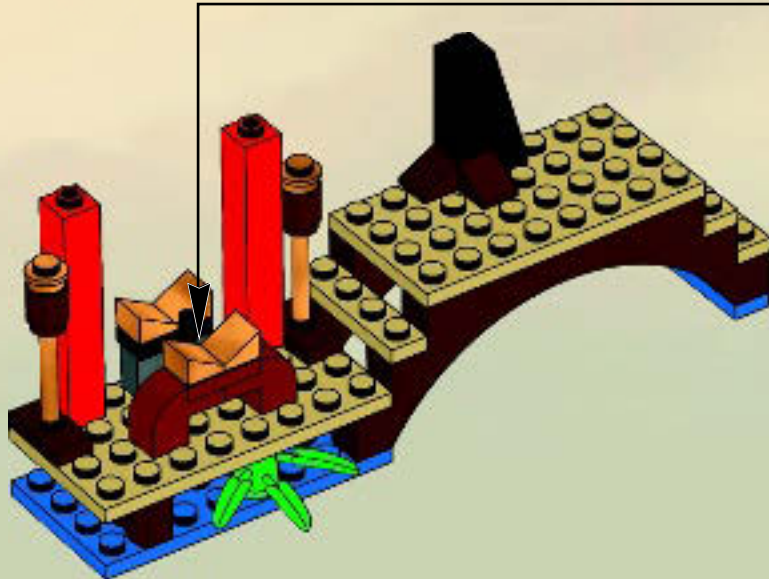



10

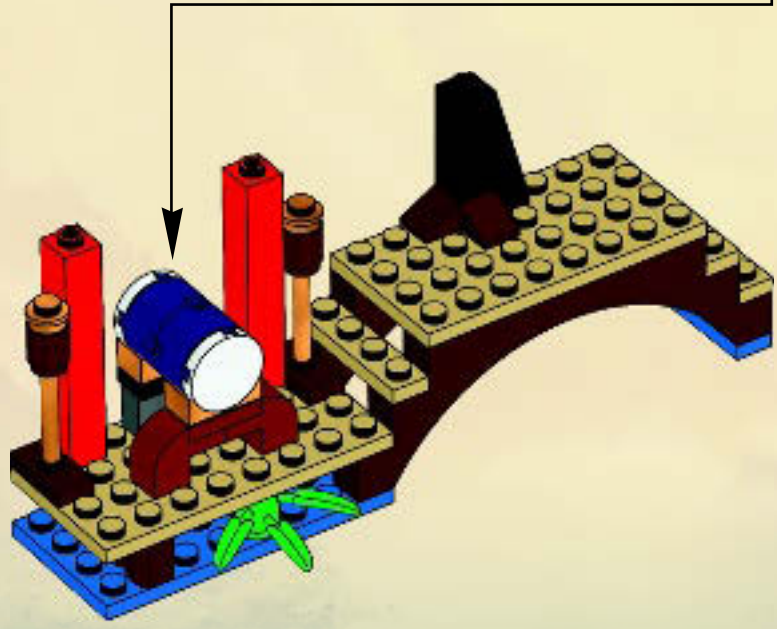
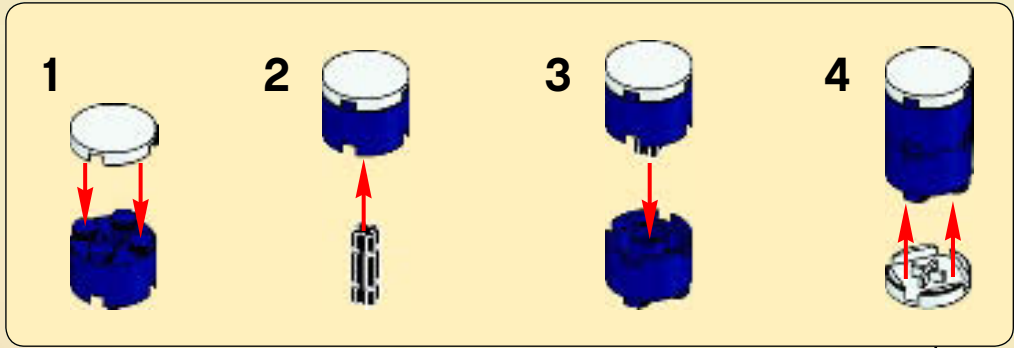

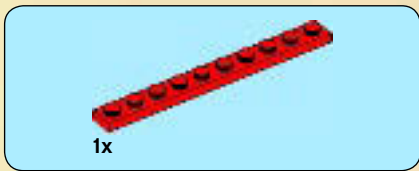

11

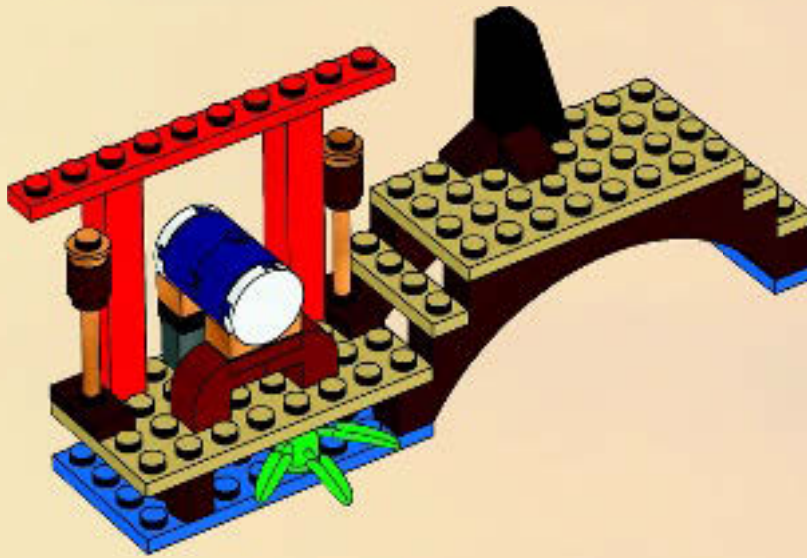

12

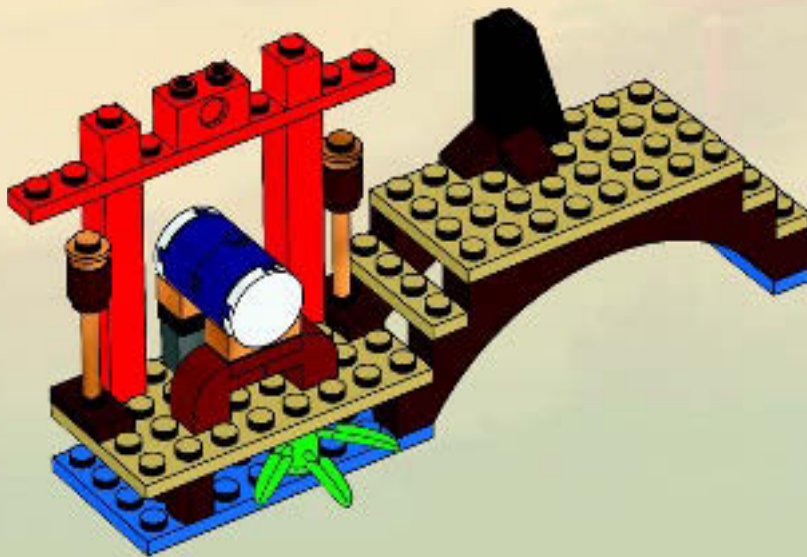



13

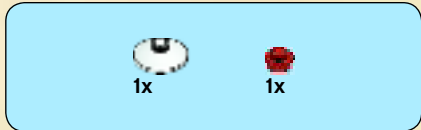
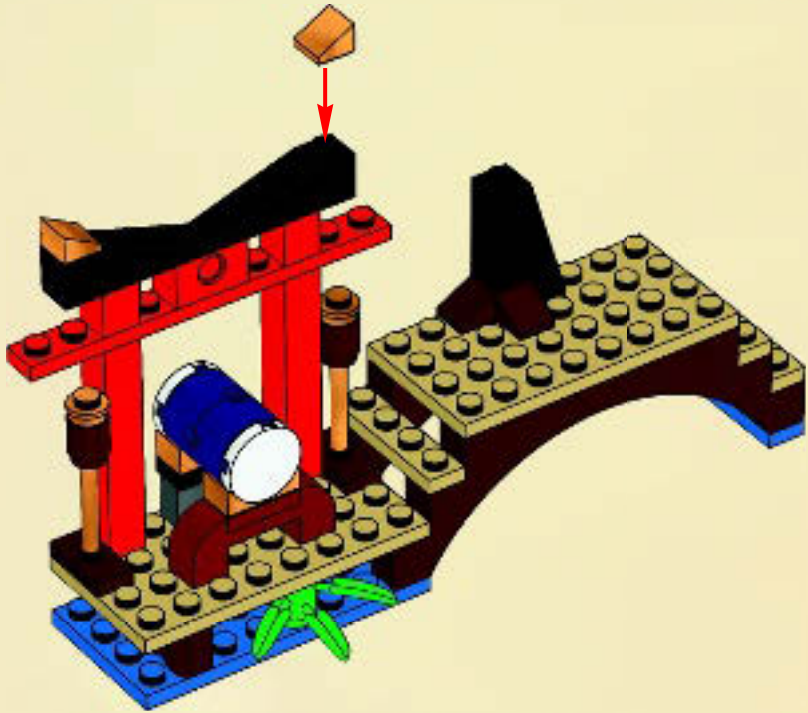

14

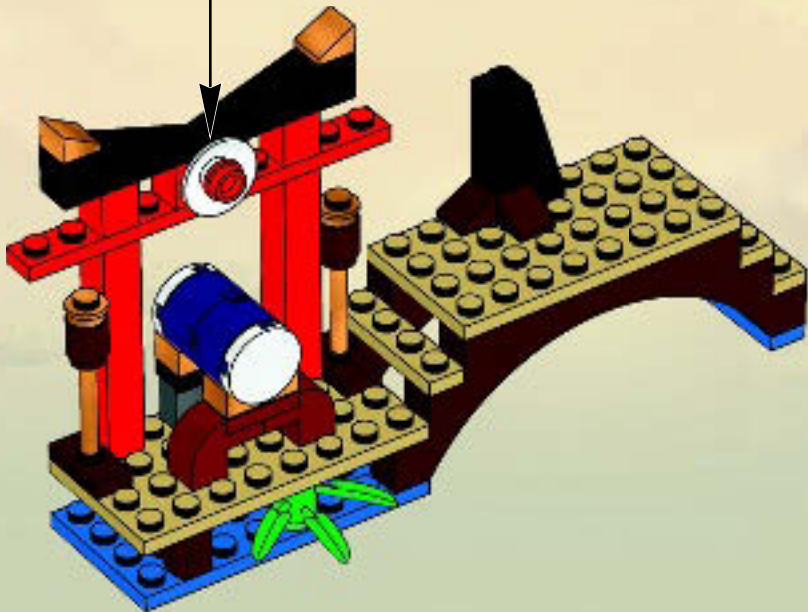
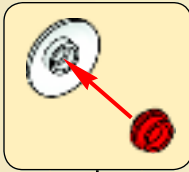

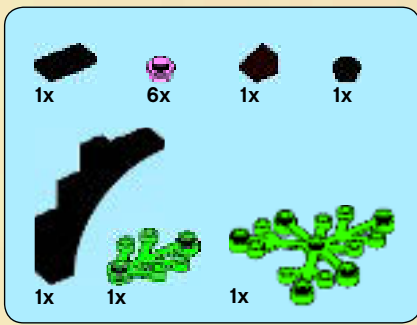

1



2

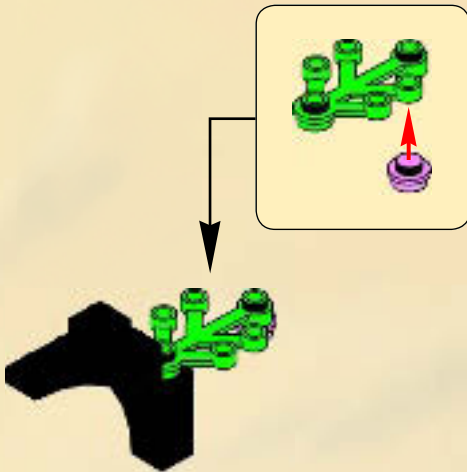

3



4

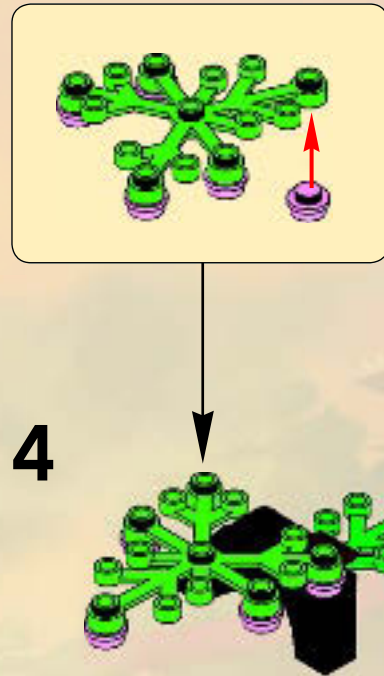

5



15

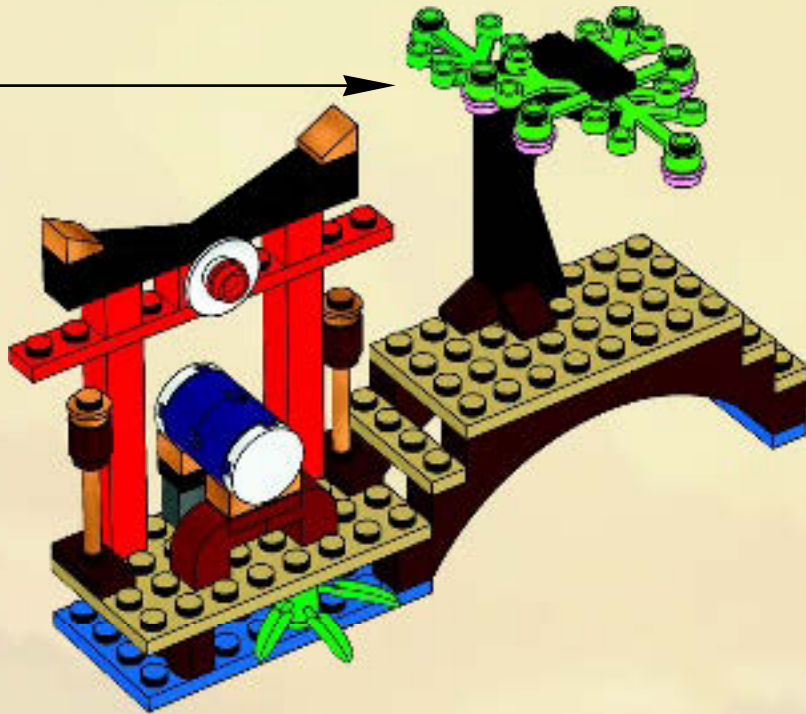



1

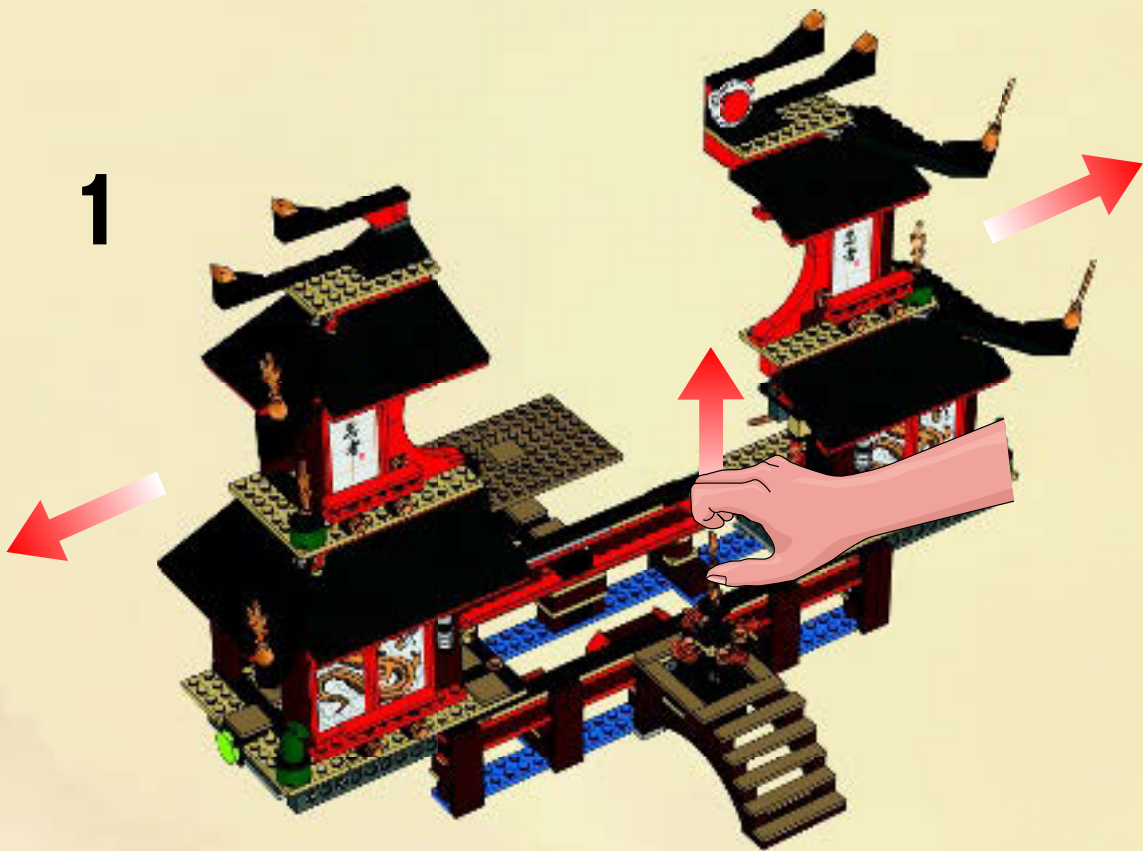

2

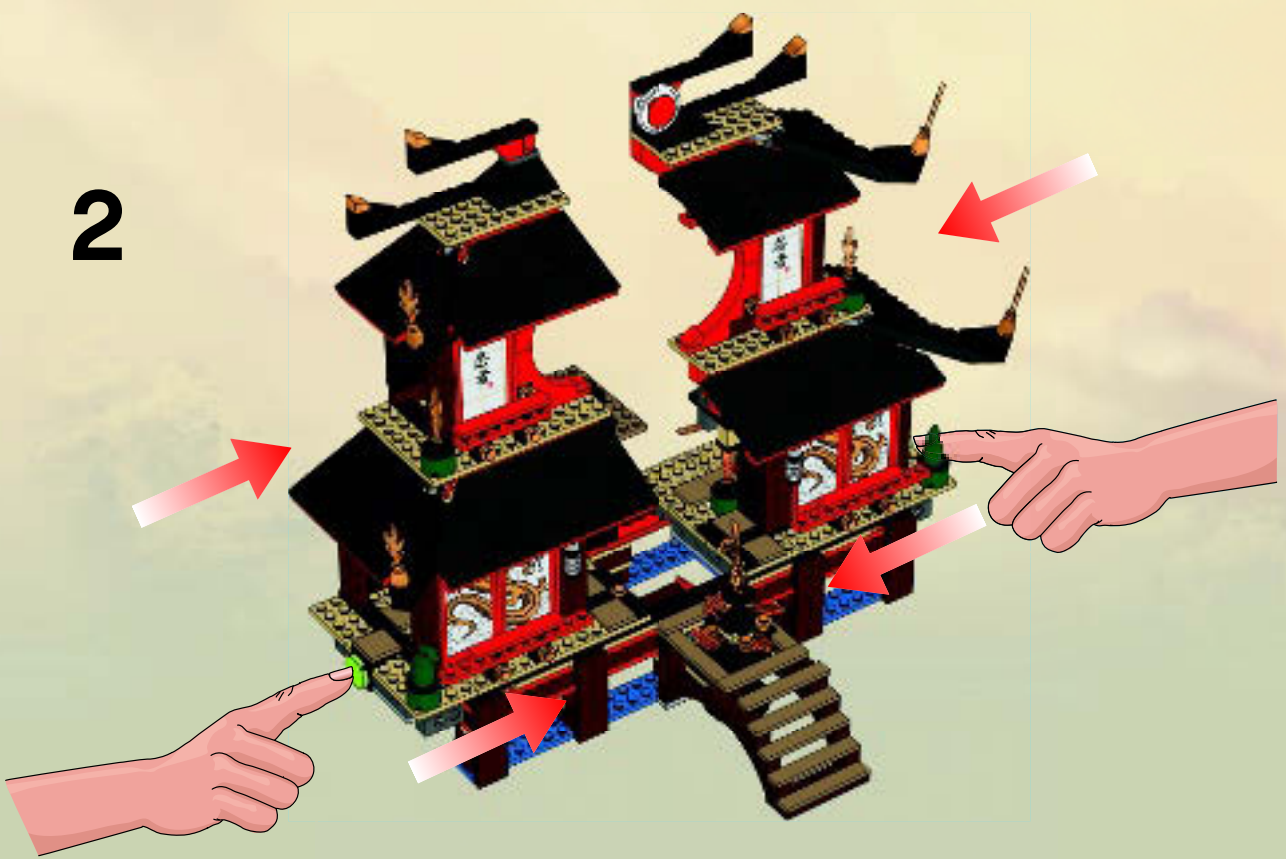

1

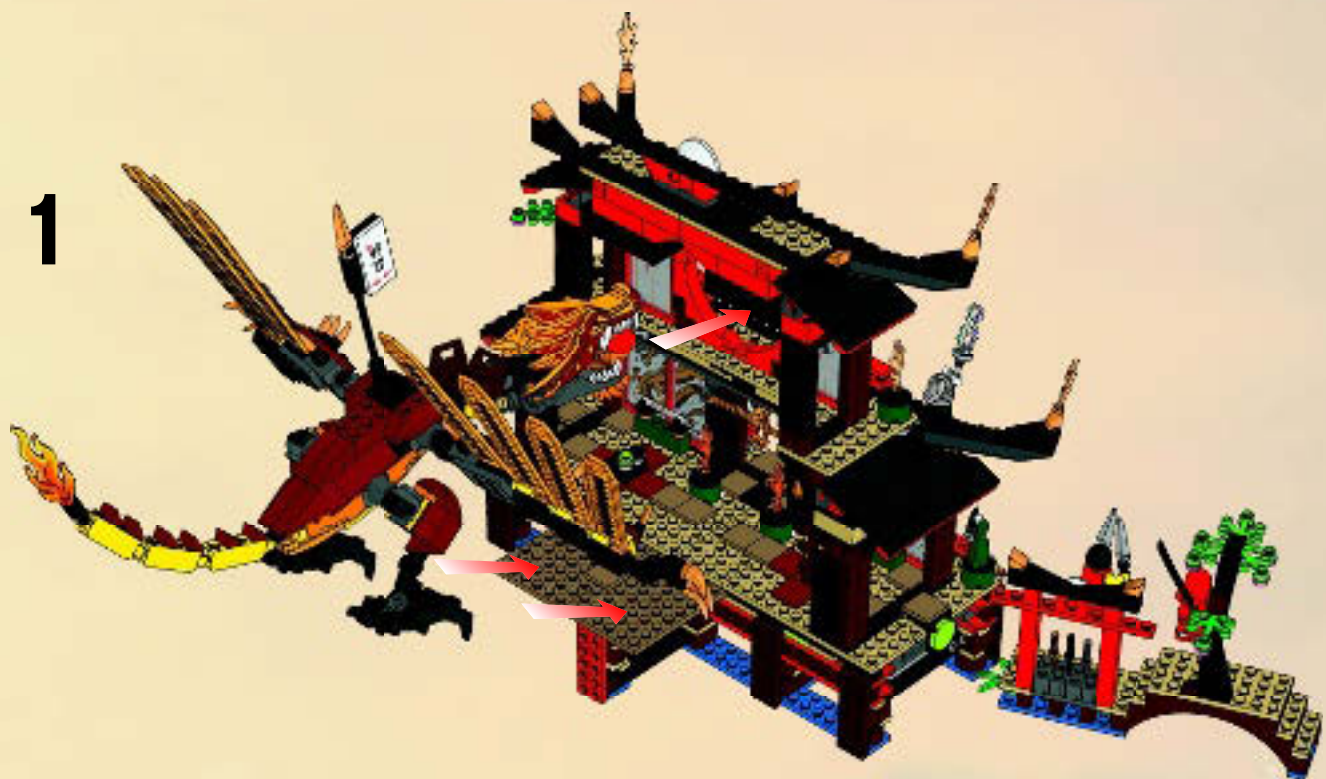

2





1x 4612857
 1x 379401
 6x 370901
 8x 614101
 2x 415001
 2x 474001
 1x 4179580
 1x 4612637
 6x 4609295
 4x 4602970
 1x 4612771
 1x 4602984
 1x 4612346
 1x 4611924
 1x 4623786
 1x 4641675
 1x 4600294
 1x 4600307
 1x 4609289

1x 4544140
 6x 4162465
 6x 4112982
 19x 4113917
 2x 4114077
 2x 4114084
 12x 4113233
 6x 4114309
 6x 4243824
 1x 4113988
 17x 4509897
 2x 4140593
 15x 4140562
 1x 4609291
 4x 4514554
 4x 300521
 4x 4212410
 4x 362221

6x 300121
 6x 300921
 3x 245821
 7x 306221
 1x 654121
 2x 370021
 2x 4504379
 2x 366521
 2x 4603263
 6x 4500462
 2x 4629998
 2x 4629997
 14x 306921
 2x 371021
 4x 366621
 4x 4113858
 6x 346021
 10x 447721

12x 4544531
 2x 614121
 1x 4278275
 6x 4550015
 4x 4190219
 4x 486521
 1x 4616366
 1x 4619618
 1x 4641677
 12x 613421
 1x 4622390
 1x 302223
 2x 371023
 10x 303423
 2x 303523
 6x 4206482
 3x 4218728
 3x 370024

1x 4277159
 4x 302224
 2x 362324
 3x 302024
 12x 4205196
 1x 4611424
 1x 4611429
 1x 4616378
 1x 4611432
 2x 4544151
 1x 4239601
 6x 245426
 3x 300326
 2x 300226
 2x 300726
 16x 4558954
 10x 4529236
 2x 3200026
 1x 370126

1x 389426
 2x 370226
 2x 4144025
 2x 389526
 10x 428626
 4x 4515362
 2x 367526
 8x 4581280
 6x 306926
 6x 302326
 4x 362326
 6x 302126
 12x 346026
 8x 416226
 6x 303226
 2x 383226



2x 303626
 2x 4514845
 4x 303026
 4x 255526
 1x 394026
 4x 4598528
 1x 4569733
 21x 4277932
 2x 4535739
 1x 4613759
 2x 4604304
 2x 3200126
 4x 4192456
 19x 614126
 6x 474026
 6x 4515350
 2x 4227684

10x 4106977
 1x 4631558
 1x 4616334
 1x 4630138
 6x 4650022
 1x 4616311
 1x 4526756
 1x 4624209
 2x 4598897
 2x 4114206
 2x 4143372
 1x 4159335
 4x 4213374
 1x 4209159
 1x 4636072
 1x 4598407
 2x 4584550
 3x 4184169

4x 4107082
 1x 4109810
 11x 4121715
 1x 4526982
 4x 4119589
 2x 242328
 2x 4114348
 2x 4129872
 2x 4639781
 2x 4639782
 2x 4639783
 1x 4548009
 2x 612647
 4x 4540865
 2x 4613934
 2x 4177932

4x 4180512
 4x 4180540
 2x 4587102
 2x 4164037
 1x 4183133
 2x 4541957
 1x 4514700
 23x 4507045
 9x 4507047
 2x 4251796
 2x 4566927
 2x 4505985
 2x 4245571
 6x 4265392
 2x 4619469
 1x 4541369
 2x 4539059
 20x 4531415
 4x 4541526

2x 4541380
 2x 4539081
 1x 4541523
 1x 4541524
 2x 4539082
 4x 4541546
 2x 4611666
 2x 4539097
 14x 4539105
 5x 4539061
 6x 4261397
 2x 4525868
 2x 4525869
 8x 4629838
 1x 4630187
 6x 4211201
 70x 4211180

19x 4211181
 5x 4211183
 15x 4211166
 2x 4267994
 6x 4504376
 6x 4584719
 3x 4211194
 3x 4211186
 8x 4211204
 7x 4211247
 2x 4219726
 3x 4211219
 1x 4538724
 3x 4252456
 2x 4211718
 2x 4211466
 7x 4211438
 1x 4211369
 4x 4211803

- 2x 4211503
- 1x 4211628
- 1x 4539481
- 2x 4616840
- 9x 4211483
- 4x 4211375
- 2x 4211815
- 8x 4225033
- 2x 4211103
- 6x 4211095
- 4x 4225973
- 1x 4497253
- 4x 4225975
- 4x 4209726
- 6x 4211137
- 1x 4294180
- 4x 4211063
- 1x 4227398
- 2x 4212075
- 1x 4609368
- 2x 4289542
- 12x 211066
- 1x 4516456
- 2x 4210665
- 2x 4508553
- 1x 4499858
- 12x 4517996
- 6x 4529247
- 12x 4587002
- 65x 4523159
- 1x 4579099
- 3x 4600267
- 1x 4600270
- 10x 4618195
- 1x 4626501
- 3x 4640843
- 2x 4600519
- 3x 4614404
- 1x 4614710
- 7x 4611904
- 1x 4600501
- 1x 4273965
- 2x 4518562
- 2x 4518606
- 2x 4566688
- 1x 4616331
- 3x 4612900
- 1x 4611883
- 1x 4631534
- 1x 4631535
- 1x 4631541



Customer Service
Kundenservice
Service Consommateurs
Servicio Al Consumidor

www.lego.com/service or dial

 : 00800 5346 5555
 : 1-800-422-5346



NINJAGO

Masters of Spinjitzu



2257



2254



2174



2175



2255



2256



NINJAGO

Masters of Spinjitzu



2170
2507
2509



2508
2507



2170



2170
2507
2508
2509



2171



2171



2171
2507
2508



2507



2172

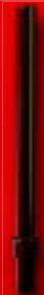

2172
2507



2173



2173
2174



2173
2256
2508



2174



2174
2175



2175



2175



2255



2255



2255
2507
2508



2256



2256



2506



2506
2507



2506
2507



2506
2507



2507
2254



2507



2508



2508



2509



2509



2254



2254



NINJAGO

Masters of Spinjitzu



JAY
2257 - 2506



KAI DX
2507 - 2508 - 2254



ZANE
2506 - 2507



COLE DX
2170 - 2509



NYA
2172 - 2507



SENSEI WU
2255 - 2507



GARMADON
2256 - 2506 - 2507



SAMUKAI
2507



NUCKAL
2173



FRAKJAW
2257



KRUNCHA
2174 - 2507



WYPLASH
2175 - 2506 - 2509



NINJAGO
Masters of Spinjitzu





NINJAGO

Masters of Spinjitzu



NINJAGO.COM



NINJAGO

Masters of Spinjitzu



NINJAGO.COM



NINJAGO

THE VIDEO GAME
LE JEU VIDÉO
EL VIDEO JUEGO



OUT NOW!
MAINTENANT DISPONIBLE !
¡DISPONIBLE AHORA!

LEGO Bricques, Ninjabot software © 2011 TT Games Publishing Ltd. Produced by TT Games under license from the LEGO Group. LEGO, the LEGO logo, the Brick and the Knob configurations and the Minifigure are trademarks of the LEGO Group. © 2011 The LEGO Group. Hellbent Games and the Hellbent logo are trademarks of Hellbent Games Inc. Nintendo DS is a trademark of Nintendo. © 2004 Nintendo. All other trademarks and copyrights are the property of their respective owners. All rights reserved.

LEGO Bricques, Le logiciel Ninjabot © 2011 TT Games Publishing Ltd. Produit par TT Games sous licence de LEGO Group. LEGO, le logo LEGO, le Bricques, les configurations du briquet et la Minifigures sont des marques de commerce de LEGO Group. © 2011 The LEGO Group. Hellbent Games et le logo Hellbent sont des marques de commerce de Hellbent Games Inc. Nintendo DS est une marque de commerce de Nintendo. © 2004 Nintendo. Toutes les autres marques de commerce et droits d'auteur sont la propriété de leurs propriétaires respectifs. Tous droits réservés.

LEGO Bricques, Ninjabot software © 2011 TT Games Publishing Ltd. Produced by TT Games under license from the LEGO Group. LEGO, the LEGO logo, the Brick and the Knob configurations and the Minifigure are trademarks of the LEGO Group. © 2011 The LEGO Group. Hellbent Games and the Hellbent logo are trademarks of Hellbent Games Inc. Nintendo DS is a trademark of Nintendo. © 2004 Nintendo. All other trademarks and copyrights are the property of their respective owners. All rights reserved.



www.pegi.info



NINJAGO

THE BOARD GAME
LE JEU DE SOCIÉTÉ



3856



2-4



8+



15 - 25



www.LEGO.com/LEGOGames



www.LEGOclub.com

FREE! GRATIS! GRATUIT!



LEGO® Club Magazine



LEGO® Club Email

SIGN UP ONLINE!

www.LEGOclub.com

VISIT THE WORLD'S BIGGEST LEGO® SHOP!
www.LEGOshop.com

GO TO
www.LEGOclub.com

00800 5346 5555*

1-866-534-6258 • 1-877-518-5346

US & Canada only

Canada seulement



* Freephone. Mobile charges may apply. * Numéro sans frais. Des frais peuvent s'appliquer avec les téléphones cellulaires. * Gebührenfrei. Kosten für Anrufe aus Mobilfunknetzen können abweichen. * Gratis telefoonnummer vanaf vaste lijn. * Det er et gratis nummer, når du ringer fra fasttelefon. * Det är gratis, när du ringer från en fast telefon. * Numéro sans frais. Des frais peuvent s'appliquer avec les téléphones portables.



WIN!

Go to www.LEGOsurvey.com/product to fill out a survey for a chance to win a cool LEGO® Product. No purchase necessary. Open to all residents where not prohibited.



www.LEGO.com

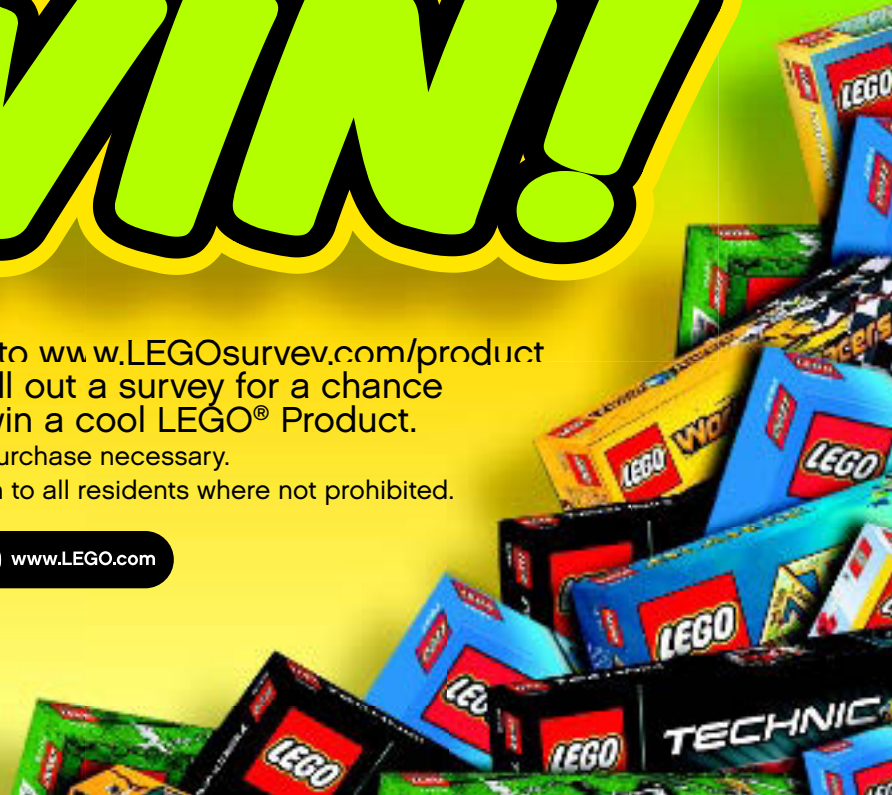

www.LEGOsurvey.com/product

GEWINNE!

Nimm an der Umfrage auf www.LEGOsurvey.com/product teil und hab die Chance ein cooles LEGO® Produkt zu gewinnen!

Die Teilnahme am Gewinnspiel führt zu keinerlei Kaufverpflichtungen. Teilnahme in allen nicht ausgeschlossenen Ländern möglich.

WIN!

Ga naar www.LEGOsurvey.com/product, vul een enquêteformulier in en maak kans op een cool LEGO® product.

Geen aankoopverplichting. Iedereen mag deelnemen, uitgezonderd ingezetenden van landen waar een enquêteverbod geldt.

GAGNE!

Visite www.LEGOsurvey.com/product pour répondre à un questionnaire et avoir une chance de gagner un produit LEGO® très cool!

Aucune obligation d'achat. Ouvert à tous les résidents des pays autorisés.

当てよう!

www.LEGOsurvey.com/product にアクセスして、アンケートにご記入ください。当選者にはレゴ®製品を差し上げます。

お買い上げの必要はありません。禁止されていない限り、すべての皆様にご利用いただけます。



NINJAGO

Masters of Spinjitzu



2011