



Инструкция ЛЕГО (Lego) 31034-1

CREATOR

31034



LEGO.com/creator



WARNING: CHOKING HAZARD.
Toy contains small parts and a small ball.
Not for children under 3 years.

1



2



3



4





1x

1

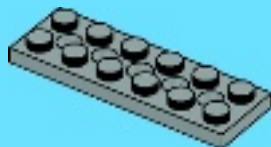

AVERTISSEMENT : RISQUE D'ÉTOUFFEMENT.

Le jouet contient des petites pièces ainsi qu'une petite boule. Il ne convient pas aux enfants de moins de 3 ans.



ADVERTENCIA: PELIGRO DE ASFIXIA.

Juguete que contiene partes pequeñas y una pelota pequeña. No recomendado para niños menores de 3 años.

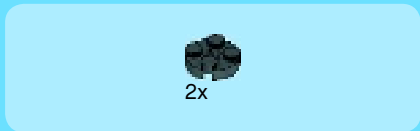

2x

2

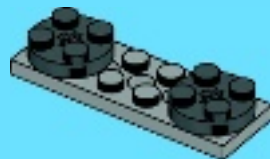



1x

3



4



2x

4



2x



2x



2x

5



2x



1x

6

1



2





2x



2x

7



1x



1x

8





2x



1x



1x



1x

9



1x



1x



1x

10





2x



1x



1x

11

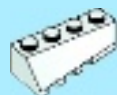
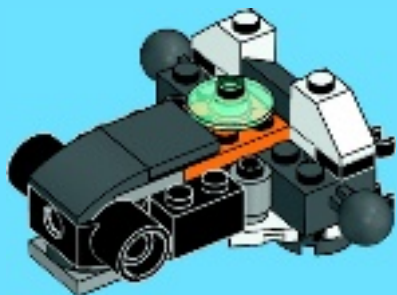

1x



1x

12

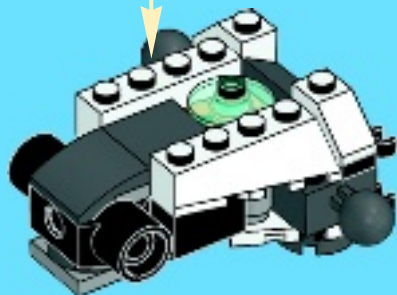
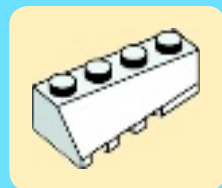



2x



2x



2x



2x



2x



2x



2x

13

1



2

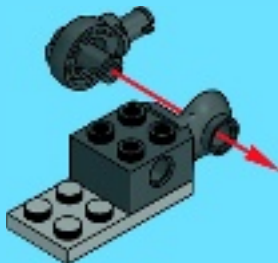

3



4



2x





2x



1x



1x

1

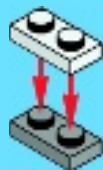

1x

2





1x

3

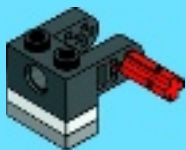

1x

4

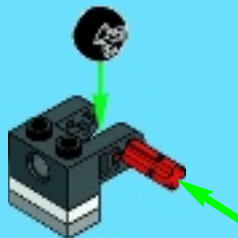



1x

5



1x



1x

6

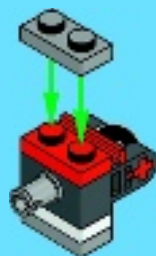



1x

7

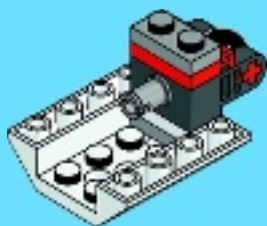

14



1x



1x

8

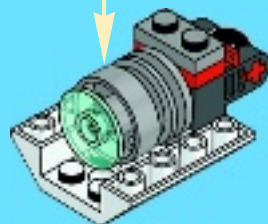
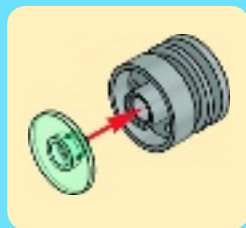

8x



9

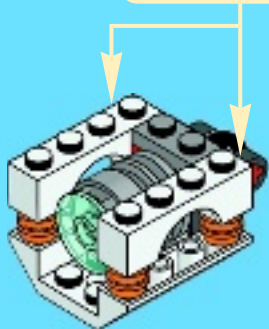
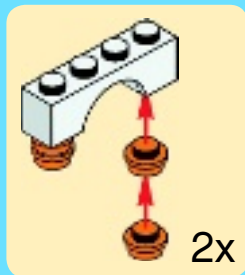

10





1x



1x

11

1



2

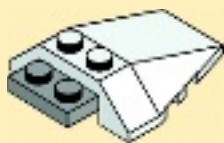

1x



2x

12





1x

13



2x

14

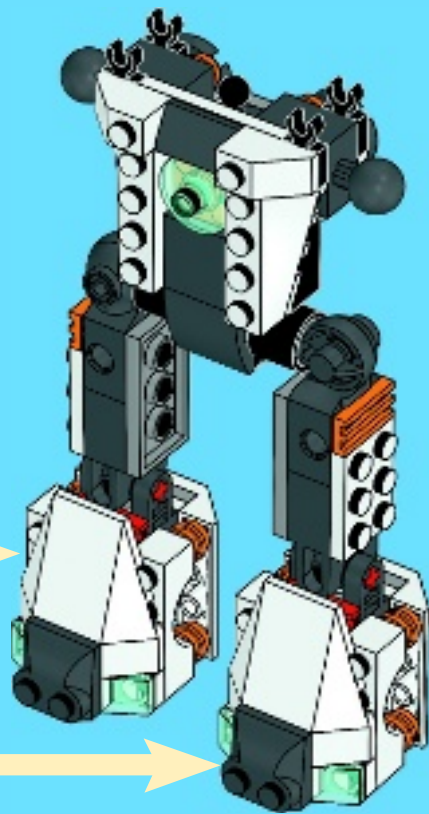



2x



2x



2x



2x



2x



2x



2x

15

1



2



3

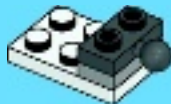

4

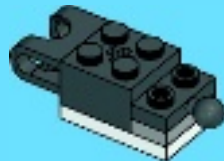

5

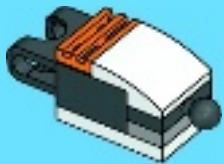

2x

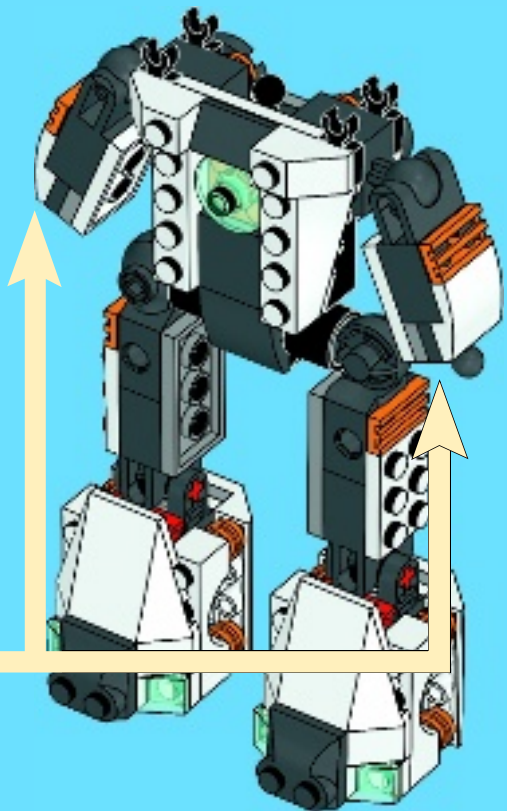



2x



2x



2x



2x



2x



2x



2x

16

1



2



3



4



5



6



2x

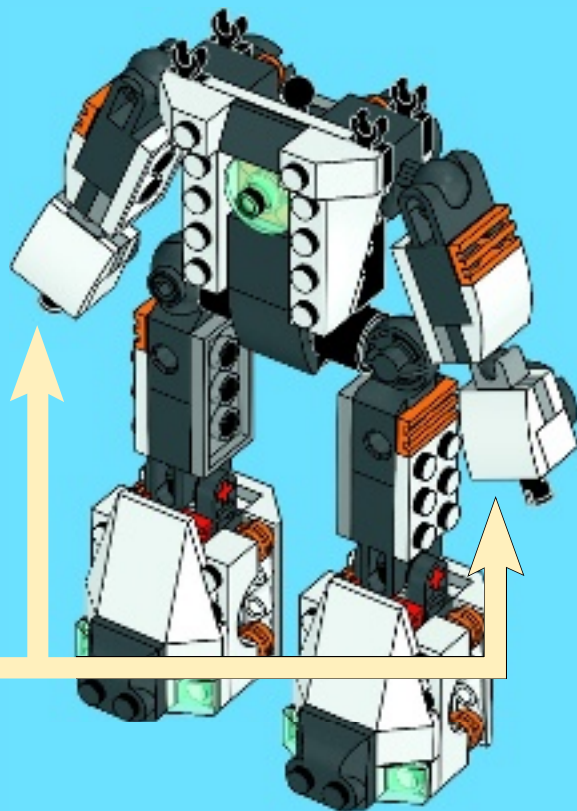



1x



1x



1x



1x



4x

17

1



2



3



4



5

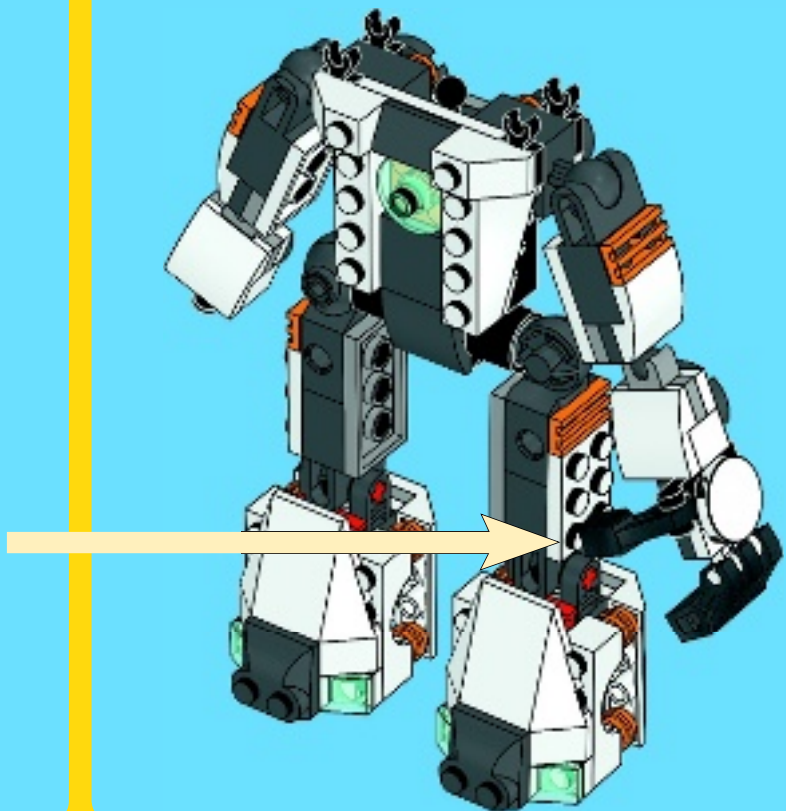



1x



1x



1x



1x



4x

18

1



2



3



4



5

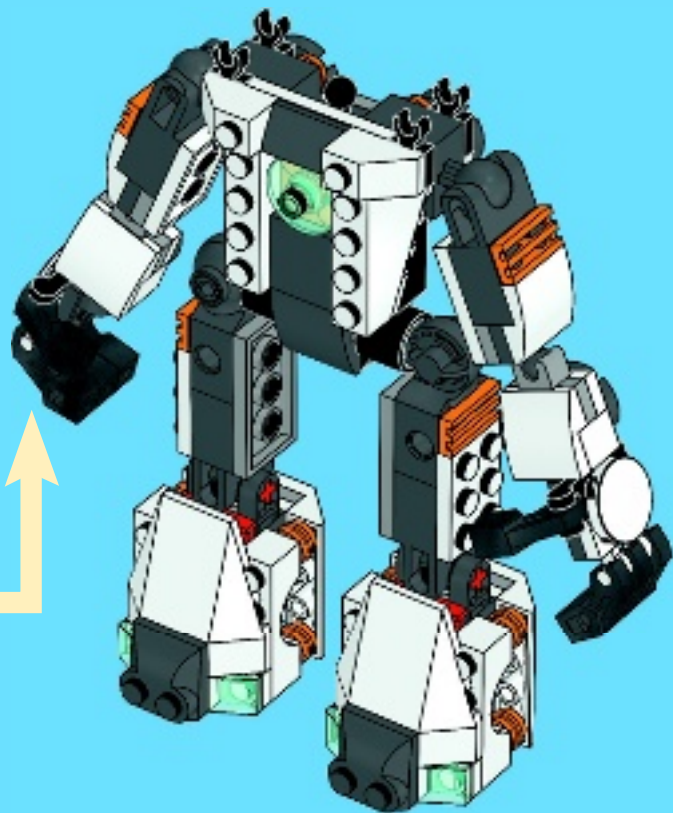



1x

1

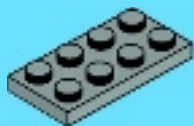

2x



1x

2



1x

3





4x

4

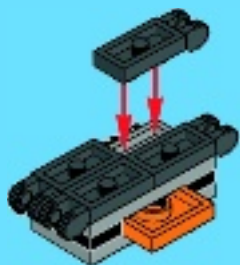

1x

5



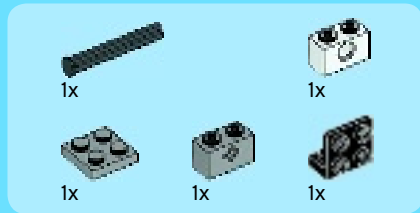

6

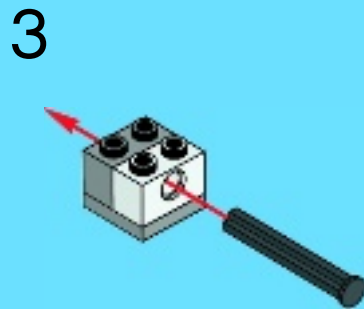
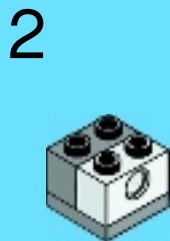
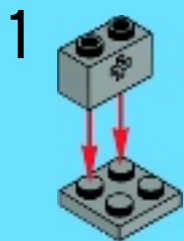

4





1x

7



19

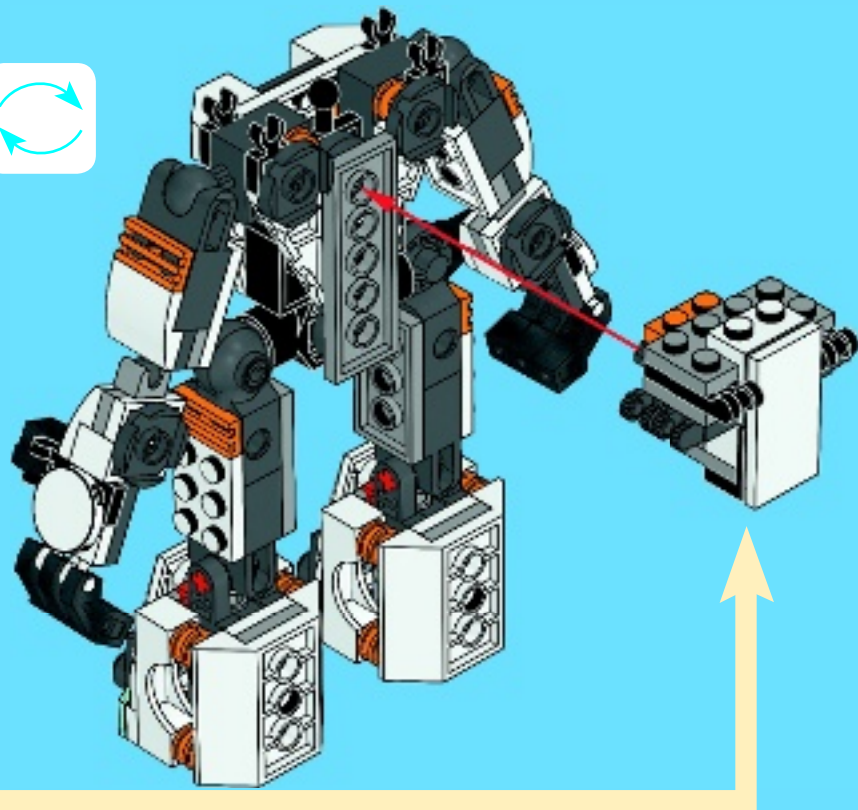



1x

1



1x

2



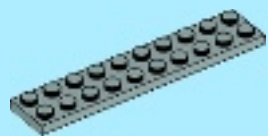

1x

3



1x



1x



1x

4





1x



1x

5



1x

6

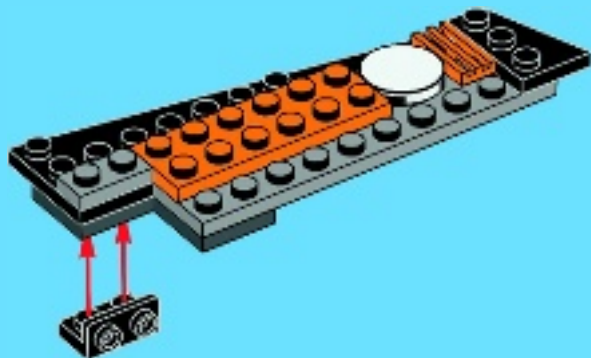



1x

7



2x

8

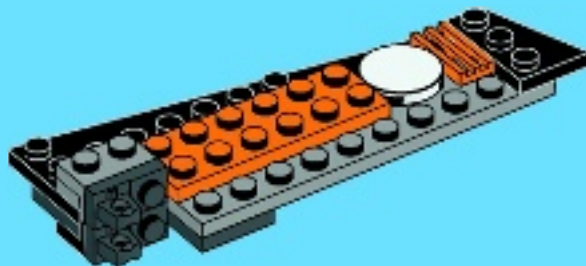



1x

9

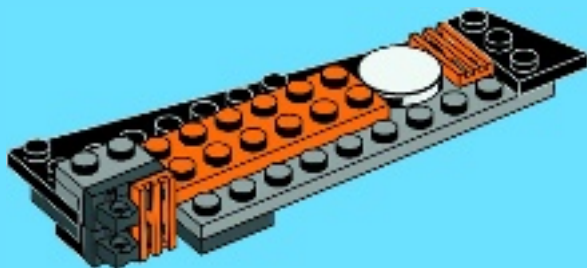

1x

10

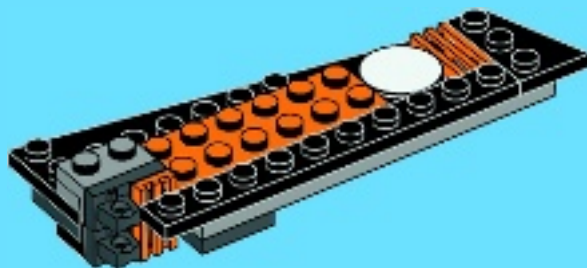

20

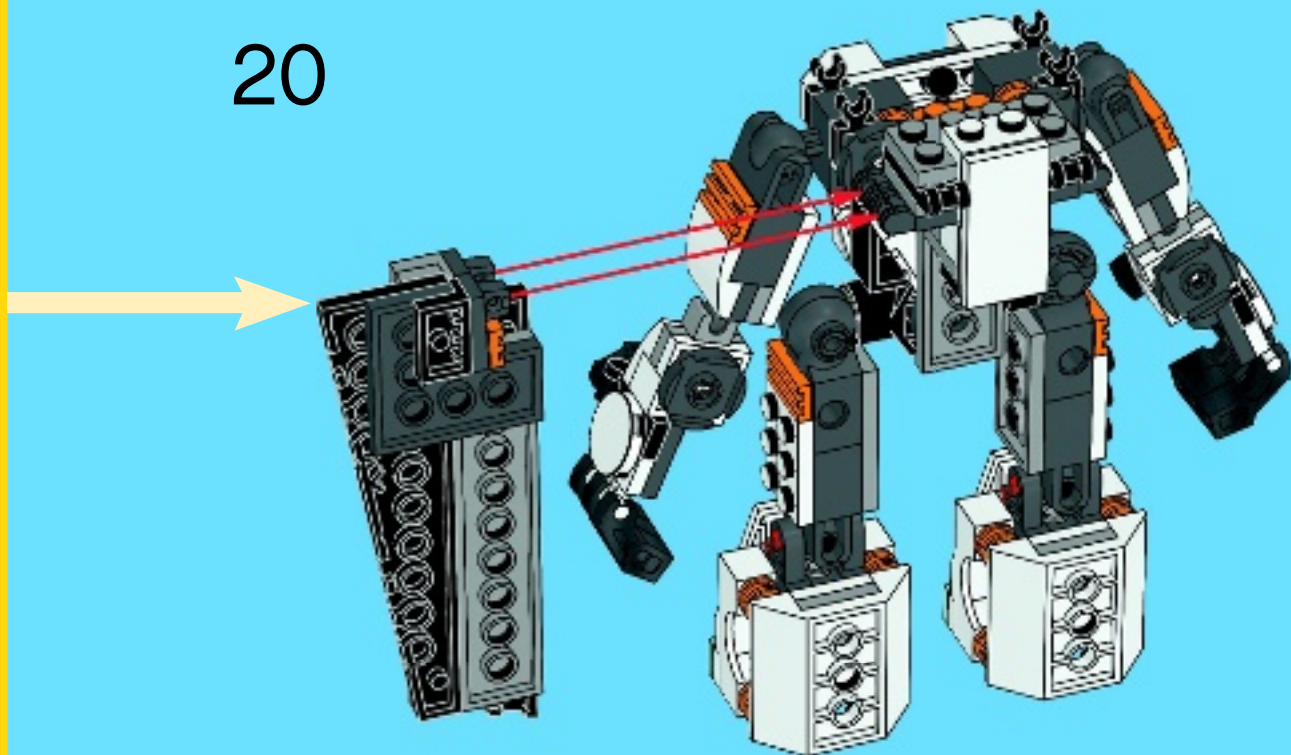



1x

1



1x

2

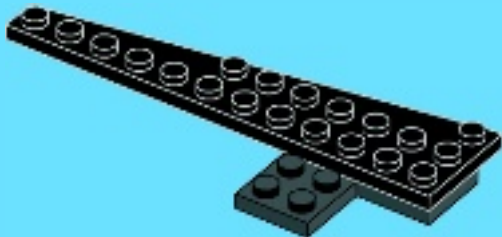

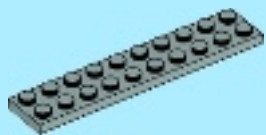

1x

3



1x



1x



1x

4





1x



1x

5

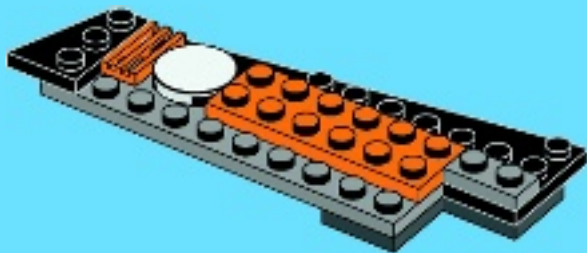

1x

6

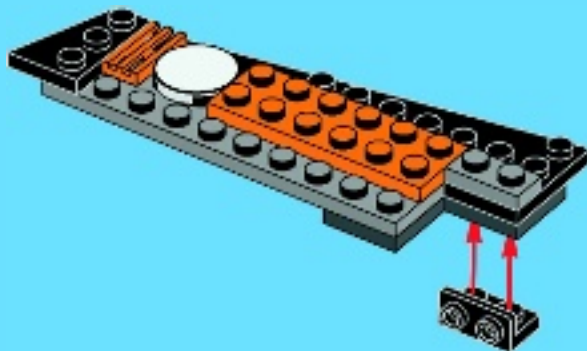



1x

7

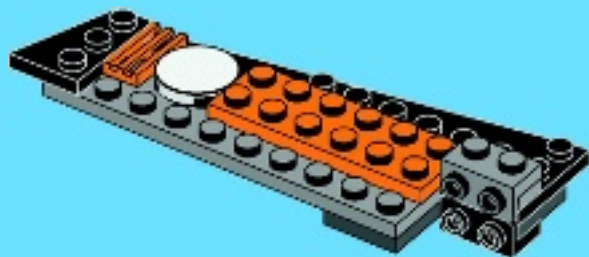

2x

8





1x

9

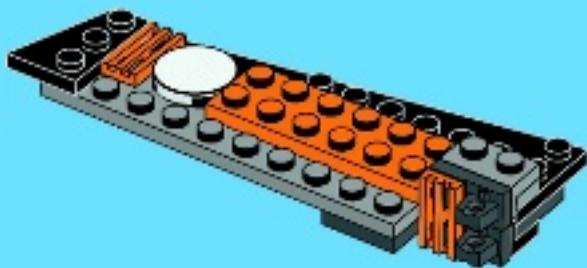

1x

10

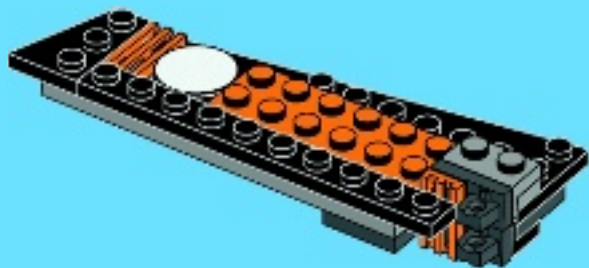

21

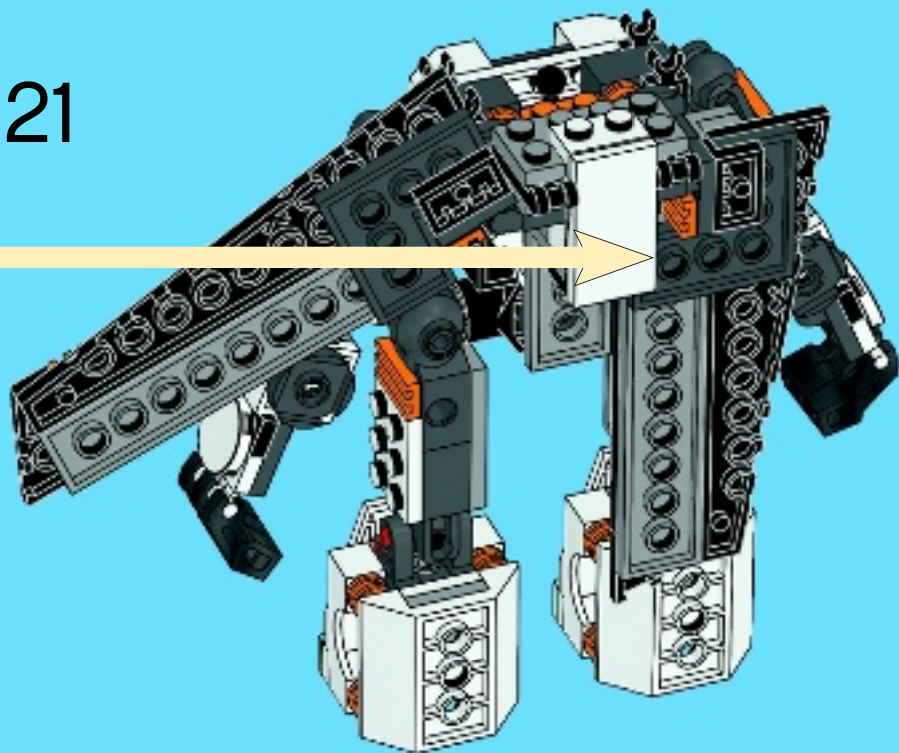



1x



1x

1

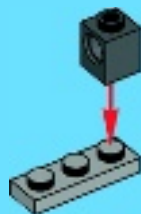

1x



1x

2

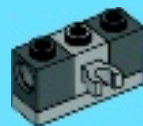



1x



1x

3

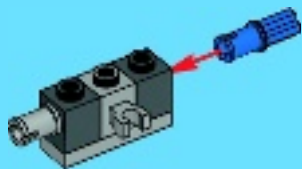

1x

4

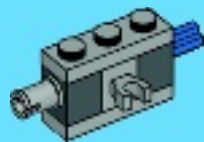



1x



1x

5

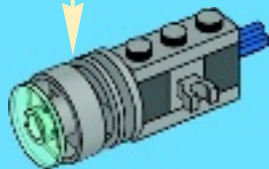
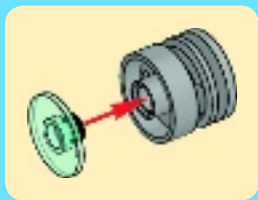

1x



1x

6

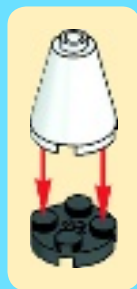

22

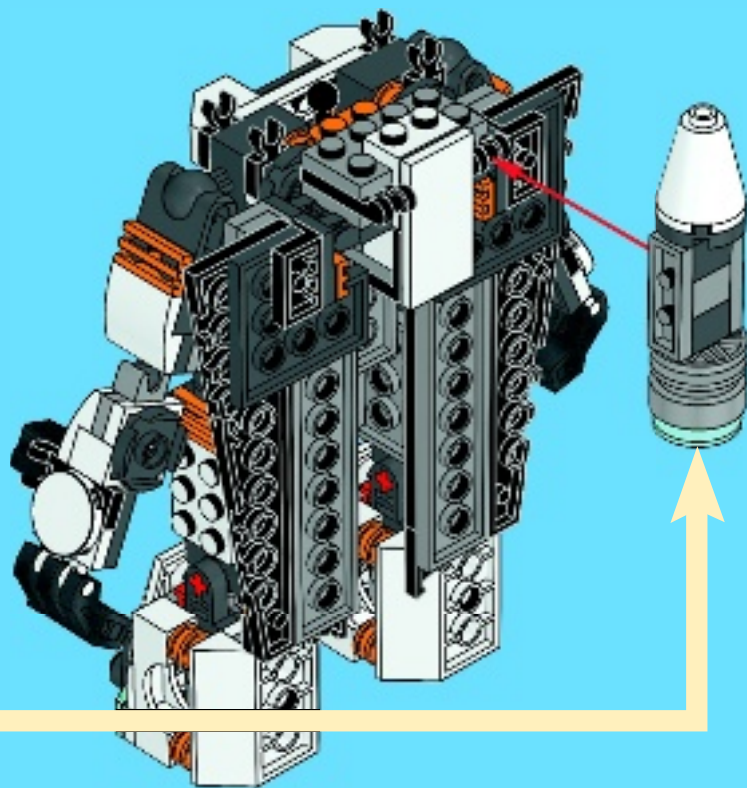



1x



1x

1

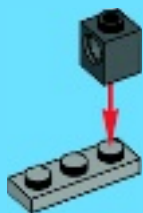

1x



1x

2

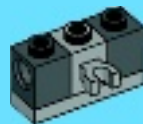



1x



1x

3

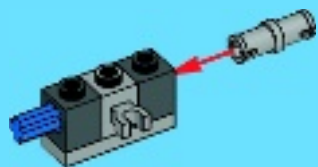

1x

4

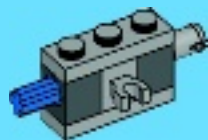



1x



1x

5

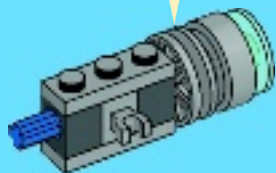
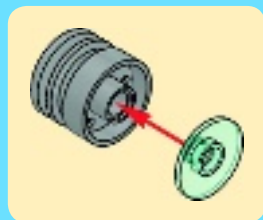

1x



1x

6

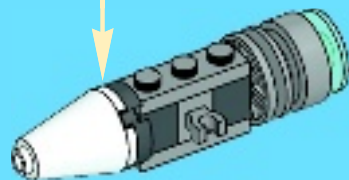
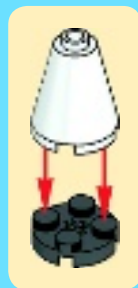

23

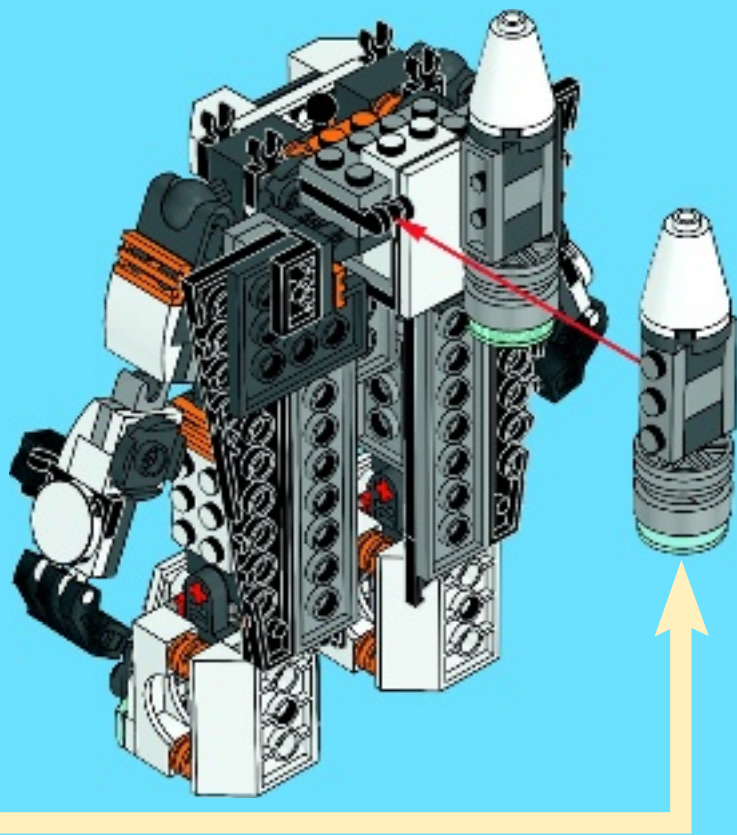



1x



1x

1

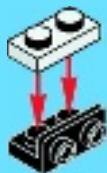

1x

2



1x

3





1x

4



2x

5



1x

6





1x



1x

7



1x



1x



1x

8

1



2

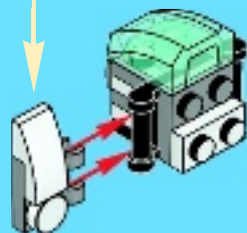



1x



1x



1x

9

1



2

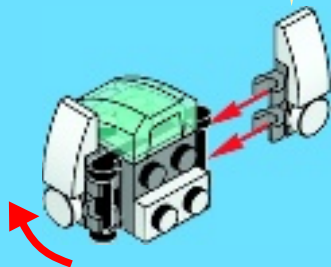

1x

10

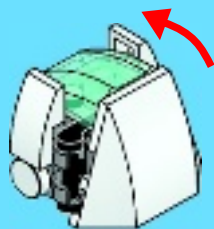

24





1x



1x



1x



1x

25

1

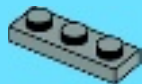

2

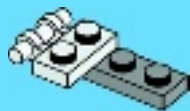

3



4



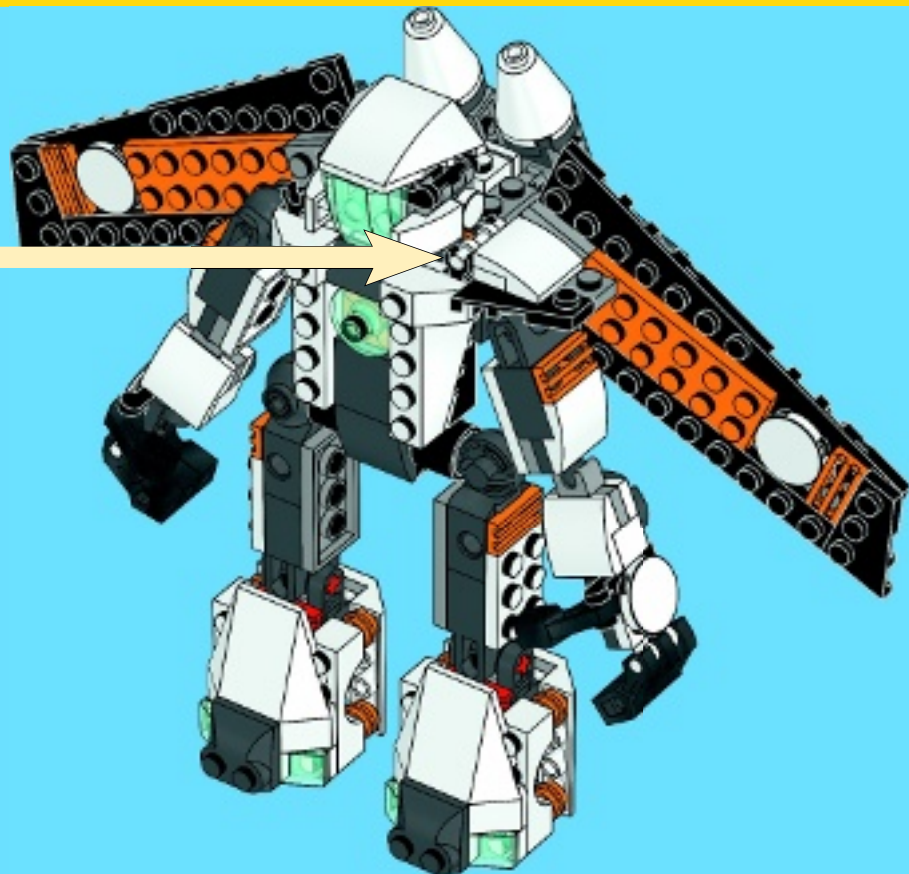

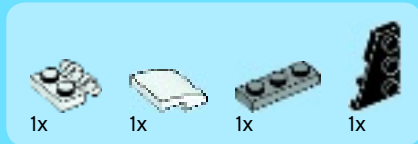

26

1

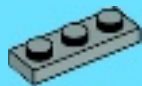

2

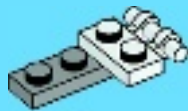

3



4







CREATOR



CREATOR ISLANDS



Apple, the Apple logo, iPad, iPhone and iPod touch are trademarks of Apple Inc., registered in the U.S. and other countries. App Store is a service mark of Apple Inc./Apple, le logo Apple, iPad, iPhone et iPod touch sont des marques de commerce d'Apple Inc., déposées aux Etats-Unis et dans d'autres pays. App Store est une marque de service d'Apple Inc./Apple, el logotipo de Apple, iPad, iPhone e iPod touch son marcas comerciales de Apple Inc. registradas en EE. UU. y otros países. App Store es una marca de servicio de Apple Inc.

Google Play is a trademark of Google Inc./Google Play est une marque de commerce de Google Inc./Google Play es una marca comercial de Google Inc.

LEGO.com/creator





CREATOR

31033

3 IN 1



LEGO.com/creator



CREATOR



31029

31027



31033



31033



31029



31027



LEGO.com/creator

WIN

GO TO WWW.LEGO.COM/PRODUCTFEEDBACK AND
GIVE US YOUR SHORT **FEEDBACK** ABOUT THIS
LEGO® SET FOR A CHANCE TO WIN
A COOL LEGO PRIZE.



LEGO.com/productfeedback

GEWINNE



Erzähle uns auf
www.LEGO.com/productfeedback

etwas über die Erfahrungen, die du mit
diesem LEGO® Set gemacht hast, und
sichere dir die Chance auf einen coolen
LEGO Preis!

GAGNE



Rends-toi sur
www.LEGO.com/productfeedback

et donne-nous quelques commentaires
sur ce produit LEGO® pour avoir une
chance de gagner un prix LEGO !

GANAN



Visita
www.LEGO.com/productfeedback

y envíanos tu opinión acerca de este set
LEGO®. ¡Participarás en el sorteo de un
premio LEGO!

获取奖品



登录
www.LEGO.com/productfeedback

给出关于此乐高®套装的简短反馈，
就有机会获得炫酷乐高奖品

LEGO and the LEGO logo are trademarks of the/son des marques de commerce du/son marcas registradas de LEGO Group. ©2015 The LEGO Group.