



Инструкция ЛЕГО (Lego) 31039

CREATOR

31039



LEGO.com/creator



LEGO.com/
brickseparator



Quick Build Construction Facile

Anfängermodelle
Construcción rápida
Construção Rápida
Egyszerűen és gyorsan -
kezdőknek
快速拼砌



Medium Build Construction moyenne

Fortgeschrittenenmodelle
Construcción
de nivel intermedio
Construção
Intermédia
Egyszerűen
és gyorsan - gyakorlóknak
中級拼砌



Advanced Build Construction avancée

Profimodelle
Construcción de nivel avanzado
Construção Avançada
Egyszerűen és gyorsan -
tapasztalt építőknek
高級拼砌



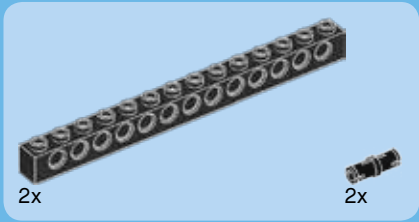

1

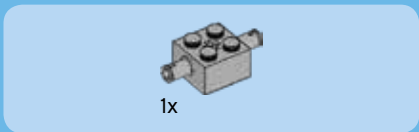
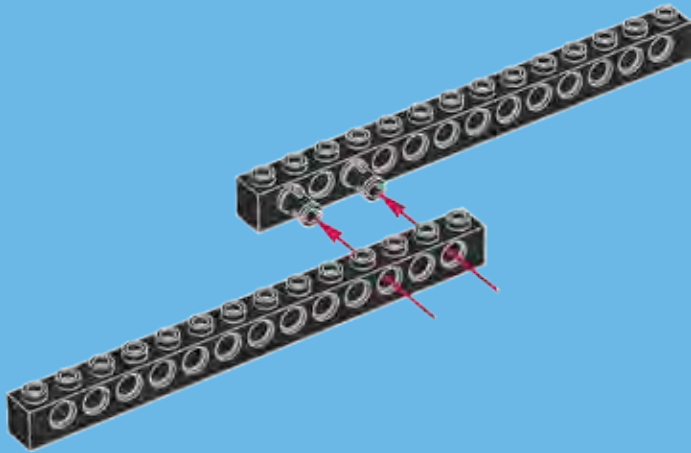

2

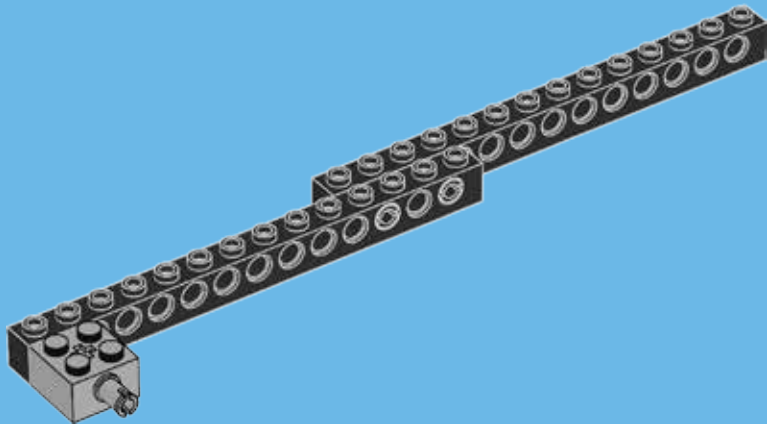



2x



2x



2x

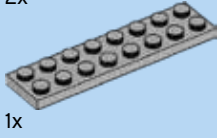

1x

3

1

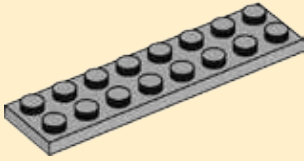

2

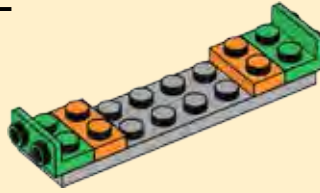

3

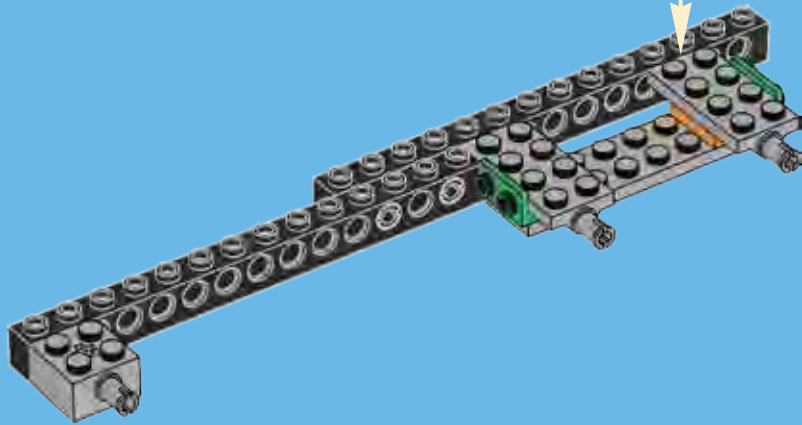
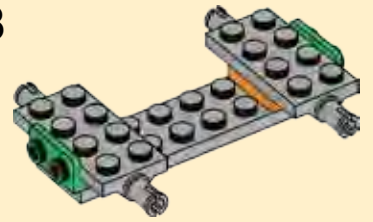

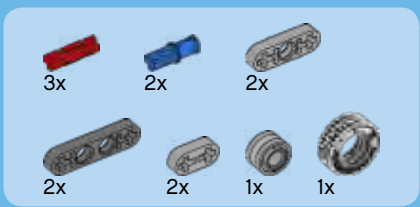

4

1



2



3

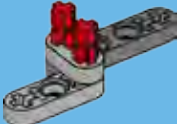

4

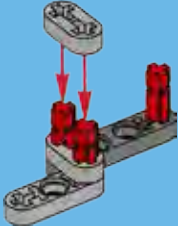

5

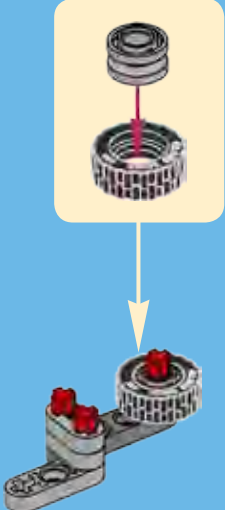

6

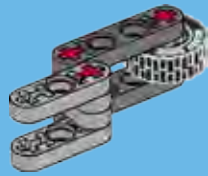

7

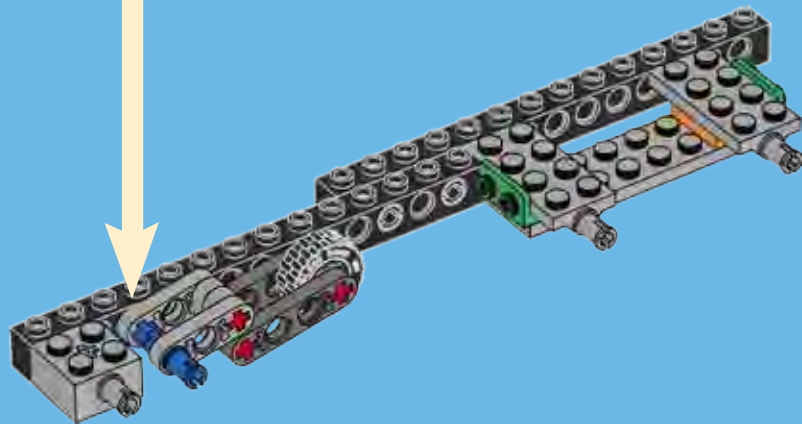
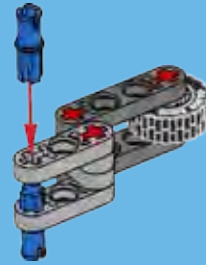

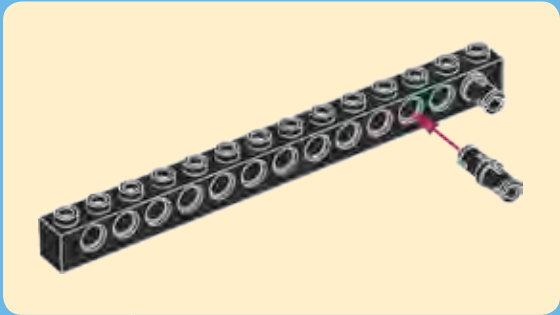
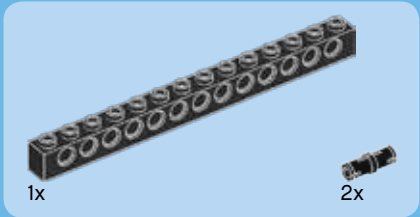

5

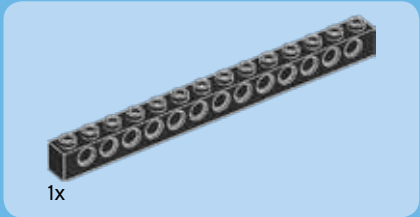
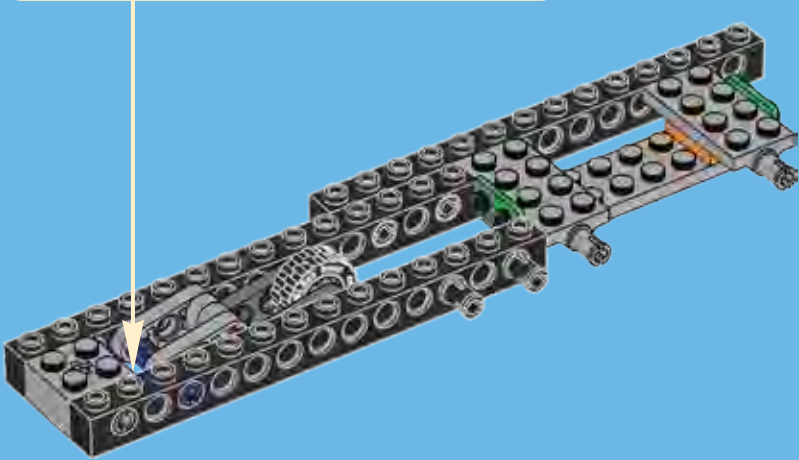

6

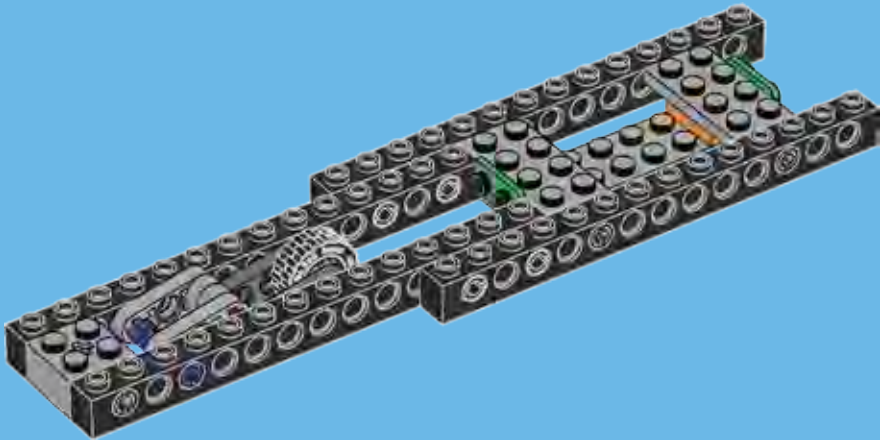



2x



2x

7

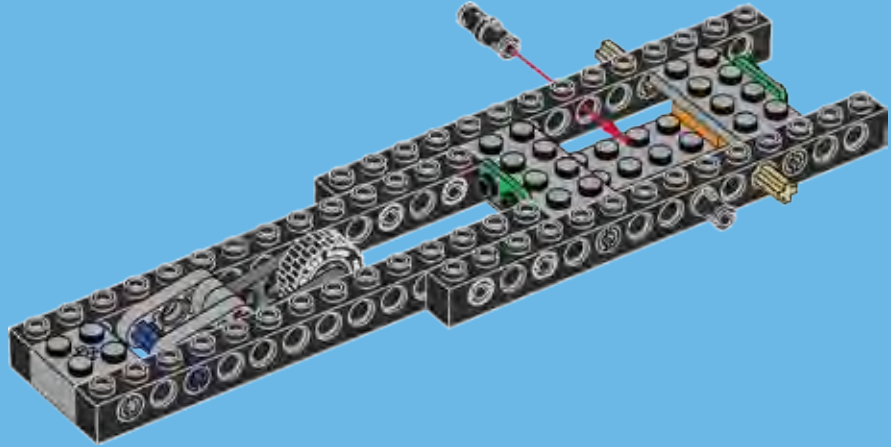

2x

8

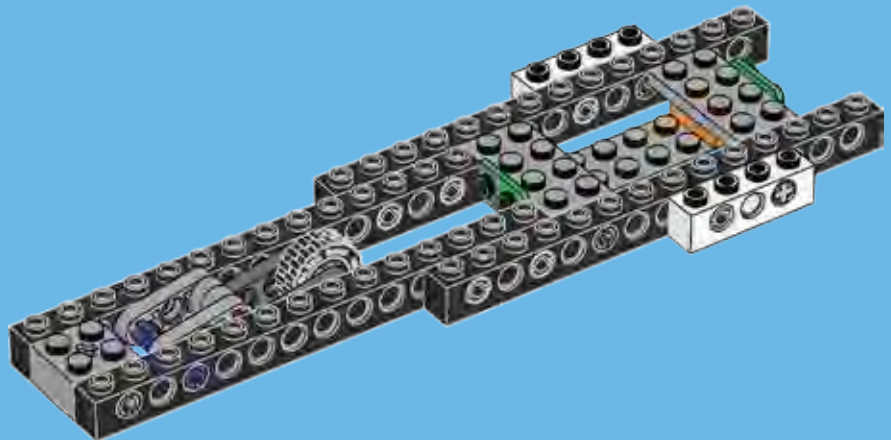

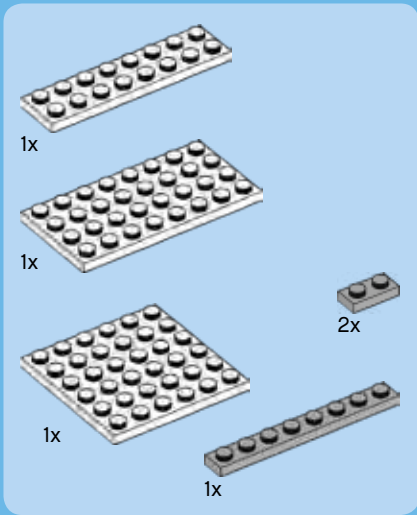

9

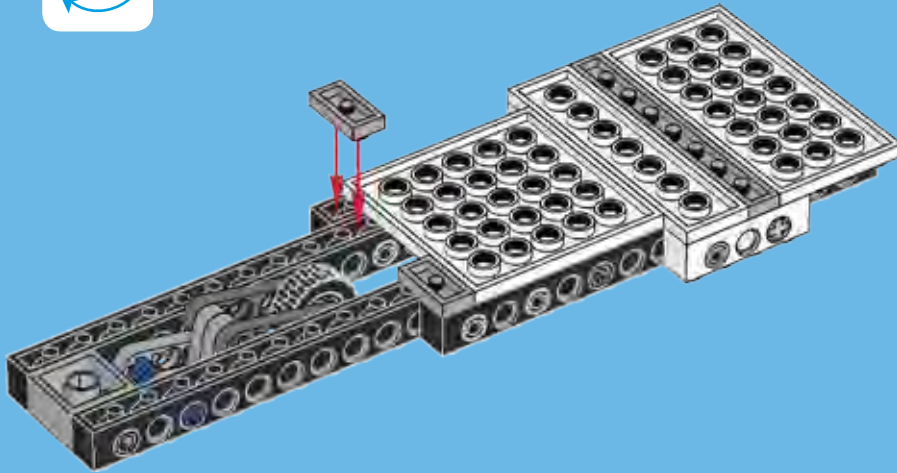



2x



4x



1x

10

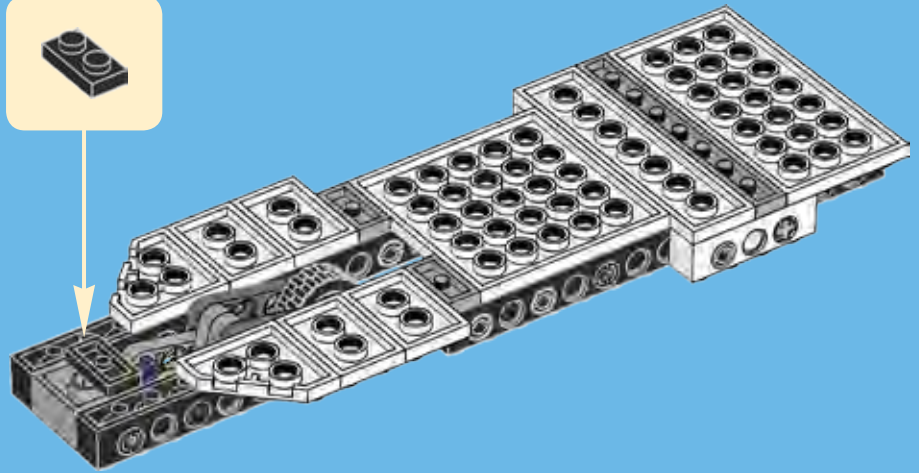

1x



2x

11

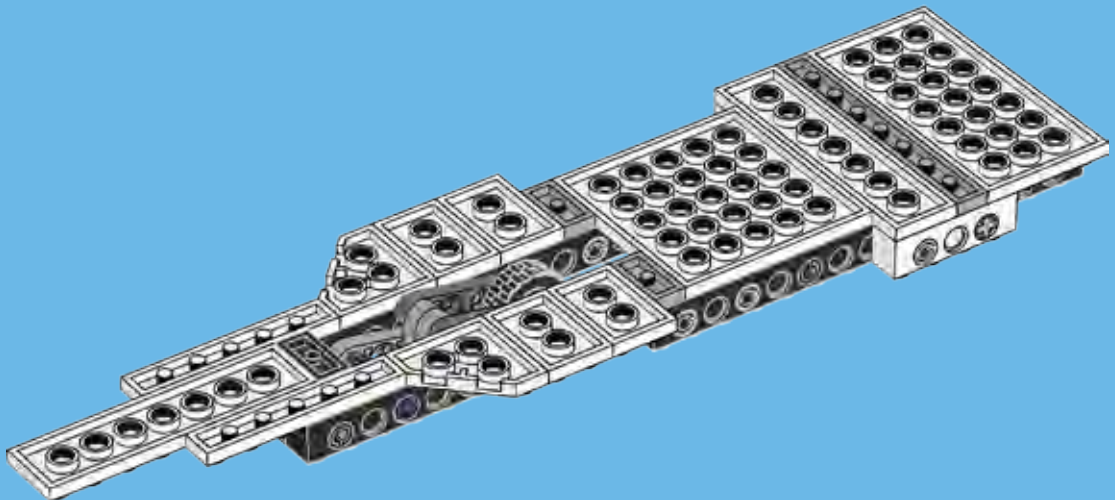

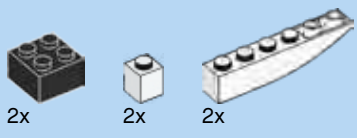

12

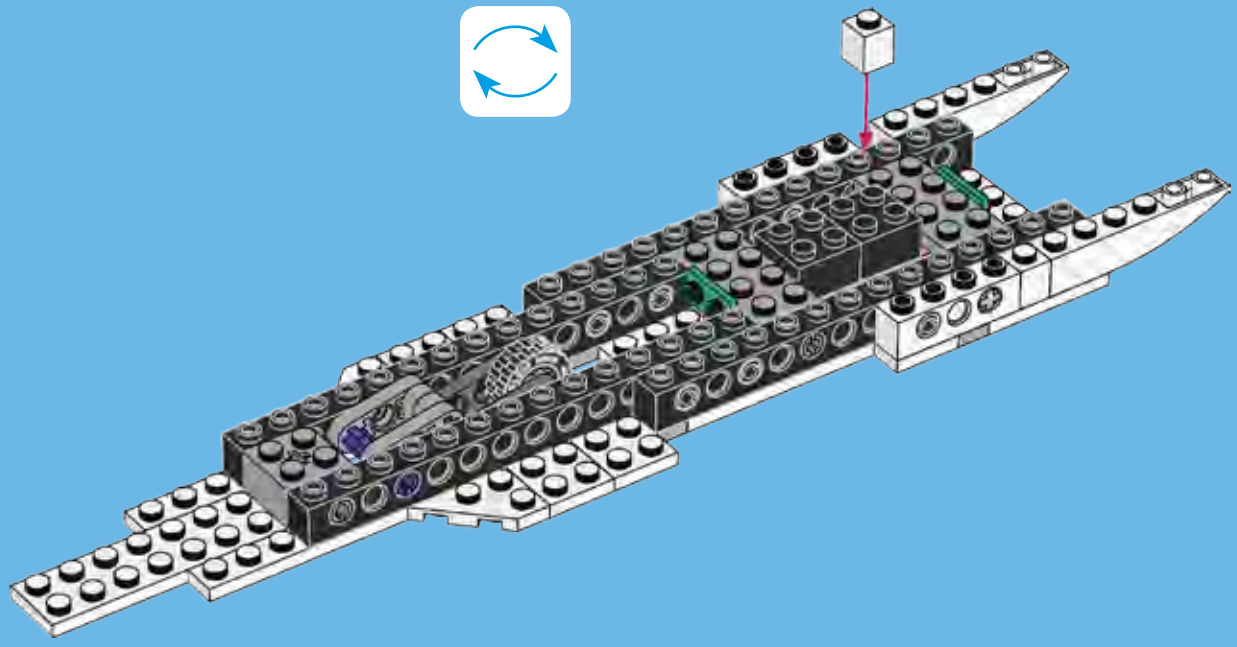



2x



1x



2x

13

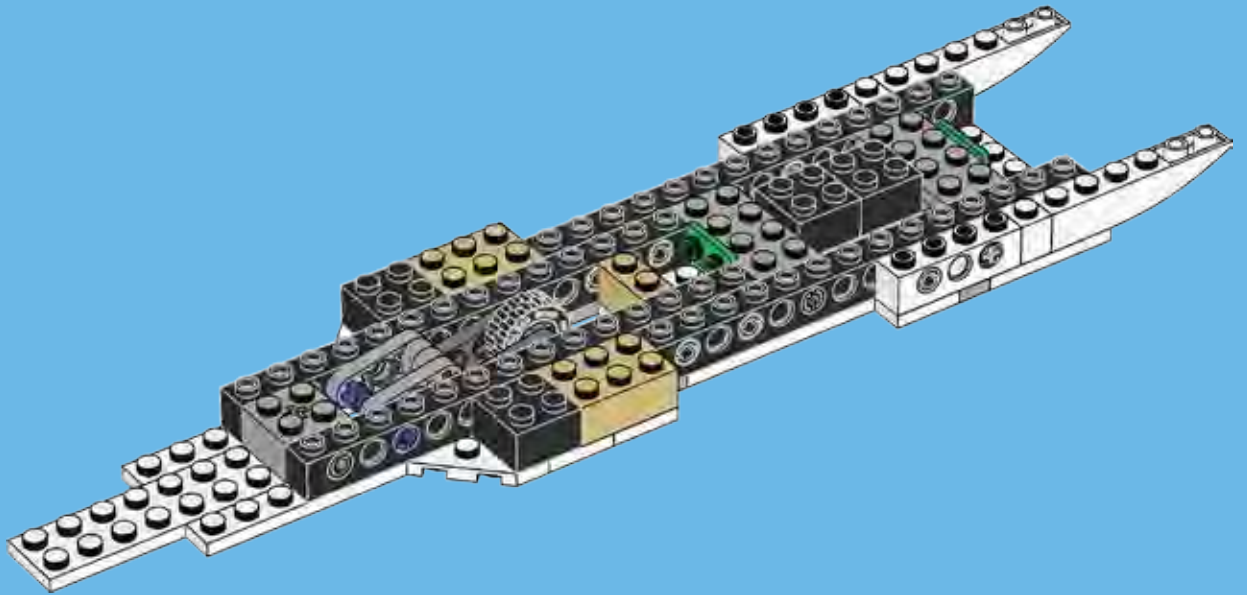

4x



1x

14

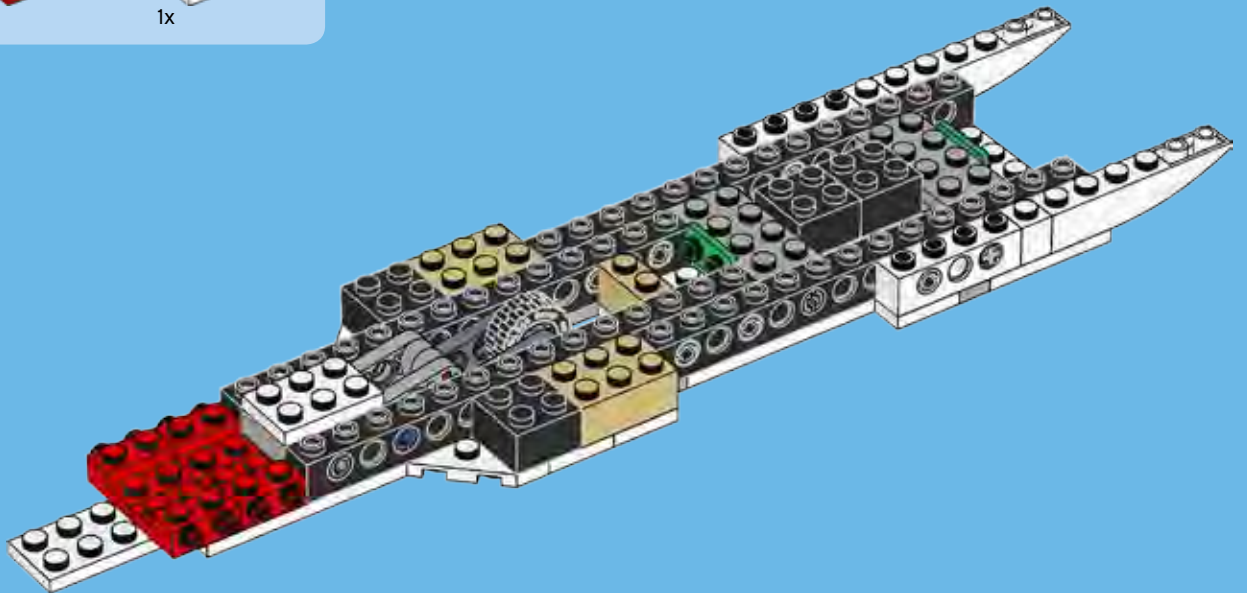



2x

15

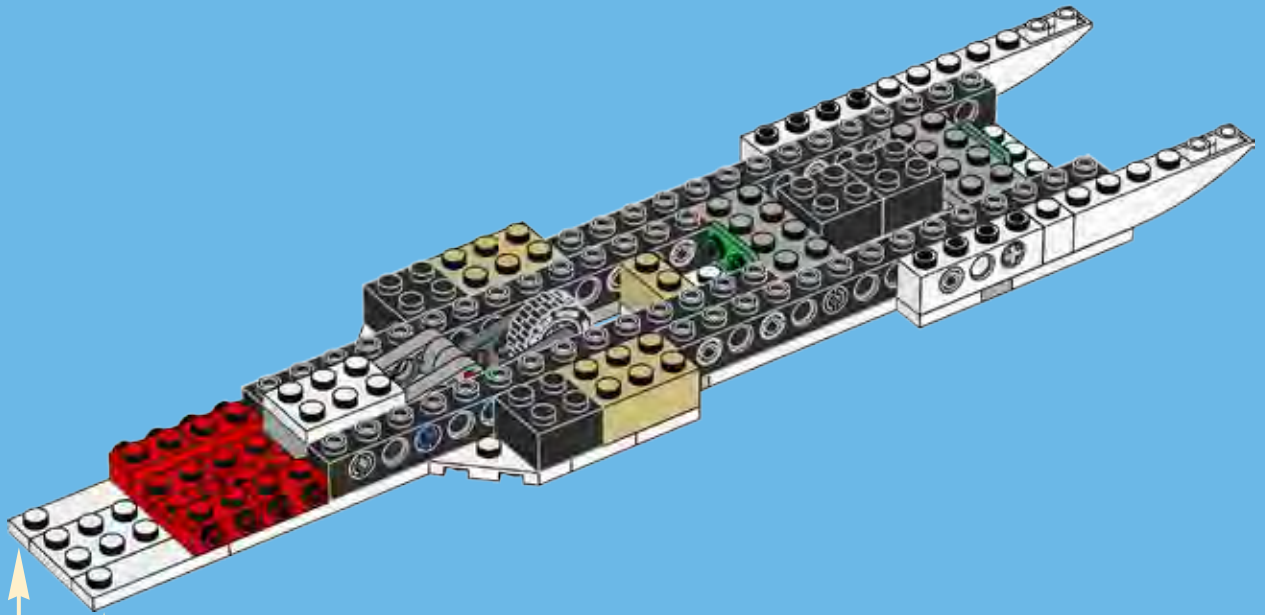

2x



1x

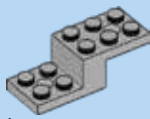

1x

18

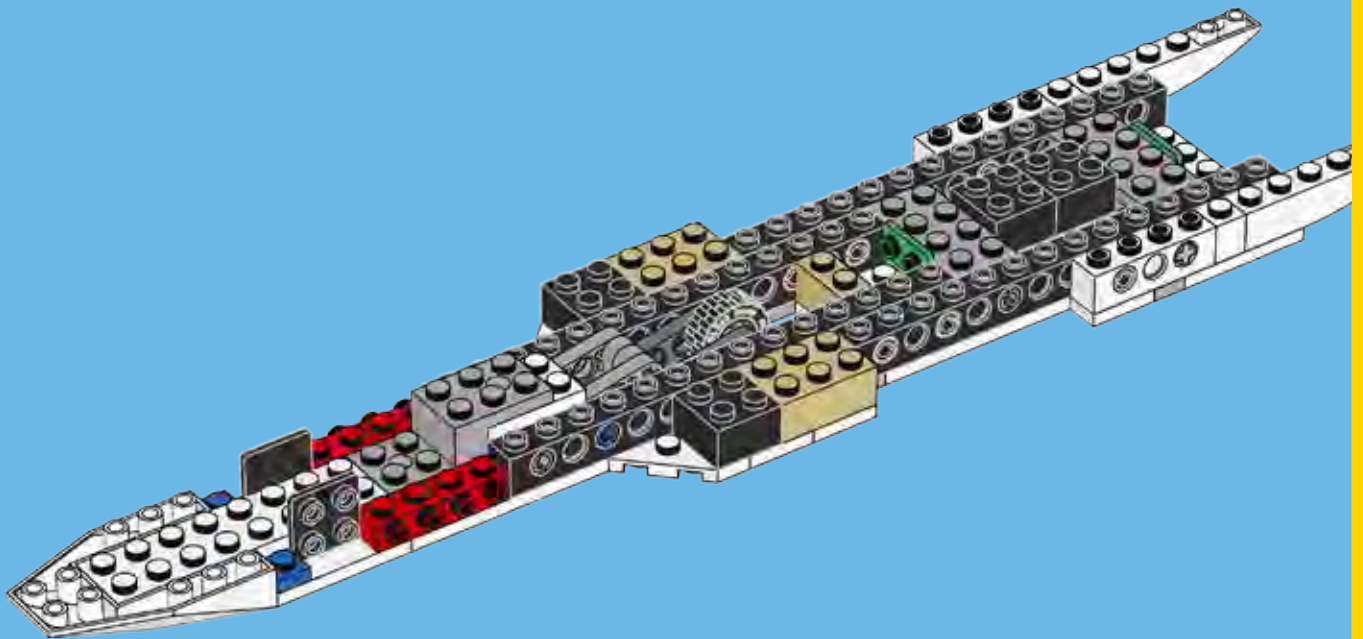



2x



2x



2x



1x



1x

19

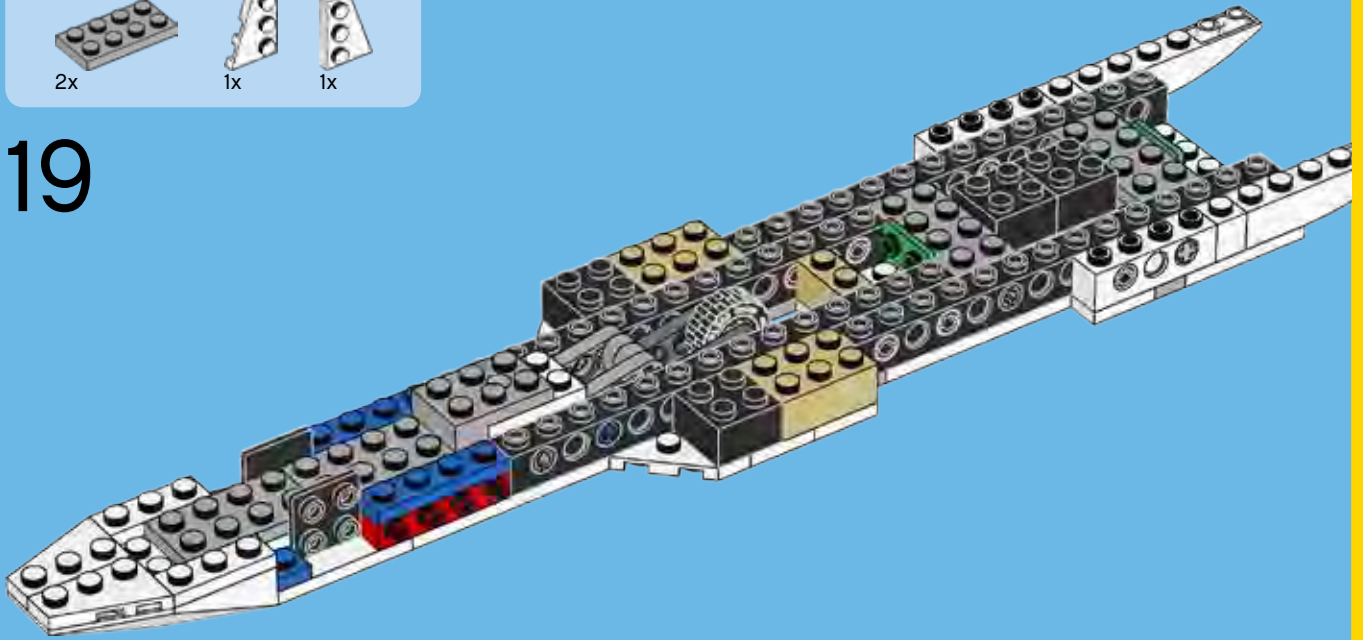

2x



2x



2x



1x



2x

20

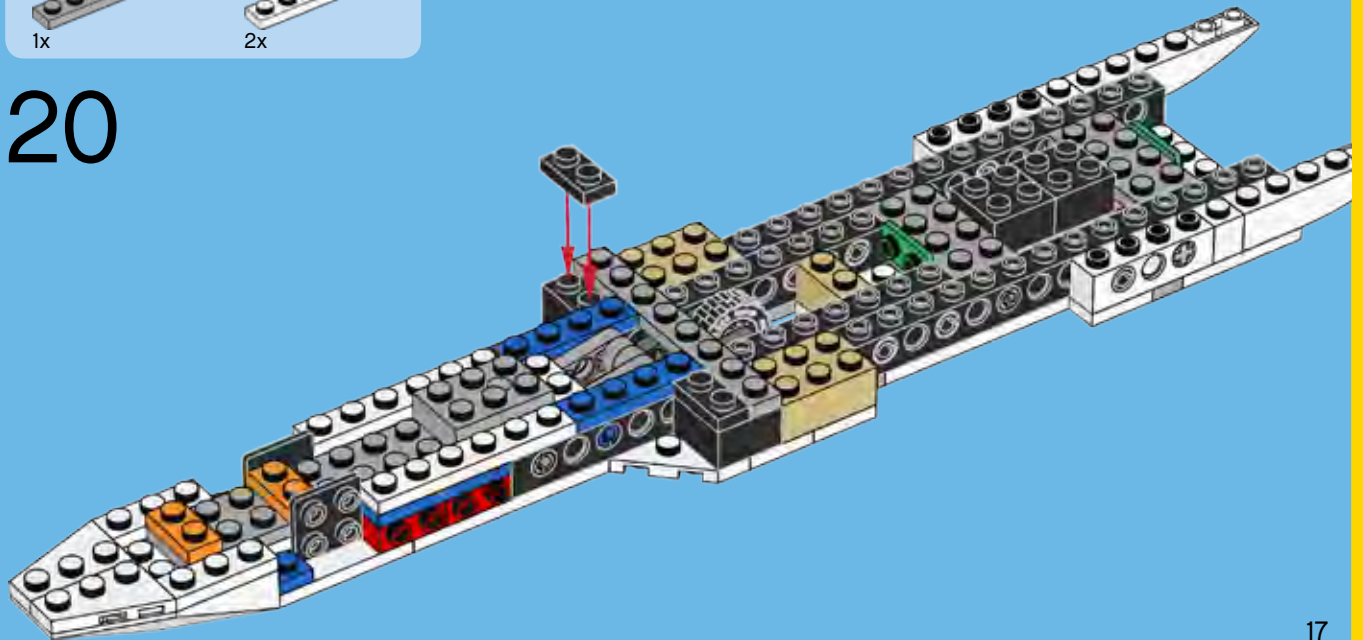

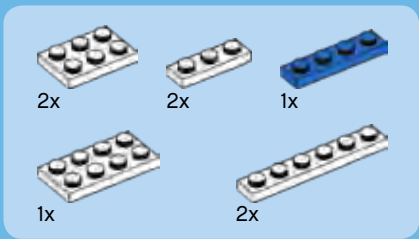

21

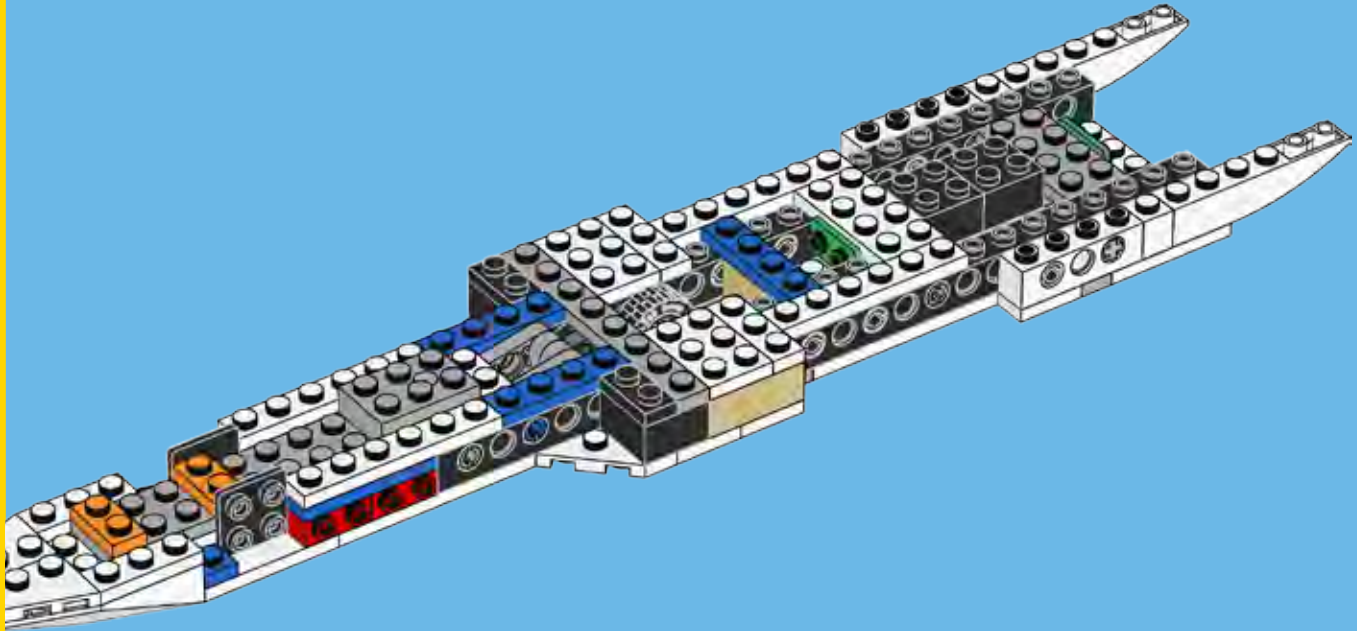

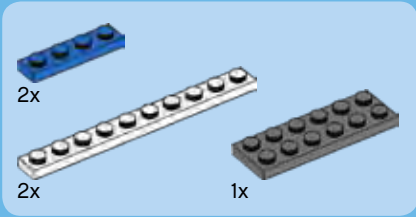

22

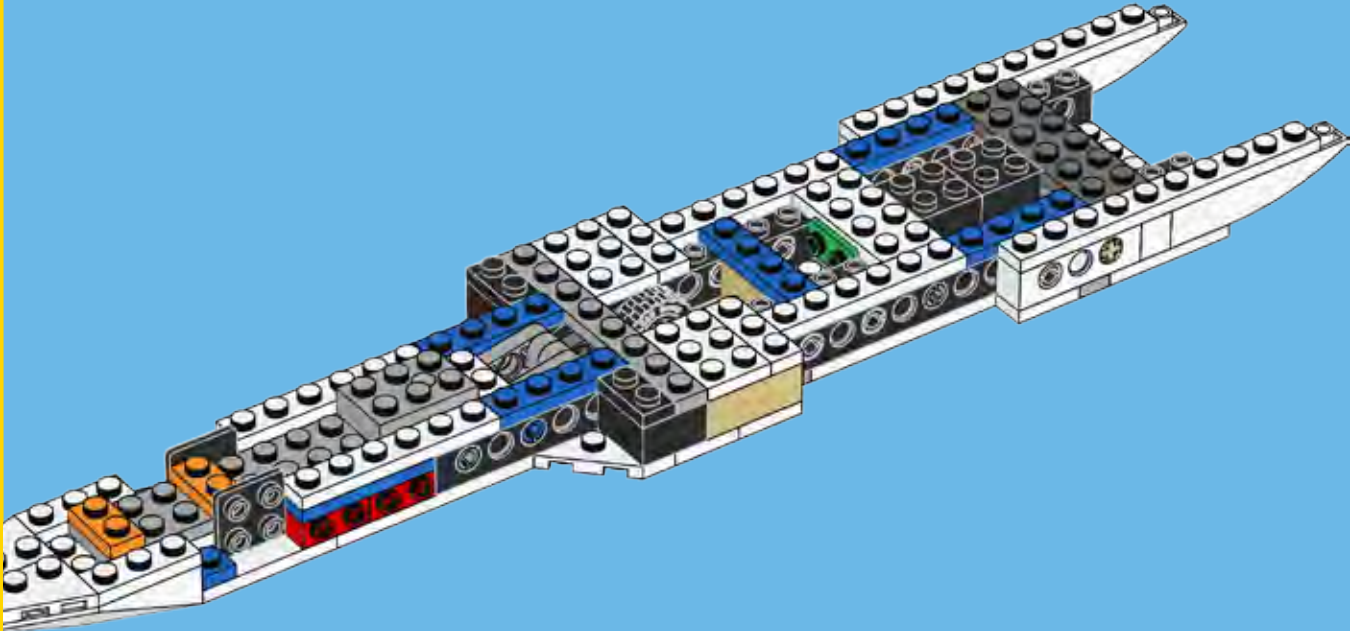

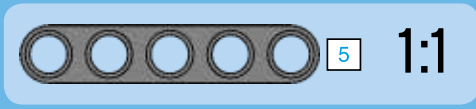

23

1

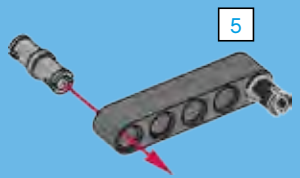

2

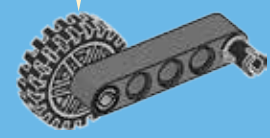
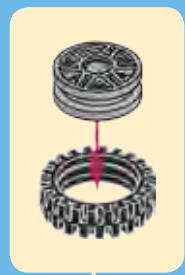

2x

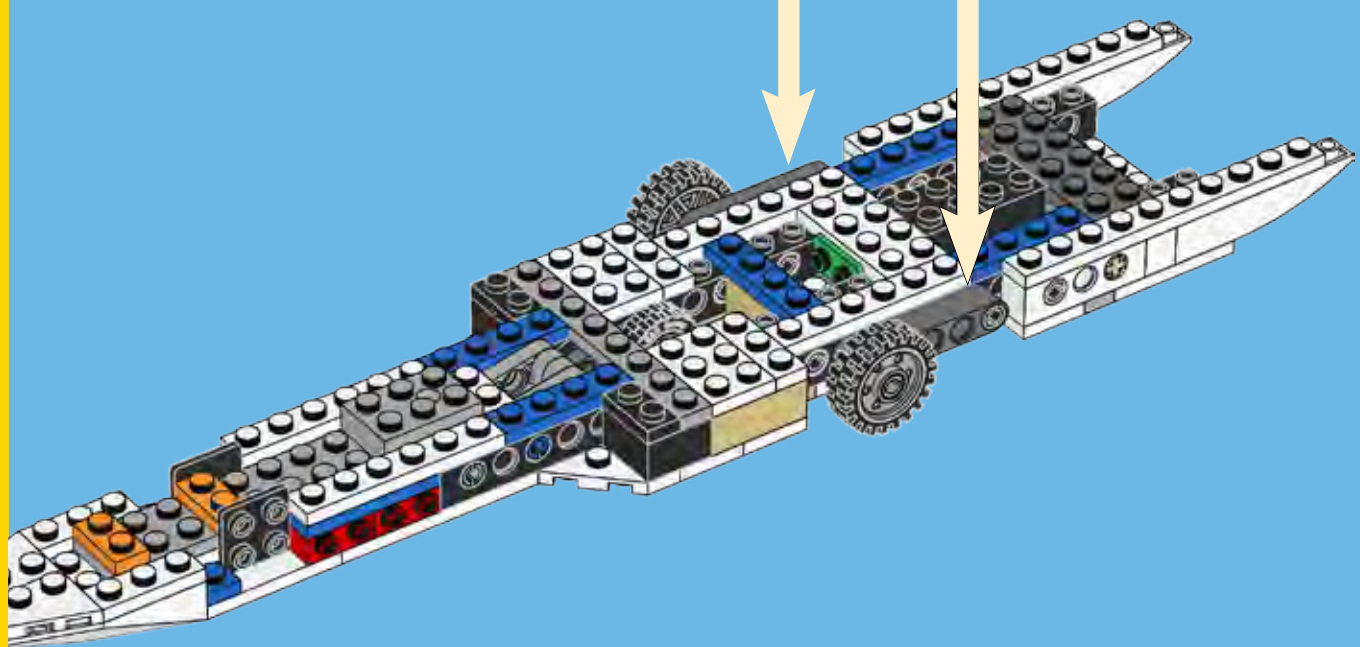



2x



1x



1x



4x



2x

24

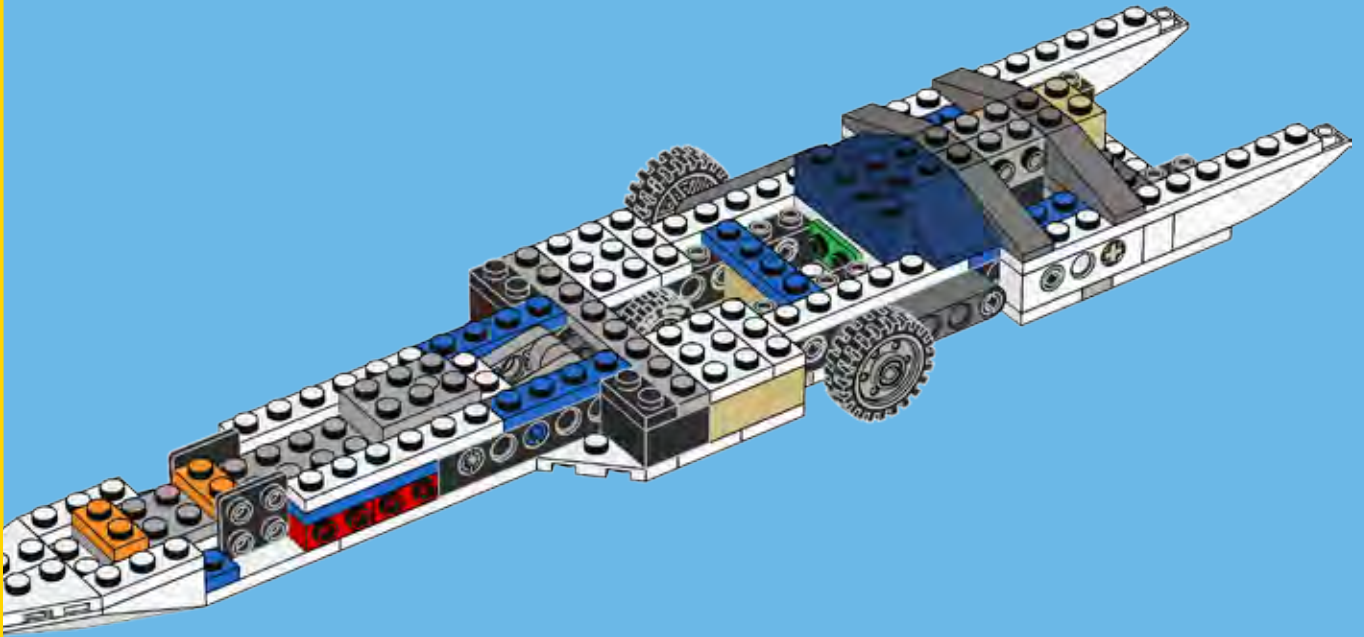

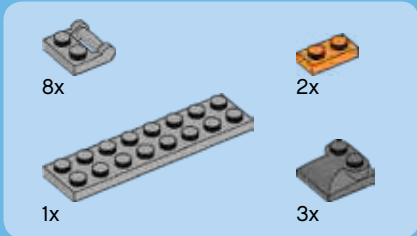

25

1

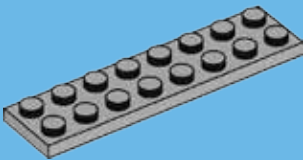

2

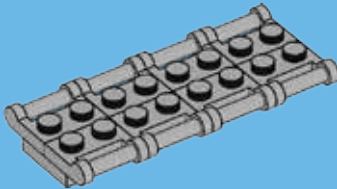

3

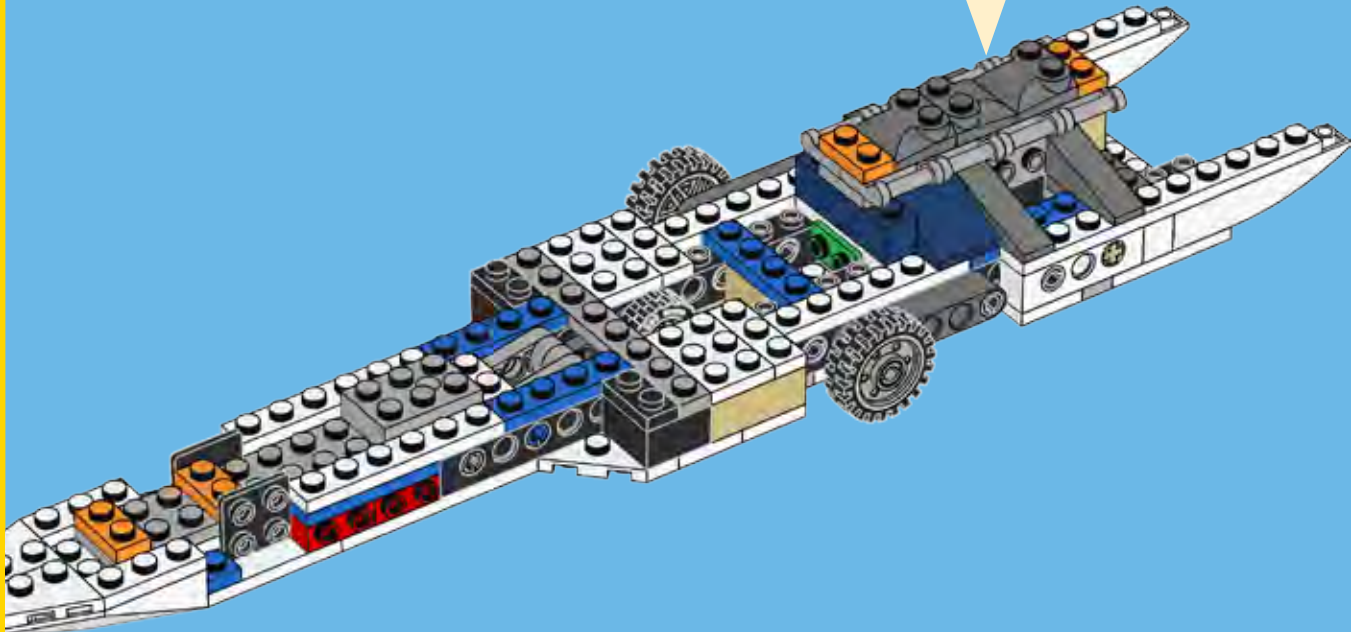
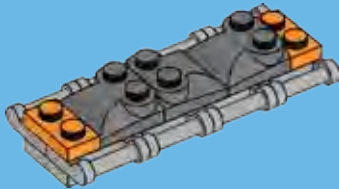



2x

26

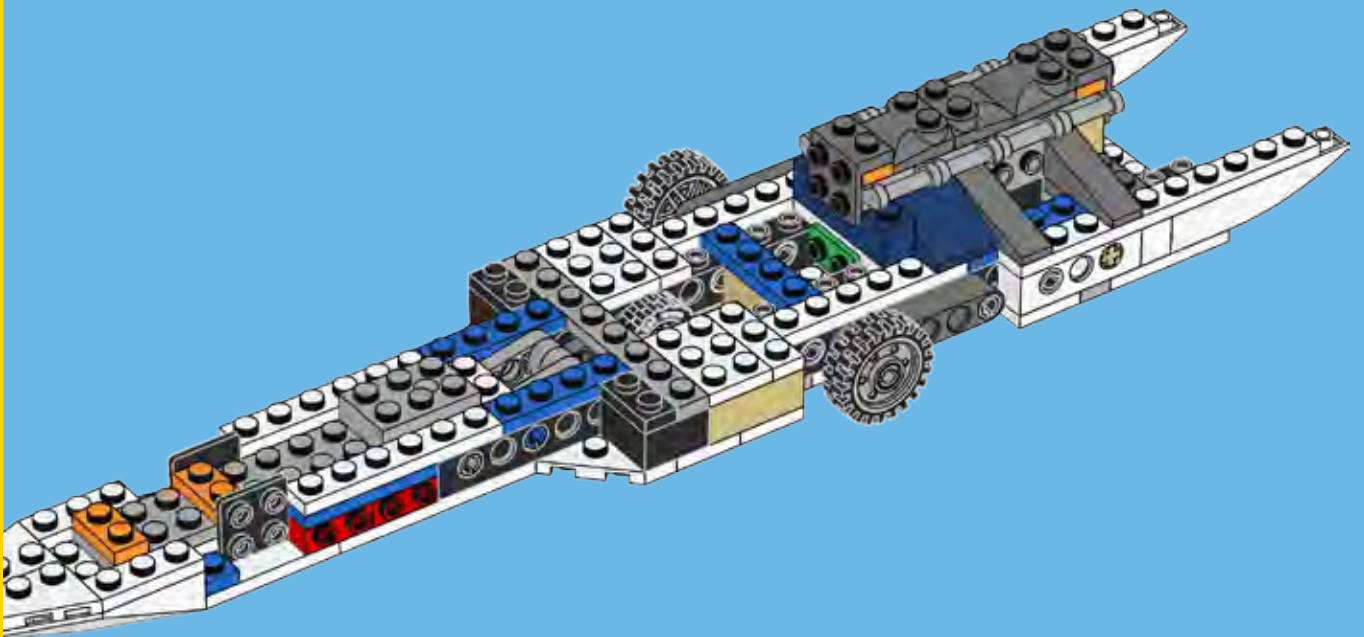



2x



2x

27

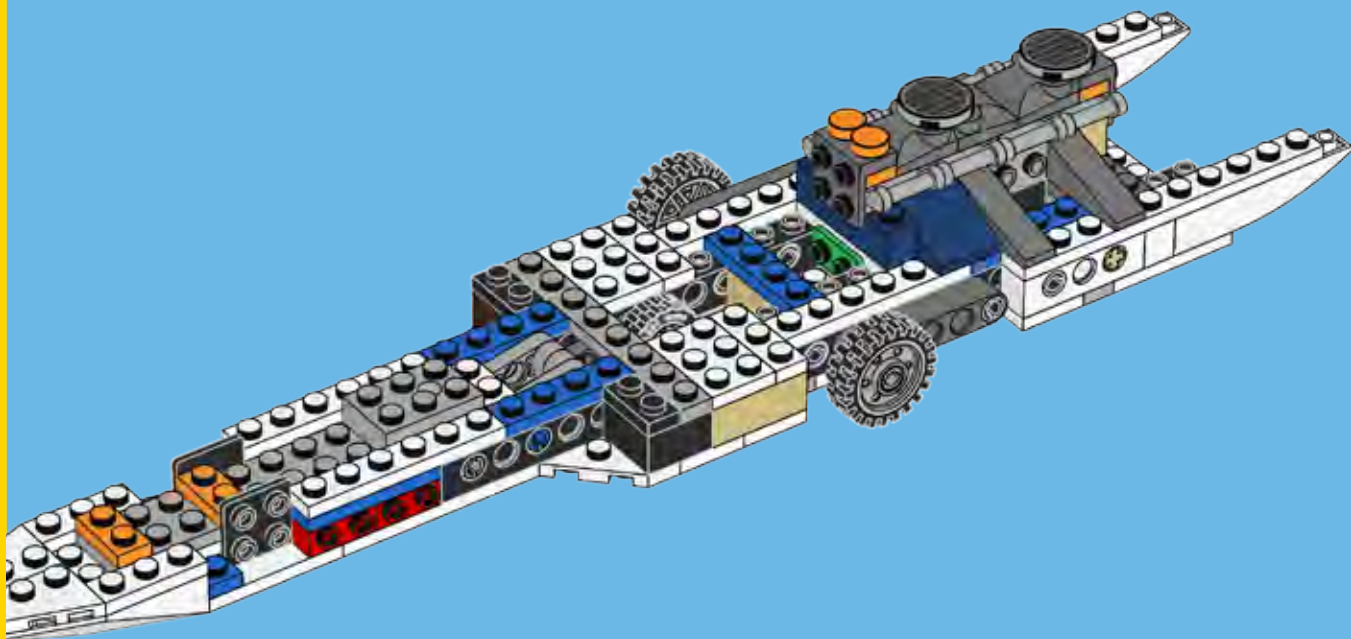

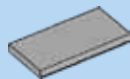

2x

28

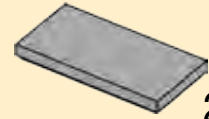

2x

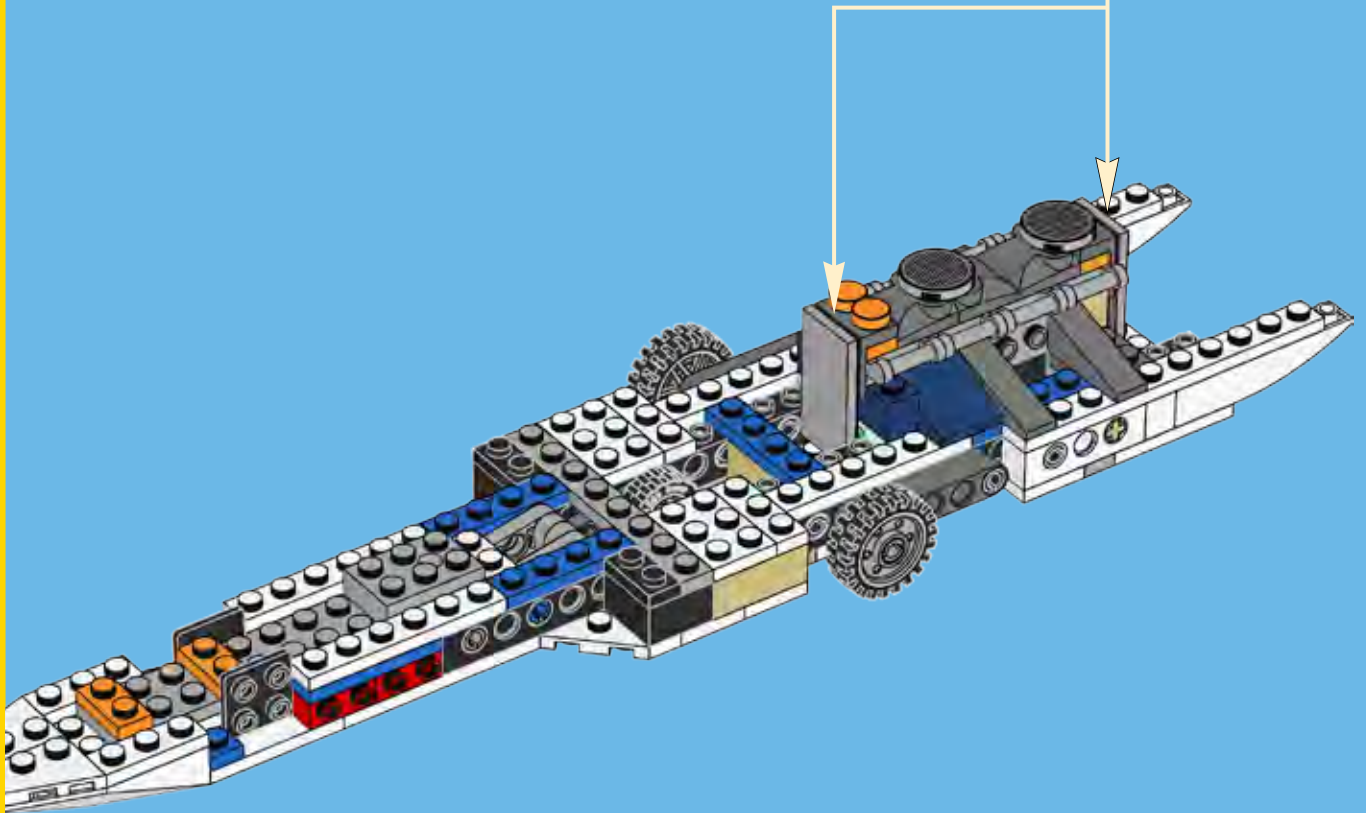

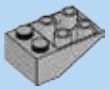

1x



1x

29

1

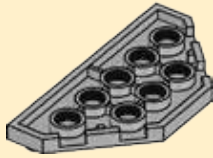

2

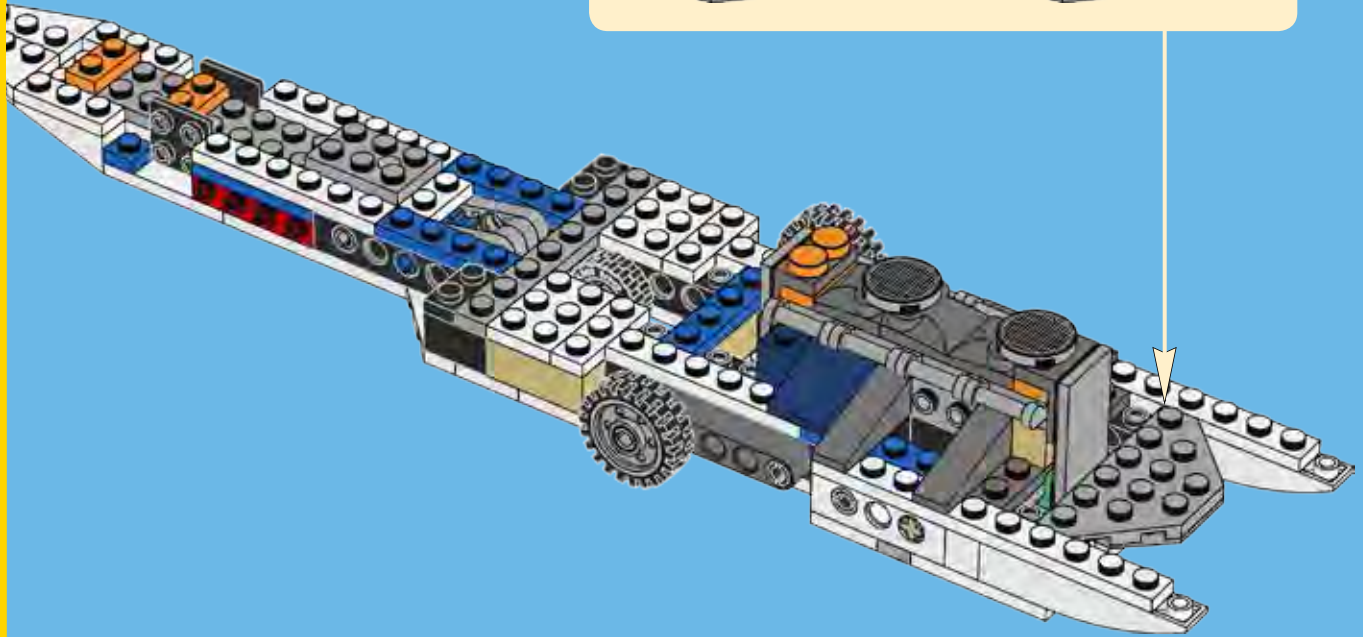
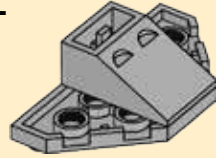

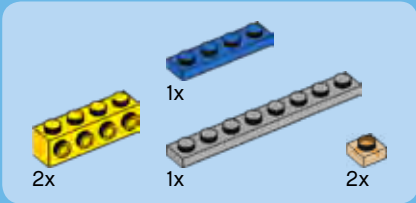

30

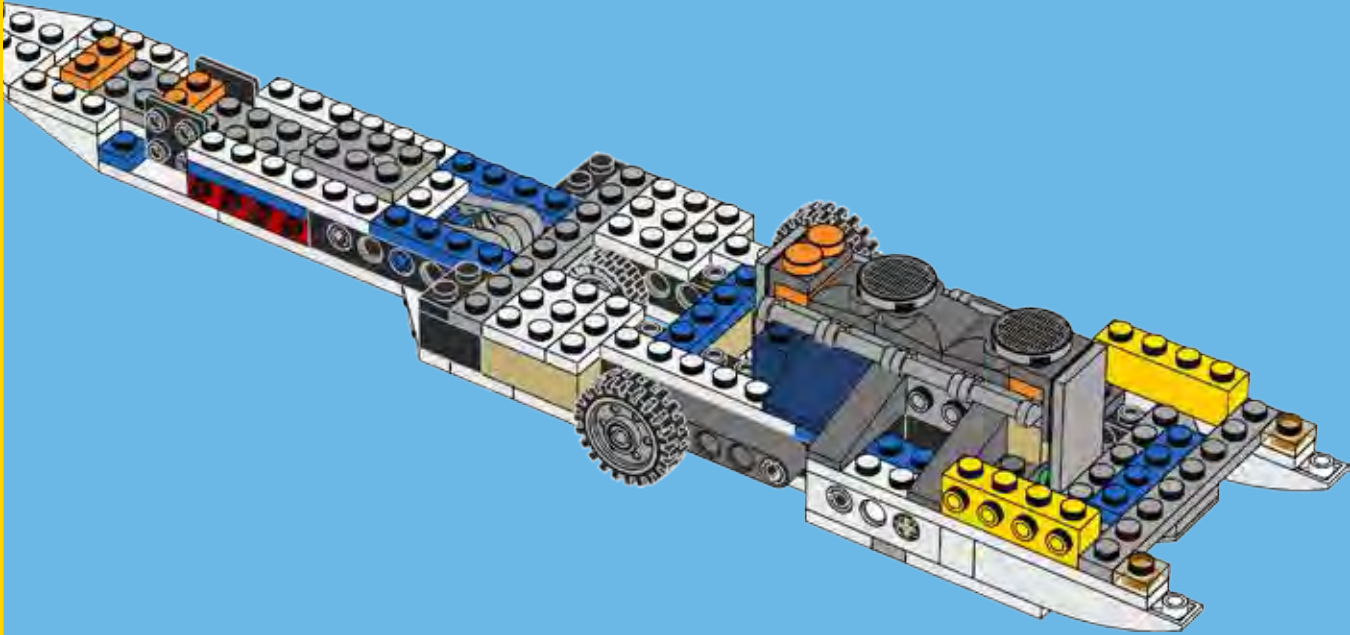



2x



2x



1x

31

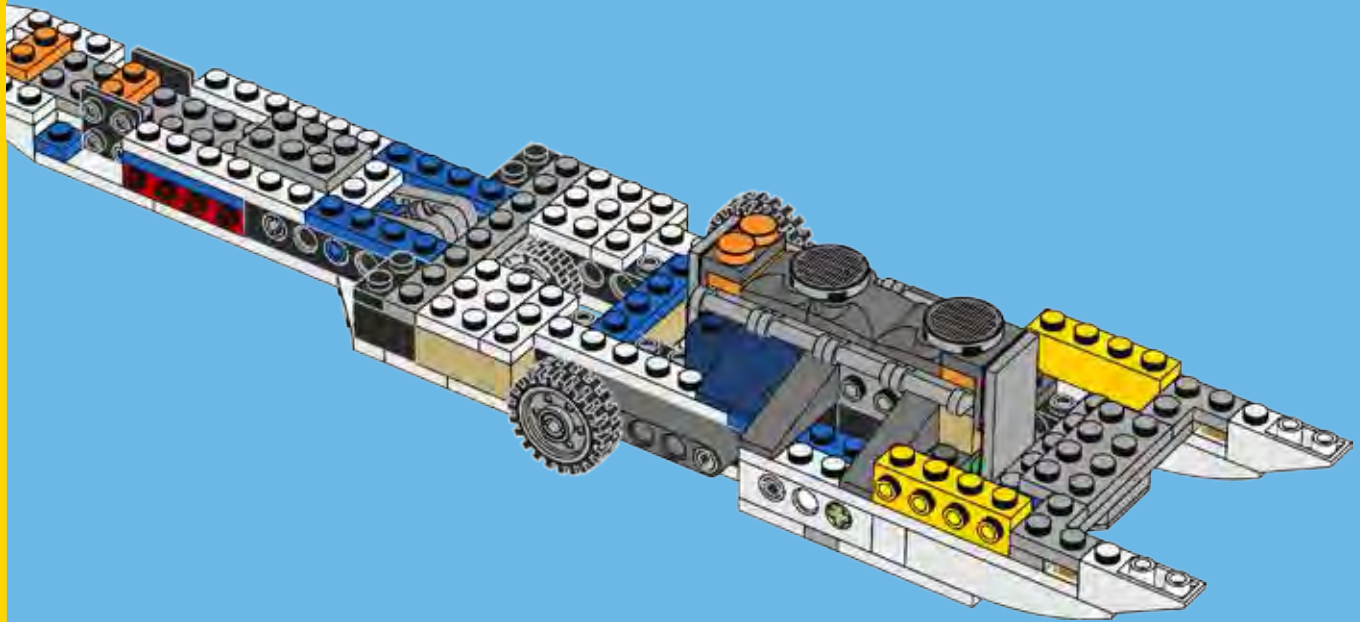



2x



2x

32

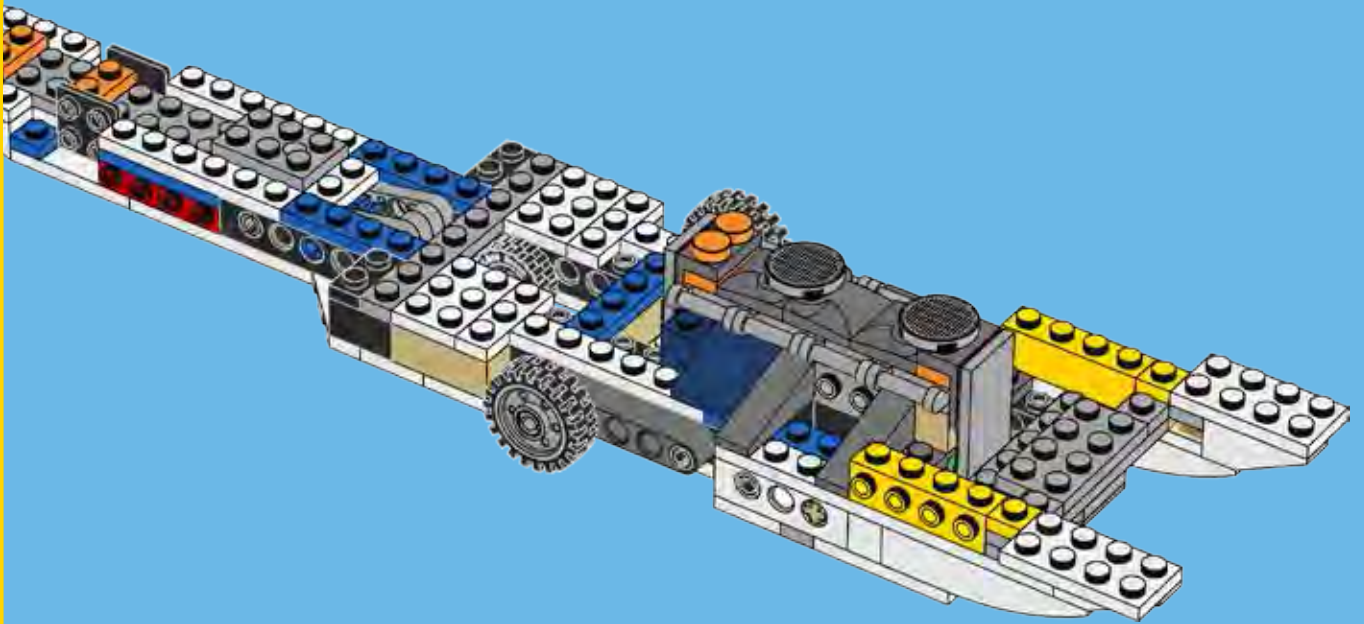



2x



2x



1x



4x



2x



2x

33

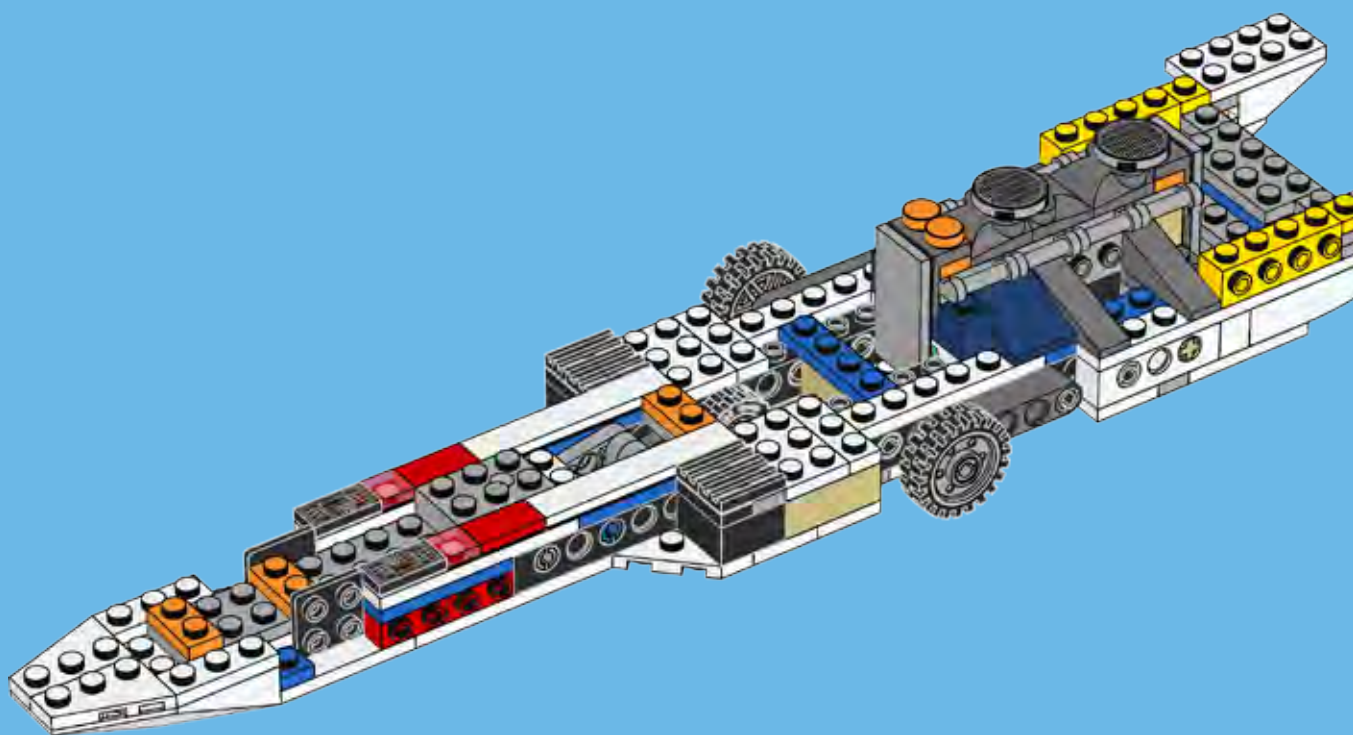



2x



2x



1x



2x

34

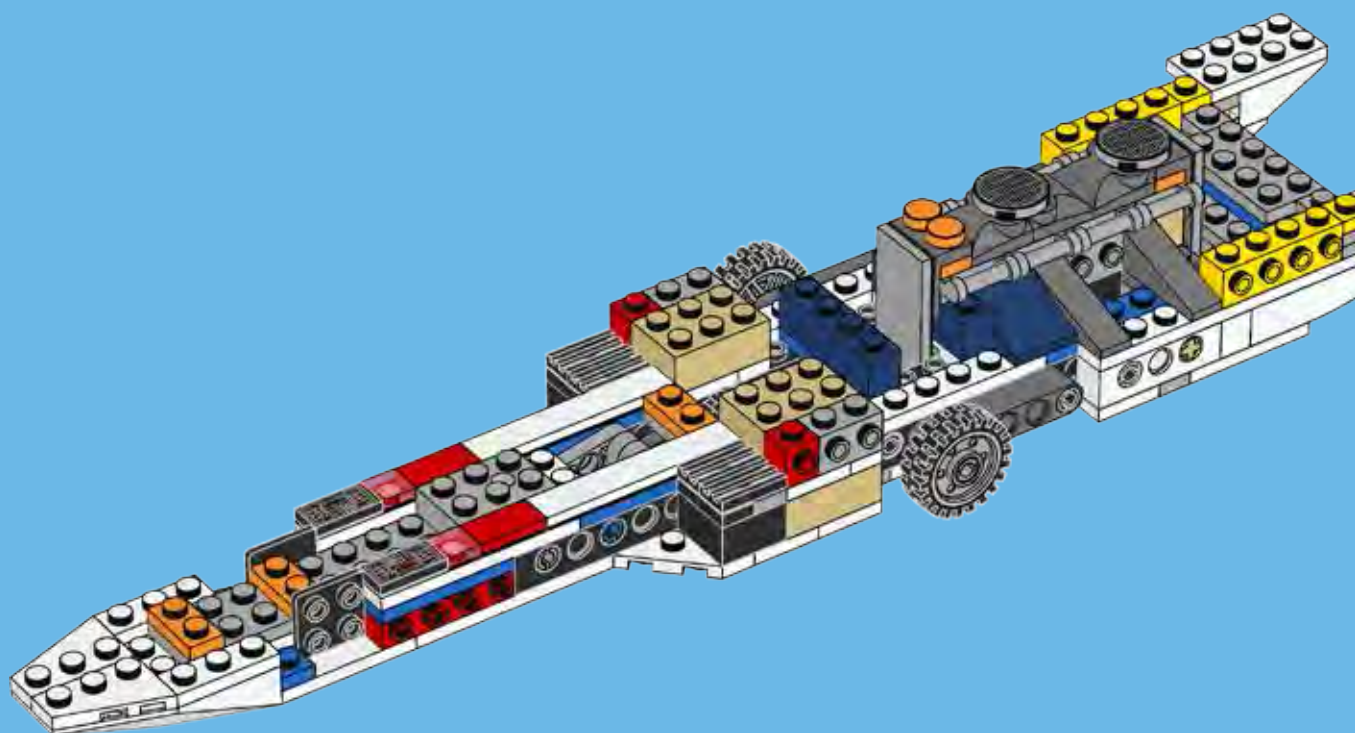



8x

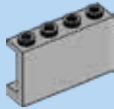

2x

35

1

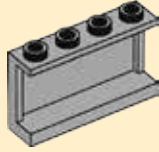

2



2x

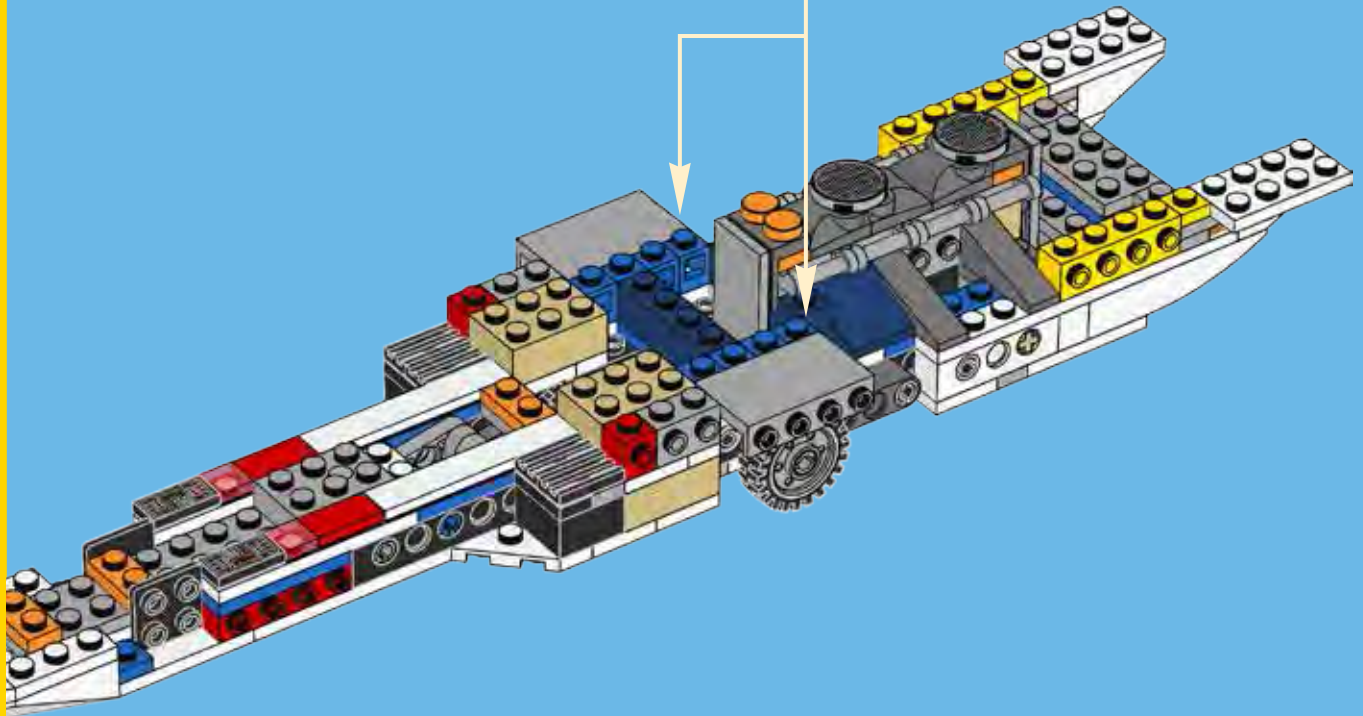



2x



2x



2x

36

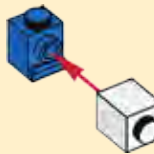

2x

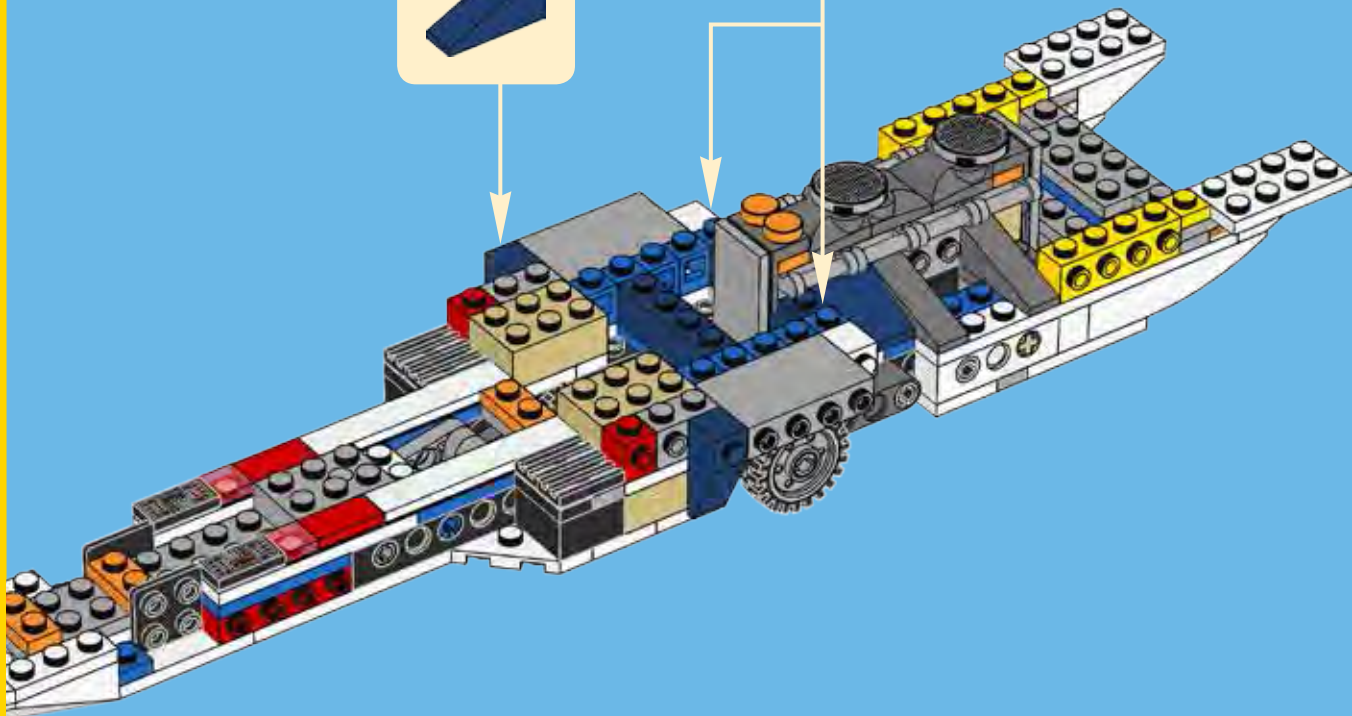

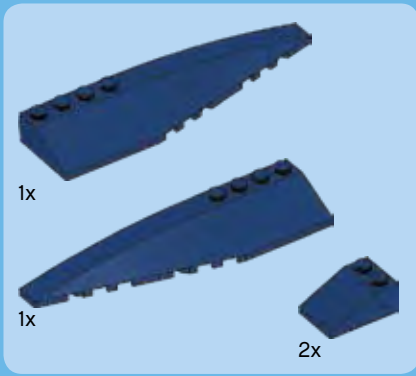

37

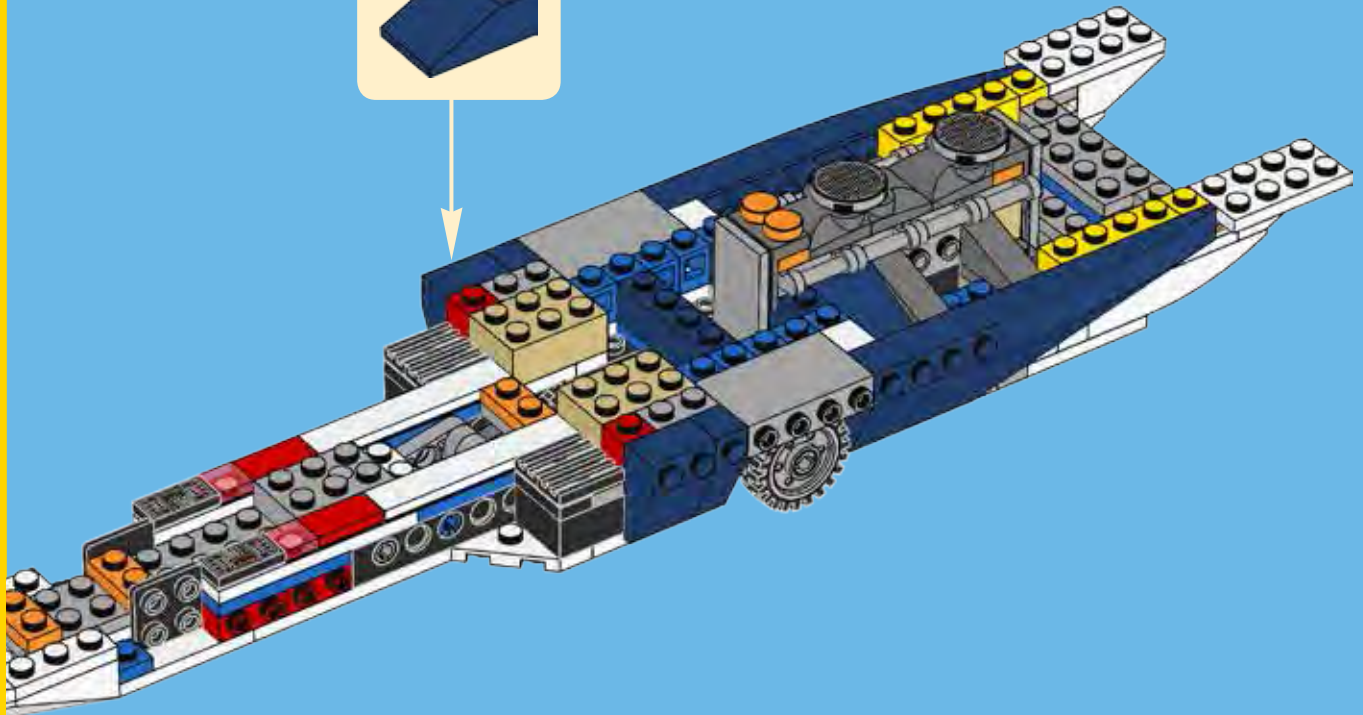



1x



1x



2x

38

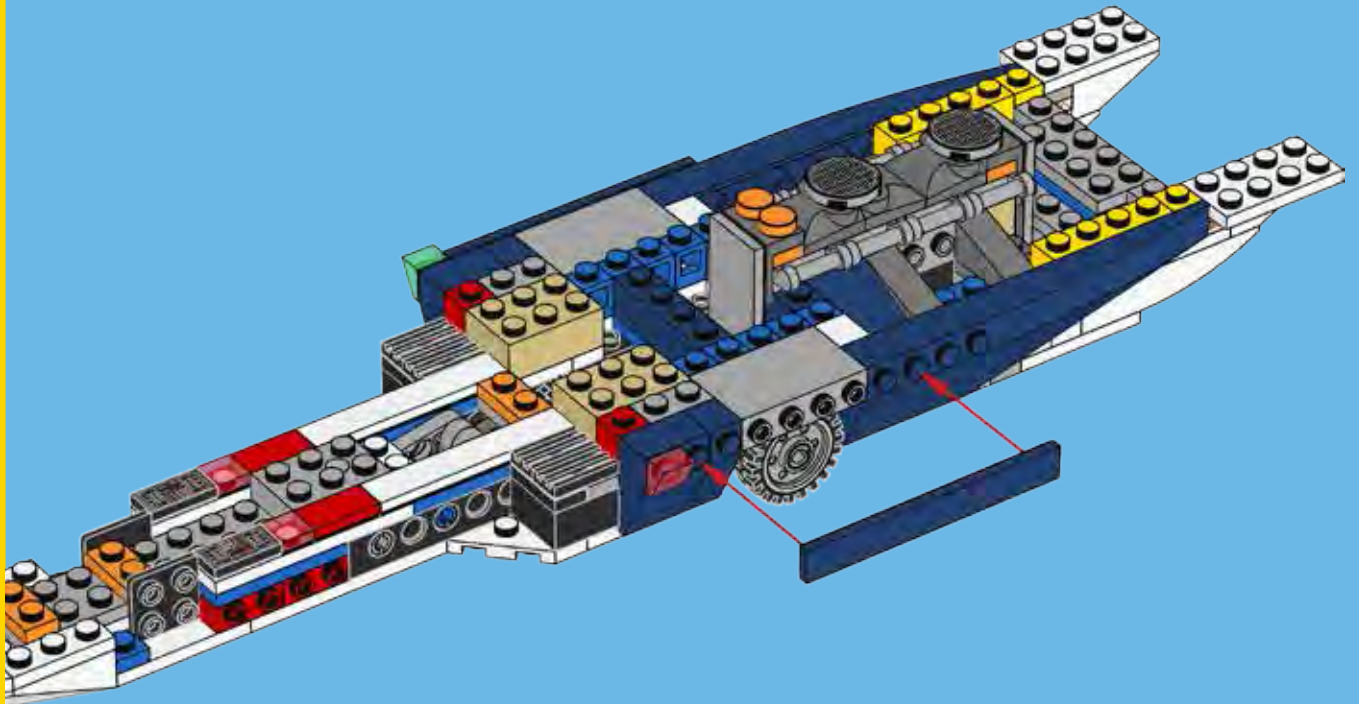



2x



4x

39

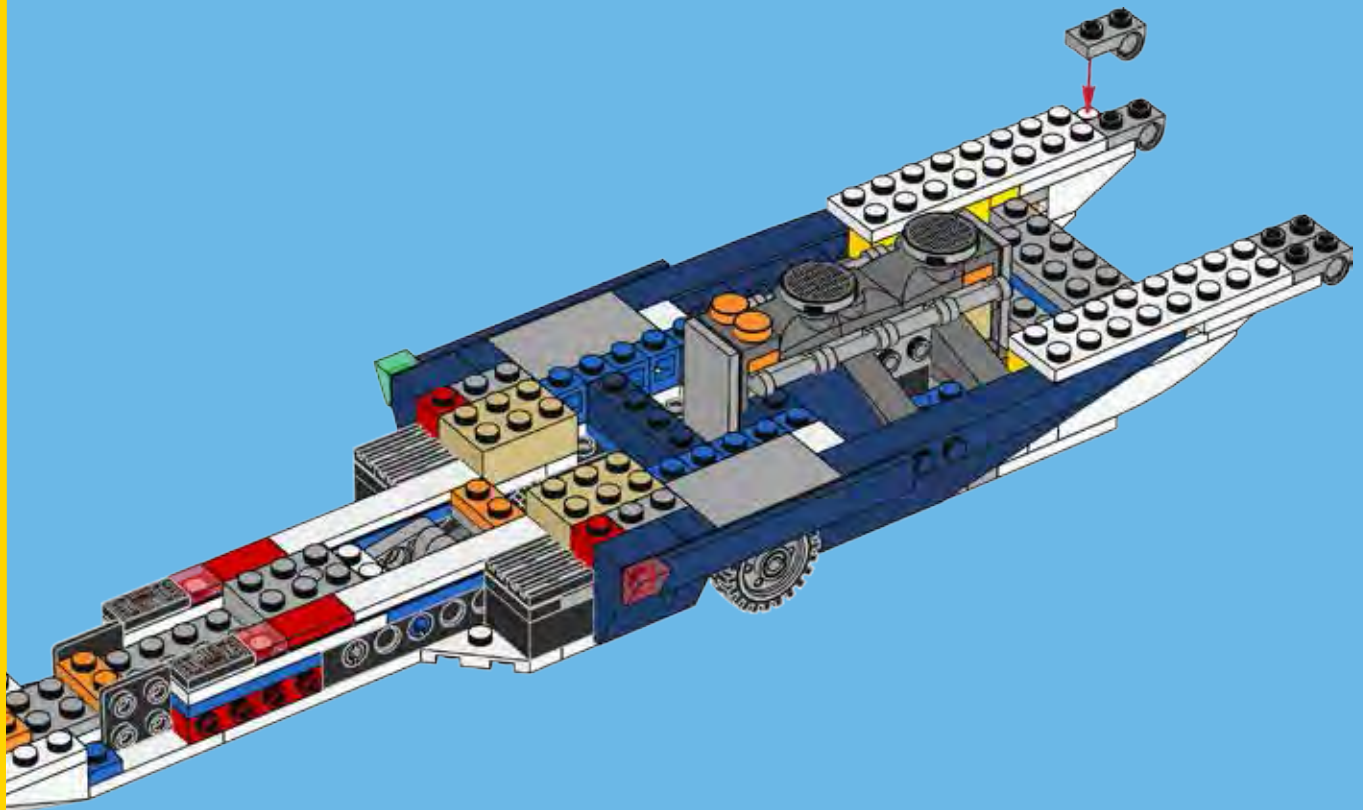



2x



4x

40

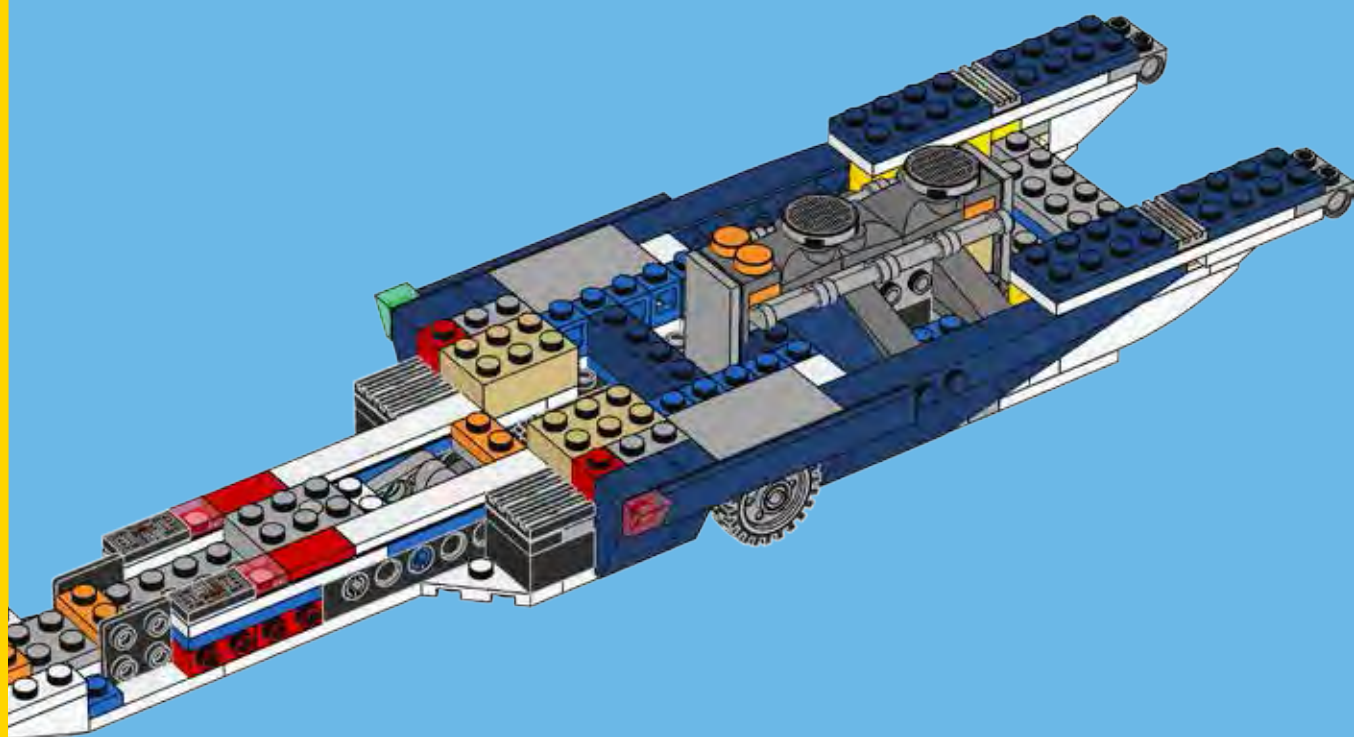



2x



2x



2x

41

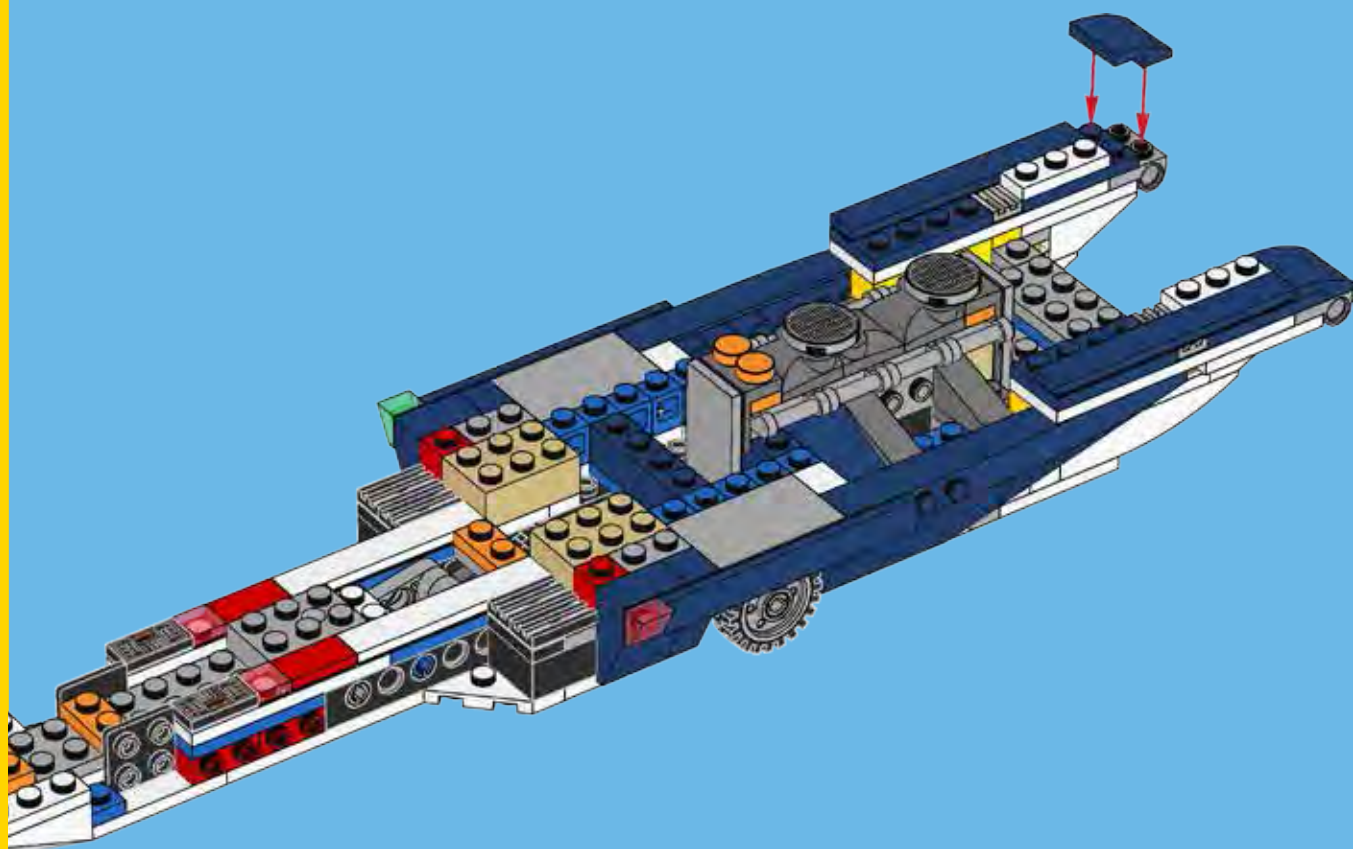

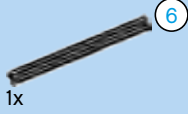

1

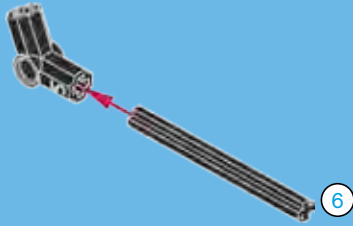

2



3

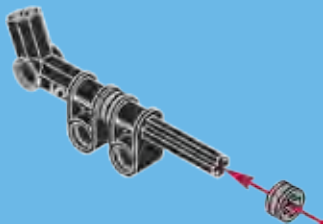

4

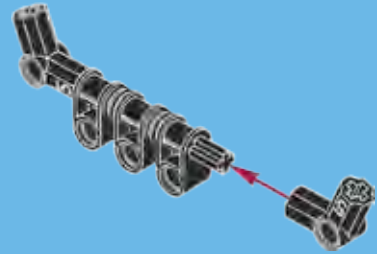

5

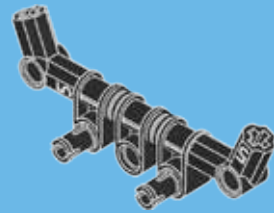

6

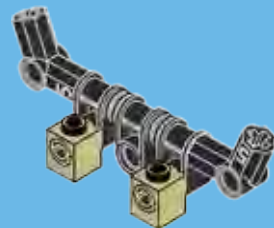

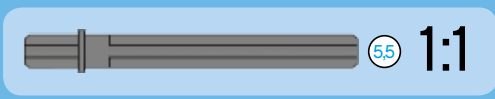
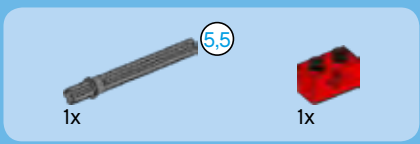

7

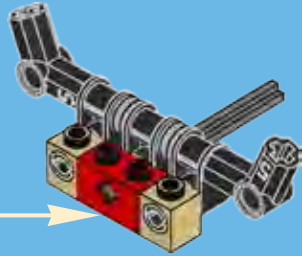
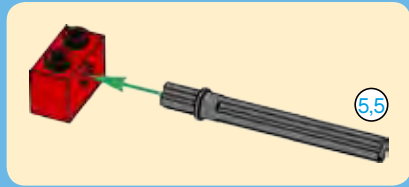

42

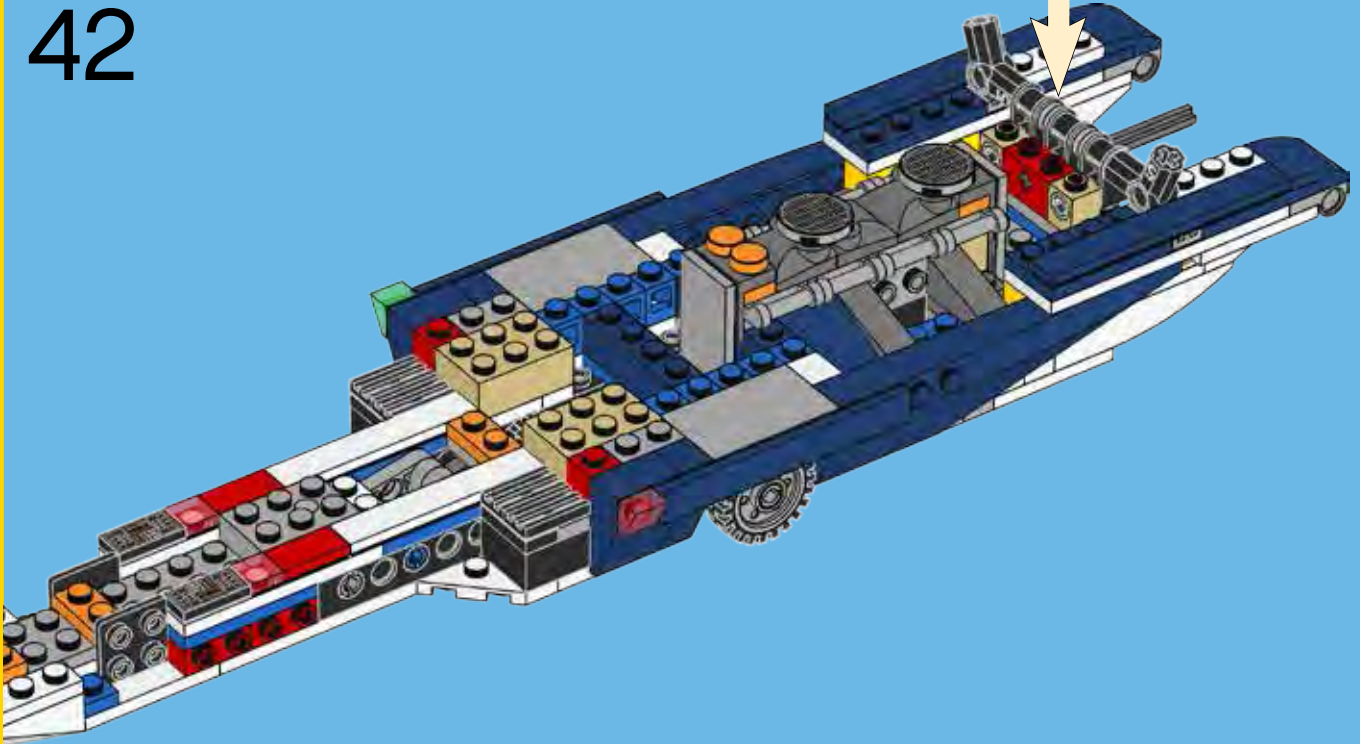



2x



2x

43

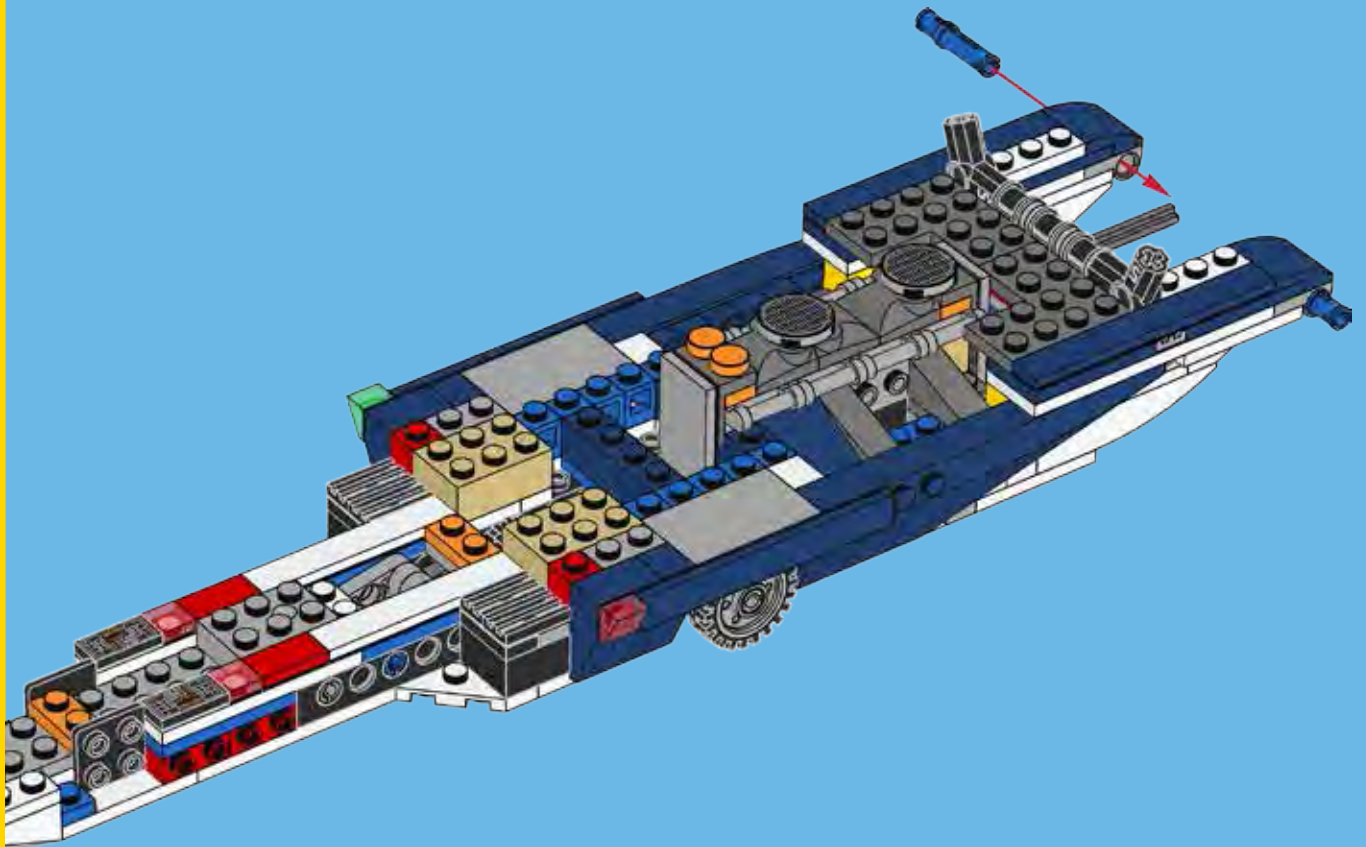

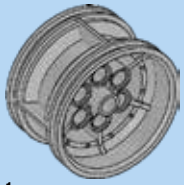

1x



1x

44

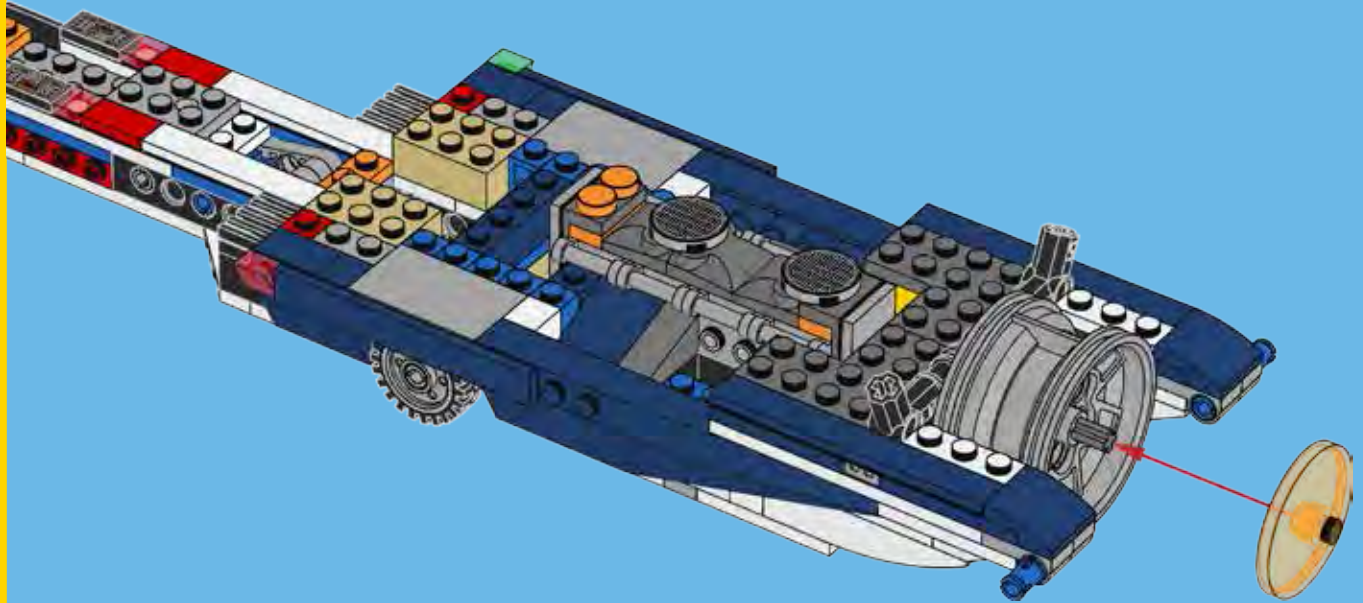



2x



4x



1x



1x

45

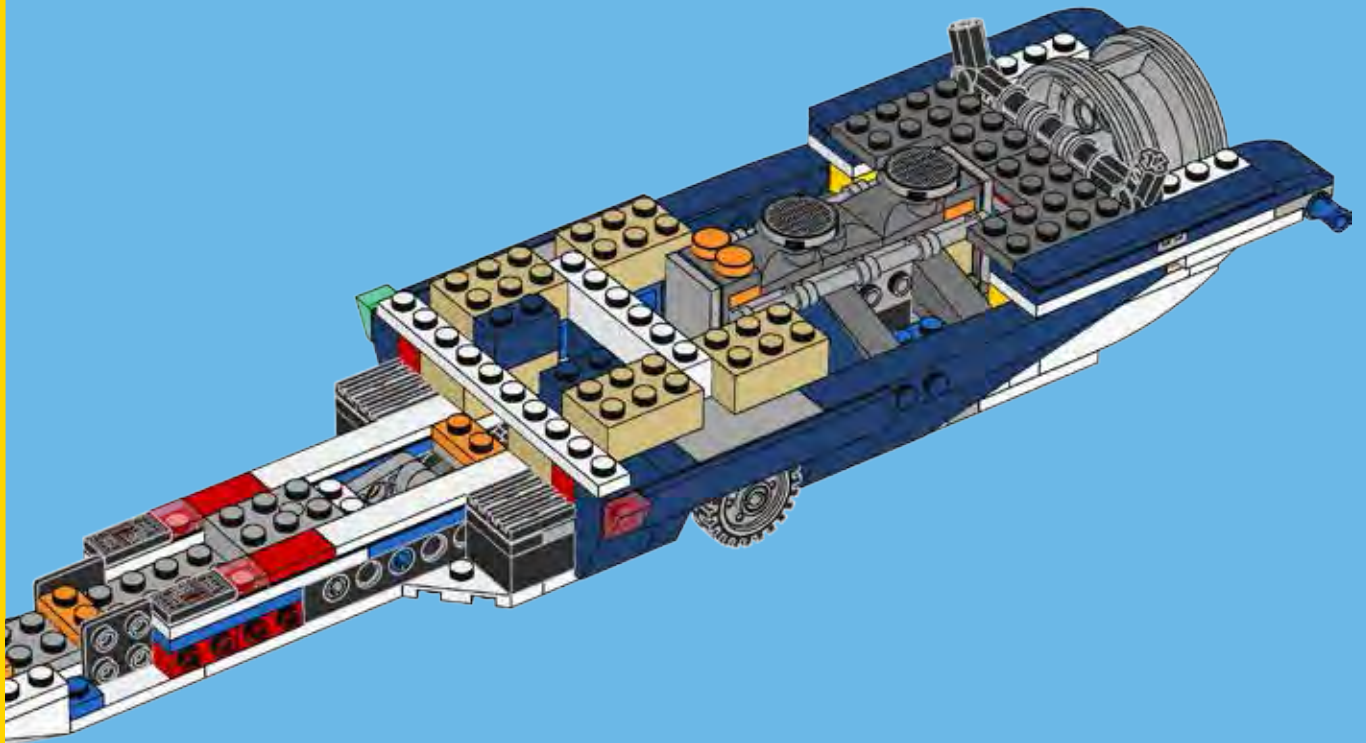



46

1



2



3



4



5

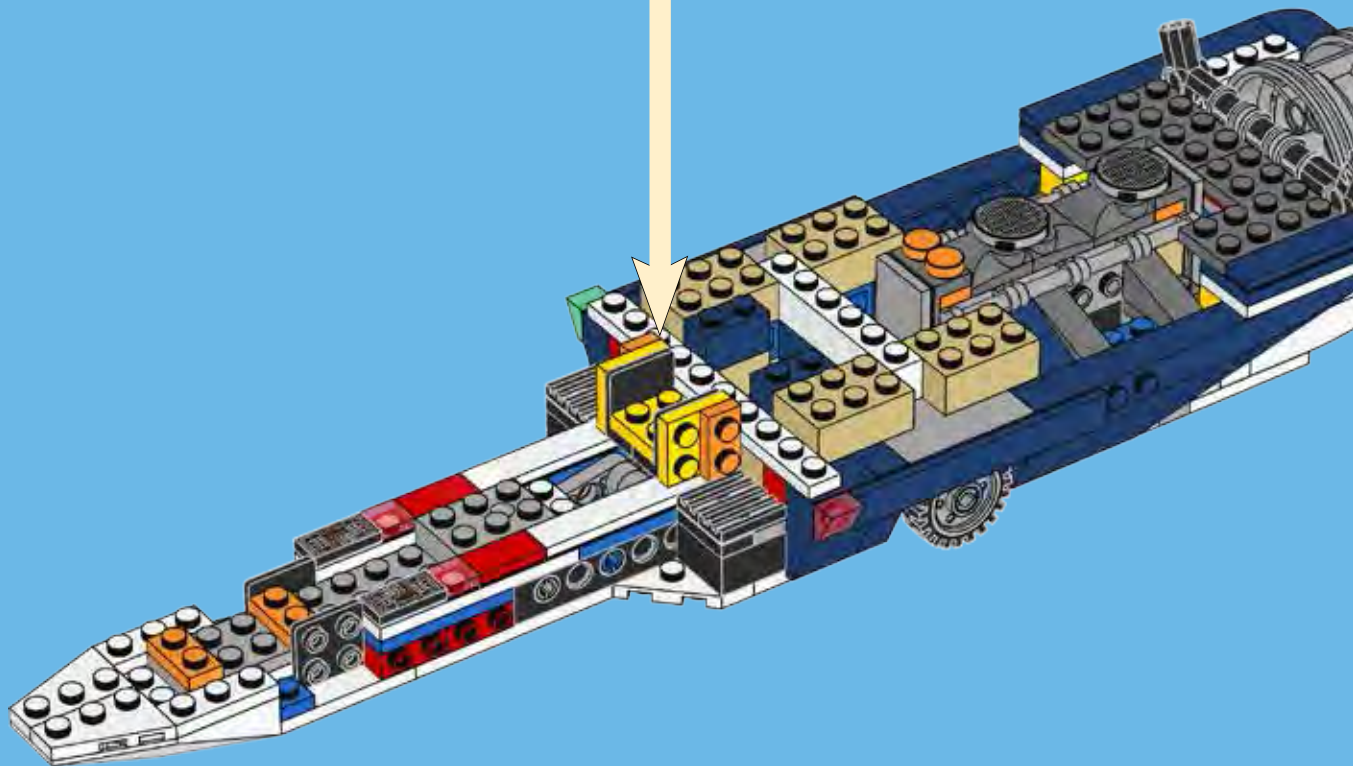

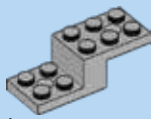

1x

47

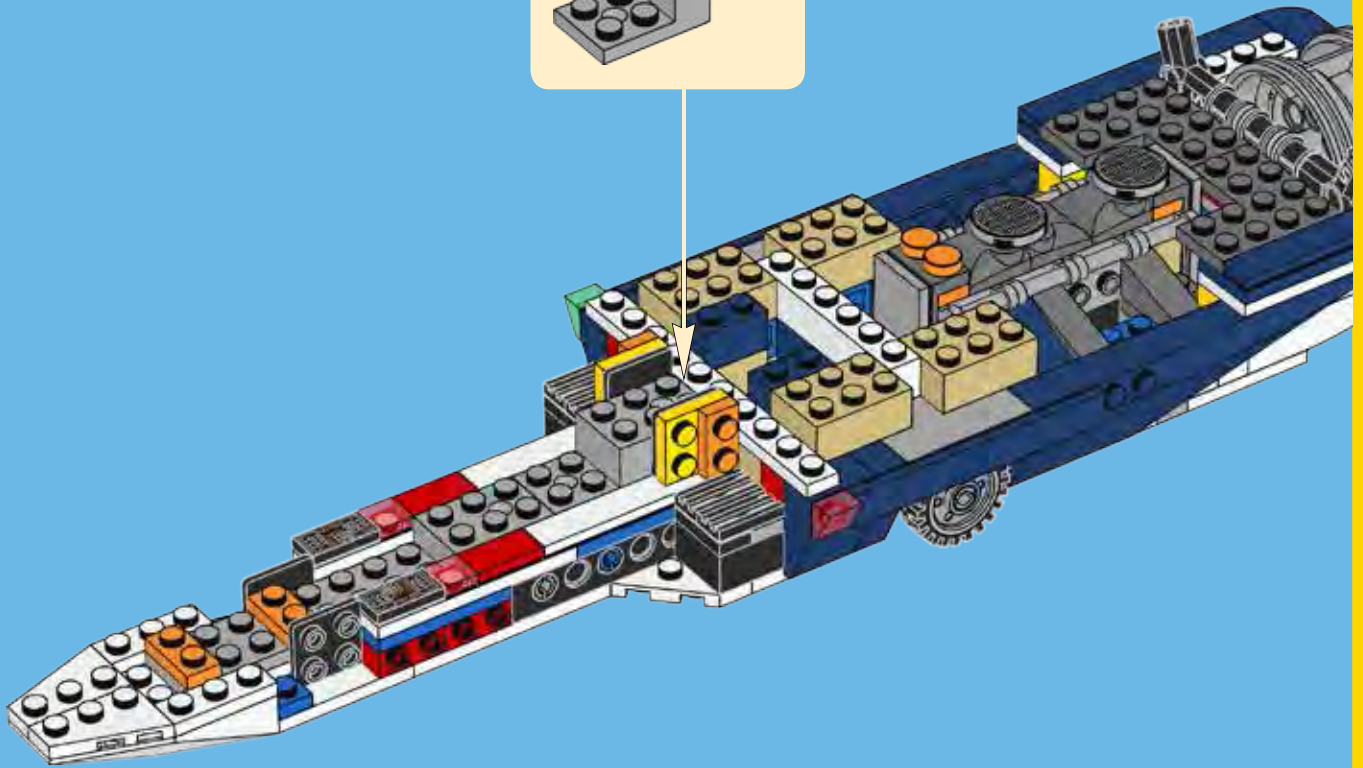
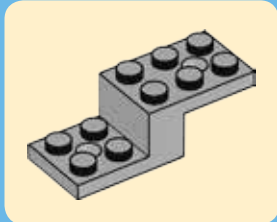



1x



1x



1x

48

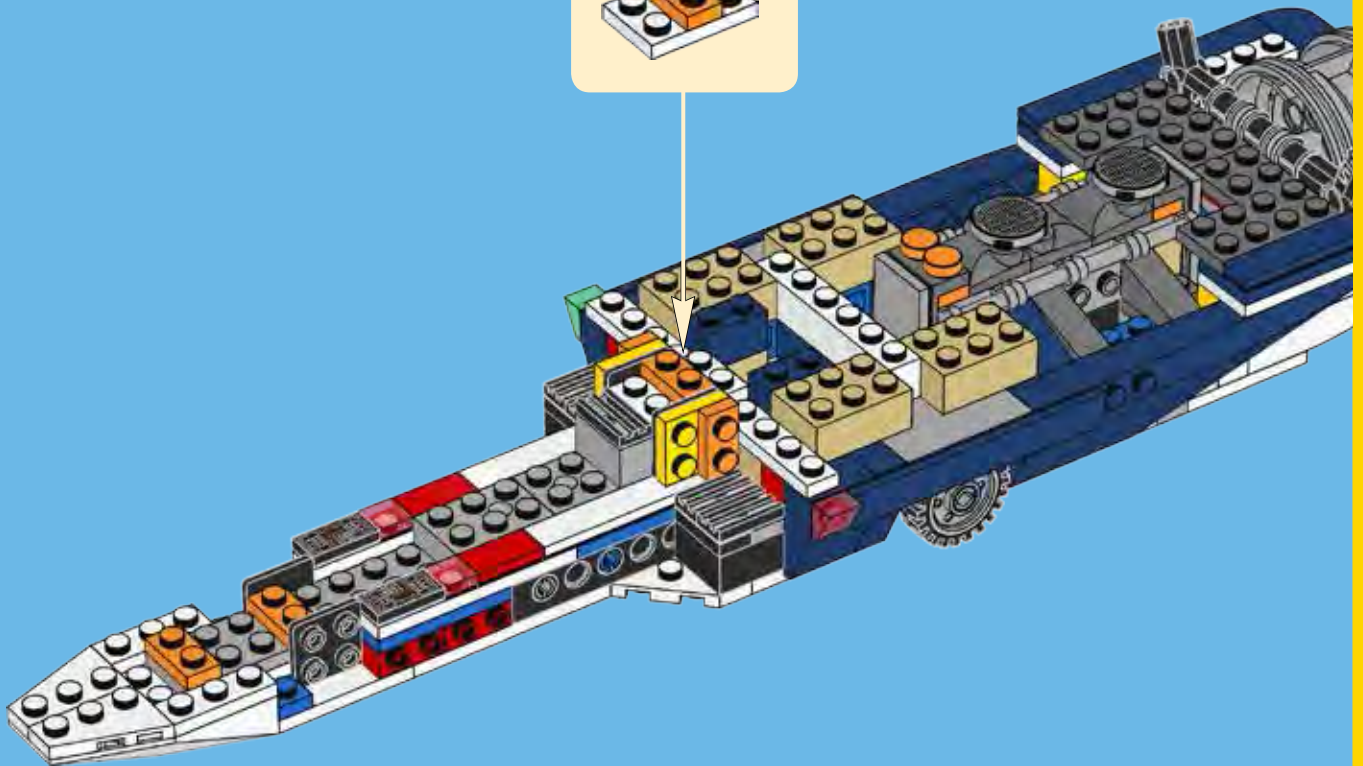



4x



1x

49

1

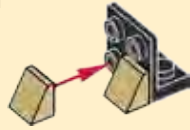

2

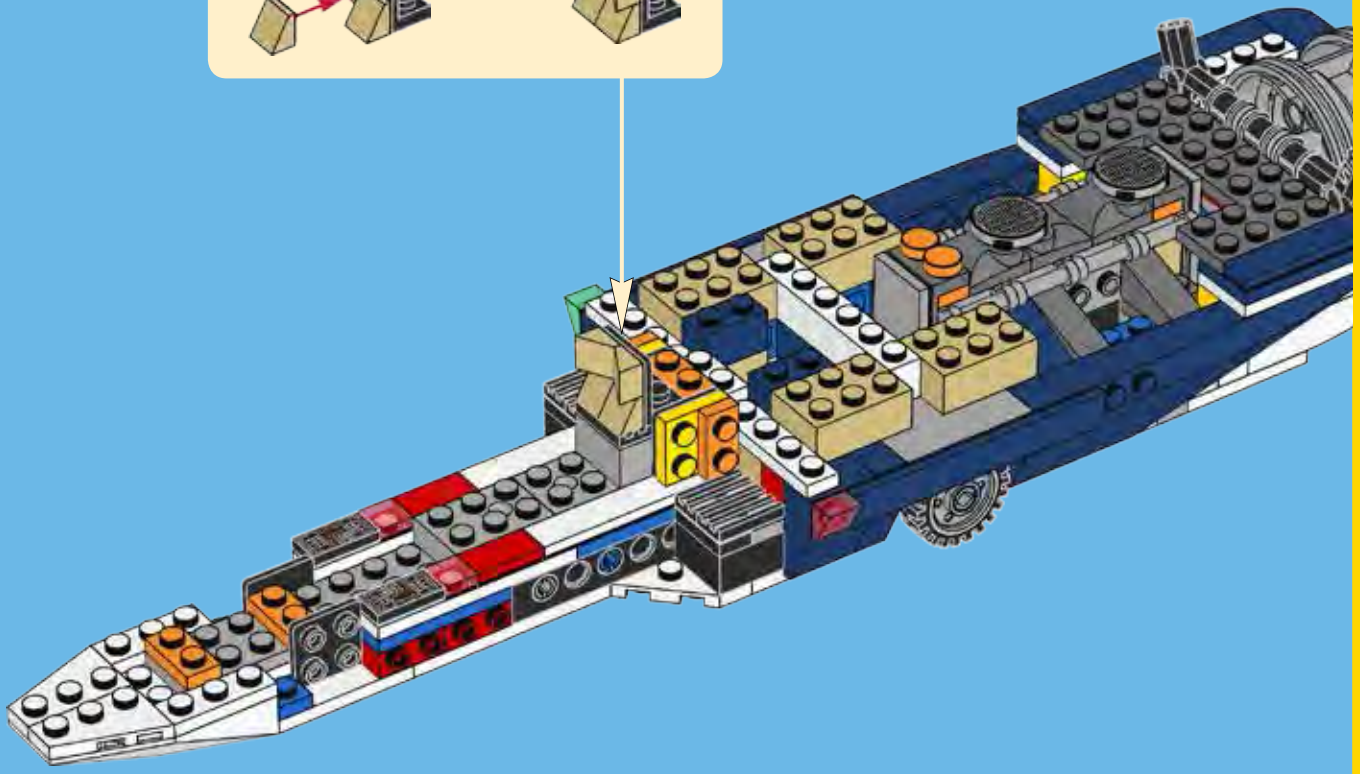



50

1



2

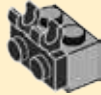

3

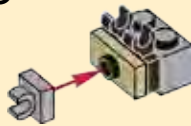

4

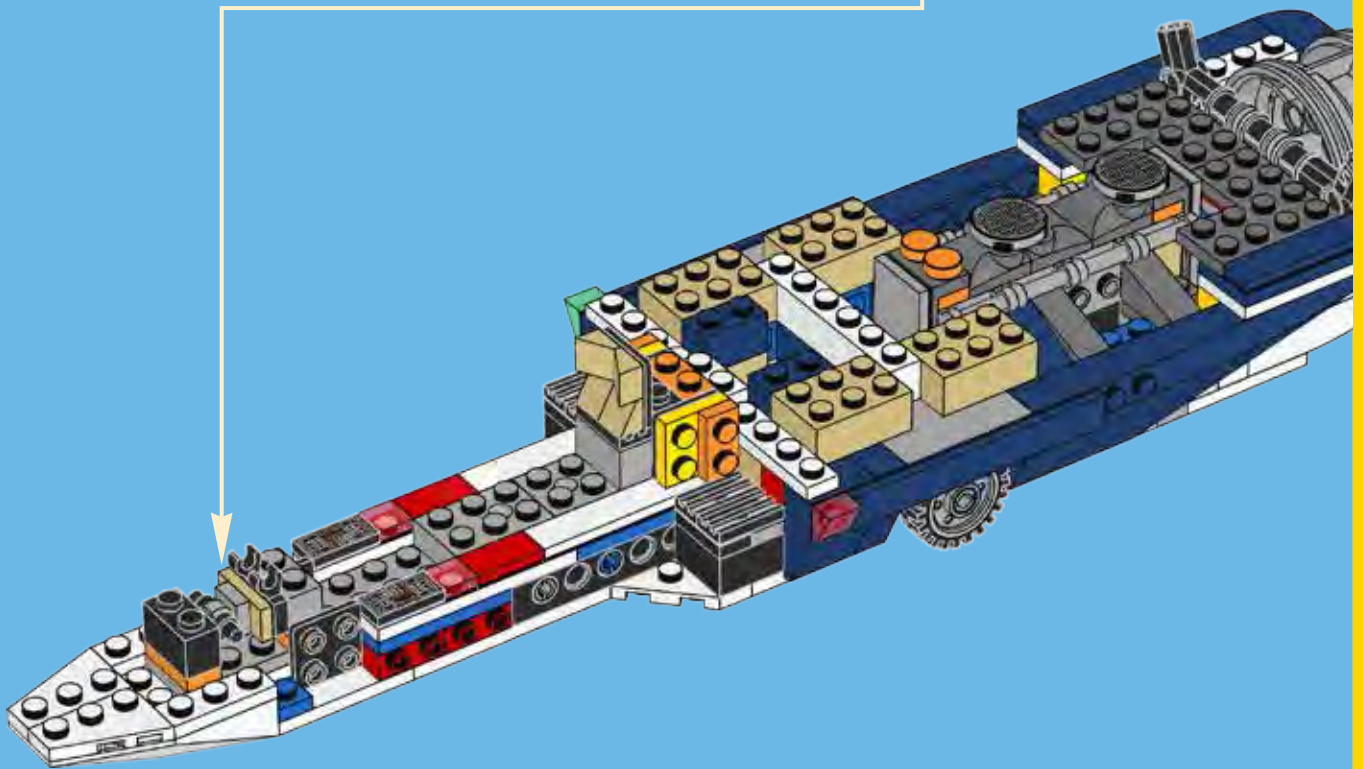
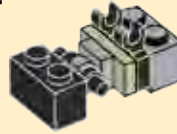

- 1x
- 1x
- 1x
- 1x
- 1x

51

1

2

3

4

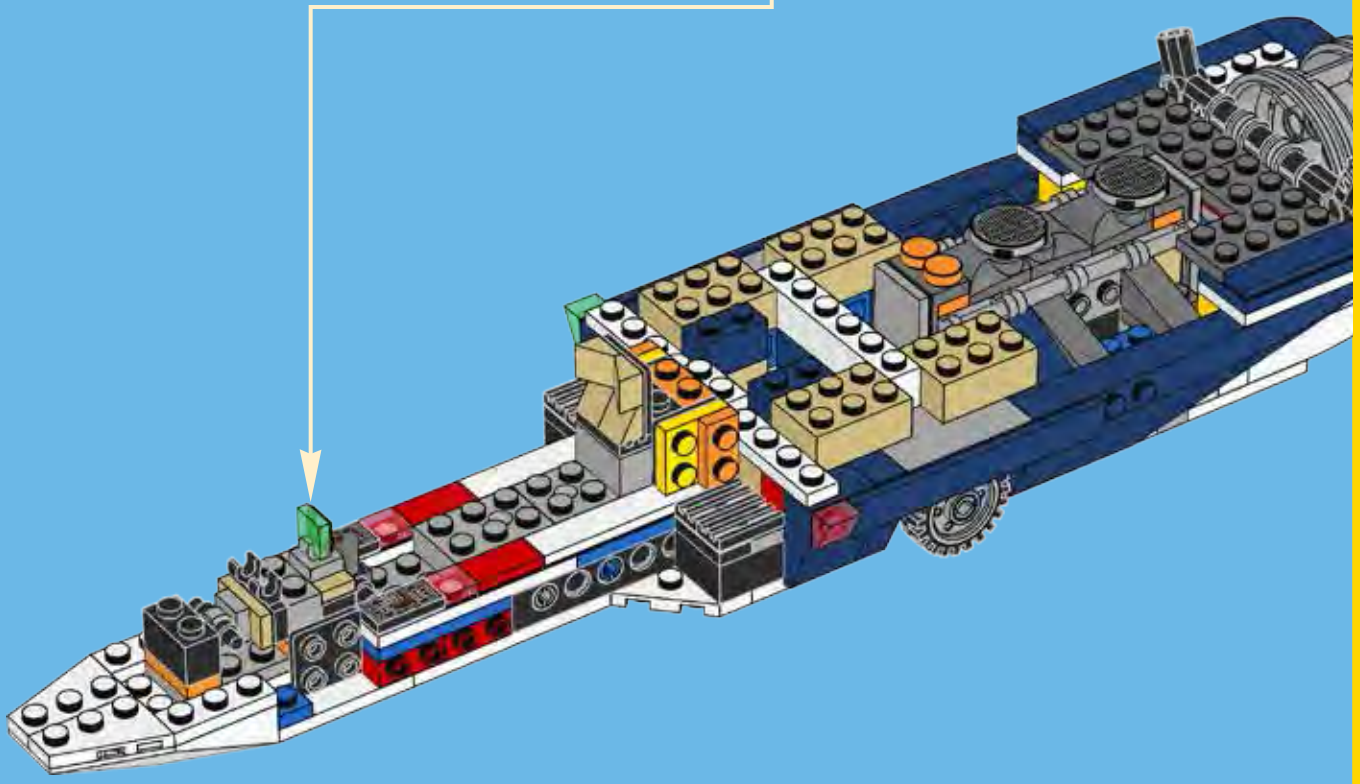



1x

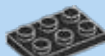

2x



2x

52

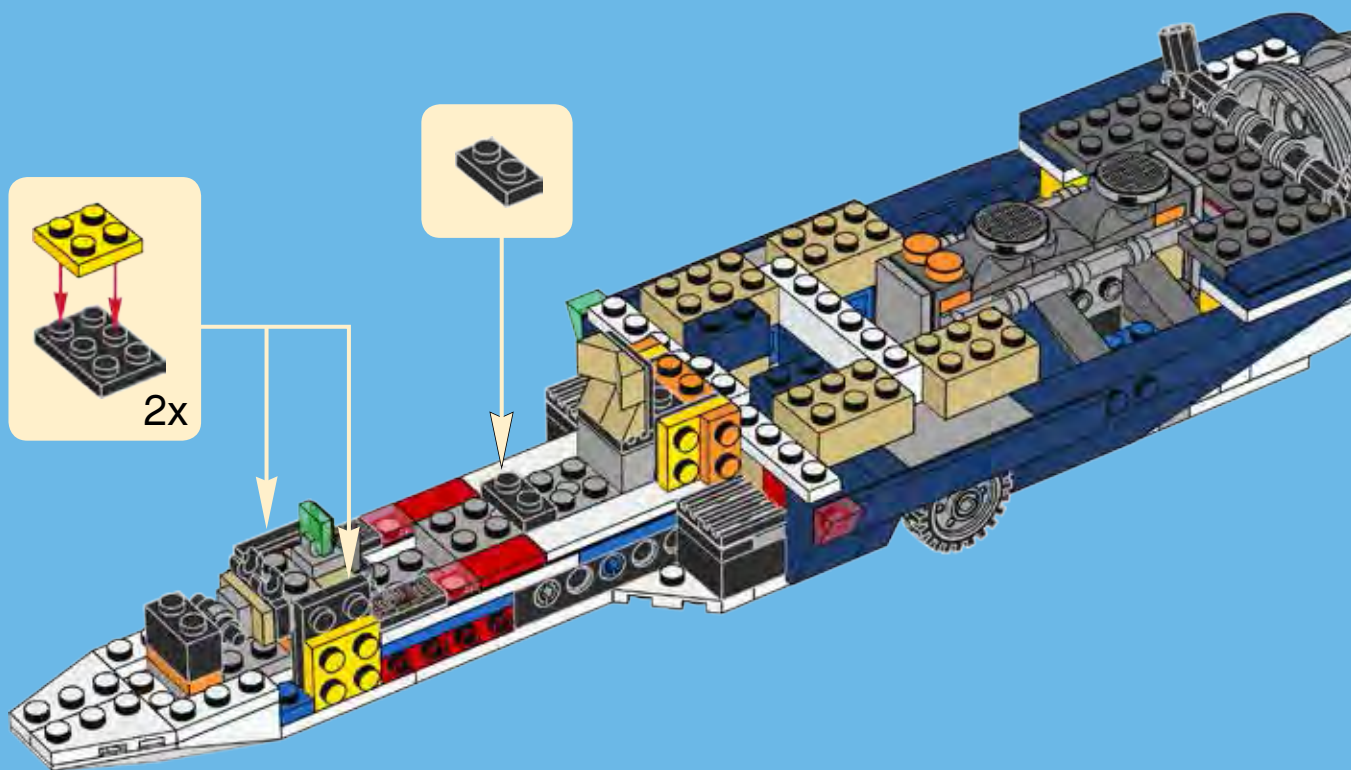



4x



2x

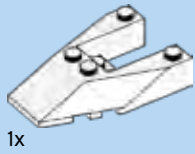

1x

53

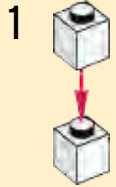

2x

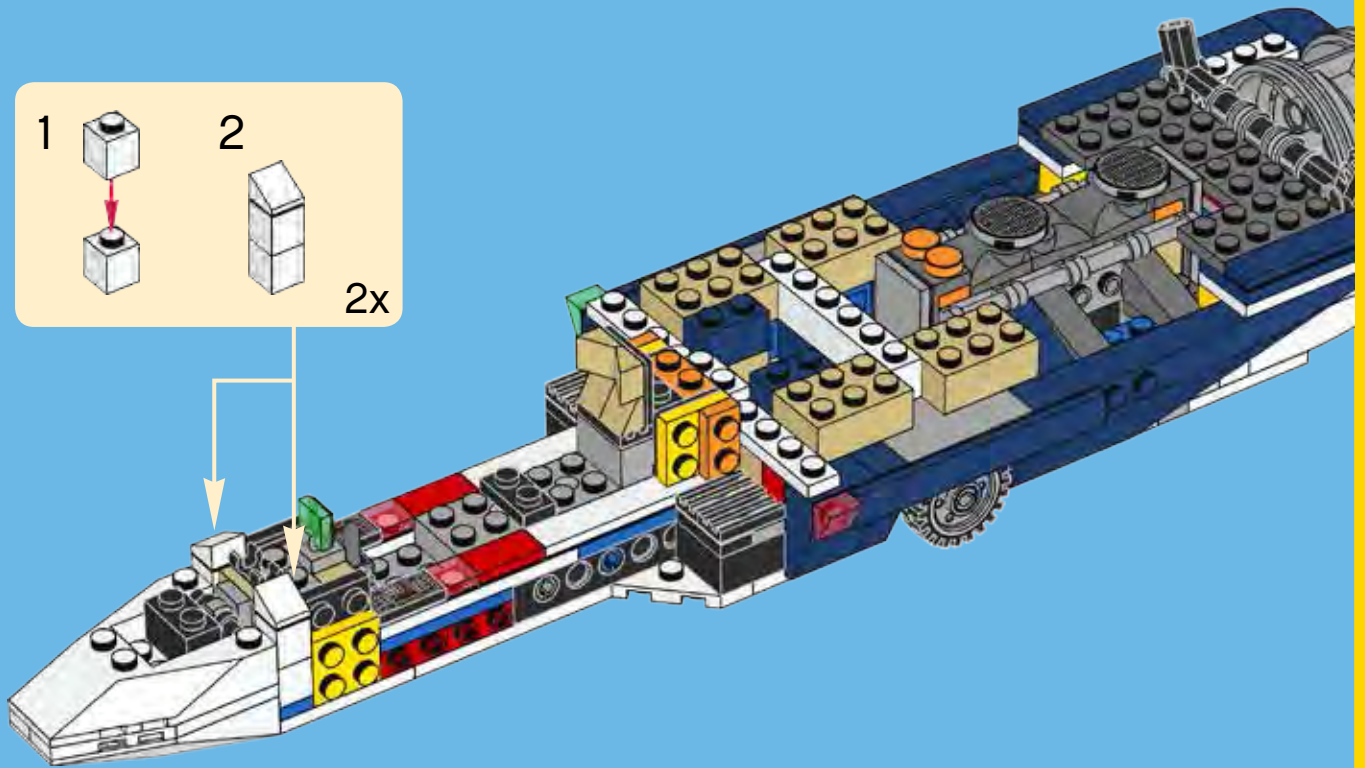

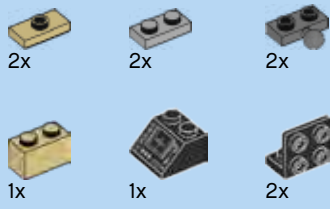

54

1

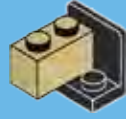

2



3



4

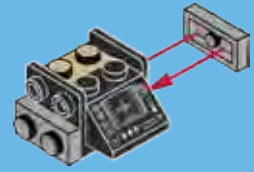

5



6

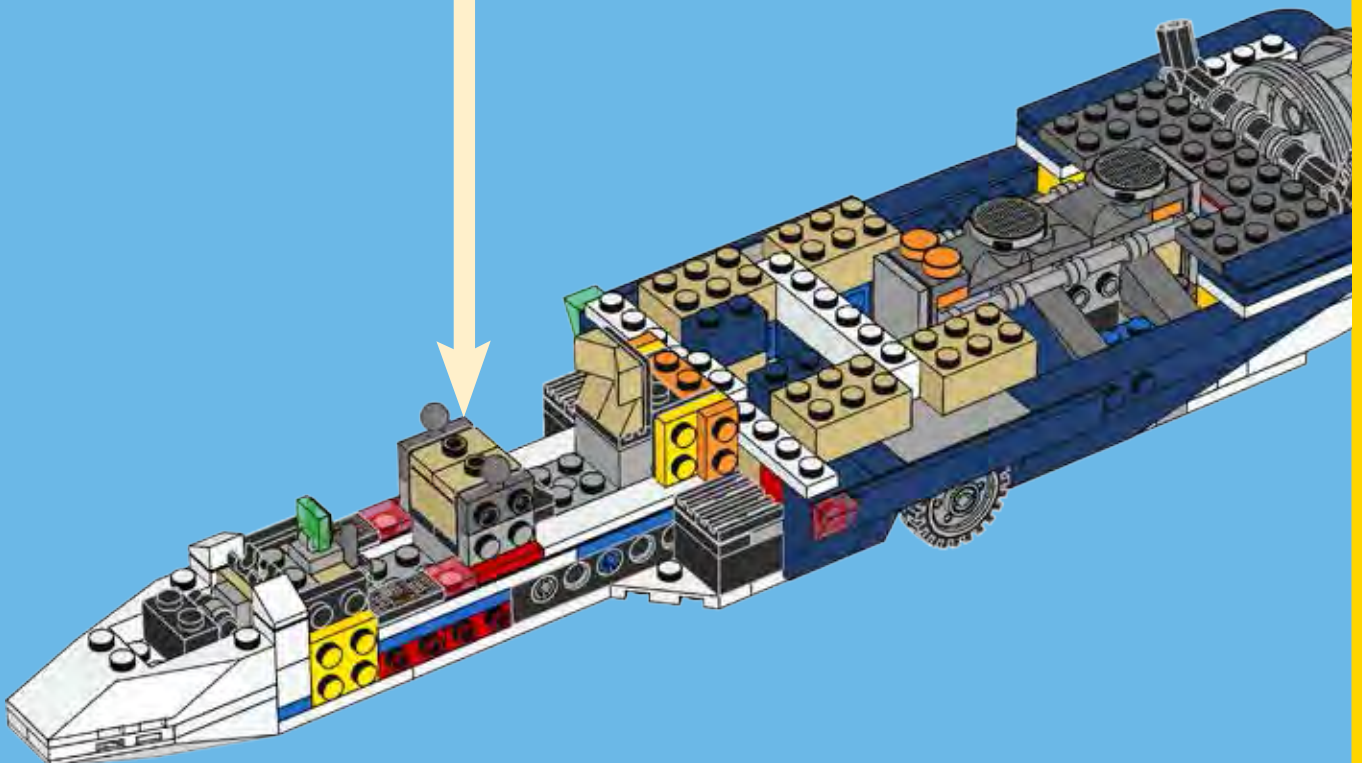
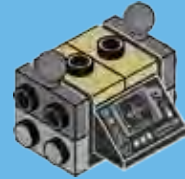

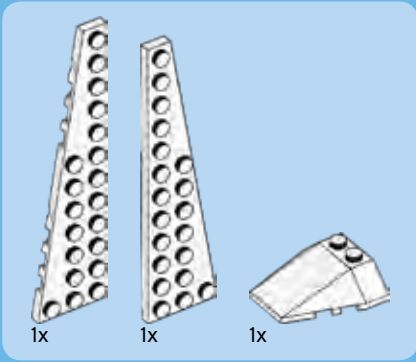

55

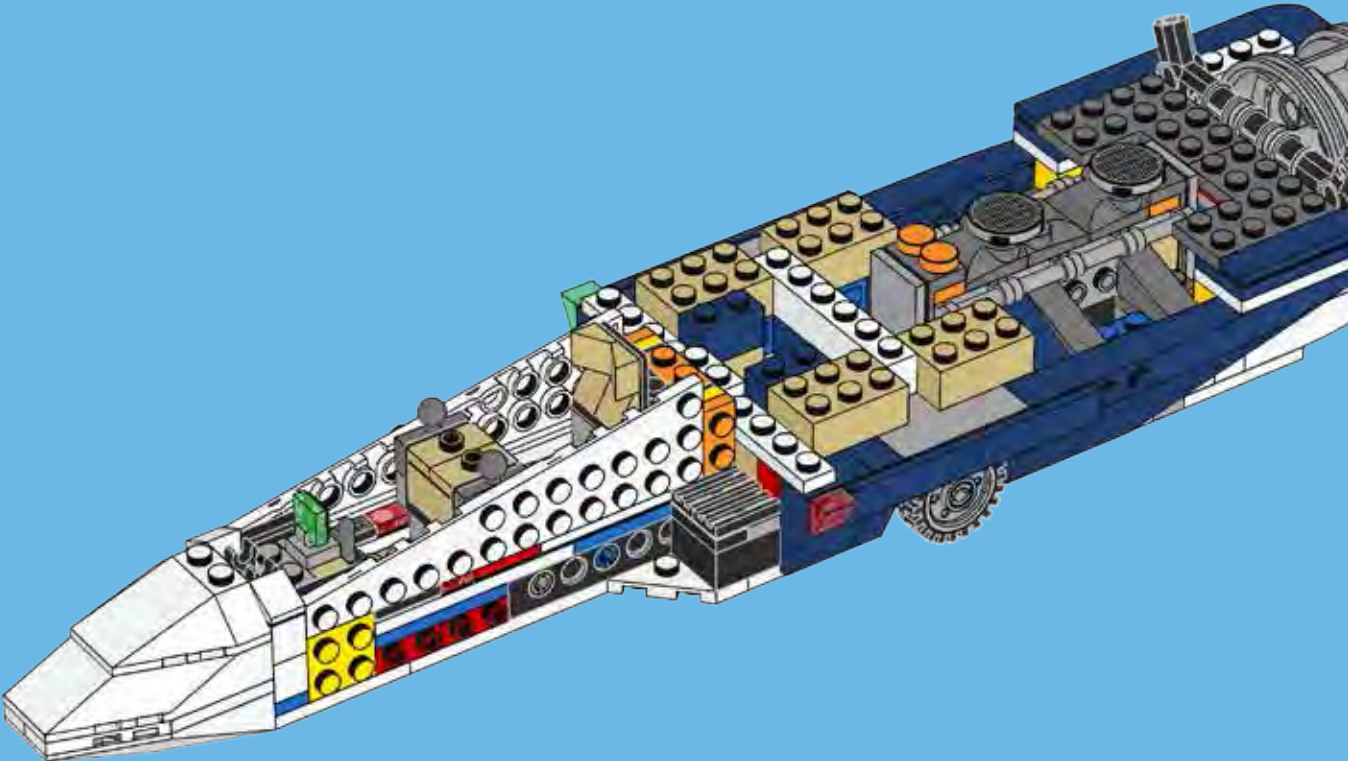



2x



2x



2x

56

1



2



3



2x

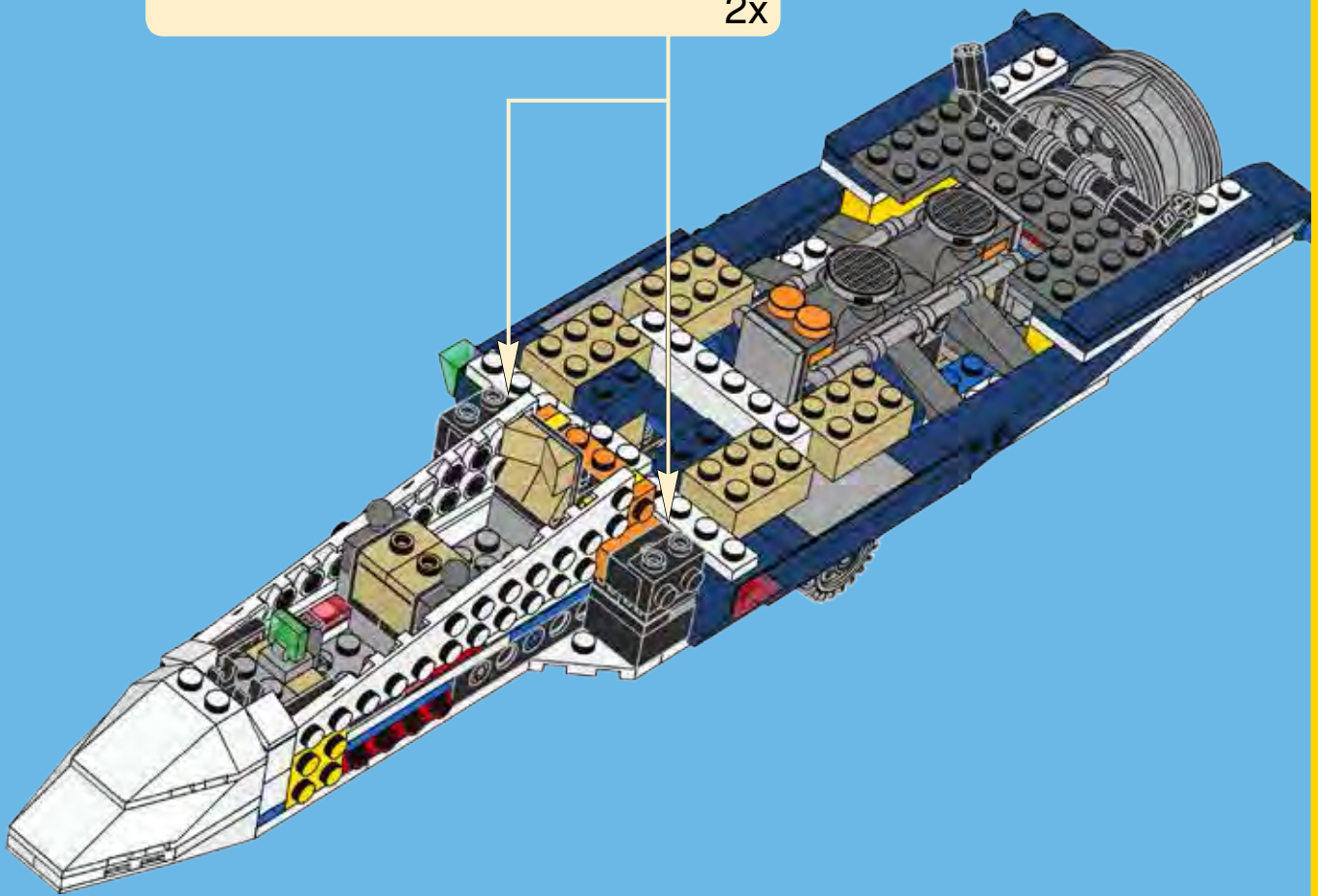



1x



1x



1x



1x

57

1



2



3

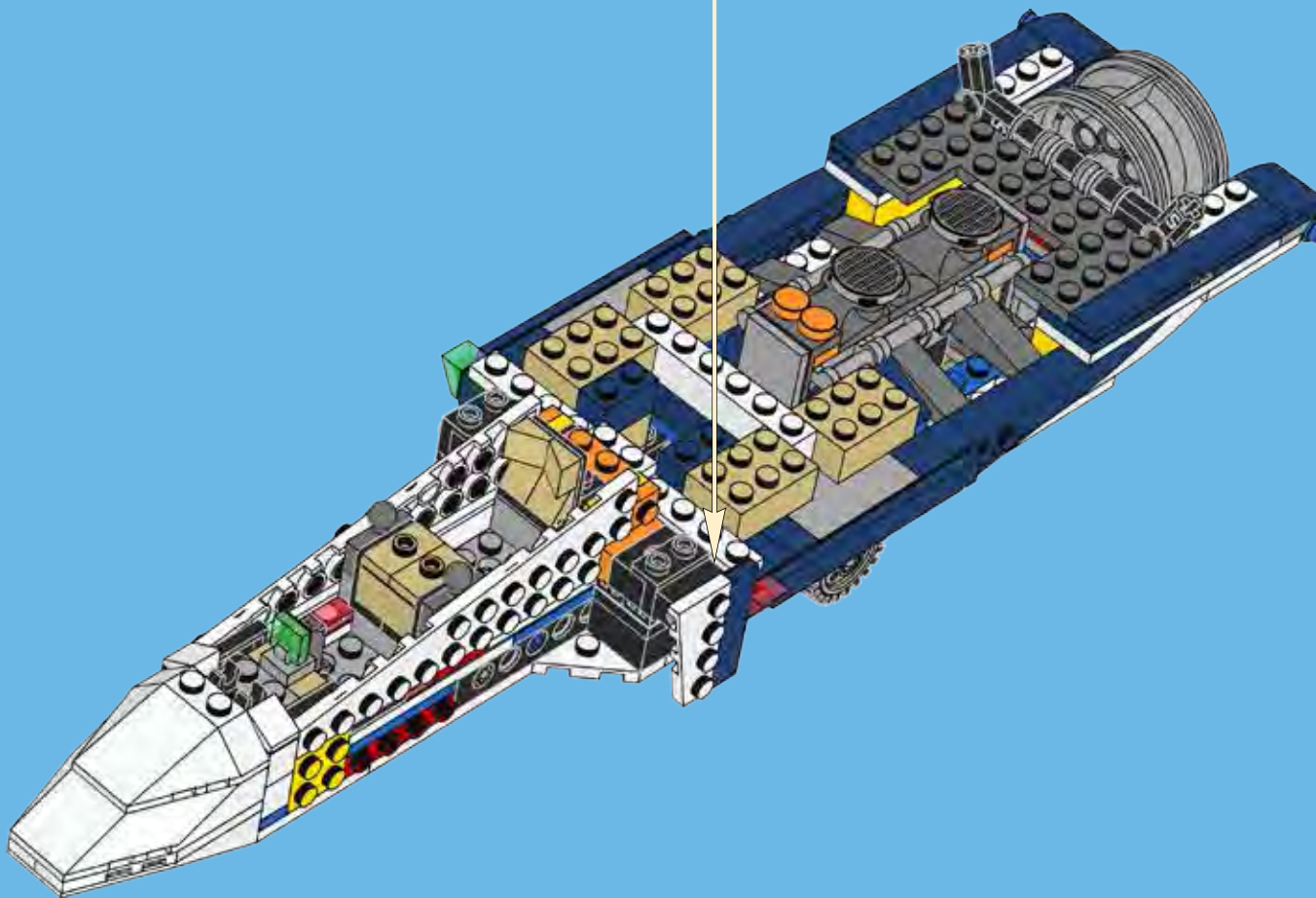

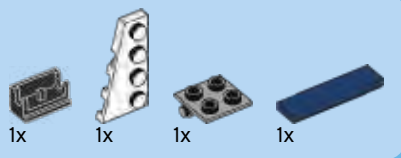

58

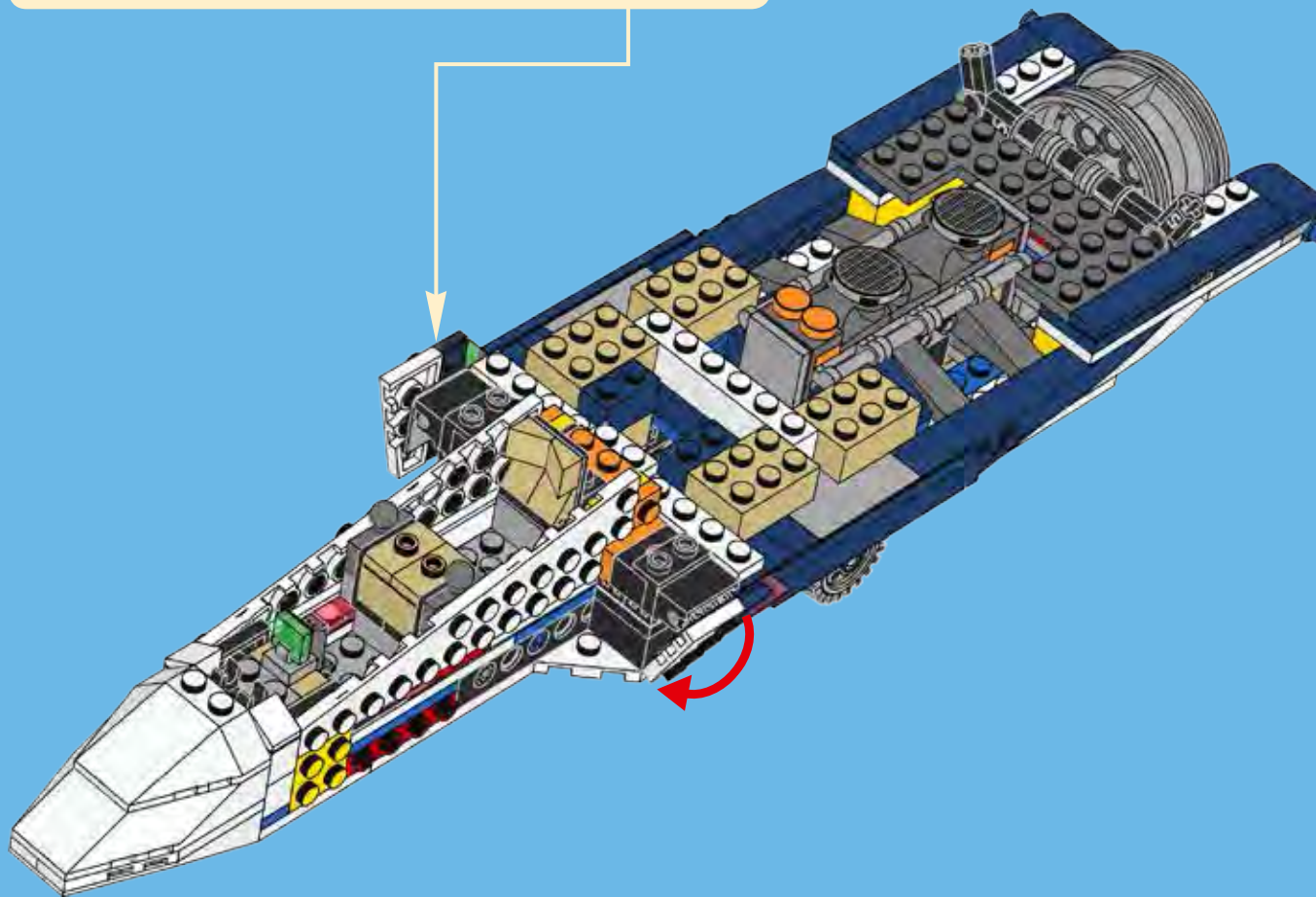
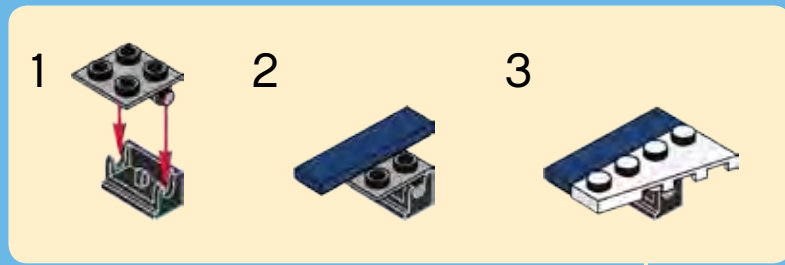

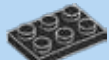

2x



1x



2x



1x

59

1



2

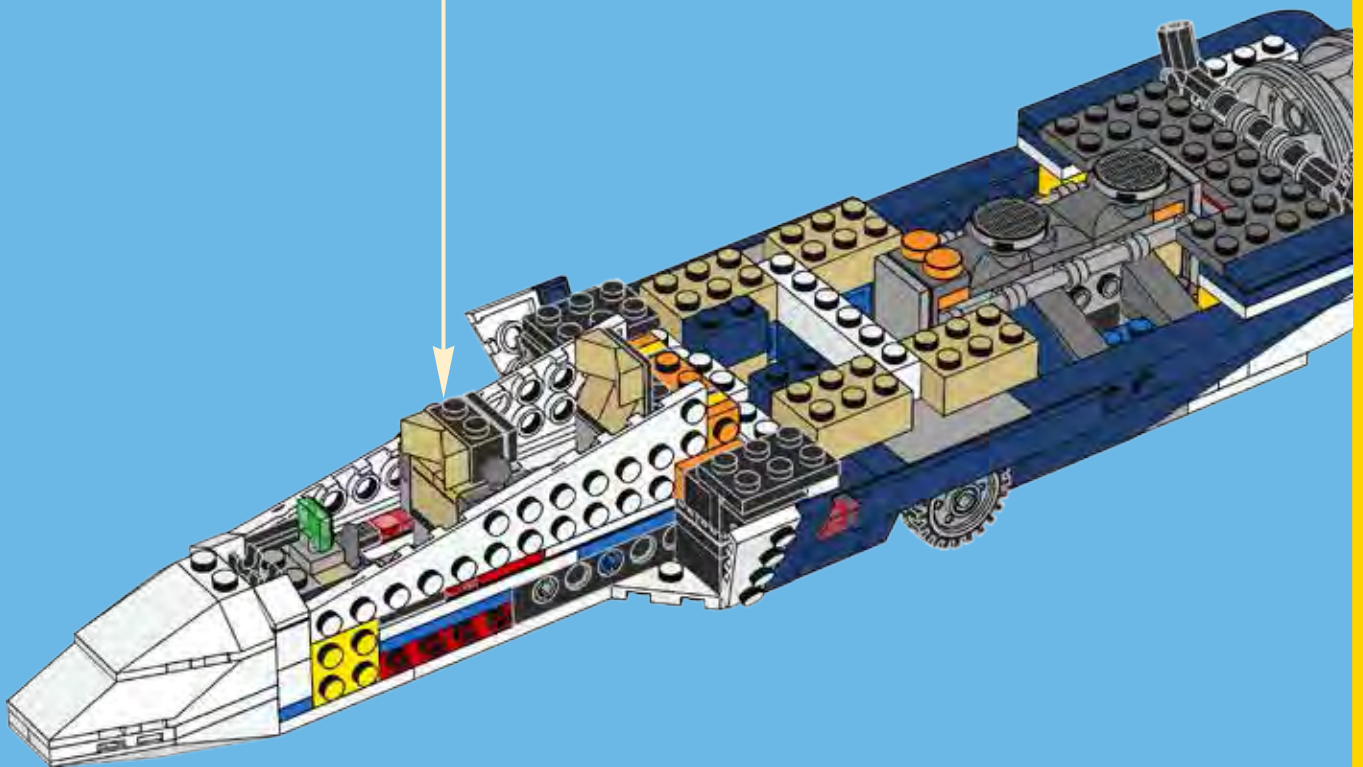

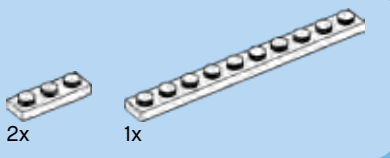

60

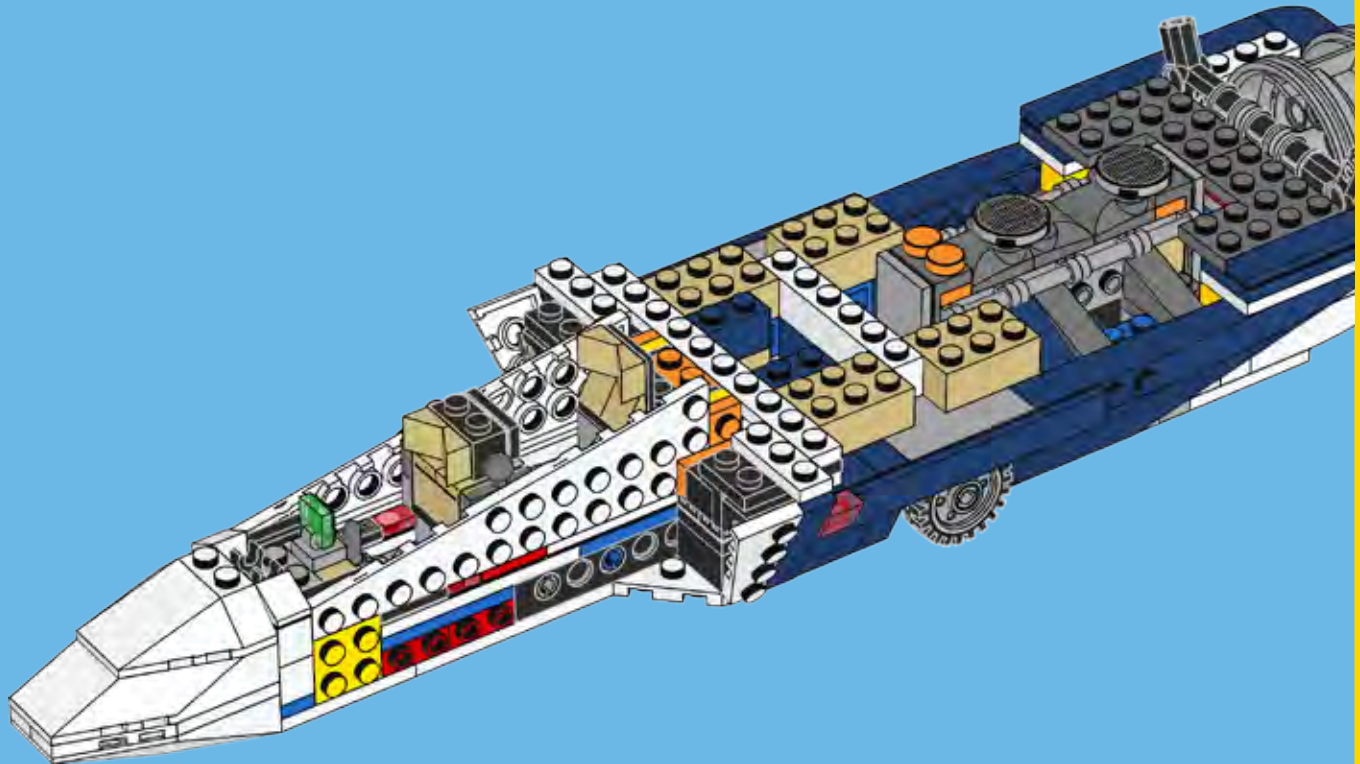



1x



3x



1x



2x

61

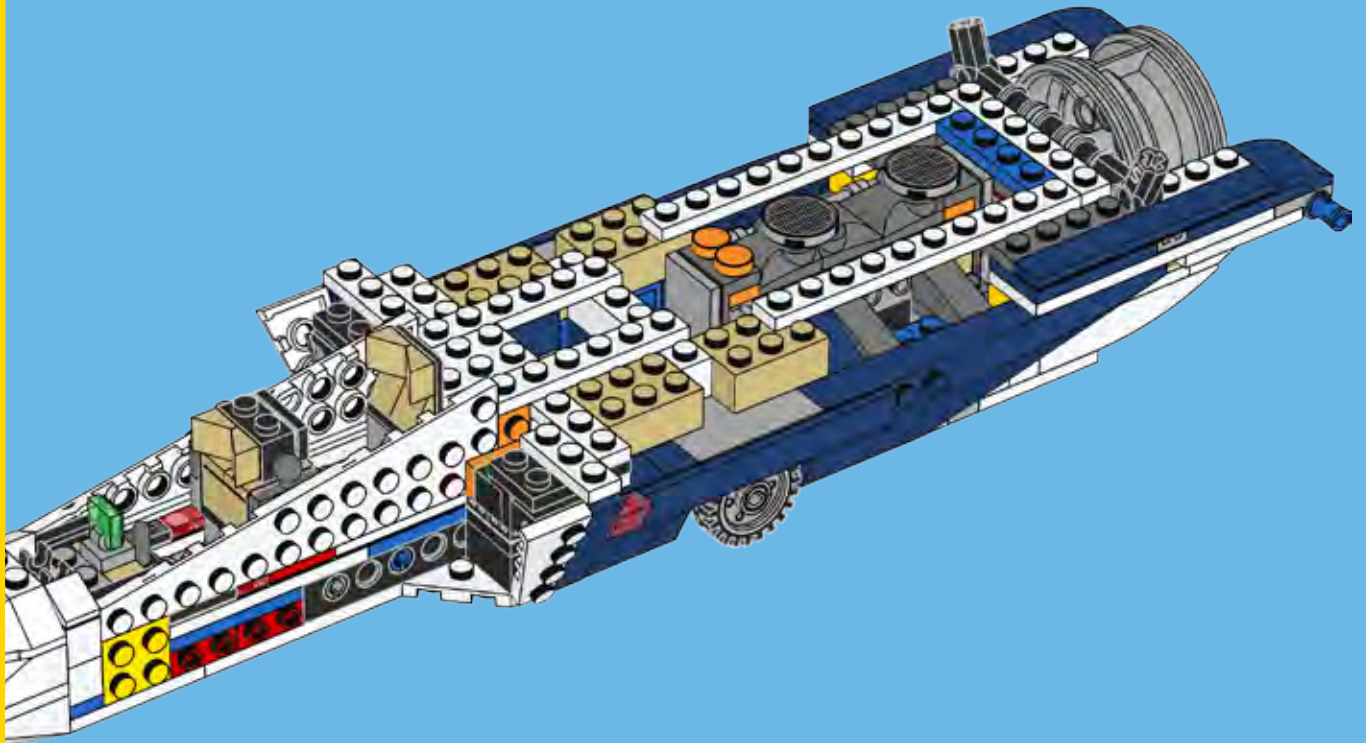

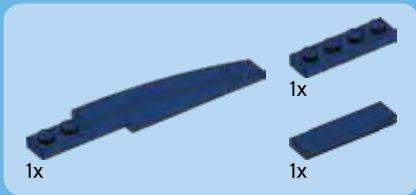

62

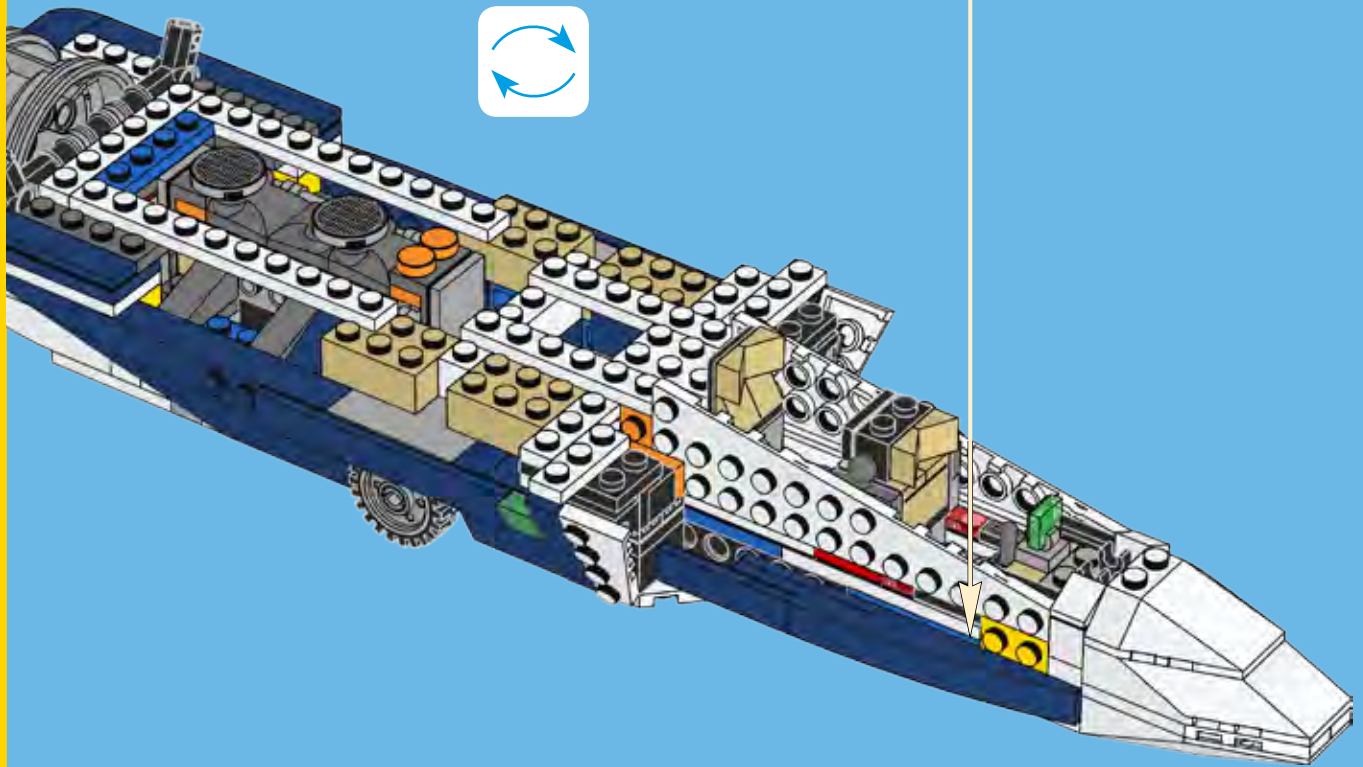
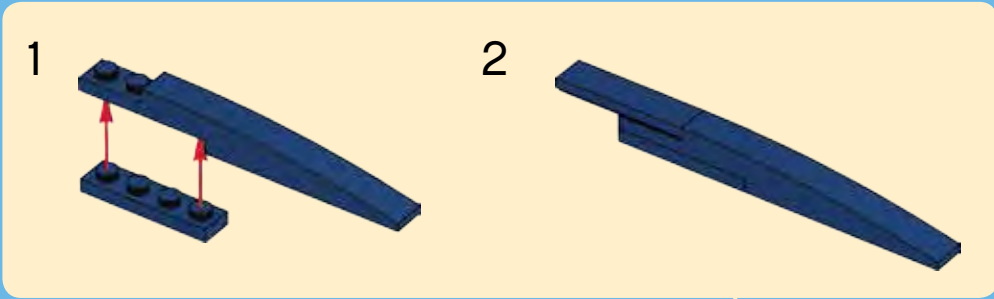



1x

63

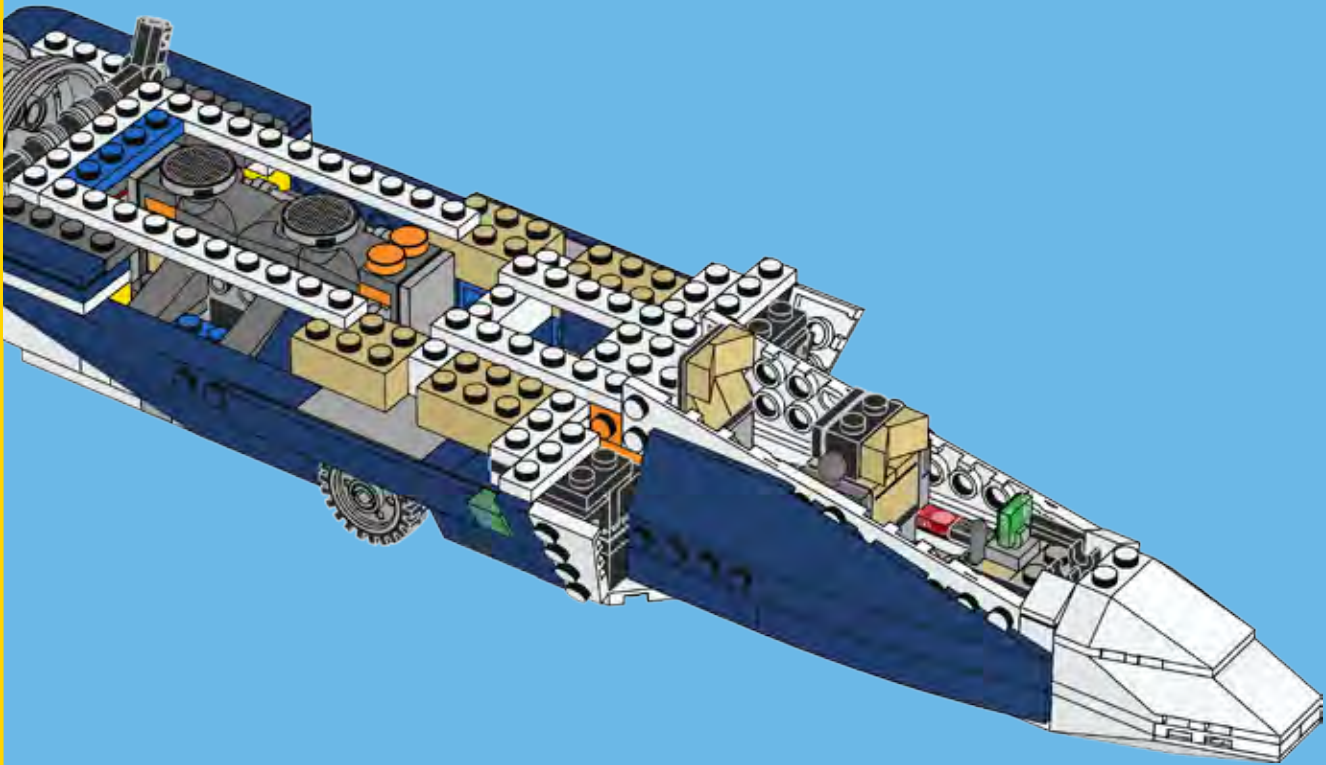

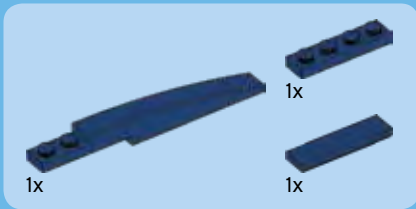

64

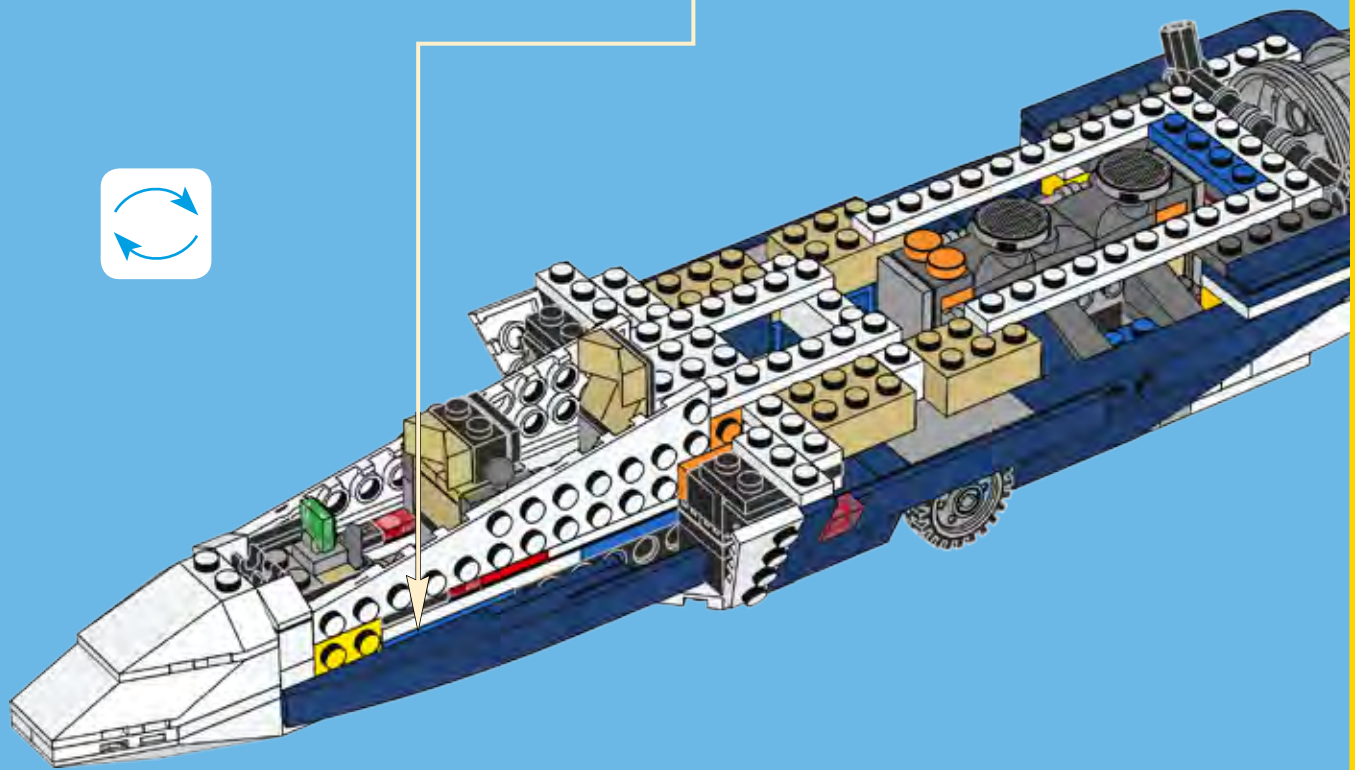
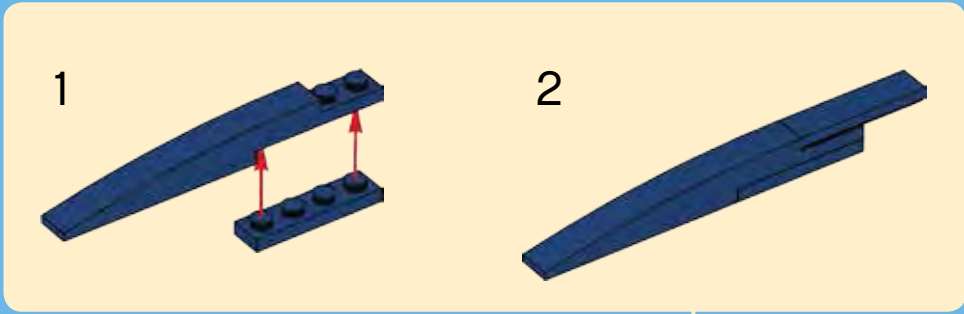

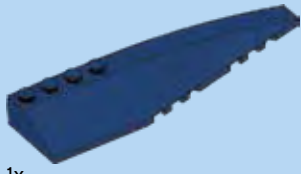

1x

65

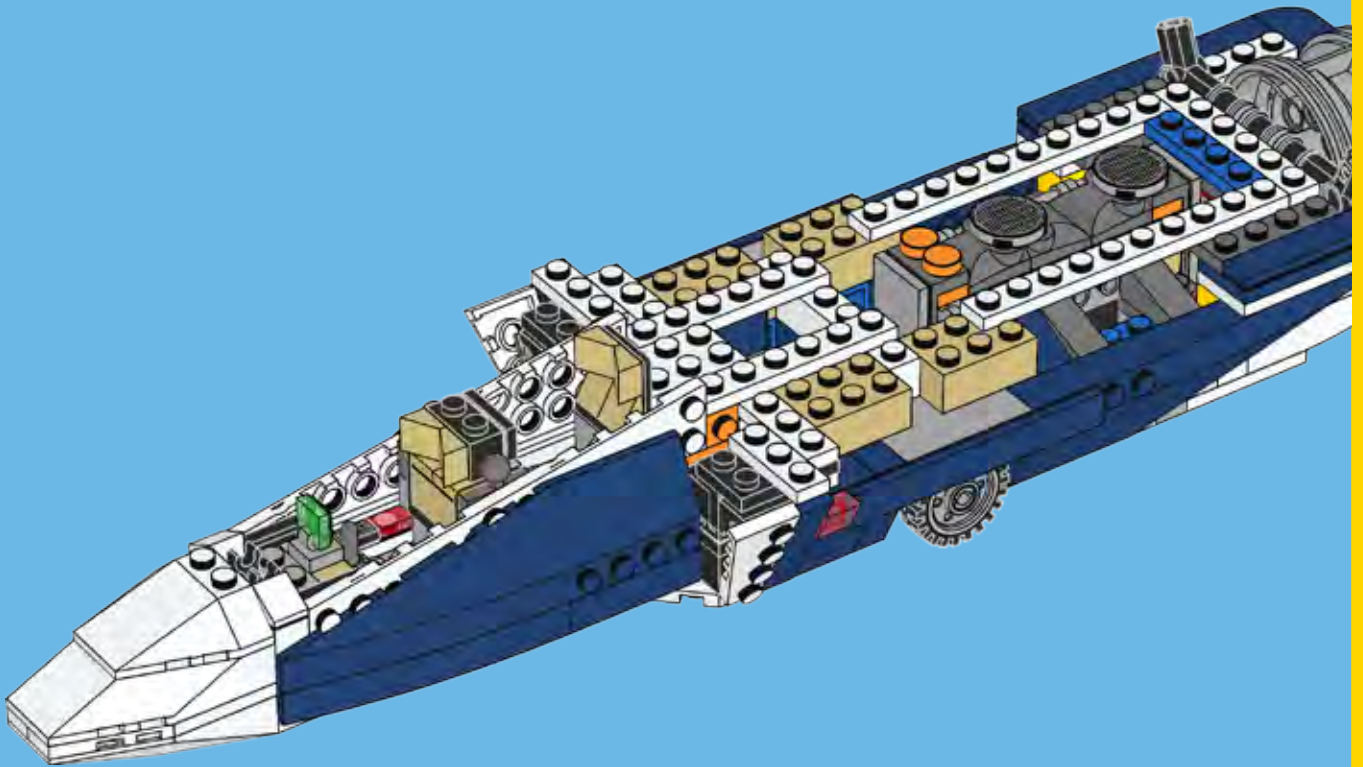



2x



2x

66

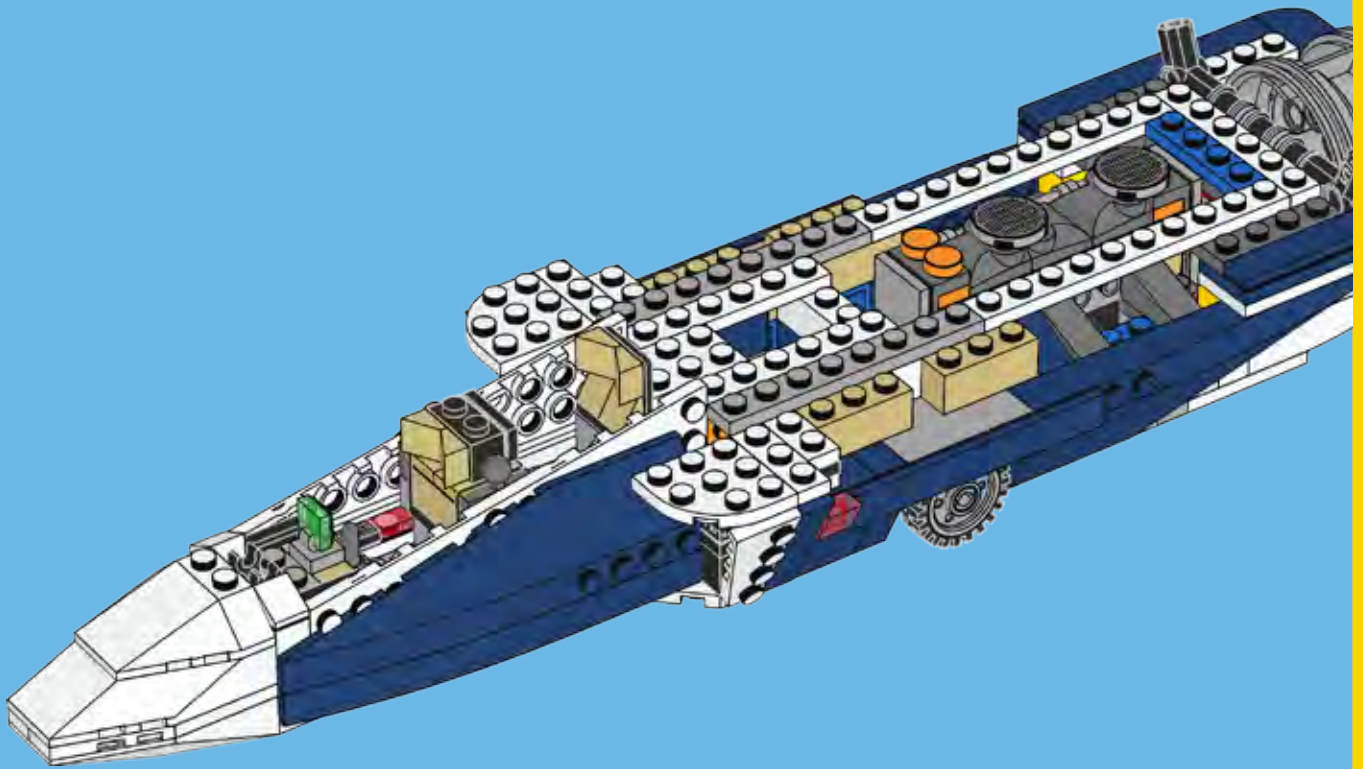



2x



12x



2x

67

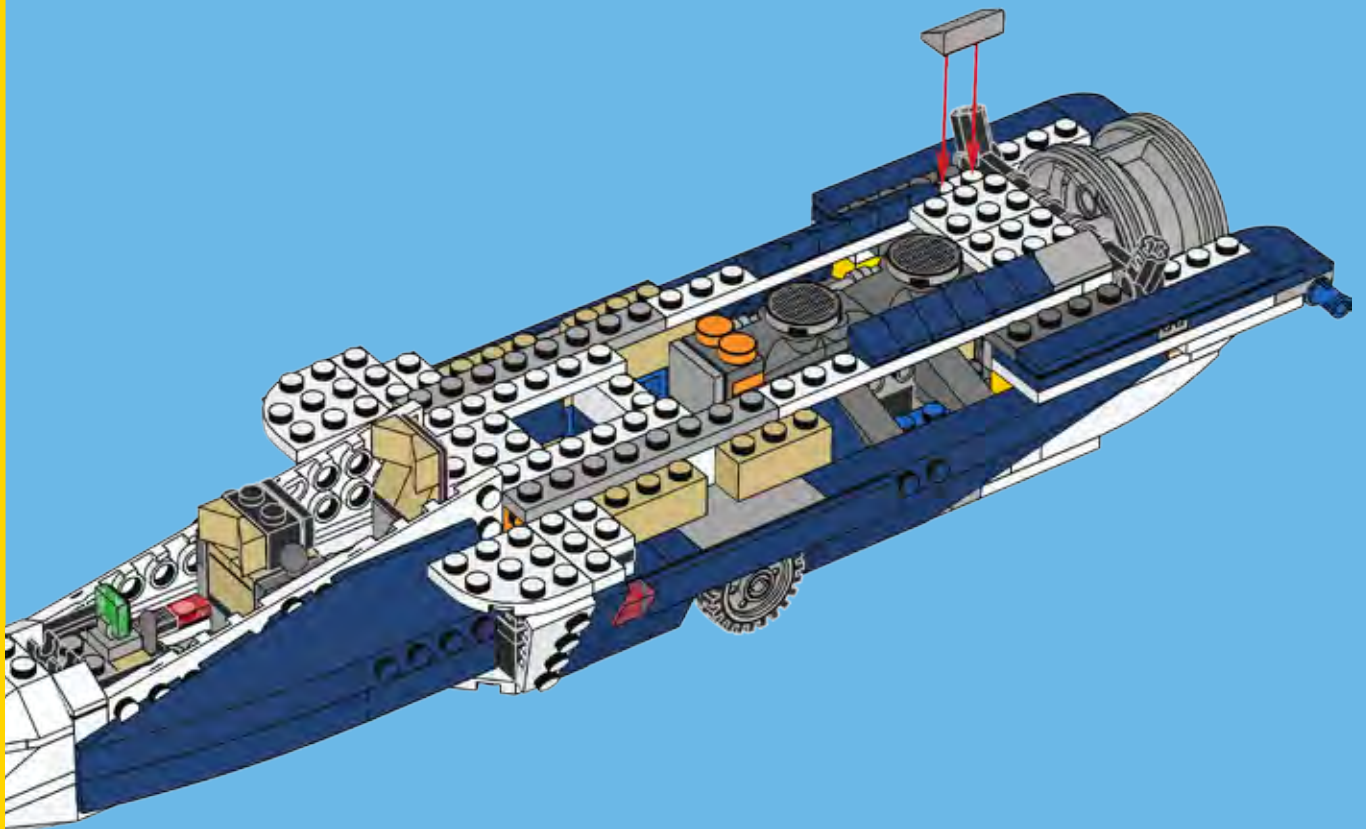



2x



1x



8x

68

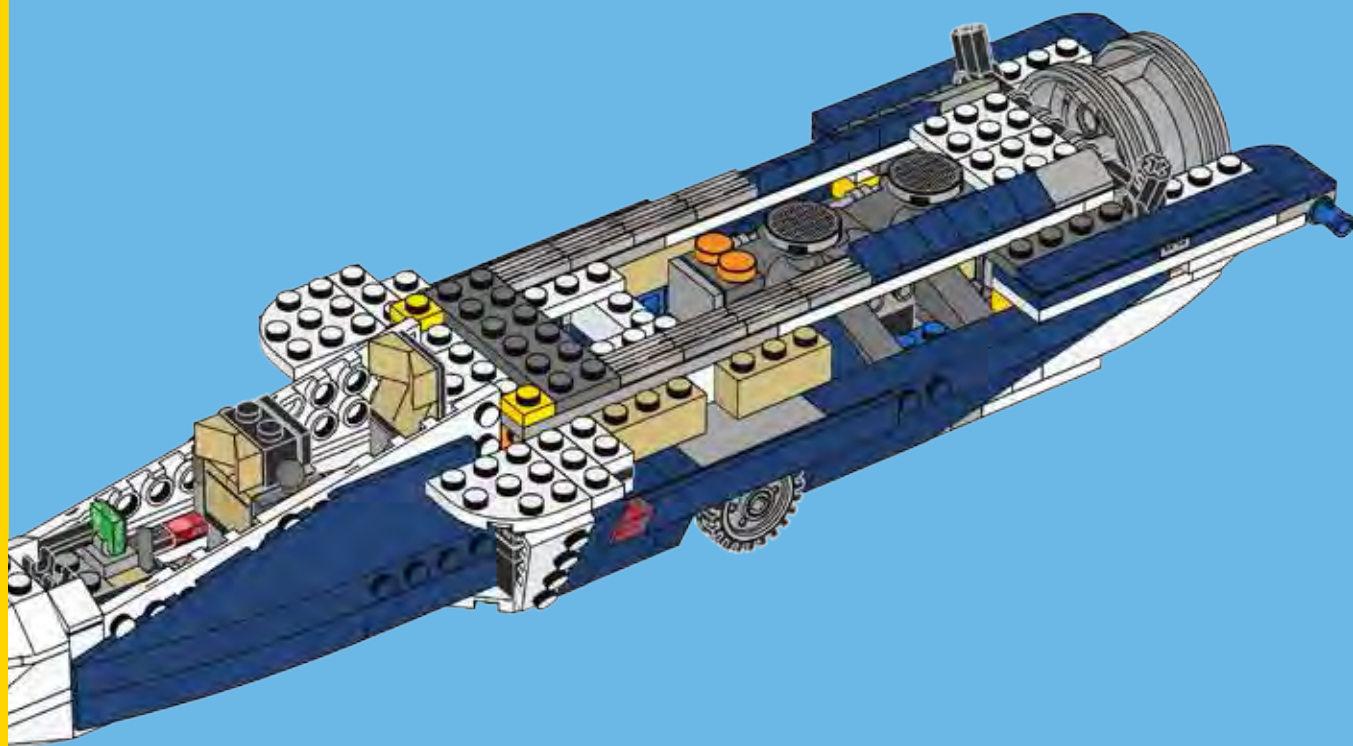



2x



4x



1x



1x



2x

69

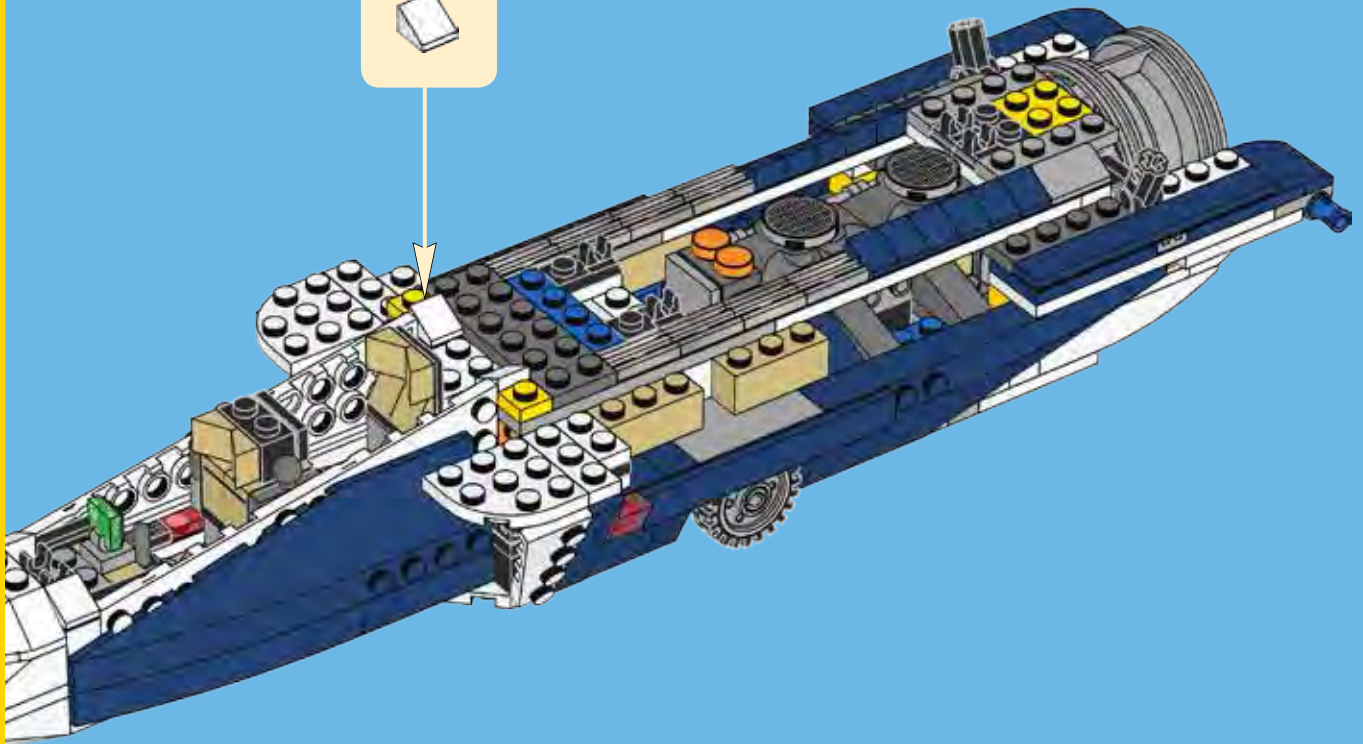



1x



2x



2x

70

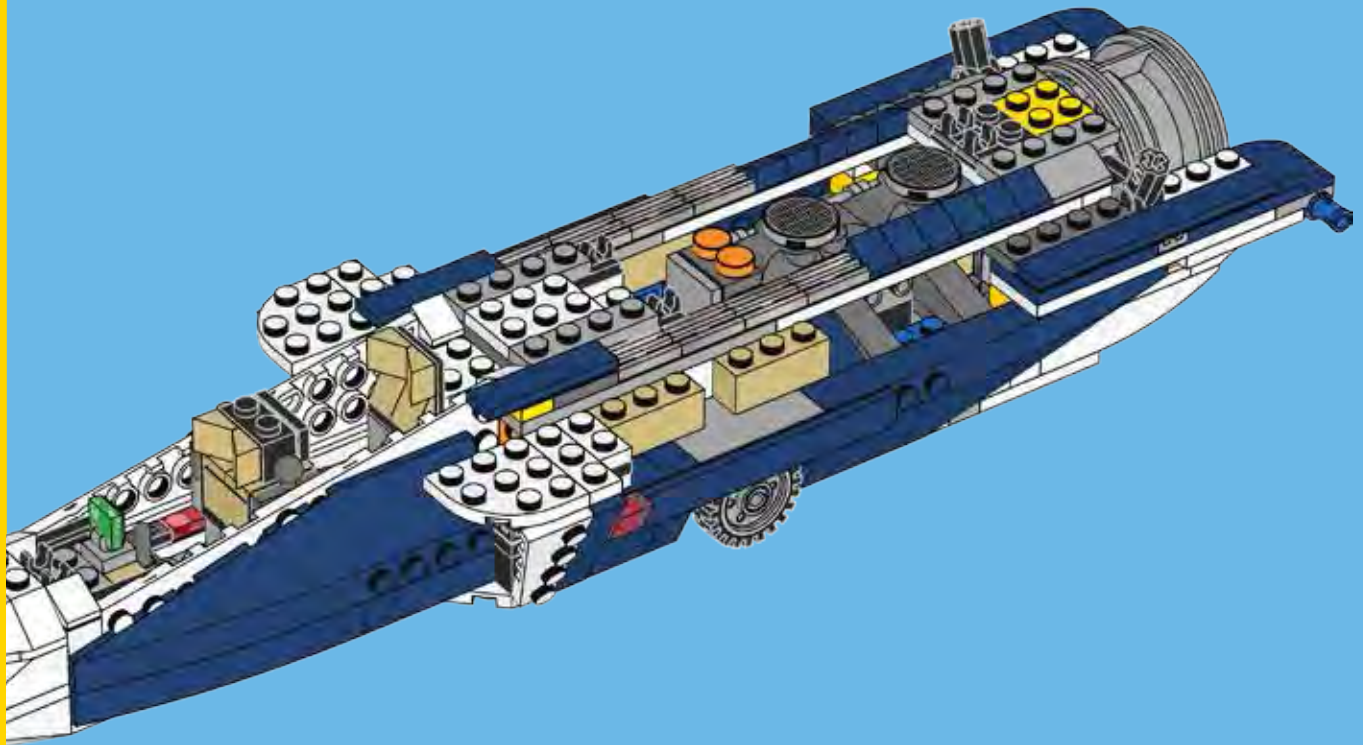



1x



2x

3



3

1:1



1x



1x

71

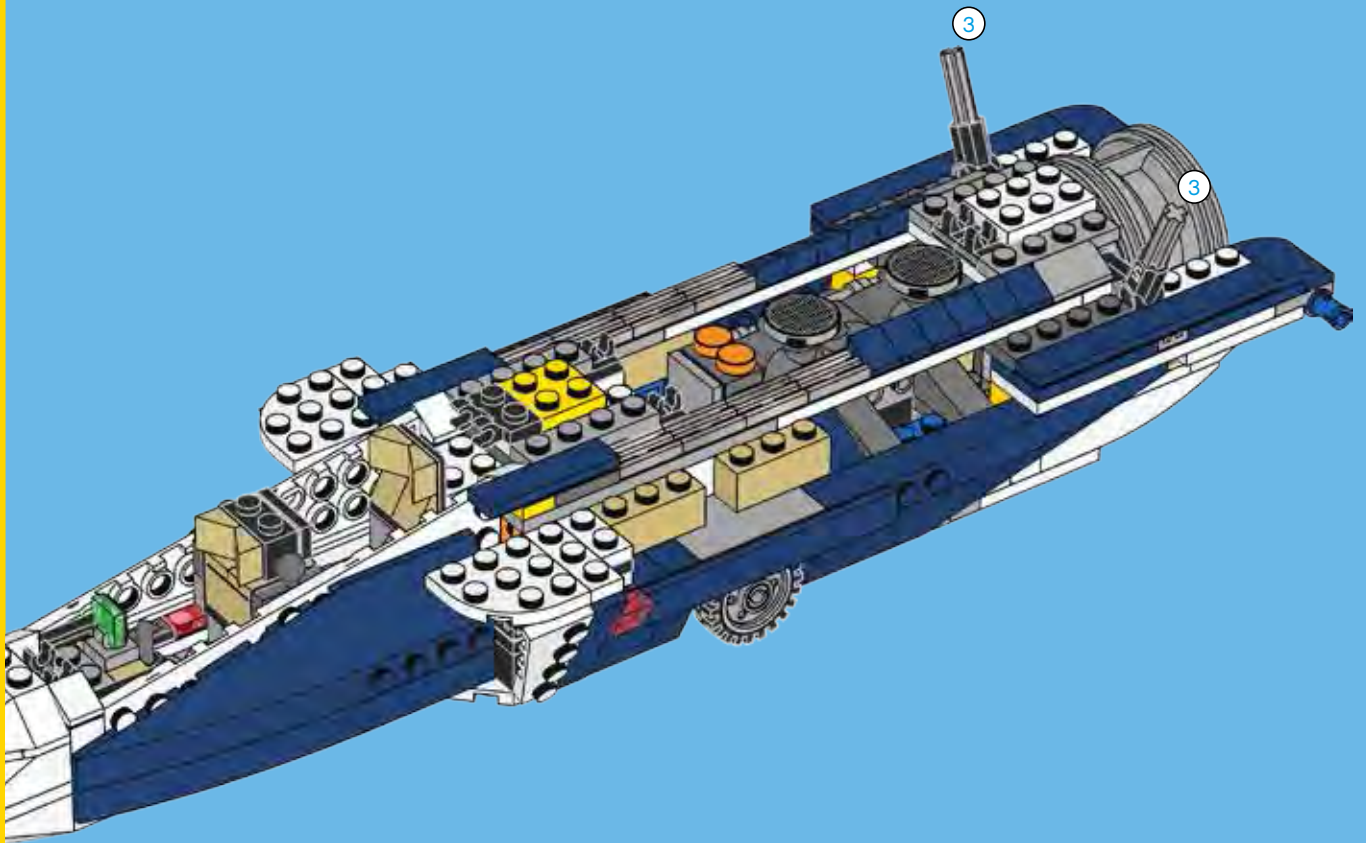

72



3x



1x



4x

1

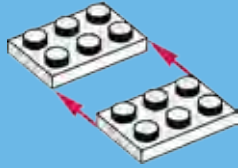

2



3



4

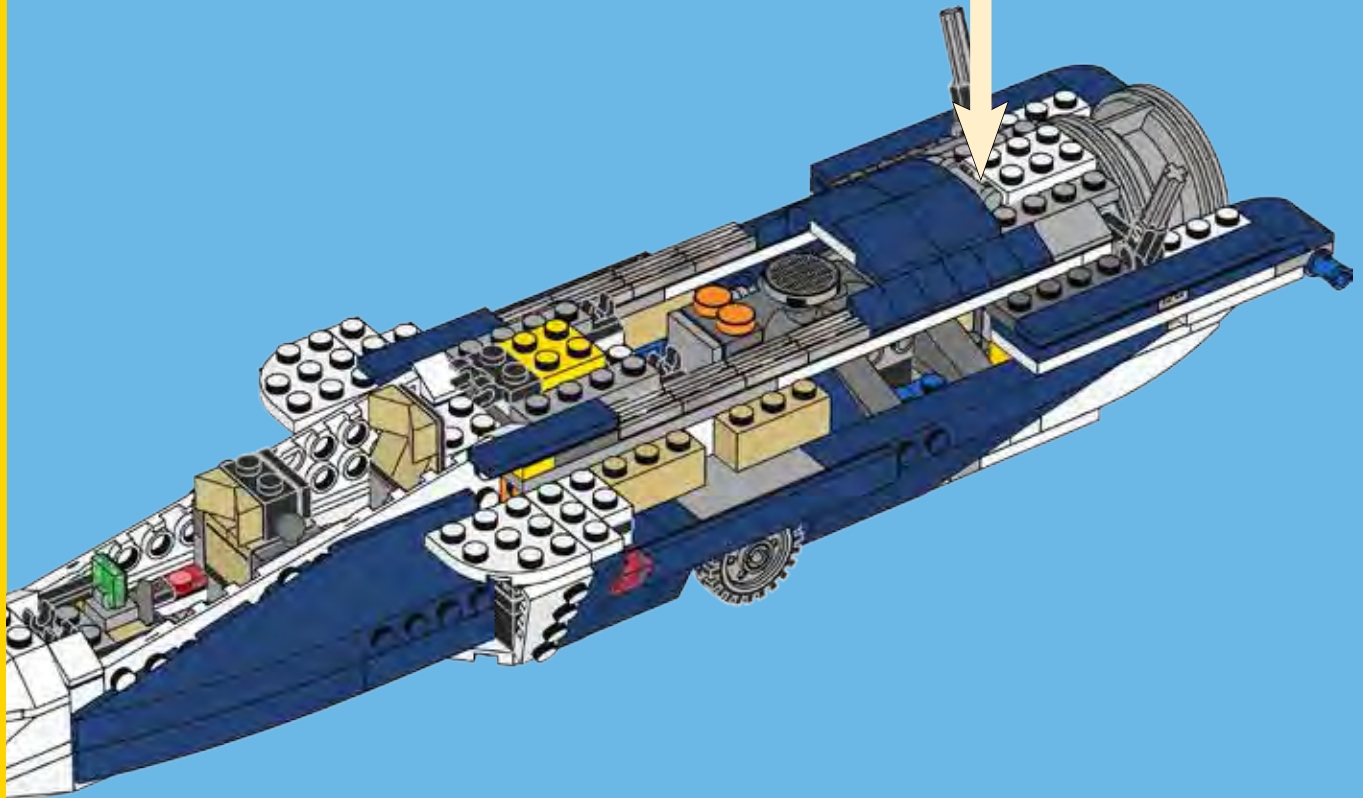
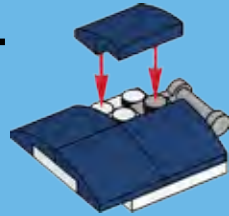



6x

73

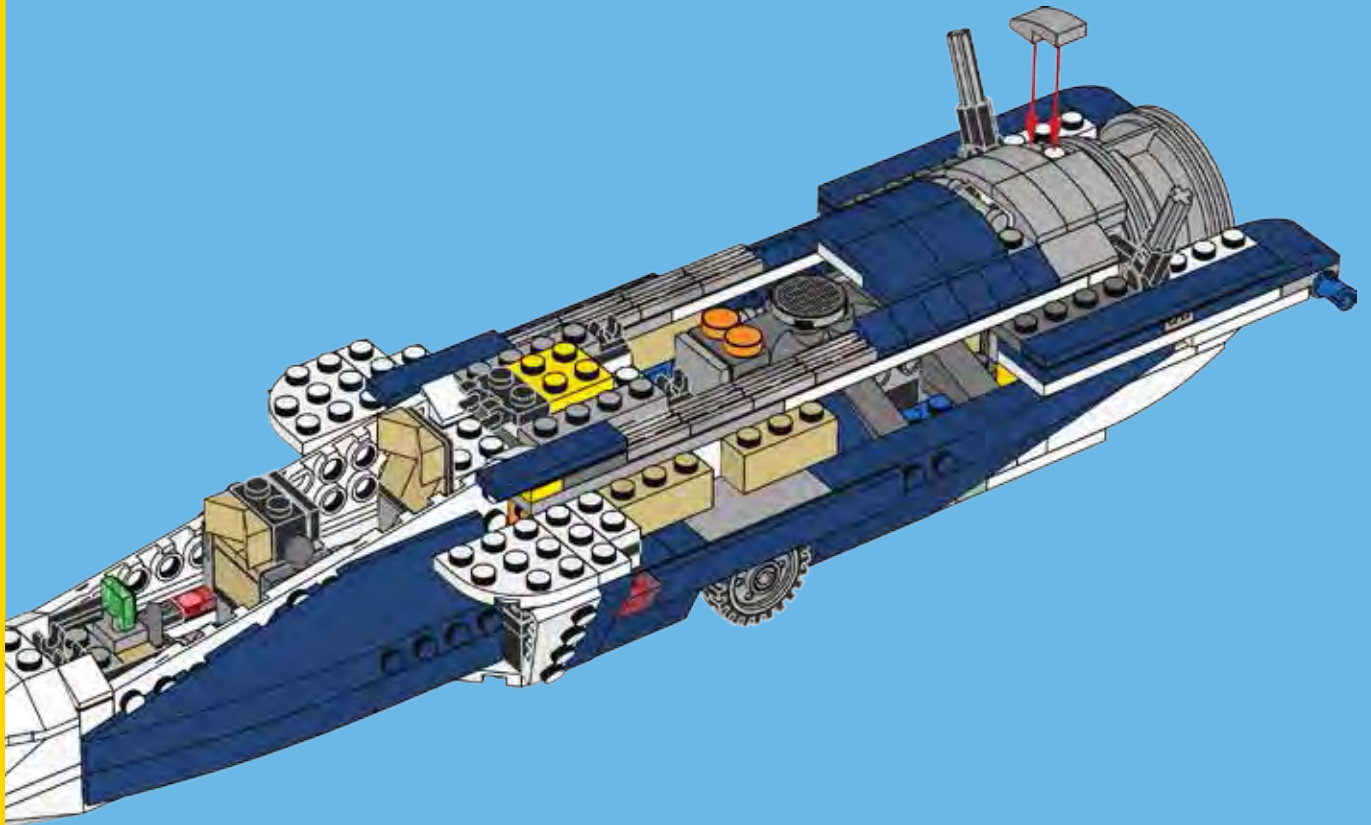

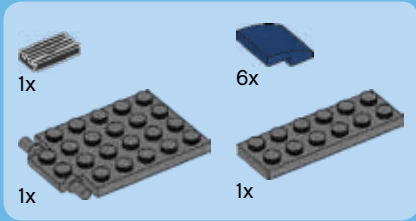

74

1

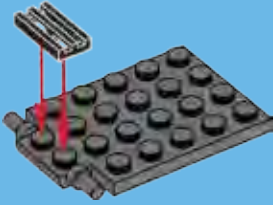

2

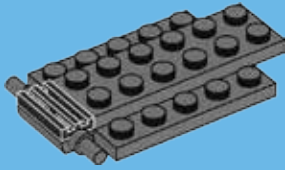

3

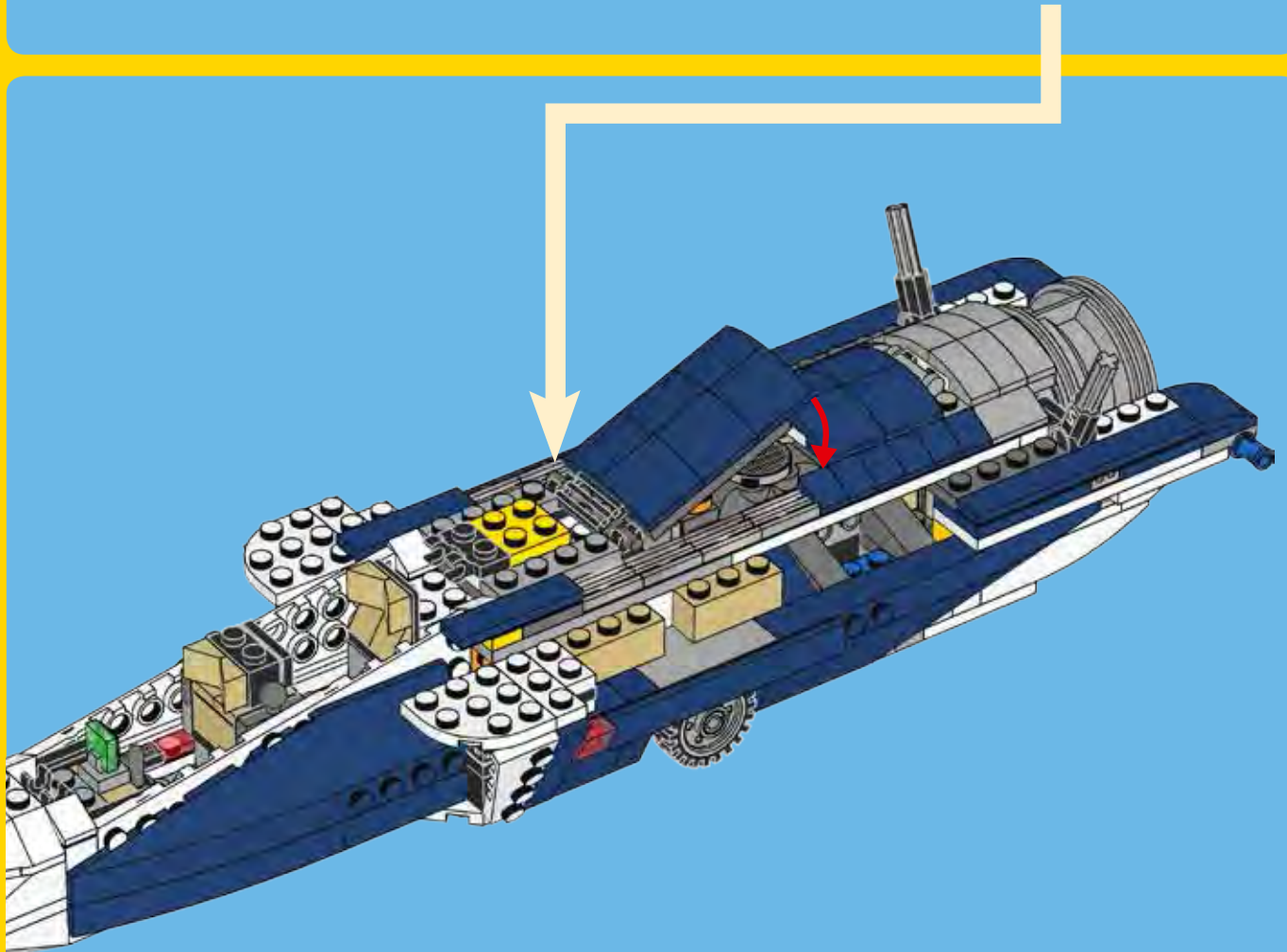
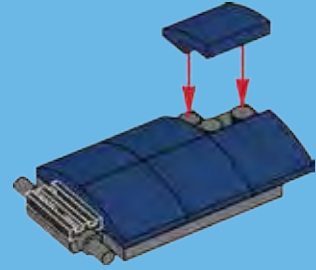



1x



2x



2x

75

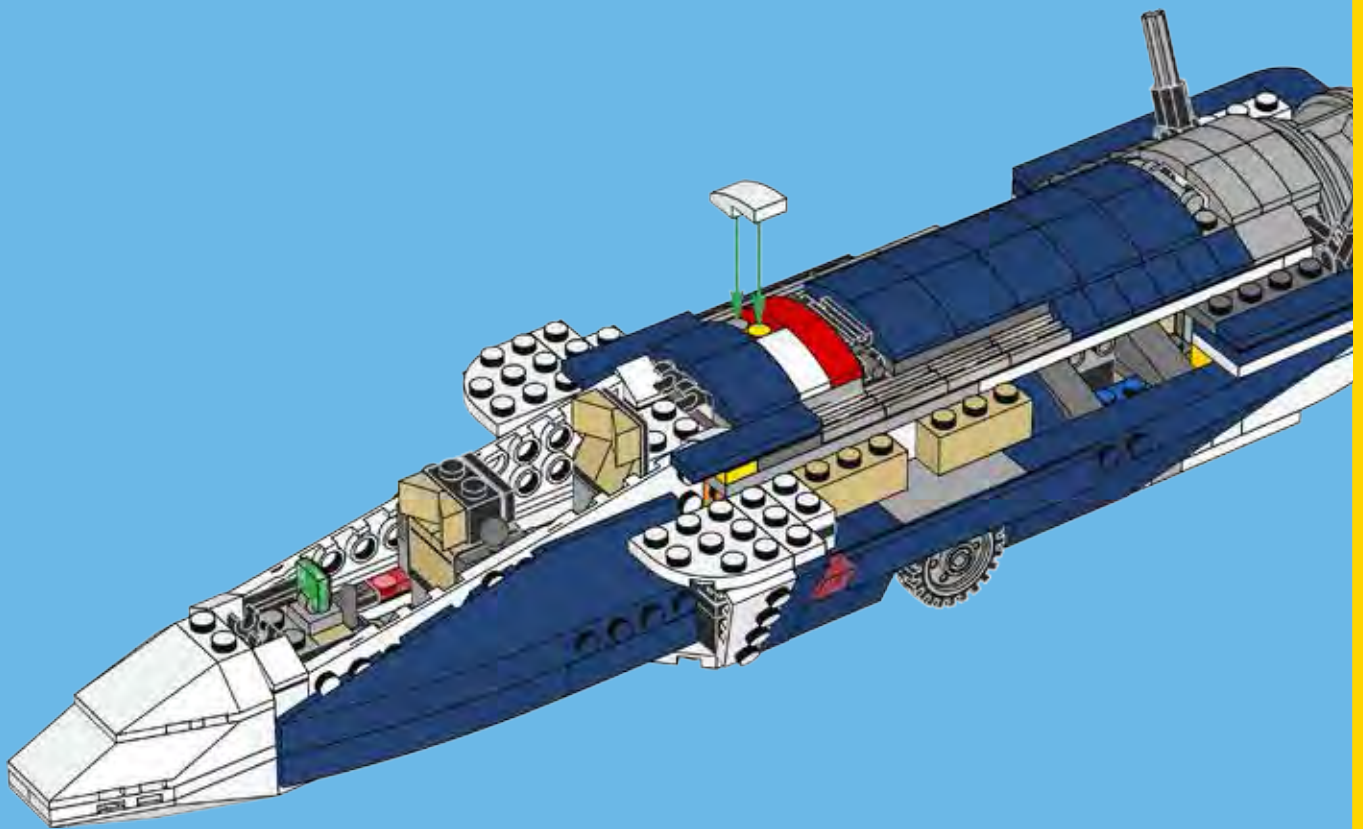

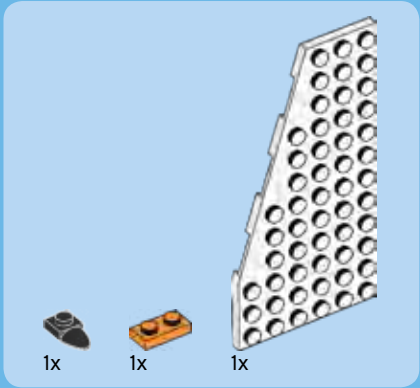

1

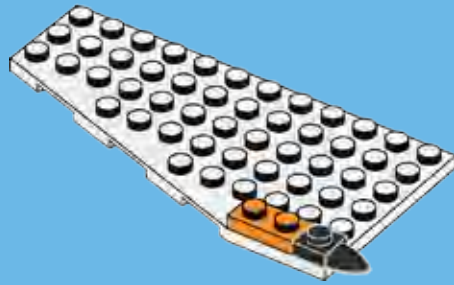

2

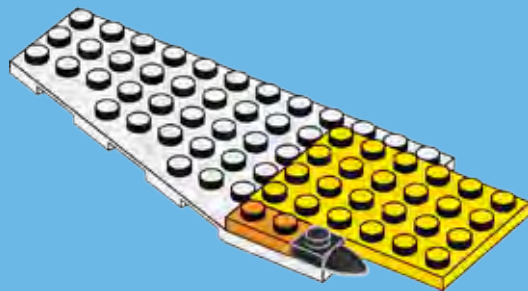



1x



1x



1x

3

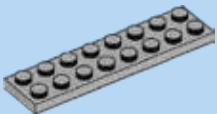
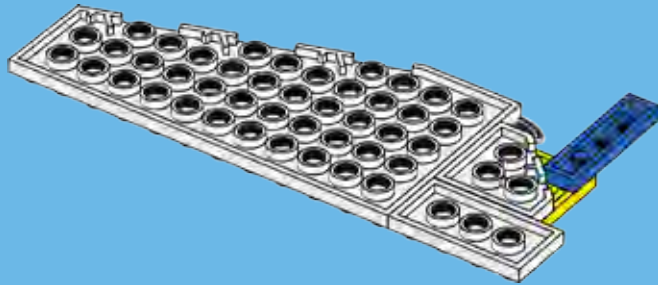

1x

4

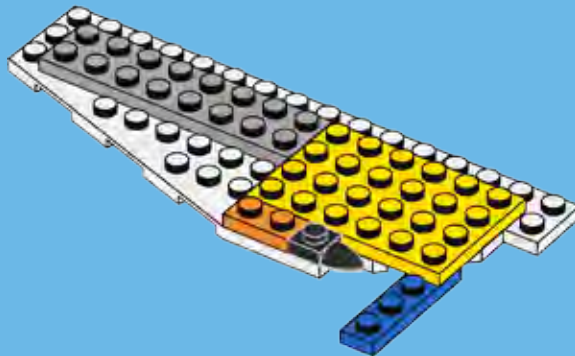

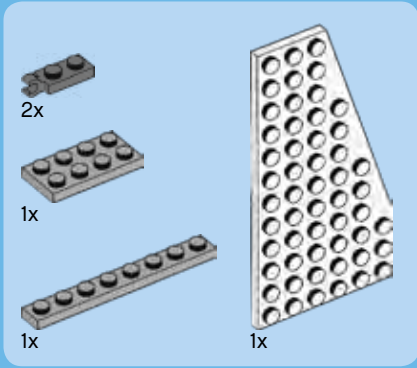

5

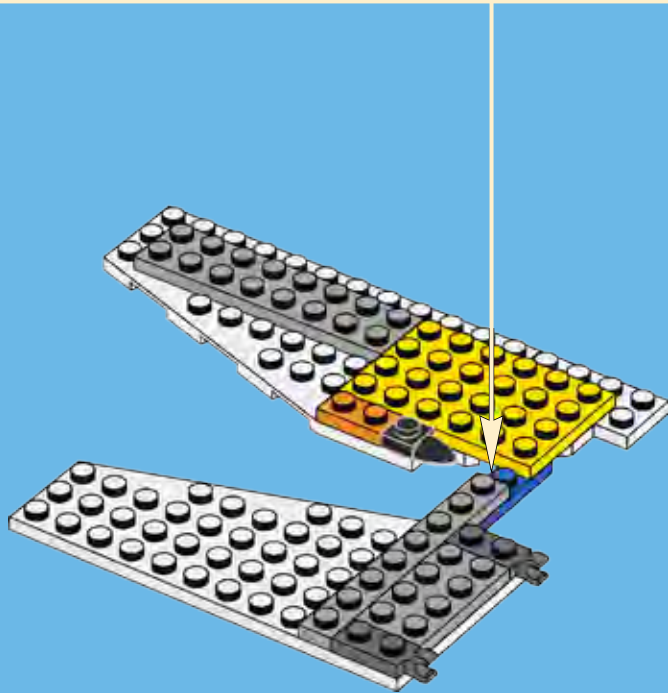
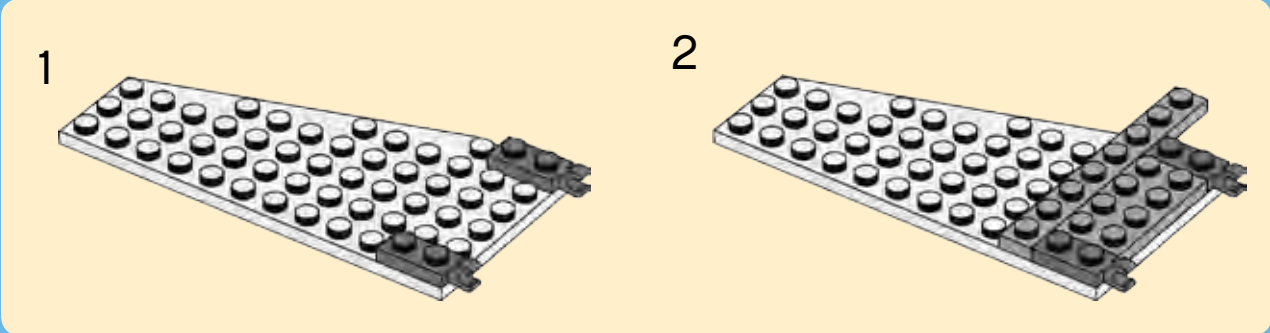



1x



1x



1x



1x

6

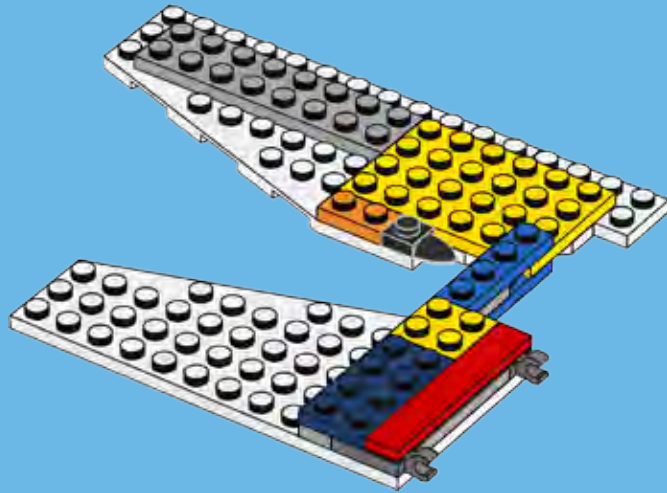

1x



1x



1x

7

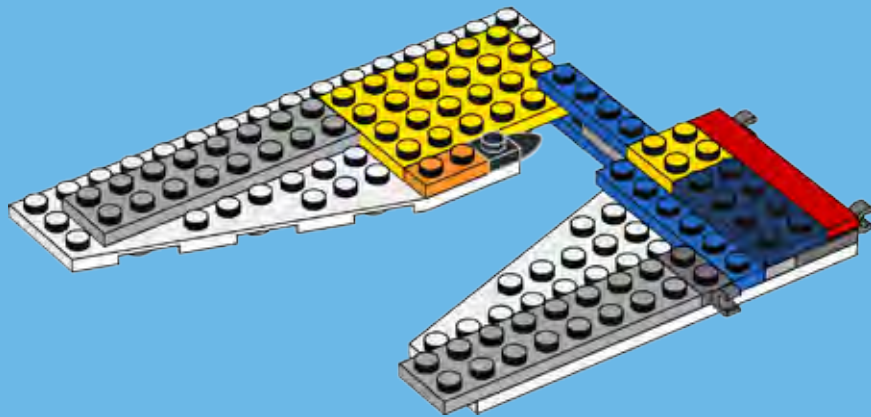



1x



1x

8

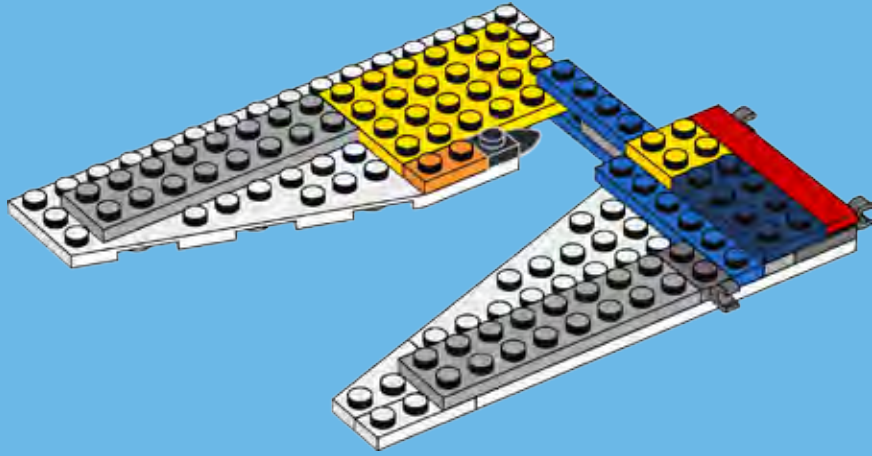

1x



1x



1x

9

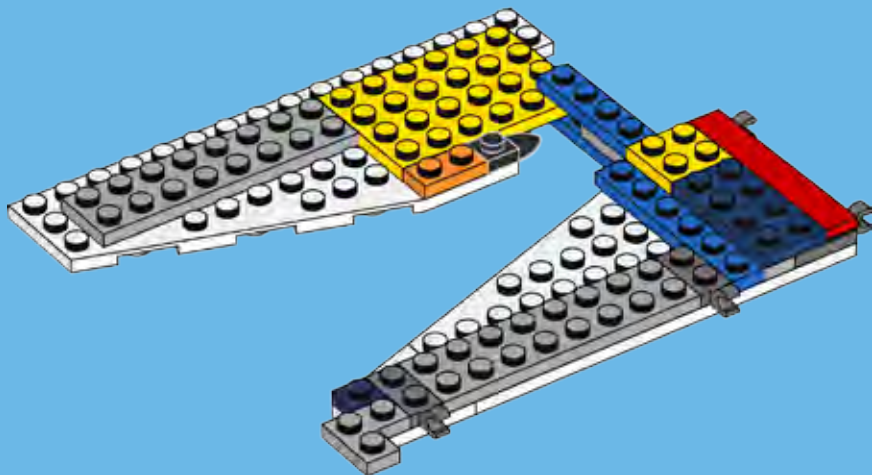



1x

10

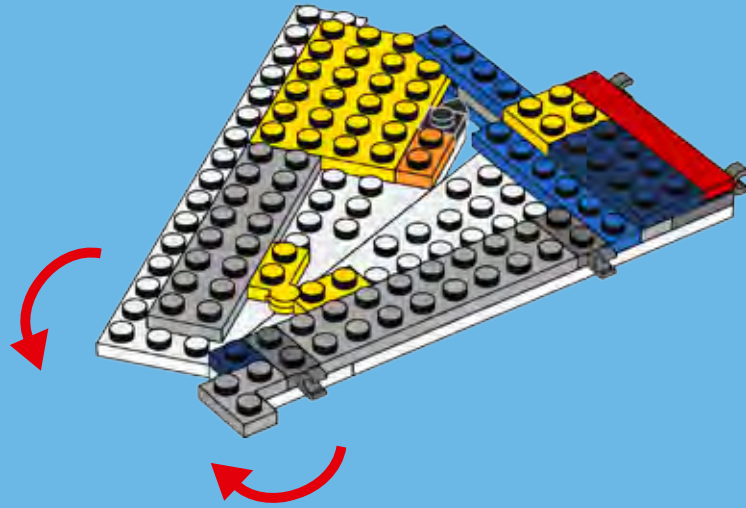

2x

11

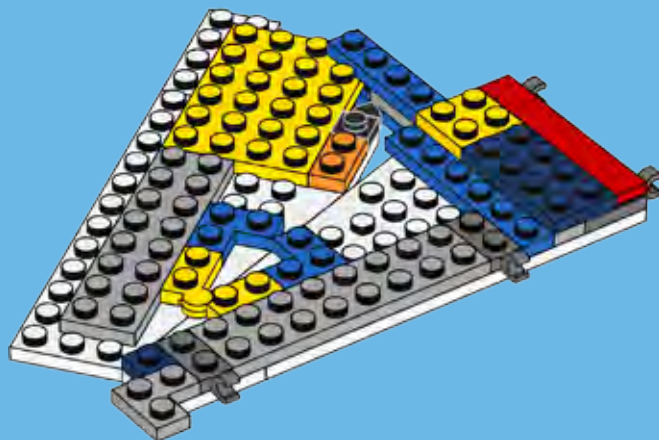



7x



1x

12

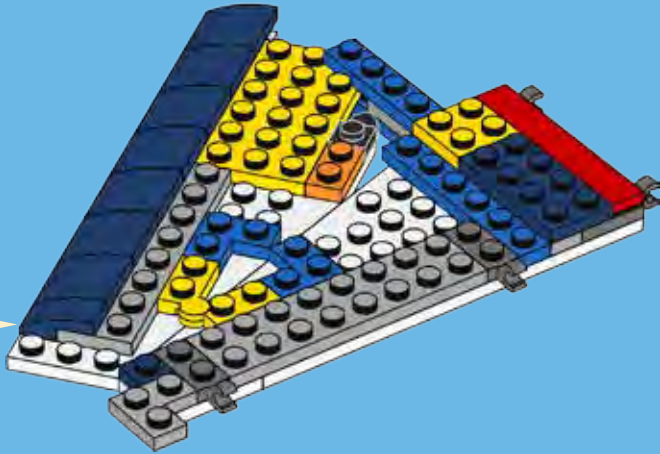

1x

13

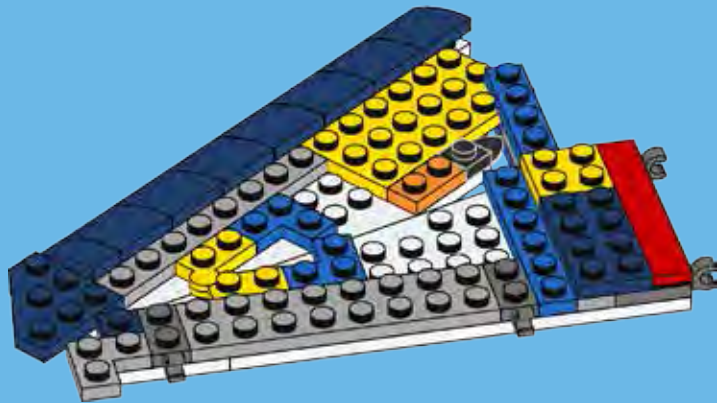

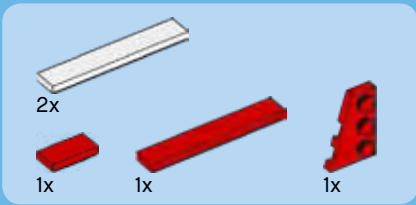

14

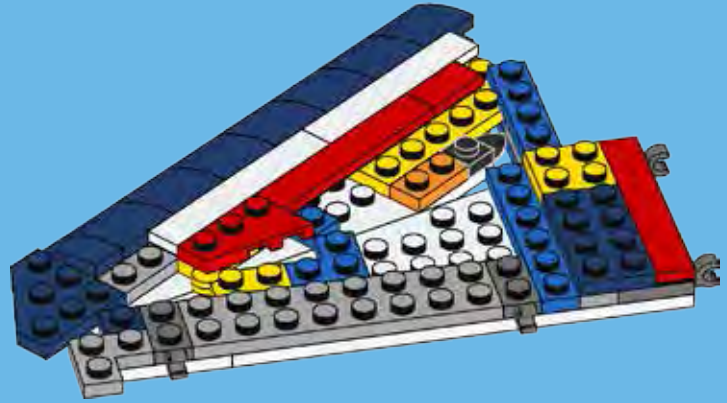

15

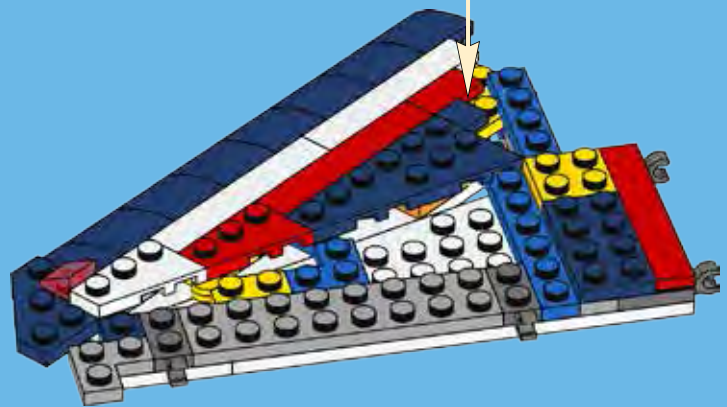

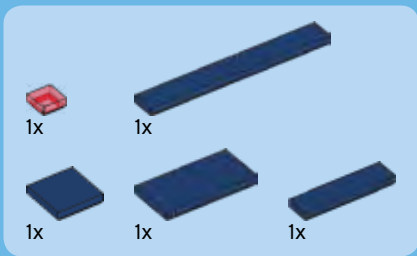

16

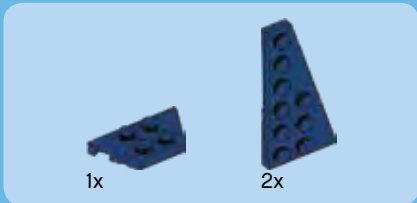
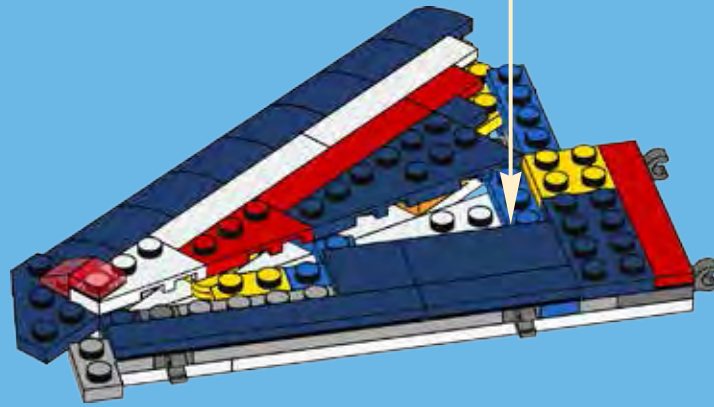

17

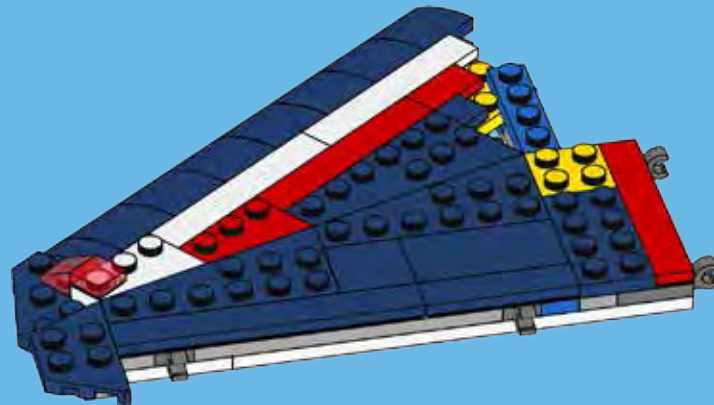

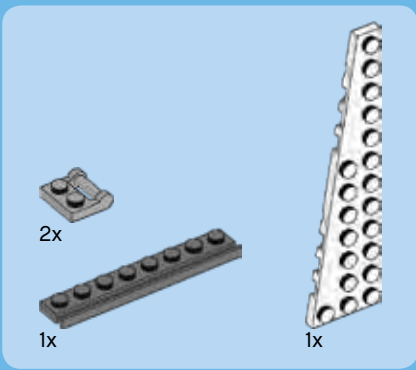

18

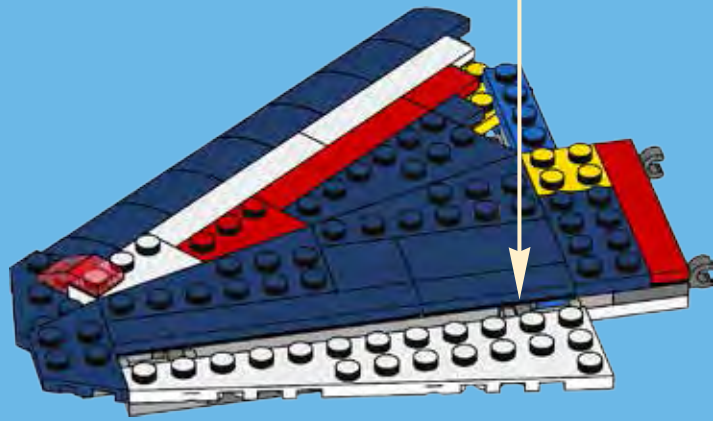
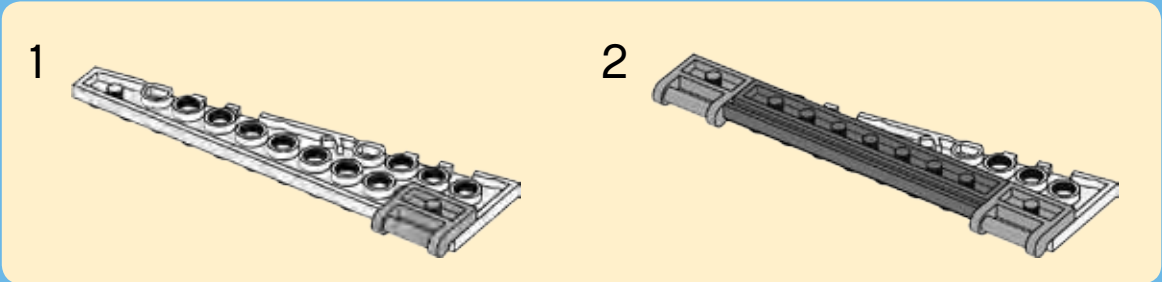

76

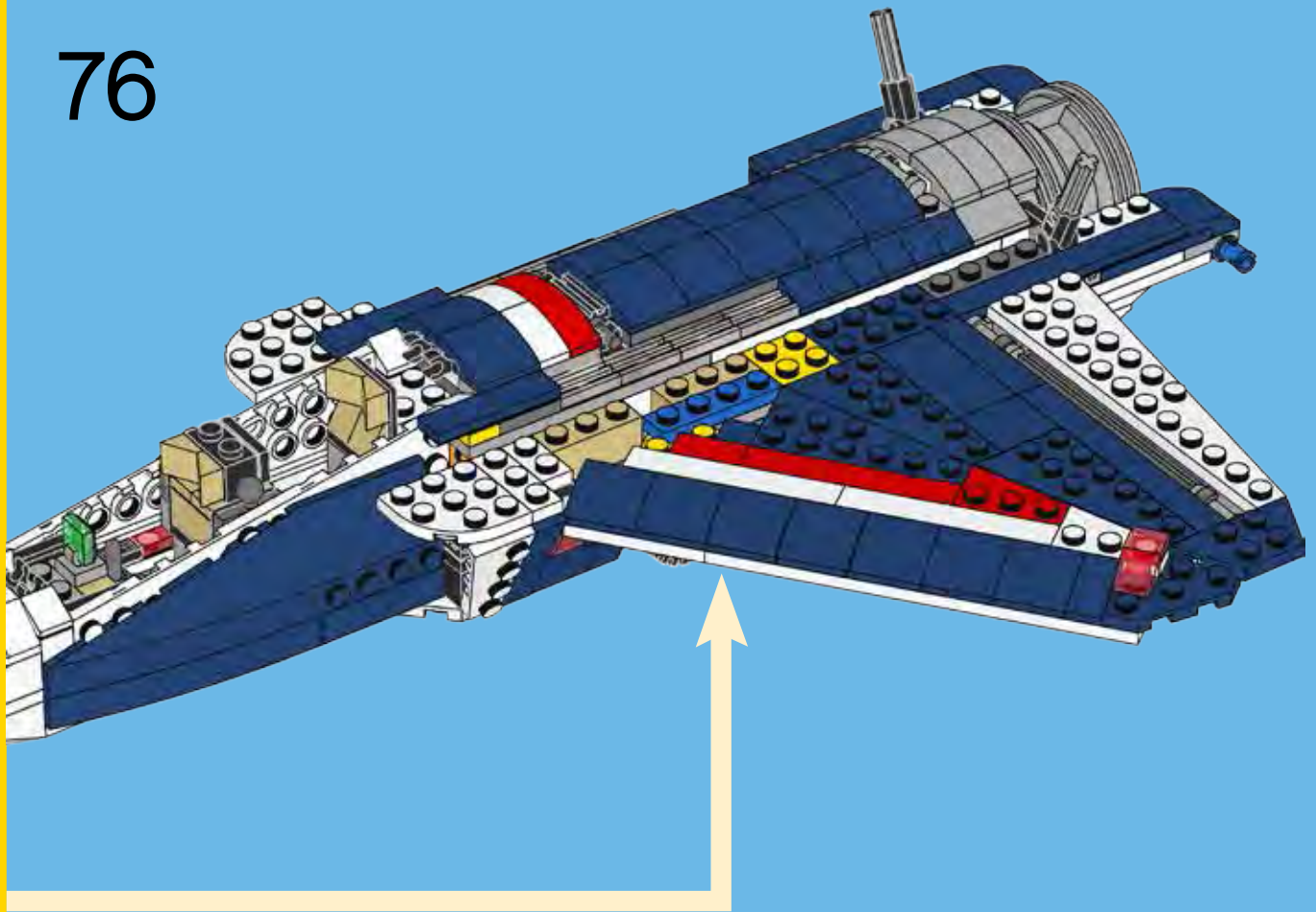

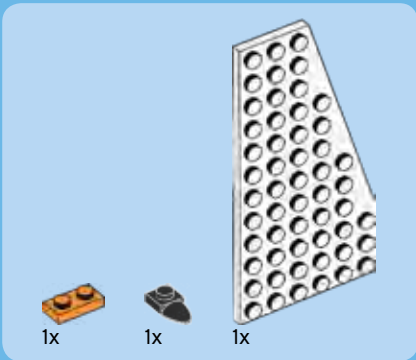

1



2



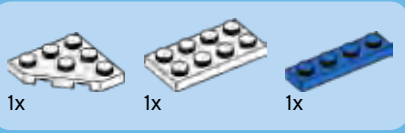

3

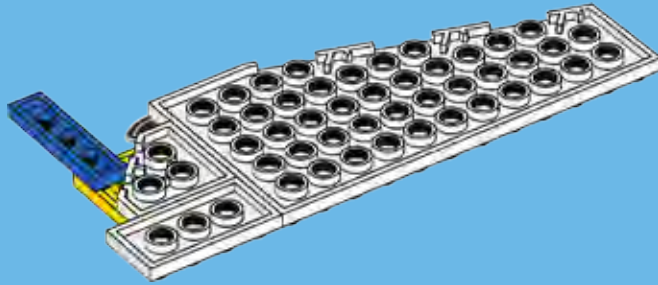

4

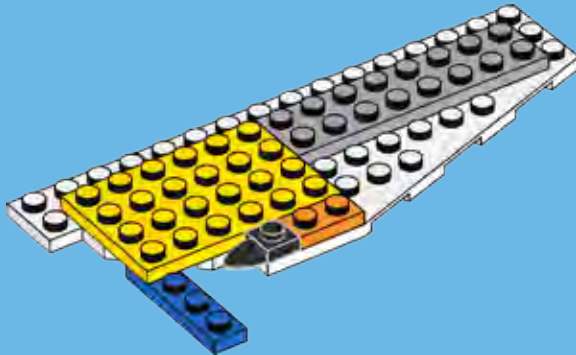

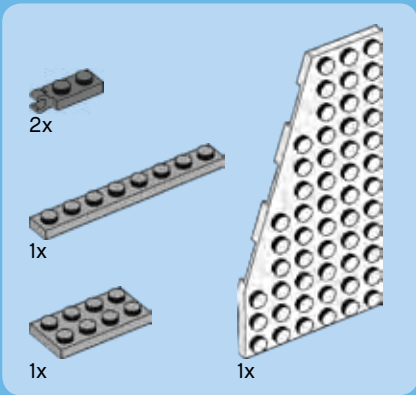

5

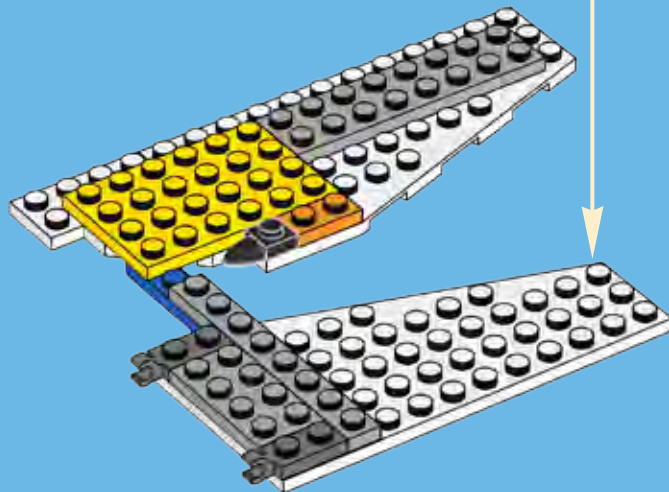
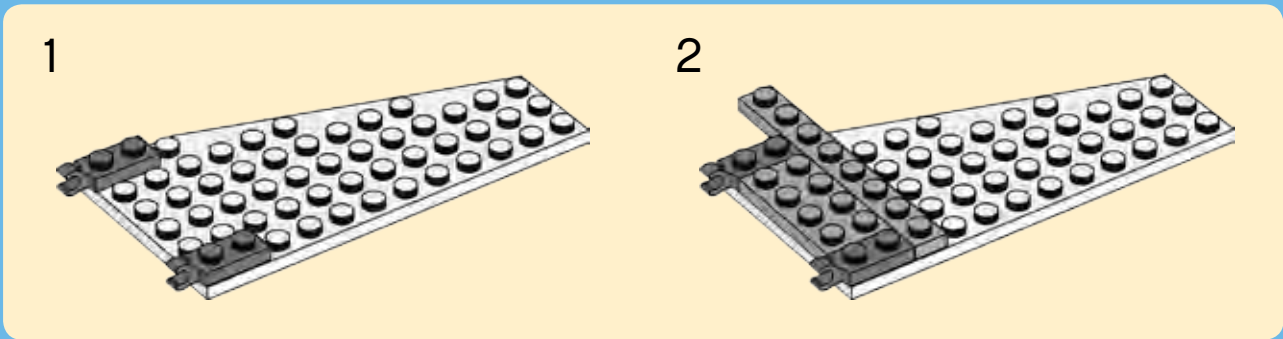



1x



1x



1x



1x

6

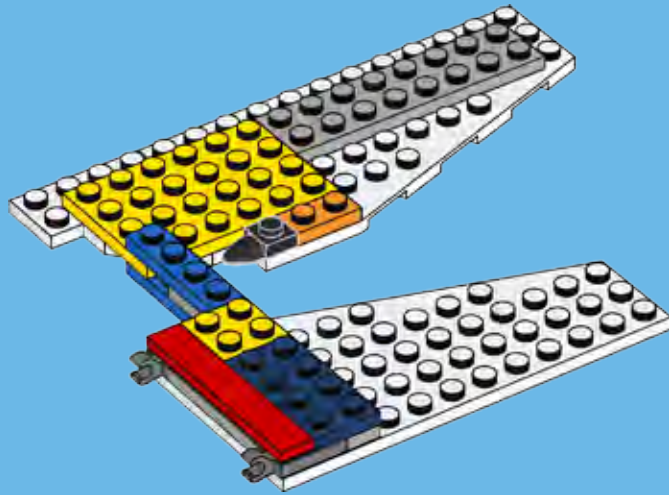

1x



1x



1x

7

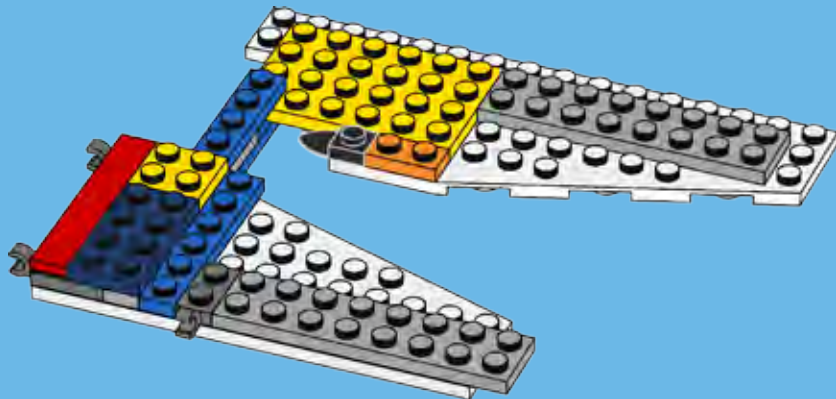



1x



1x

8

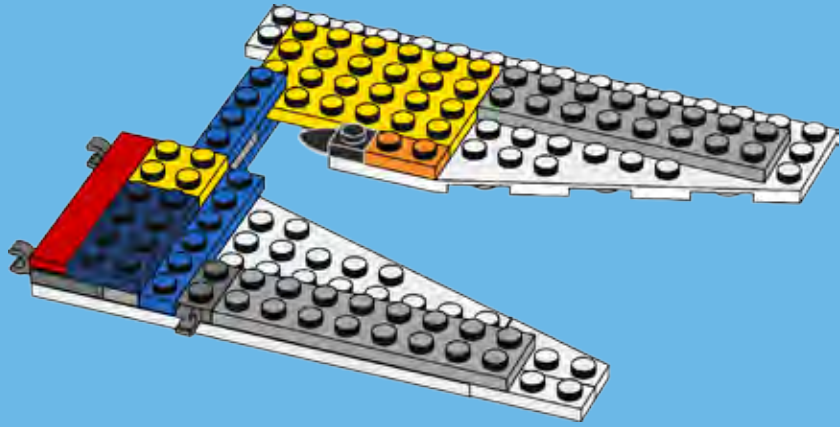

1x



1x



1x

9

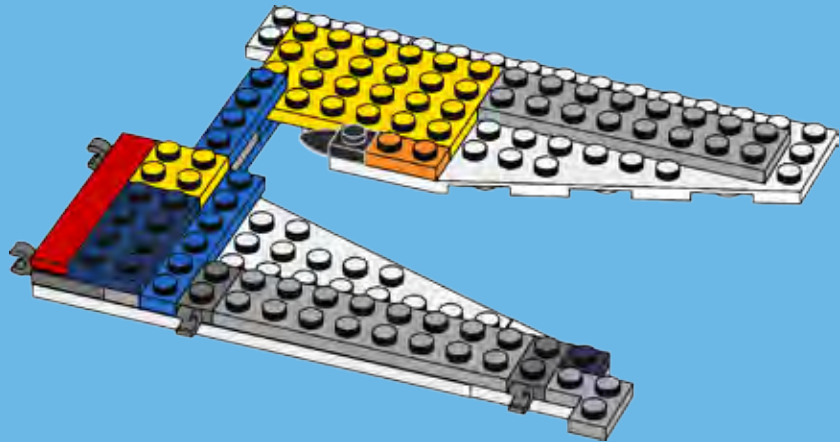



1x

10

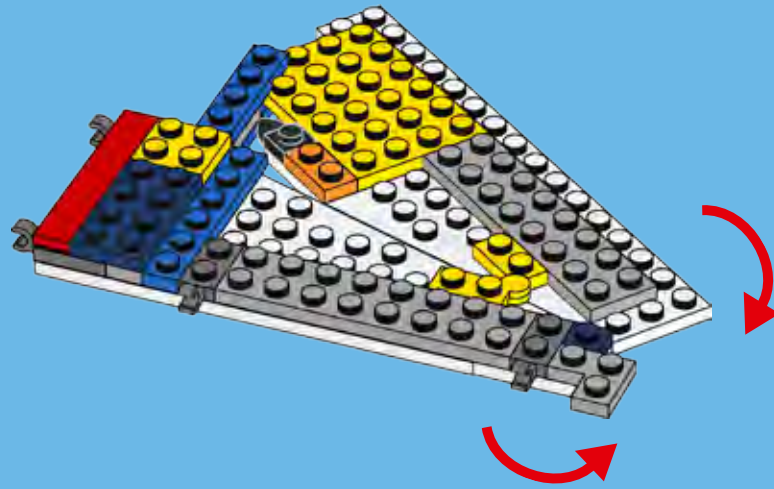

2x

11

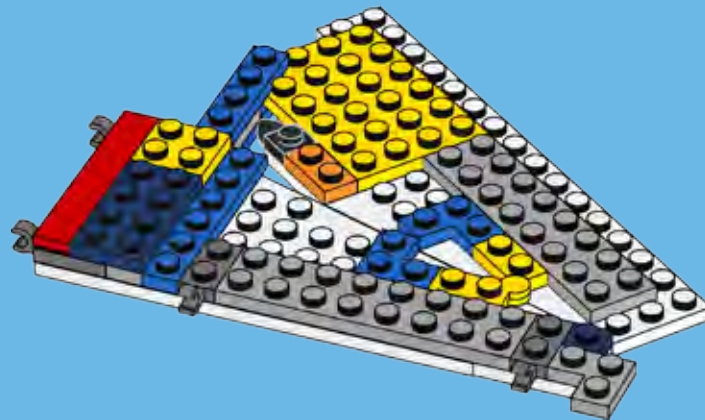



7x



1x

12

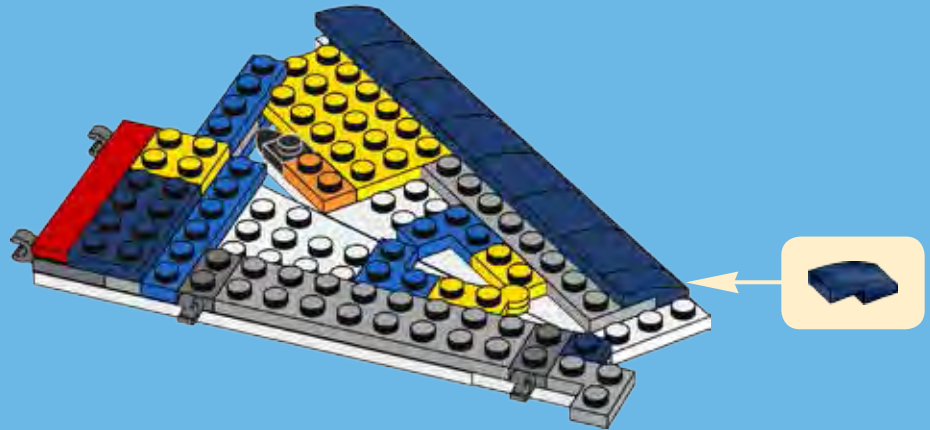

1x

13

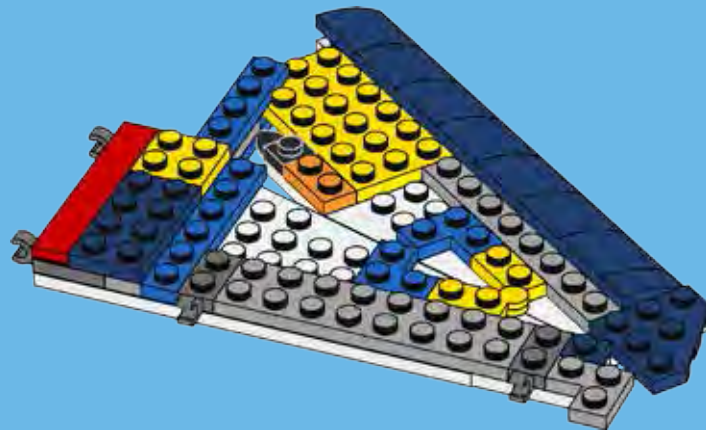

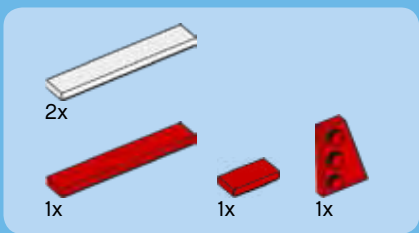

14

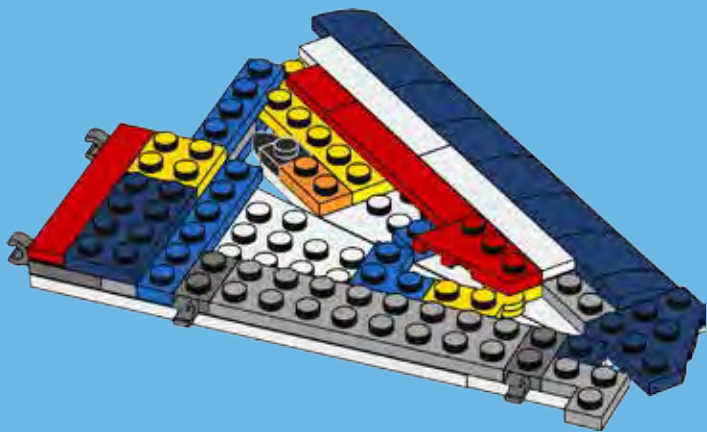

15

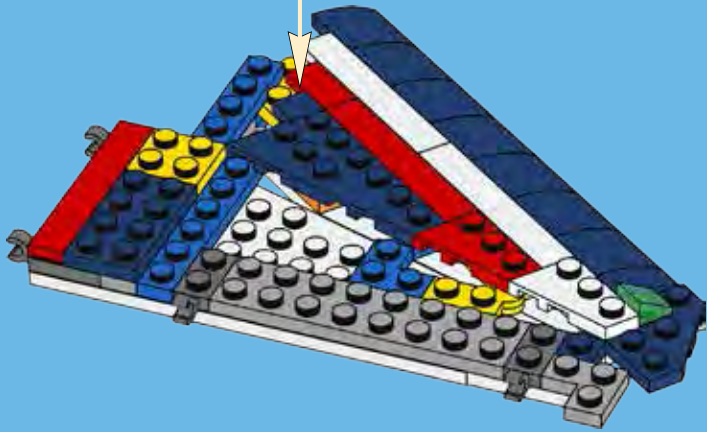

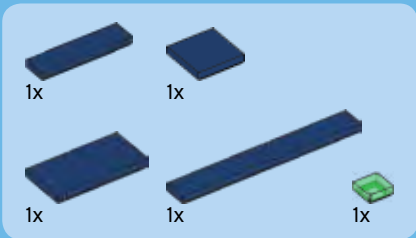

16

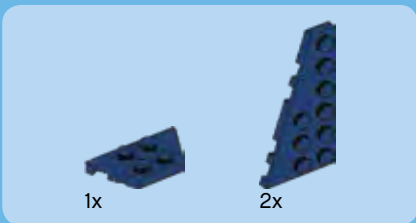
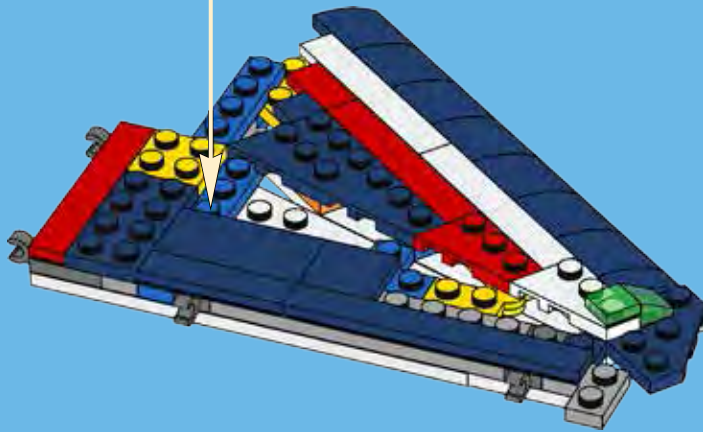

17

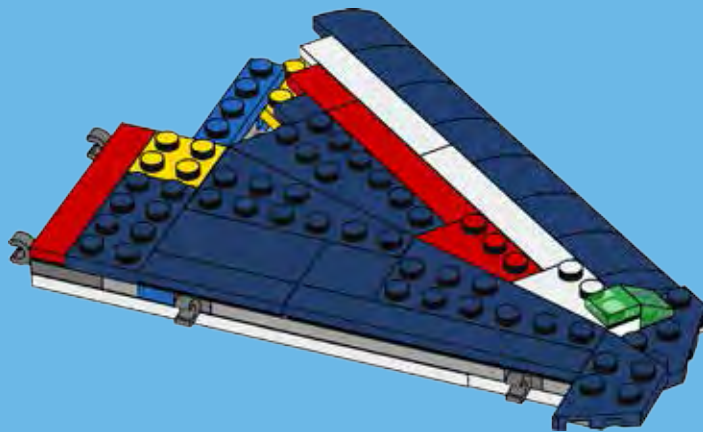

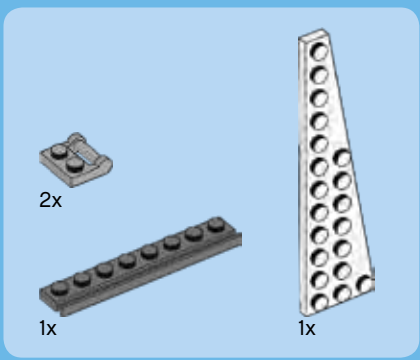

18

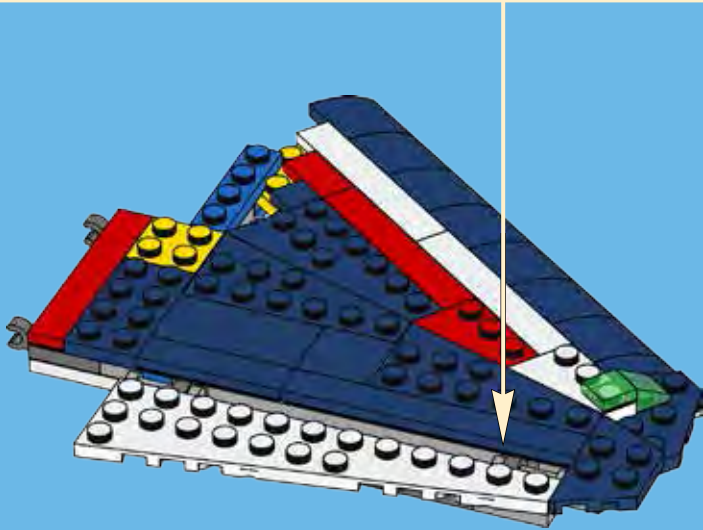
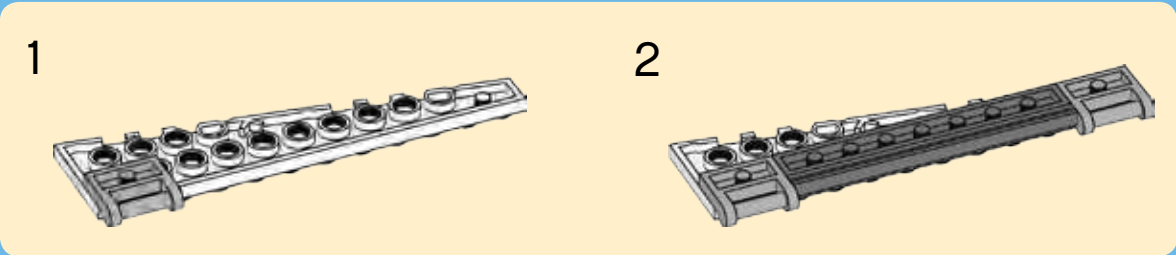

77

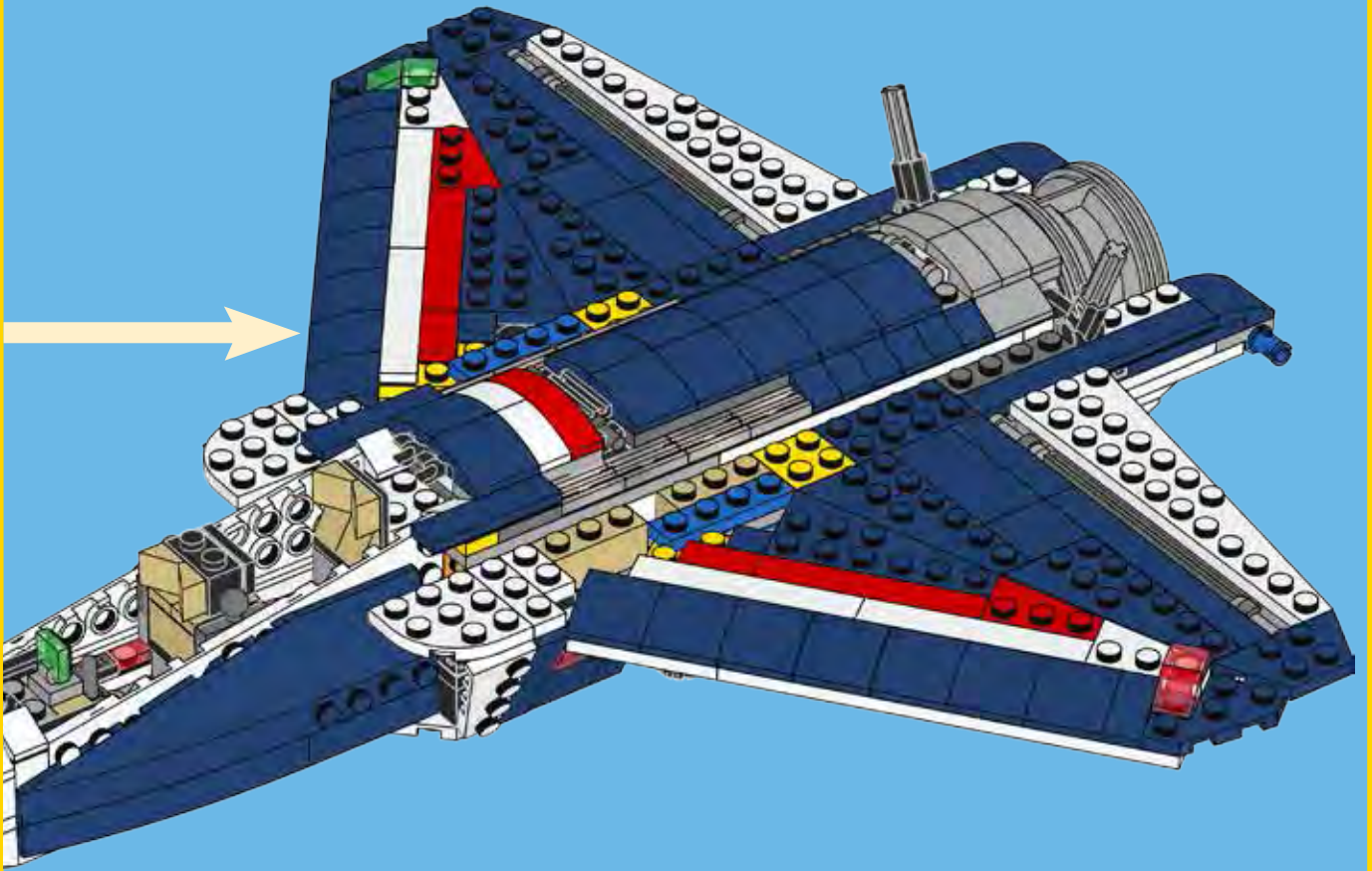

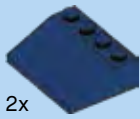

2x

78

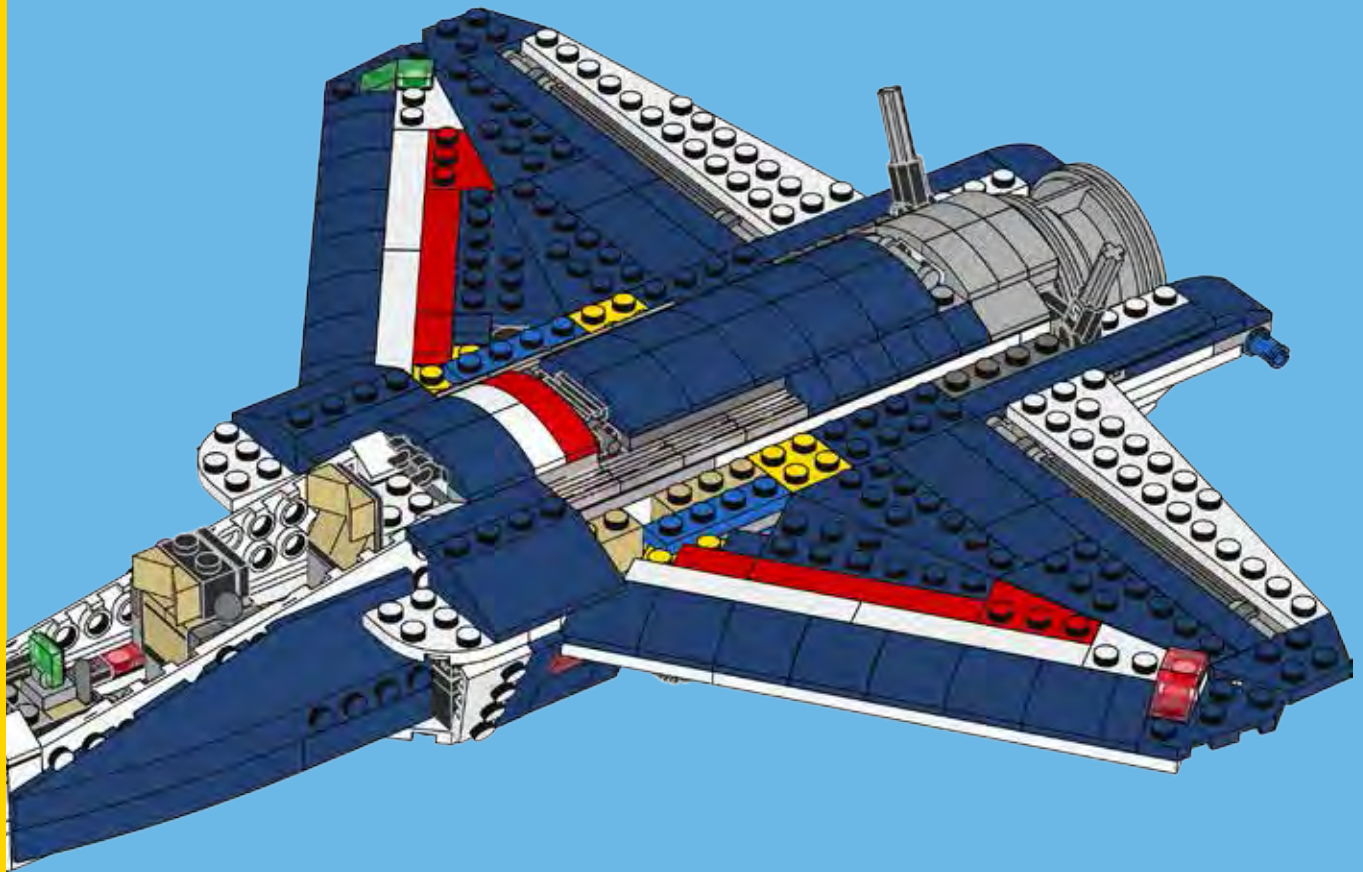

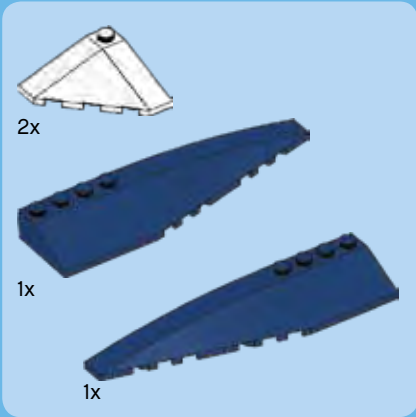

79

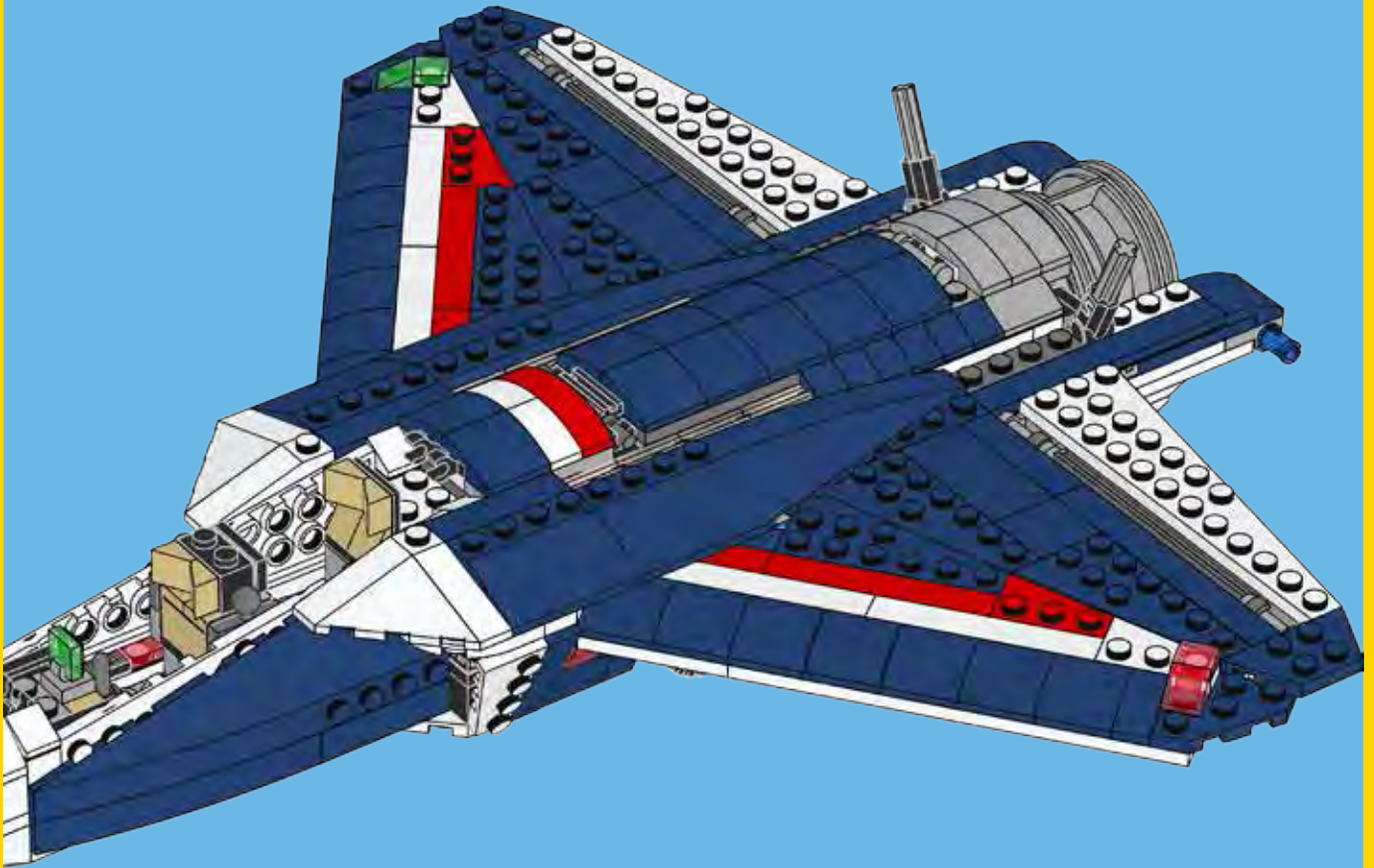



2x

80

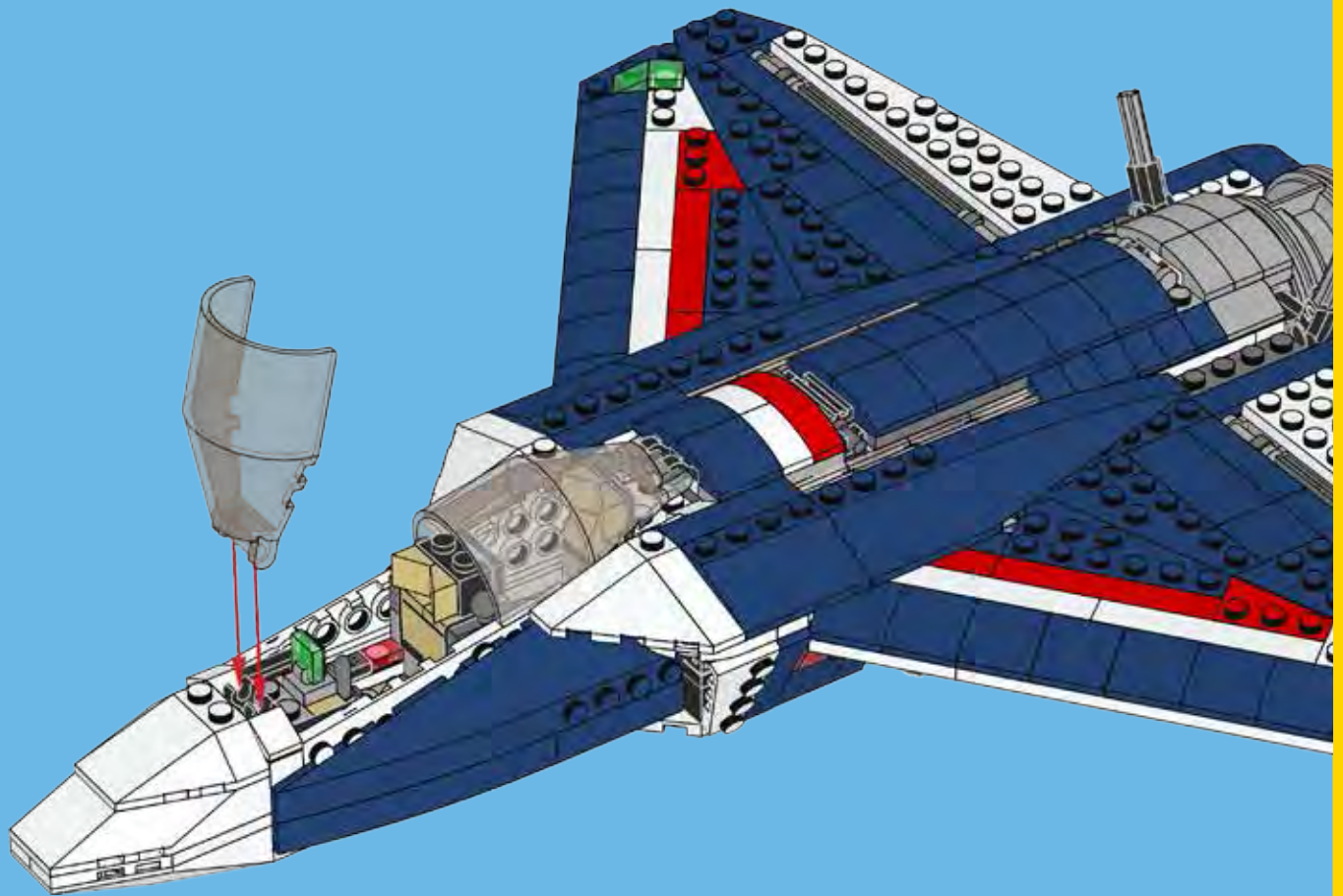



1x

1

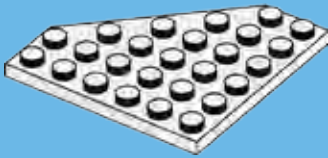

1x

2



1x



1x



1x

3

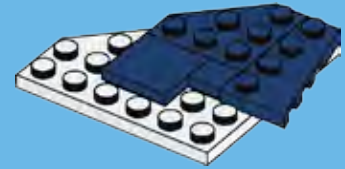

1x



2x

4

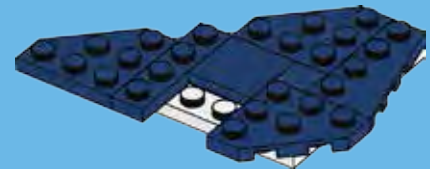



1x

5



1x



1x

6



81

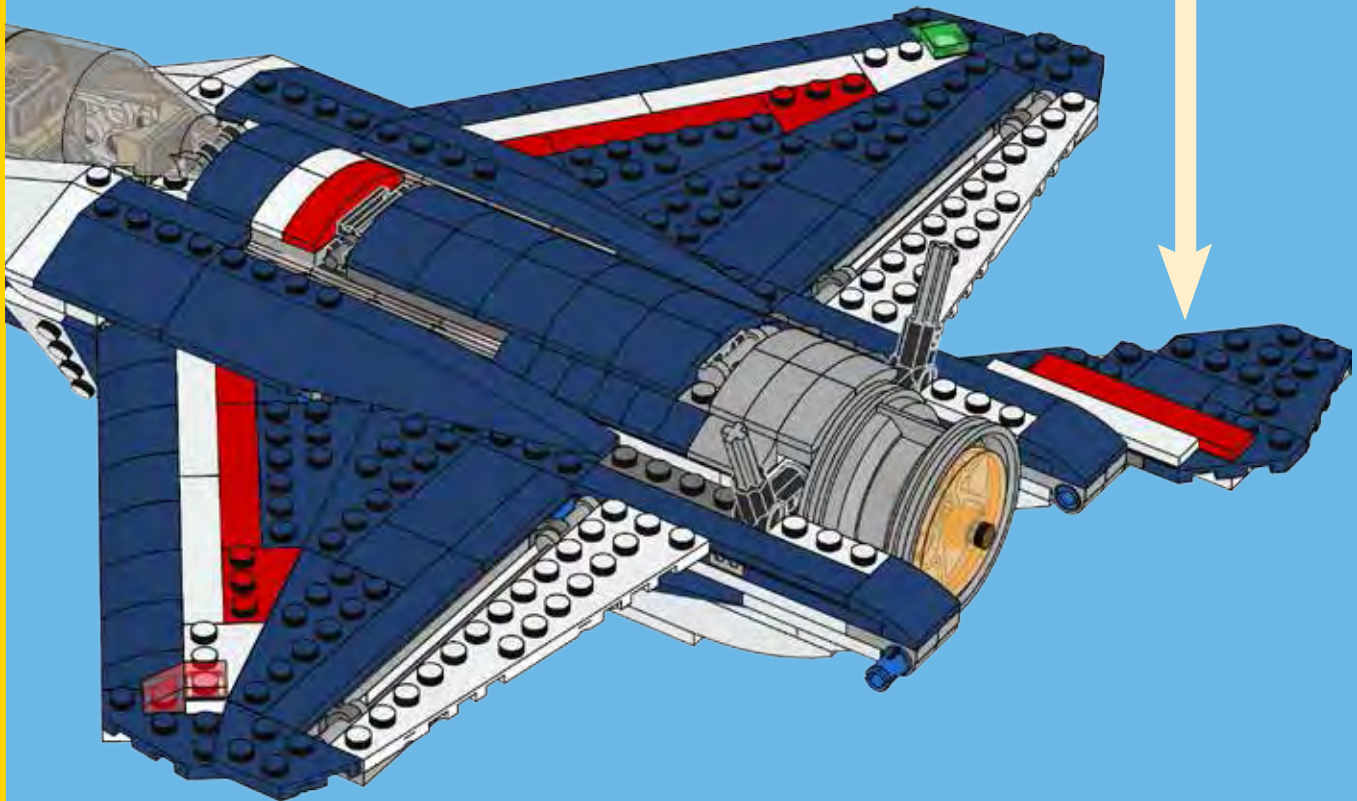

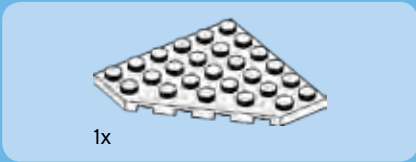
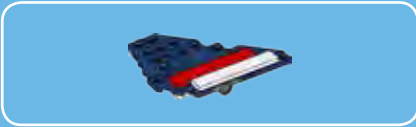

1x

1

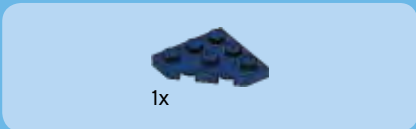

1x

2

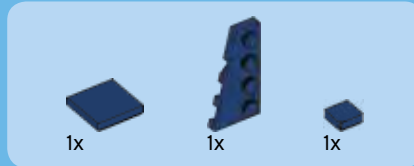
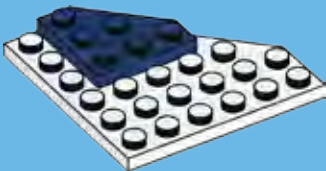

1x

1x

1x

3

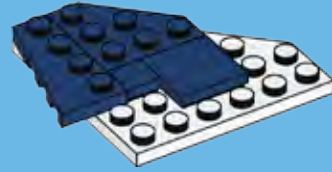

1x

2x

4





1x

5



1x



1x

6



82

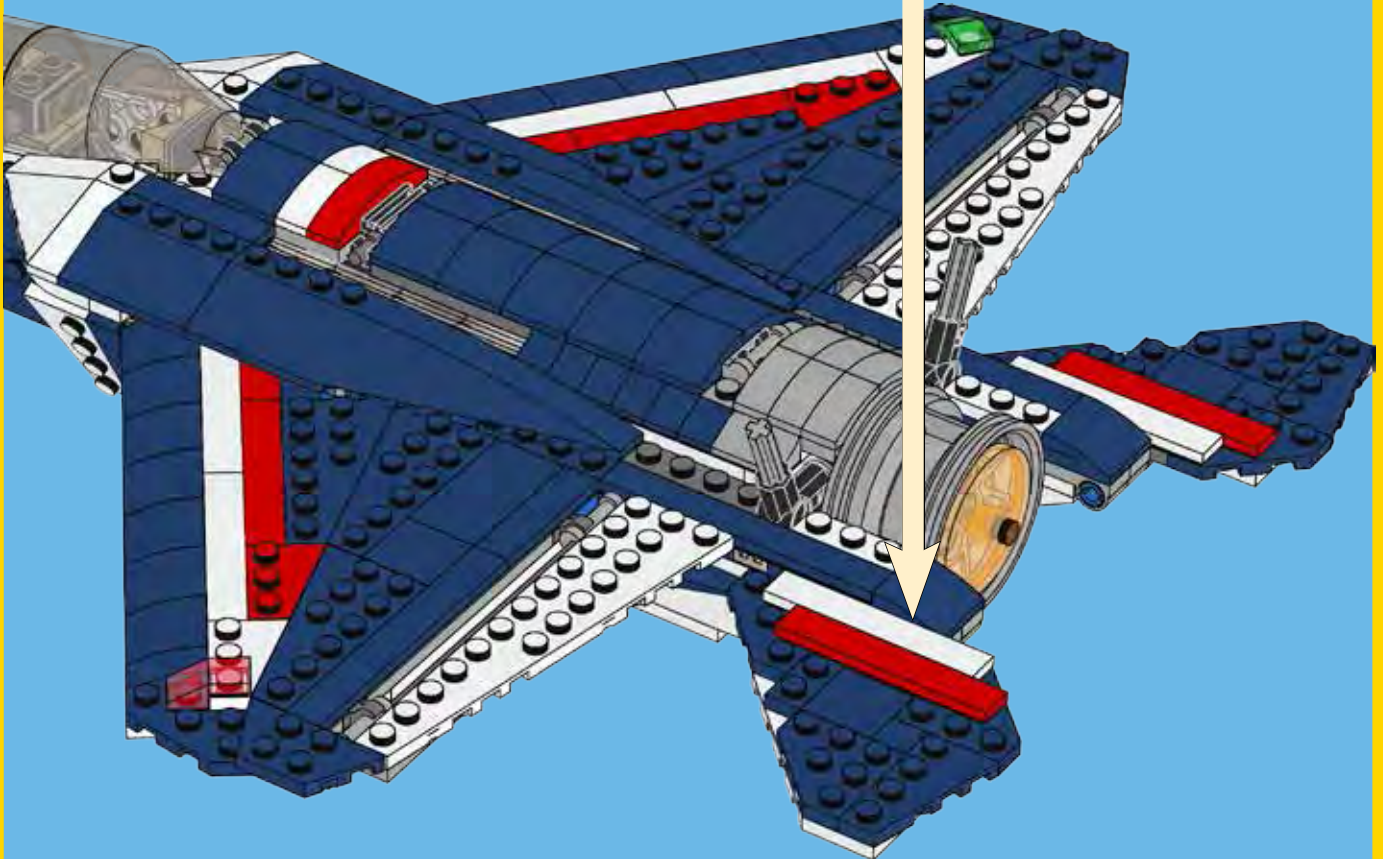



2x



2x

1

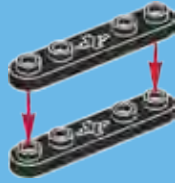

2x

2

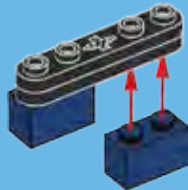

2x

3

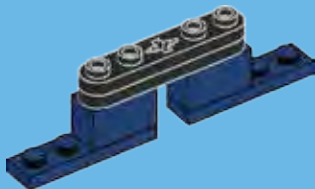

1x



1x

4

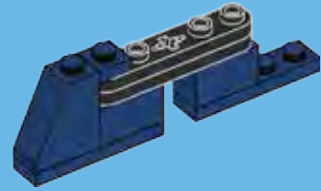

1x



1x

5

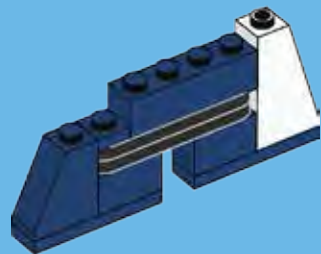



1x

6

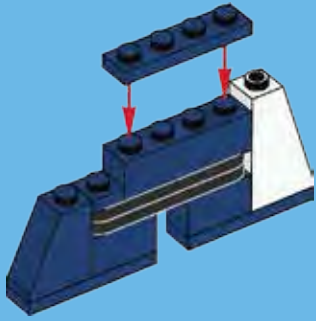

1x



1x

8

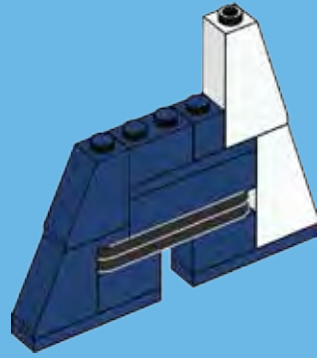

1x



1x

7

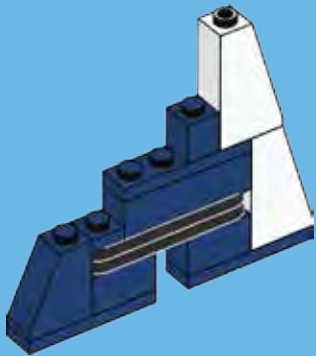

1x

9

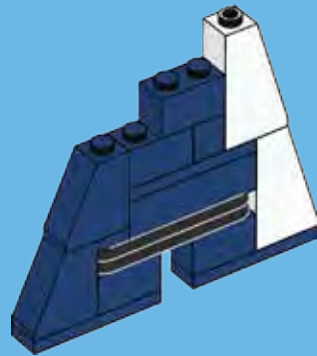



1x



1x

10

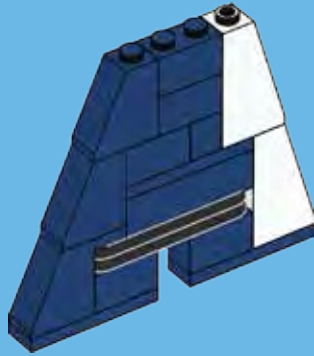

1x

11

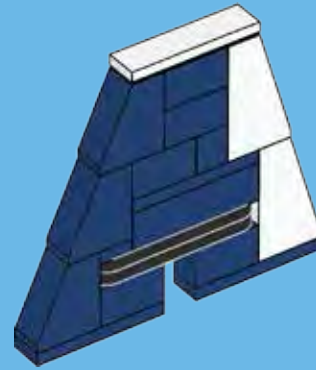

2x

83

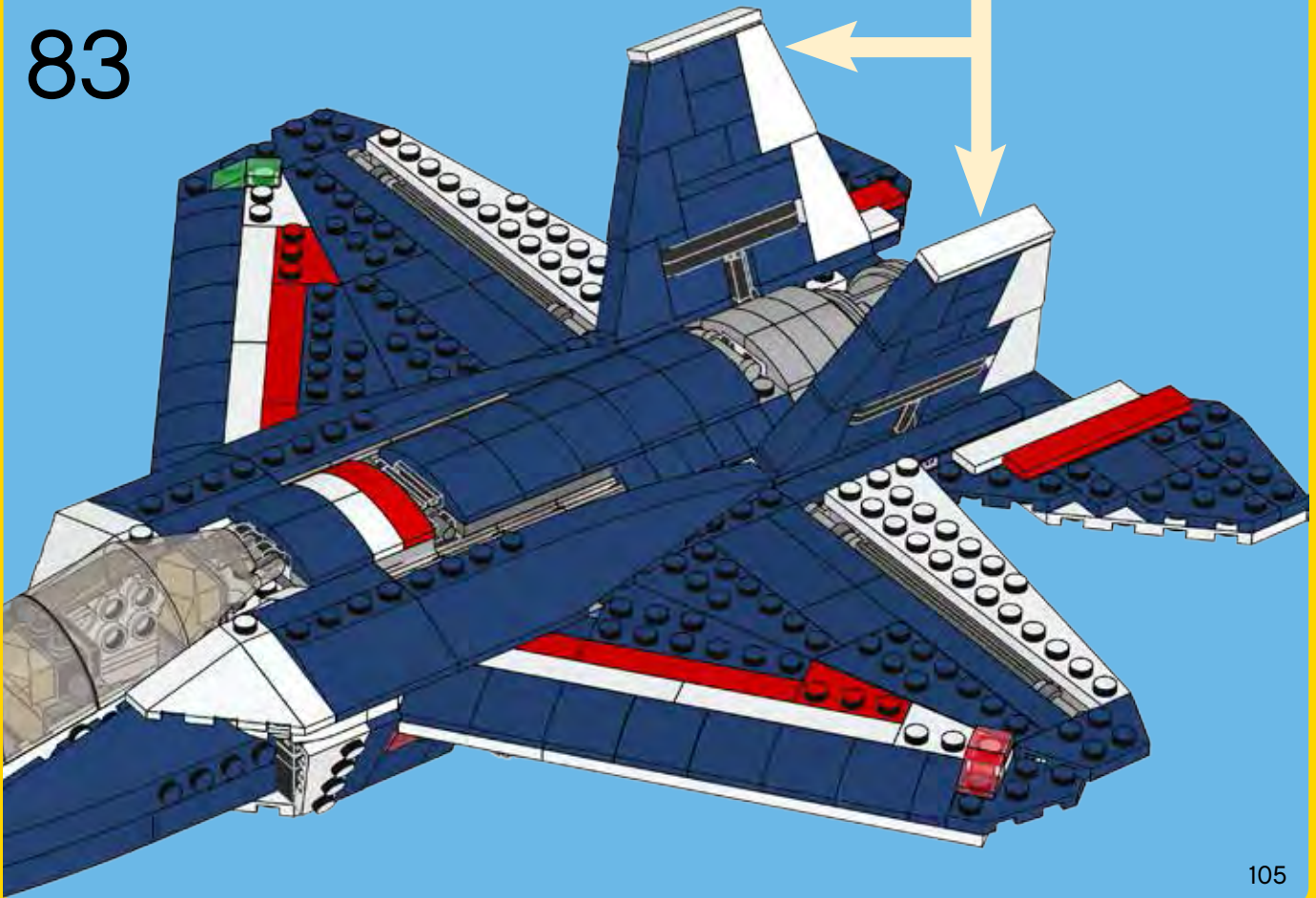

84

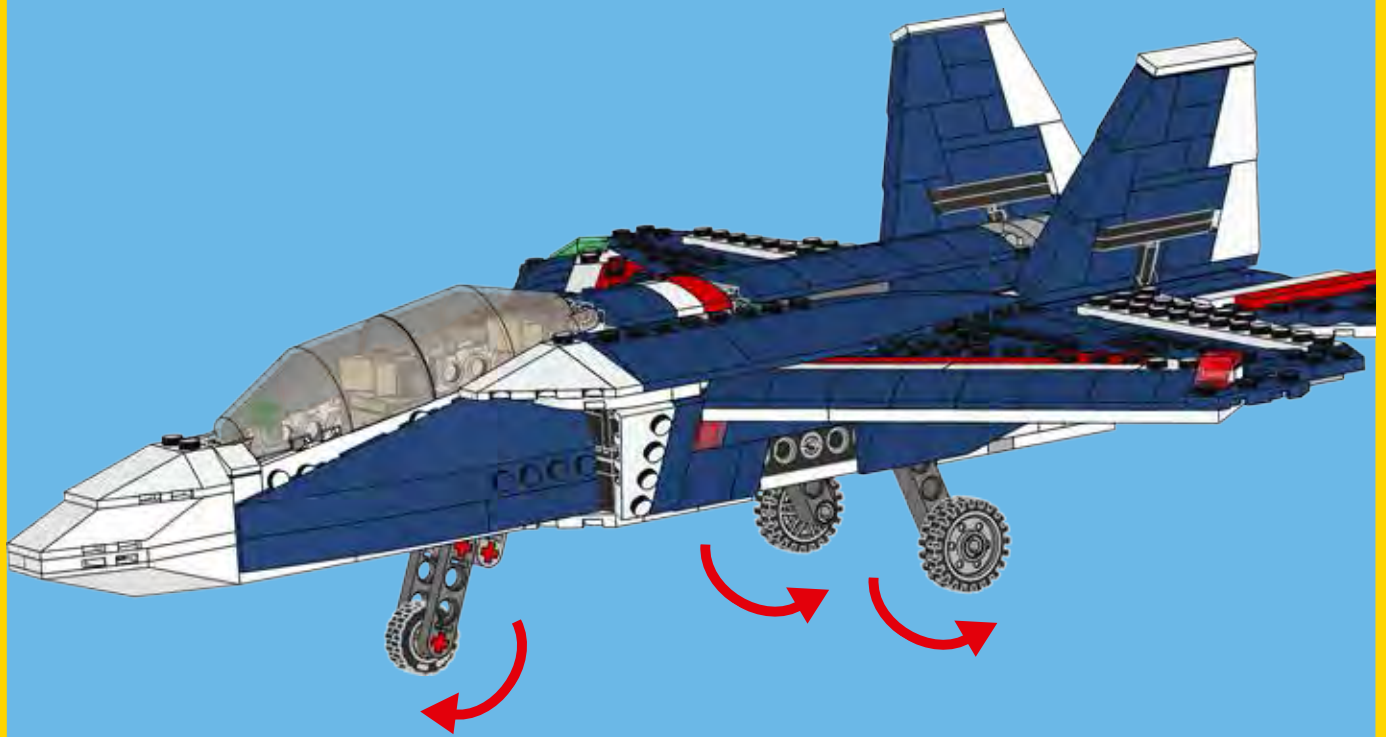

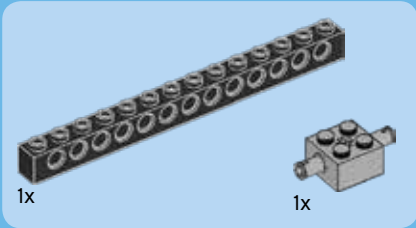

1

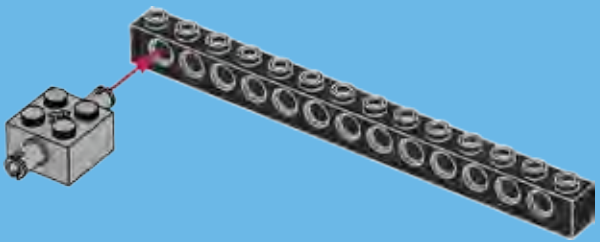



1x



1x



2x



1x



1x



2x

2

1



2



3



4



5



6

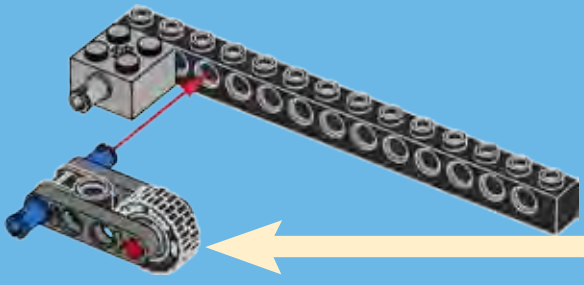

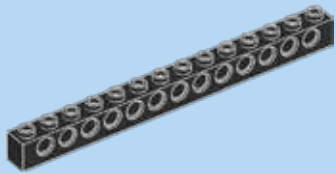

1x

3

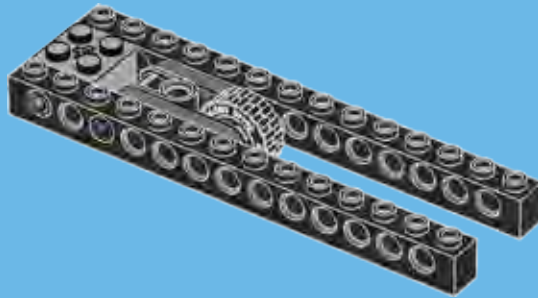

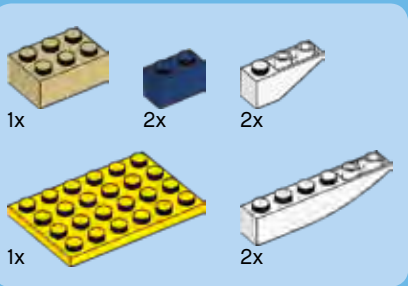

4

1

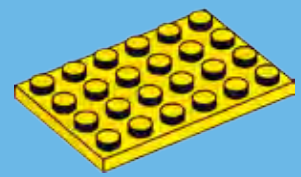

2



3

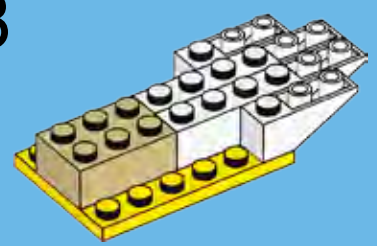

4

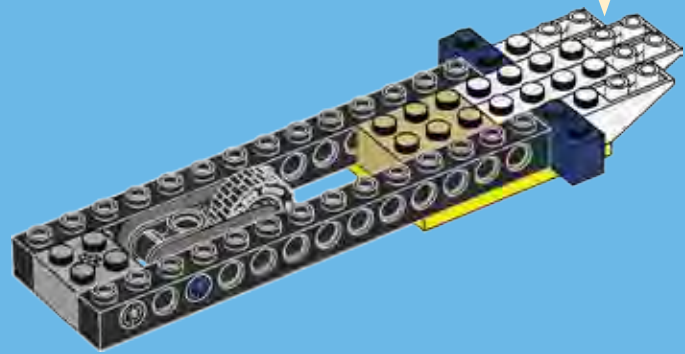
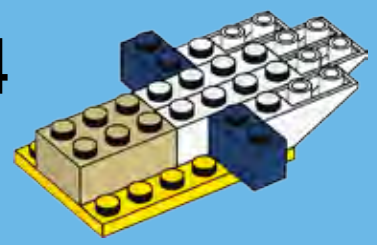

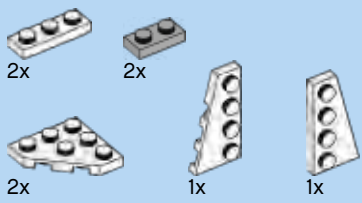

5

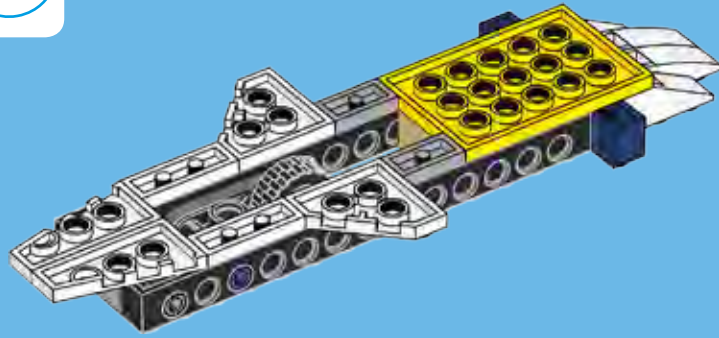

6

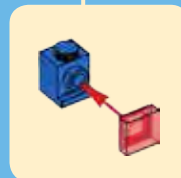
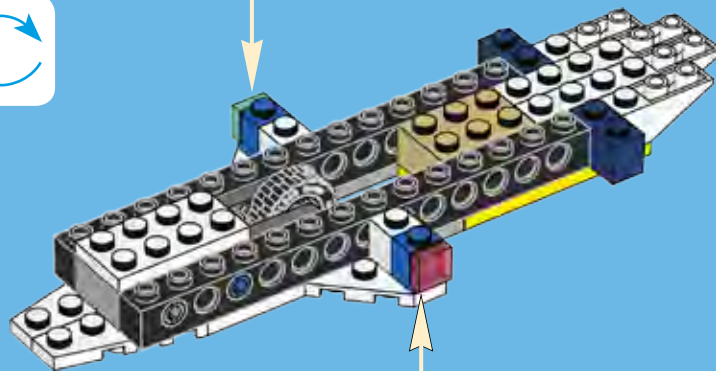
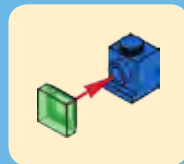



2x



1x



2x

7

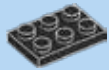
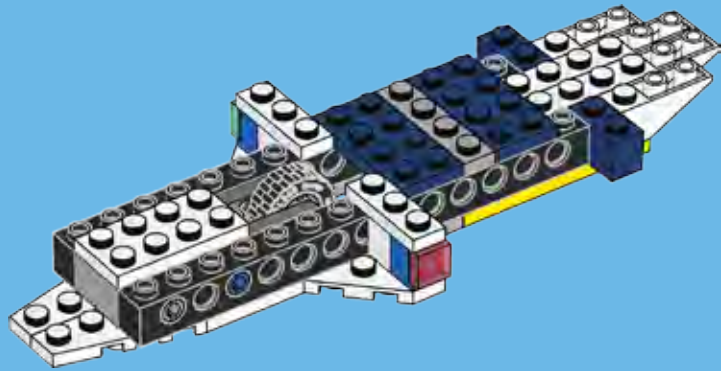

1x

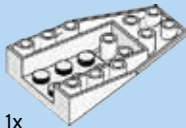

1x

8

1

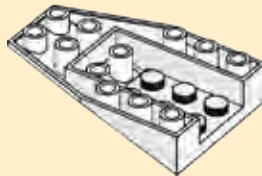

2

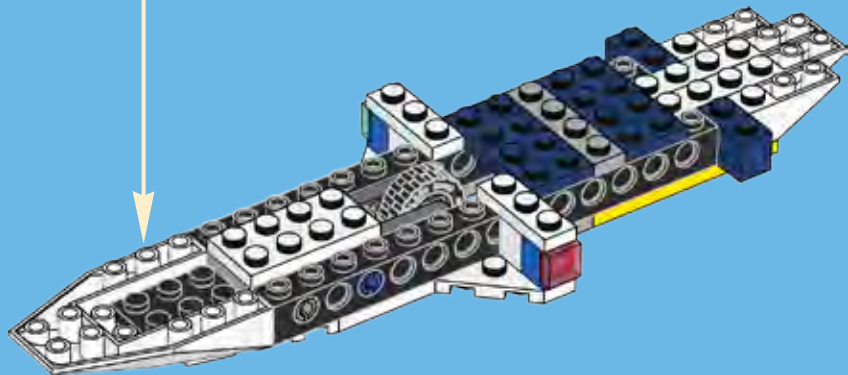
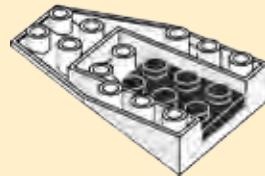



2x



2x



2x

5



5

1:1

9

5



2x

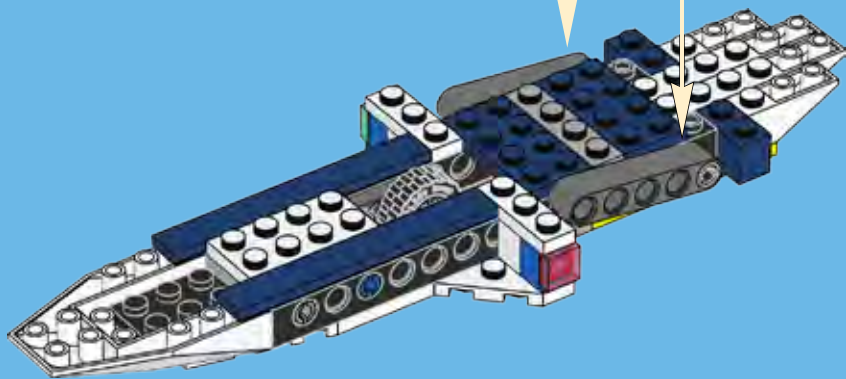

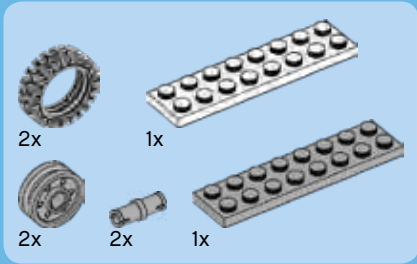

10

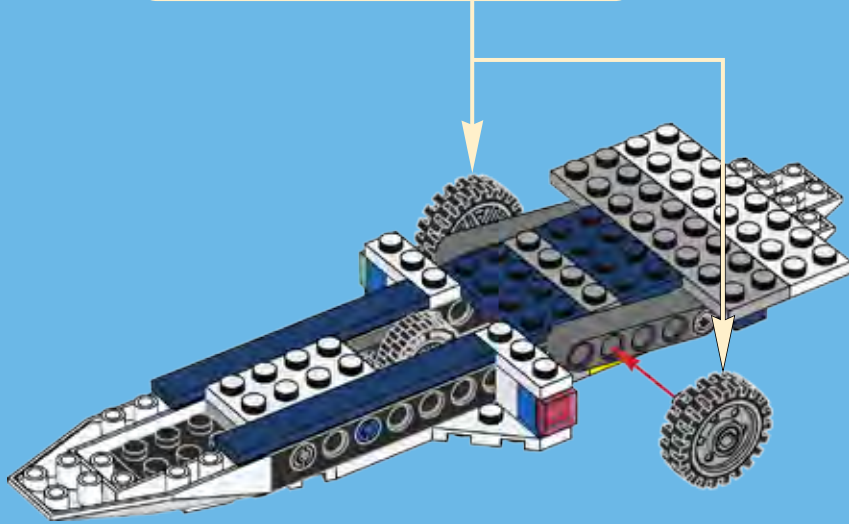
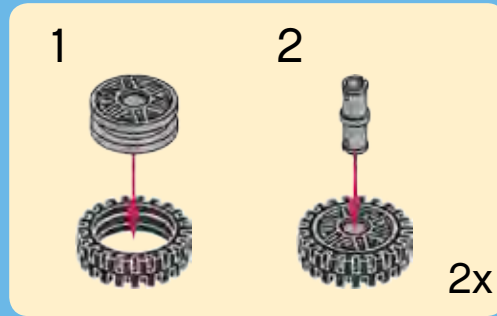



1x



1x



2x



1x

11

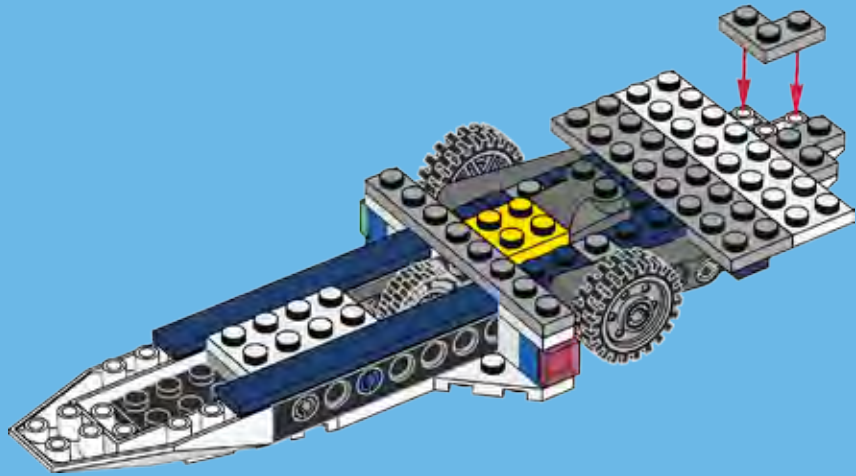

1x



2x

12

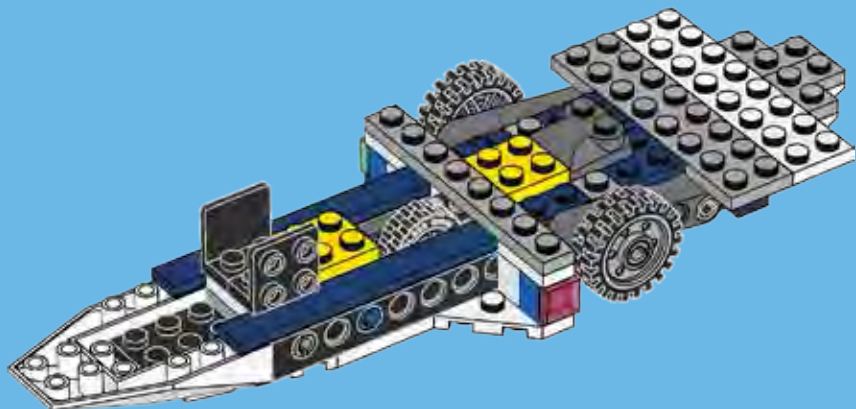

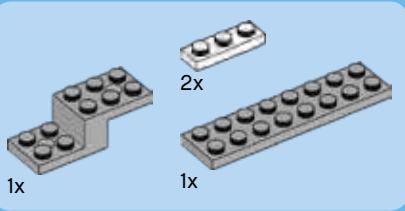

13

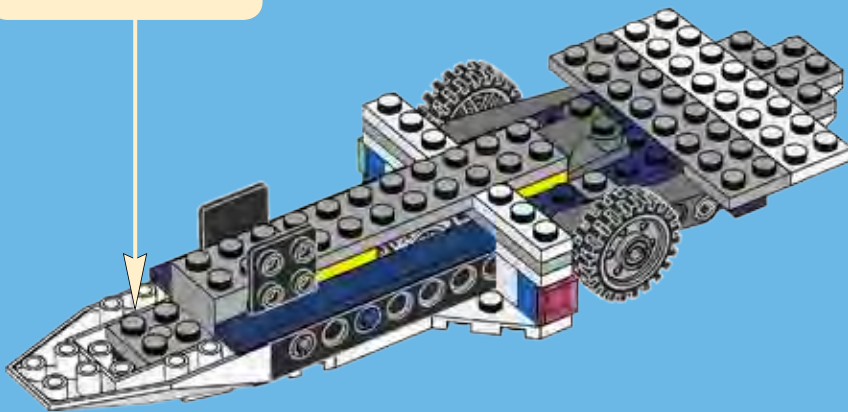
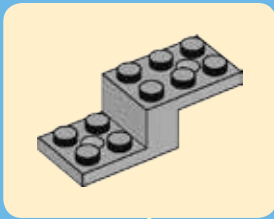

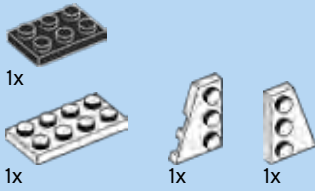

14

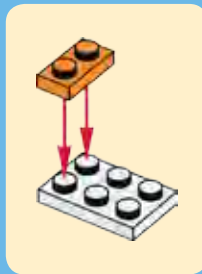
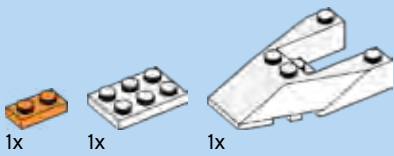
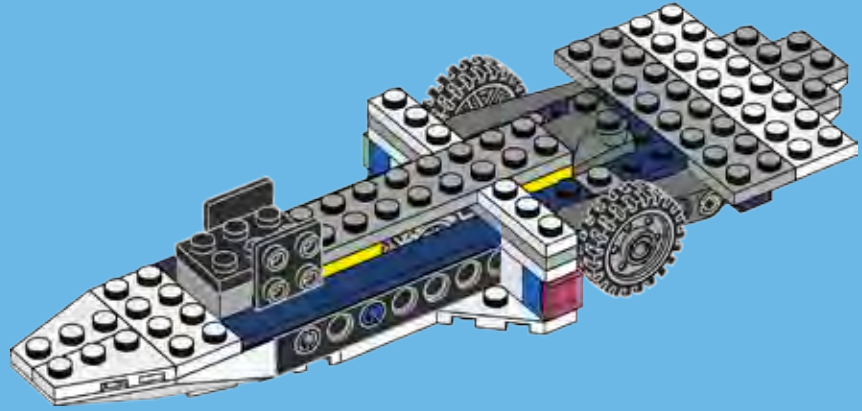

15

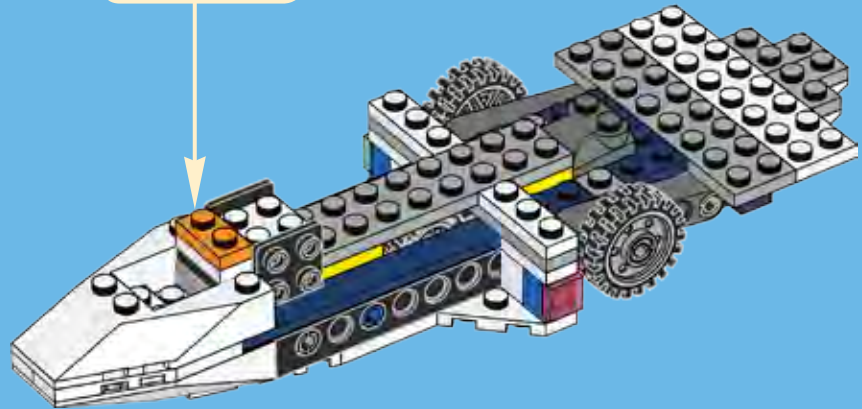



1x



2x

16

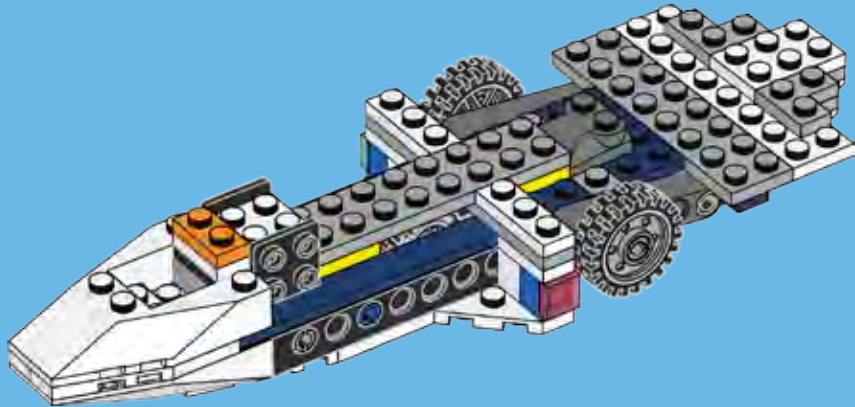



2x



2x

17

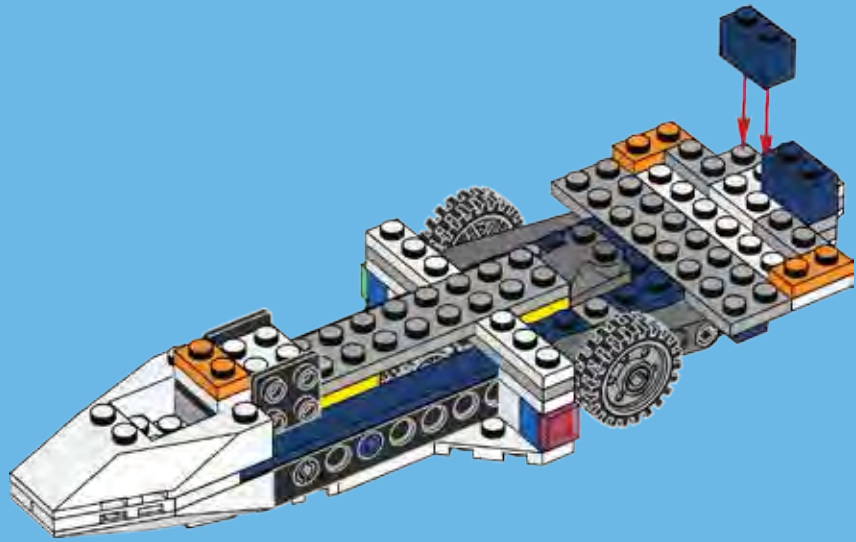

2x



1x



2x

18

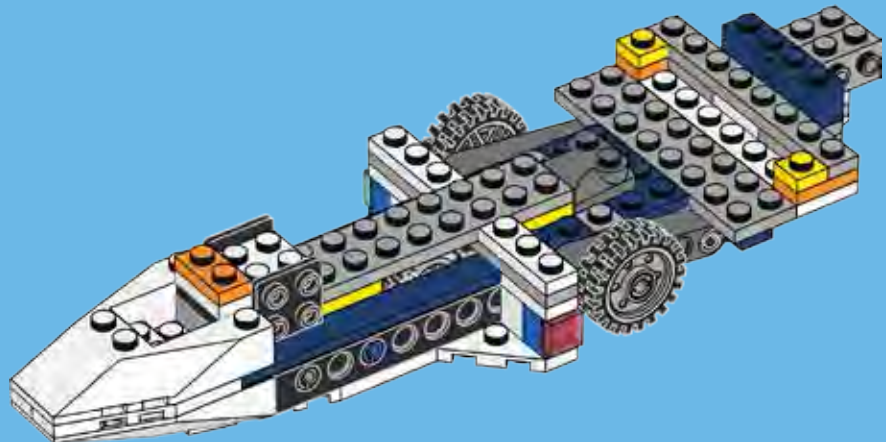



2x



1x

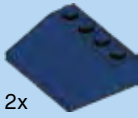

2x

19

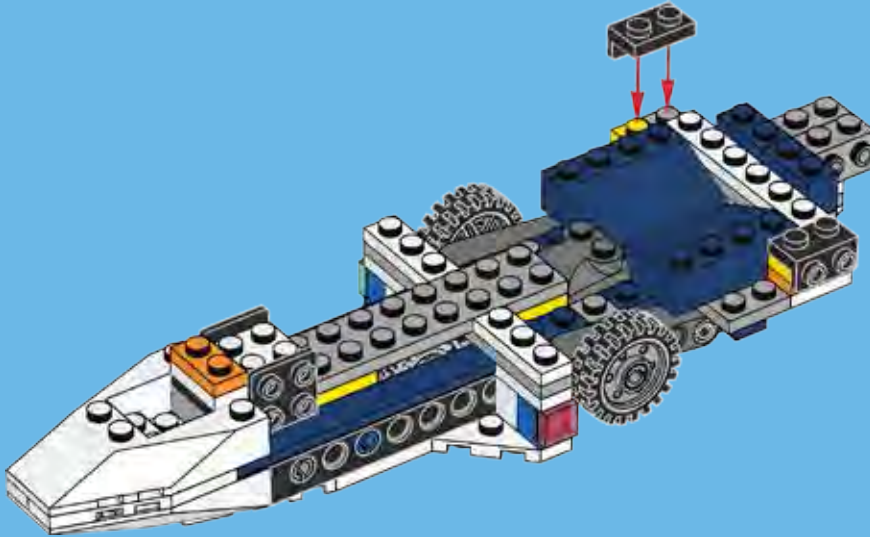



1x



4x



1x



1x

20

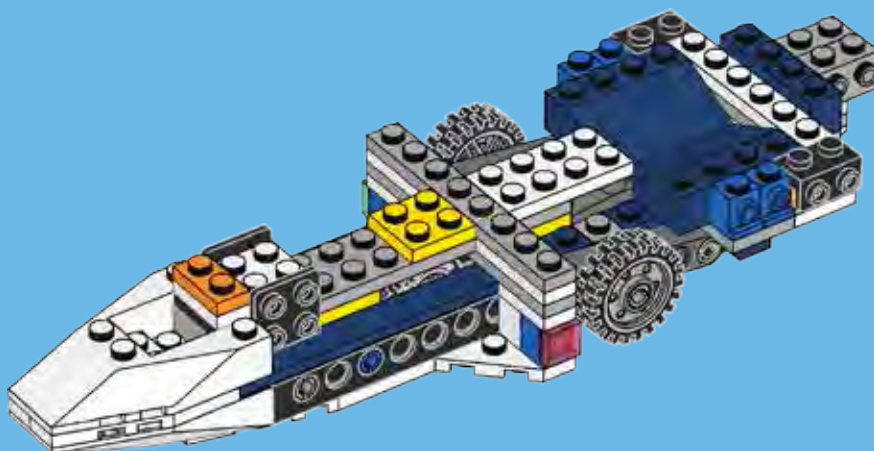

2x



4x

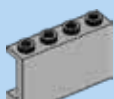

2x

21

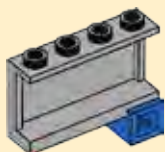

2x

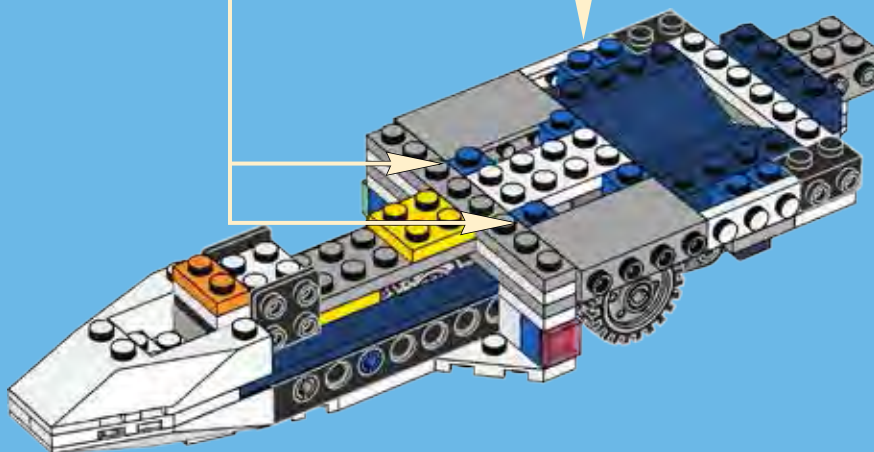

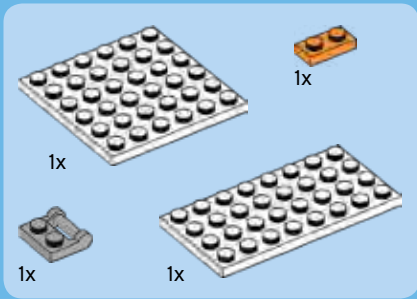

22

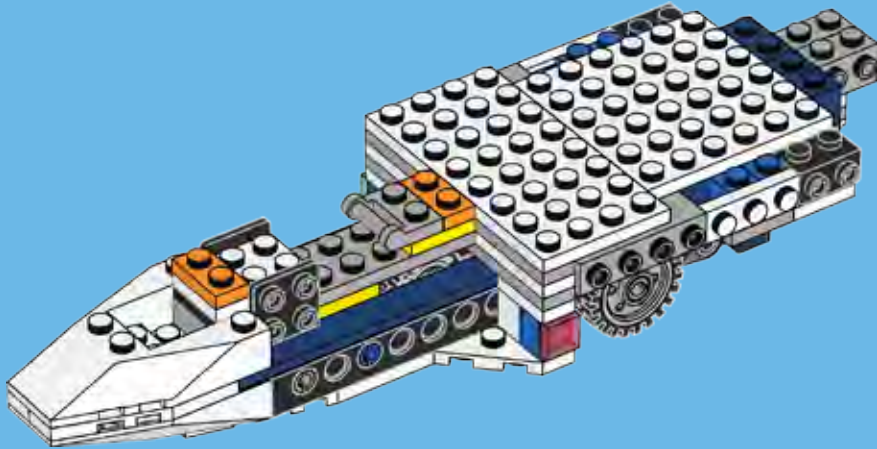



1x



1x



1x



2x



2x



2x



1x

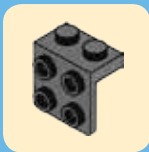

23

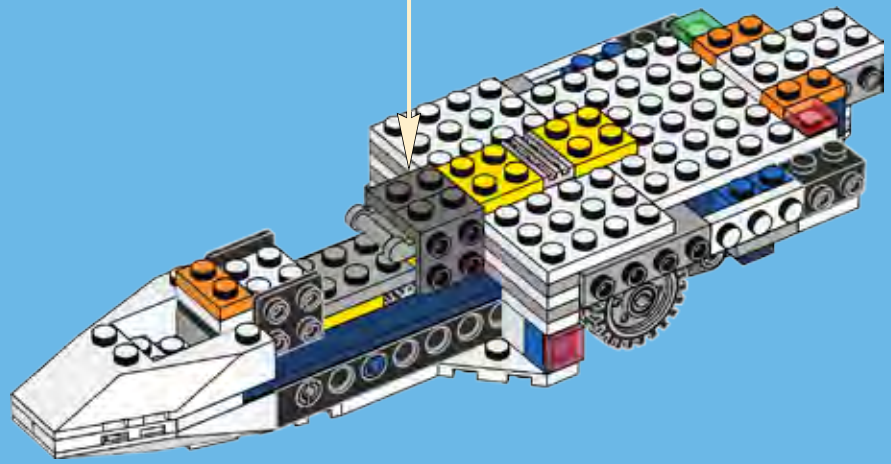

1x



1x



1x

24

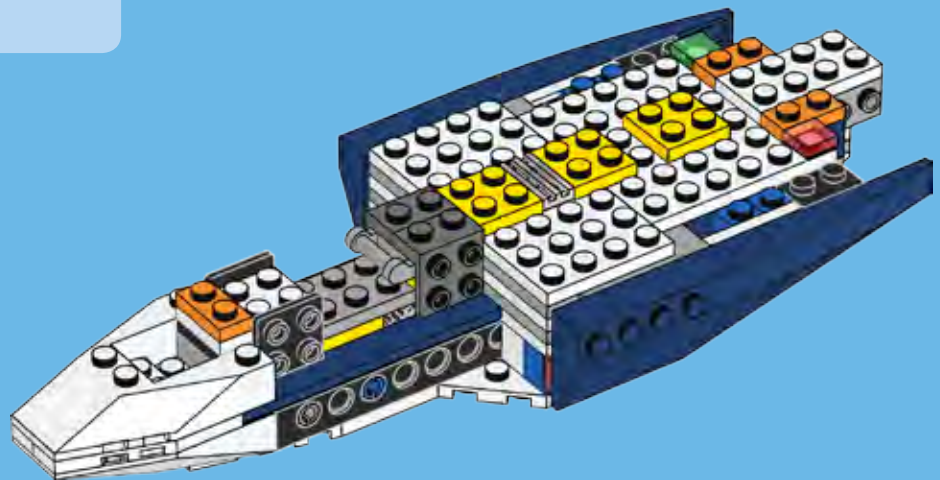



2x

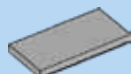

2x



4x

25

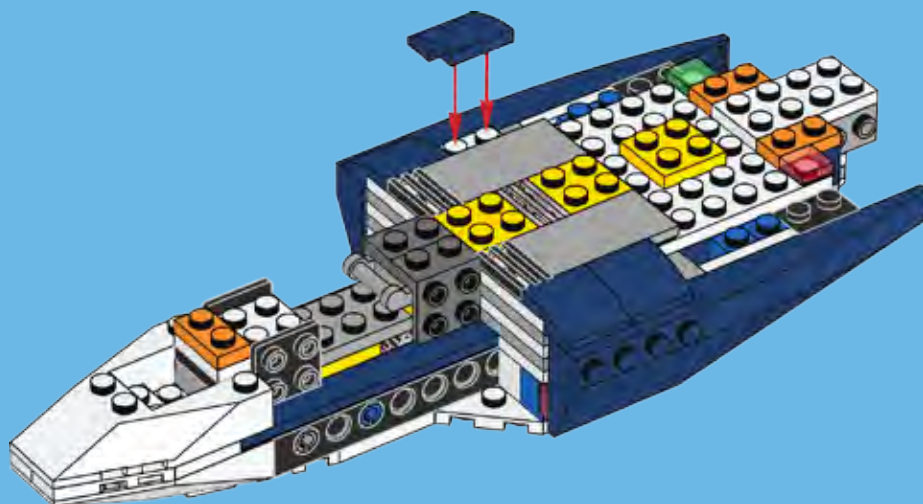

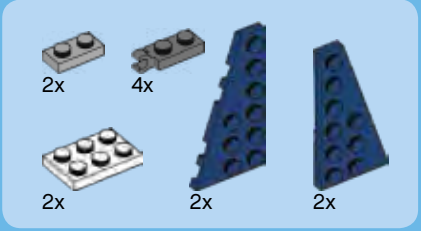
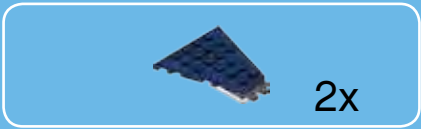

26

1



2

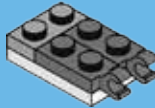

3

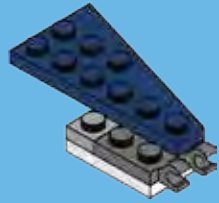

4

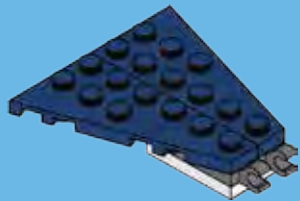

2x

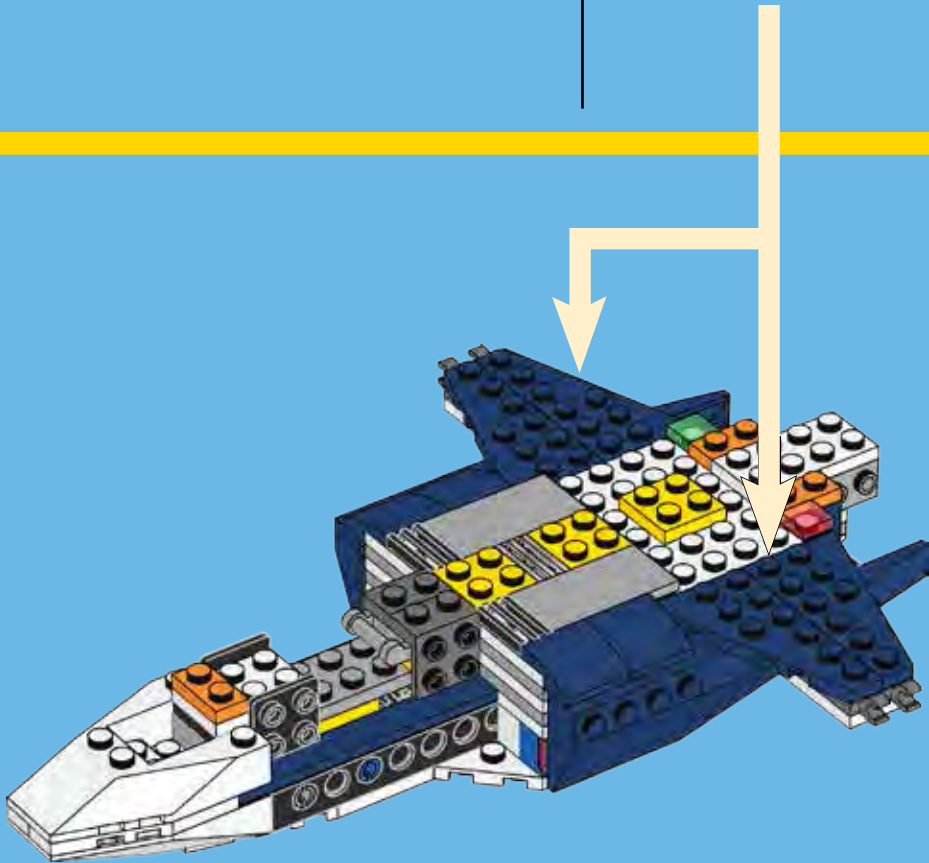

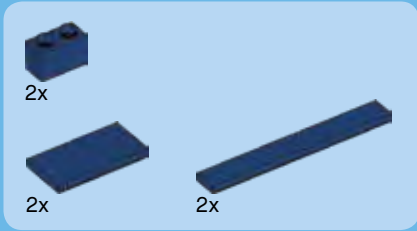

27

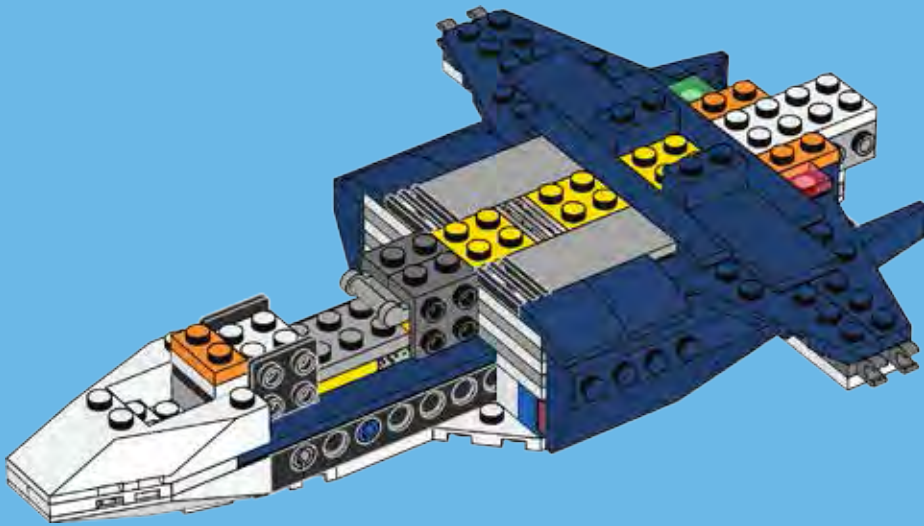



28

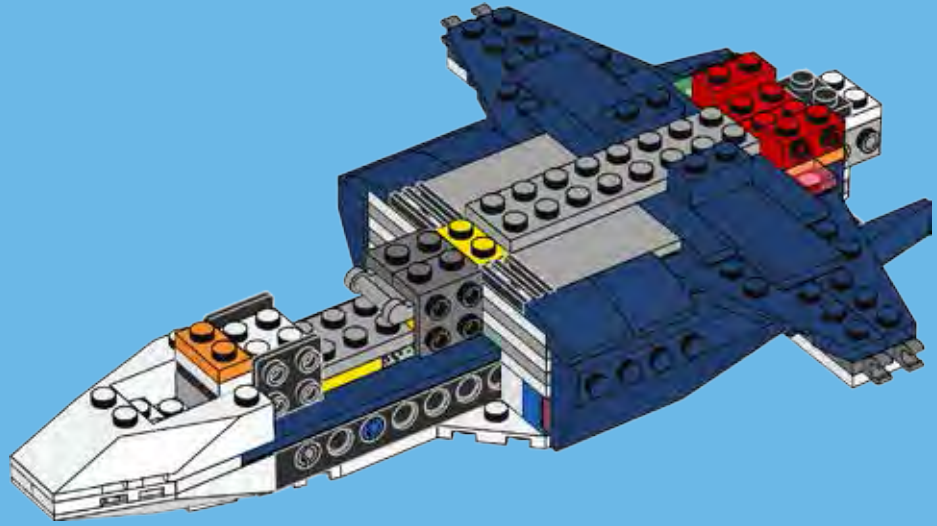

29

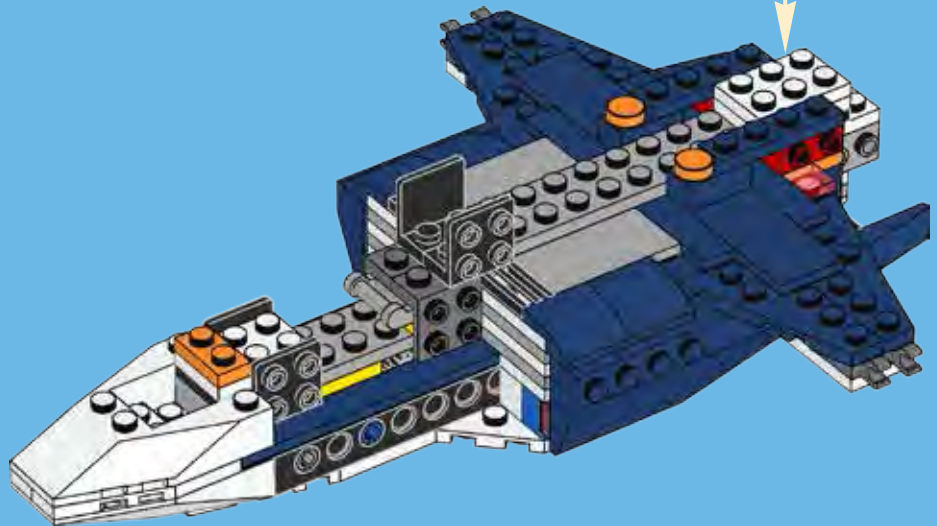
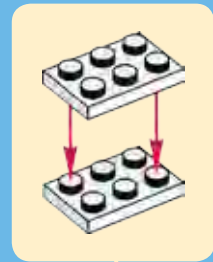



3x



1x

30

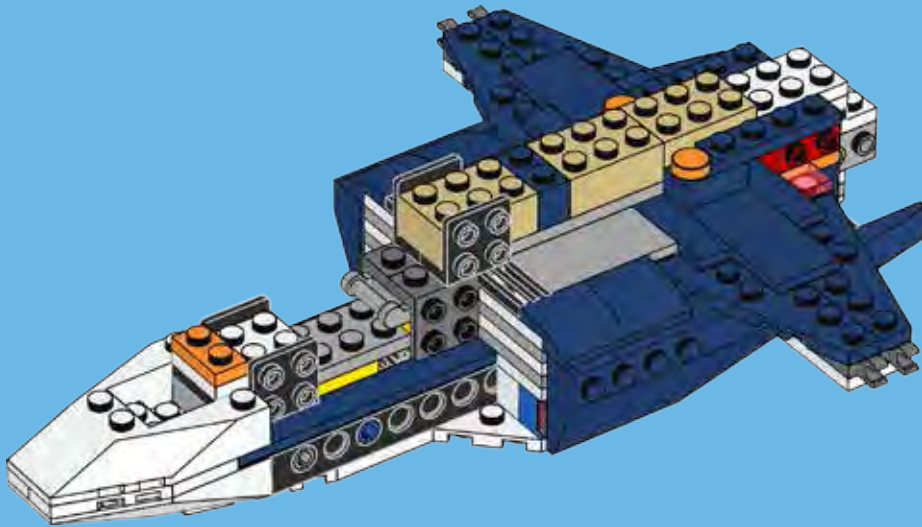



1x



1x



1x



1x

31

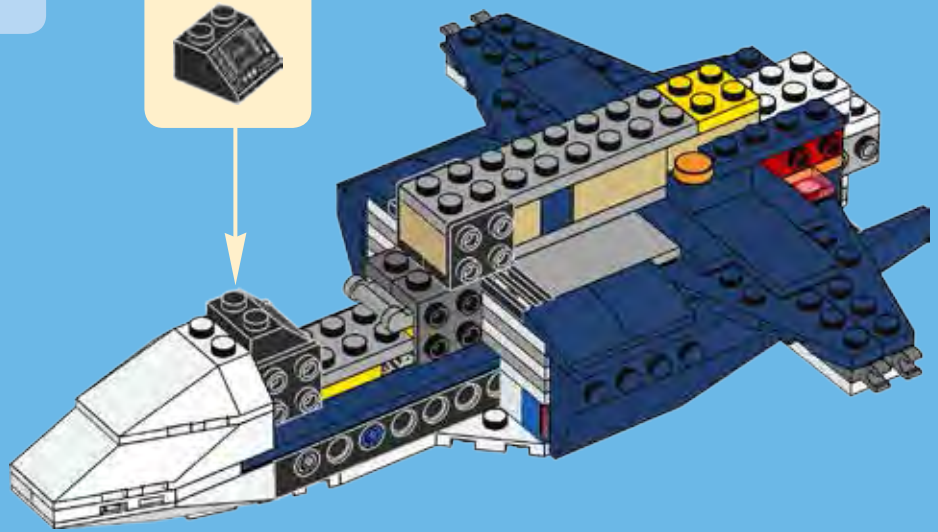

1x



2x



1x



2x



2x

1

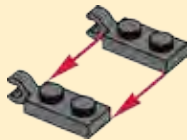

2



32

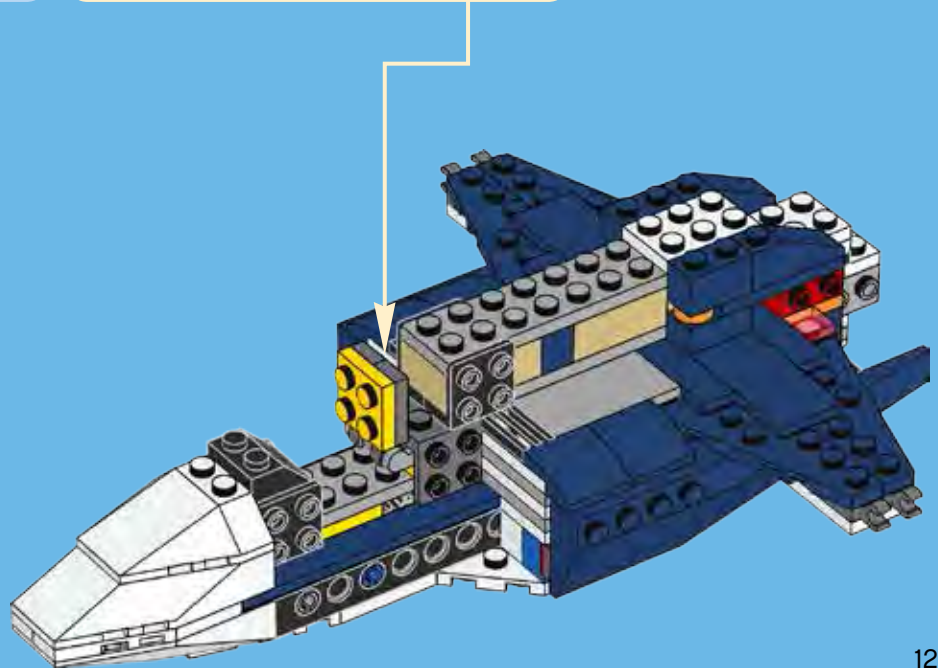



4x



1x



2x

33

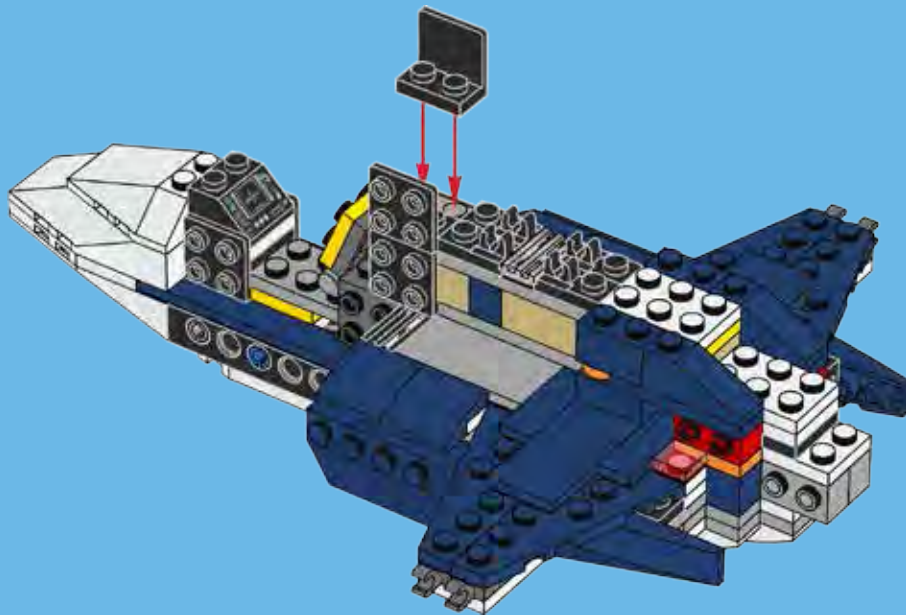

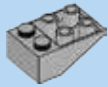

1x



2x

34

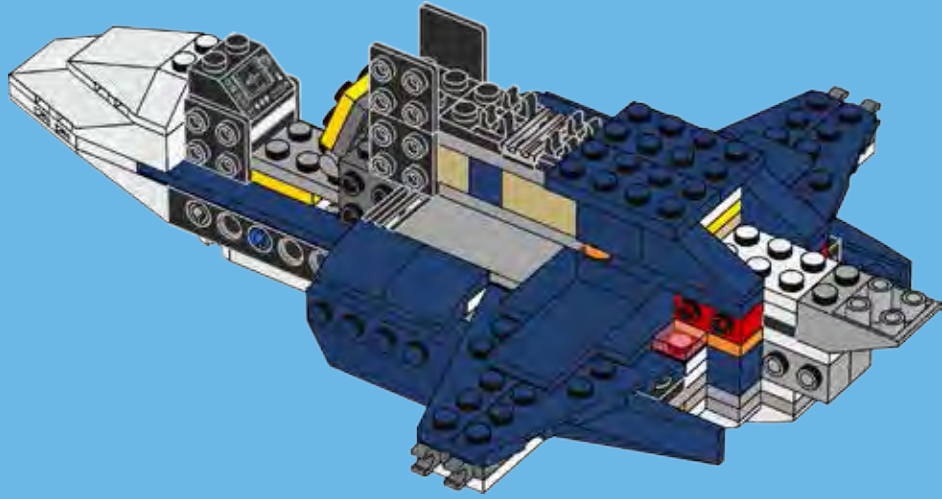

2x



2x



2x

1

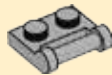

2

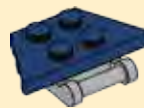

3

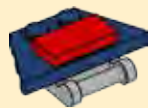

2x

35

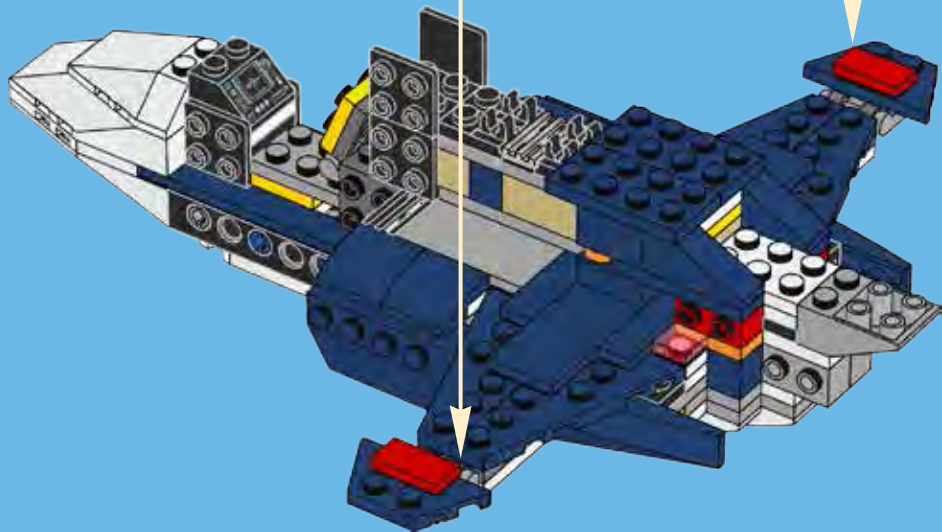

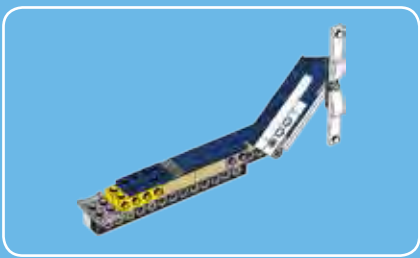

1

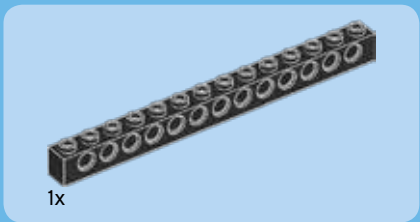

2

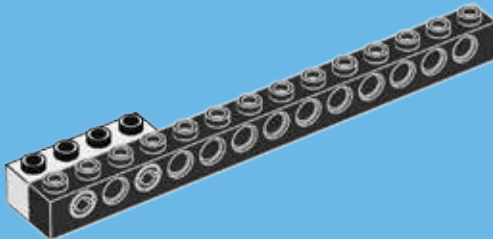

3

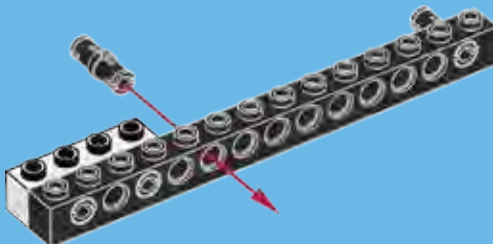

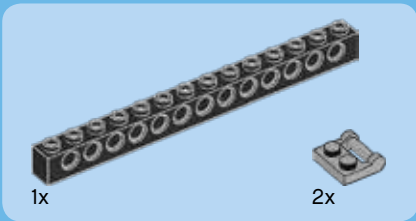

4

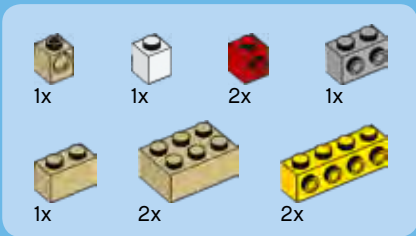
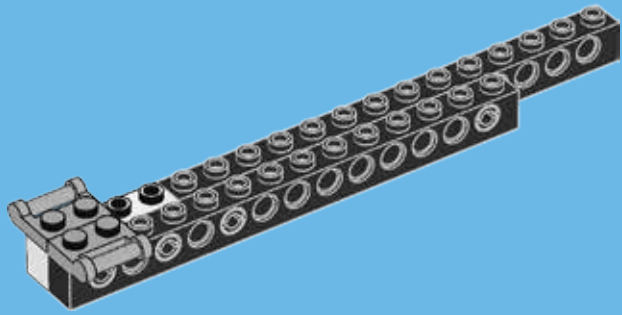

5

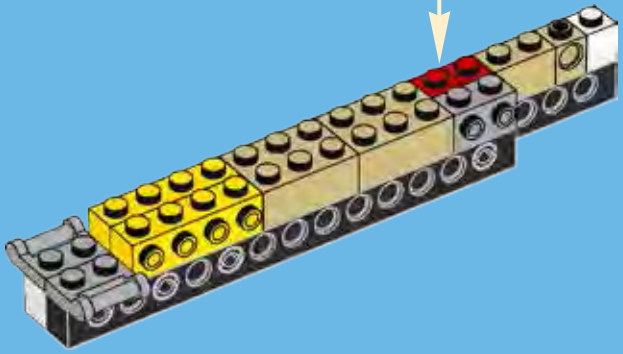
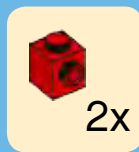



2x

1

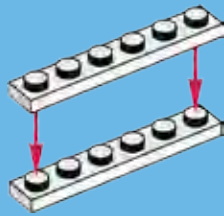

1x



2x

2

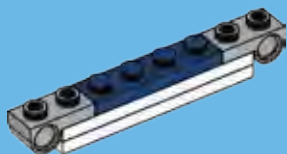

1x



1x



1x

3

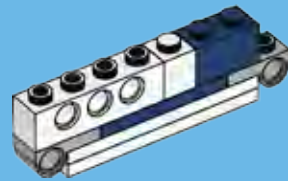

1x



1x



1x

4

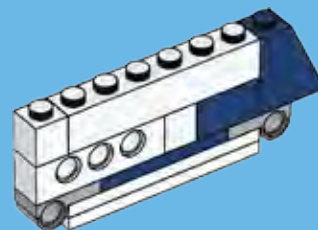



5

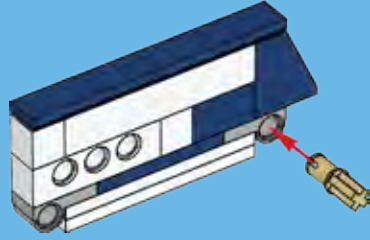

8

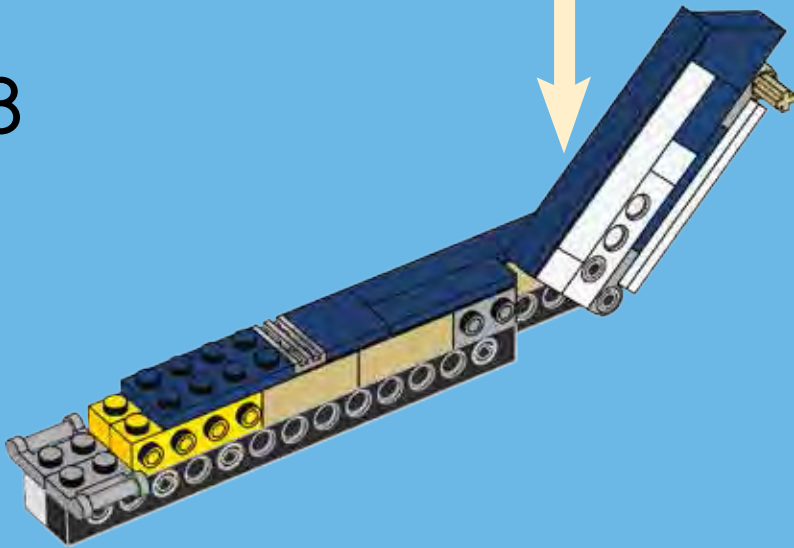



1x



2x



2x

9

1



2



3

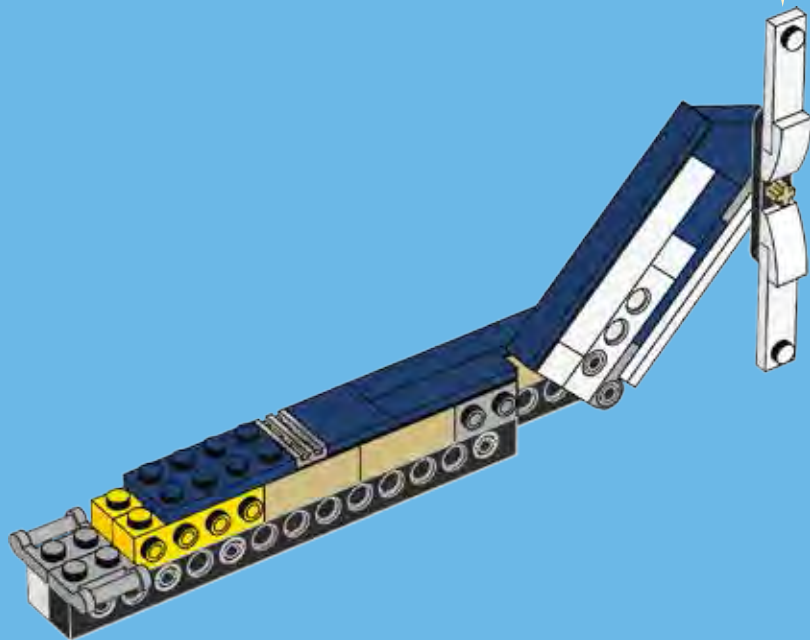
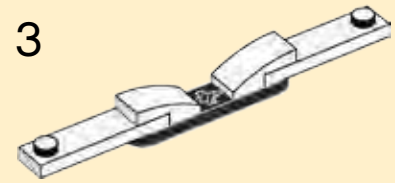

36

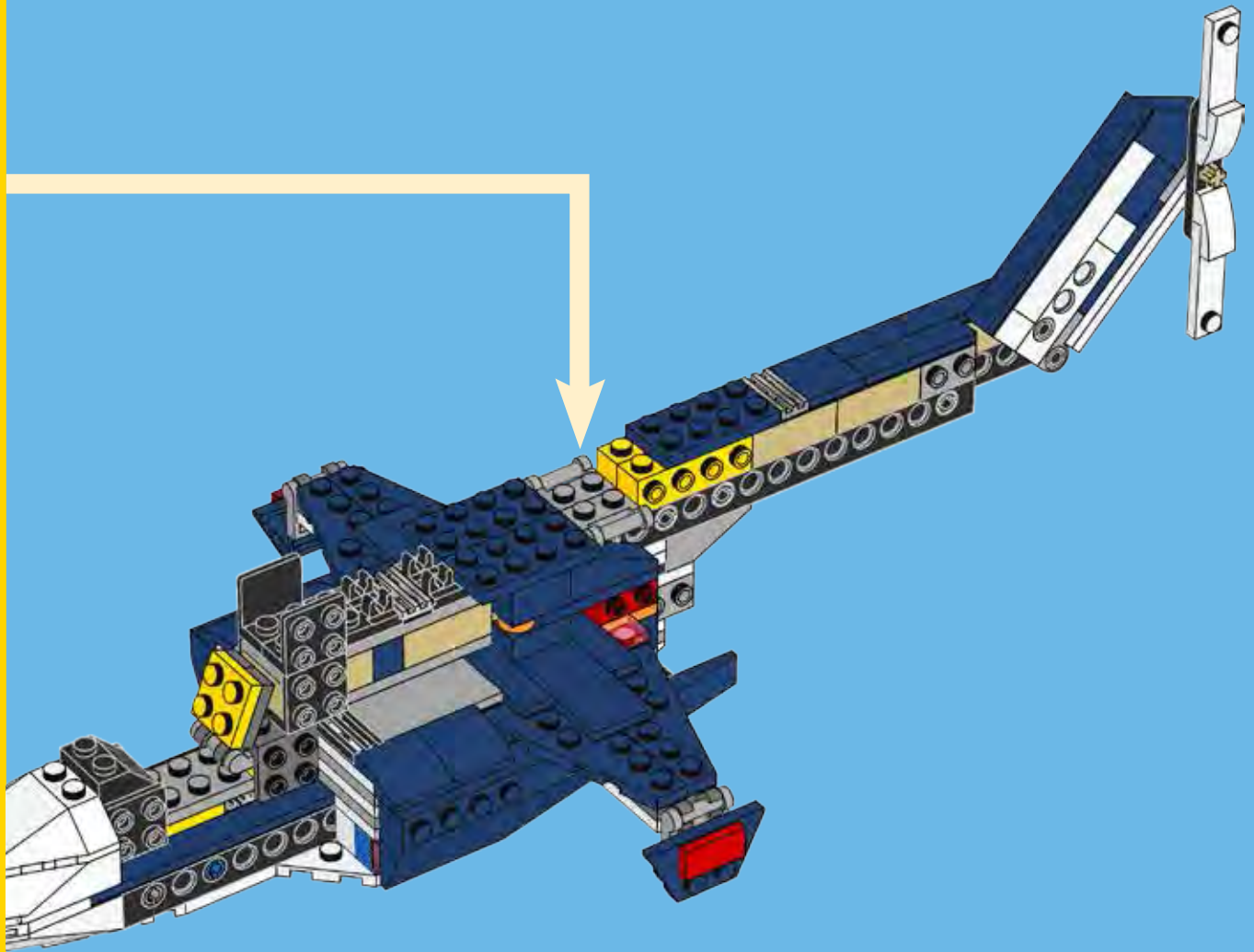



2x



1x



1x

37





1x



2x

38

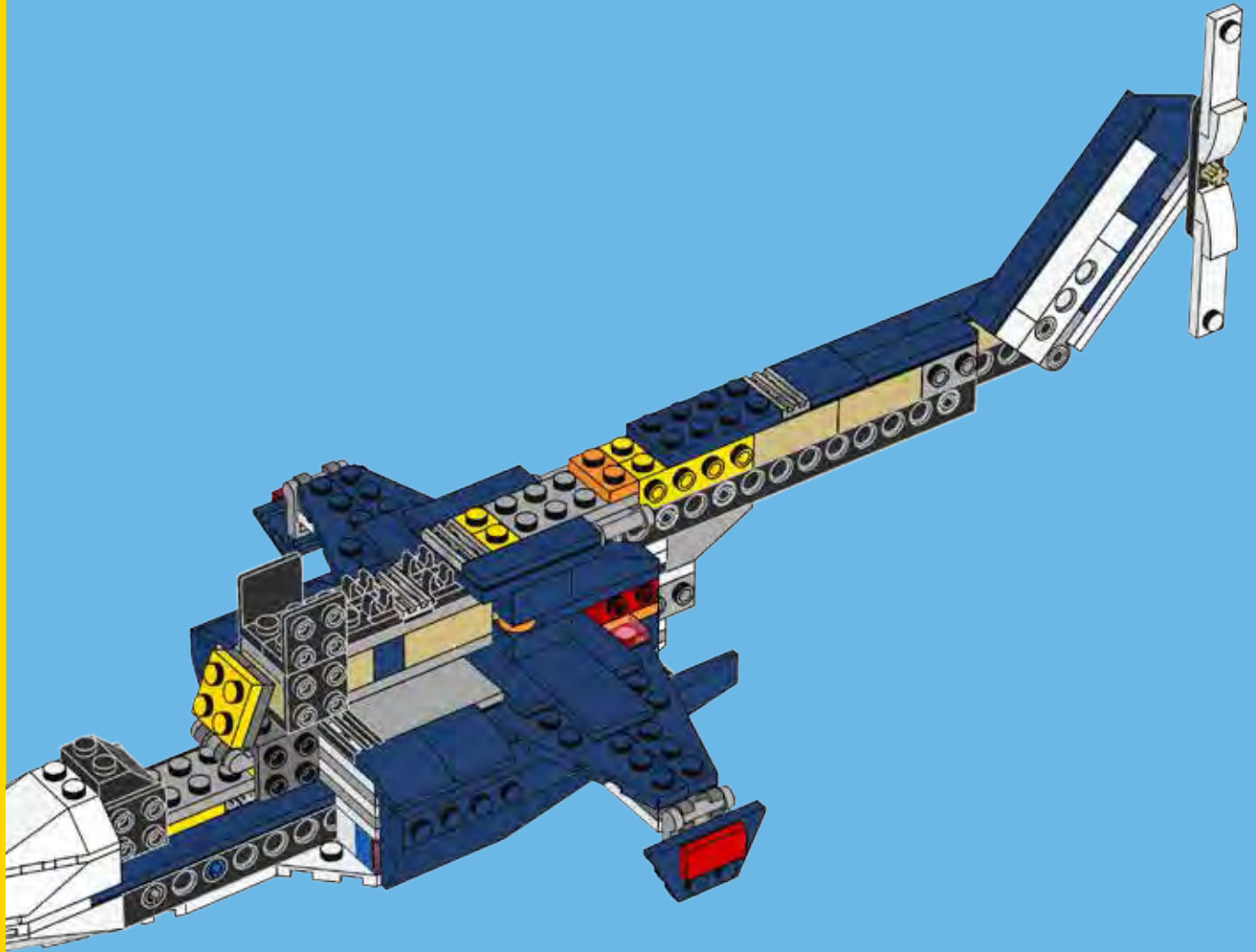



1x



2x



2x

39

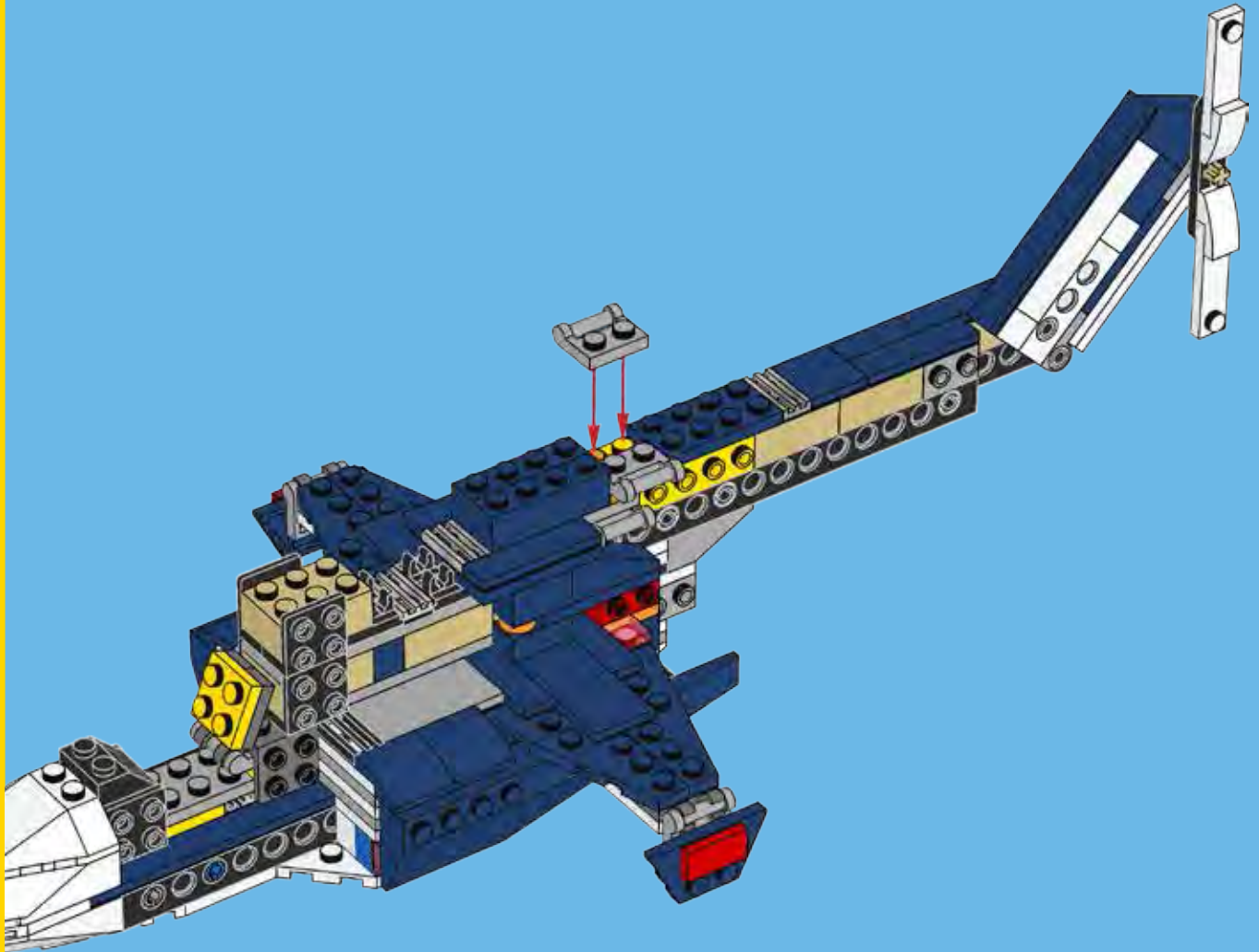



40





1x



1x



2x

41

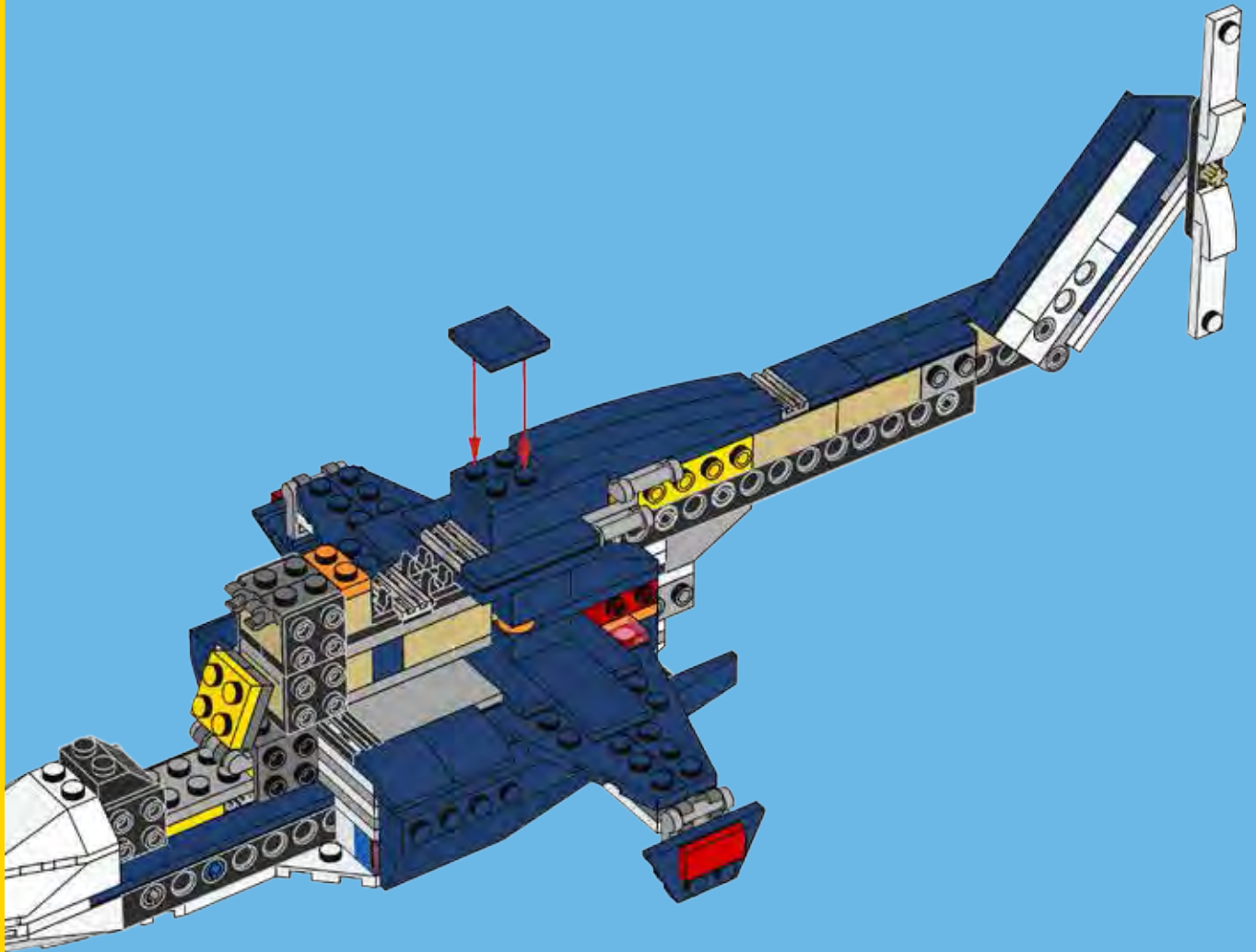

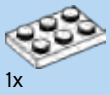

1x



1x

1



1x

2

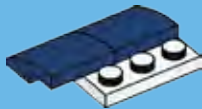

1x

3

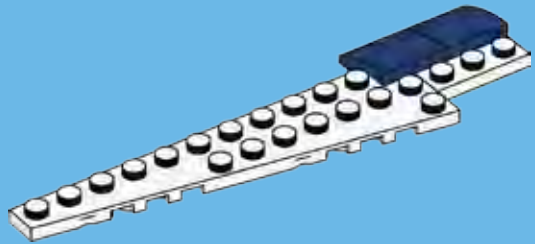

1x



5x

4

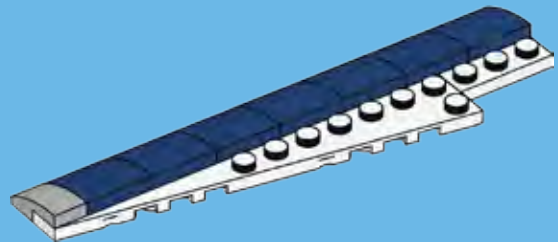



1x

5

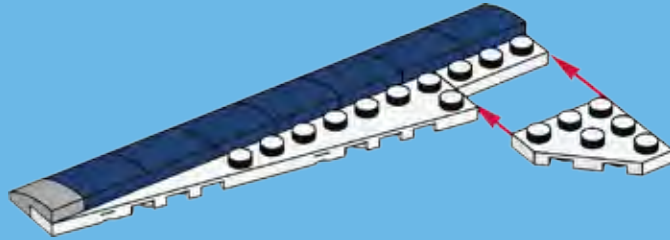

1x

6

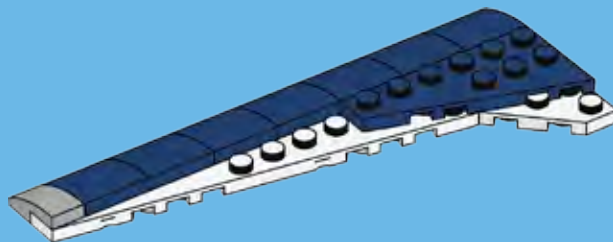

42





1x



1x



2x



1x



1x

43

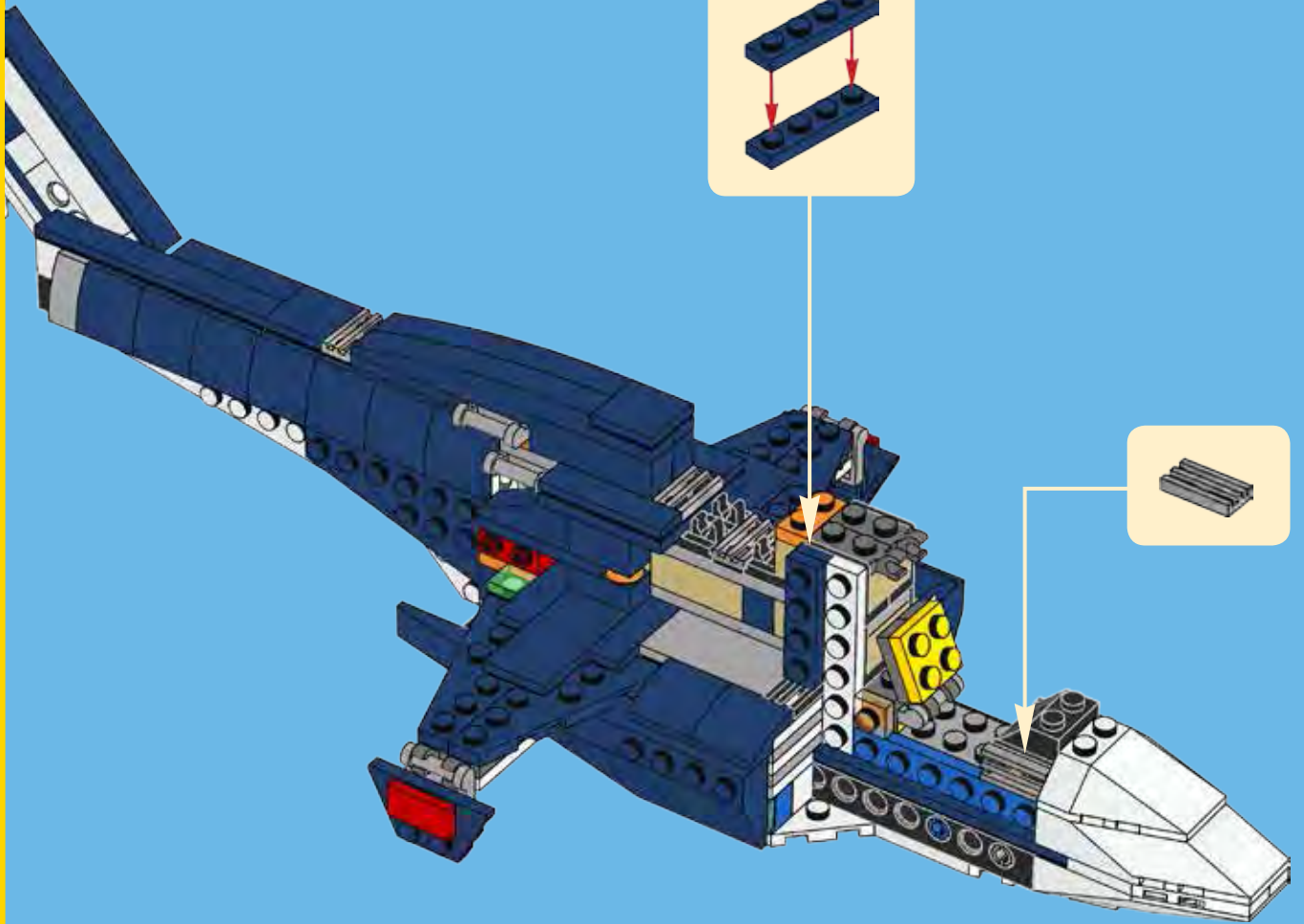
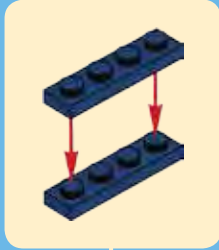



1x



1x



2x

44

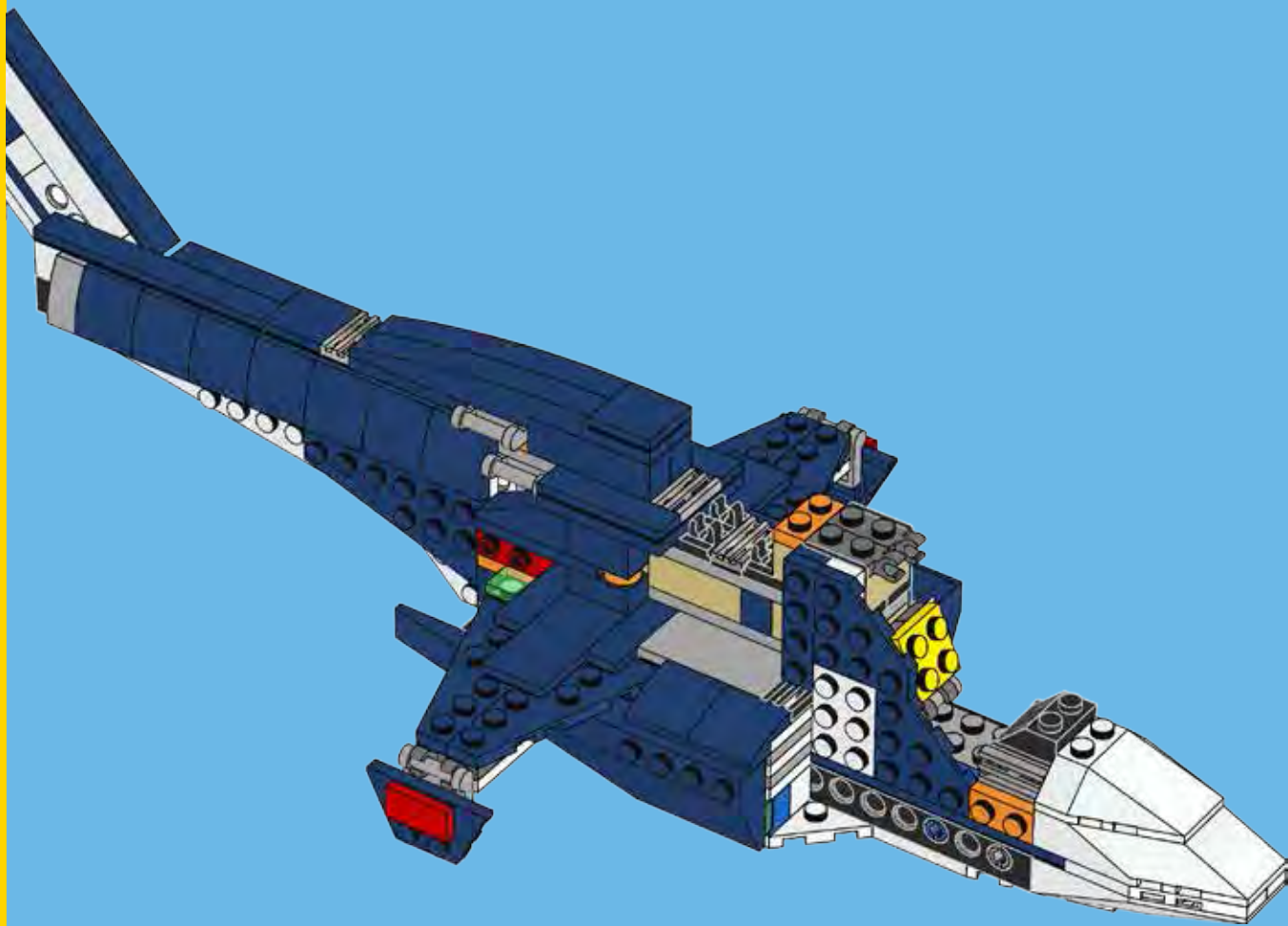

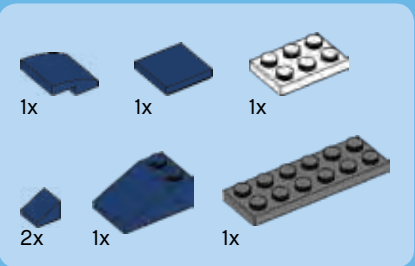

45

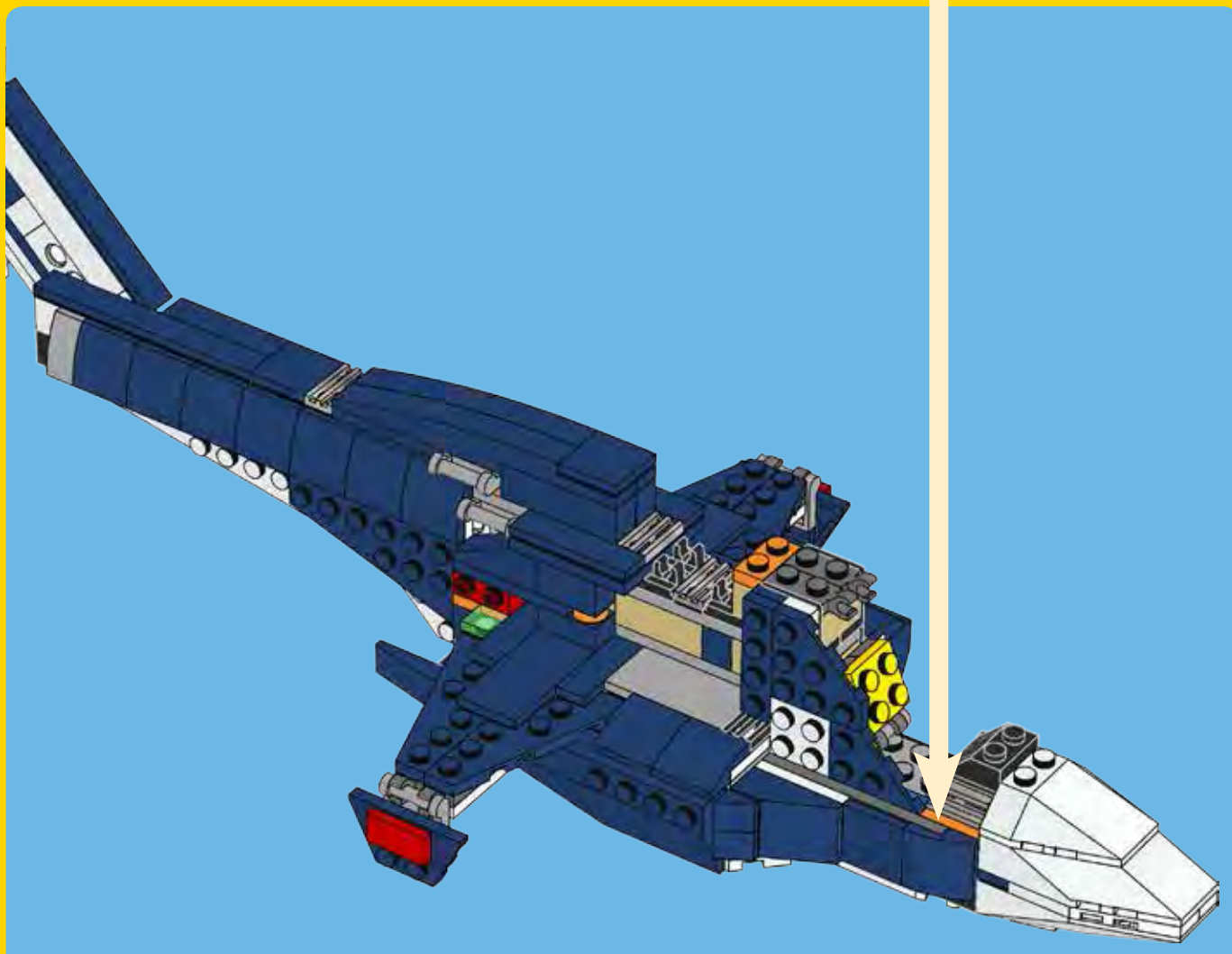
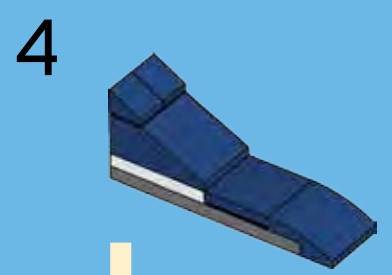
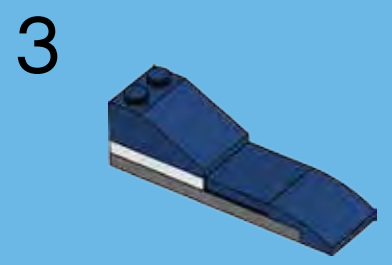
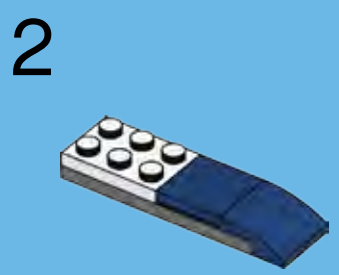
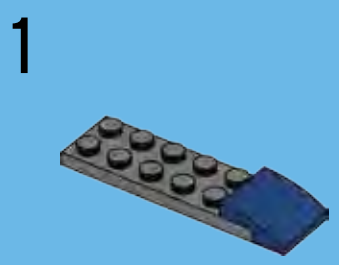



1x



1x

46

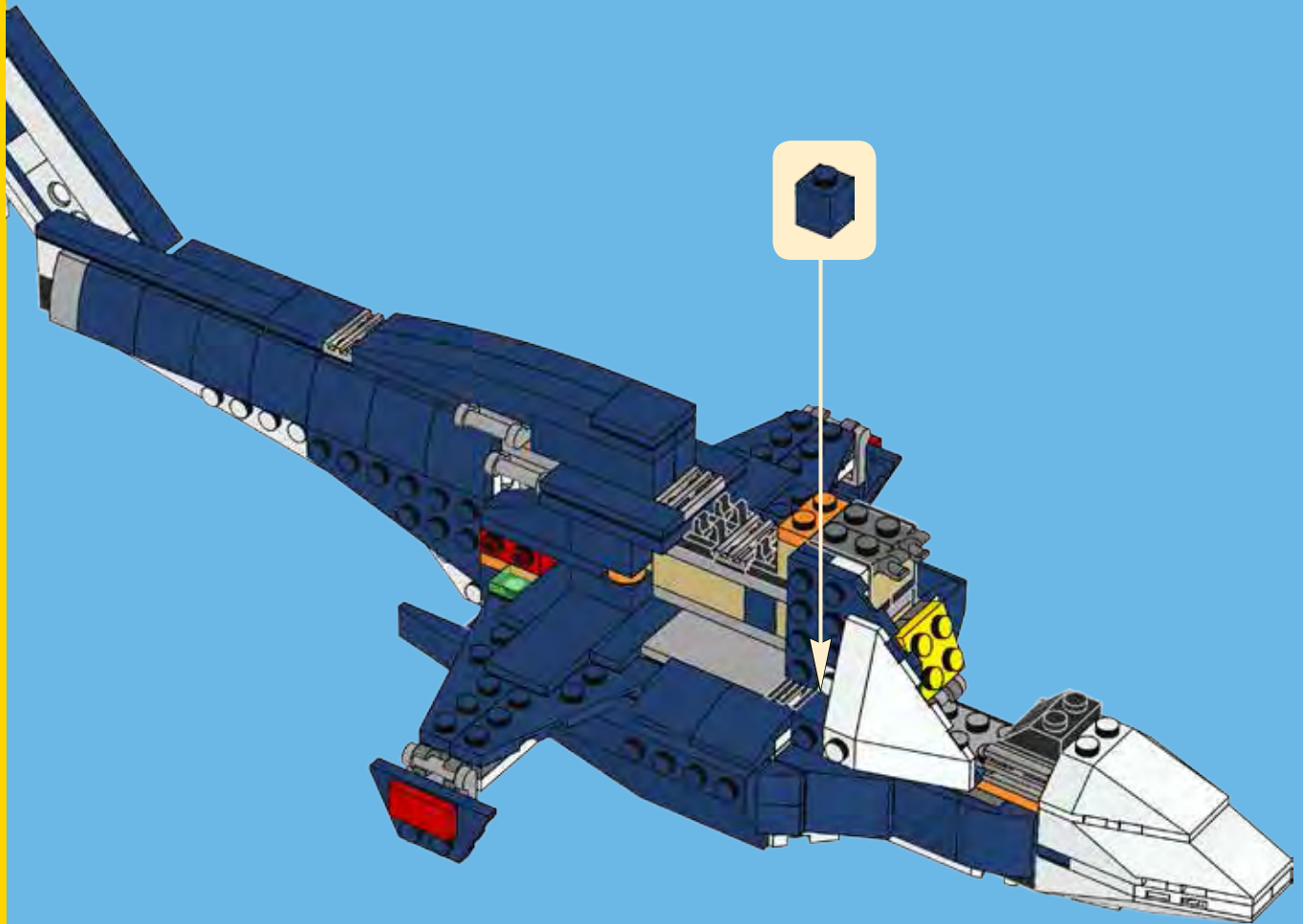

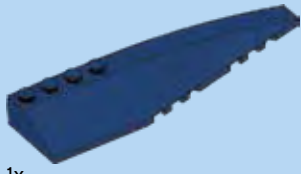

1x

47





1x



1x

1



1x

2



1x

3

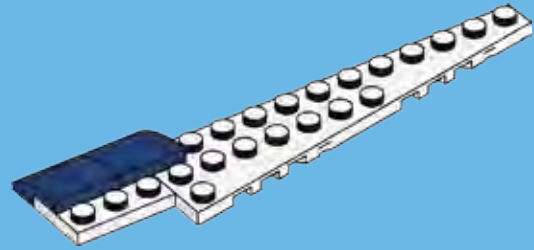

1x



5x

4

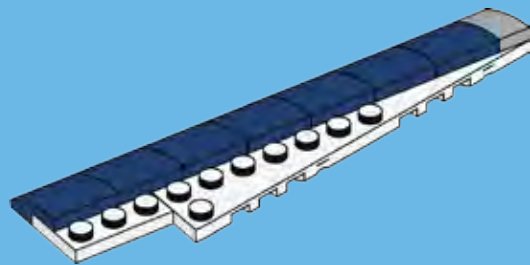



1x

5

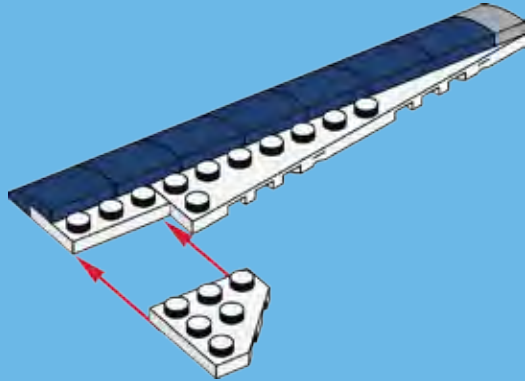

1x

6

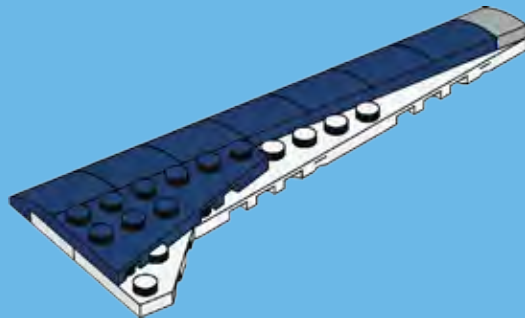

48



1x

1x

2x

1x

1x

49

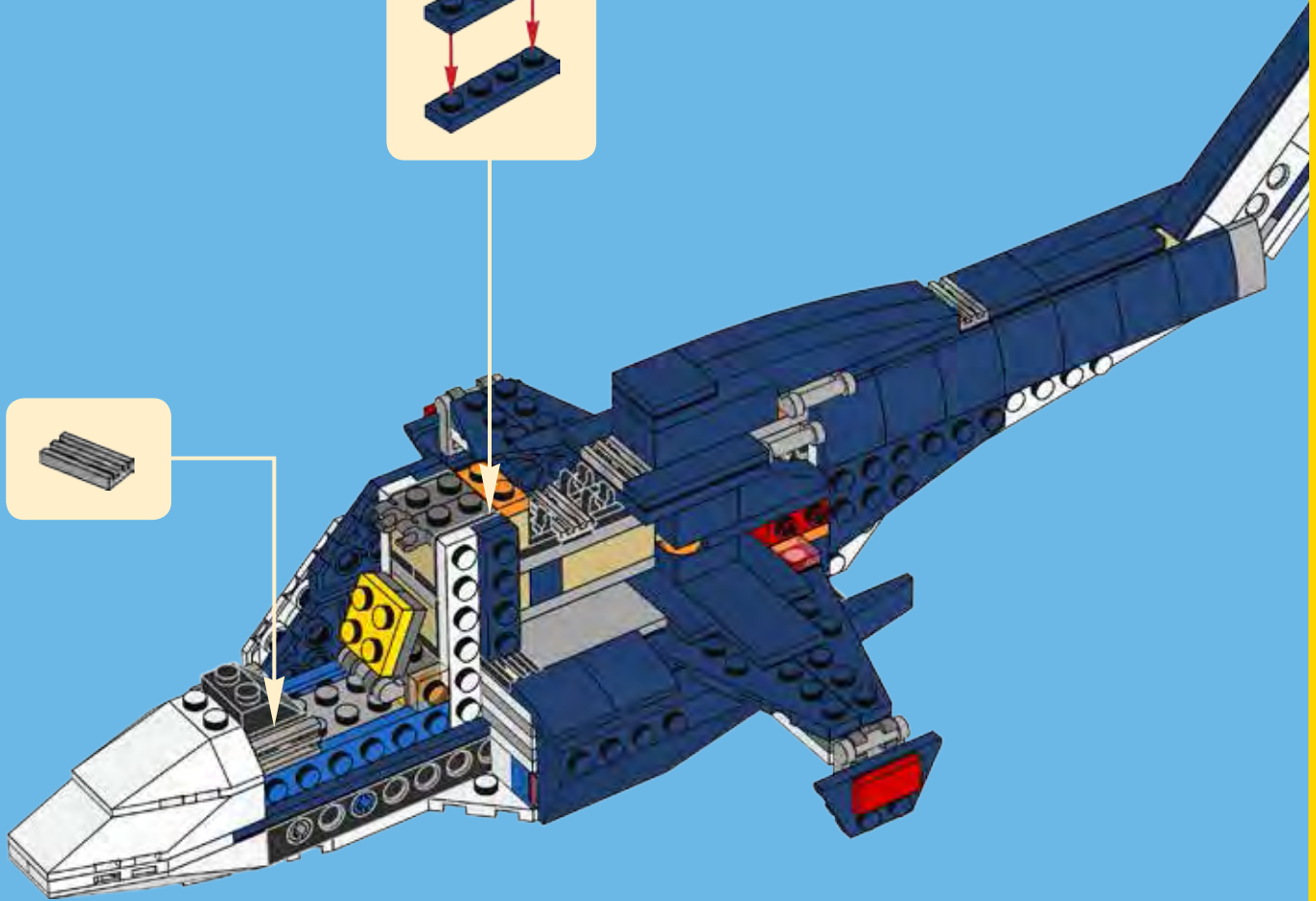
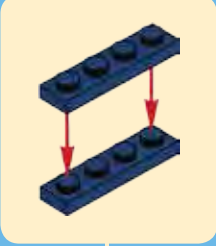



1x



1x



2x

50

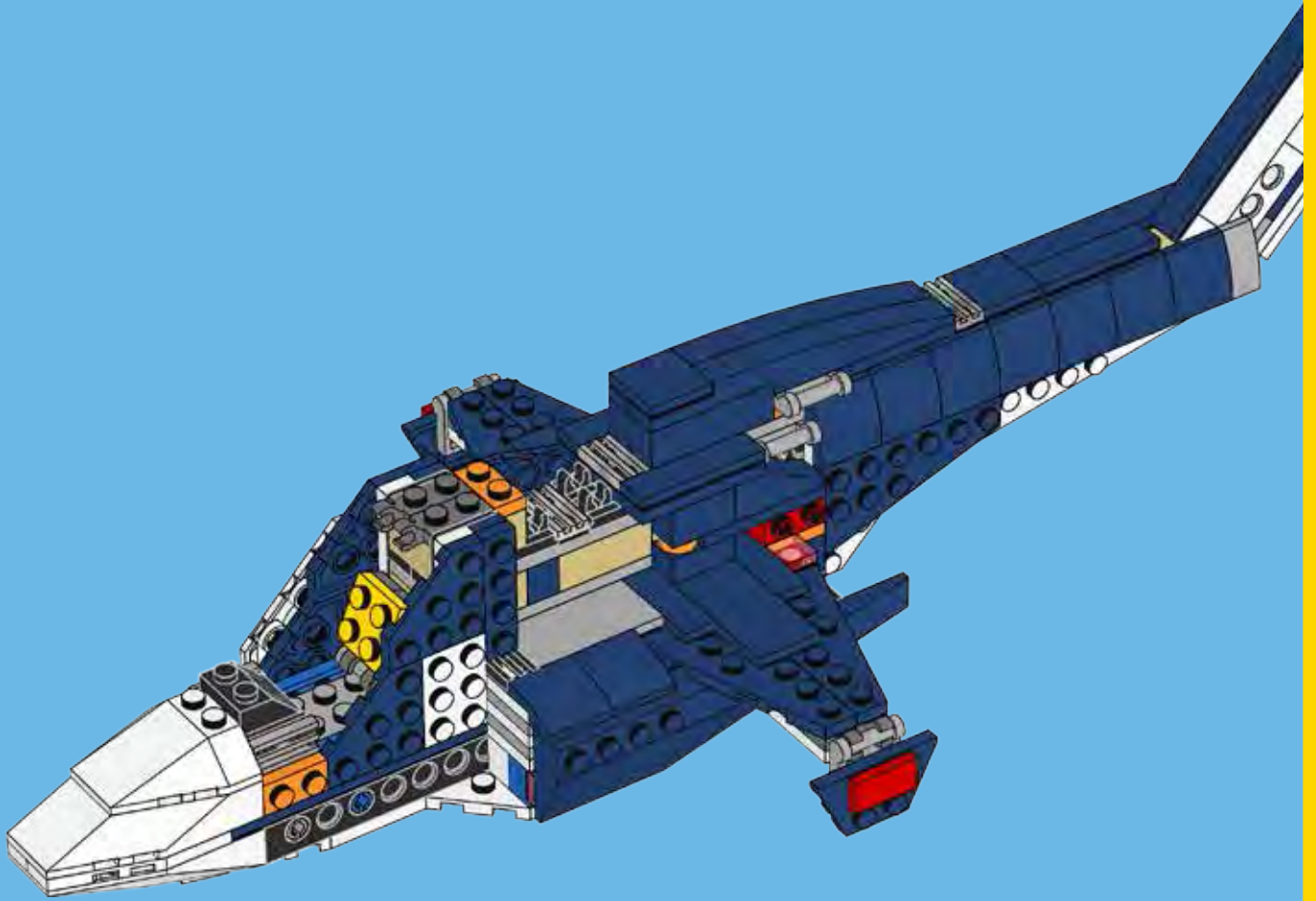

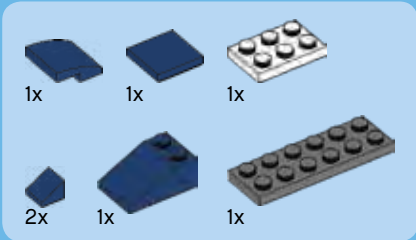

51

1

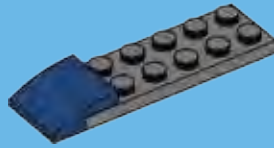

2

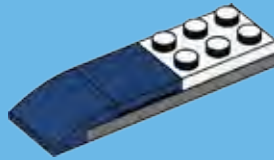

3

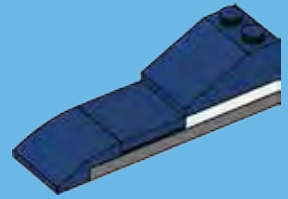

4

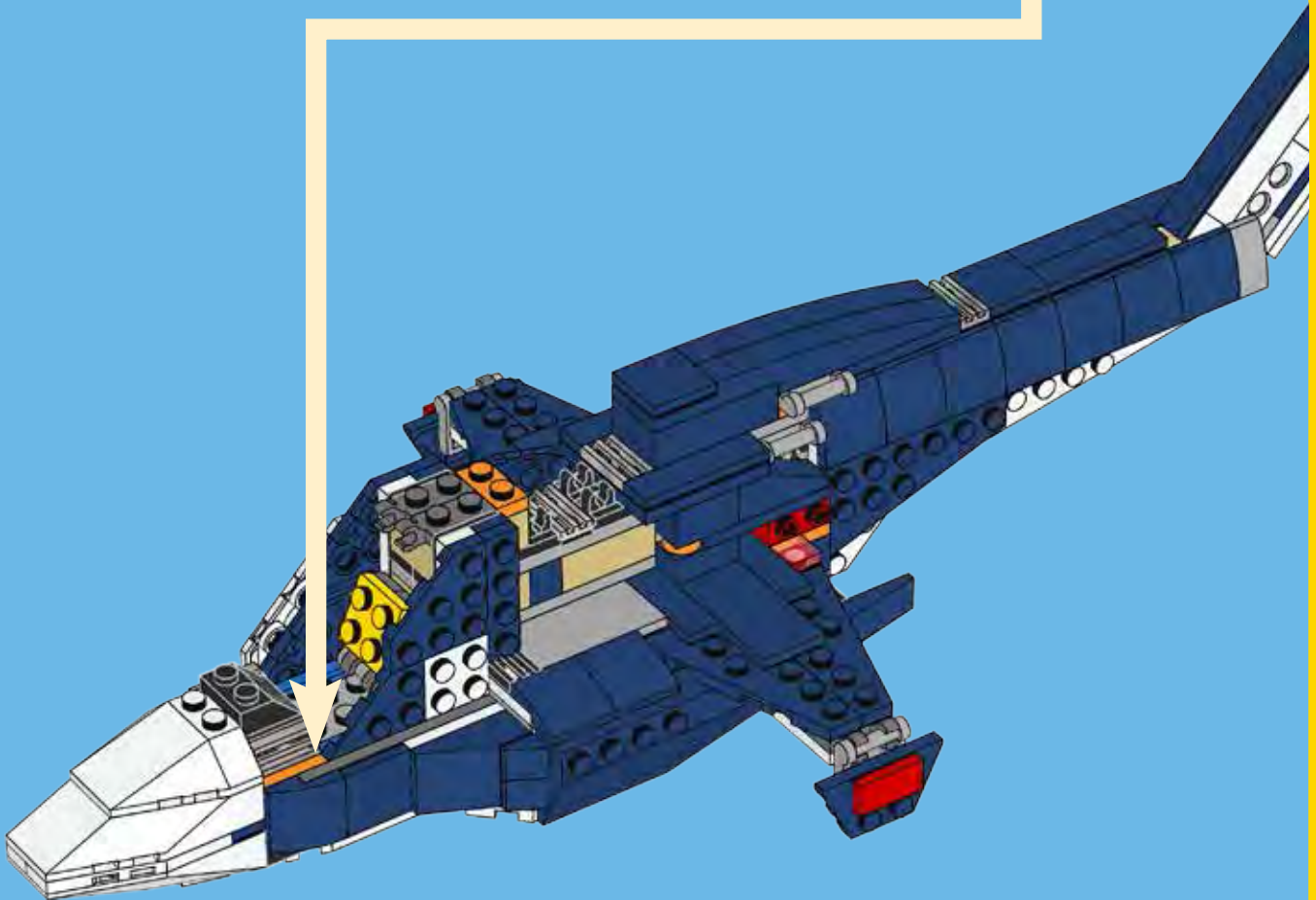
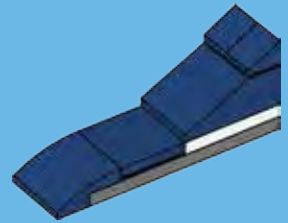



1x



1x

52

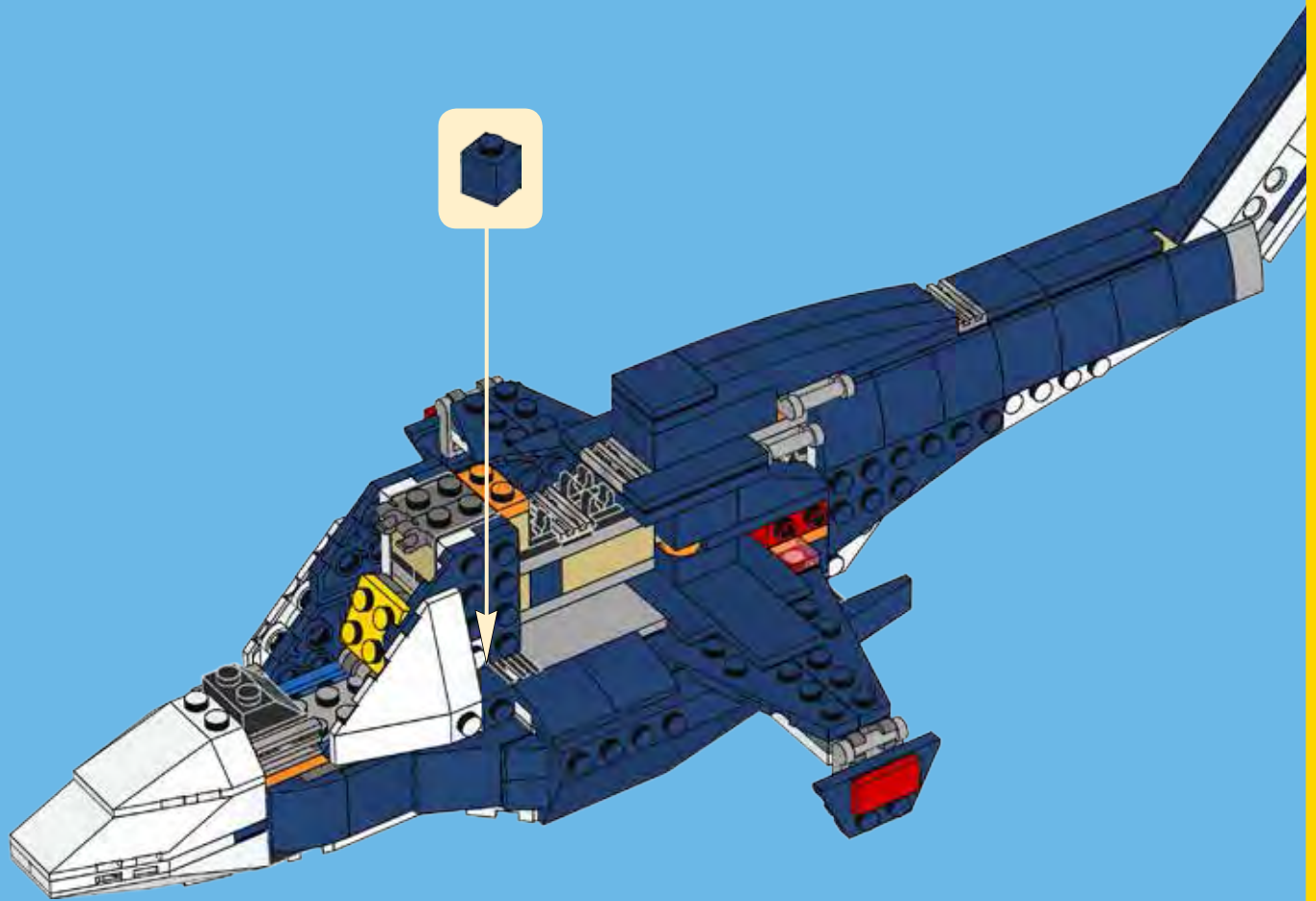

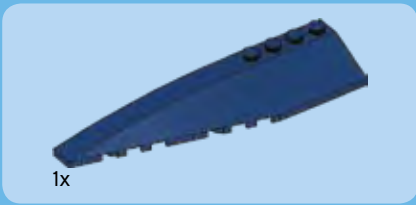

53





1



2

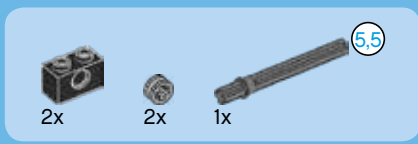

3

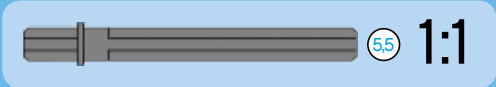
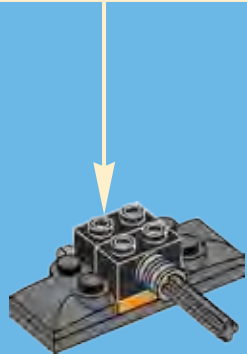
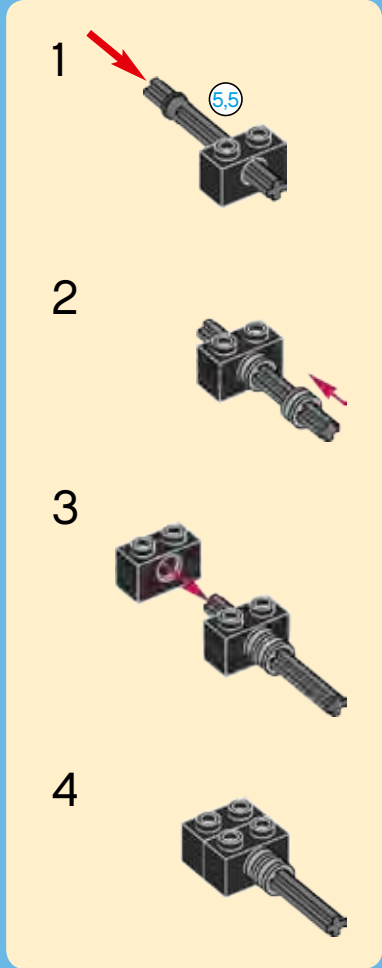



4

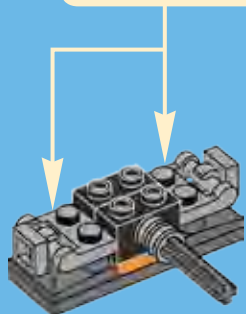
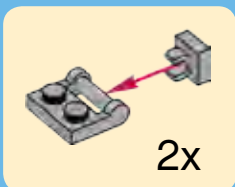

5

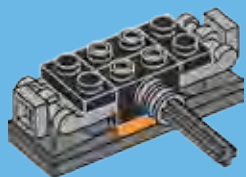

6

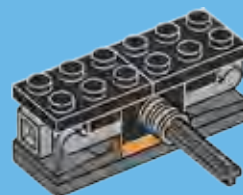

7

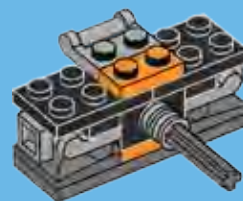



2x



2x

8

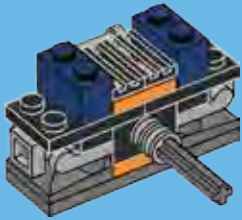

2x



2x

9

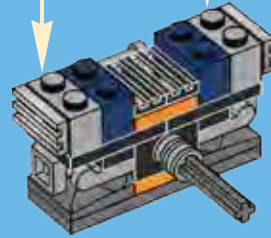
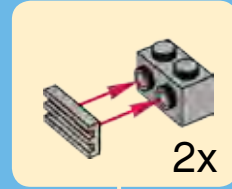

2x

10

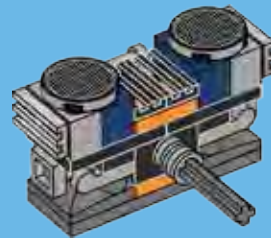



1x



1x

11

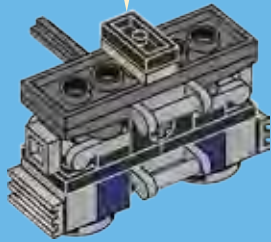
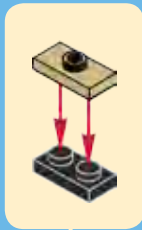

2x

12

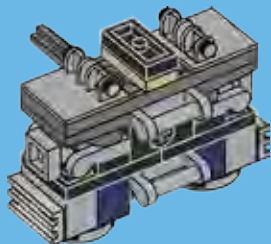

2x



2x



2x

13

1

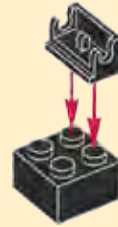

2

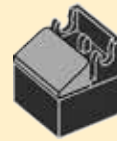

2x

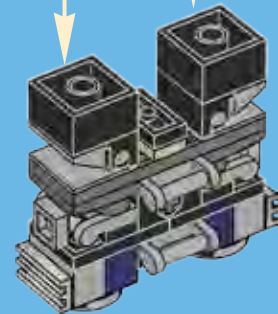

14

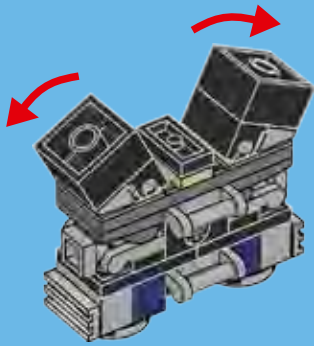

15

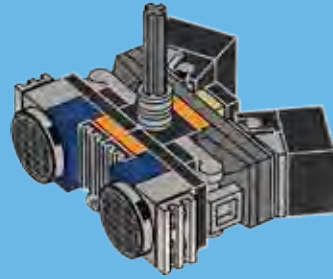

54

CLIC

CLICK

咔嗒

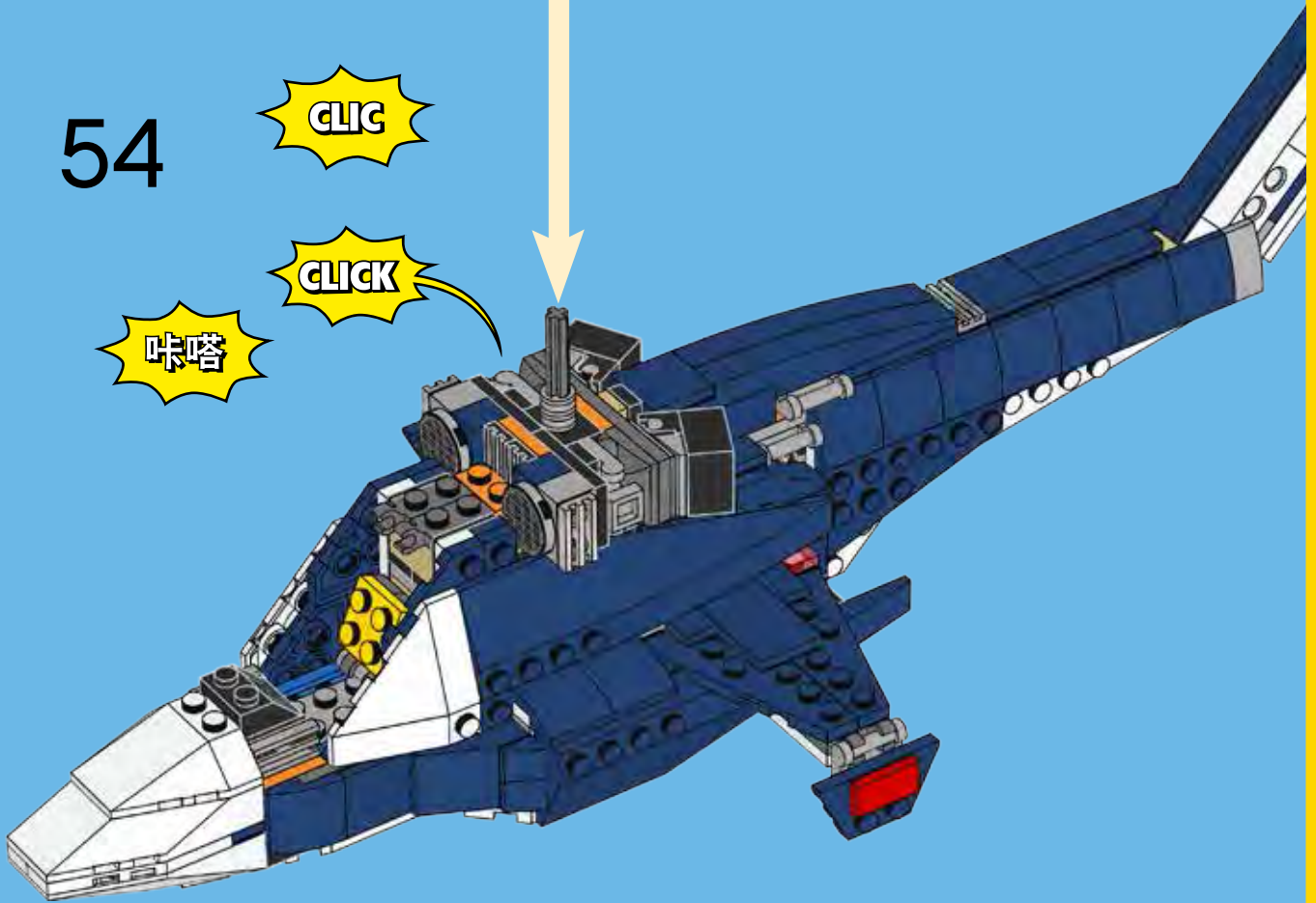



1x



1x

55





1x



2x

56

1



2

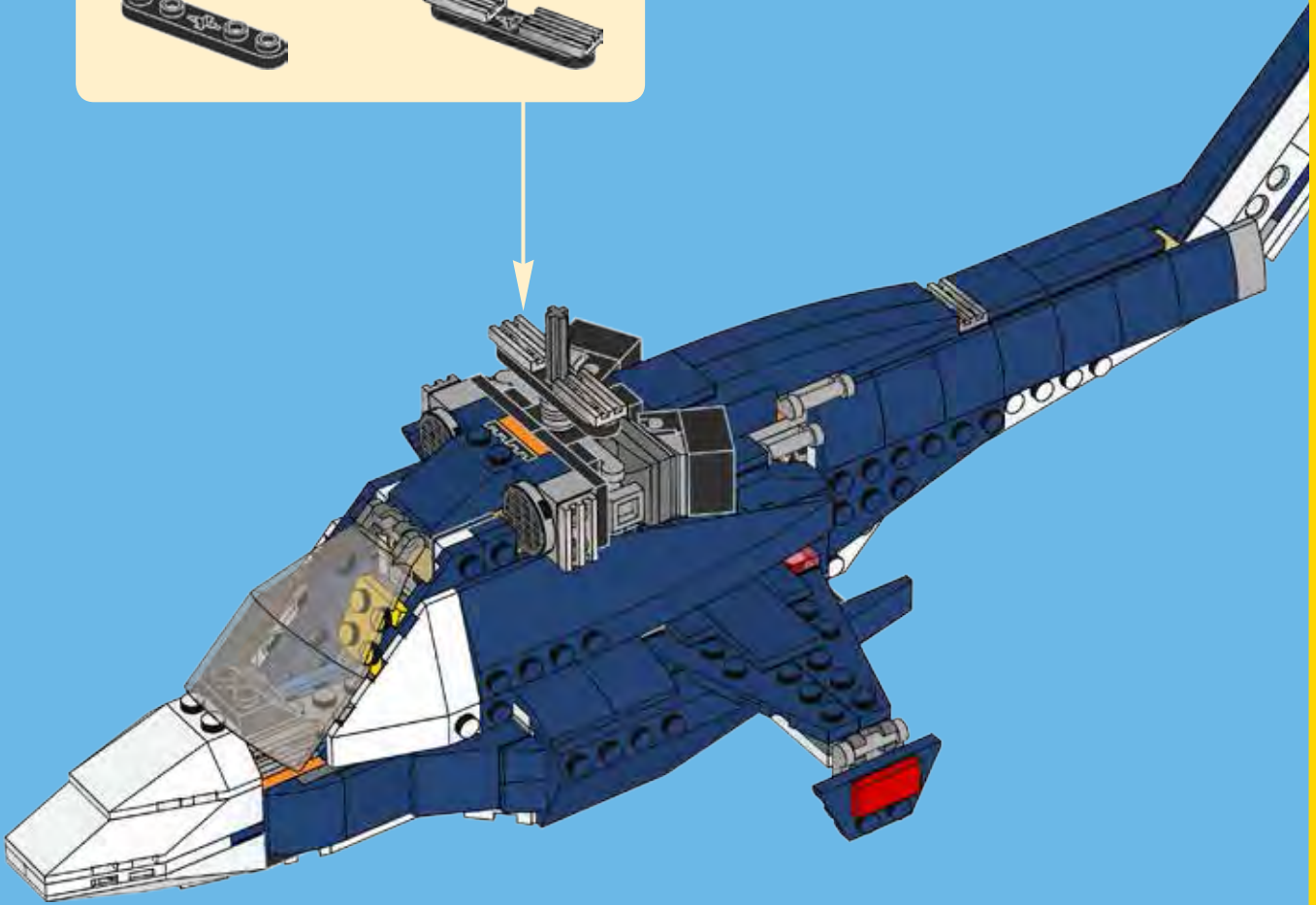
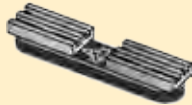

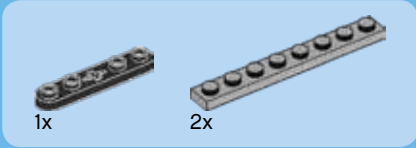
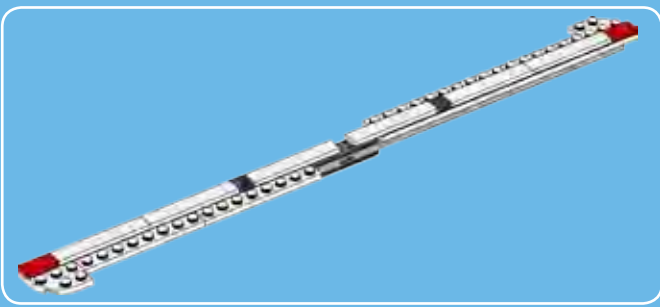

1

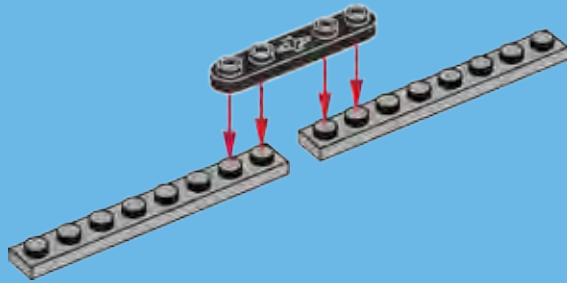

2

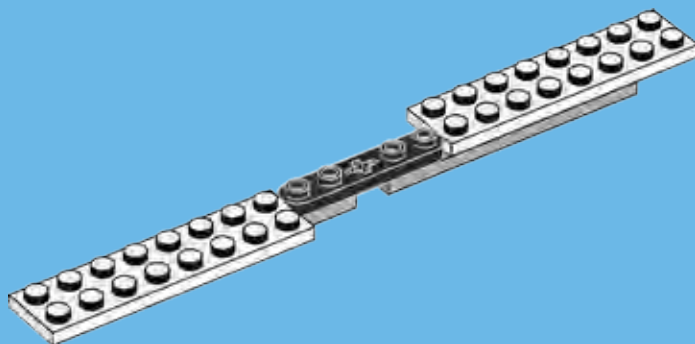



2x

3

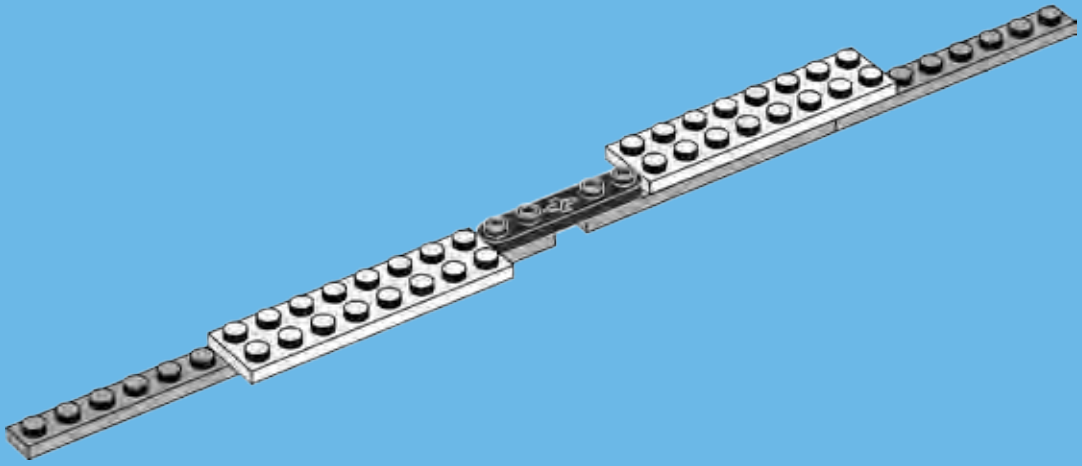

2x

4

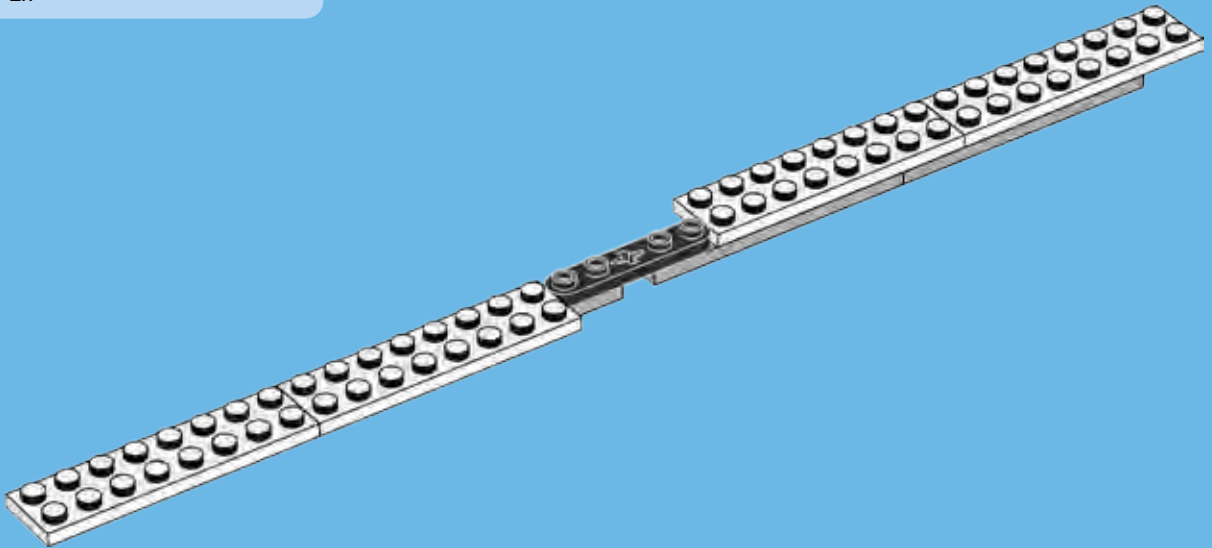



2x

5

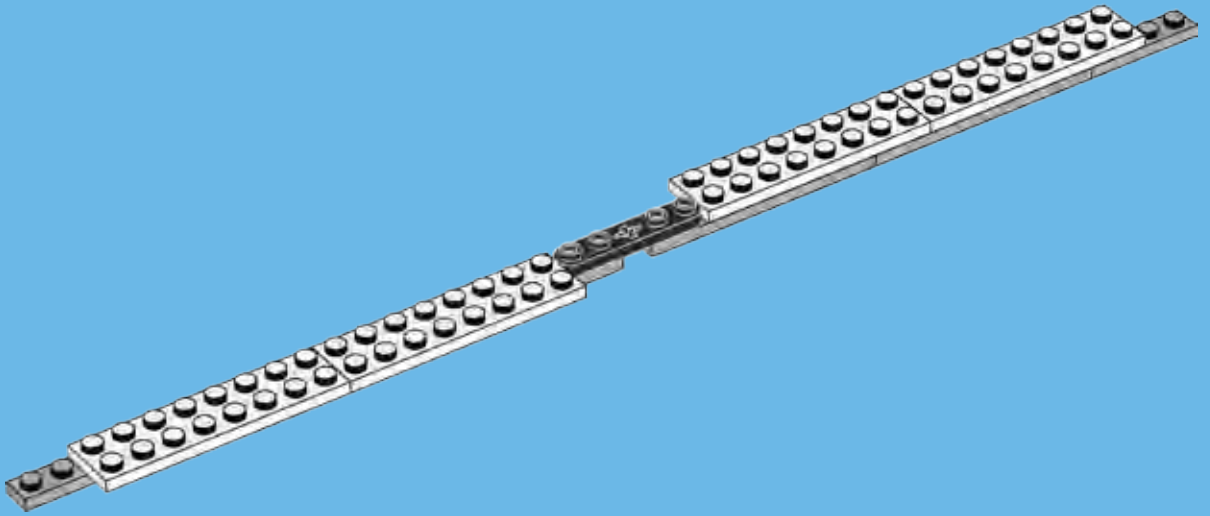

2x

6

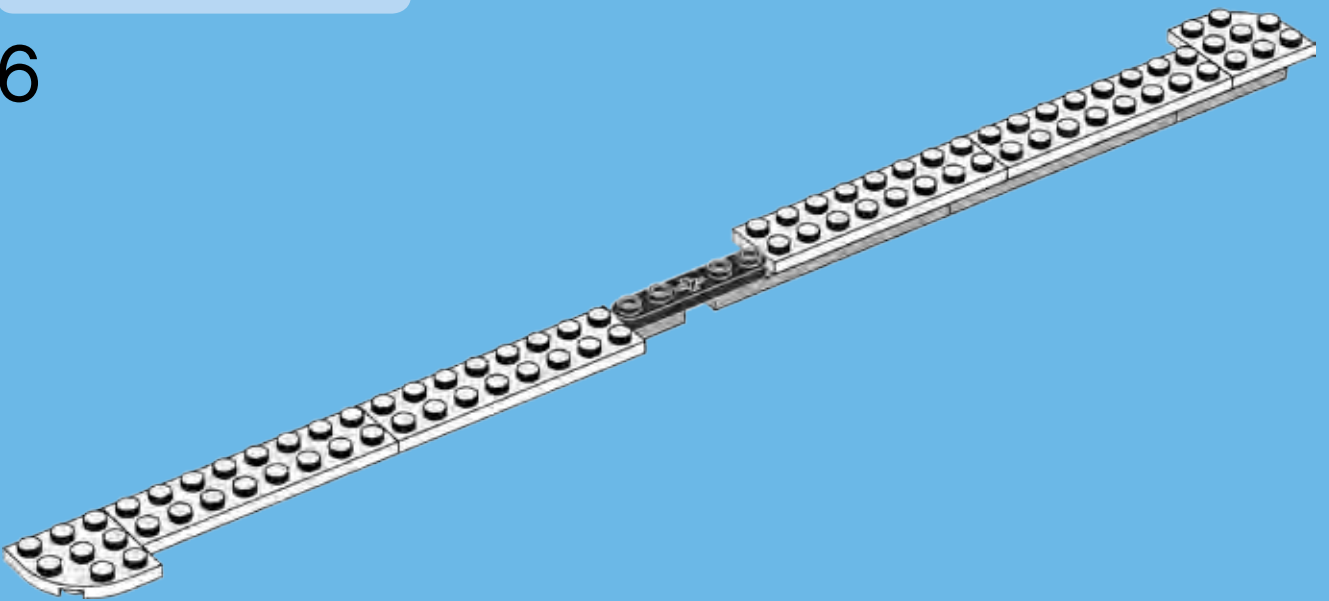

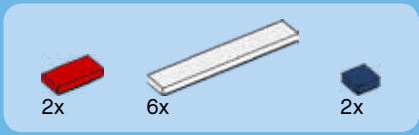

7

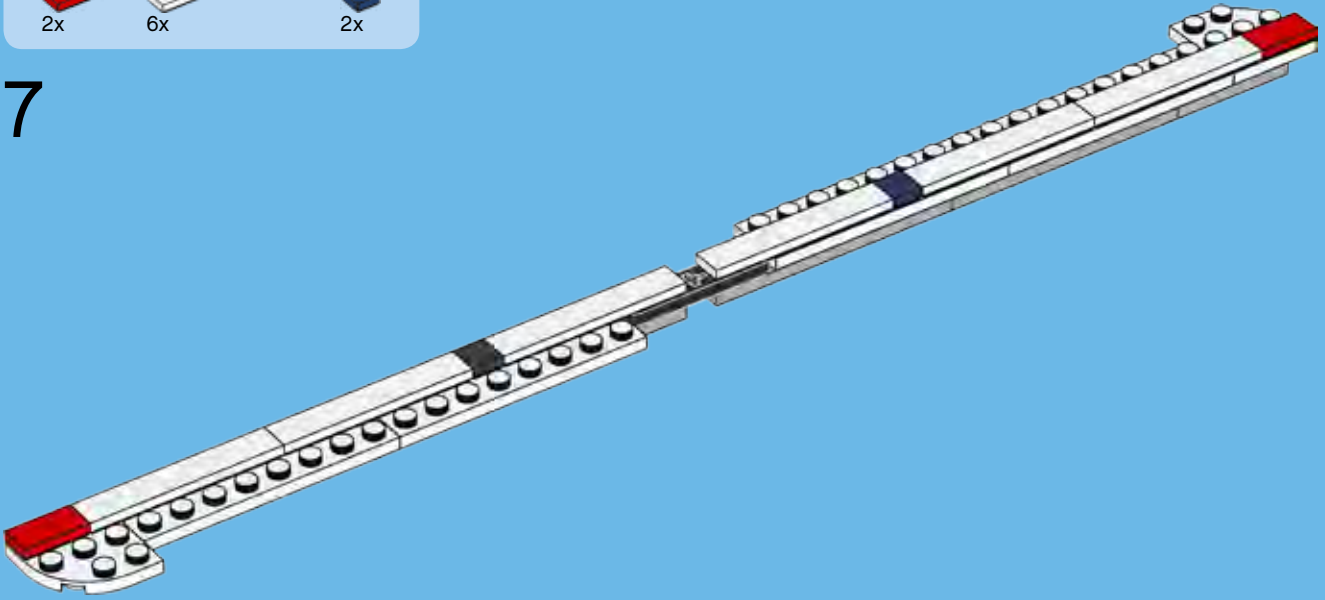

8

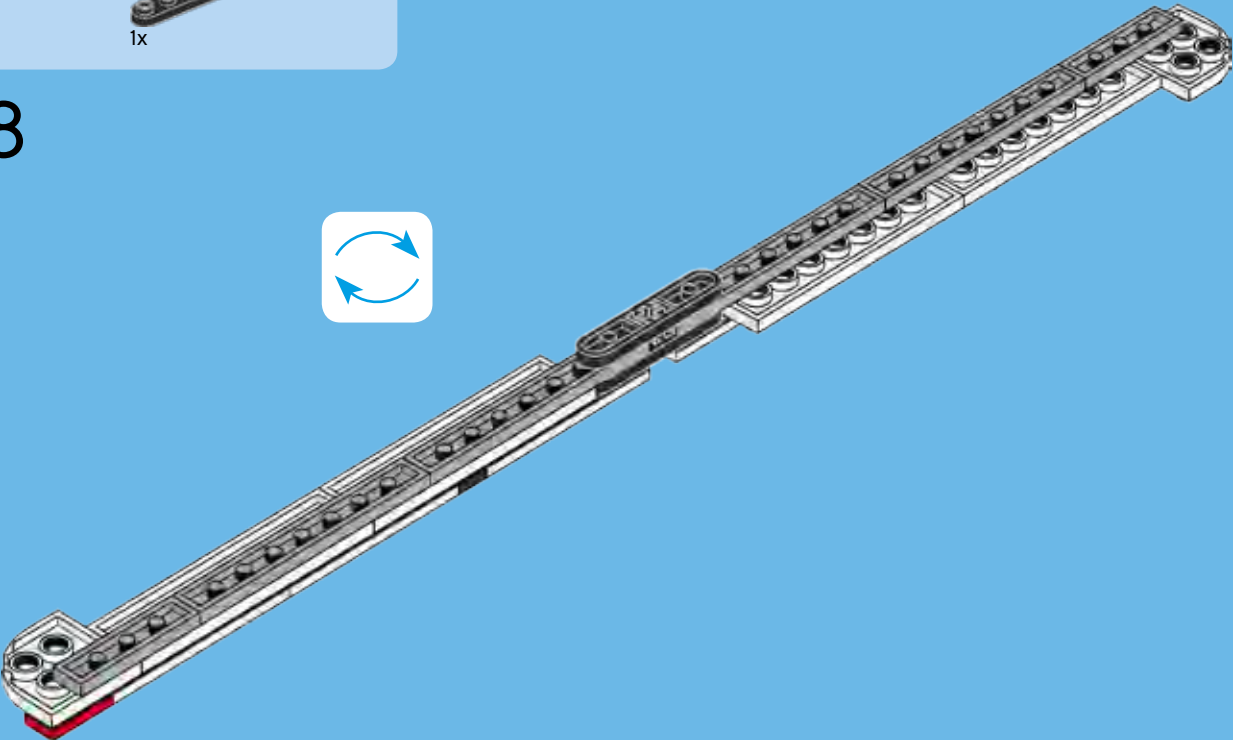

9

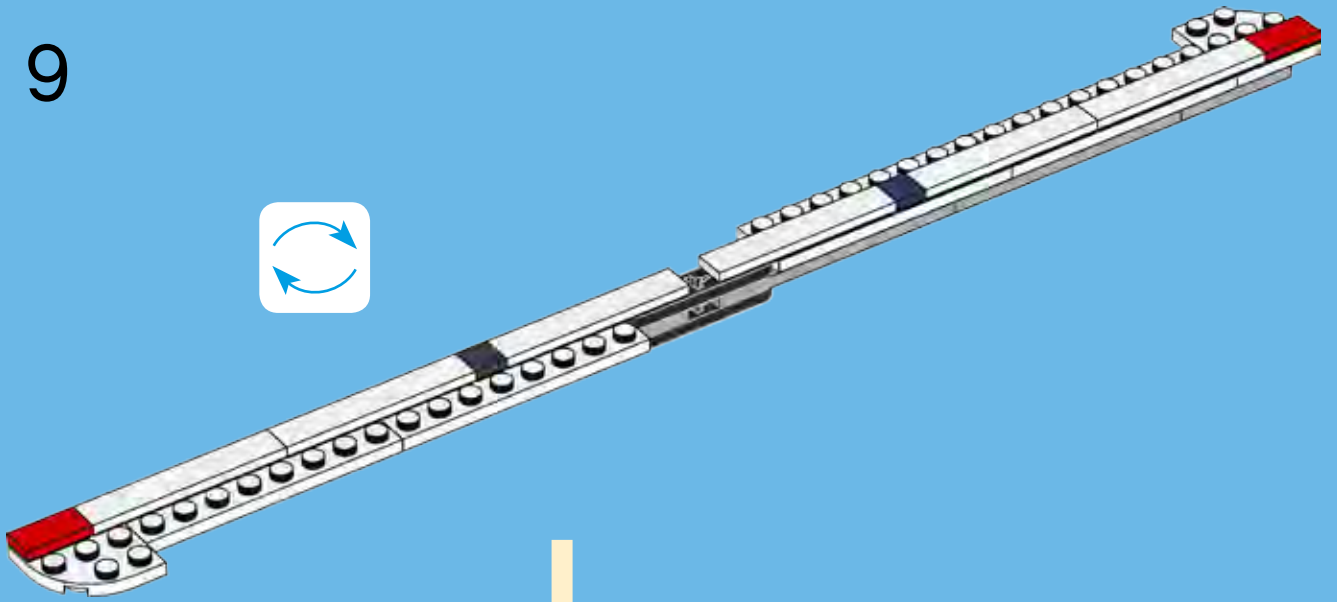

57

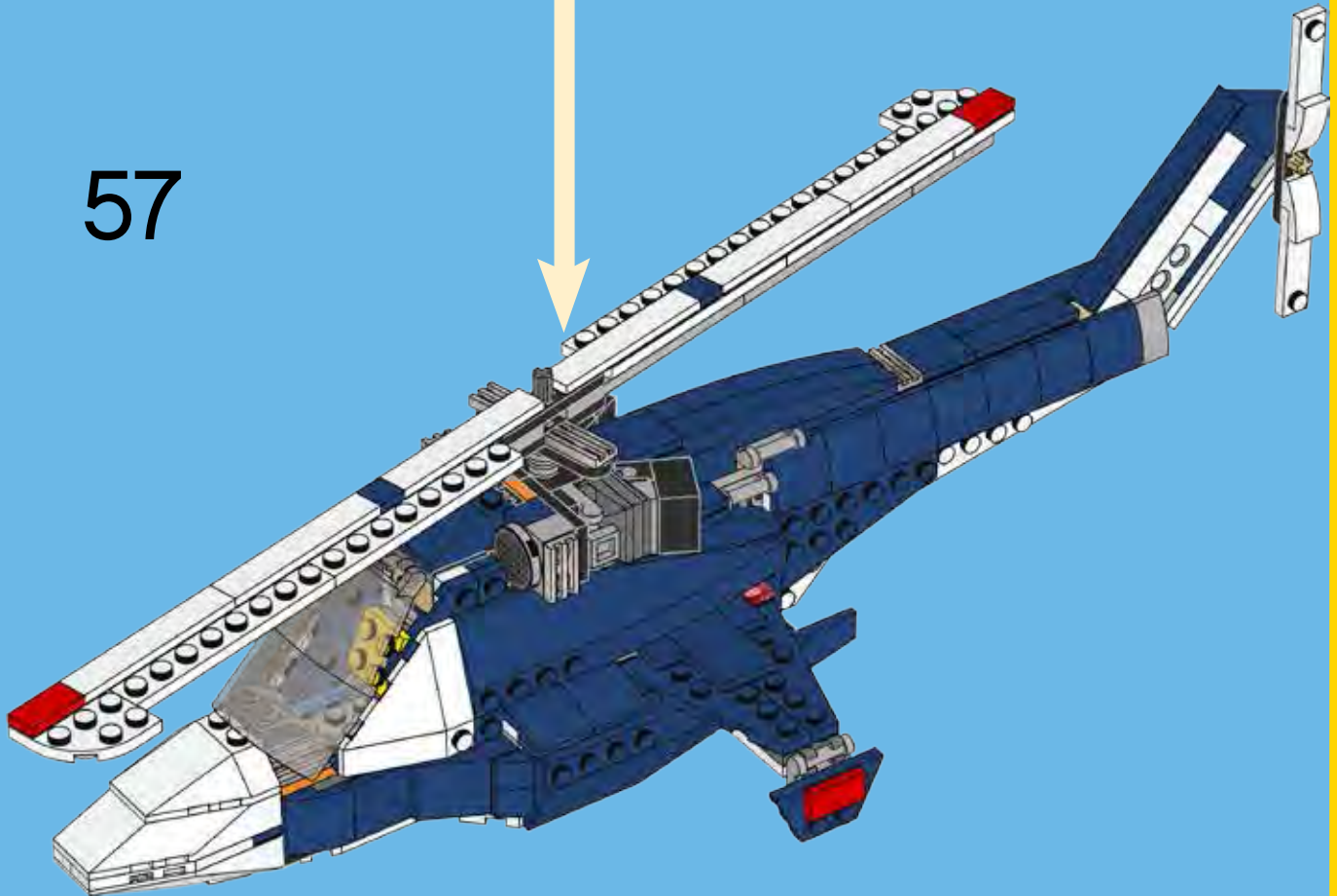

58



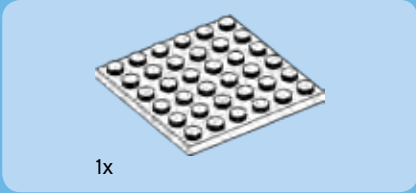

1x

1

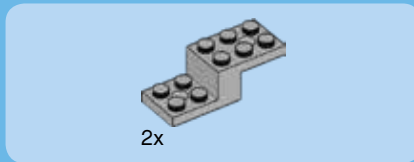
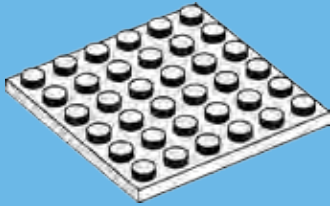

2x

2

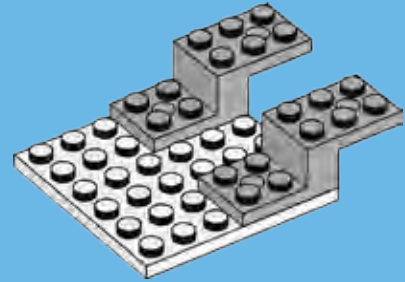

2x

2x

3

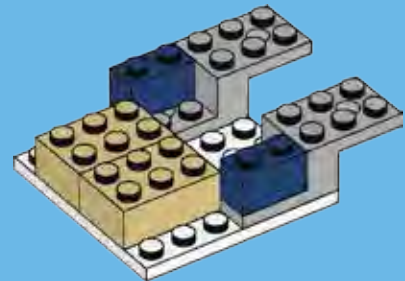

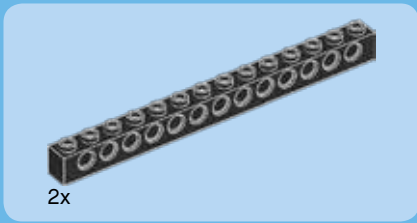

4

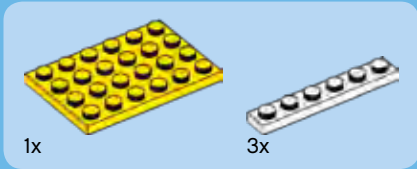
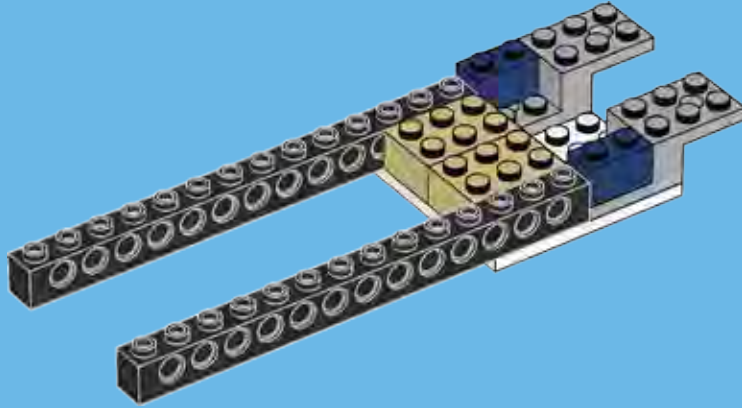

5

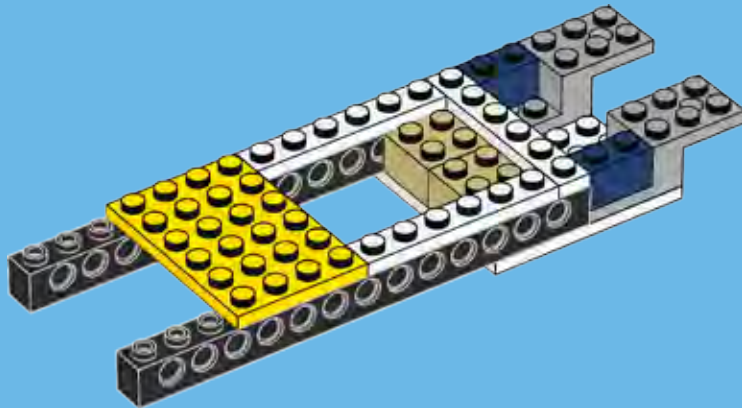



2x



2x



1x

6

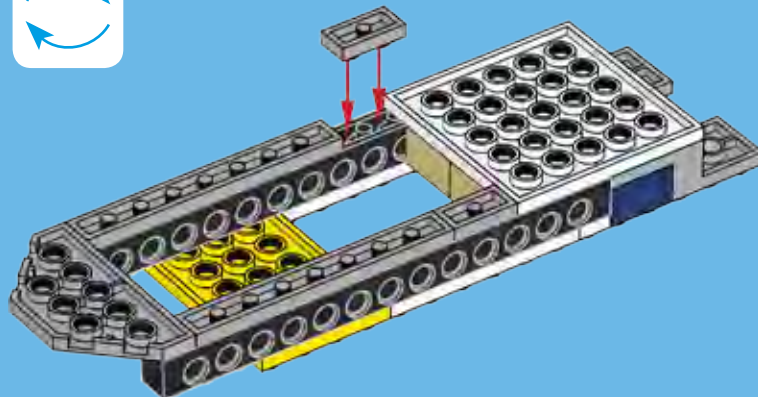

1x

7

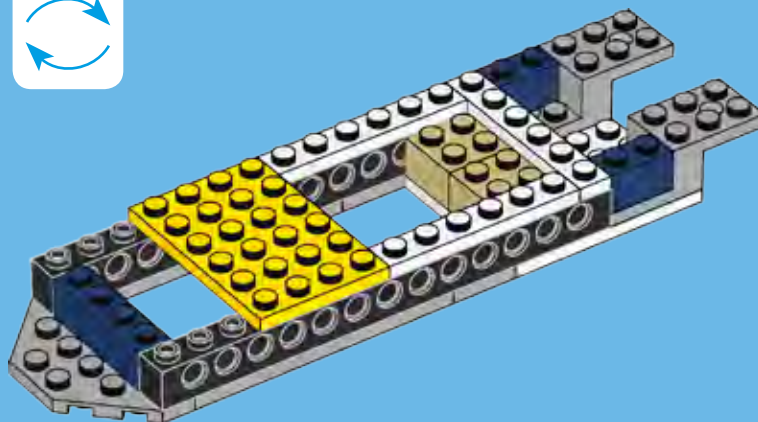



2x



2x

8

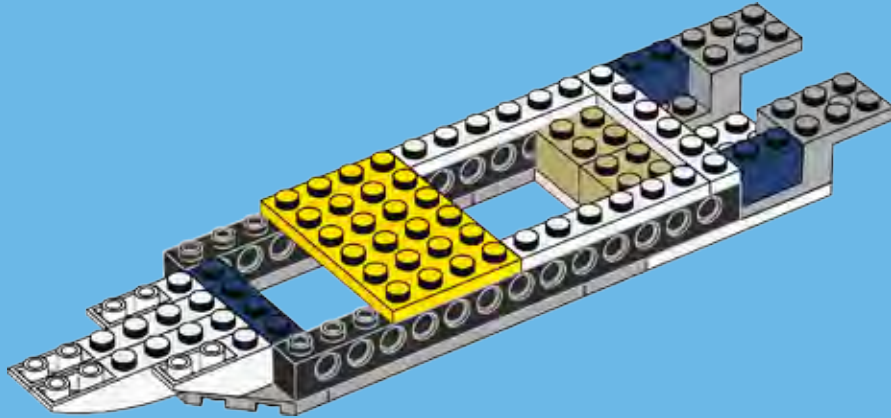

1x

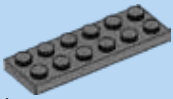

1x

9

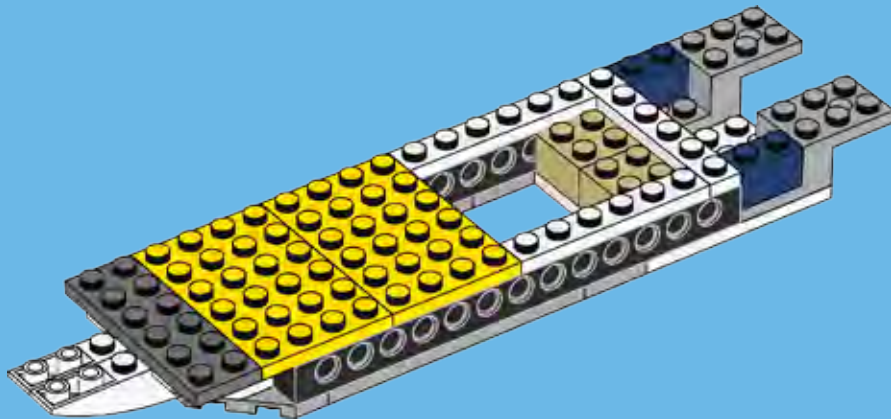

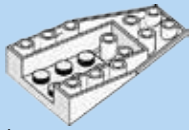

1x

10

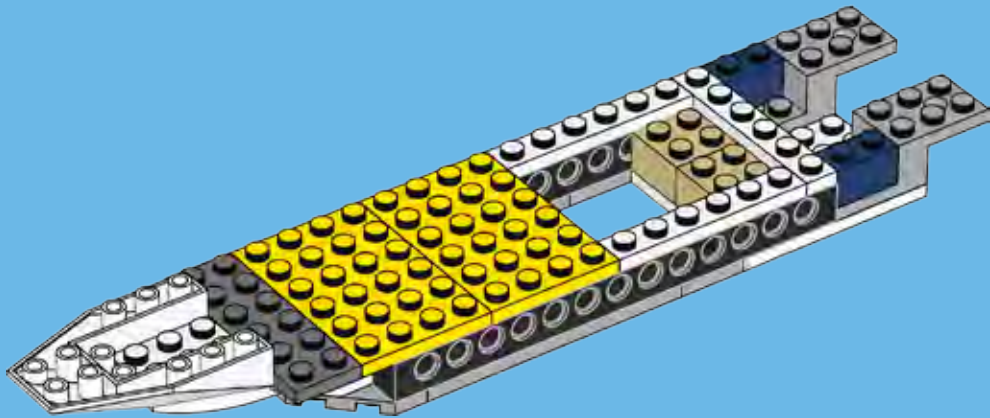

1x



1x



1x

11

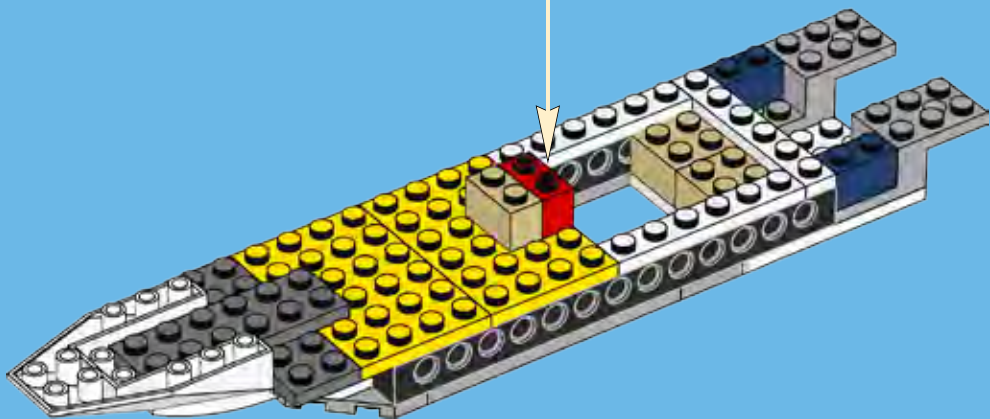



2x



2x



2x

12

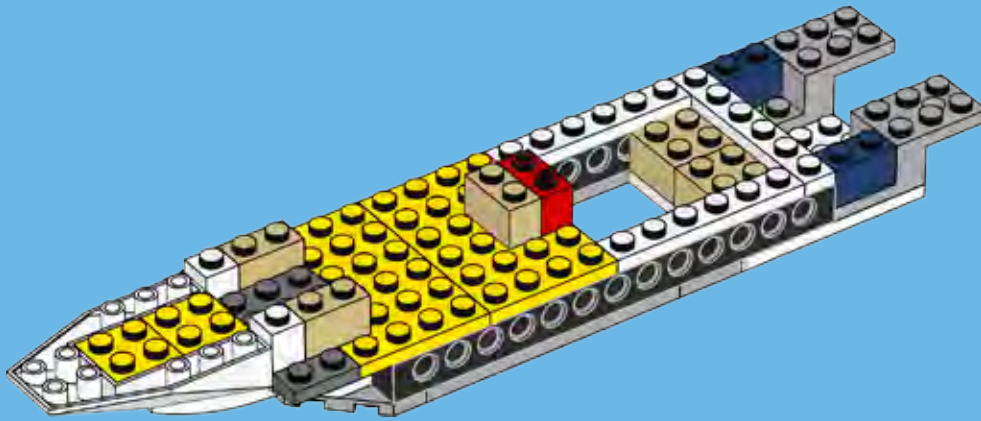

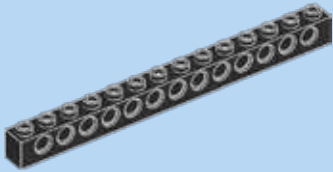

2x

13

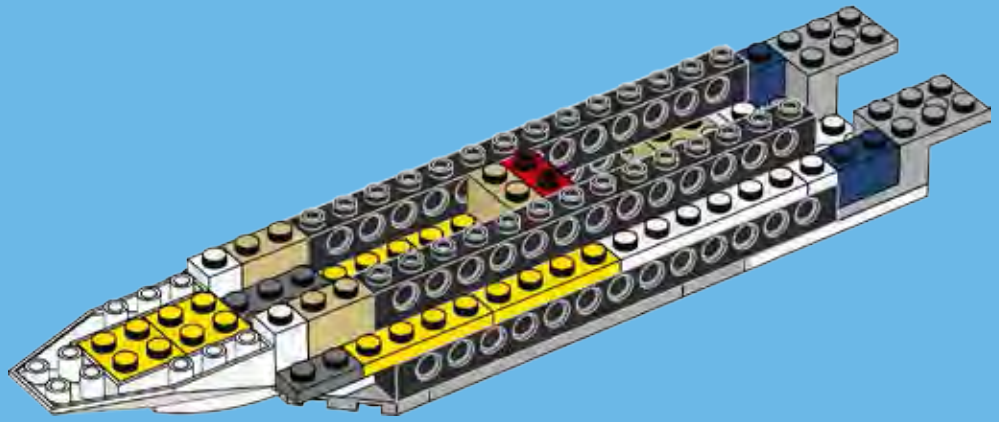

2x



2x



2x

14

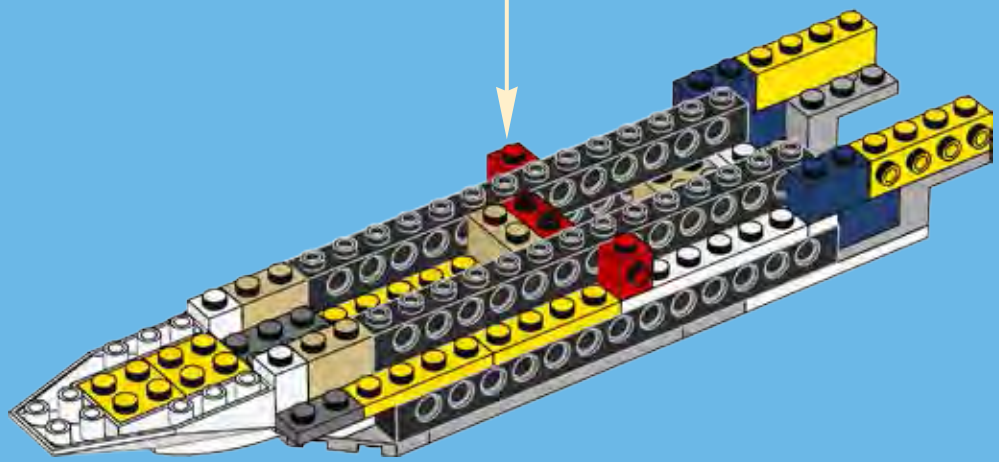

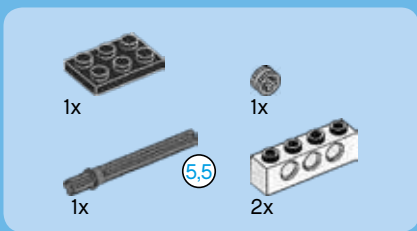

15

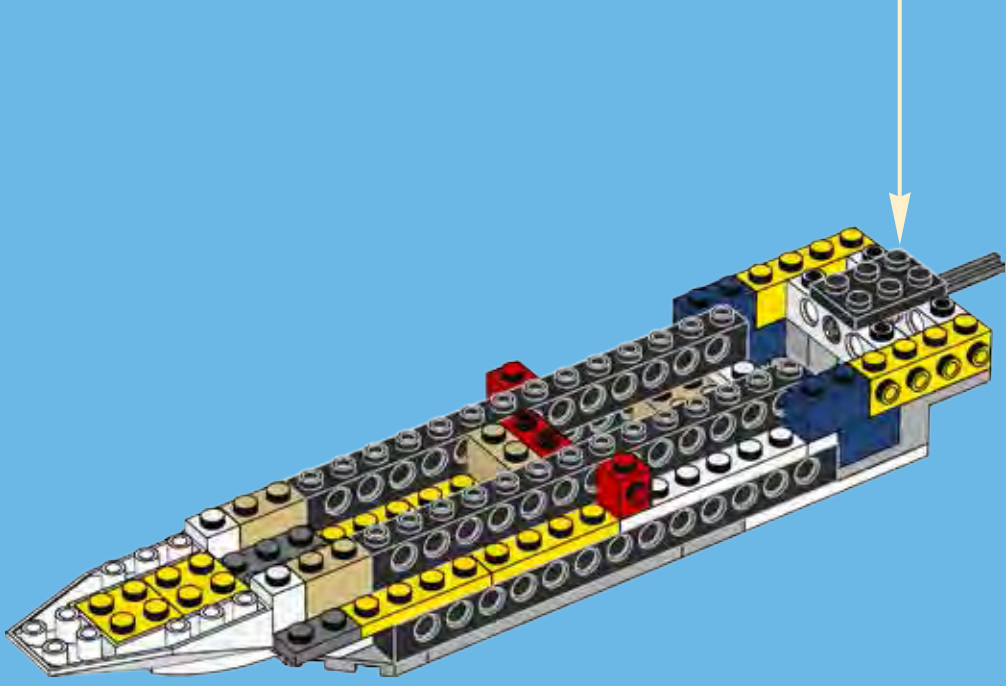
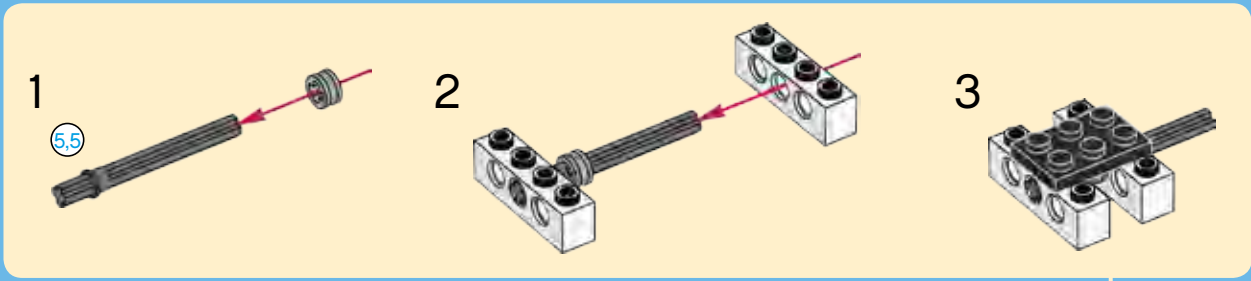



10x



2x

16

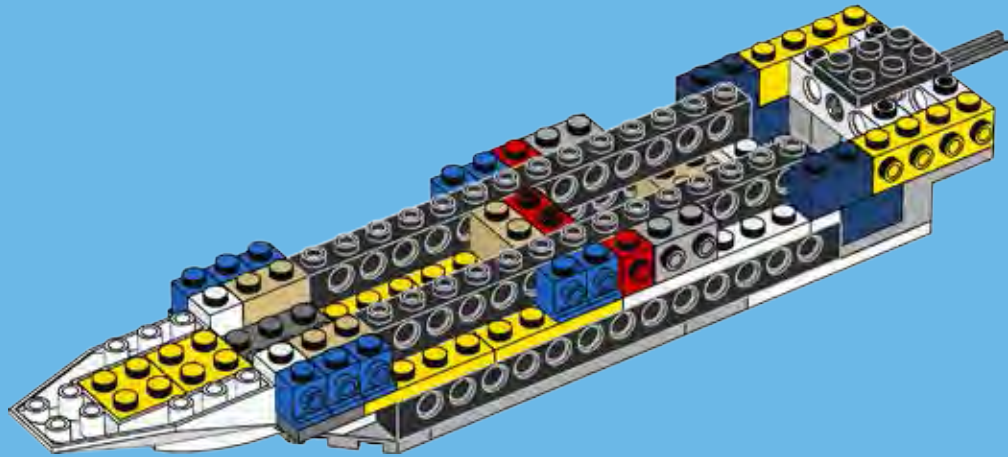

1x



1x



1x

17

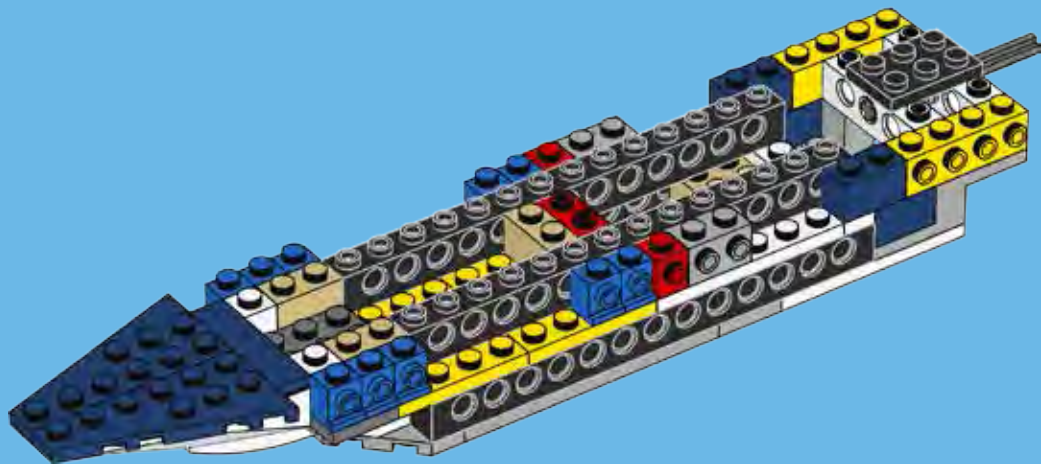



2x

18

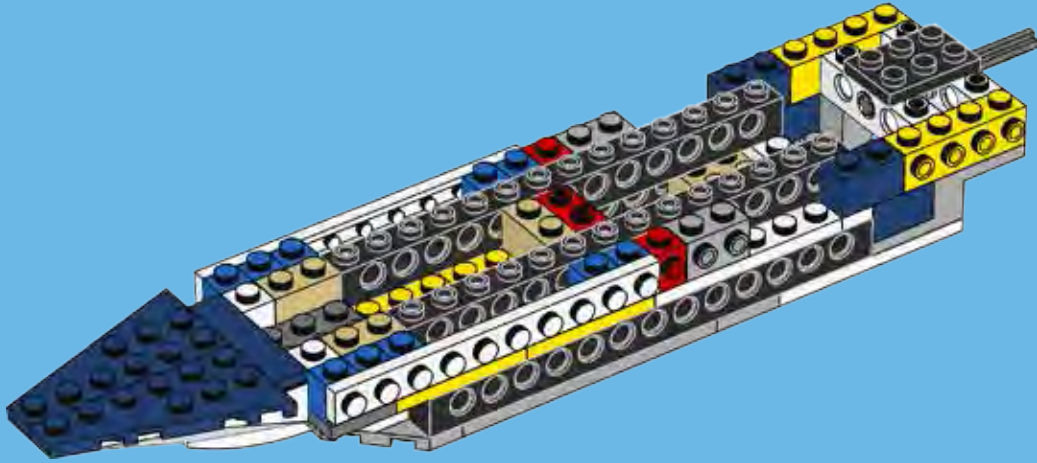

1x



1x

19

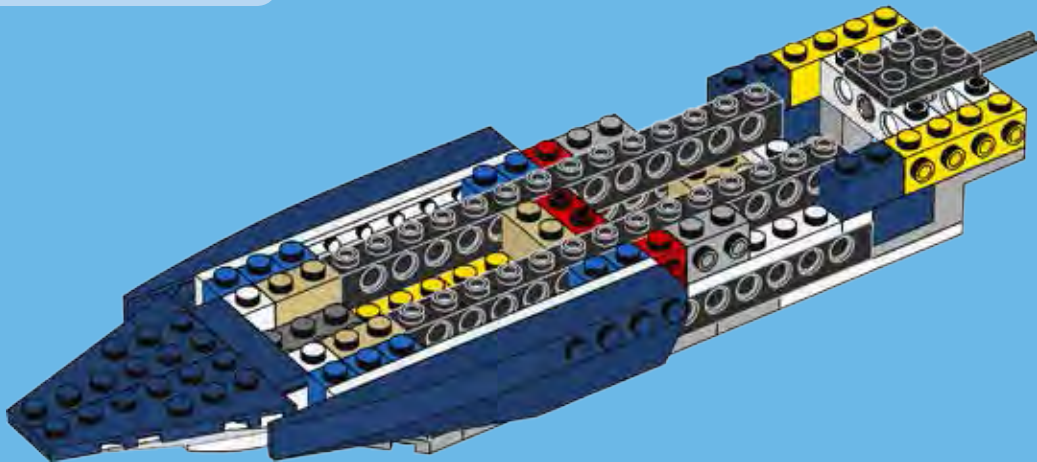

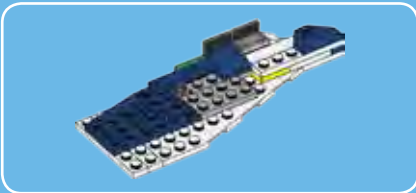

1

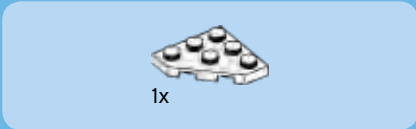

2

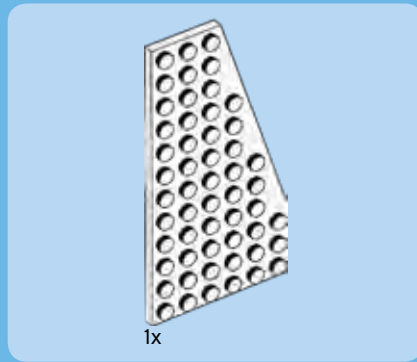

3

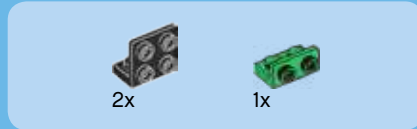
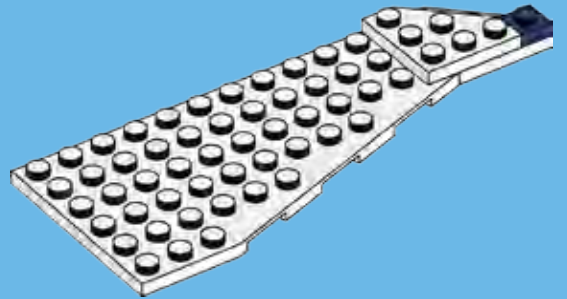

4

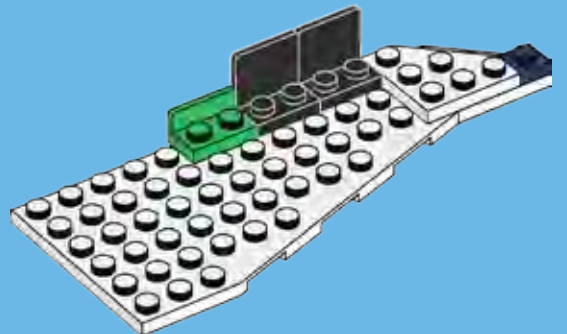



1x



1x



1x

5



1x



1x

6





2x

7



1x



1x

8



1x



1x



1x

9

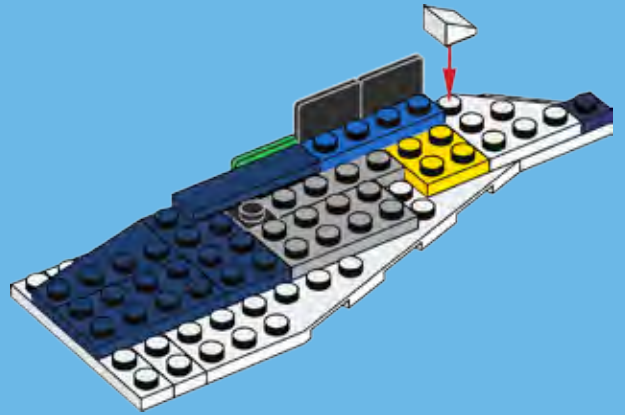

1x



1x



1x

10

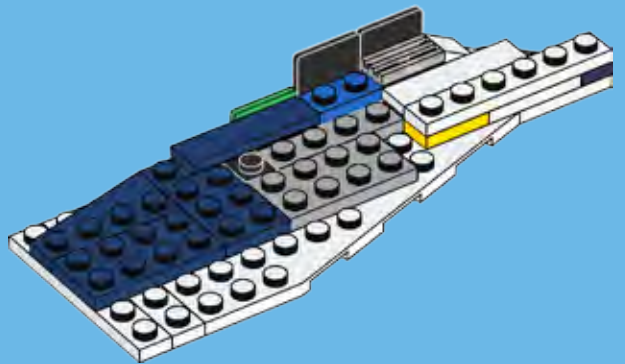



1x



1x

11

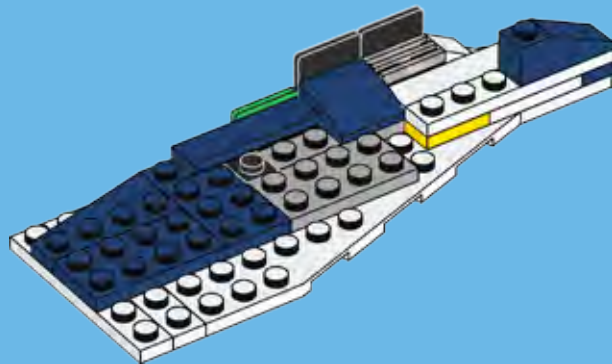

20

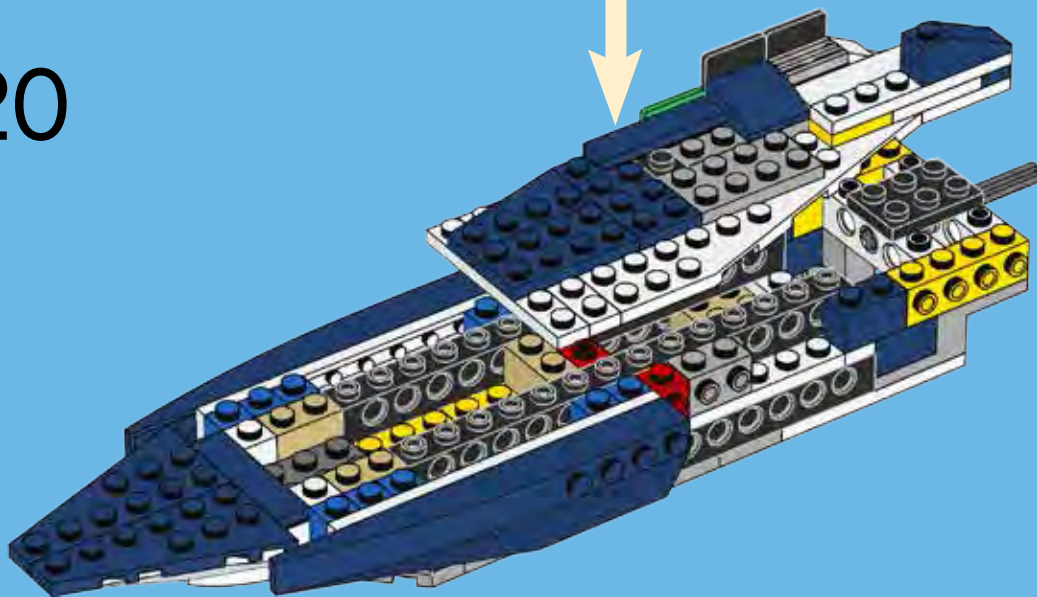

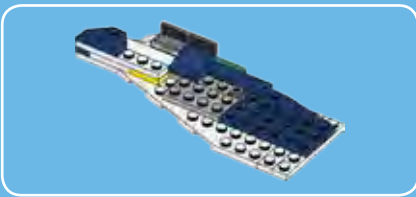

1

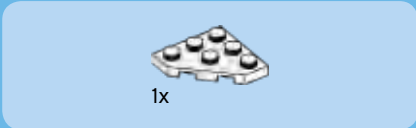

2

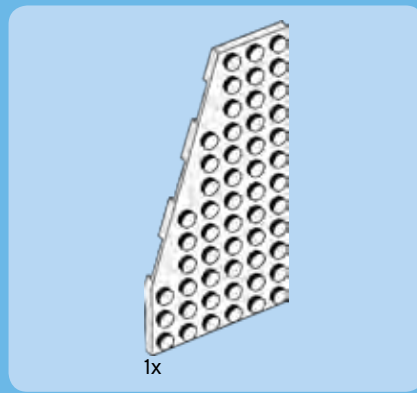

3

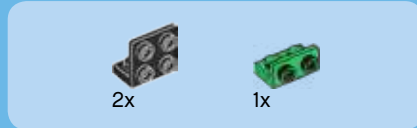
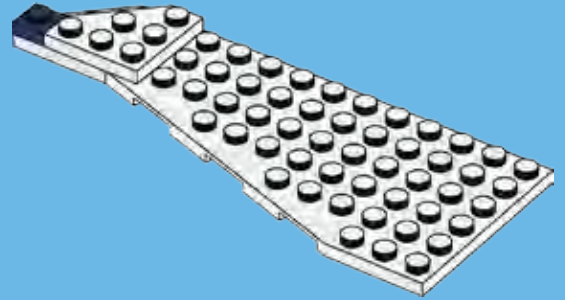

4

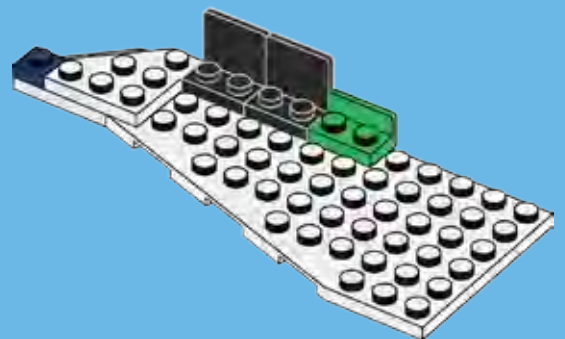



1x



1x



1x

5



1x



1x

6





2x

7

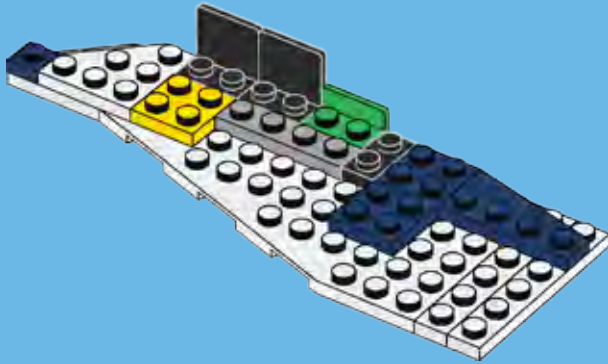

1x



1x

8



1x



1x



1x

9

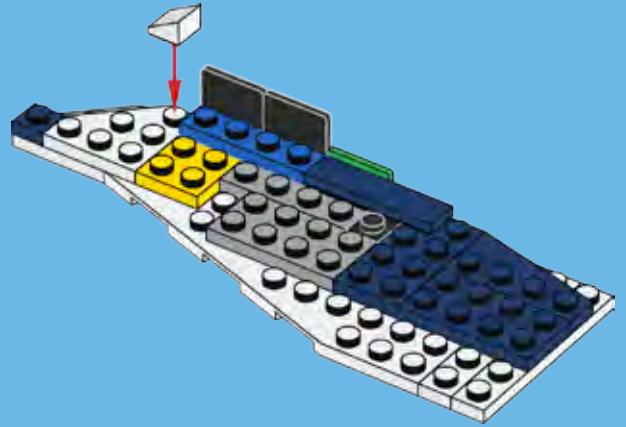

1x



1x



1x

10

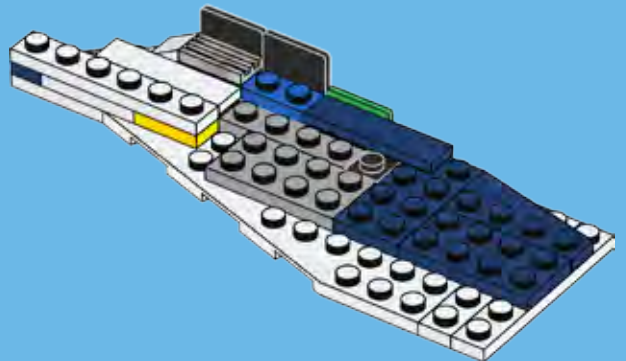



1x



1x

11

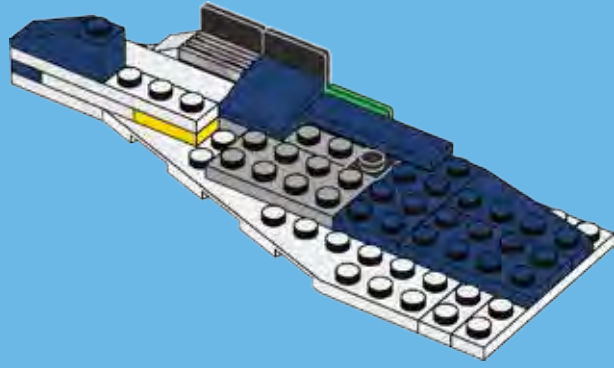

21

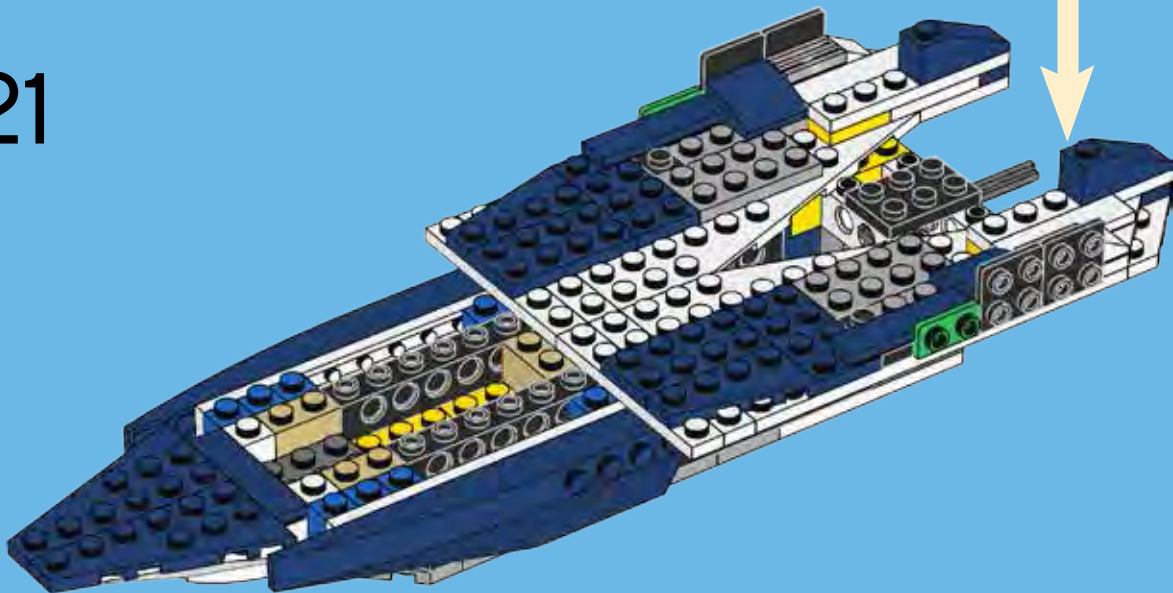

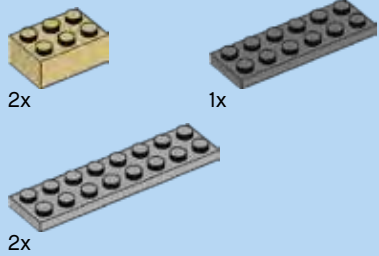

22

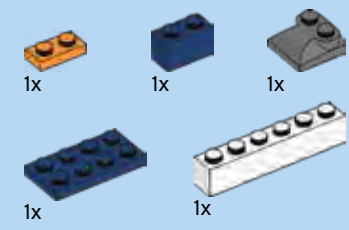
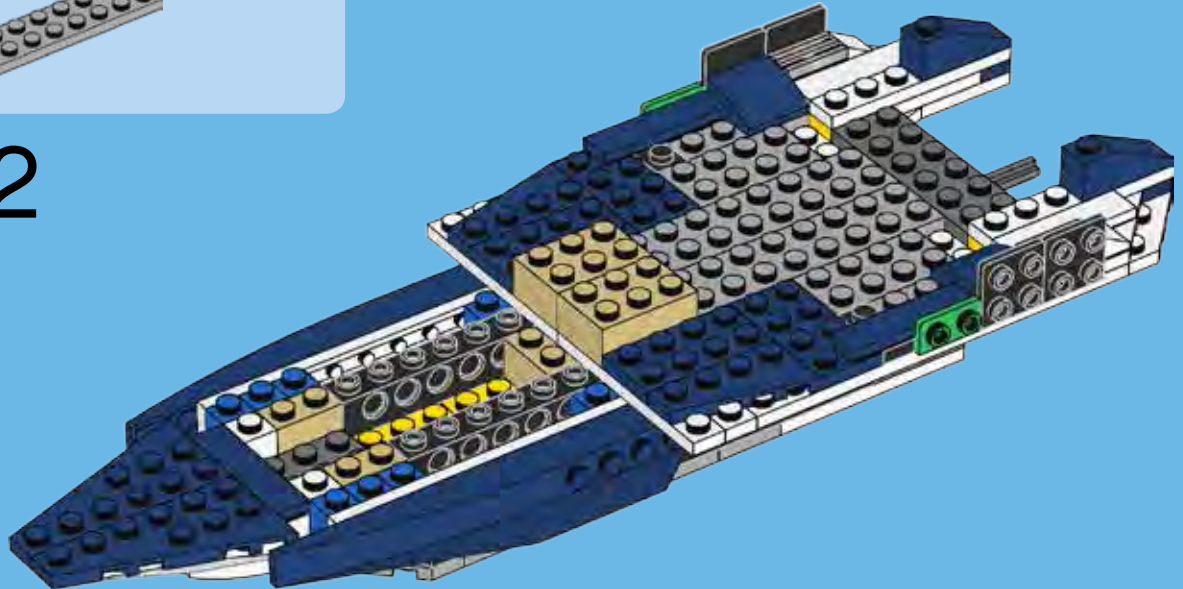

23



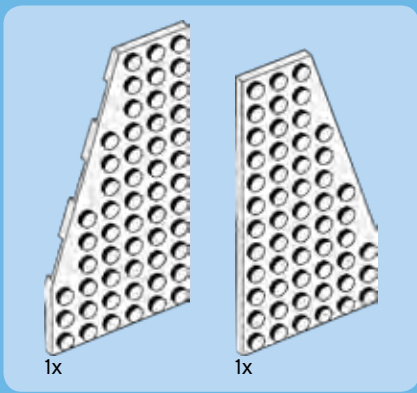

24

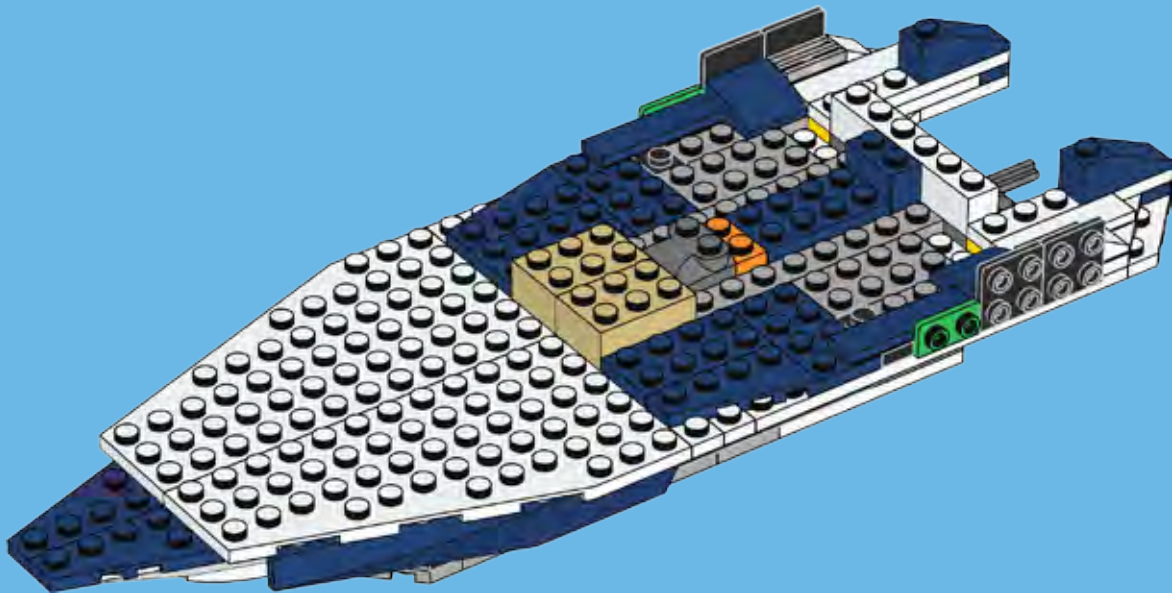

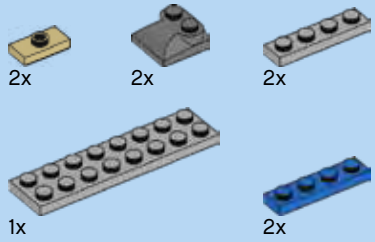

25

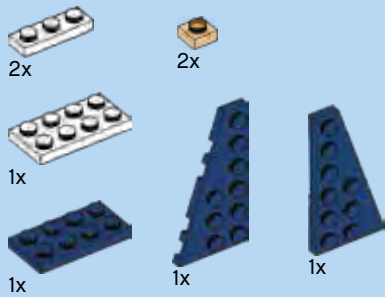
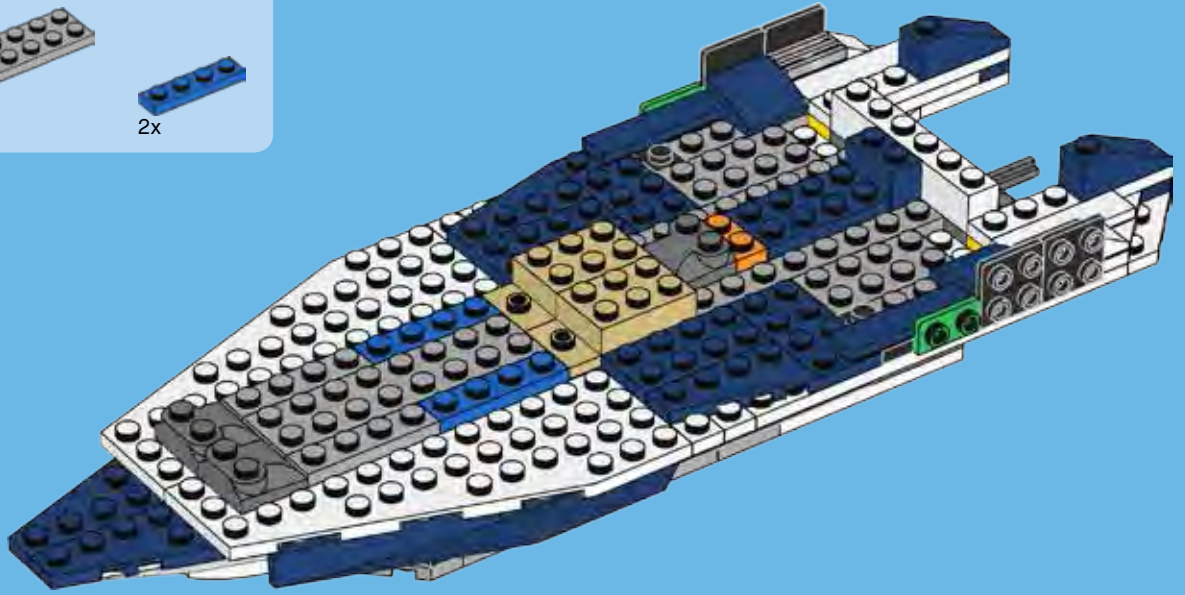

26

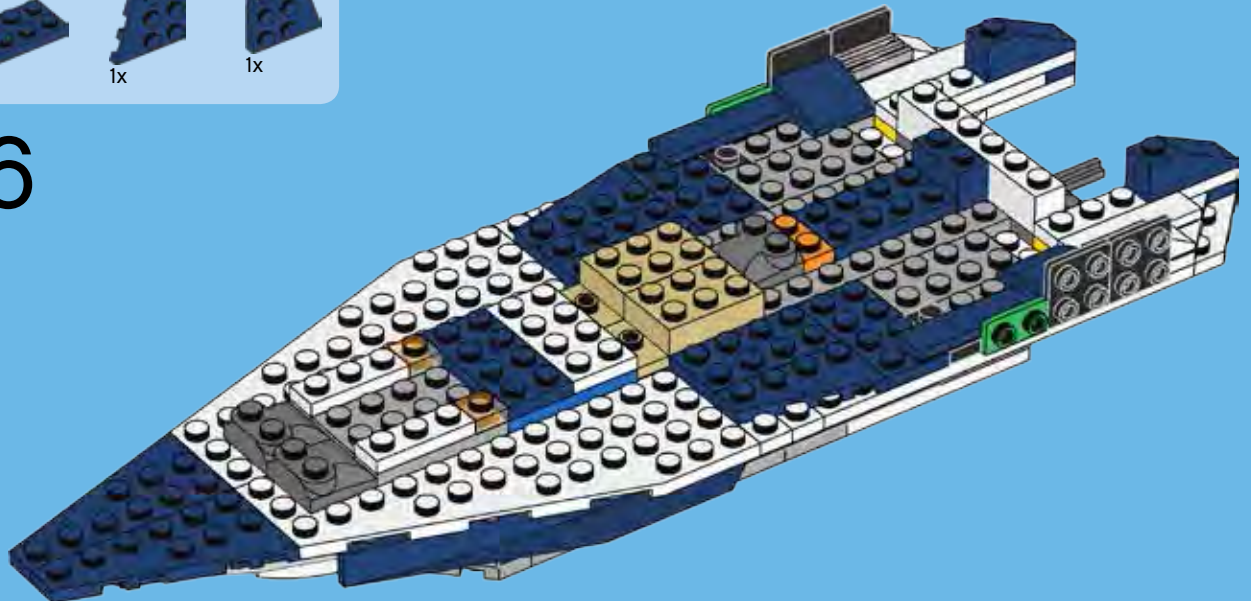

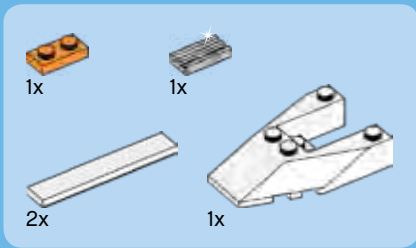

27

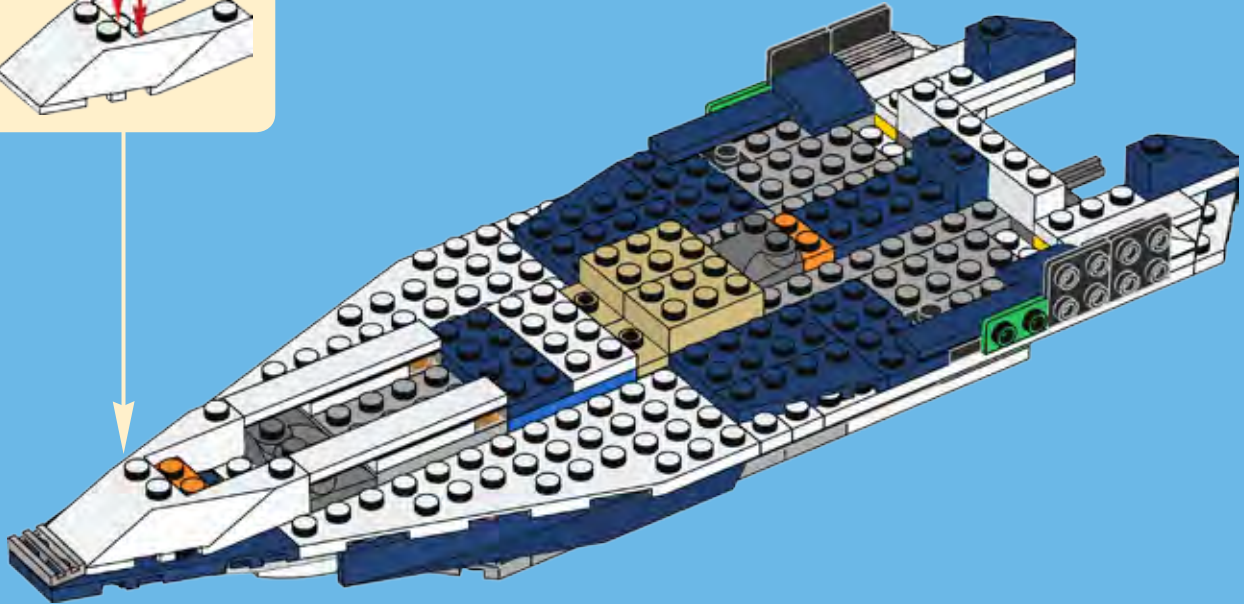
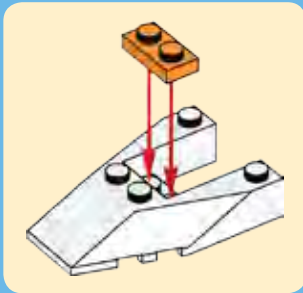



2x

28

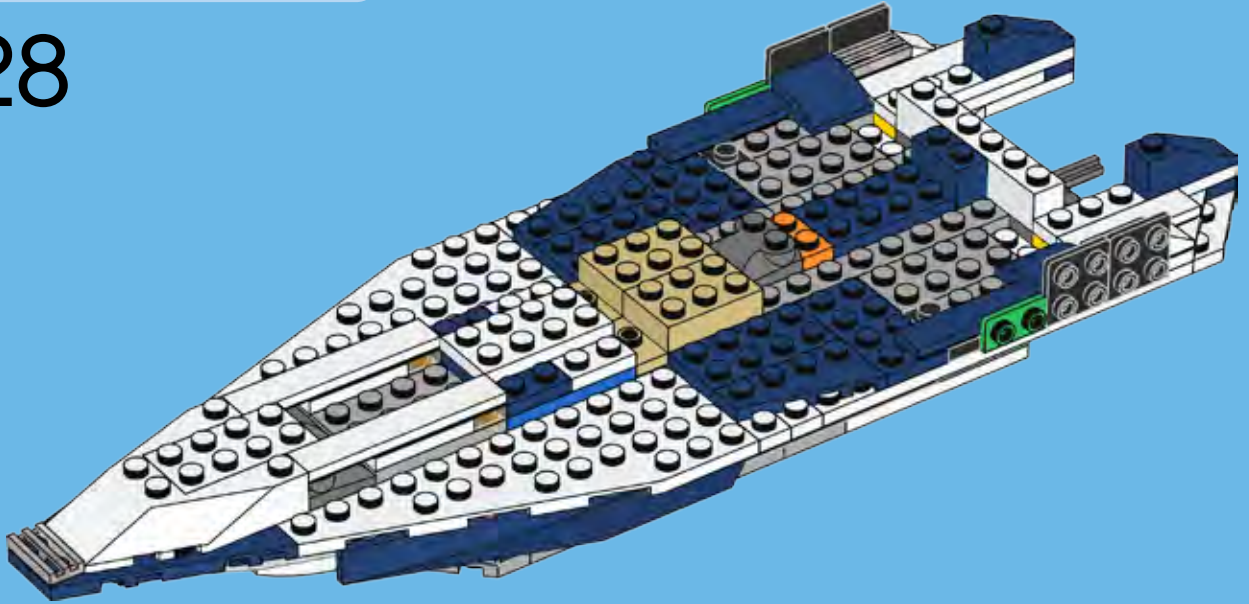

1x



1x



3x



1x

29





2x



1x



2x

30

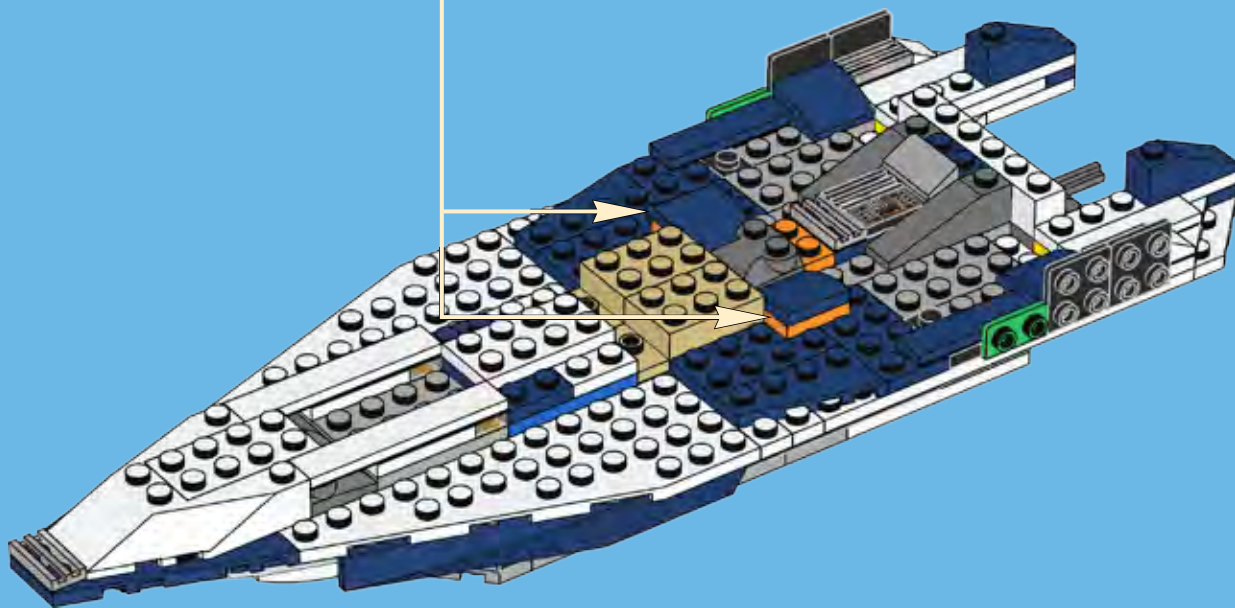



1x



2x



2x



2x

31

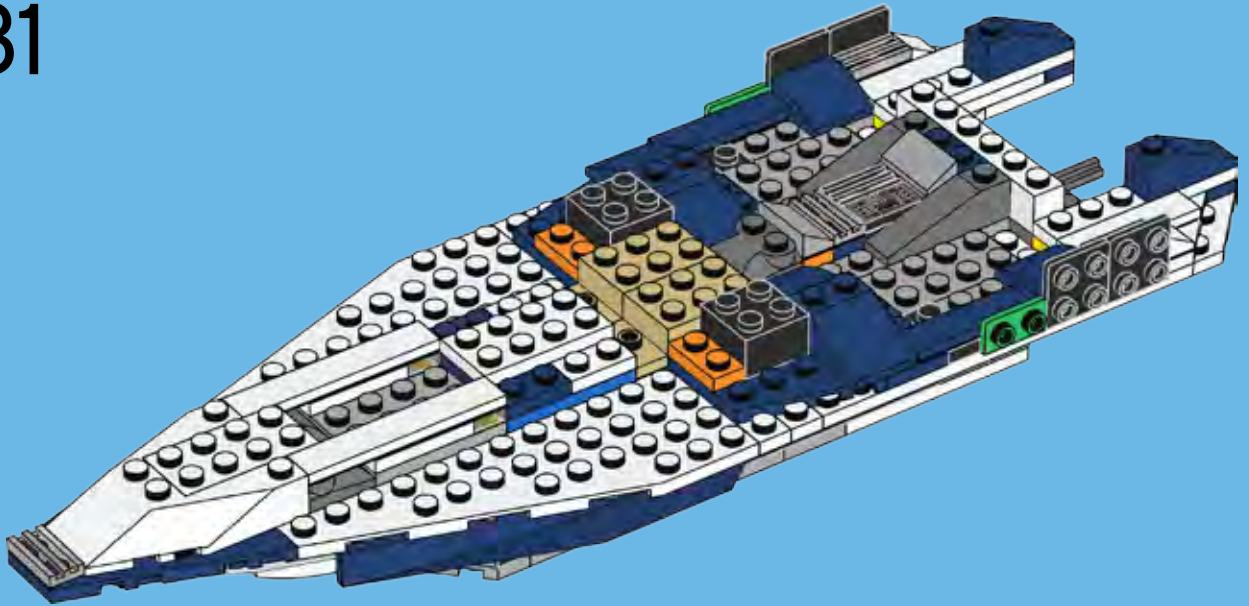

2x



4x



2x

32



2x

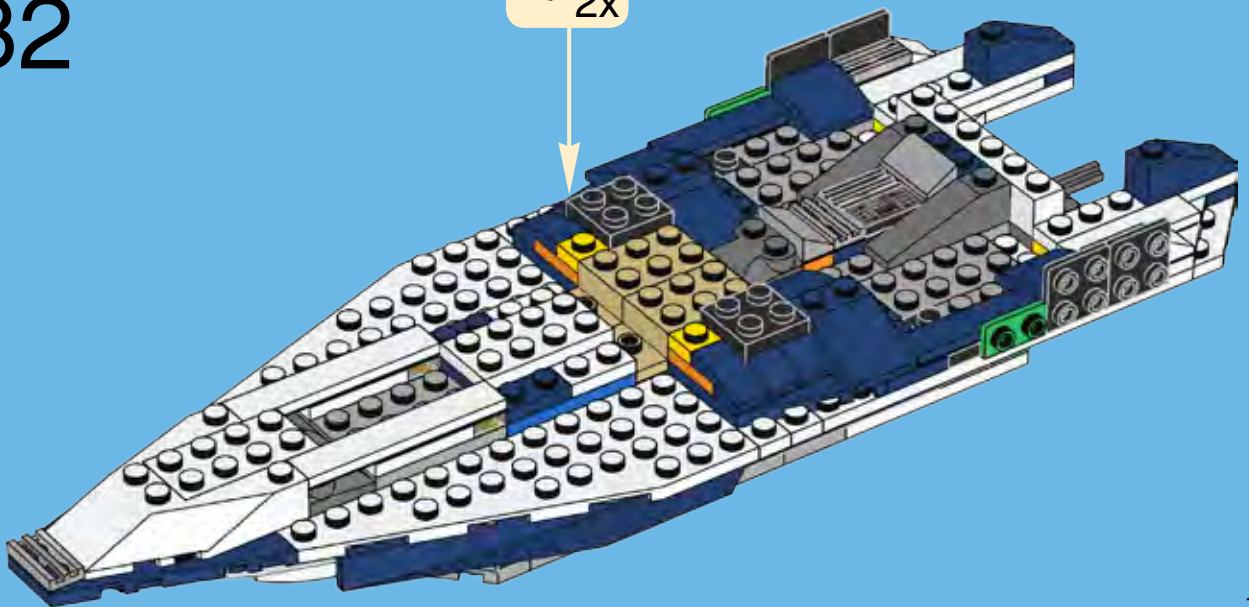



1x



1x



1x



2x



1x

33

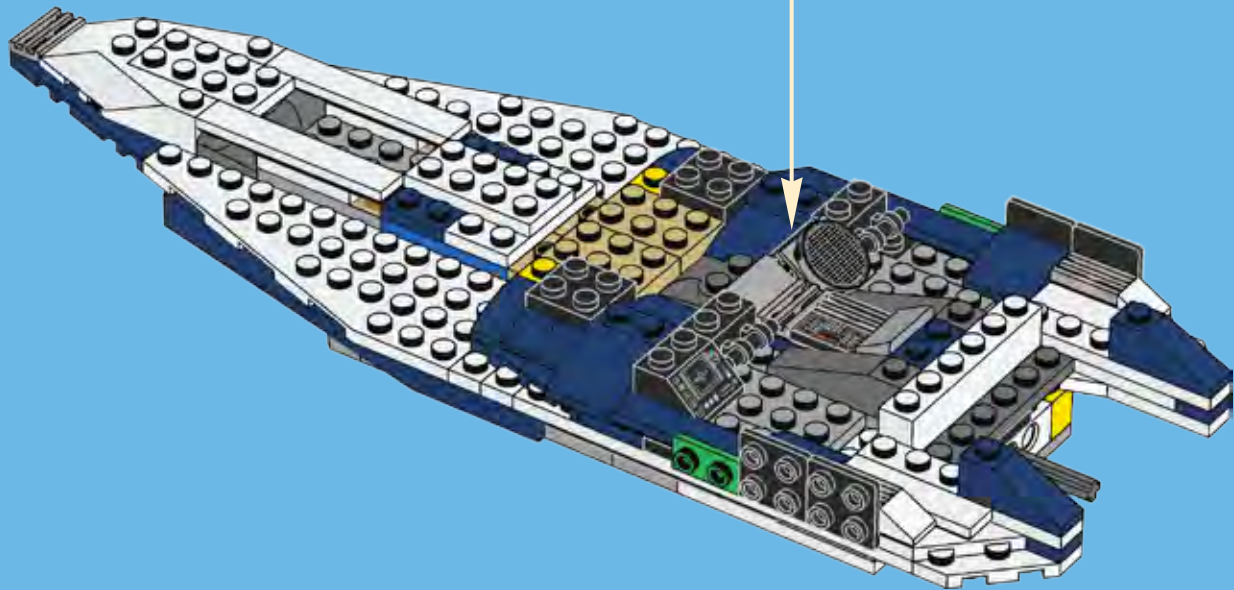
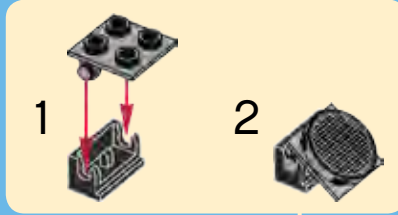



1x

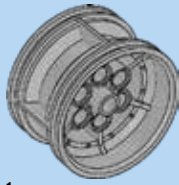

1x

34

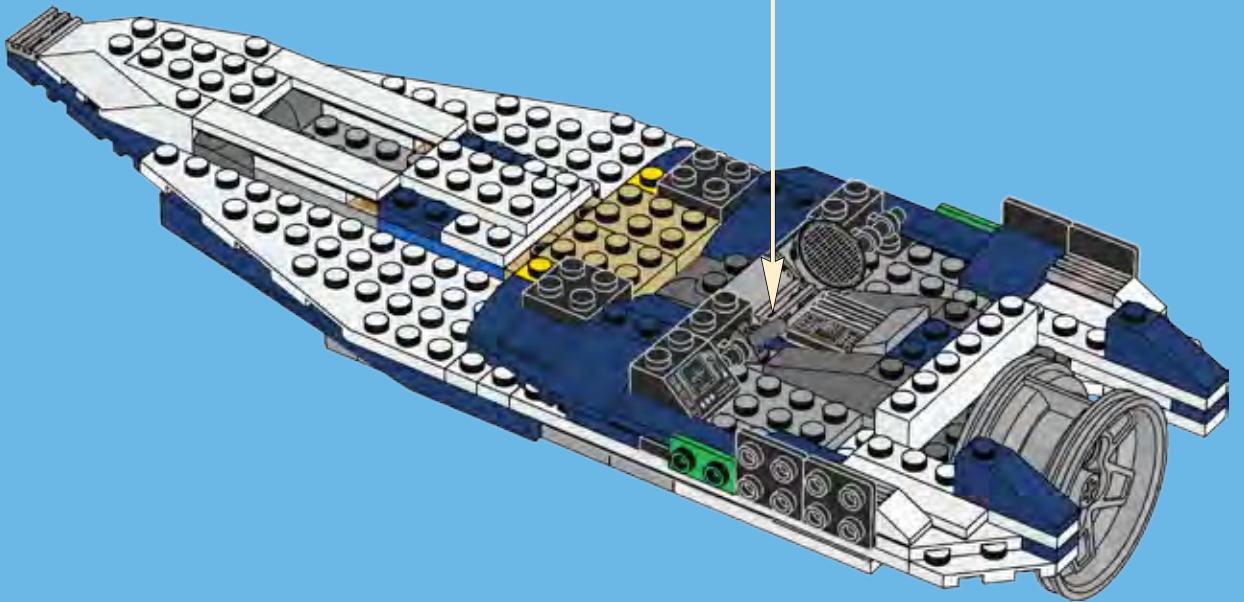



35

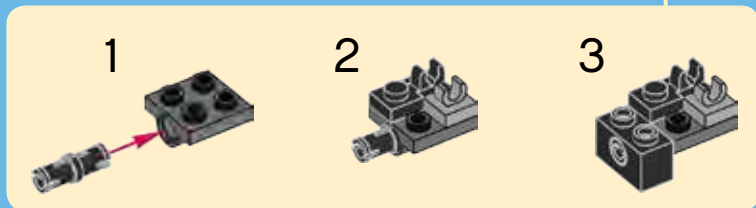
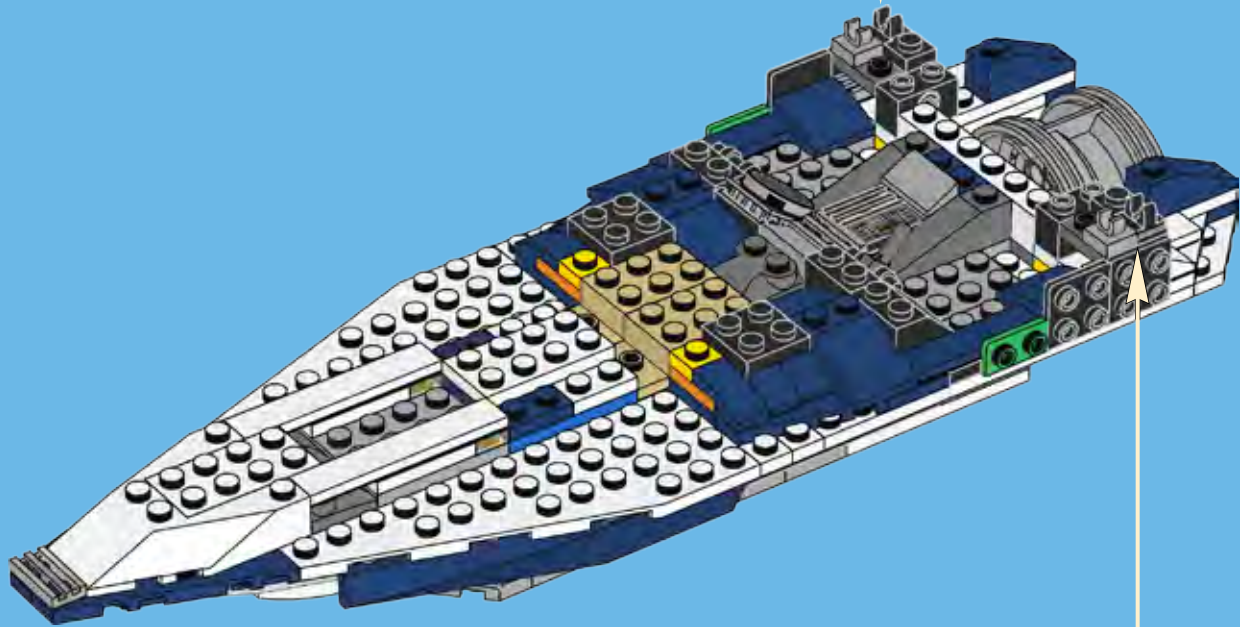
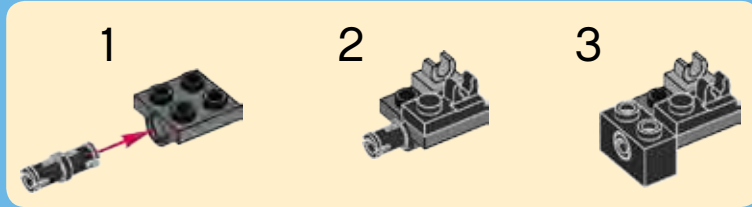



1x



2x

36

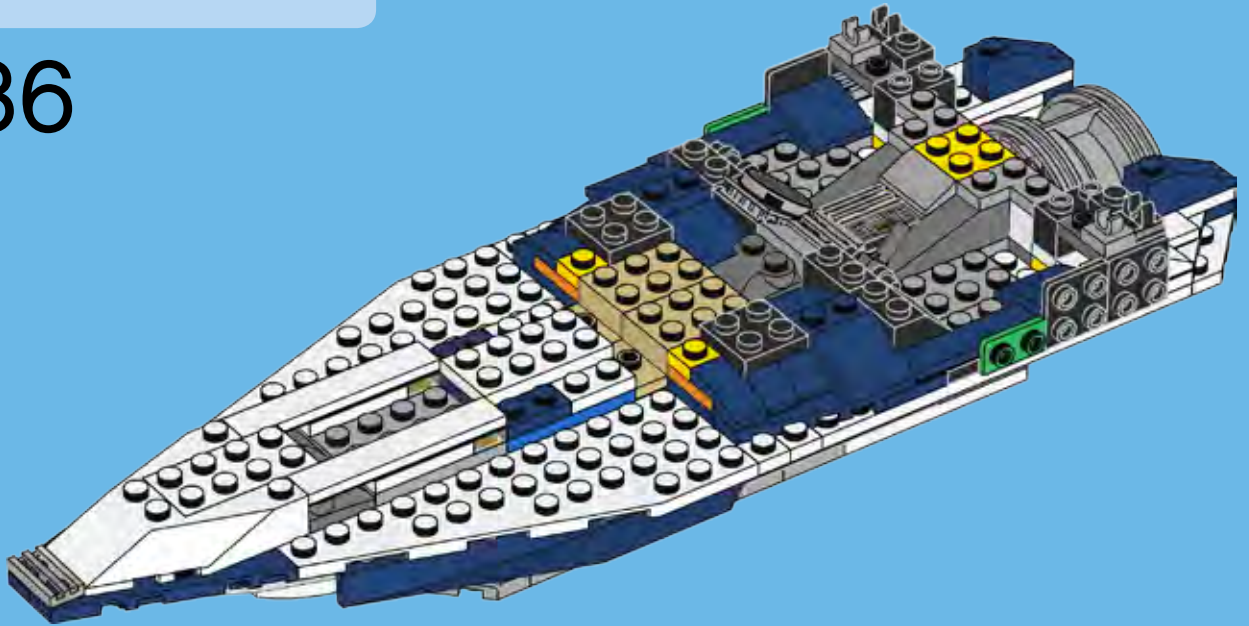

1x



2x

37

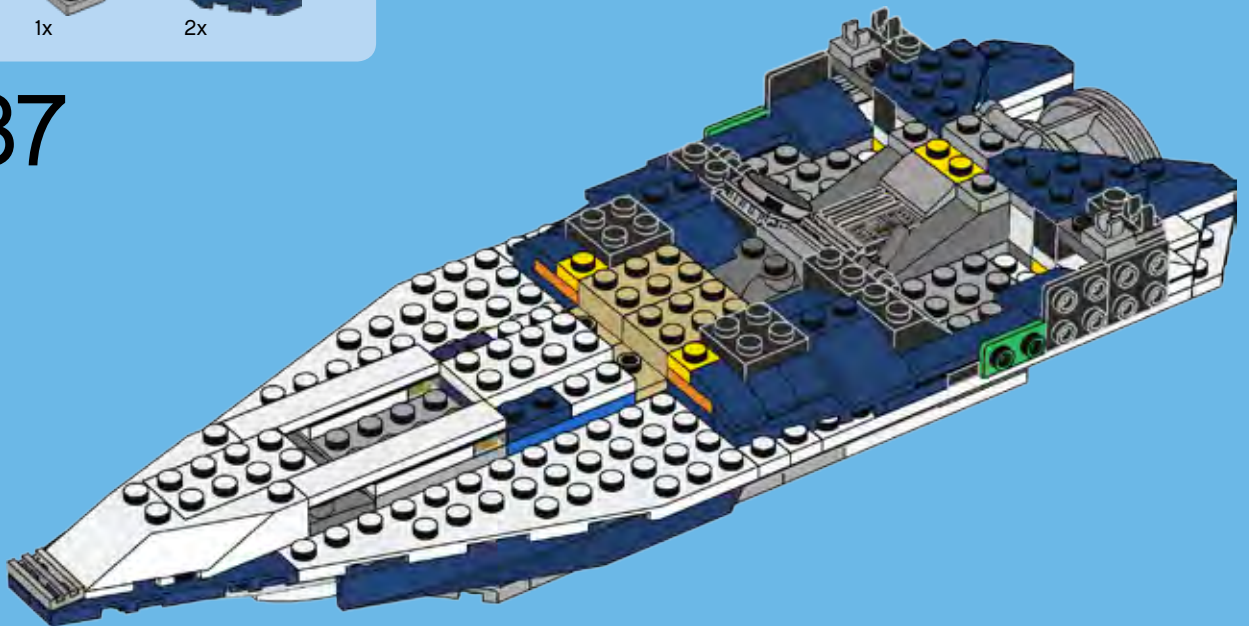



2x



2x

38

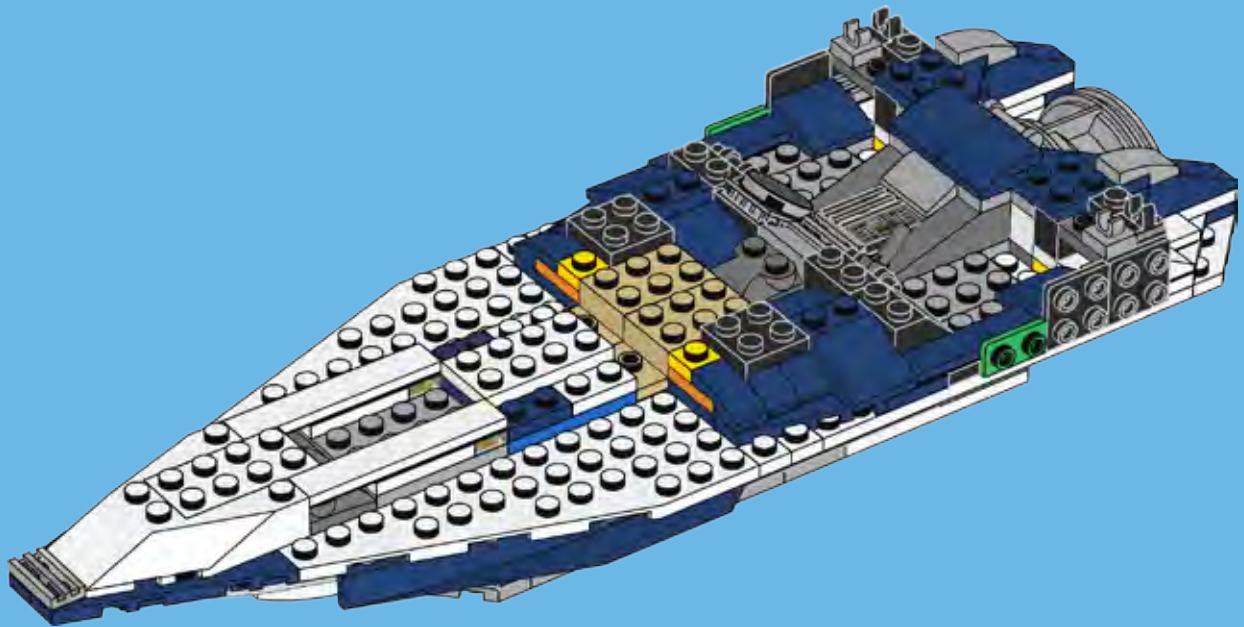



2x



2x



2x



2x



2x

39

1

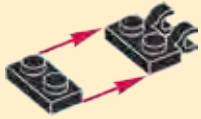

2



3



4



5

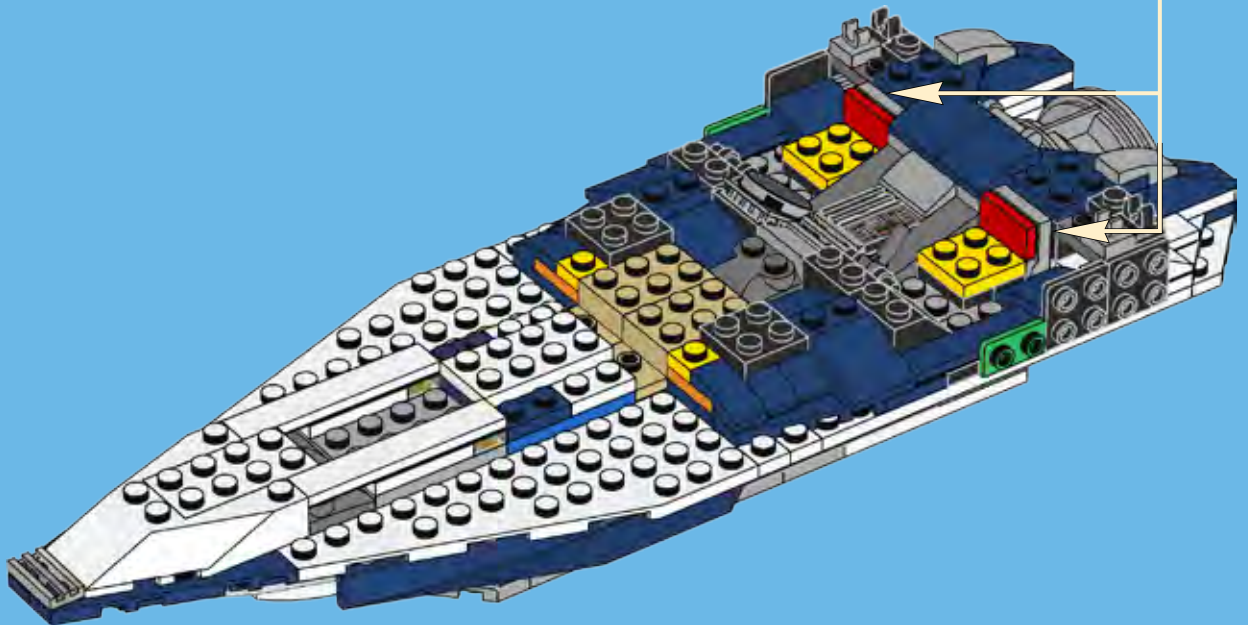
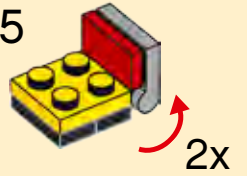



2x



1x



1x

40

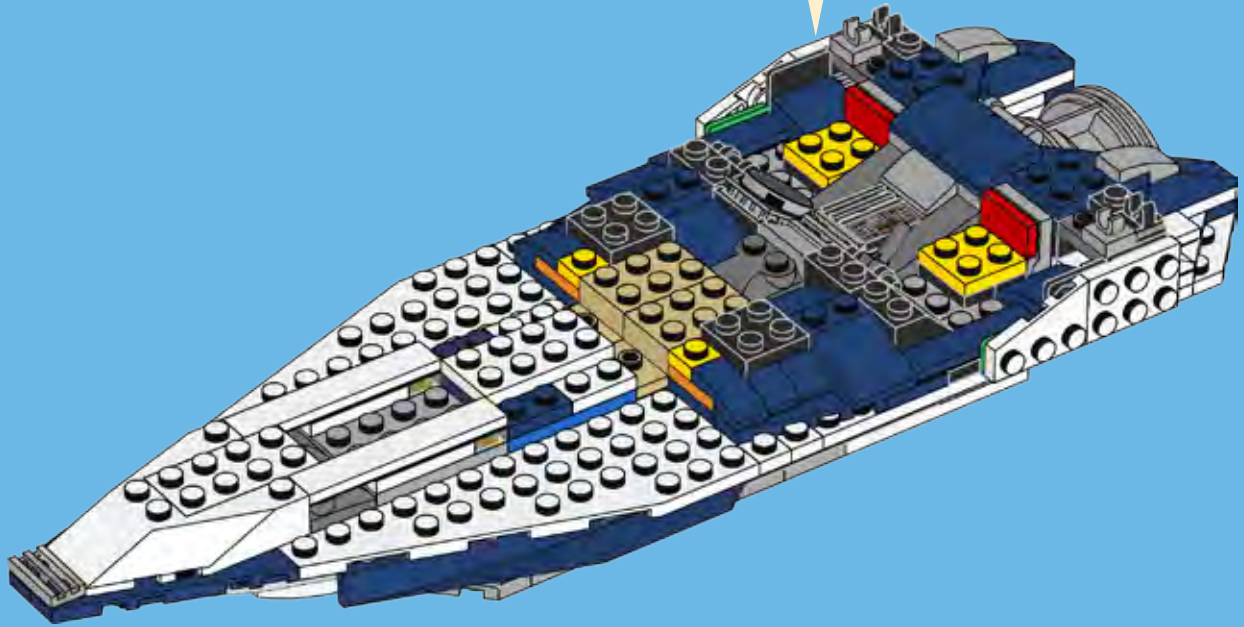

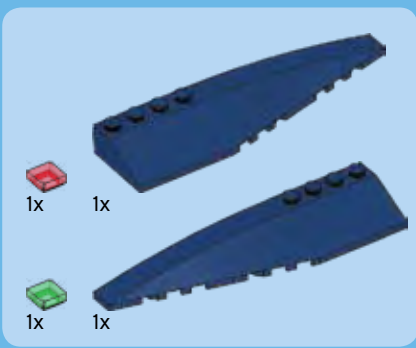

41

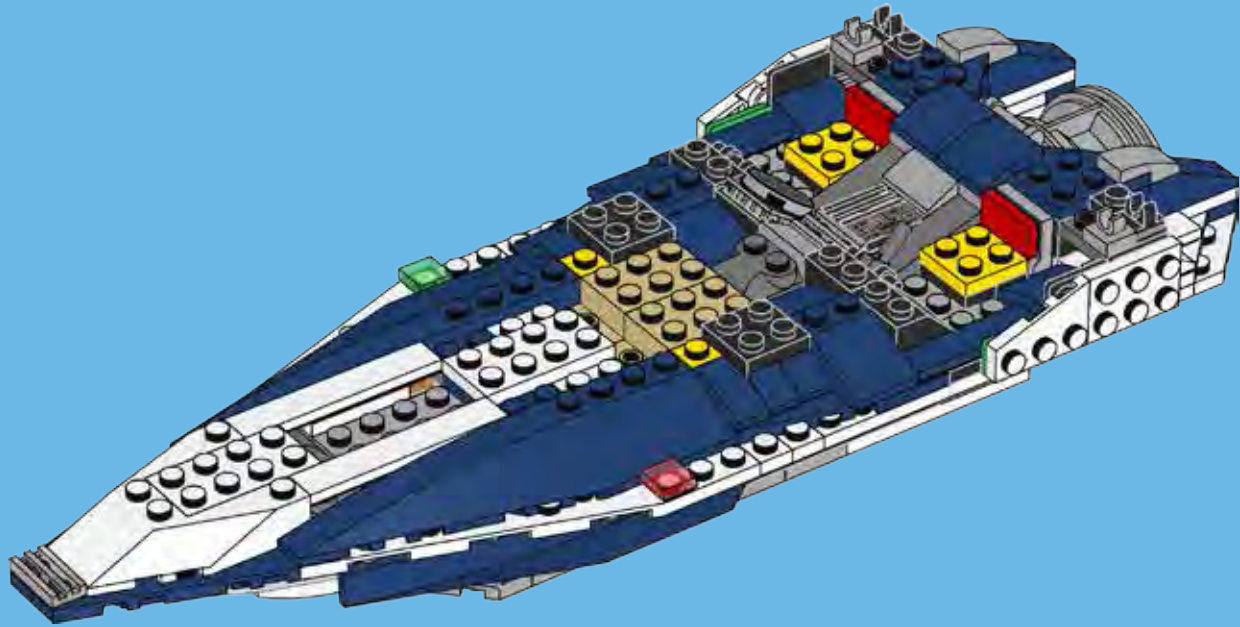

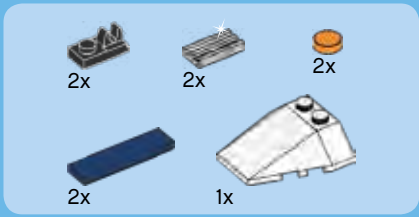

42

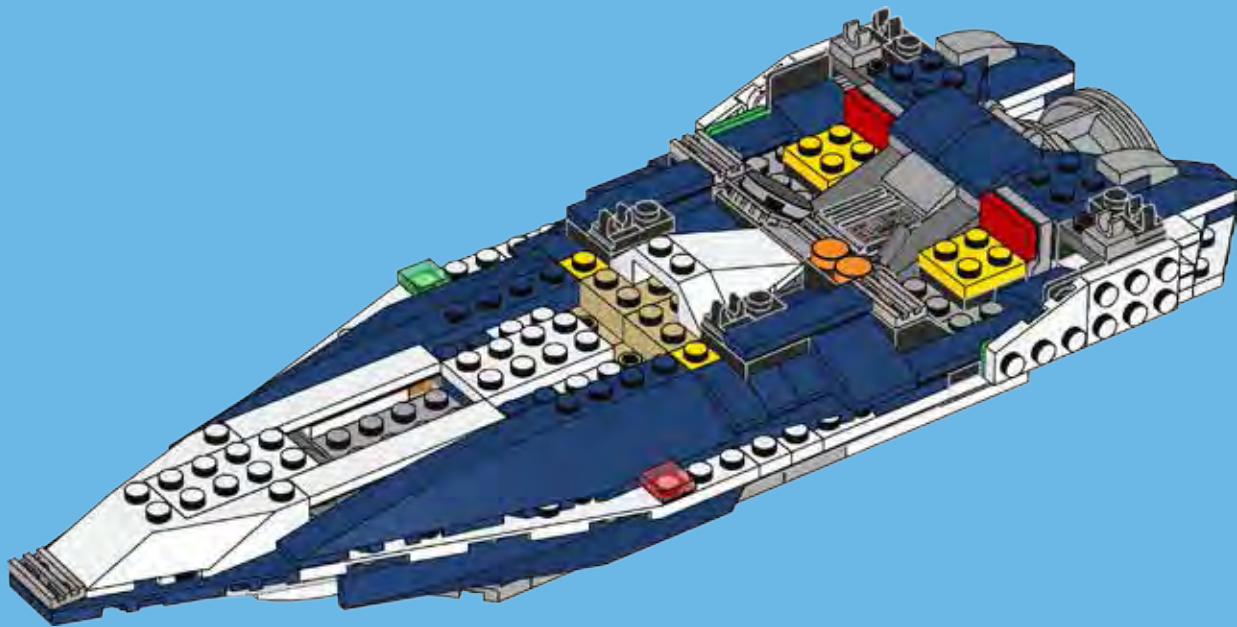

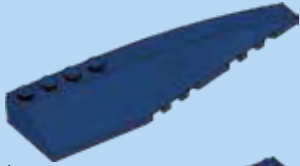

1x

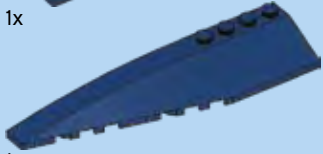

1x

43



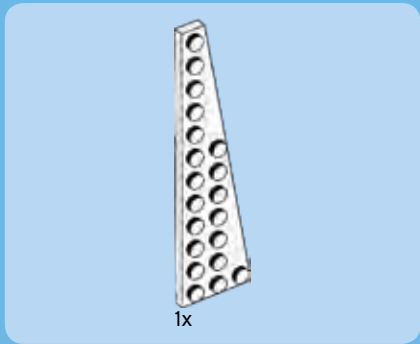

1x

1

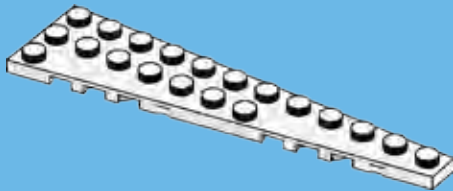

1x

2

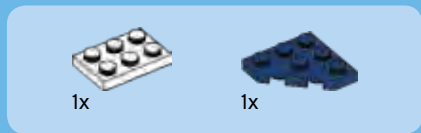
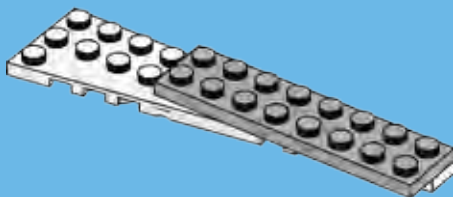

1x

1x

3

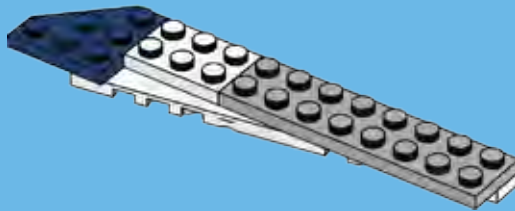

1x

4x

4

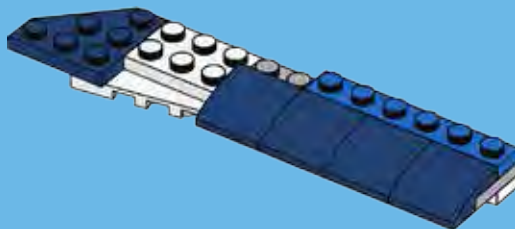



1x

5

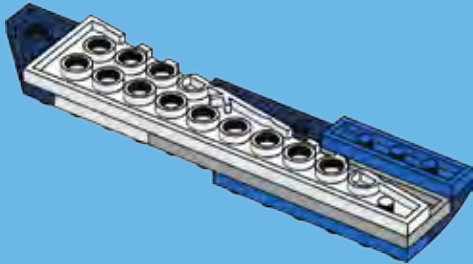

2x



1x

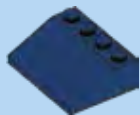

1x

6

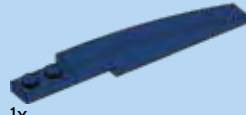
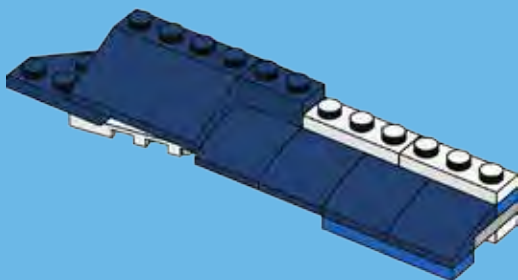

1x



1x

7

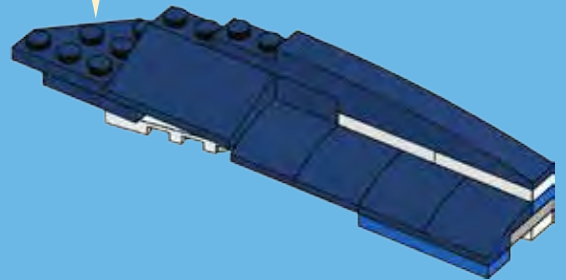

1x



1x

8

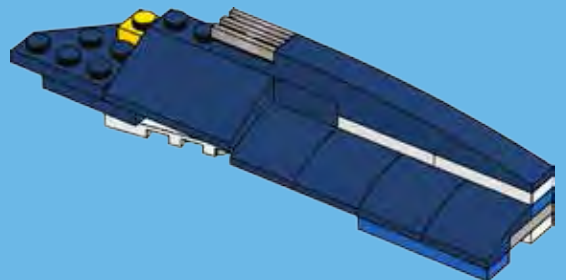



1x



1x

9

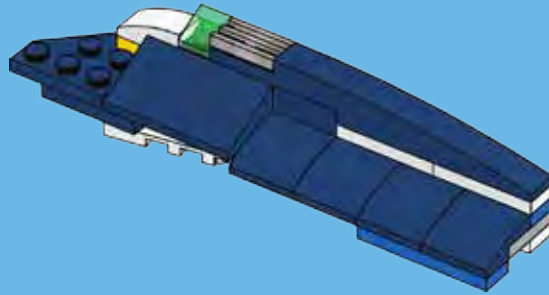

44

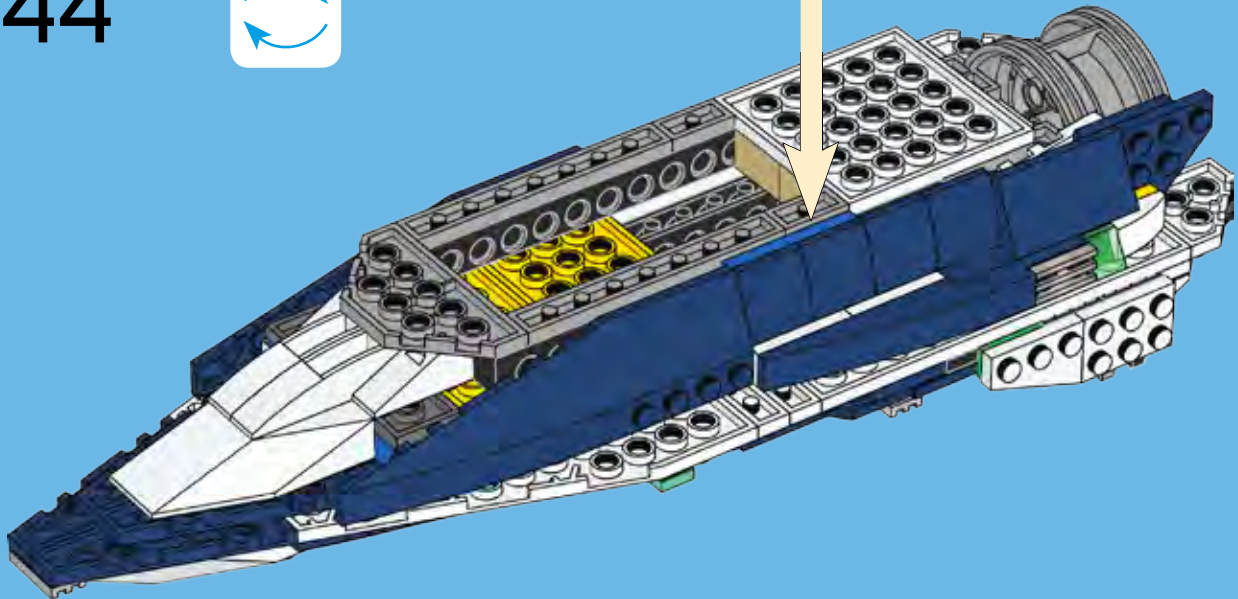



1x

1

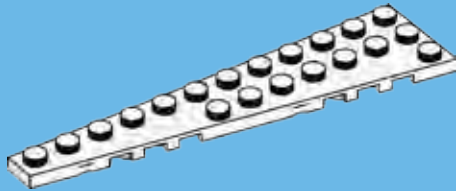

1x

2

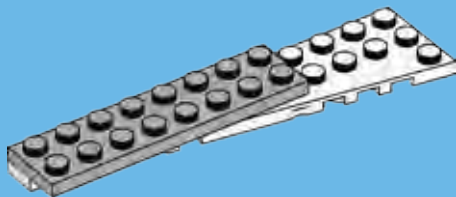

1x



1x

3

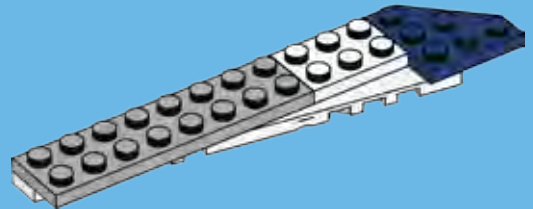

1x



4x

4

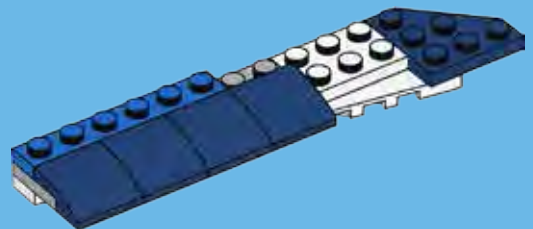



1x

5

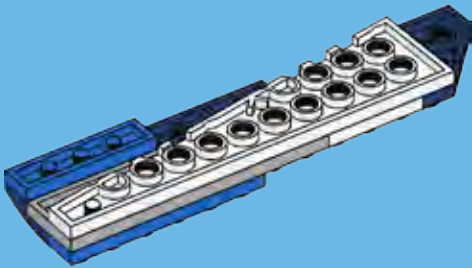

2x



1x

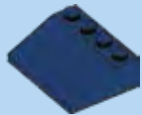

1x

6

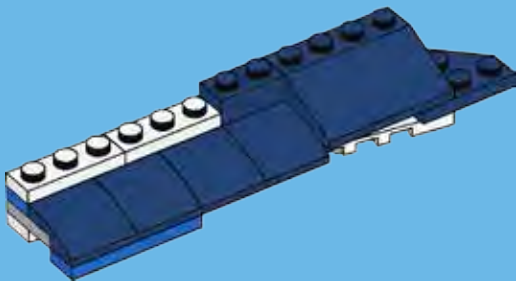

1x



1x

7

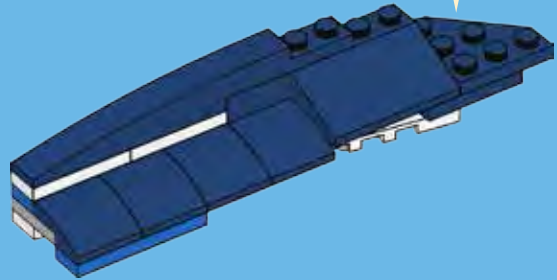
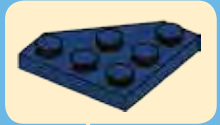

1x



1x

8

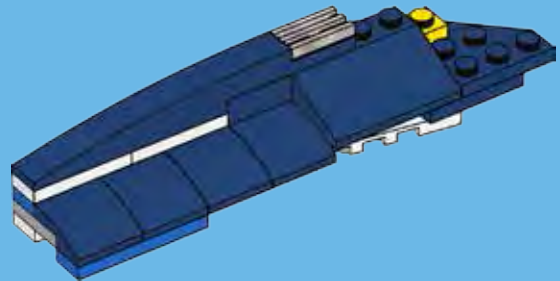



1x



1x

9

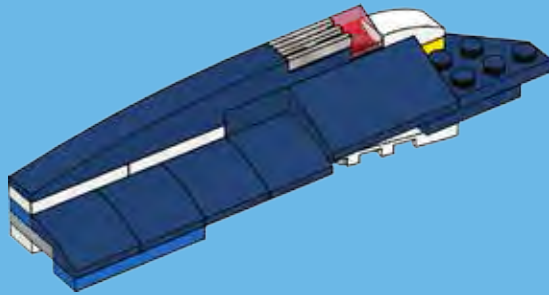

45

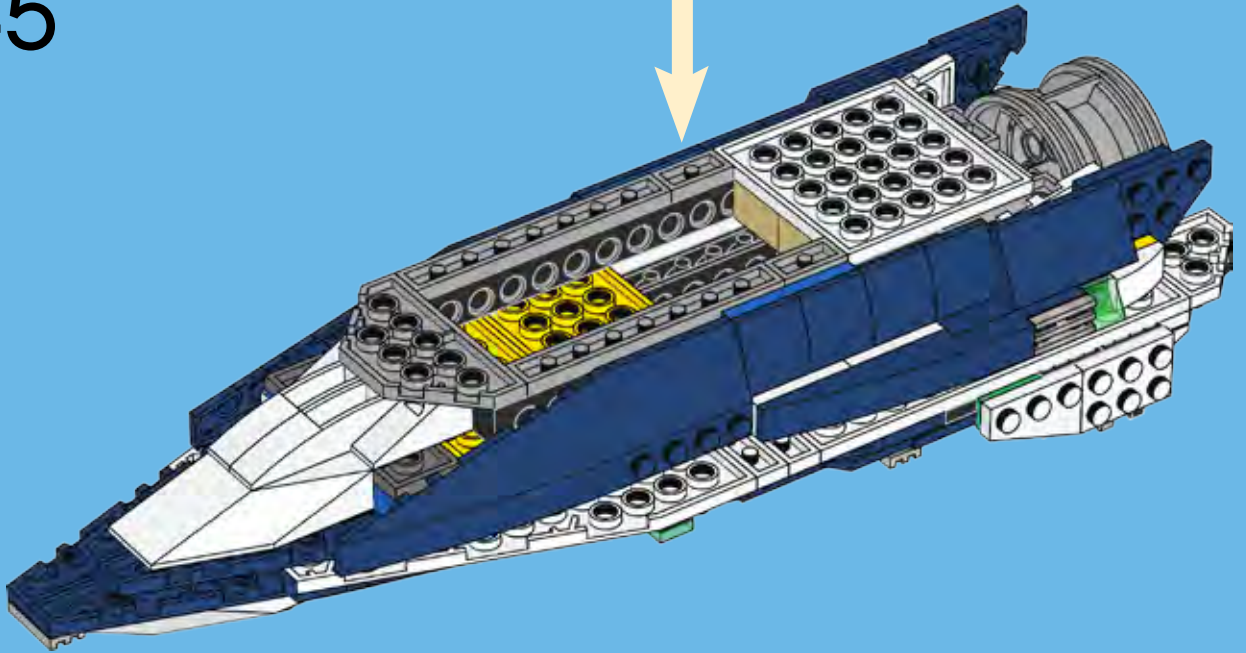

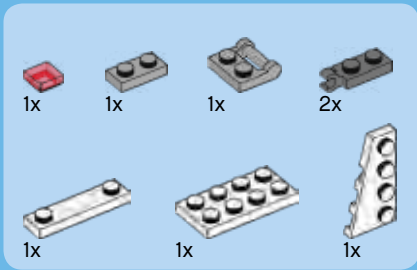

46

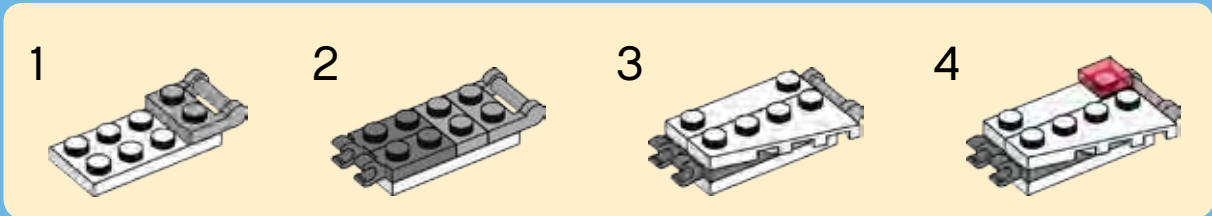

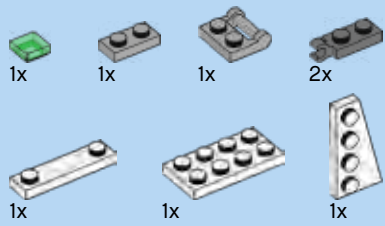

47

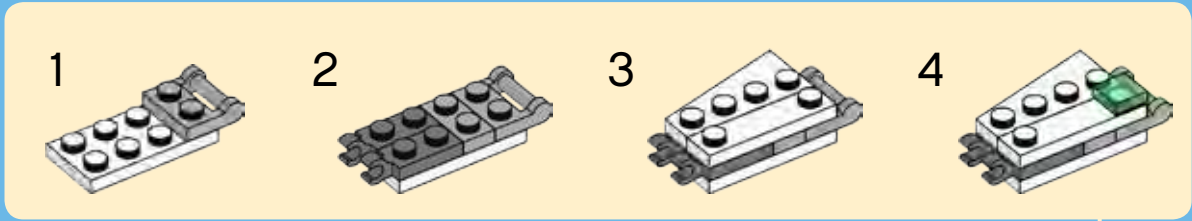



2x



2x



1x



2x

48

1

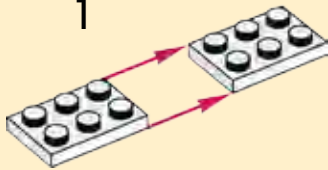

2



3

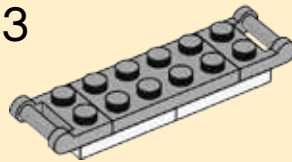

4

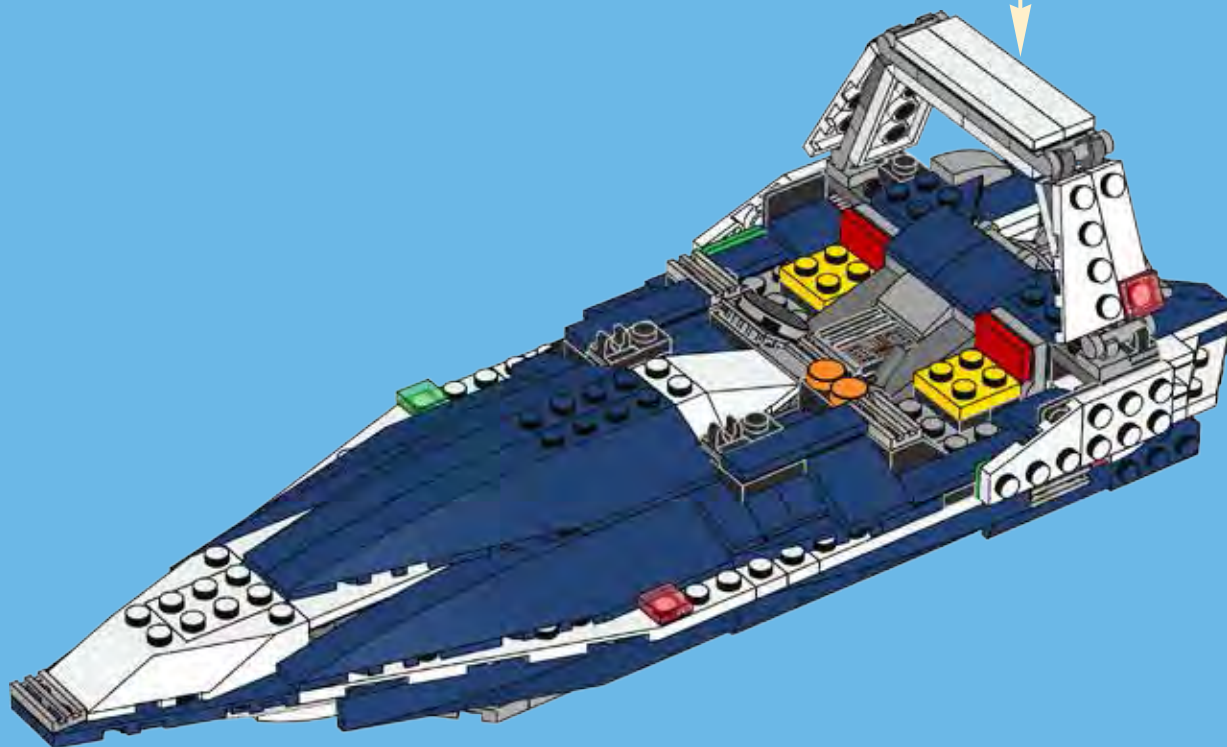
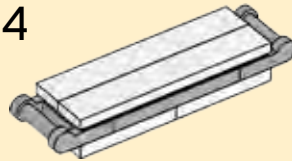



3x



1x

49

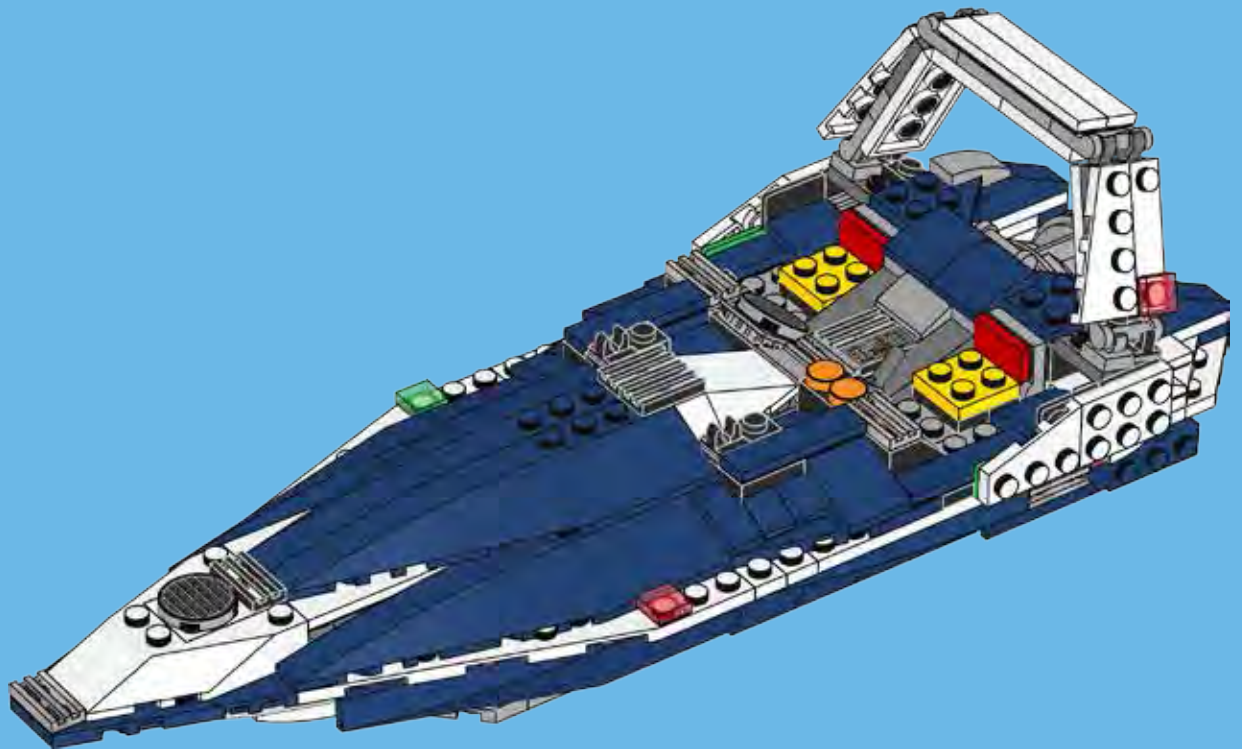



2x

50

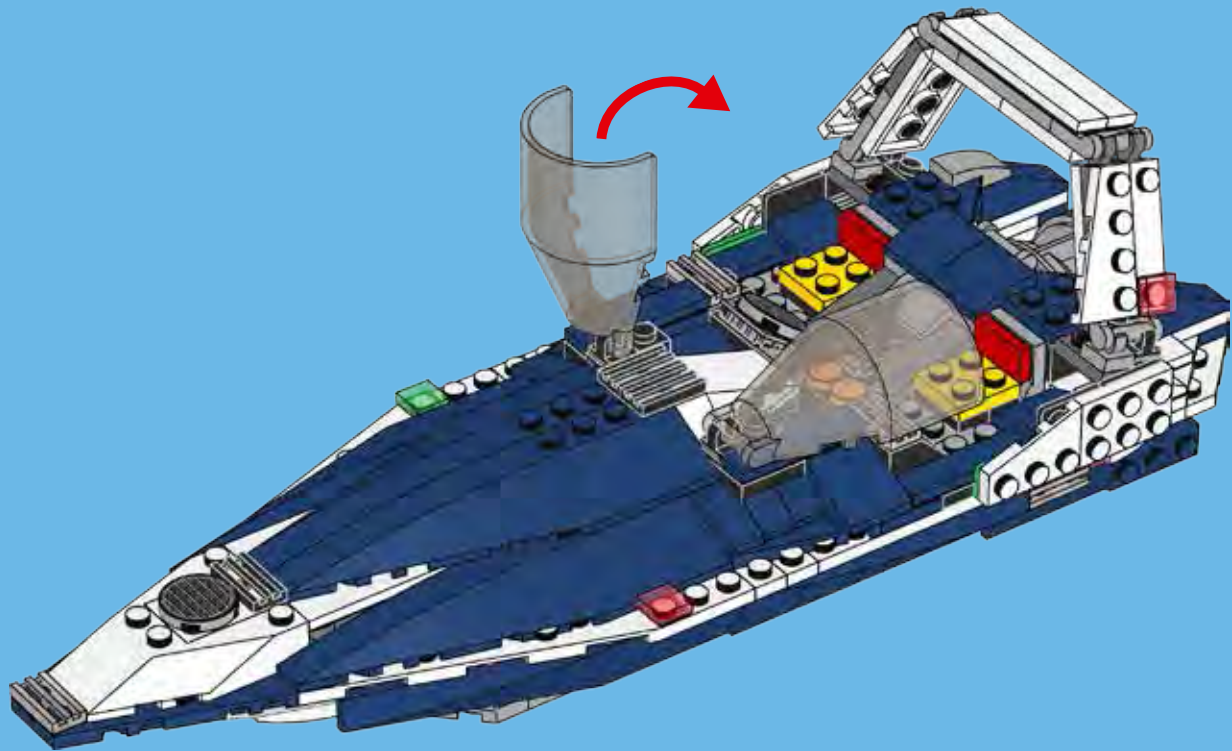

8x
300501



1x
300901



2x
370101



4x
4504369



4x
446001



2x
428701



1x
4264026



2x
6110054



1x
4567894



1x
6110031



2x
6034044



2x
4160403



10x
362301



16x
302101



2x
4597131



2x
243101



5x
302001



9x
366601



8x
663601



5x
303401



1x
4144012



6x
447701



1x
303501



1x
4160857



3x
4179874



3x
4179875



3x
4179875



3x
4179875



1x
4161326



2x
4208987



2x
4208987



2x
4208987



2x
4208987



2x
4208987



2x
4208987



2x
4209005



4x
245001



2x
4550745



2x
4141476



2x
4141475



2x
6107667



3x
4109995



8x
4159739



2x
4179771



6x
4516055



4x
6092587



2x
4666579



2x
4558886



1x
4513987



1x
4633914



4x
306921



6x
4113858



4x
6061711



1x
4180533



1x
4180504



3x
4142865



10x
407023



6x
242023



14x
371023



2x
366623



2x
4206482



2x
4514553



2x
4164073



4x
302424



9x
302224



2x
303224



2x
6102768



4x
300326



1x
4253815



2x
4288212



2x
370026



4x
4107558



1x
6083346



3x
6021512



6x
241226



4x
302326



4x
302126



4x
4598528



7x
6000650



2x
6016172



2x
4556158



4x
4114689



1x
4617848



2x
4541455



2x
4273590



2x
393726



3x
4173668



10x
4121715



2x
4107084

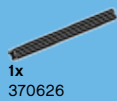

1x
370626



2x
6099243



2x
4244363



3x
3003941



2x
4244573



2x
4216384



14x
4177932



2x
6009459



1x
4654448



2x
4650628



2x
4255413



12x
4249891



4x
4264569



6x
6097429



2x
6103774



12x
4504374



4x
6025376



2x
6036241



2x
6094143



28x
6061569



2x
6110034



3x
6074661



3x
6074662



4x
4184108



4x
4631385



4x
4205004



8x
6103985



10x
4502089



6x
4667595



2x
4569836



6x
4507080



1x
4529954



1x
4502091



3x
6006628



3x
6006630



2x
4613335



8x
6110050



2x
4542673



1x
6110053



4x
4211353



4x
4211445



2x
4560183



5x
4211395



7x
4211425



6x
4211406



5x
6015344



2x
6028811



1x
4211752



2x
4568637



1x
4211570



6x
6028813



4x
4211398



2x
6071229



4x
6089147



13x
4244627



2x
4211572



2x
6052204



1x
4211352



2x
6061675



2x
6044729



2x
4211881



2x
4211741



2x
4211566



1x
4634091



10x
4619636



2x
4211573



1x
4211758



2x
4211807



2x
4211815



4x
4535930



2x
4539429



3x
4211002



2x
6039479



2x
6117972



8x
4581225



2x
6047417



1x
4595710



2x
4210967



3x
4218696



1x
4289542



2x
4210686



2x
4210749



1x
4508553



10x
4619636



Customer Service
Kundenservice
Service Consommateurs
Servicio Al Consumidor
LEGO.com/service or dial

00800 5346 5555 :     

1-800-422-5346 :  



CREATOR



10220



10242



CREATOR



LEGO.com/creator





CREATOR



31035



31036



31038



WIN

GO TO WWW.LEGO.COM/PRODUCTFEEDBACK
AND GIVE US YOUR SHORT **FEEDBACK**
ABOUT THIS LEGO® SET FOR A CHANCE
TO WIN A COOL LEGO PRIZE.



LEGO.com/productfeedback

GEWINNE



Erzähle uns auf
www.LEGO.com/productfeedback

etwas über die Erfahrungen, die du
mit diesem LEGO® Set gemacht hast,
und sichere dir die Chance auf einen
coolen LEGO Preis!

GAGNE



Rends-toi sur
www.LEGO.com/productfeedback

et donne-nous quelques commen-
taires sur ce produit LEGO® pour avoir
une chance de gagner un prix LEGO !

GANAN



Visita
www.LEGO.com/productfeedback

y envíanos tu opinión acerca de este
set LEGO®. ¡Participarás en el sorteo
de un premio LEGO!

获取奖品



登录
www.LEGO.com/productfeedback

给出关于此乐高®套装的简短反馈，
就有机会获得炫酷乐高奖品

경품 당첨 기회



www.LEGO.com/productfeedback

페이지로 이동하여 이 레고® 세트에
대한 간략한 피드백을 보내 주시고
멋진 레고 경품을 탈 수 있는 기회도
잡으십시오

ЗАПОЛНИ АНКЕТУ И ПОЛУЧИ ПРИЗ



Перейди по ссылке
www.LEGO.com/productfeedback

ответь всего на несколько вопро-
сов об этом наборе LEGO®, и у тебя
появится шанс выиграть замеча-
тельный приз от компании LEGO.