



# Friends



3185





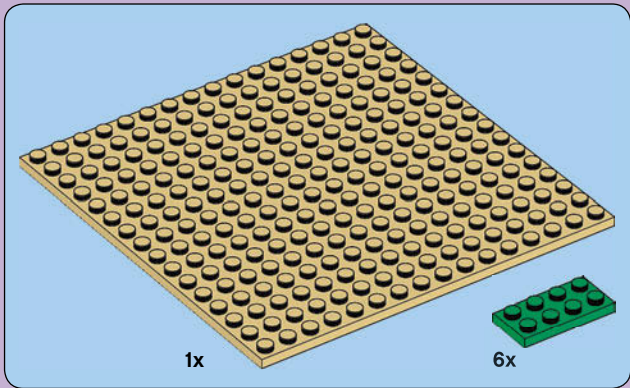
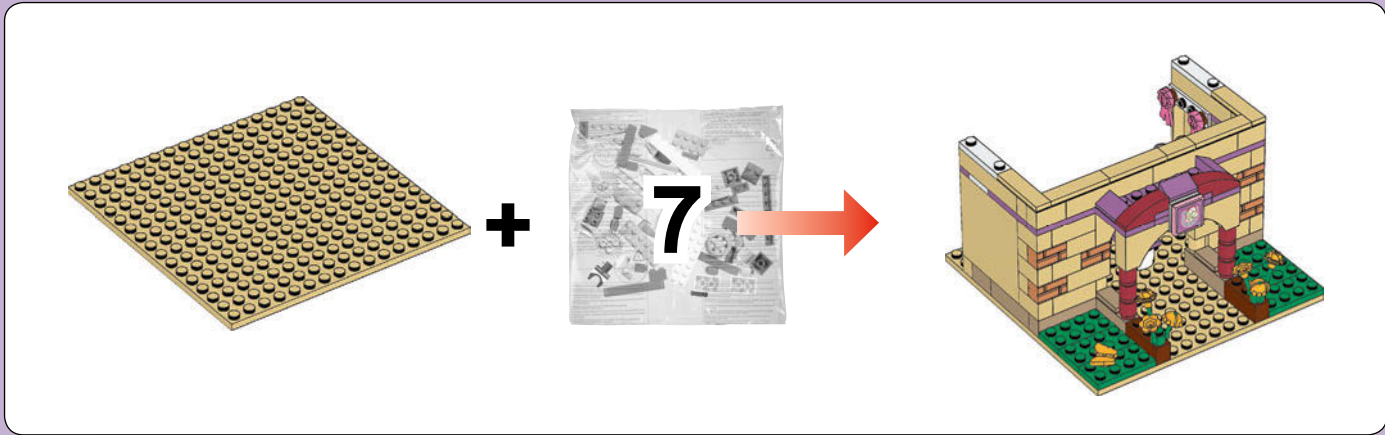

1

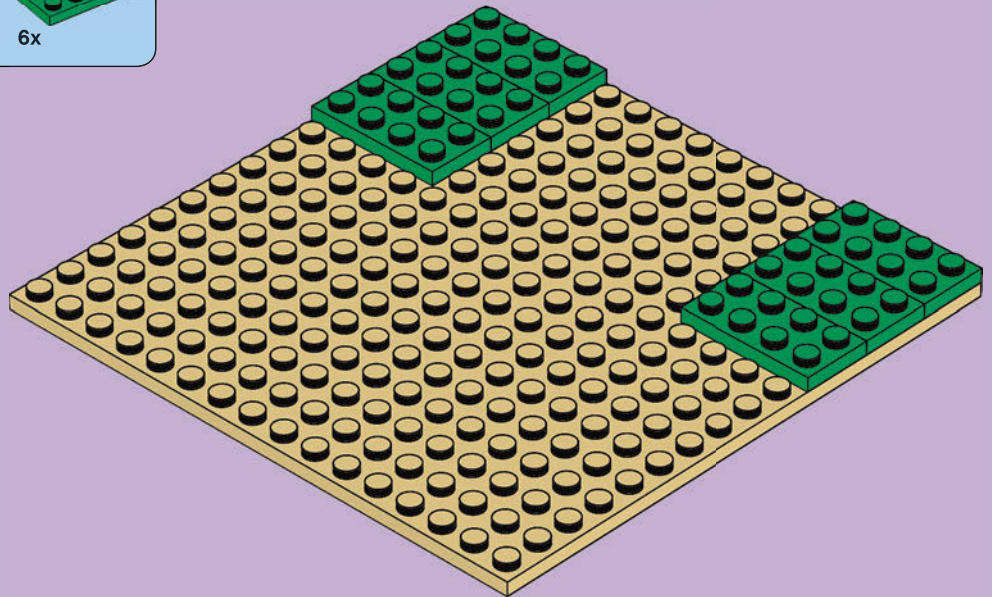

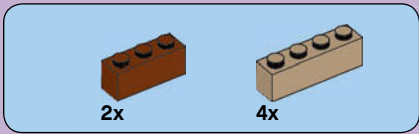

2



3



2x  6x 

4

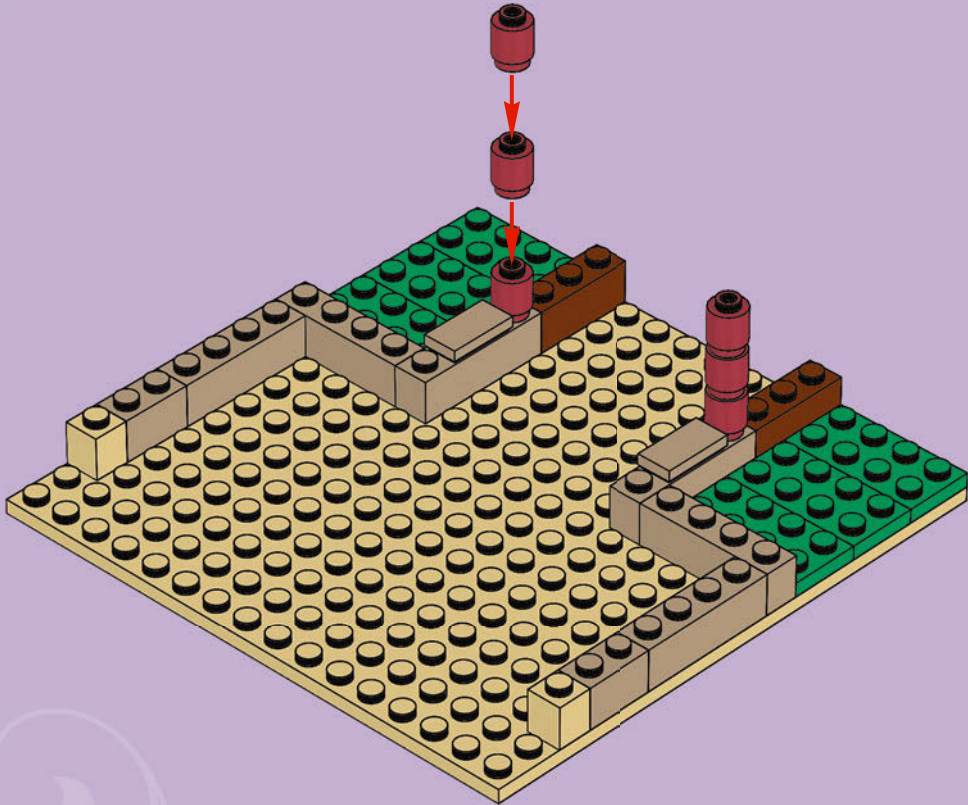





5

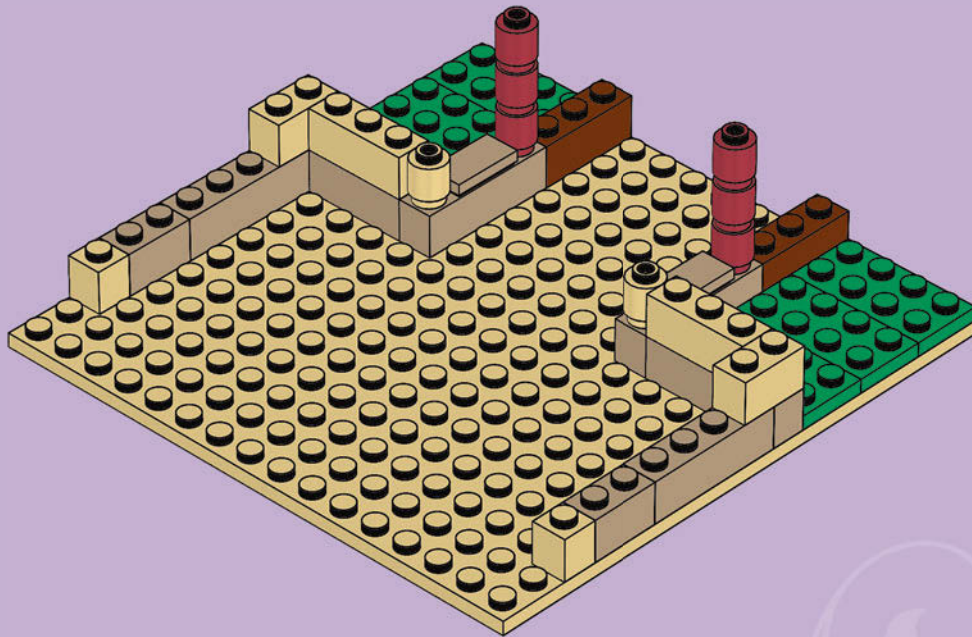



2x



2x



2x

# 6

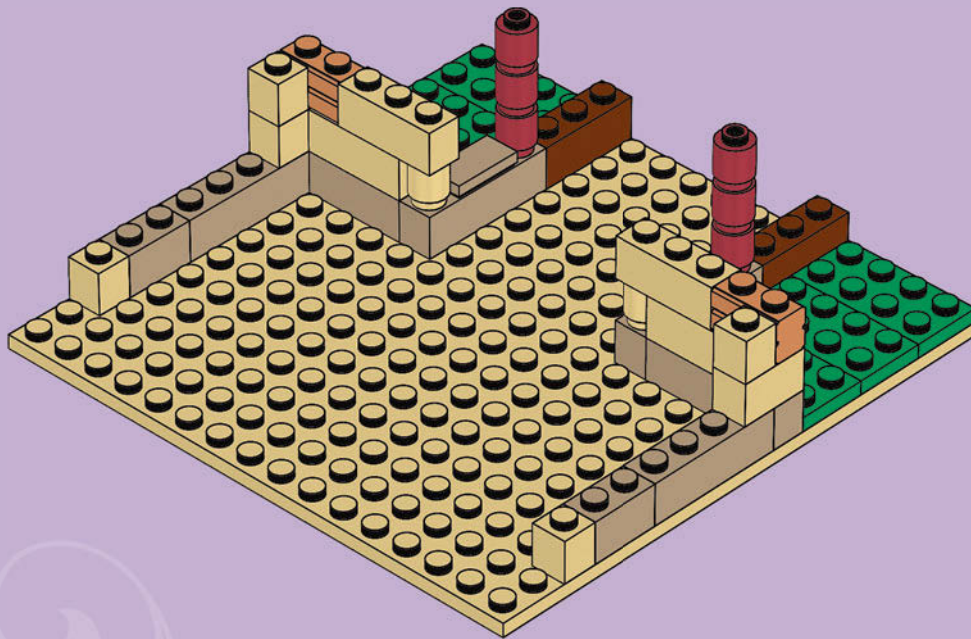



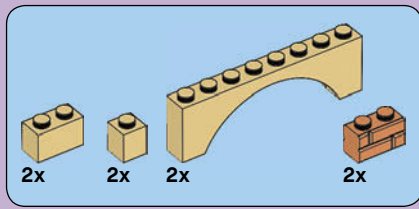

8

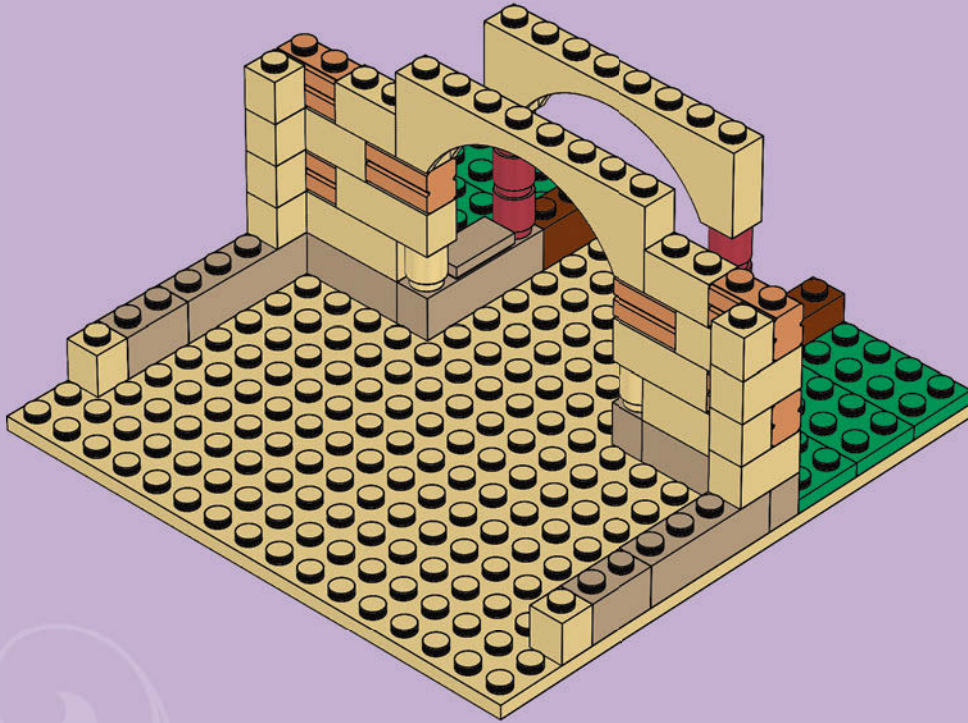





4x

9



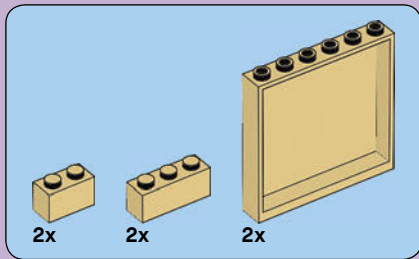

10

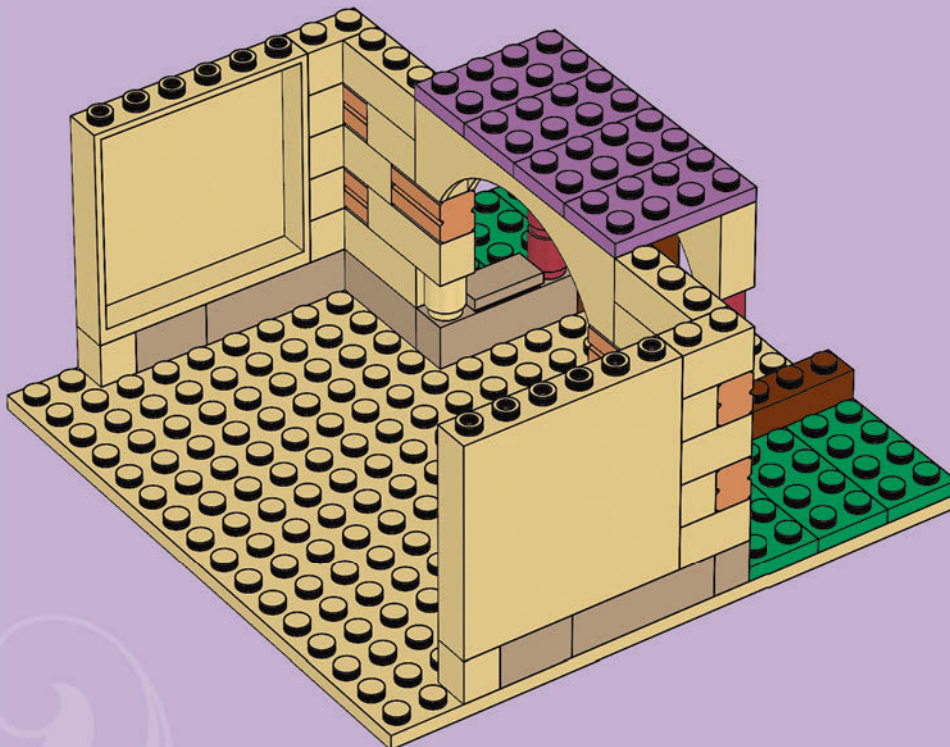

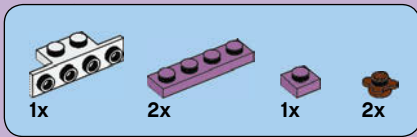

# 11

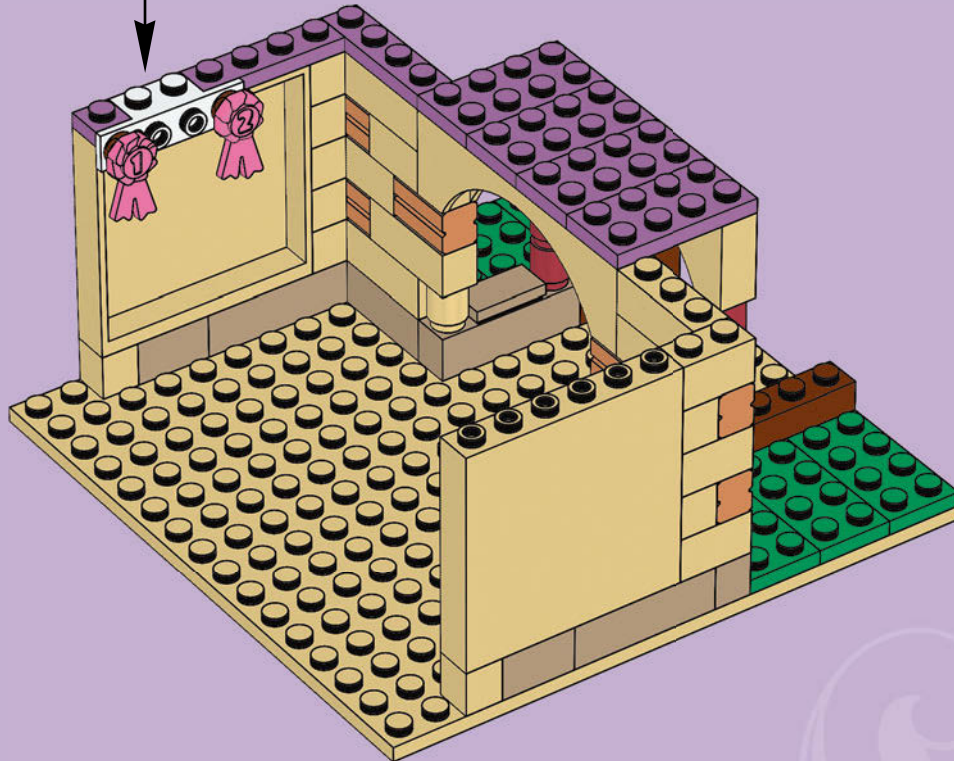
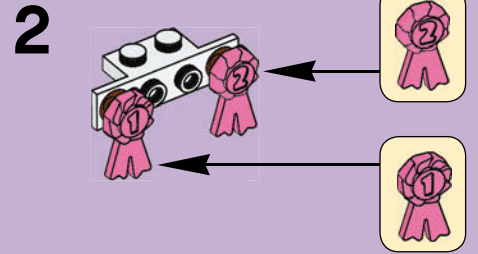
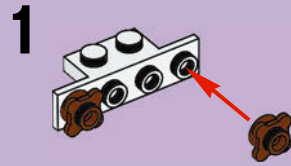



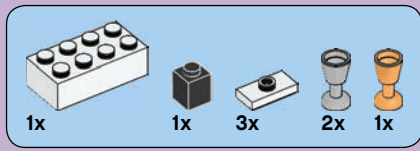

12

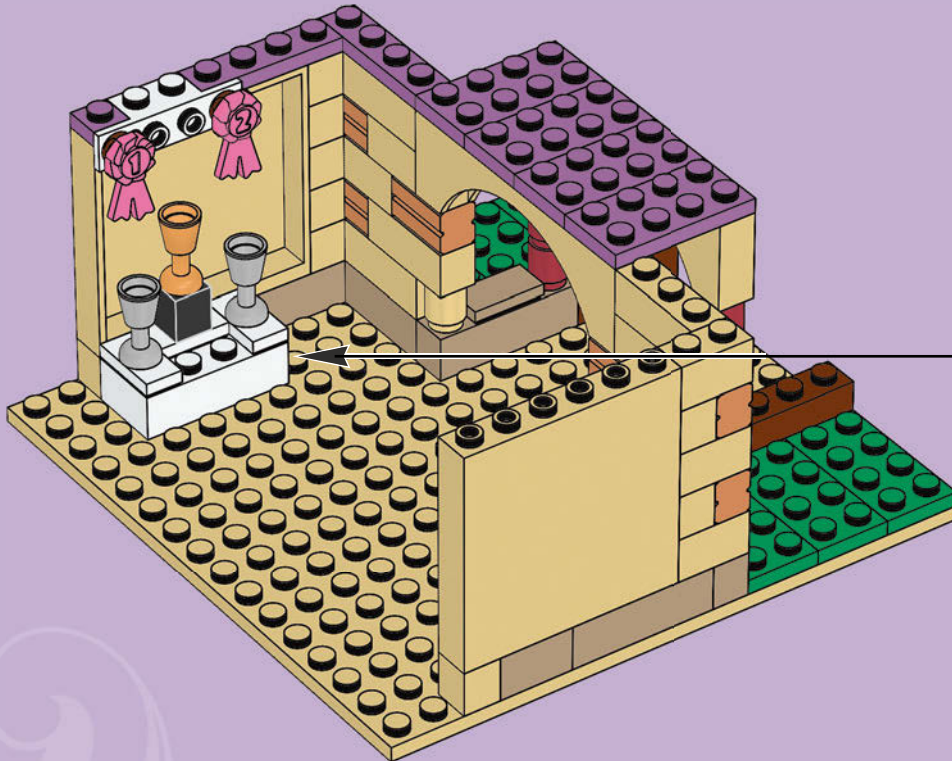
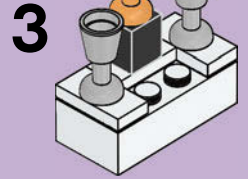
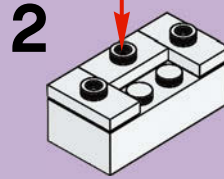
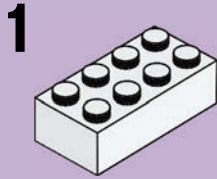

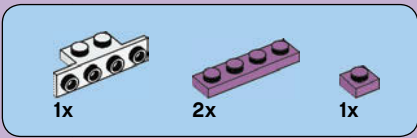

# 13

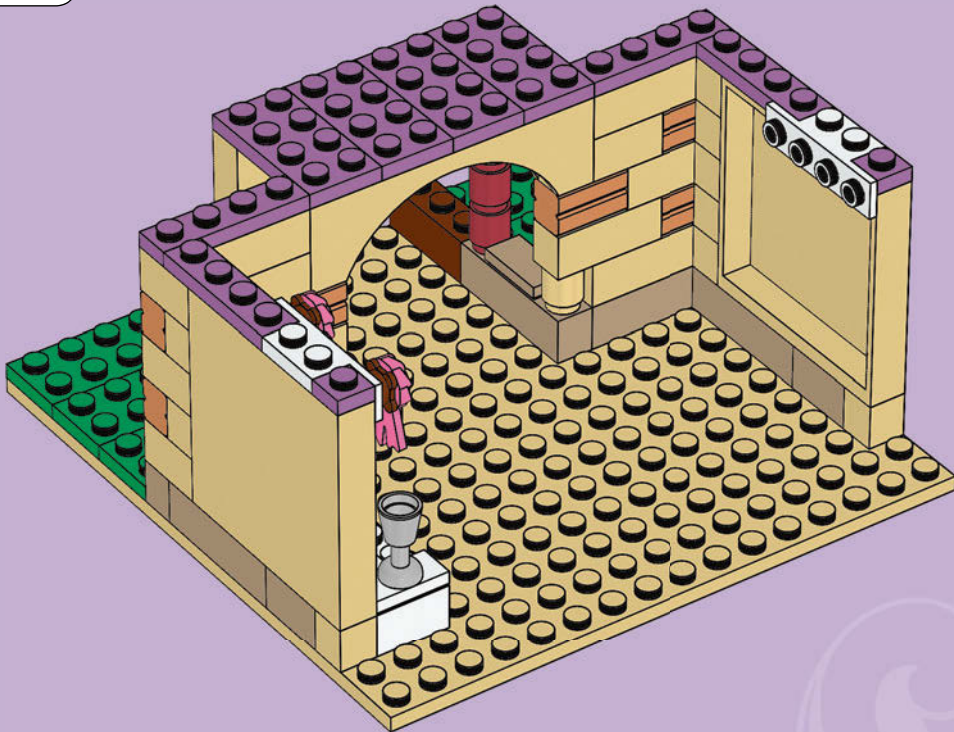

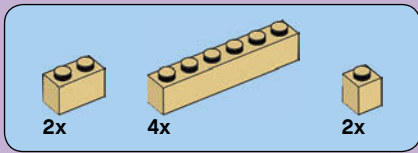

14

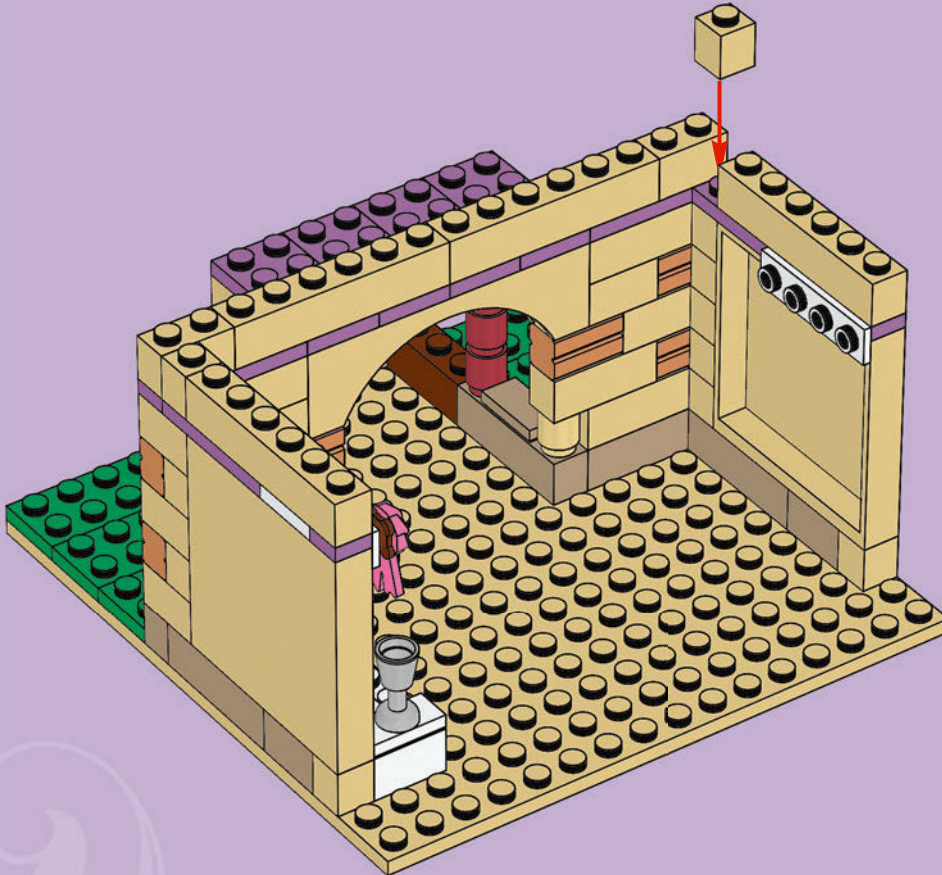



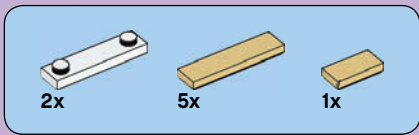

# 15

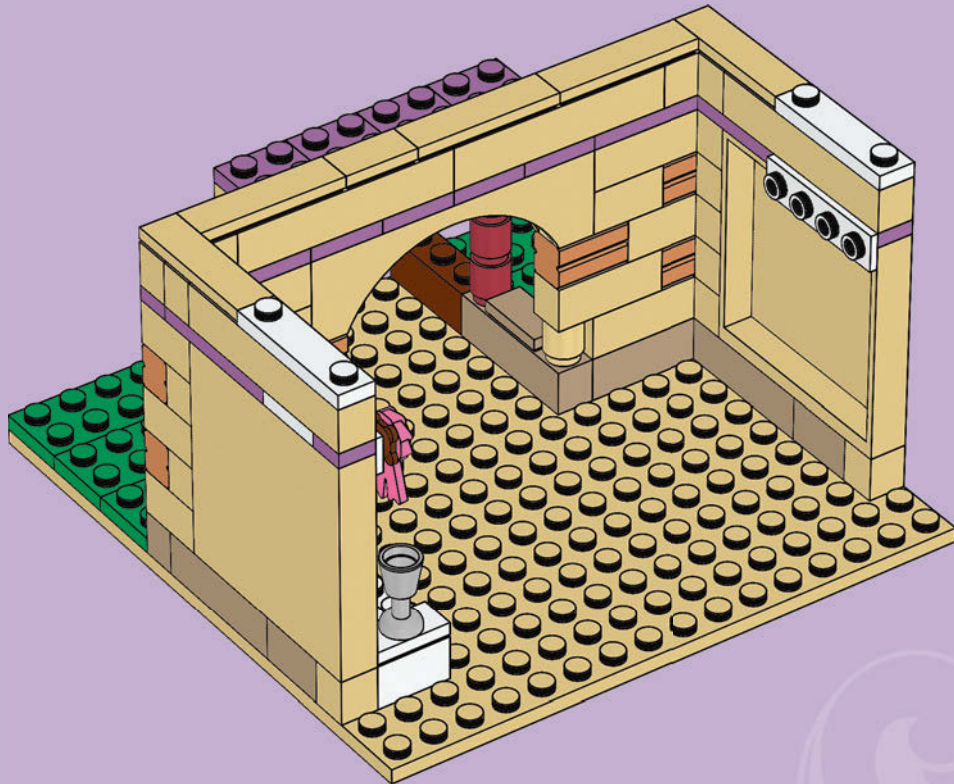

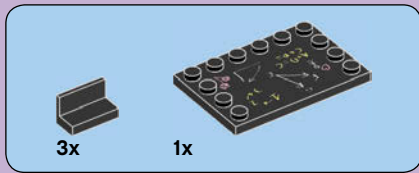

16

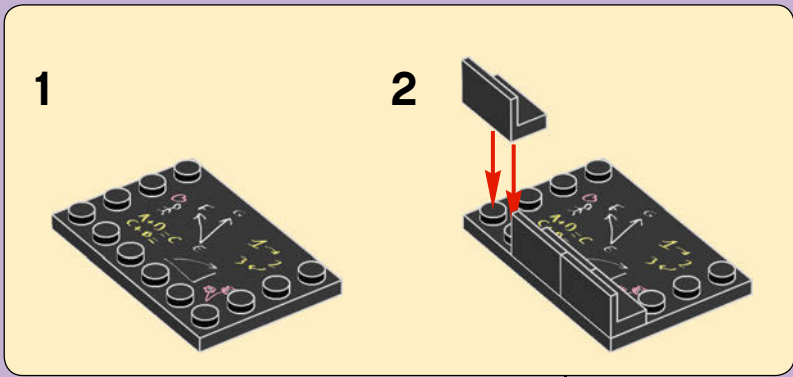

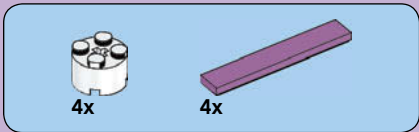

17

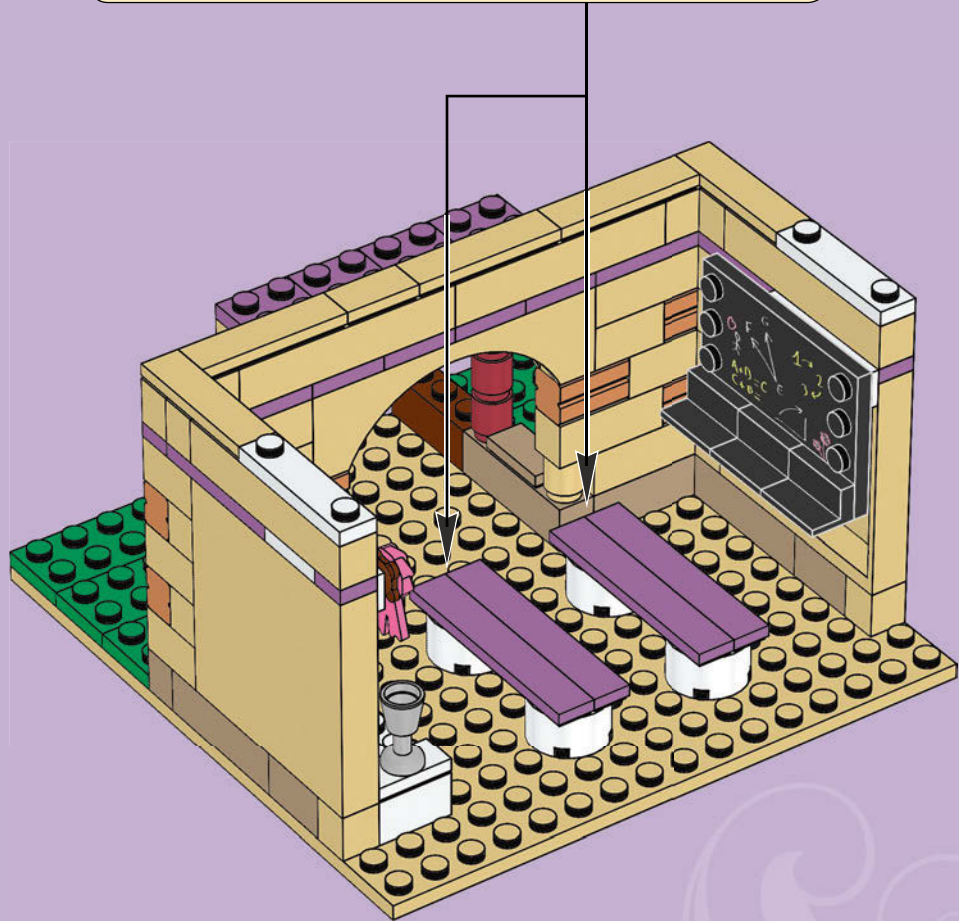
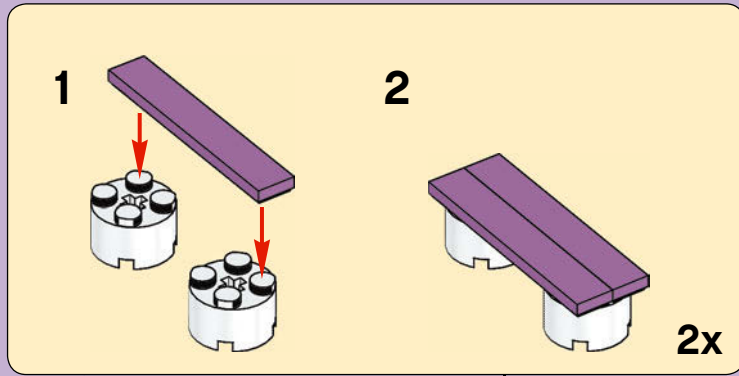



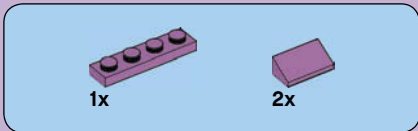

# 18

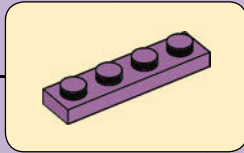
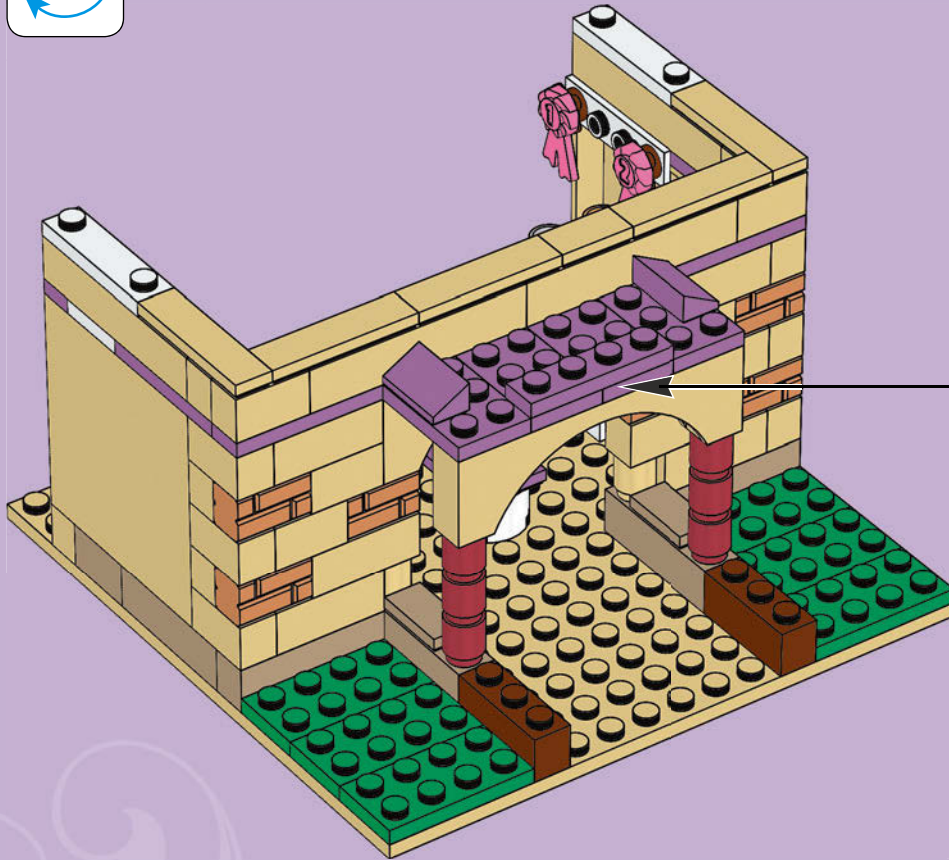

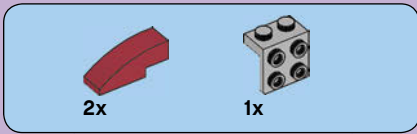

# 19

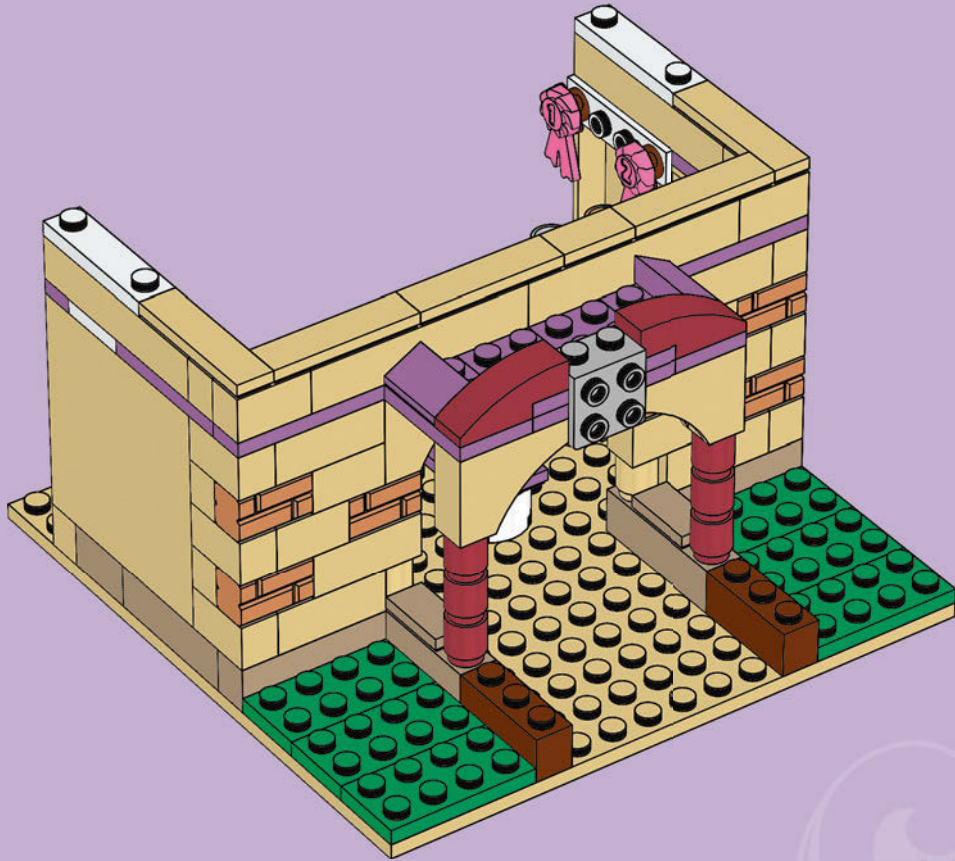



1x



1x

# 20

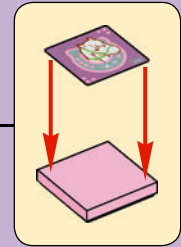
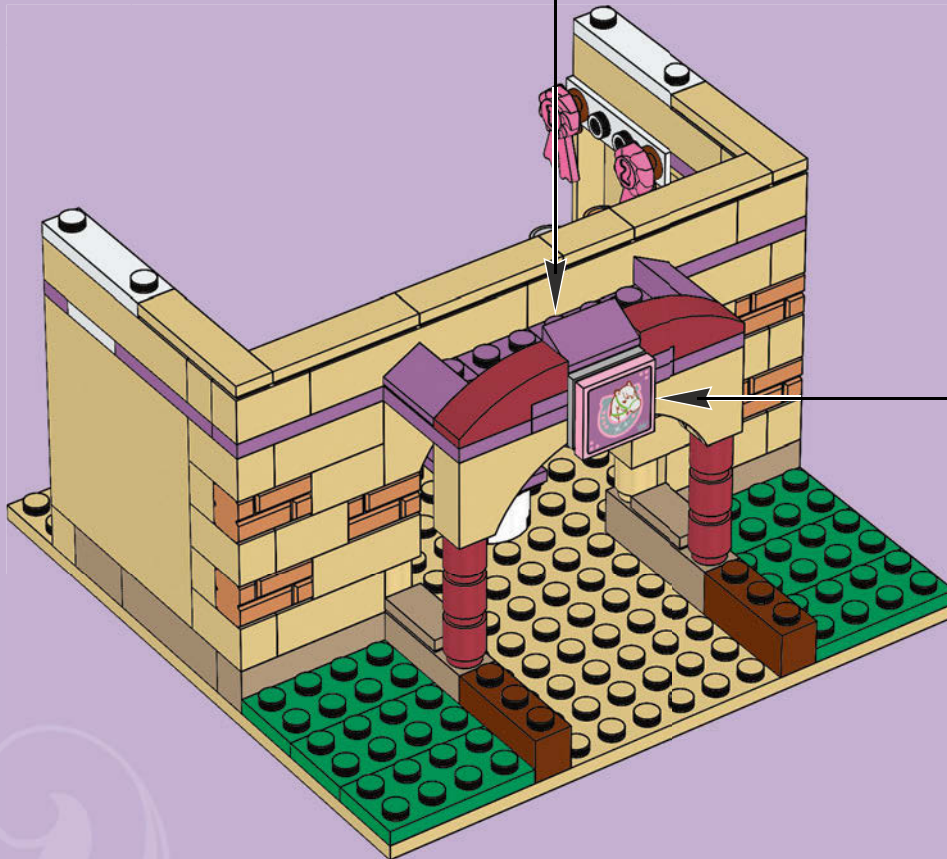





2x

# 21

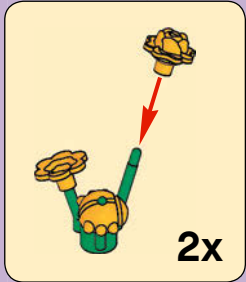

2x



22

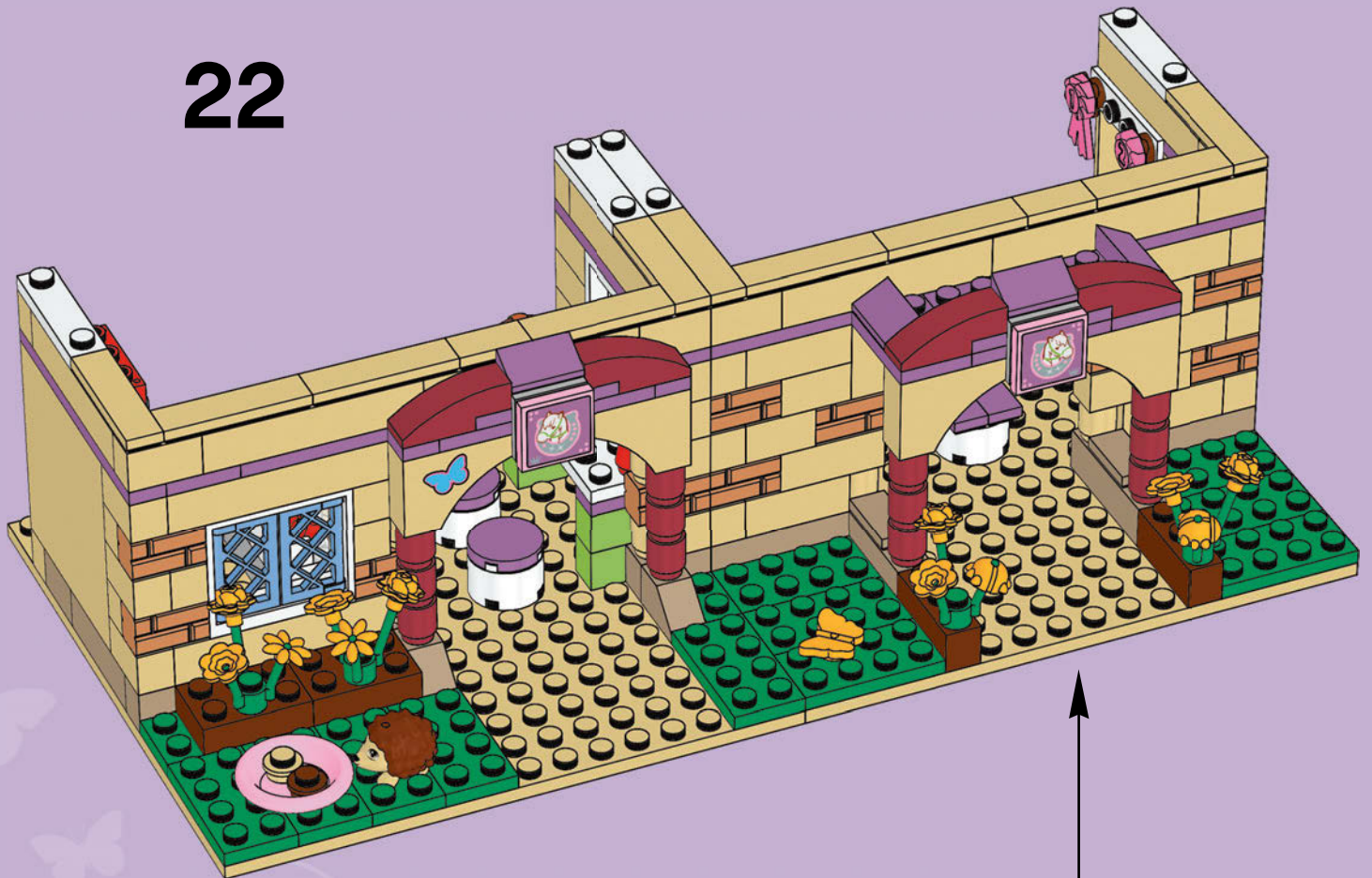

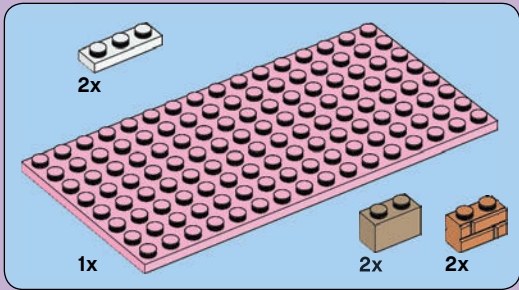
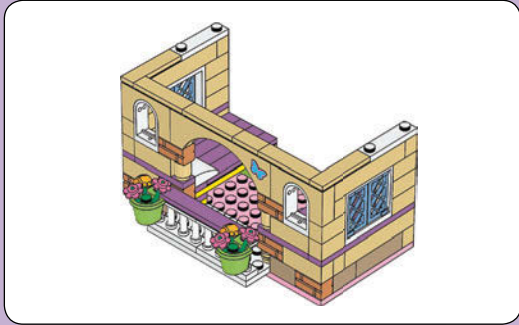
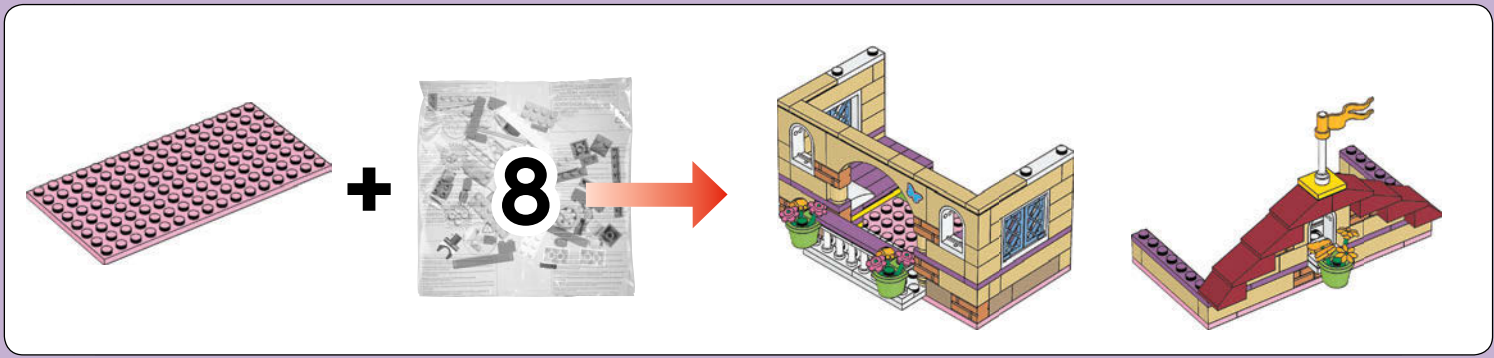

1

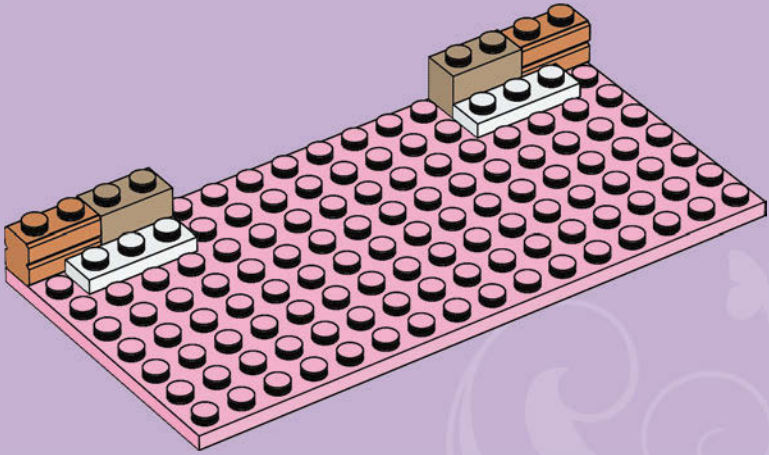



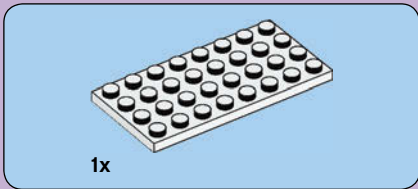

2

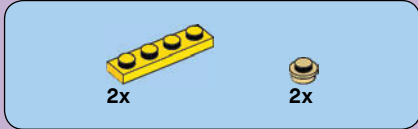
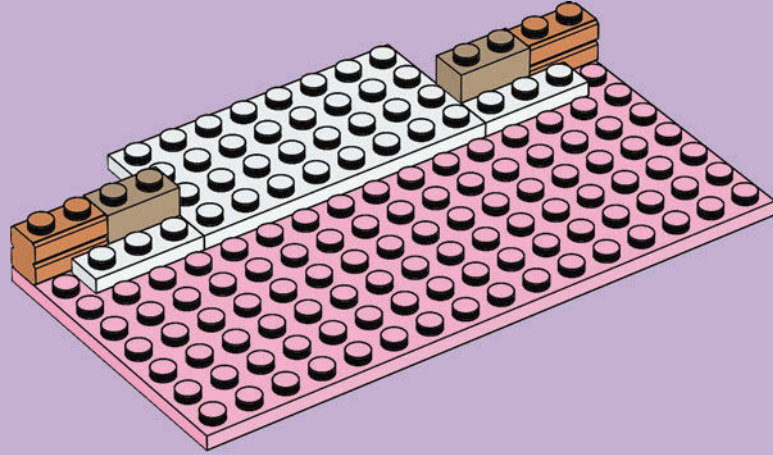

3

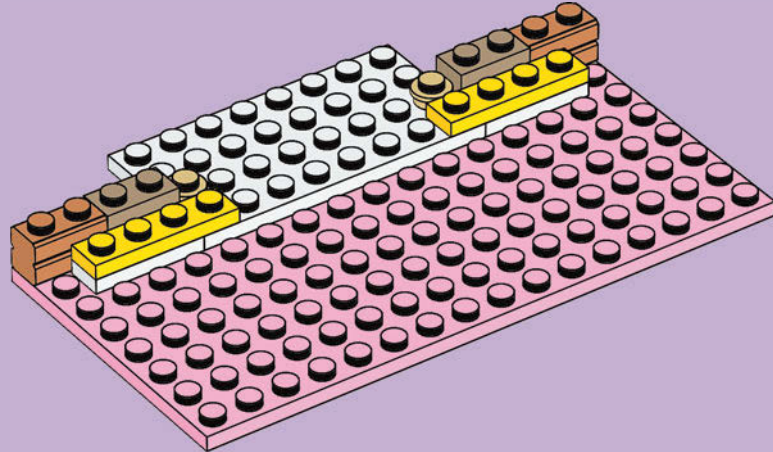



2x



2x

4

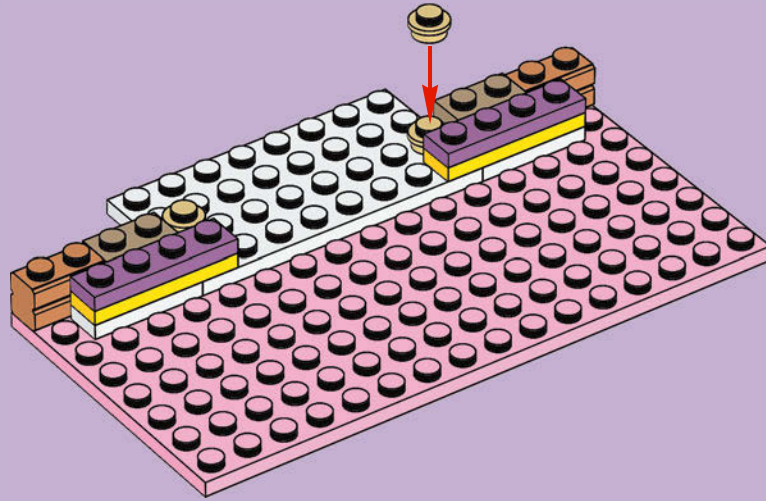

2x



2x



2x

5

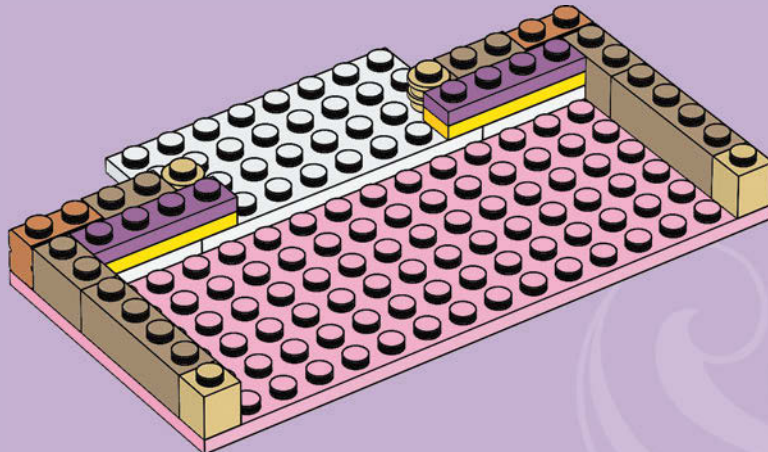

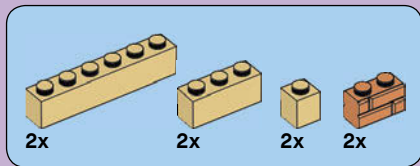

6

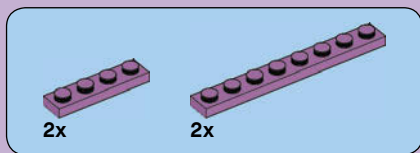
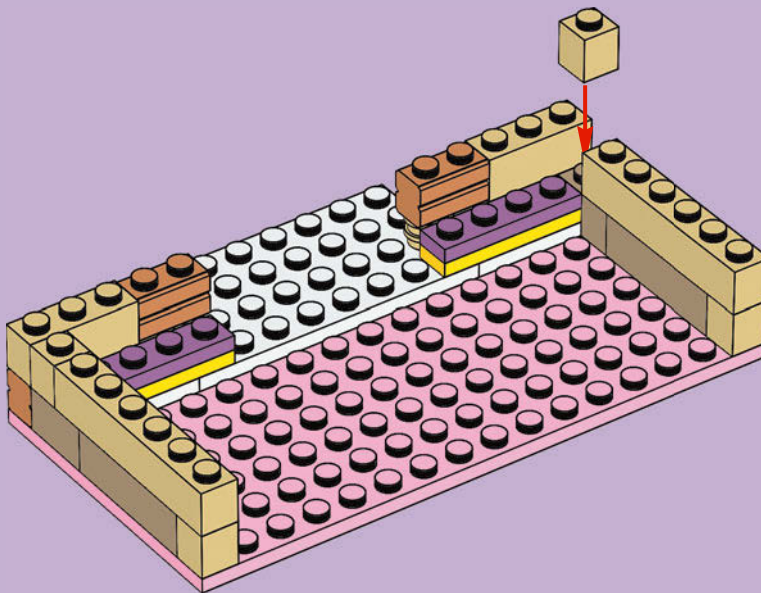

7

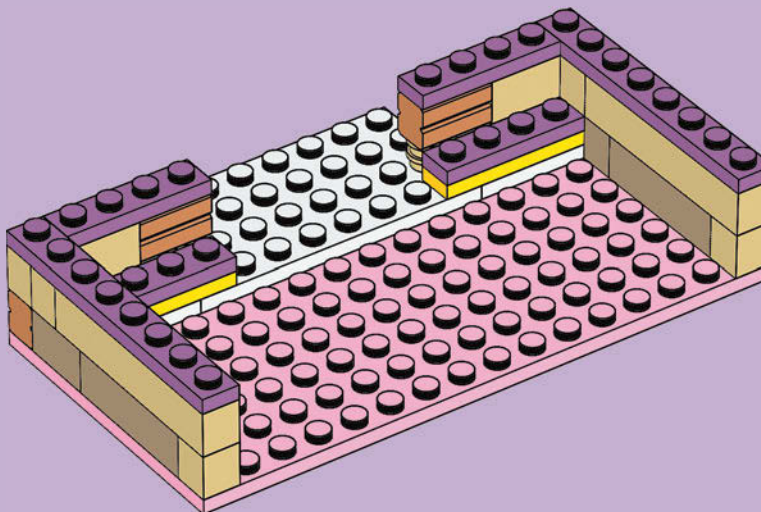





8

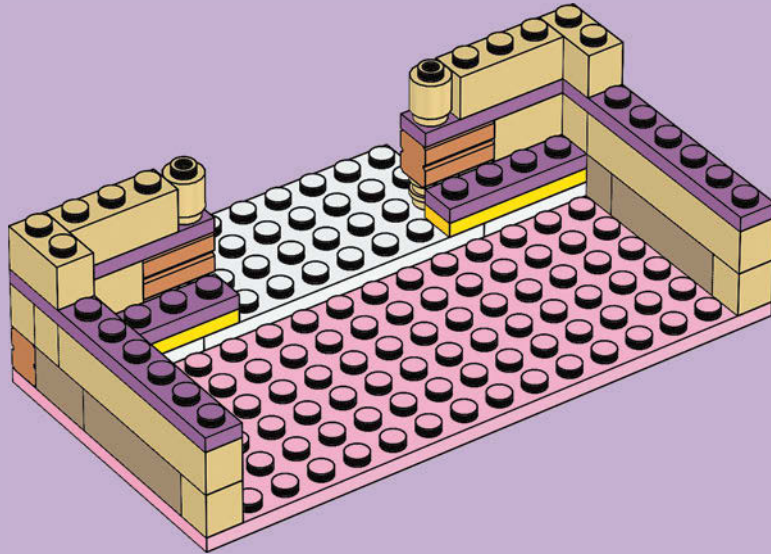



9

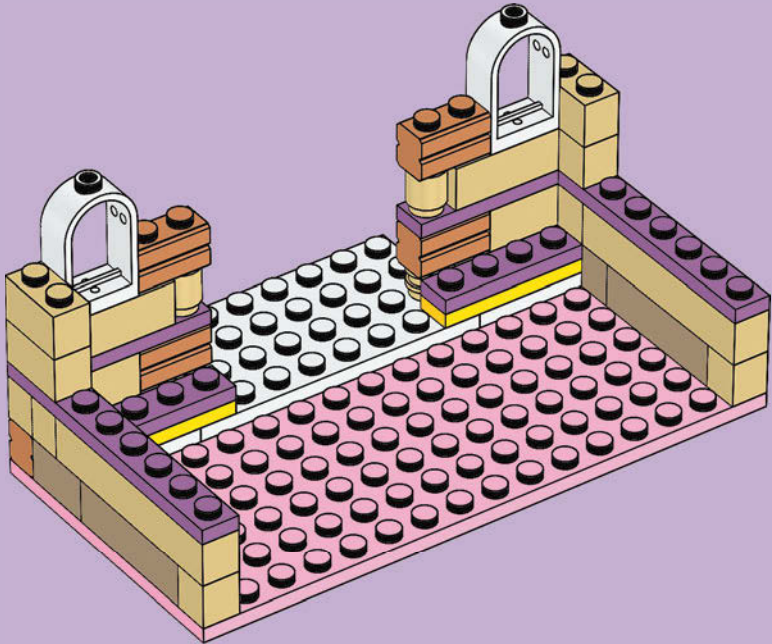

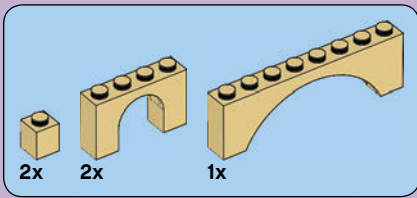

# 10

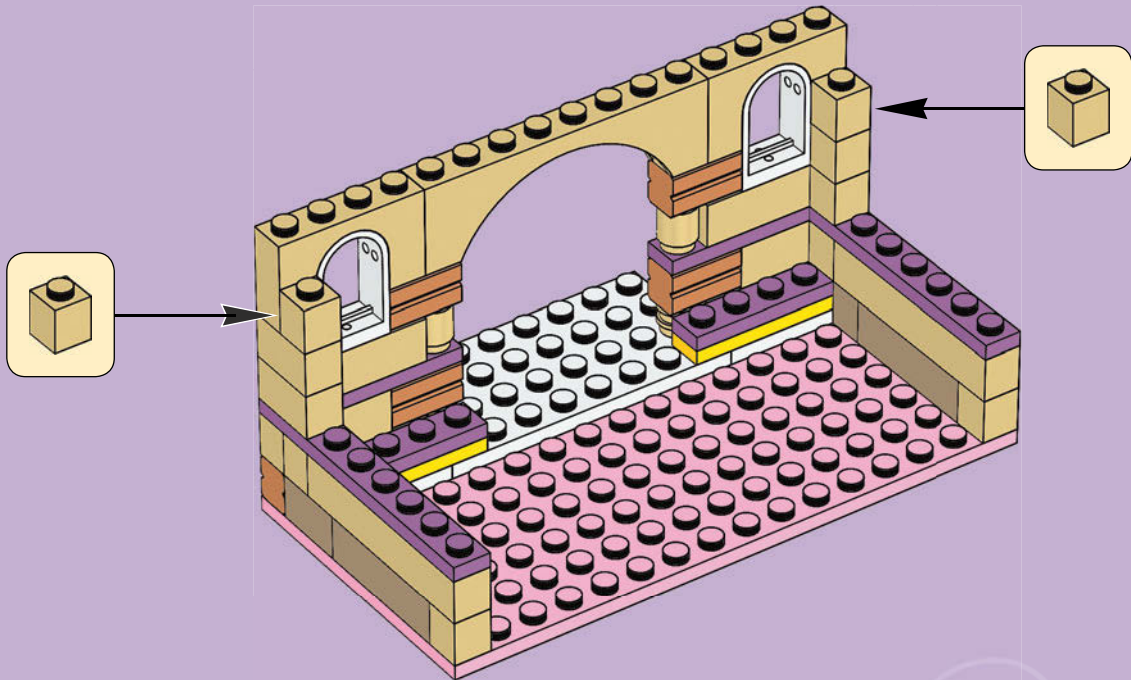



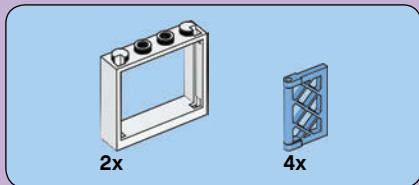

11

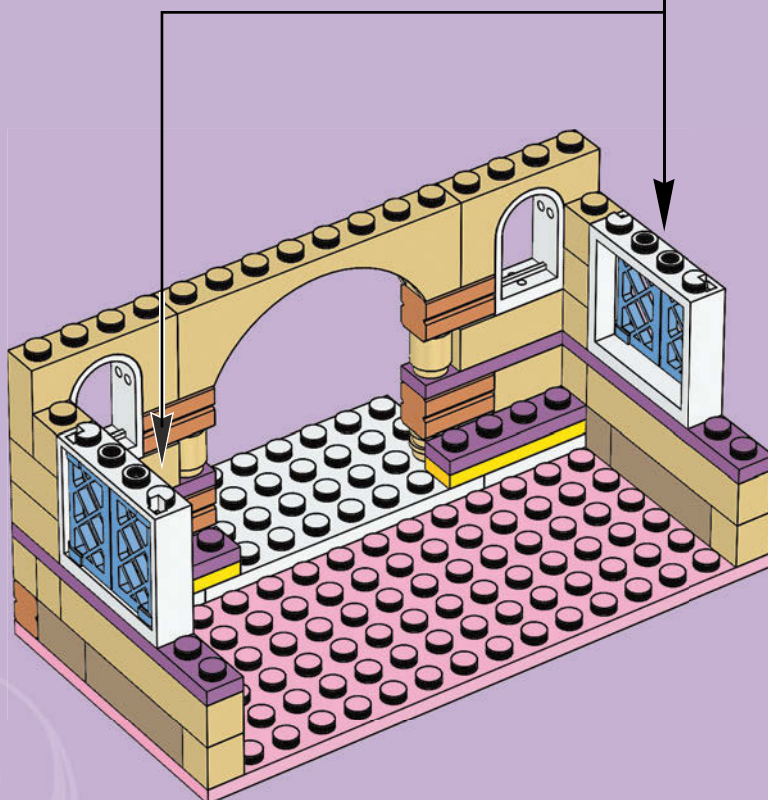
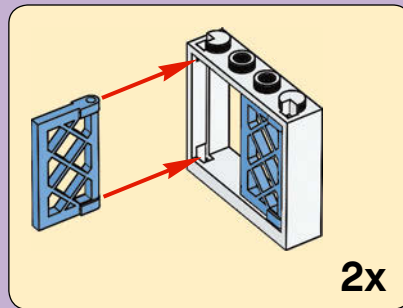



6x

# 12

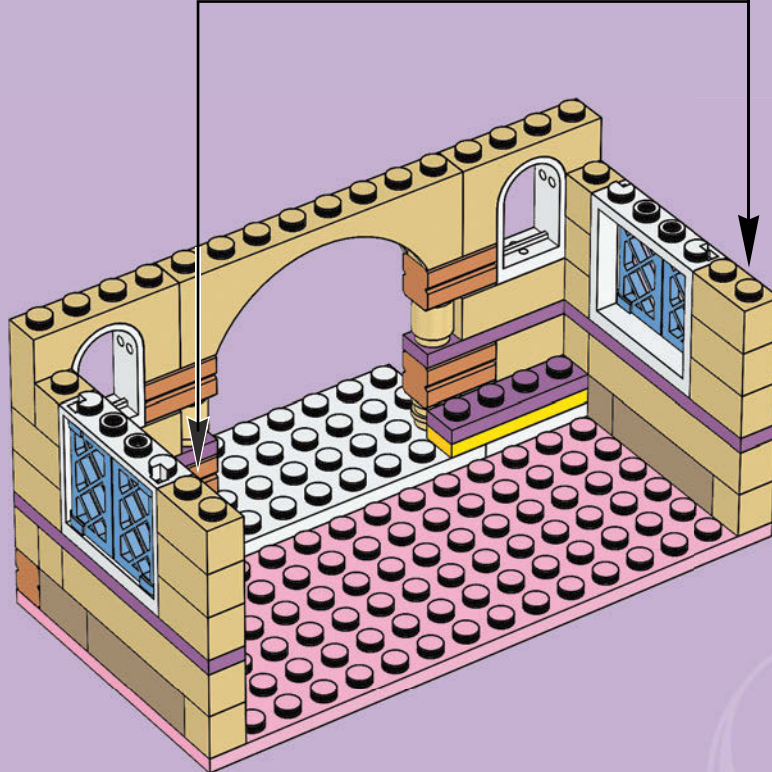
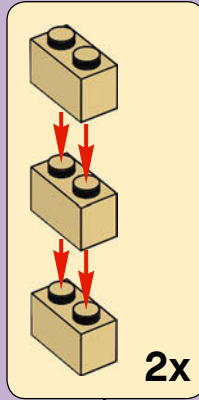

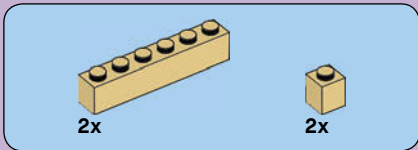

# 13

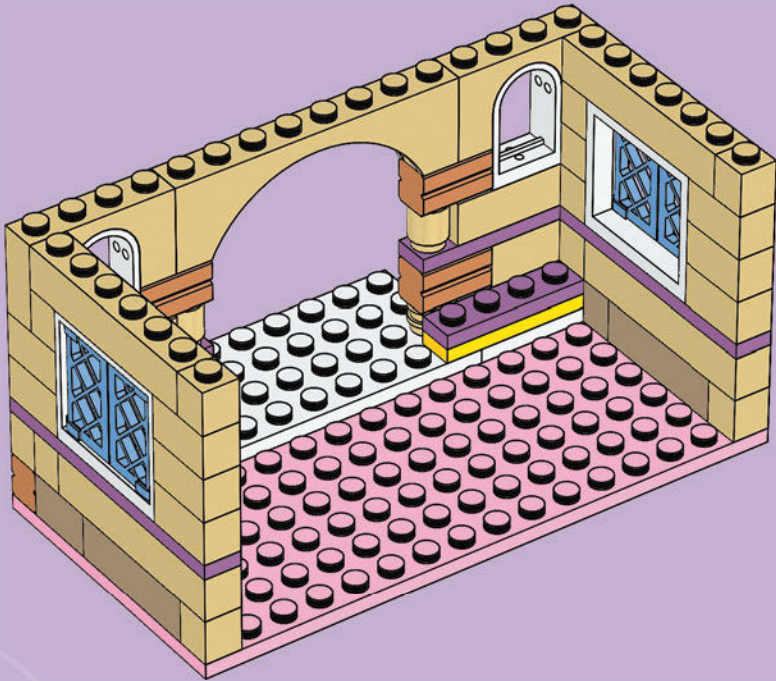

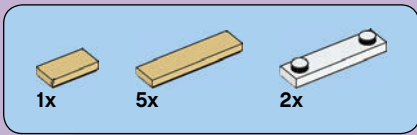

14

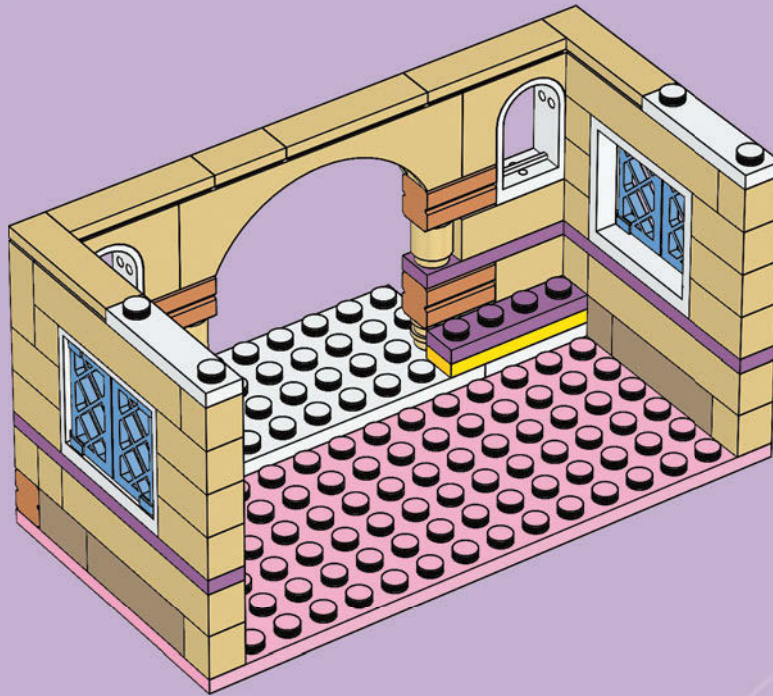



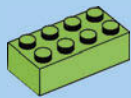

2x

# 15

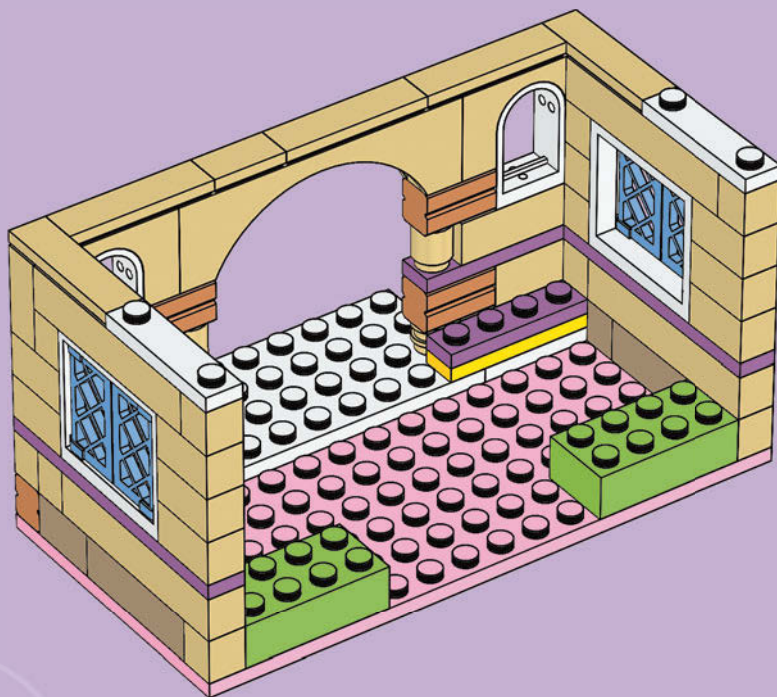

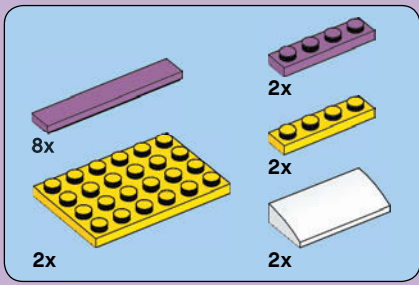

16

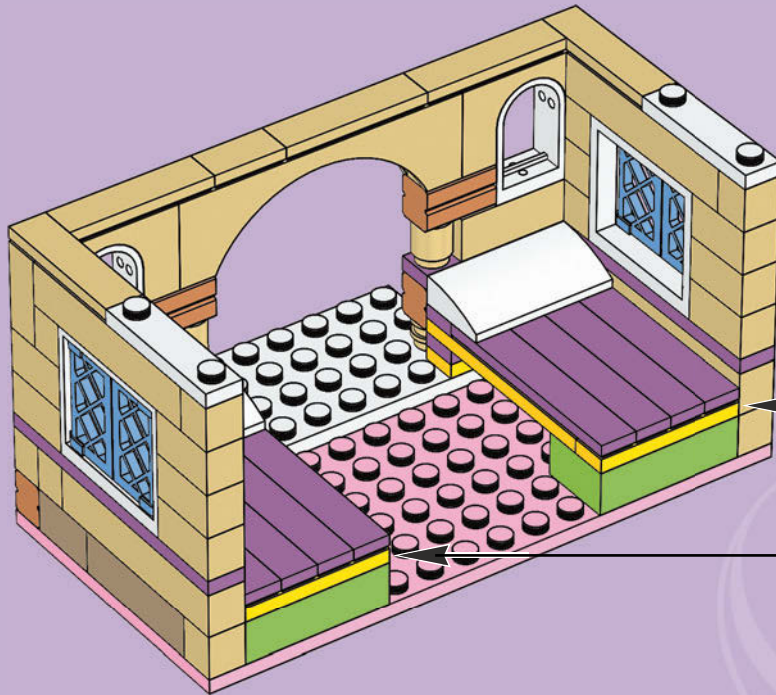
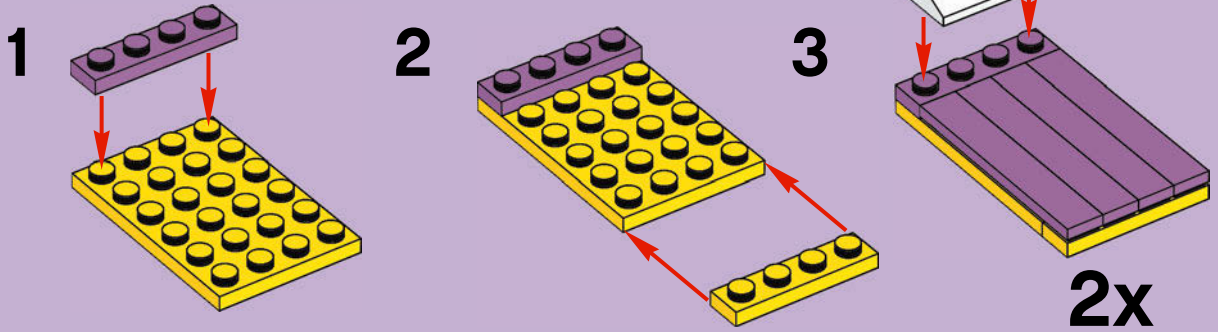



2x

# 17

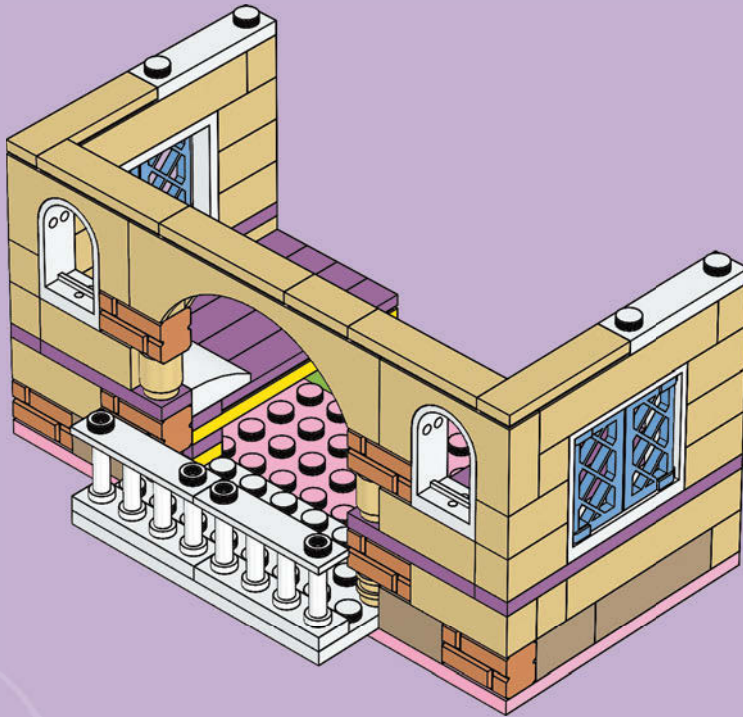
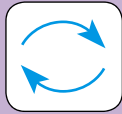

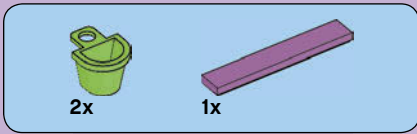

18

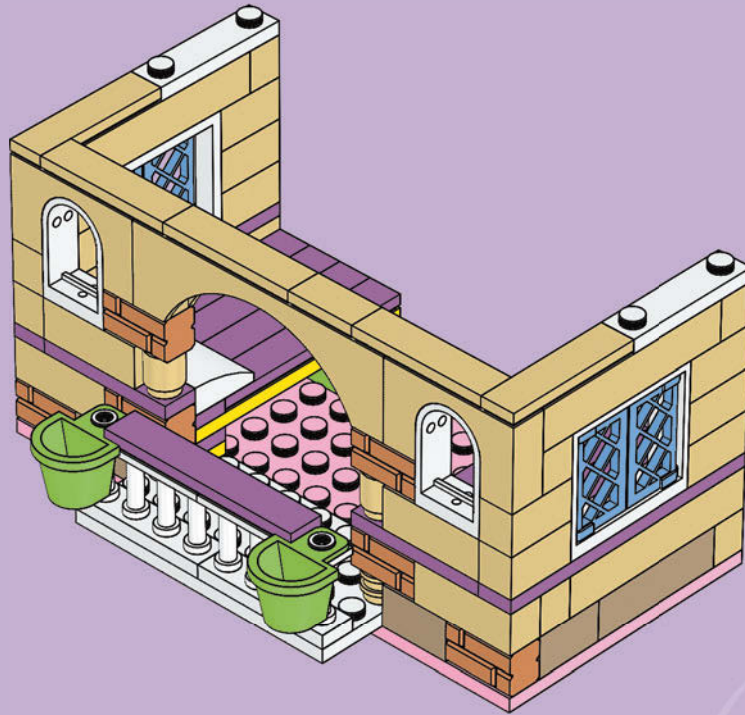



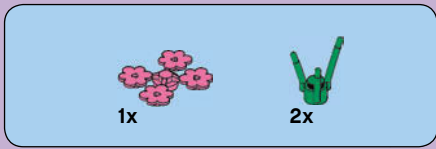

# 19

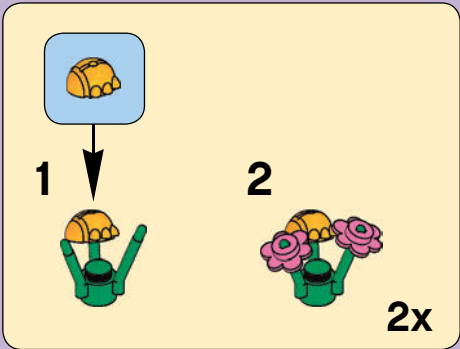
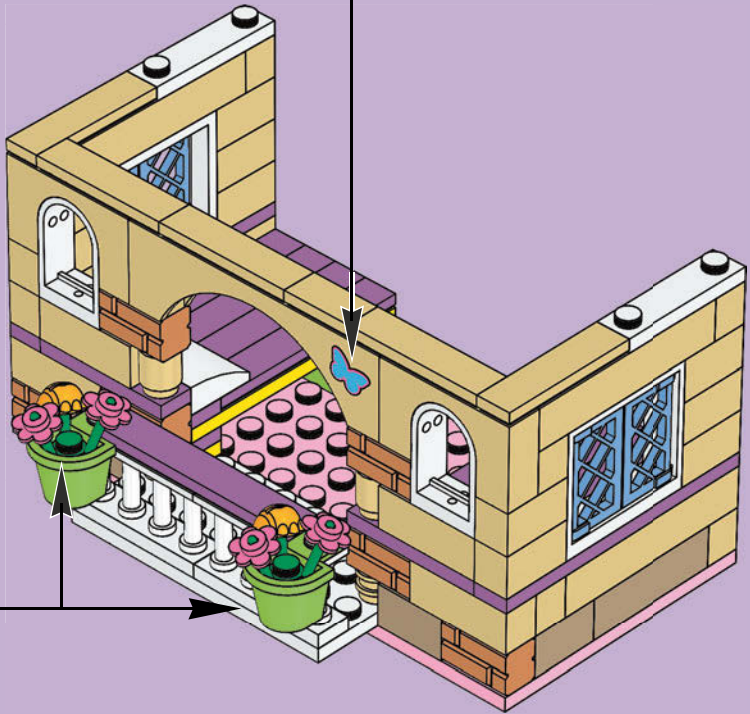

20



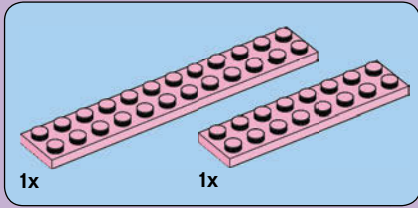
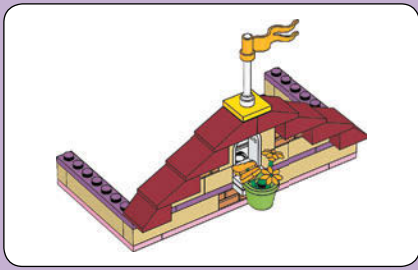

1

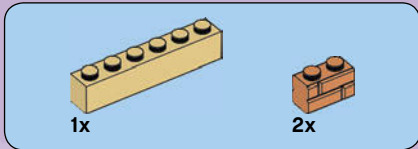
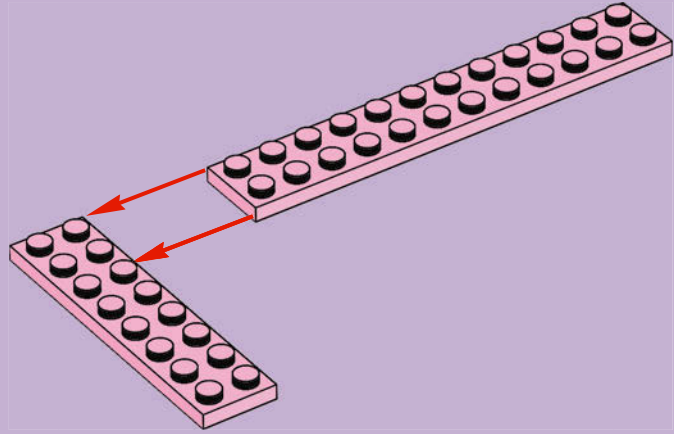

2

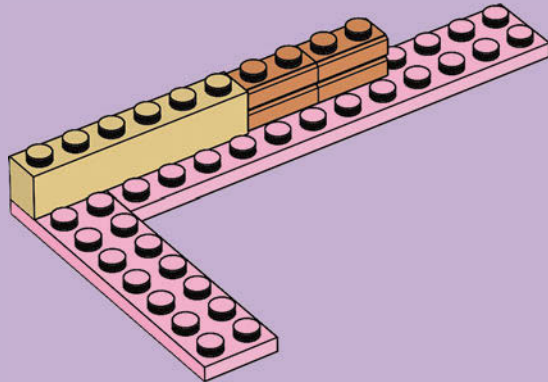

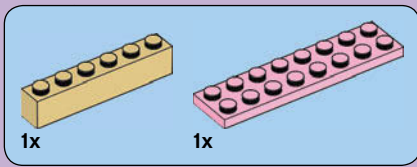

3

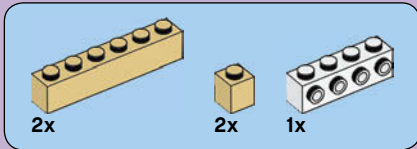
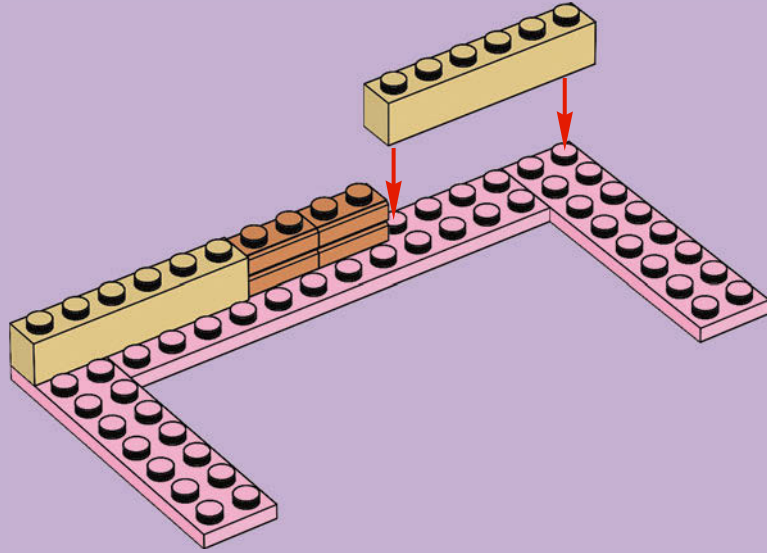

4

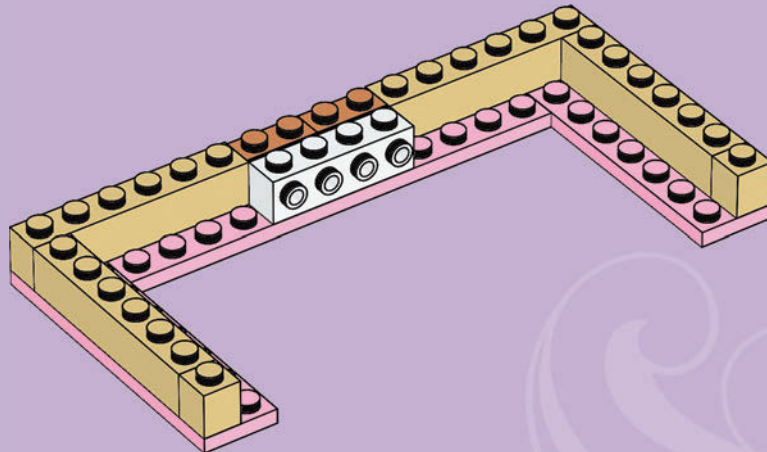



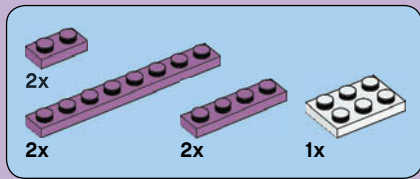

5

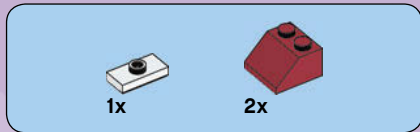
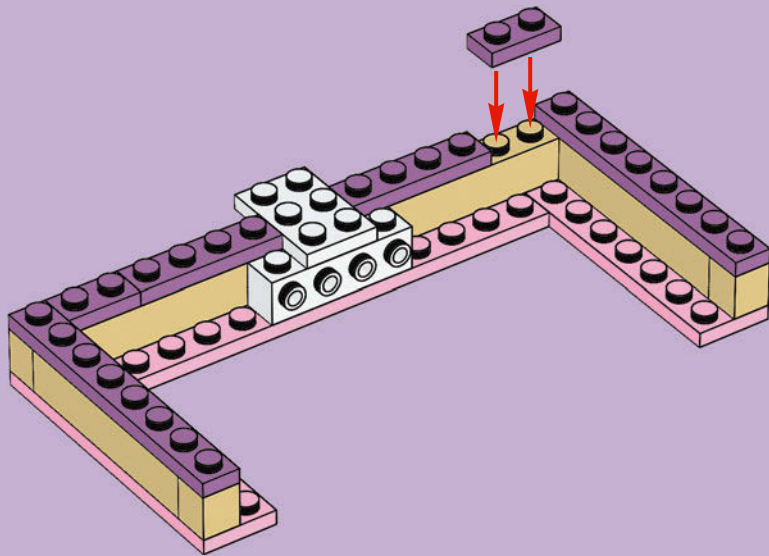

6

