



CITY

3368





+



2

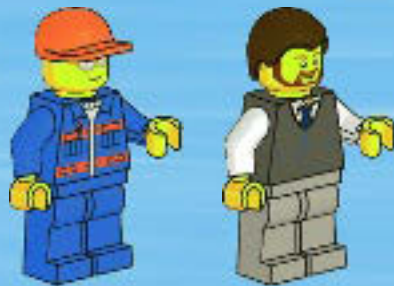
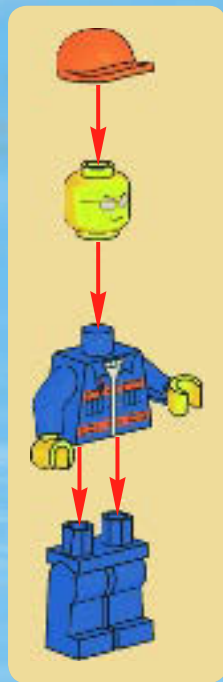
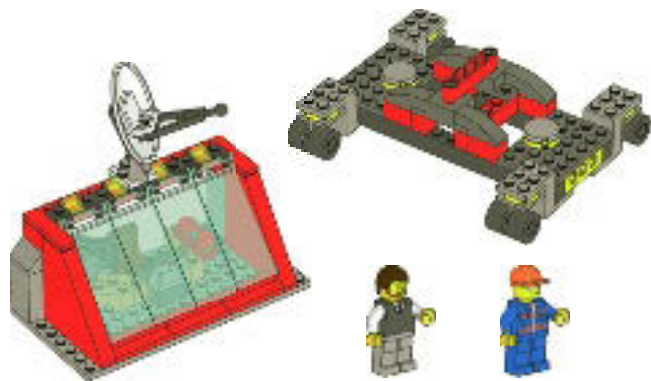



1

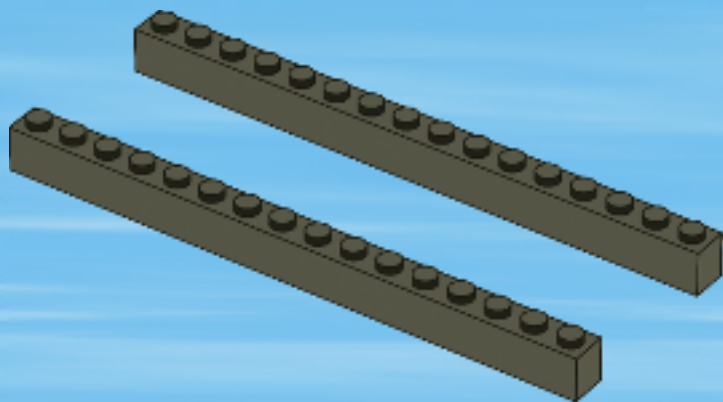

2

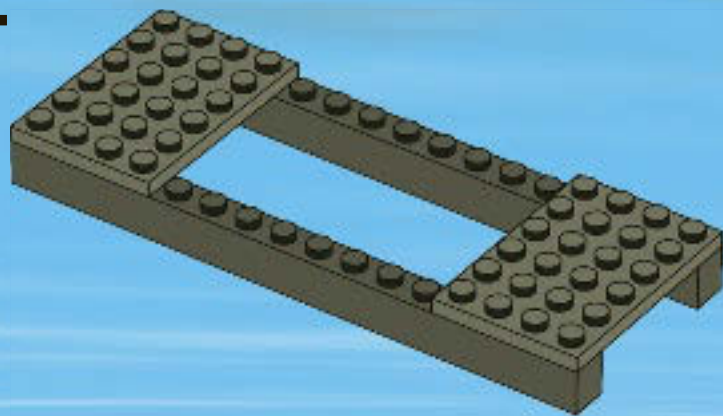

3

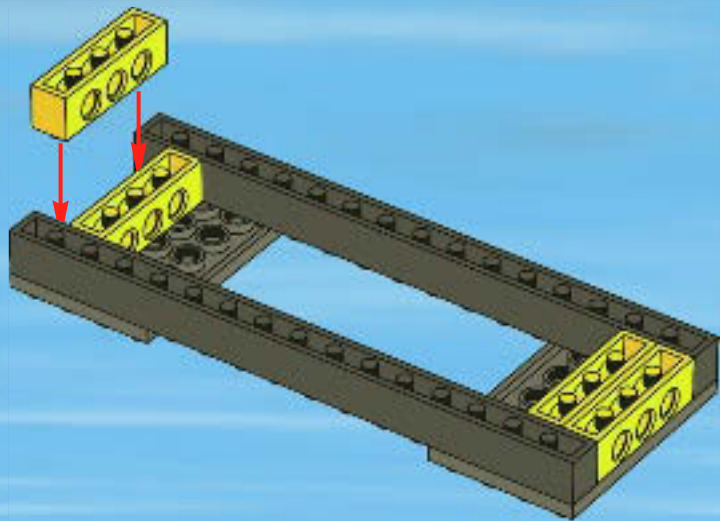

4

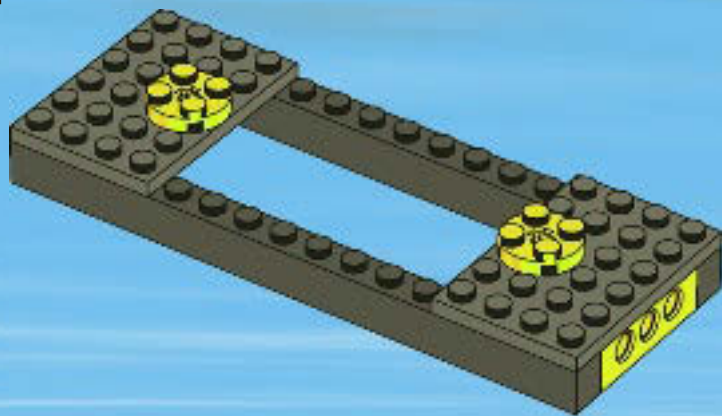

5

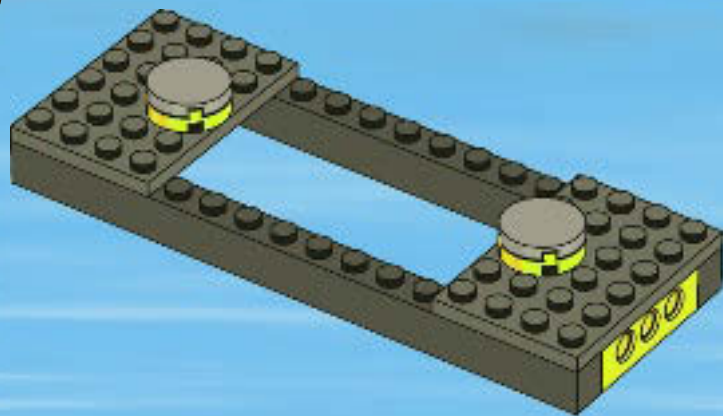

6

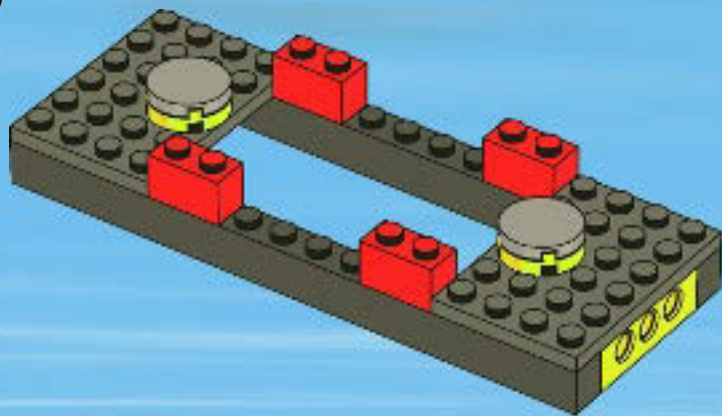

7

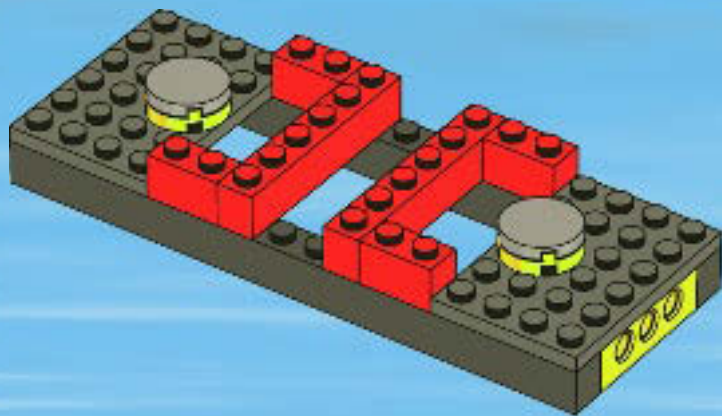

8

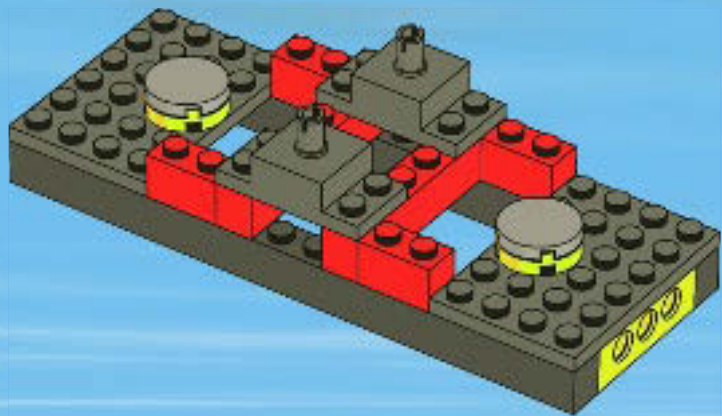

9

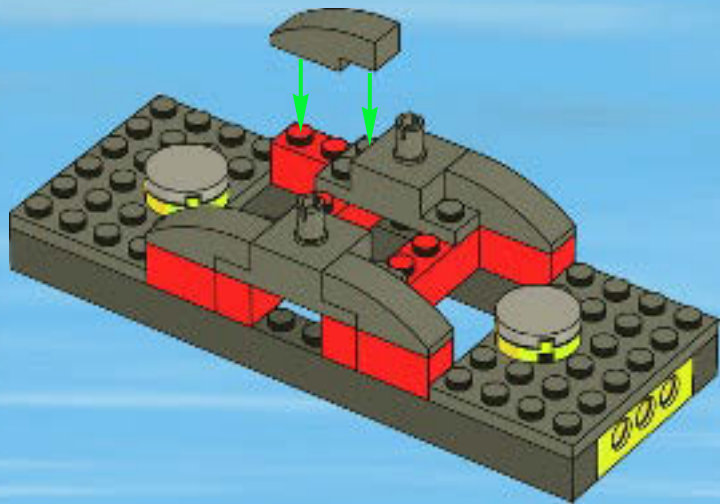

10

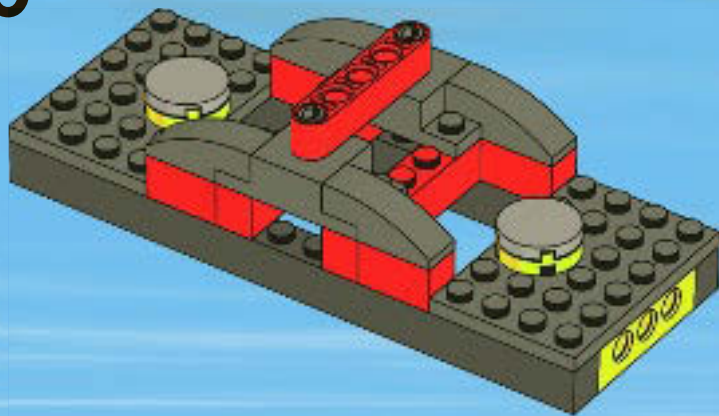

1



2



3

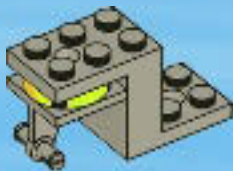

4

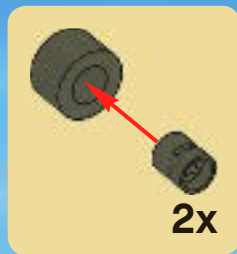

4x

11

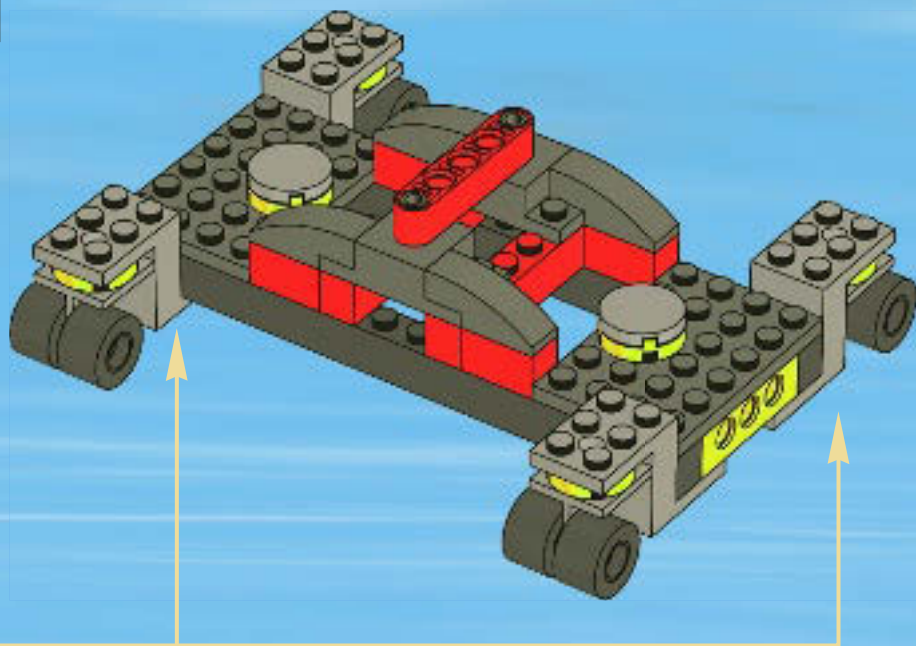

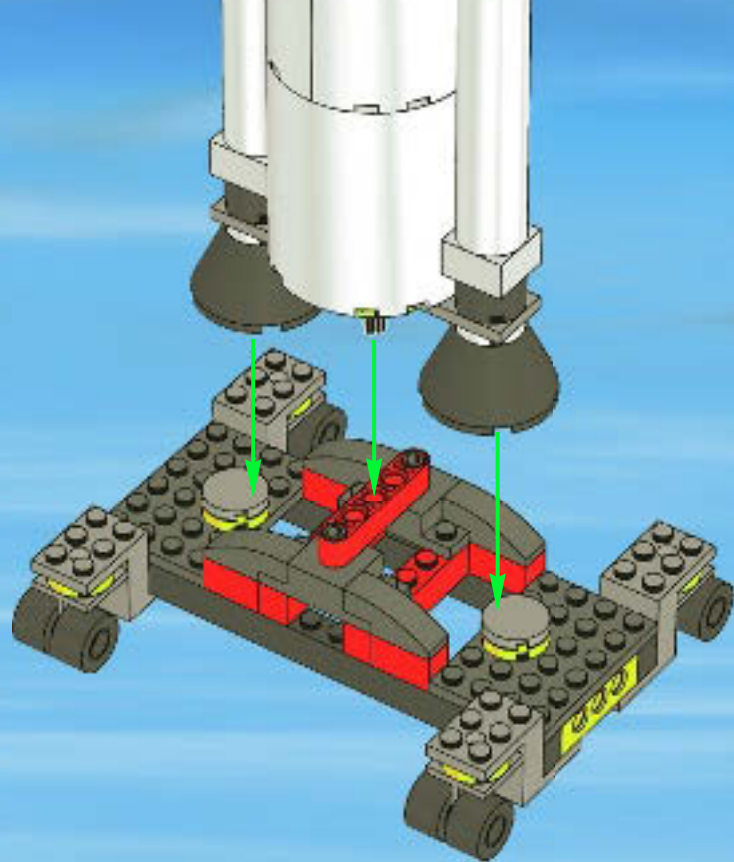



1

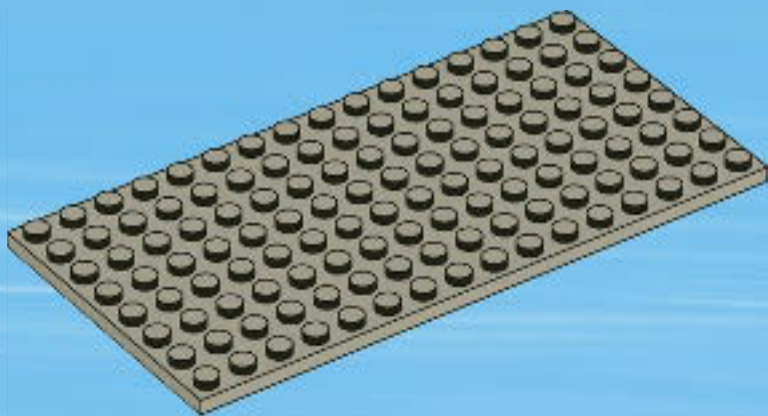

2

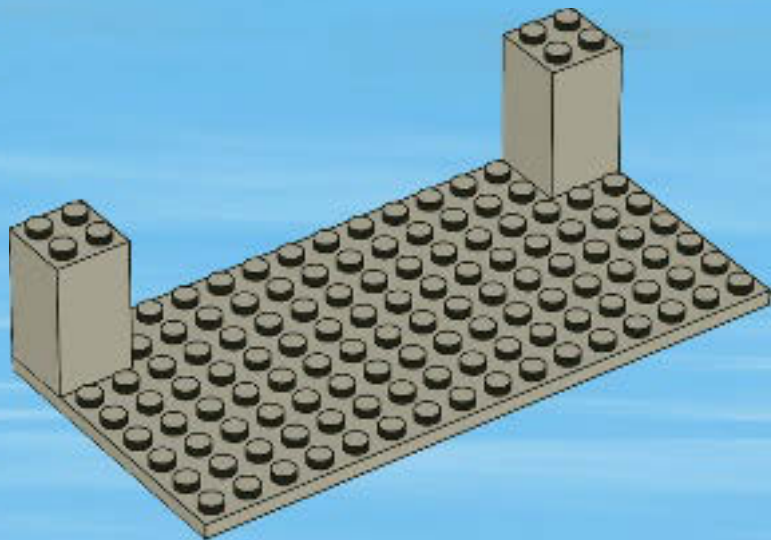

3

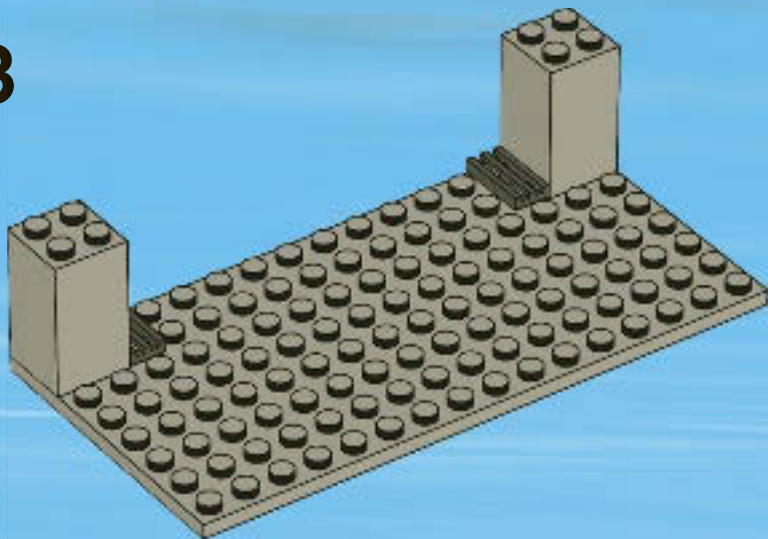

4

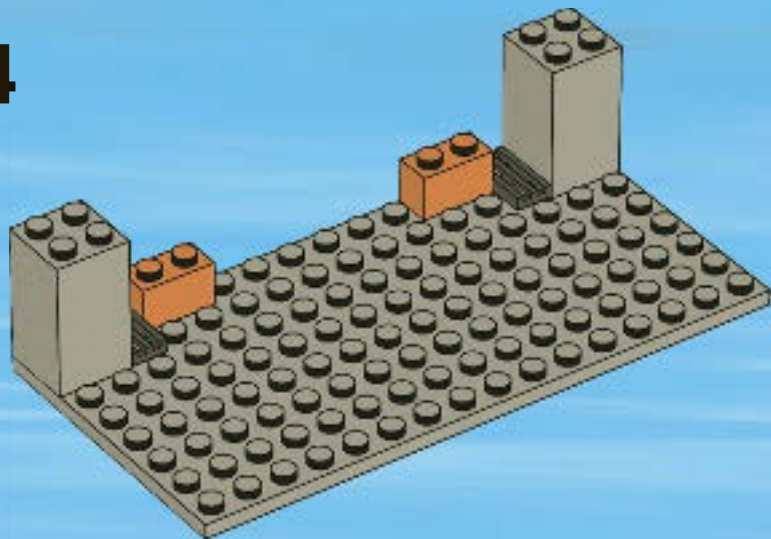

5

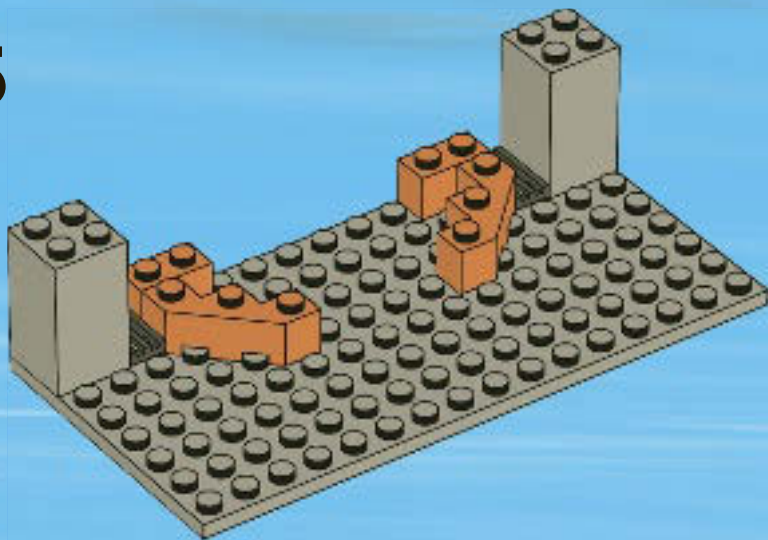

6

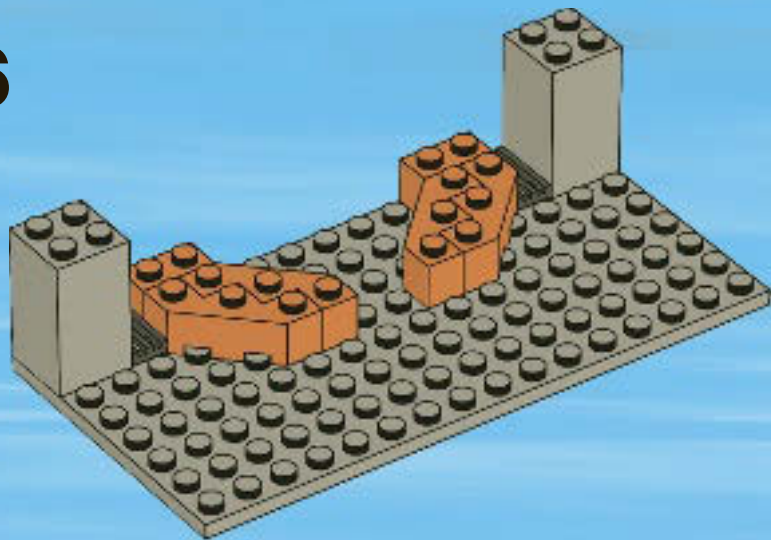

1



2



3



7

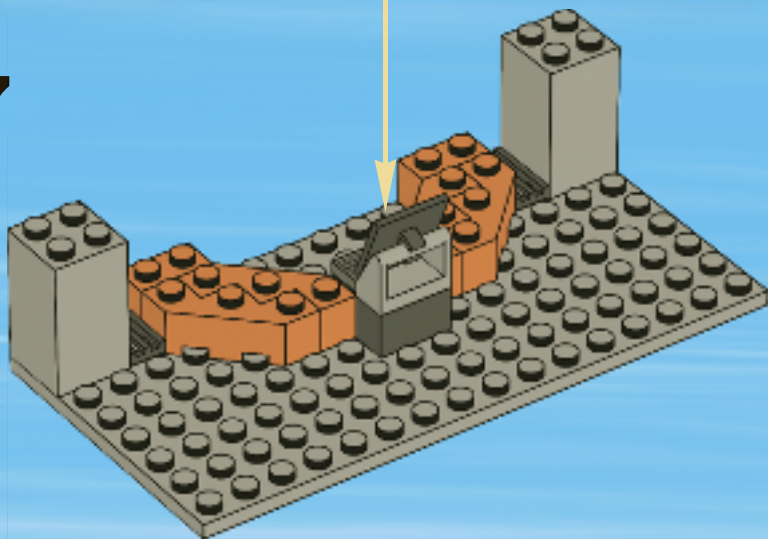

8

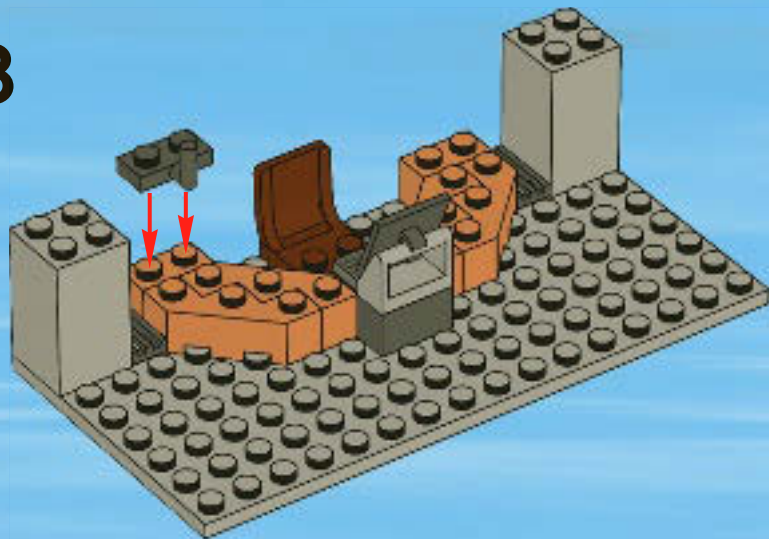

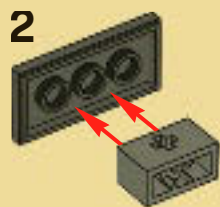
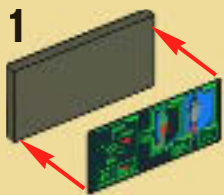

9

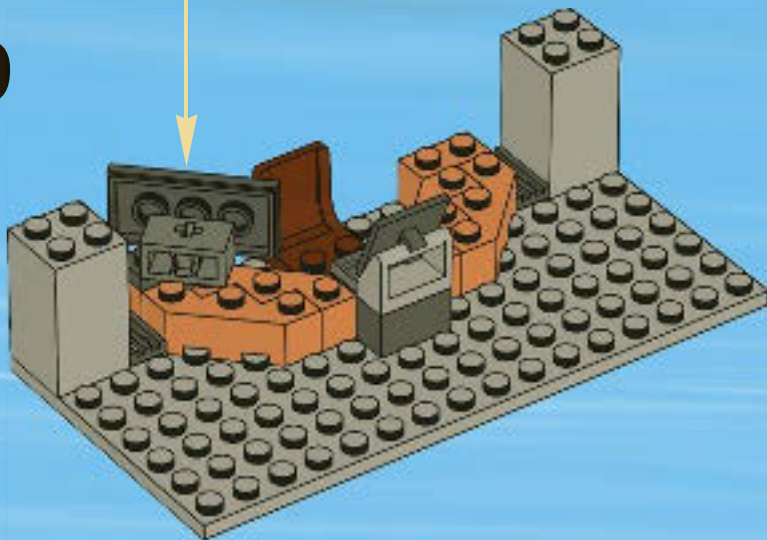

1



2



3



4



10

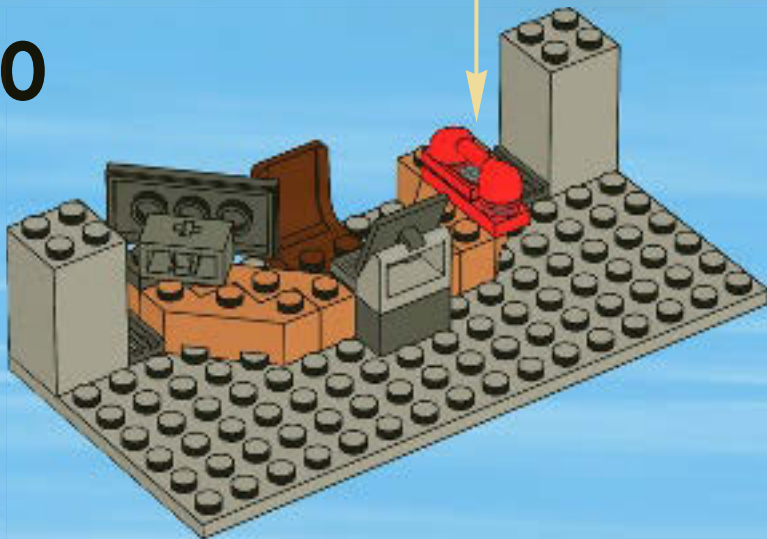

11

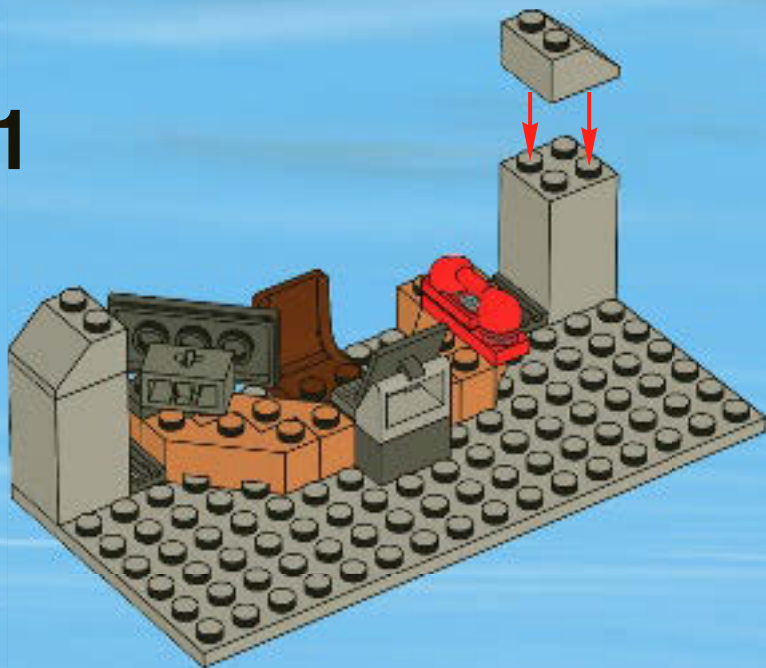

12

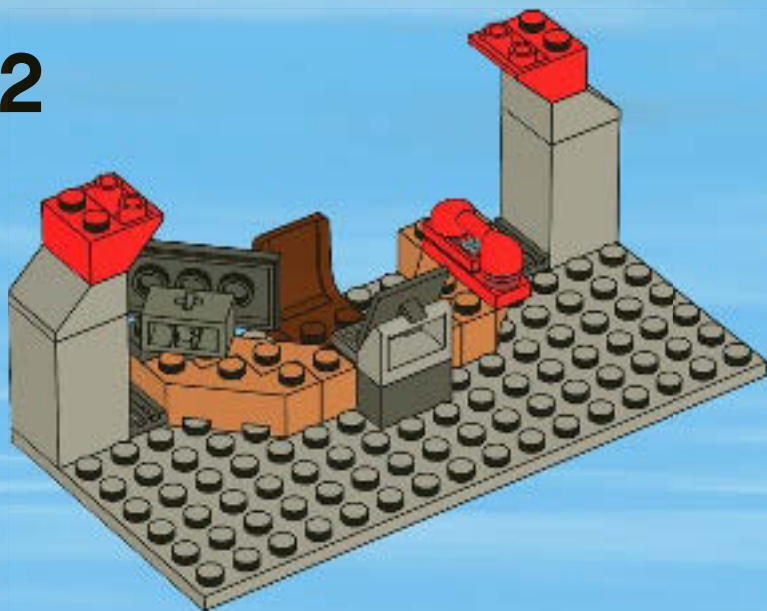

13

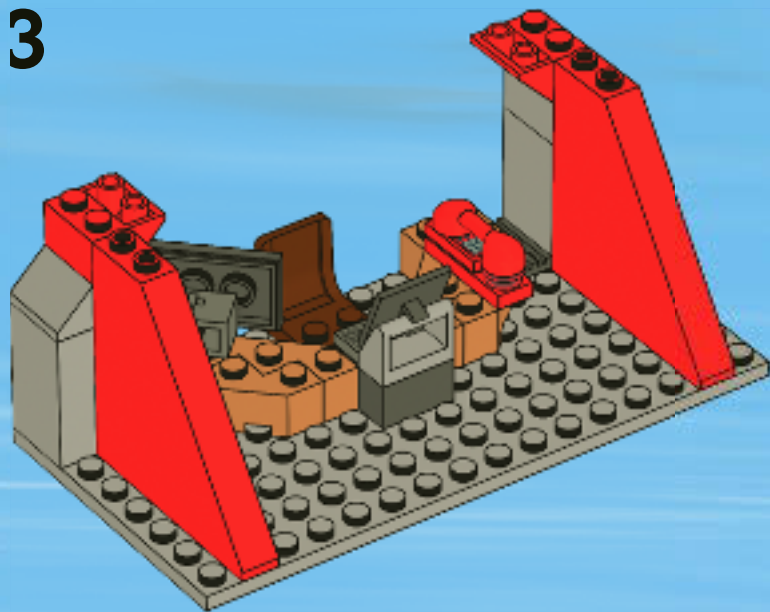

14

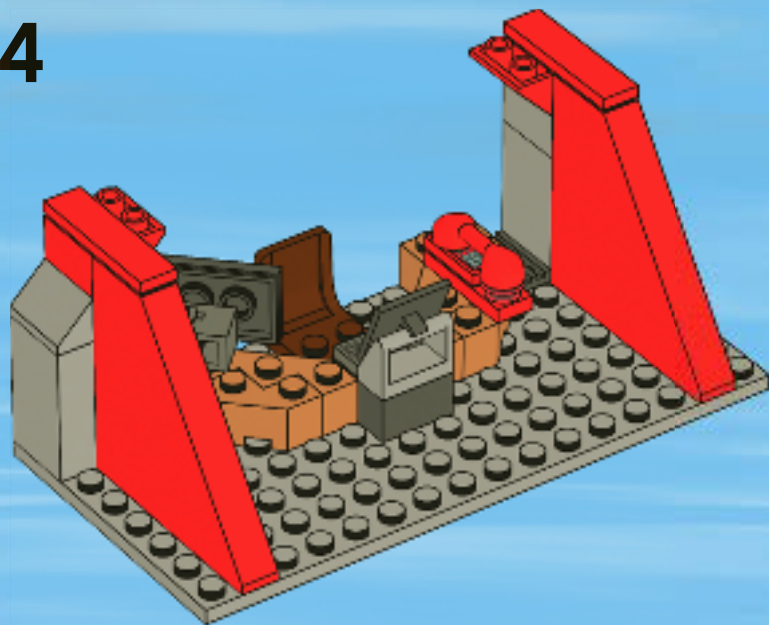

15

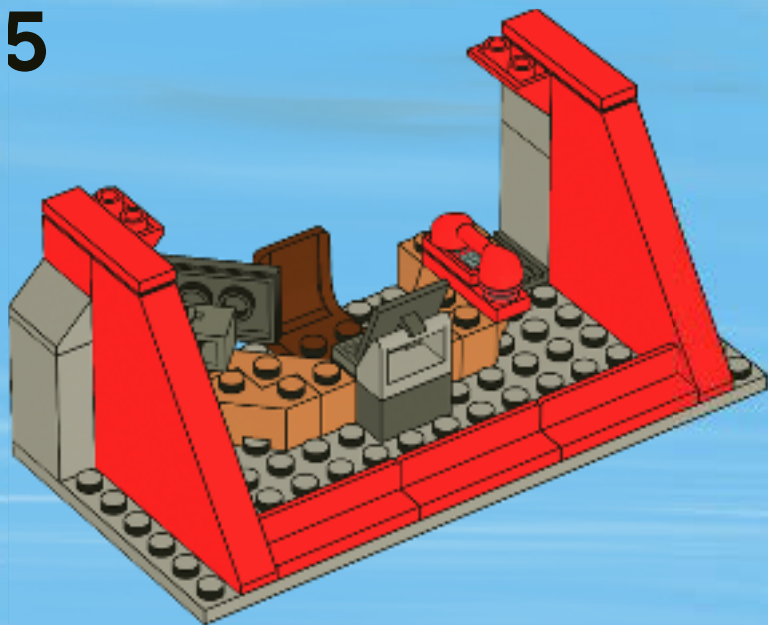



1

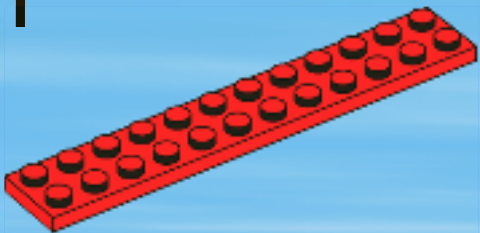

2

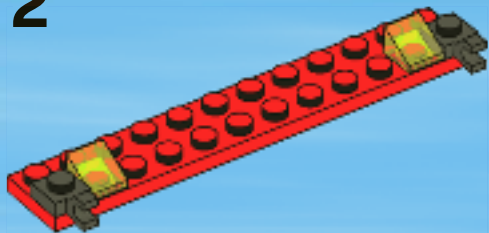

3



4



5

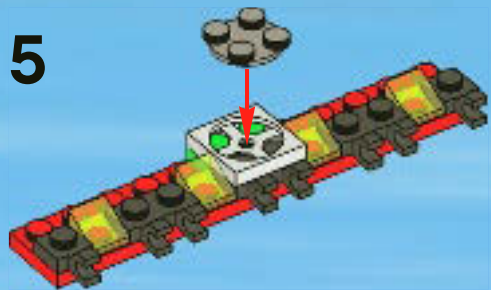

6

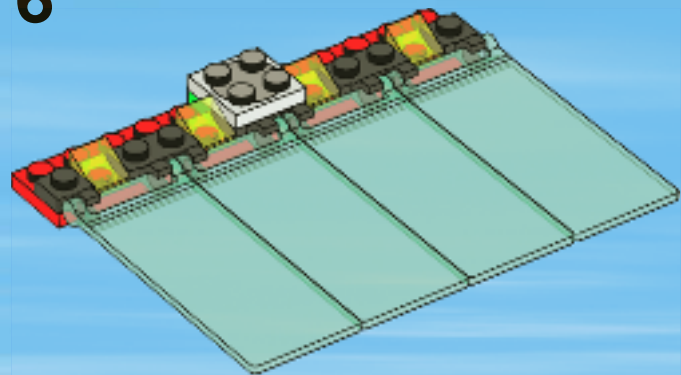

7

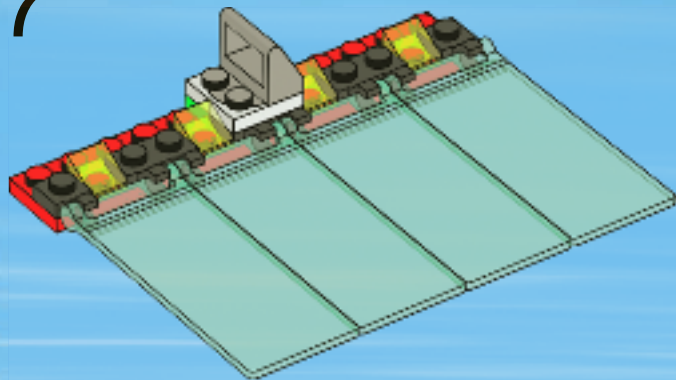

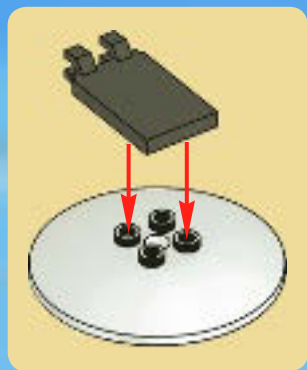

8

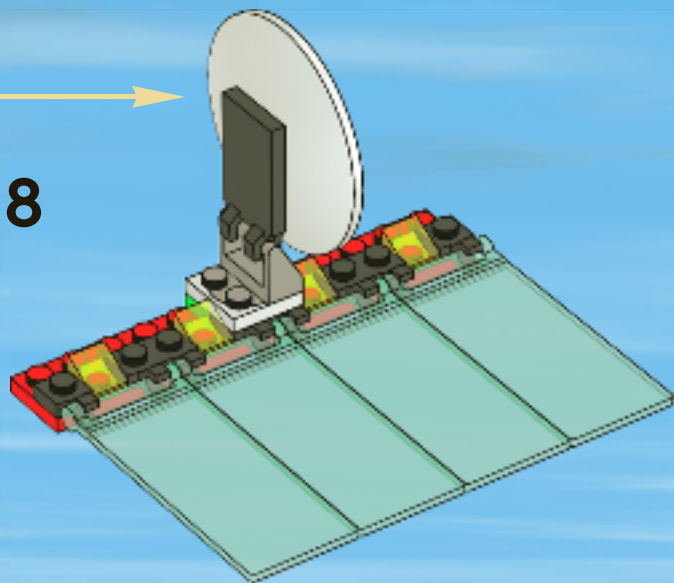

16

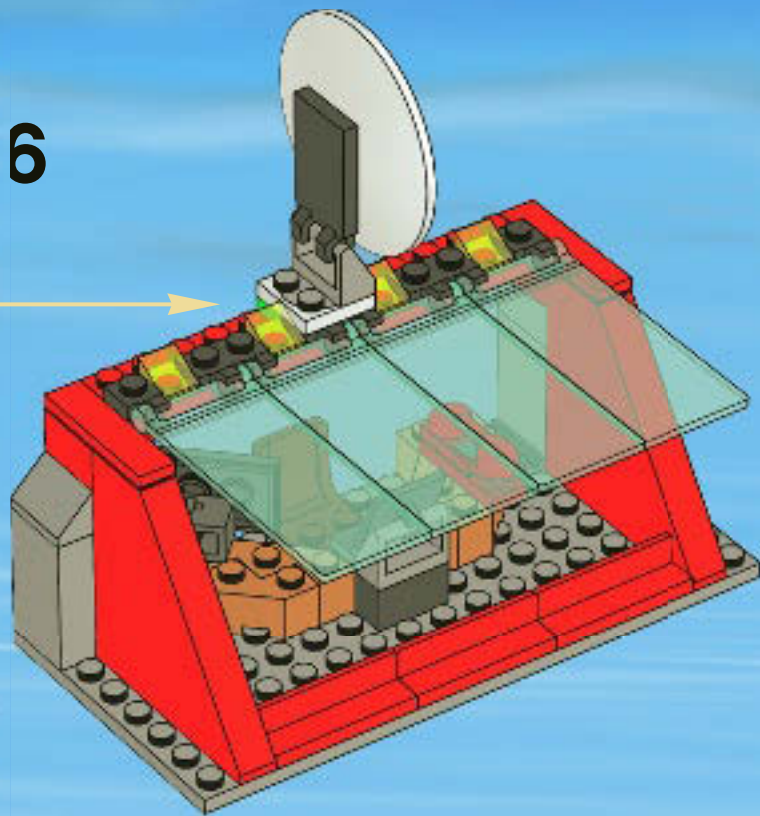

17

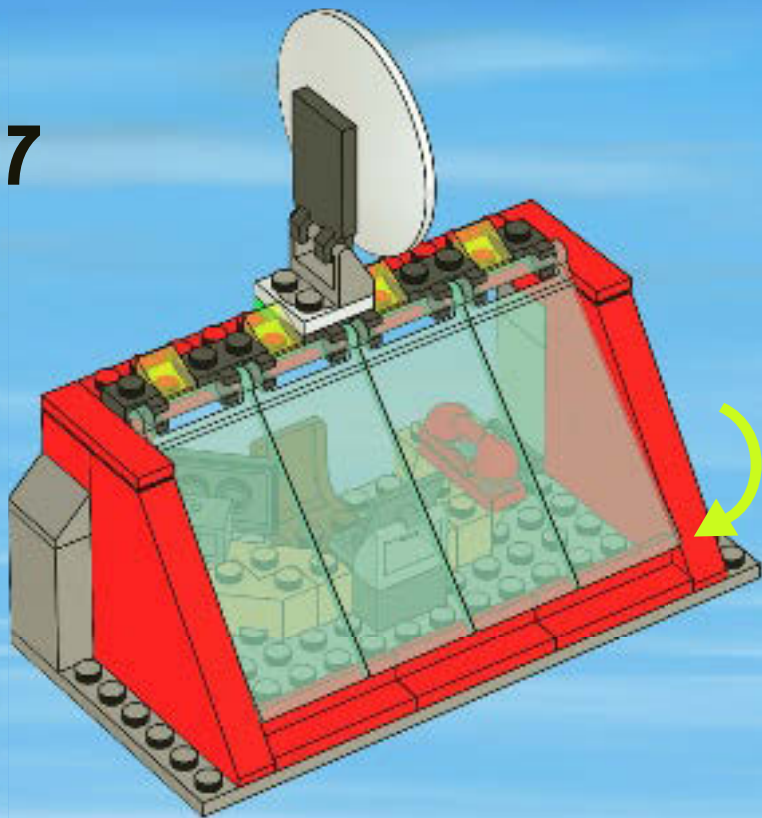

18

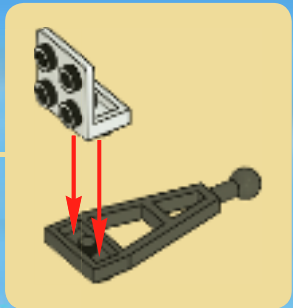
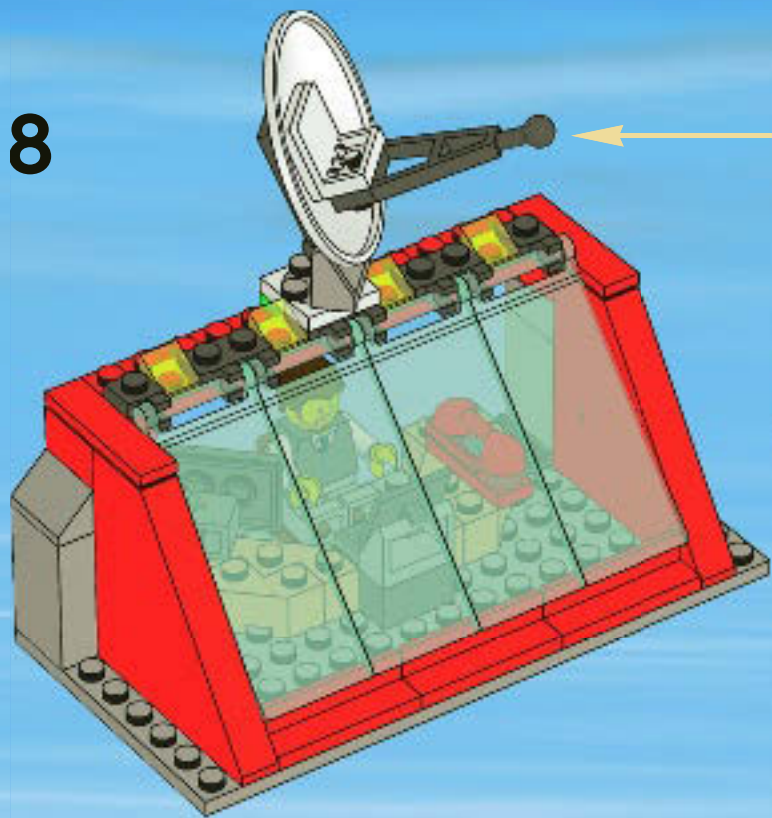

The LEGO logo is displayed in its characteristic white font on a red rectangular background.The word "CITY" is written in a stylized, light blue font with a slight glow effect.A detailed LEGO model of the Saturn V rocket is shown in a vertical orientation, angled towards the right. It features three distinct stages: a white base stage with black boosters, a white middle stage, and a white nose cone. A bright yellow and orange flame is visible at the base. The background is a dark space with a large, glowing planet with orange and white bands, resembling Jupiter, and a bright sun or star.

The three-stage Saturn V is the largest and most powerful rocket ever launched.

La Fusée à trois étages Saturn V est la plus haute et la plus puissante jamais lancée.

El cohete Saturno V, de tres Pases, es el más grande y potente que jamás se ha lanzado.

The LEGO CITY logo is located in the top left corner. It consists of the word "LEGO" in its signature yellow font with a black outline, set against a red square background. To the right of this square, the word "CITY" is written in a large, white, sans-serif font with a slight shadow effect.The word "CITY" is part of the LEGO CITY logo, positioned to the right of the red square containing the "LEGO" text.A LEGO astronaut minifigure is shown in the bottom left corner, facing away from the viewer. It has a white body, a gold helmet, and is holding a grey tool. The background is a dark space with a large, glowing red planet or nebula.

**The ISS
(International Space Station) is where about six astronauts live and
work in space (typically for six months at a time).**

L'ISS (station spatiale internationale) est l'endroit où environ six astronautes vivent et travaillent dans l'espace (normalement pour 6 mois chacun).

La EEI (Estación Espacial Internacional) es una instalación situada en el espacio en la que conviven y trabajan unos seis astronautas (normalmente durante periodos de 6 meses).

**The longest stay at the ISS
was 377 days.**

Le séjour le plus long dans l'ISS (station spatiale internationale) a été de 377 jours.

El máximo periodo de tiempo que ha permanecido una persona en la EEI es de 377 días.



ISS • International Space Station



The LEGO CITY logo, featuring the word "LEGO" in its signature font on a red background, followed by "CITY" in a blue, blocky font.The word "CITY" in a blue, blocky font, part of the LEGO CITY branding.

NASA Astronaut



Spacesuits help protect astronauts from extreme temperatures (-250 degrees Fahrenheit to 250 degrees Fahrenheit).

Les combinaisons spatiales aident les astronautes à se protéger des températures extrêmes (moins 157 degrés Celsius à plus 121 degrés Celsius).

Los trajes espaciales protegen a los astronautas frente a temperaturas extremas (comprendidas entre -157 y 121 grados centígrados).

Every 97 minutes, the Hubble Space Telescope completes an orbit around Earth – Fast enough to travel across the United States in about 10 minutes.

Chaque 97 minutes, le Télescope Spatial Hubble complète une orbite autour de la Terre, assez vite pour traverser les États-Unis en environ 10 minutes.

El Telescopio Espacial Hubble completa una órbita alrededor de la Tierra cada 97 minutos (su velocidad es suficiente como para atravesar Estados Unidos de costa a costa en unos 10 minutos).





CREATOR

5766



3 IN 1



CITY



7279



7285



7286



7287



7288



7498

LEGO

CITY



7942



7239



7207



7208

YES! I want to join the LEGO Club FREE! **OUI!** Je veux m'abonner au LEGO Club GRATUITMENT! **Ja!** Ich möchte Mitglied im kostenlosen LEGO Club werden.
Ja! Ik wil graag GRATIS lid worden van de LEGO Club. **Ja!** Jeg ønsker å melde meg inn i LEGO Club gratis! **Ja!** Jag vill gå med i LEGO Club GRATIS!

First name • Prénom
 Vorname • Voornaam
 Fornavn • Förnamn

Last name • Nom de famille
 Name • Achternaam •
 Etternavn • Efternamn

Date of Birth • Date de naissance
 Geburtstag • Geboortedatum
 Fødselsdato • Födelsedatum

Street • Adresse
 Straße, Hausnr.
 Straat, huisnr. • Adress

City • Ville
 Ort • Woonplaats
 Poststed • Postort

Zip/Postcode
 Code Postal • PLZ
 Postcode
 Postnummer

Email • Courriel
 E-Mail • E-post

Boy • Garçon
 Junge • Jongen •
 Gutt • Pojk

Girl • Fille
 Mädchen • Meisje
 Jente • Flicka

State
 Prov.
 County

Country
 Pays
 Land

Mail to: /
 Poster à:

LEGO Club
 P.O. Box 1157
 Enfield, CT USA
 06083-1157

Send til:
 LEGO Club Norge
 Postboks 58
 1314 Vøyenenga

Mail to:
 LEGO Club
 33 Bath Road
 Slough SL1 3UF
 United Kingdom

Skickas till:
 LEGO Club Sverige
 Ubox 841
 202 29 Malmö

Per Post an:
 LEGO Club
 Postfach 14 15
 D-36243 Niederaula

Poster à:
 LEGO Club
 21 rue de la banque
 75 002 PARIS
 FRANCE

Stuur op naar:
 LEGO Club
 Postbus 40250
 3504 AB Utrecht

Fill in your email address and we will send you a membership confirmation and monthly email newsletters. If you do not wish to receive the newsletters please tick here. Remplis ton adresse e-mail et nous t'enverrons une confirmation d'adhésion ainsi que le bulletin e-mail mensuel. Si tu ne désires pas recevoir le bulletin, coche cette case. Vul je e-mailadres in en we sturen je een bevestiging van je lidmaatschap en maandelijkse e-mail nieuwsbrieven. Als je geen e-mail wilt ontvangen, kruis dan dit vakje aan.

If you do not wish to receive additional mailings from the LEGO Club please tick here. Si tu ne désires pas recevoir de courrier supplémentaire du Club LEGO, coche cette case. Als je geen verdere post van de LEGO Club wilt ontvangen, kruis dan dit vakje aan.

Ich möchte per E-Mail den monatlichen LEGO Club Newsletter erhalten. Önsker du at vi skal sende en liten hilsen til barnet ditt for å bekrefte medlemskapet, ber vi deg krysse av i feltet, samt oppgi e-postadressen som hilsenen skal sendes til. Om du vill att vi ska skicka en bekräftelse på ditt barns medlemskap, ber vi dig sätta ett kryss i rutan och skriva den e-post adress som bekräftelsen ska skickas till.

Om du vill få annan informasjon från LEGO Gruppen, sätt ett kryss här. Dersom du ønsker å motta annen informasjon fra LEGO Gruppen, setter du et kryss her.

The English language version of the magazine can only be mailed to addresses in the US, Canada, the UK and Republic of Ireland. Club membership is valid for two years and includes free copies of the LEGO Club Magazine and e-mail newsletters. In the US and Canada please allow up to 6 weeks for delivery of your first magazine. In the UK and Republic of Ireland please allow six to 14 weeks for delivery of your first magazine. By signing this form you consent the LEGO Club to use your child's data for LEGO mailings. The data will only be used for LEGO mailings and will not be sold, rented or otherwise disclosed to any company outside the LEGO Company except for disclosure to companies acting as our agents to help us provide services requested by the child. This coupon is valid for one free membership per person, group or organization. Photocopied coupons are not valid. La version française du magazine peut être postée uniquement au Canada. L'abonnement est valide pour 2 ans et inclut des exemplaires gratuits du magazine LEGO Aux E U et au Canada, allouer 6 semaines pour la livraison initiale. En remplissant ce formulaire, vous consentez à ce que LEGO utilise les informations de votre enfant pour des envois postaux de LEGO L'information sera utilisée uniquement pour des envois postaux par LEGO et ne sera en aucun cas, vendue, louée, échangée ou divulguée à d'autres compagnies autres que la compagnie LEGO, à l'exception des compagnies affiliées qui nous procurent des services auxquels l'enfant en a fait la demande. Formulaires photocopiés acceptés. Mit der folgenden Unterschrift erkläre ich, für mein Kind den Beitritt zum kostenlosen LEGO Club, der von der LEGO GmbH, D 85627 Grasbrunn, betrieben wird. Die Mitgliedschaft beinhaltet die Zusendung des LEGO Club Magazins und kann beiderseits jederzeit beendet werden. Mit der Mitgliedschaft im LEGO Club sind keinerlei Verpflichtungen verbunden. Das deutschsprachige LEGO Club Magazin wird nur an Adressen in Deutschland, Österreich und der Schweiz versendet. Eine Anmeldebestätigung kann nur per E-Mail geschickt werden. Das Magazin erscheint fünfmal jährlich. Daher kann die Zustellung des ersten Heftes bis zu drei Monate dauern. Die Mitgliedschaft ist beidseitig jederzeit kündbar, ohne dass Ihnen Kosten entstehen. Sie können der werblichen Nutzung Ihrer Daten jederzeit widersprechen. Kündigung und Widerspruch können Sie telefonisch erklären (00800 / 5346 5555, Anruf gebührenfrei, Kosten für Anrufe aus dem Mobilfunknetz können abweichen) oder an die LEGO GmbH senden. Het Nederlandse LEGO Club Magazine kan alleen worden gestuurd naar adressen in Nederland. Het lidmaatschap is 2 jaar geldig en geeft recht op toezending van het gratis LEGO Club Magazine en LEGO Club e-mails. Het eerste magazine zal binnen 12 tot 14 weken toegestuurd worden. Het lidmaatschap kan op ieder moment opgezegd worden en kan na 2 jaar gratis worden verlengd, tenzij LEGO met deze activiteit stopt. Uw gegevens worden uitsluitend gebruikt voor mailings van LEGO en zu niet worden verkocht, verhuurd of op weke wijze dan ook versprekt aan derden buiten de LEGO Groep, uitgezonderd de organisaties die namens ons optreden om de informatie te sturen waarvoor toestemming is verleend. Den norske utgaven av magasinet sendes kun til adresser i Norge. Medlemskap i klubben gjelder 2 år og inkluderer gratisutgaver av LEGO Club Magazine. Pæren minimum oppsett seks eller leveringsstid for første magasin. Ved å undertegne dette skjemaet, gir du ditt samtykke til at LEGO Club kan bruke opplysningene om barnet ditt i LEGO ferdensler. Dataene vil utelukkende bli brukt i LEGO ferdensler og vil ikke bli solgt, utleiet eller på annen måte gjøres tilgjengelig for selskaper utenfor LEGO gruppen, unntatt selskaper som er våre agenter og som hjelper oss å ti by tjenestene barnet etterter. Dette skjemaet gjelder for ett gratis medlemskap per person, gruppe eller organisasjon. Den svenska versionen av tidningen kan endast skickas till adresser i Sverige. Club medlemskapet är giltigt i 2 år och innefattar gratis exemplar av LEGO Club Magazine. Vänligen räkna med minimum 6 veckor för leveransen av din första tidning. Genom att skicka in det här formuläret godkänner du att LEGO Club använder barnets uppgifter för LEGO utskick. Uppgifterna kommer bara att användas för LEGO utskick och kommer inte att sål, hyras ut eller vidarebefordras till något företag som inte tillhör LEGO Gruppen, med undantag av företag som agerar som våra ombud för att tillhandahålla tjänster som barnet har begärt. Den här kupongen gäller för ett gratis medlemskap per person, grupp eller organisation. En complétant ce bulletin d'adhésion, vous acceptez que LEGO Club utilise les données relatives à votre enfant pour l'envoi de courriers concernant LEGO. Ces données seront uniquement utilisées pour l'envoi d'information concernant LEGO et ne seront ni vendues, ni louées, ni utilisées par d'autres sociétés que le groupe LEGO, à l'exception des sociétés agissant pour le compte de LEGO en tant que sous-traitant de services divers. L'abonnement au LEGO Club est valable pour une période de 2 ans. Il inclut l'envoi par courrier du magazine LEGO Club et par email des newsletters. Un délai de 6 à 14 semaines est à prévoir pour la réception de votre premier magazine. Ce bulletin d'adhésion gratuit est valable pour l'inscription d'une seule personne. Les photocopies sont acceptées. ATTENTION! Le bulletin d'adhésion doit être rempli et signé par un parent ou un tuteur.

Parent's signature • Signature d'un parent ou d'un tuteur
 Unterschrift Erziehungsberechtigter/ • Handtekening ouders •
 Foreldres/foresattes underskrift • Förälders /förmyndares underskrift

Date
 Datum
 Date



LEGO club

FREE! GRATIS! GRATUIT!

 www.LEGO.com

SIGN UP ONLINE!

www.LEGOclub.com



00800 5346 5555*



1-866-534-6258 • 1-877-518-5346

US & Canada only

One call, worldwide

- * Freephone. Mobile charges may apply.
- * Numéro sans frais. Des frais peuvent s'appliquer avec les téléphones cellulaires.
- * Gebührenfrei, Kosten für Anrufe aus Mobilfunknetzen können abweichen.
- * Gratis telefonnummer vanaf vaste lijn.
- * Det er et gratis nummer, når du ringer fra fasttelefon.
- * Det är gratis, när du ringer från en fast telefon.
- * Numéro sans frais. Des frais peuvent s'appliquer avec les téléphones portables.