



41054





+



2x



4x

# 46





1x



1x



2x

# 47





2x



1x

# 48





2x

# 49





2x

# 50





1x



2x

# 51





2x



3x



1x

# 52

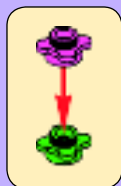





2x



2x





# 53



2x



4x  2x 

1  2   
2x  

54

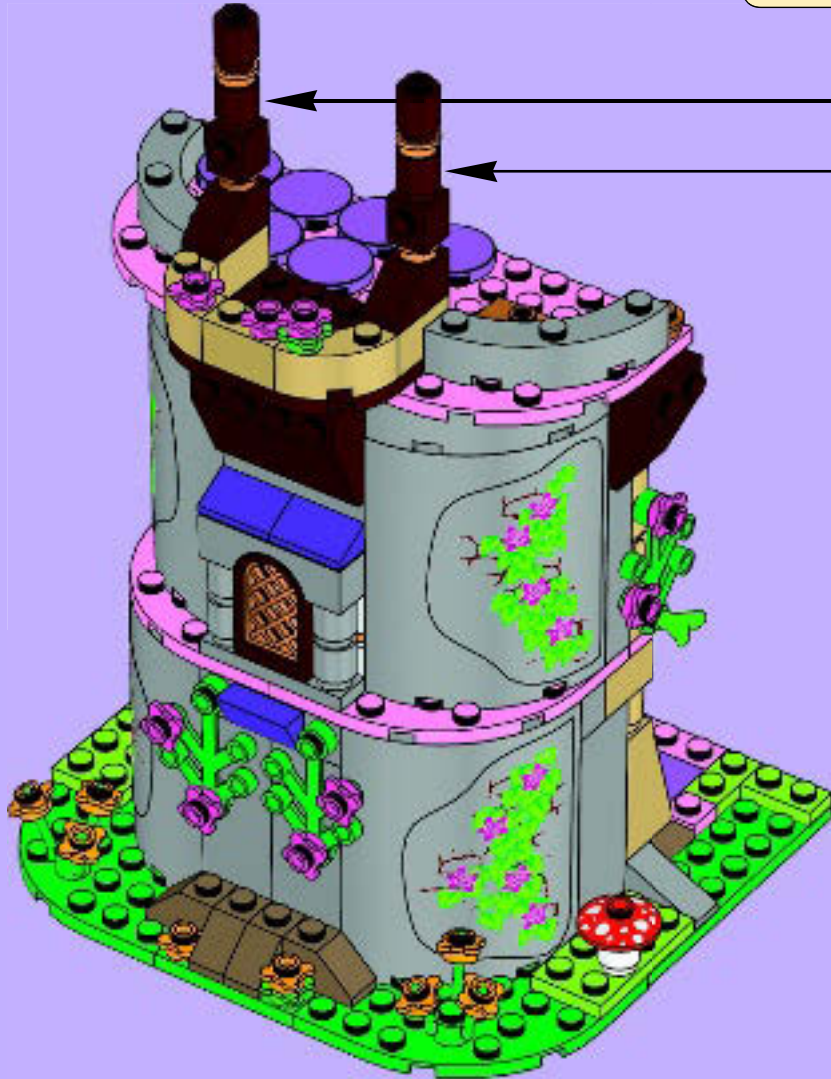



1x

55



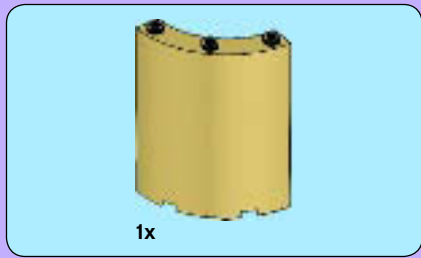

56

1



2



3

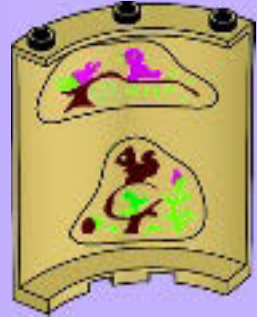
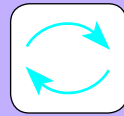



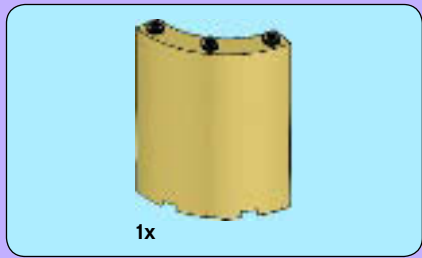

57

1

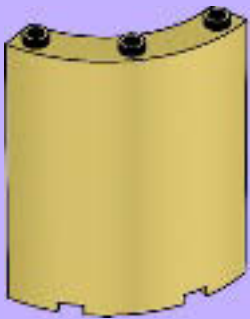

2



3

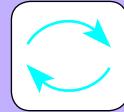



2x  6x 

58

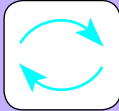

1  2  2x







2x

# 59



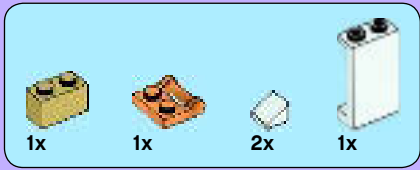

60

1

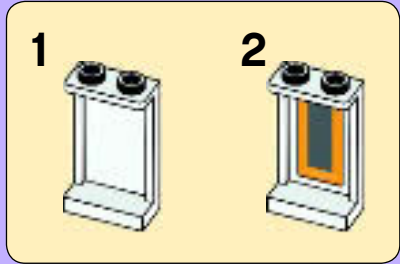

2



3



61

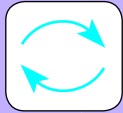



2x

1

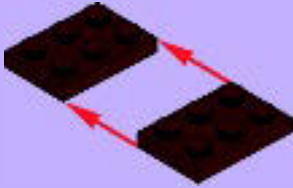

1x

2



4x



2x

3



1x



2x

4

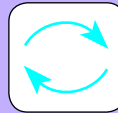

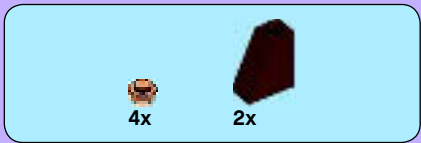

5



6



62



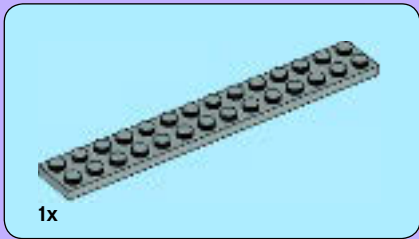
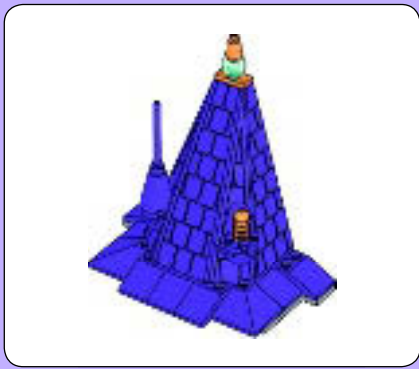

1x

1

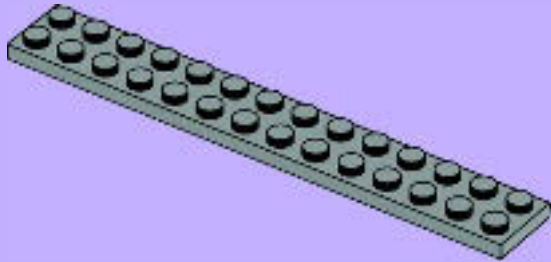

2x

2

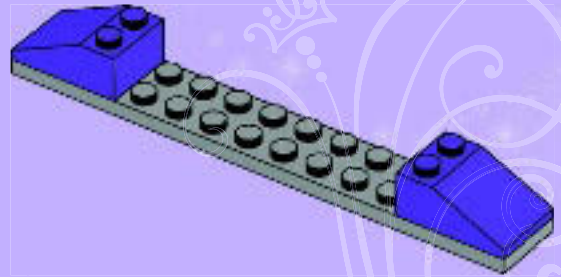





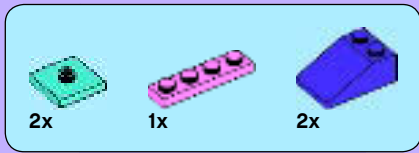

5

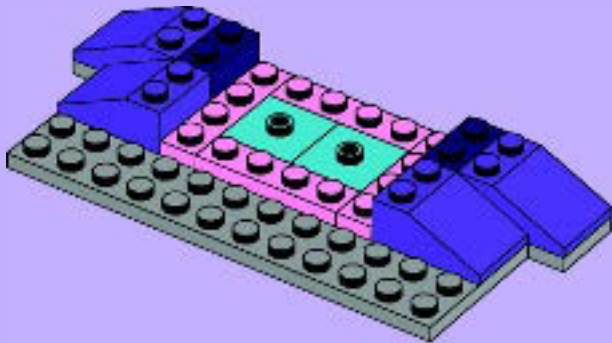

6

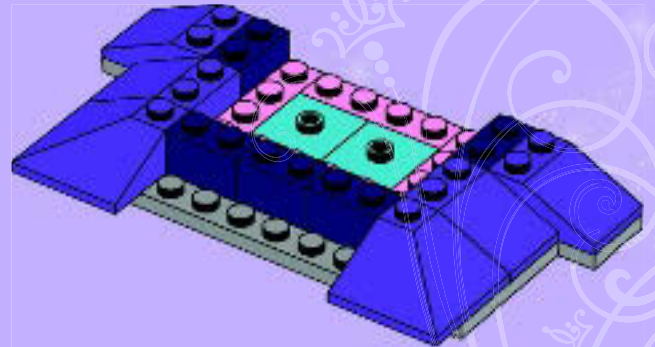



3x

7

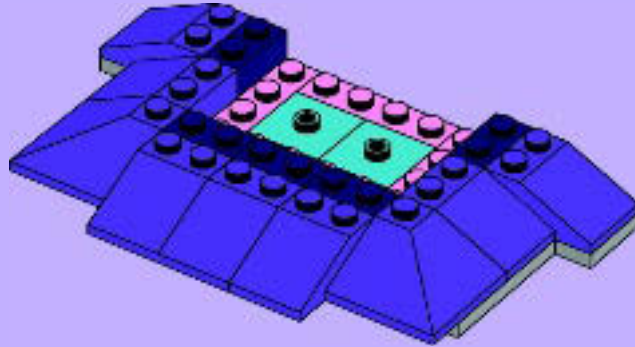

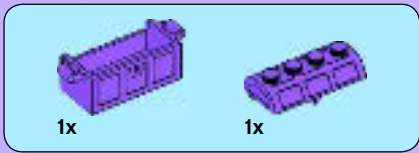

8

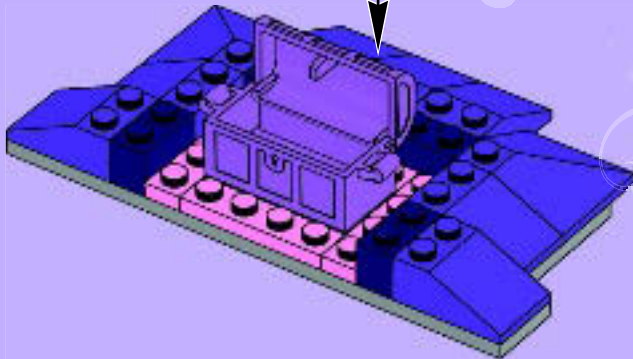
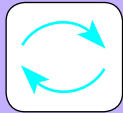
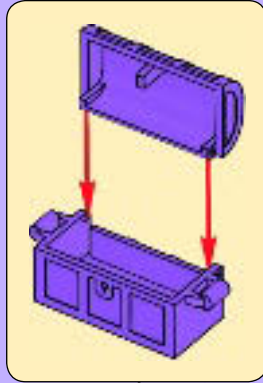

1x 1x 1x 3x

9

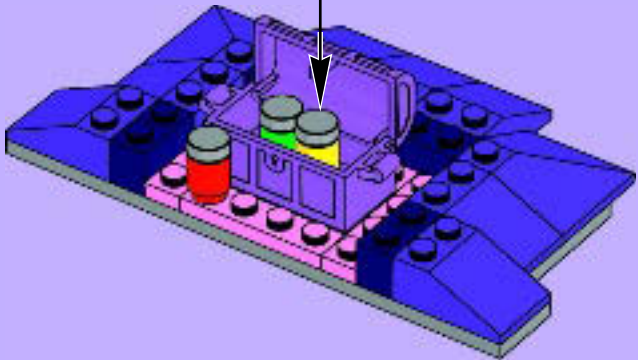

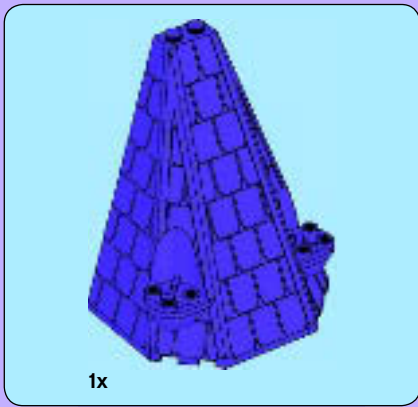

10

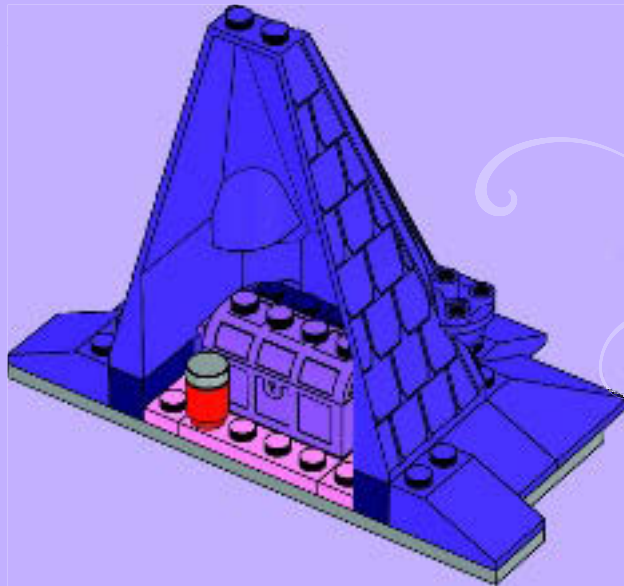

3x 1x 1x

# 11

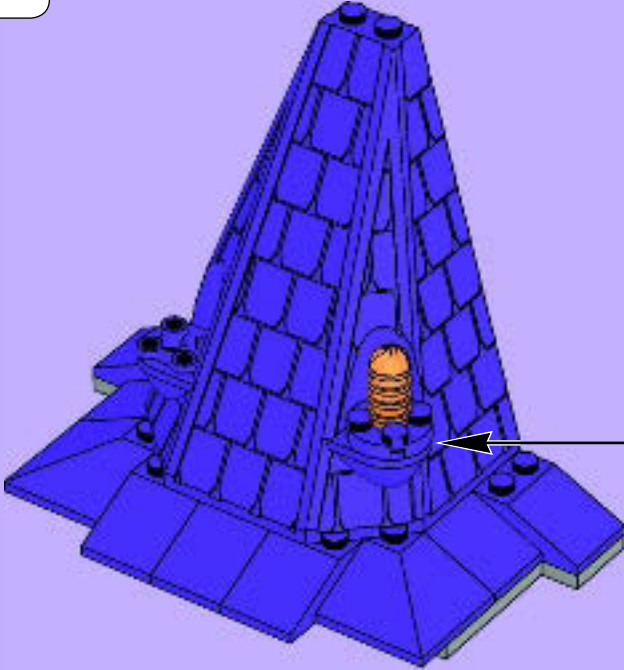

1 2 3

A diagram showing three steps of assembly. Step 1 shows three brown circular pieces being stacked vertically, with red arrows pointing downwards between them. Step 2 shows a brown circular piece being placed on top of the stack from step 1, with a red arrow pointing downwards. Step 3 shows the completed stack of four brown circular pieces being inserted into a blue base with a central hole.



# 12

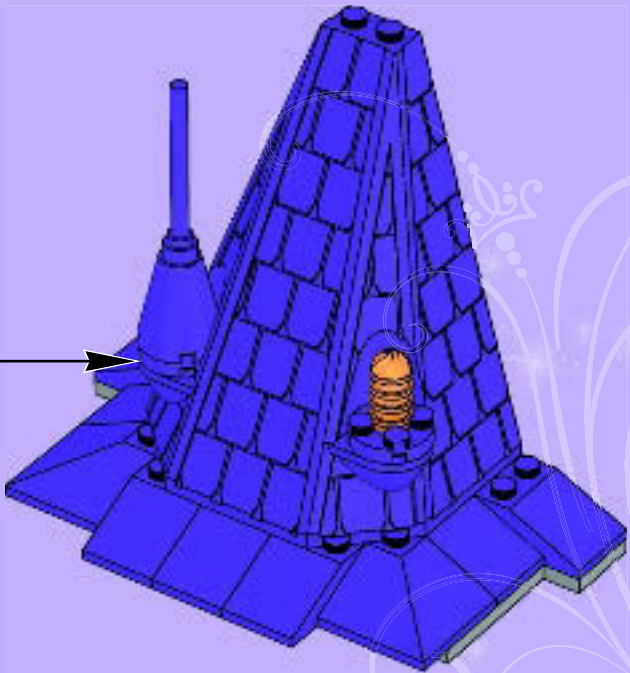
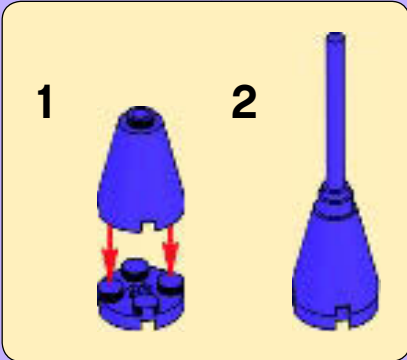



13

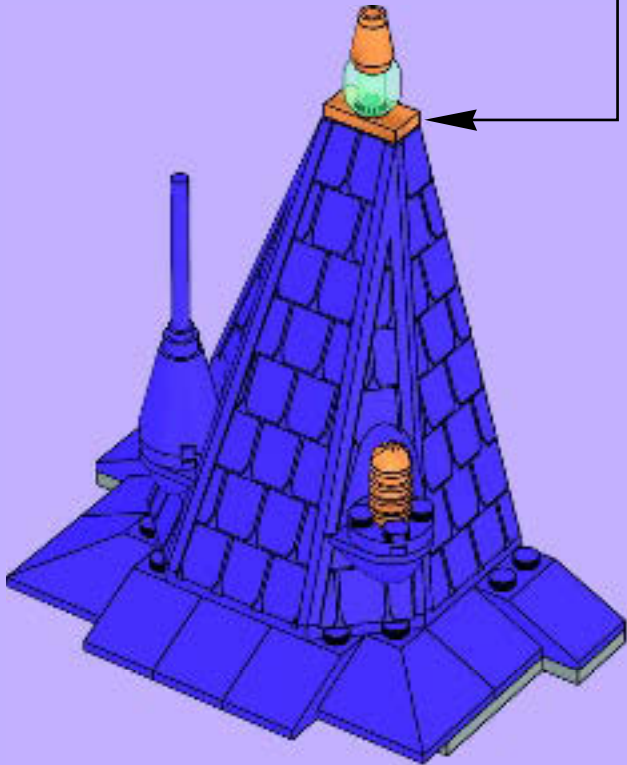
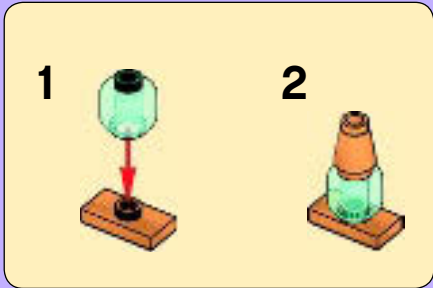



63







# Friends

## Heartlake City



41039



41035



41037



[LEGO.com/friends](http://LEGO.com/friends)



41050

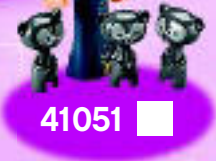

41051

 [LEGO.com/disneyprincess](https://www.LEGO.com/disneyprincess)



41054





41055



41052



41053

 1x  
4518400  
 2x  
4504369  
 2x  
366501  
 2x  
4121932  
 1x  
302001  
 1x  
4293876  
 1x  
4585448  
 1x  
4261470  
 6x  
4109995  
 2x  
4124455  
 2x  
4579260  
 2x  
6024495  
 4x  
4117070  
 2x  
6055868

 2x  
4129996

 1x  
6061062

 2x  
6056230

 2x  
4585486

 1x  
306224

 1x  
614126

 1x  
452826

 1x  
4155558

 1x  
4626934

 1x  
6066376

 1x  
3005747

 1x  
4540865

 4x  
4216625

 1x  
4655611

 2x  
4211150

 2x  
4211189

 2x  
4211190

 1x  
4221590

 2x  
4283660

 1x  
4542131

 1x  
4623429

 2x  
6062574

 4x  
4211183

 1x  
4504376

 2x  
4211199

 2x  
4629736

 2x  
4225532

 2x  
4211636

 4x  
4211412

 4x  
4215472

 2x  
4211488

 1x  
4211435

 1x  
4211445

 1x  
4211401

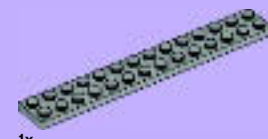
 1x  
4662161

 1x  
4211365

 4x  
4650260

 1x  
6059033

 2x  
4211362

 4x  
4211363

 4x  
4631286

 1x  
4543086

 11x  
4216479

 4x  
6031883

 5x  
4580010

 2x  
4615728

 6x  
6002148

 1x  
4625633

 4x  
6055872



1x  
4568934



1x  
6062100



1x  
6058333



1x  
6064743



1x  
6056845



1x  
6055645



1x  
6017048



1x  
6058297



1x  
6055736



1x  
6062750



1x  
6047551



6x  
4523157



2x  
4490599



1x  
4585493



27x  
4523159



1x  
4541895



1x  
4656153



1x  
4505990



1x  
6050916



1x  
4529247



2x  
6055384



1x  
4620909



2x  
4649741



2x  
6003008



1x  
6023825



1x  
6058368



6x  
4651902



6x  
6062386



1x  
6035703



1x  
6056227



1x  
6056226



4x  
4164037



2x  
4537936



1x  
6023827



1x  
4243784



6x  
4530678



5x  
4249891



2x  
6020073



14x  
4624184



1x  
306221



1x  
4598786



7x  
6055875



2x  
6055877



2x  
6030534



1x  
6064621



3x  
4566607



8x  
6064120



1x  
6057451



1x  
6056448



1x  
306228



2x  
374128



6x  
242328



2x  
4619599



4x  
4119479



1x  
4116671



2x  
6021999

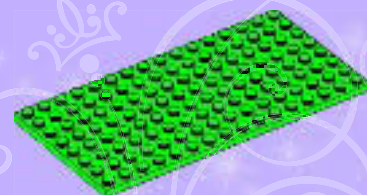

1x  
4610602



**Customer Service**  
**Kundenservice**  
**Service Consommateurs**  
**Servicio Al Consumidor**

**LEGO.com/service or dial**



**: 00800 5346 5555**

**: 1-800-422-5346**



# Win!

Go to [LEGO.com/productfeedback](http://LEGO.com/productfeedback) to fill out a survey for a chance to win a cool LEGO® Product.

No purchase necessary.  
Open to all residents  
where not prohibited.



## [LEGO.com/productfeedback](http://LEGO.com/productfeedback)

### Gewinne!

Nimm an der Umfrage auf [LEGO.com/productfeedback](http://LEGO.com/productfeedback) teil und hab die Chance ein cooles LEGO® Produkt zu gewinnen!

Die Teilnahme am Gewinnspiel führt zu keinerlei Kaufverpflichtungen. Teilnahme in allen nicht ausgeschlossenen Ländern möglich.

### Win!

Ga naar [LEGO.com/productfeedback](http://LEGO.com/productfeedback), vul een enquêteformulier in en maak kans op een cool LEGO® product.

Geen aankoopverplichting.  
Ledereen mag deelnemen, uitgezonderd ingezetenden van landen waar een enquêteverbod geldt.

### Gagne!

Visite [LEGO.com/productfeedback](http://LEGO.com/productfeedback) pour répondre à un questionnaire et avoir une chance de gagner un produit LEGO® très cool!

Aucune obligation d'achat.  
Ouvert à tous les résidents des pays autorisés.

### 当てよう!

[LEGO.com/productfeedback](http://LEGO.com/productfeedback)にアクセスして、アンケートにご記入ください。当選者にはレゴ製品を差し上げます。

お買い上げの必要はありません。  
禁止されていない限り、すべての皆様にご利用いただけます。

 [LEGO.com](http://LEGO.com)

6074750 / 6074751

LEGO and the LEGO logo are trademarks of the/son des marques de commerce de/son marcas registradas de LEGO Group. ©2014 The LEGO Group. © Disney