

# CITY

4209



**WARNING:** CHOKING HAZARD.  
Toy contains small parts and a small ball.  
Not for children under 3 years.



**AVERTISSEMENT : RISQUE D'ÉTOUFFEMENT.**  
Le jouet contient des petites pièces ainsi qu'une petite boule.  
Il ne convient pas aux enfants de moins de 3 ans.



**ADVERTENCIA: PELIGRO DE ASFIXIA.**  
Juguete que contiene partes pequeñas y una pelota pequeña.  
No recomendado para niños menores de 3 años.

1

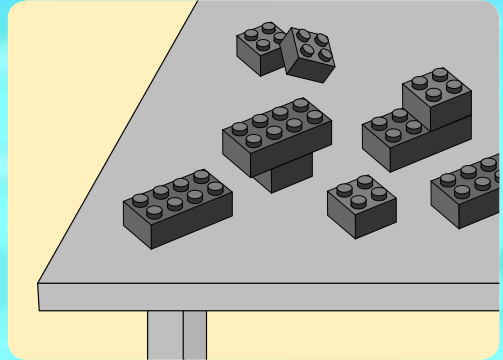
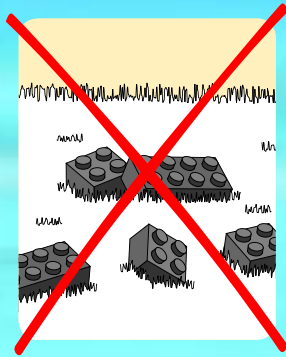

2





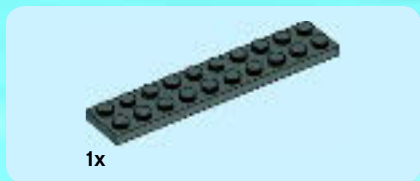

1x

1

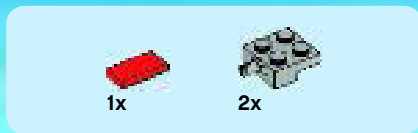
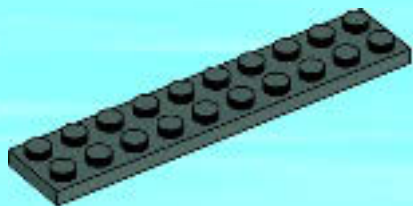

2

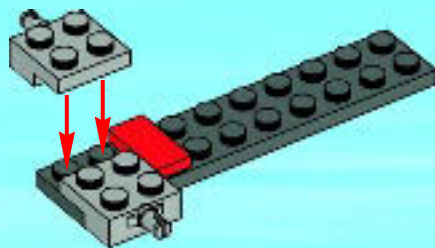



1x

3

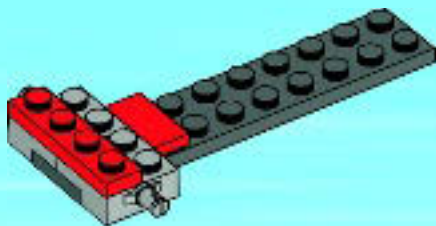

6



1x

4

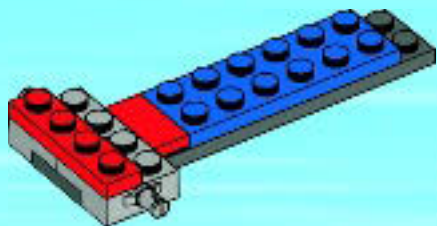

2x

5

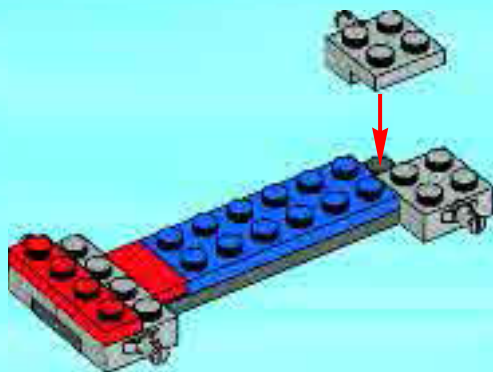



1x



1x

6

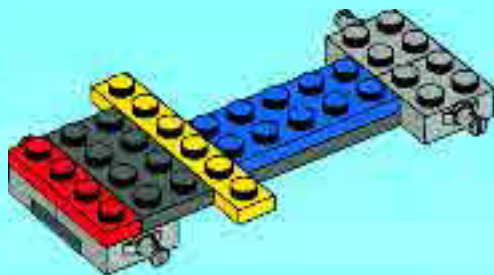



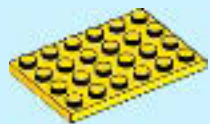

1x



1x

# 7

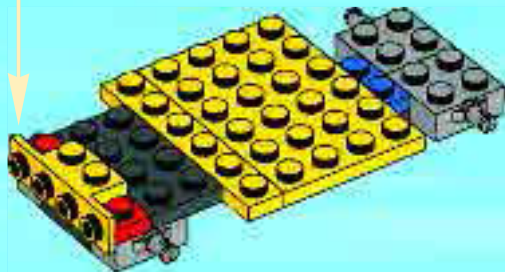

1x



1x

# 8

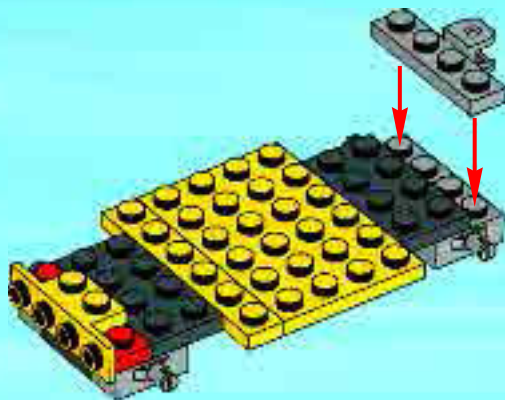



1x



1x

9

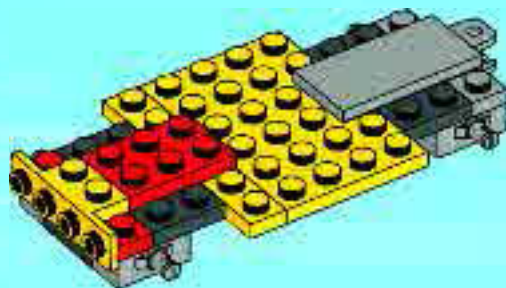

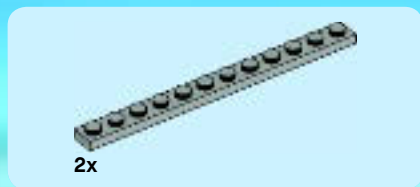

10

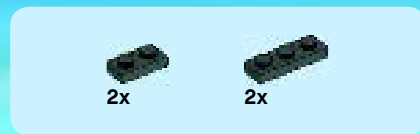
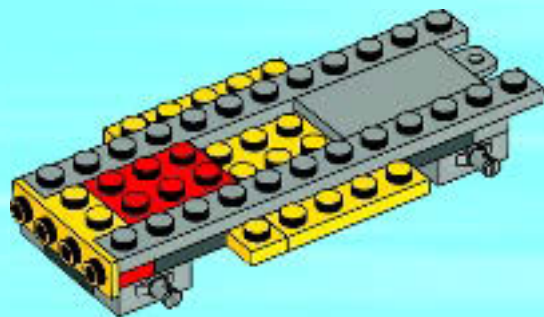

11

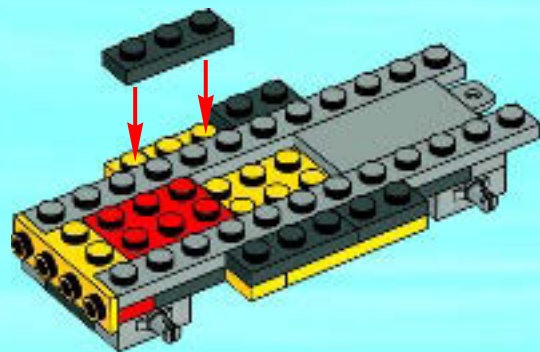



1x



1x

# 12

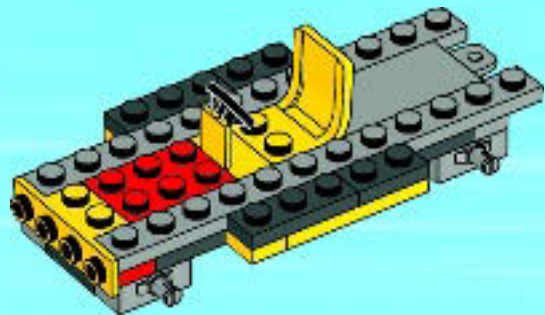

12



1x



2x

# 13

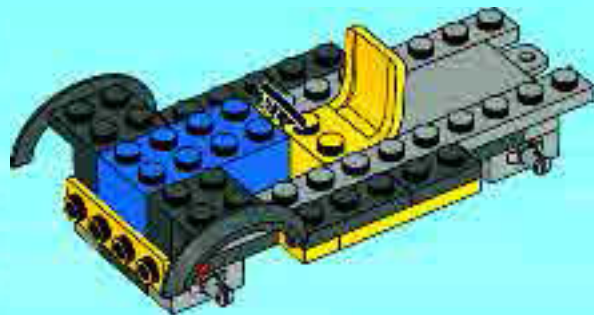



2x

14

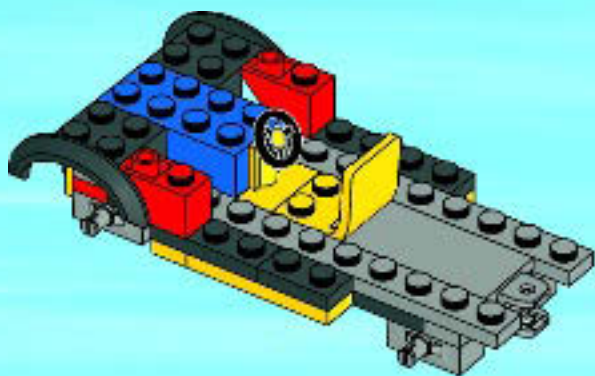



2x

15

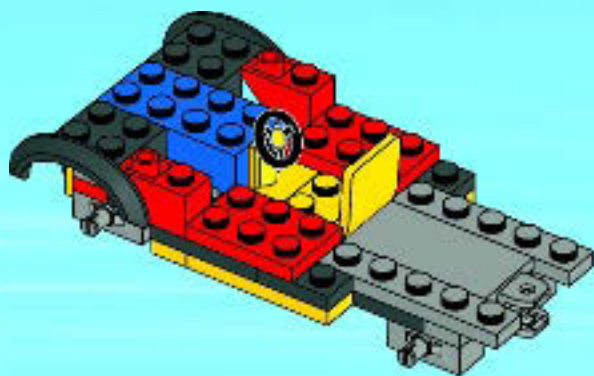



2x

16

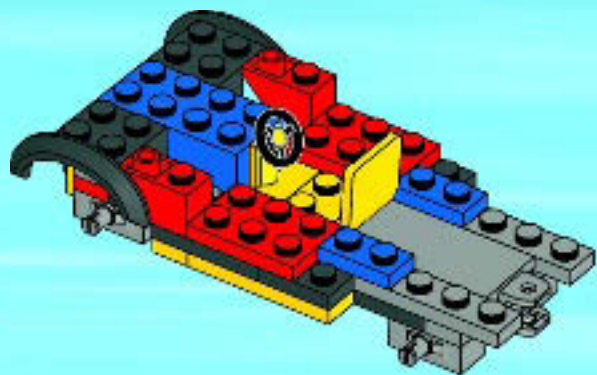

2x

17

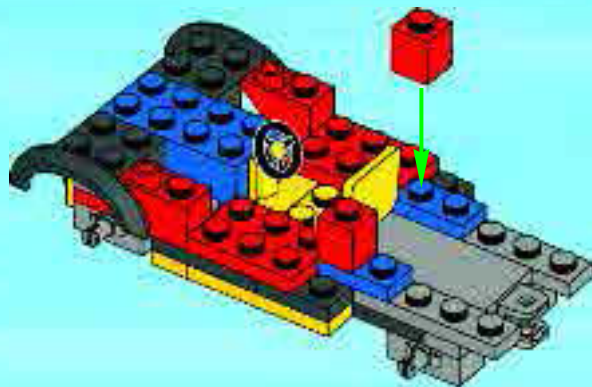



2x

18

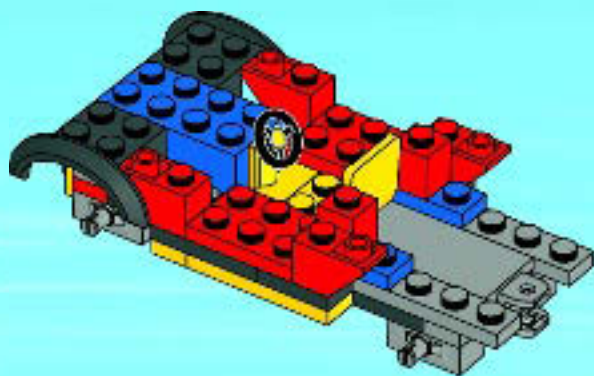





2x

19

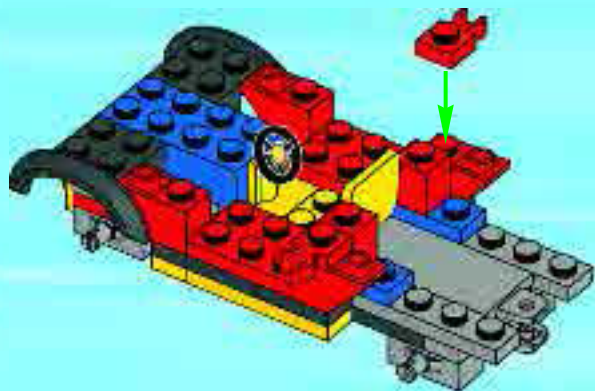

2x

20

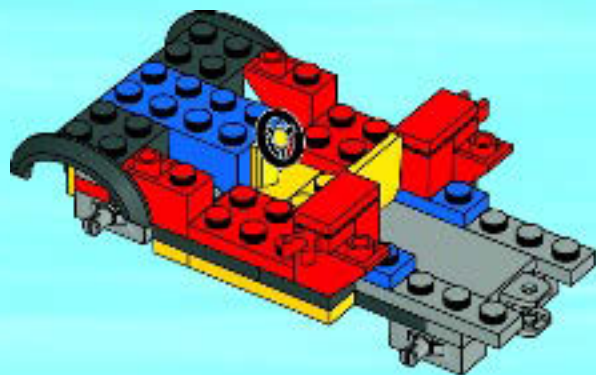



1x

21

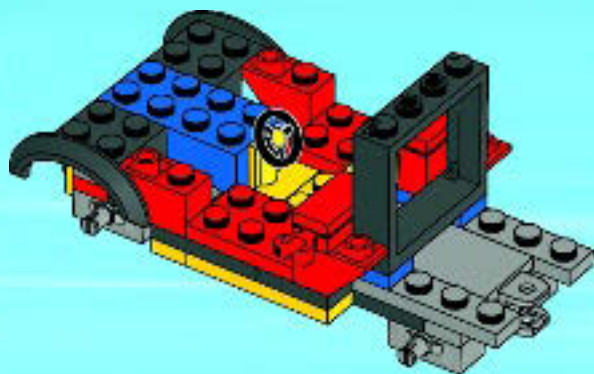

2x

22

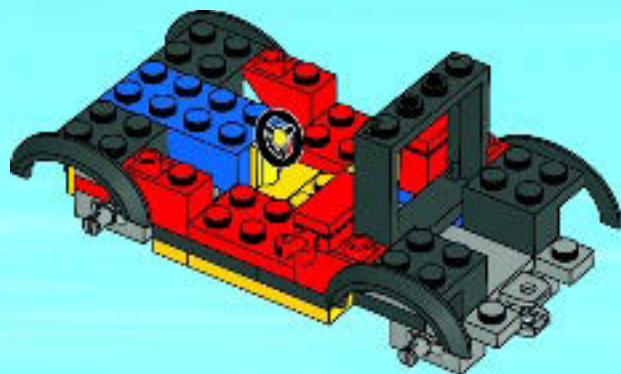



23

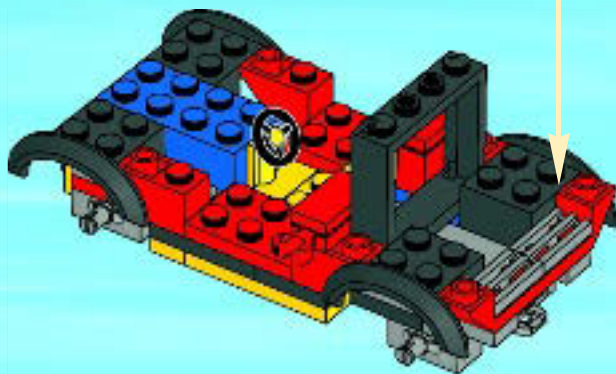
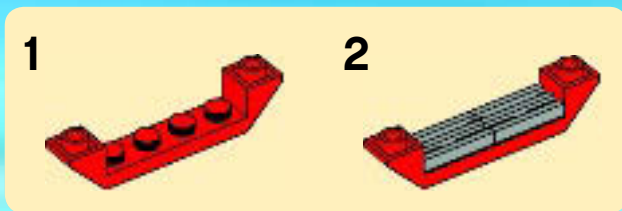



2x

24

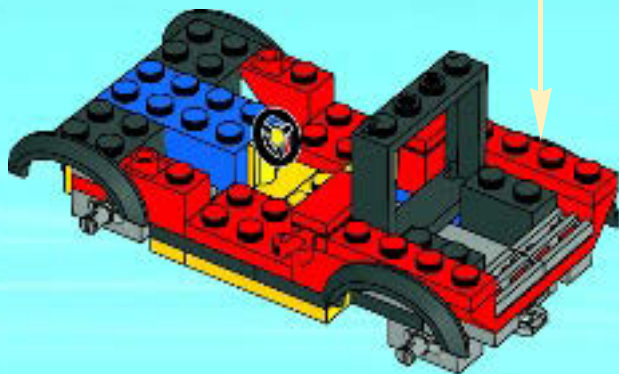



2x

# 25

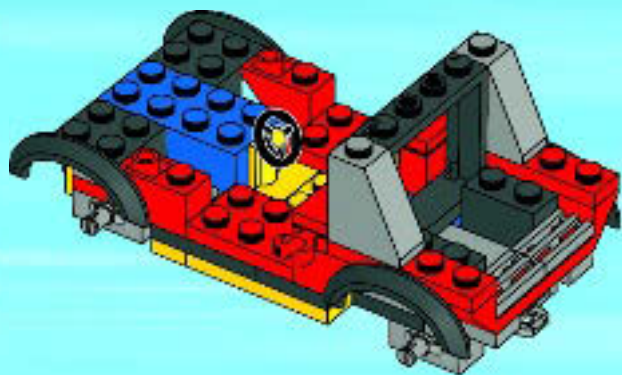

1x



1x

# 26

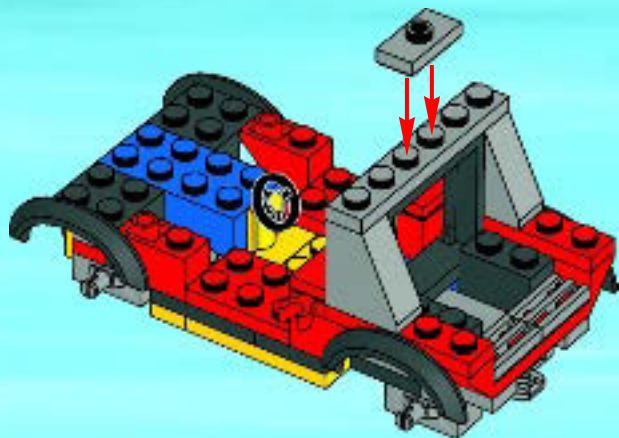



2x



1x

# 27

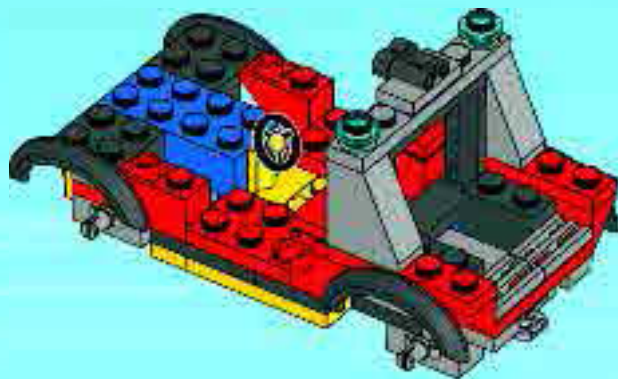



1x

# 28

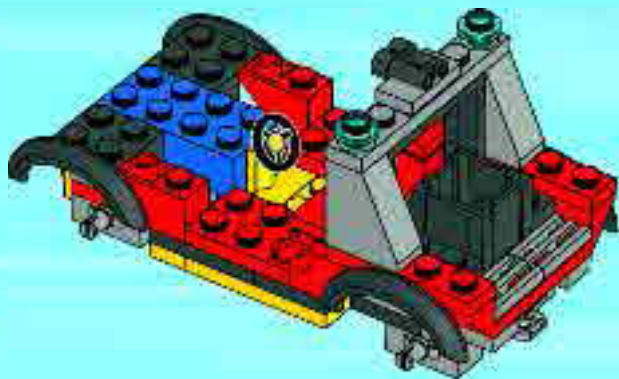

1x



1x

# 29

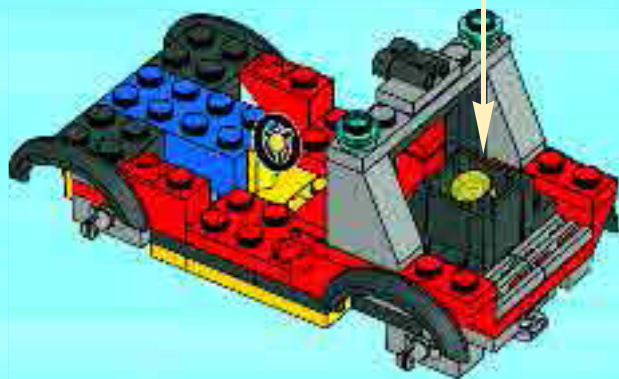



1x



1x



1x

# 30

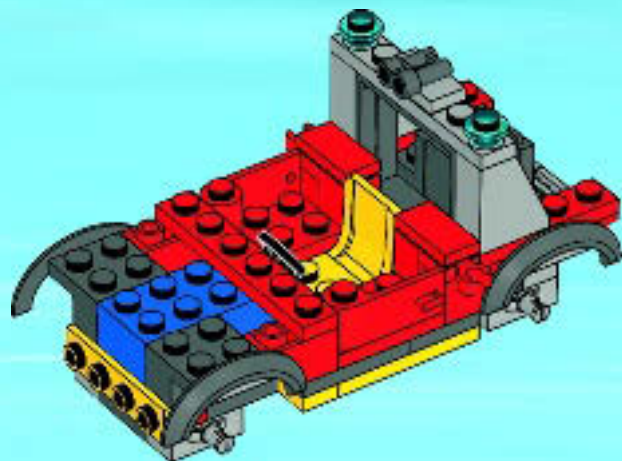





1x

# 31

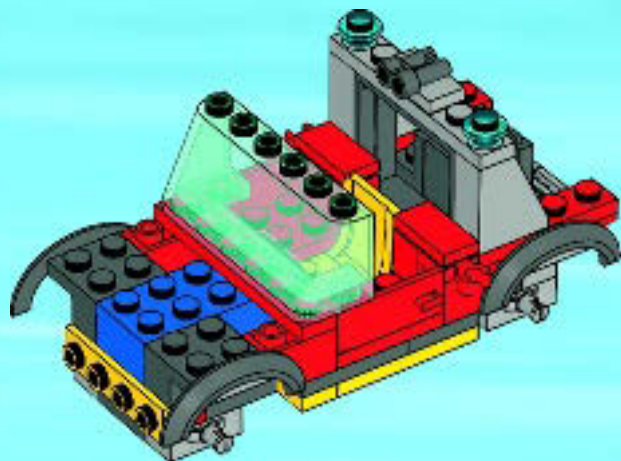

1x



1x



1x

# 32

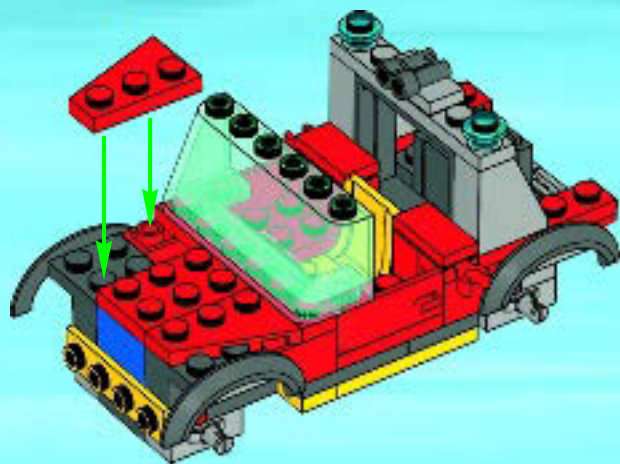



1x



1x

# 33

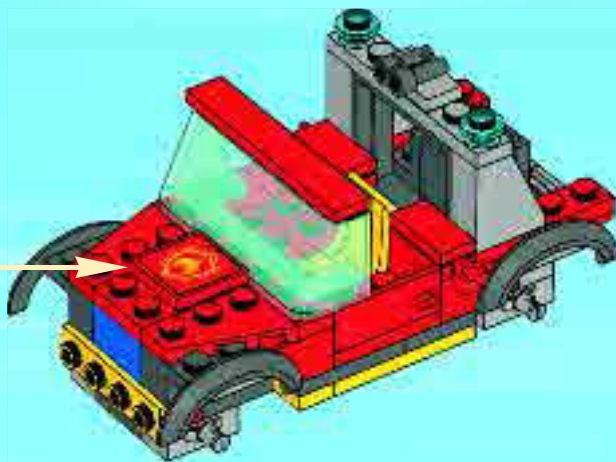

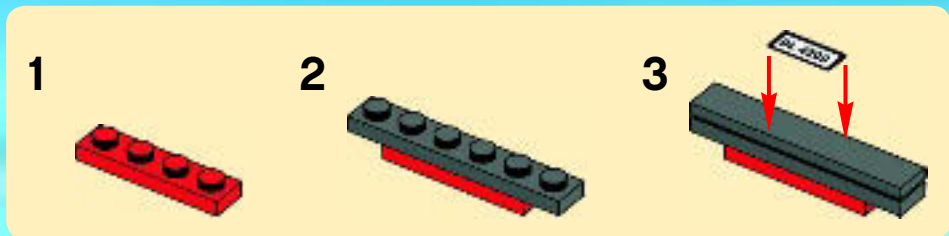
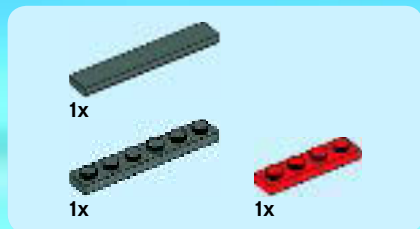

34

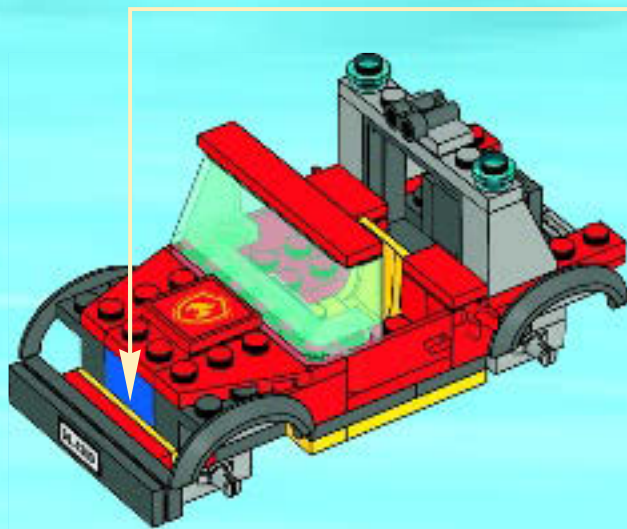



2x



2x



2x



1x



2x



1x



1x

# 35

## 1



## 2

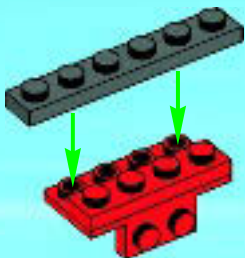

## 3

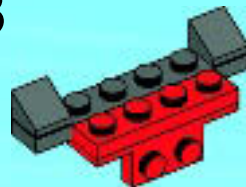

4

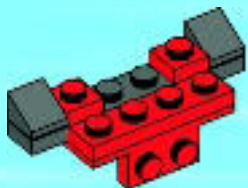

5

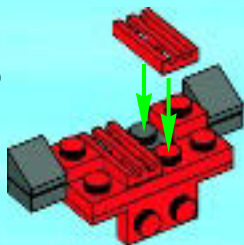

6



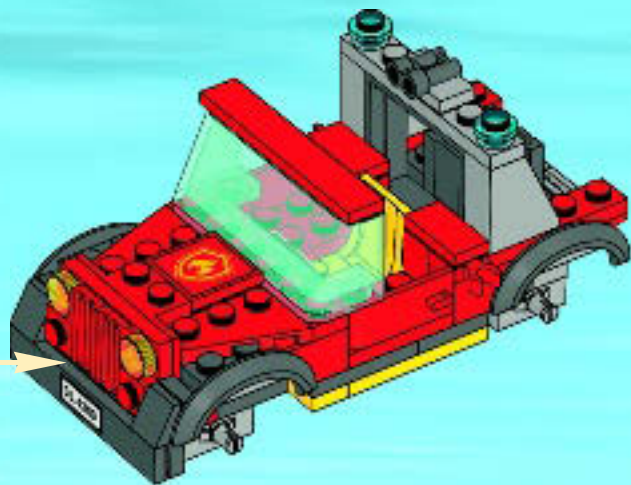



1x



1x

# 36

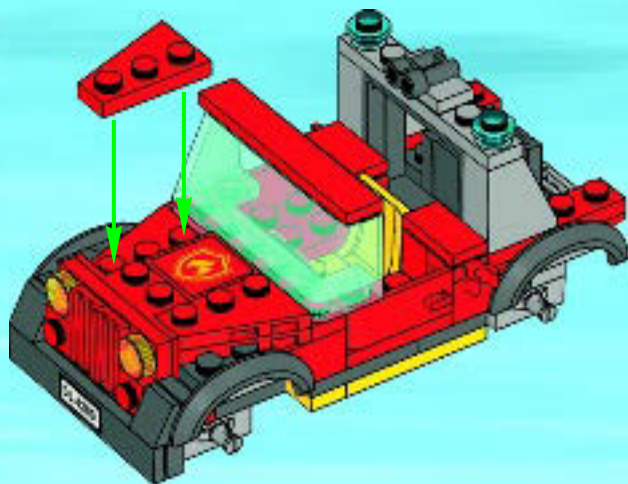



4x



4x

# 37

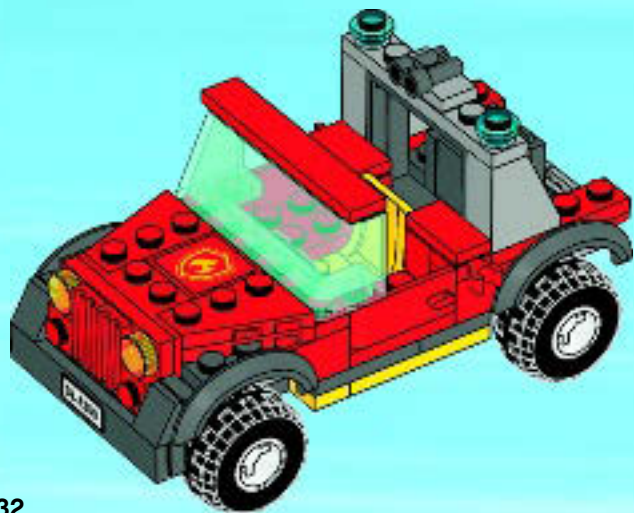

32



1x



1x

# 38

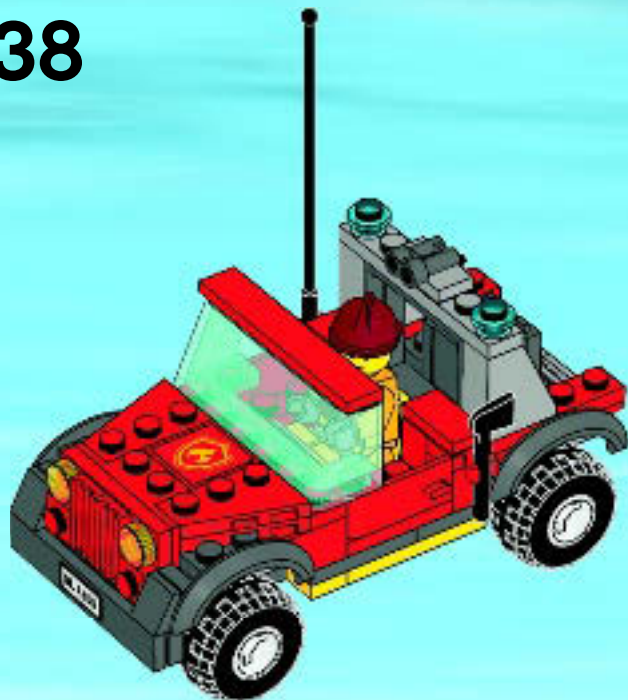





1x



1x

1

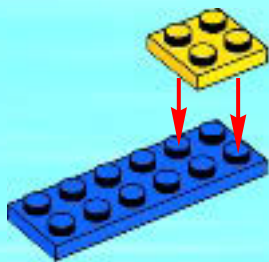

1x



2x

2

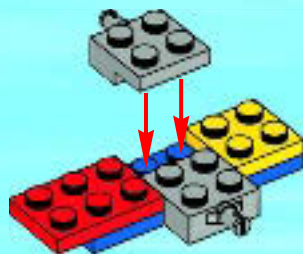



1x

3





2x



1x

4

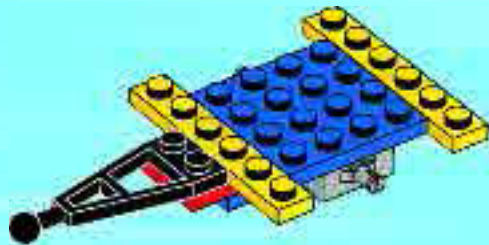

1x



1x

5

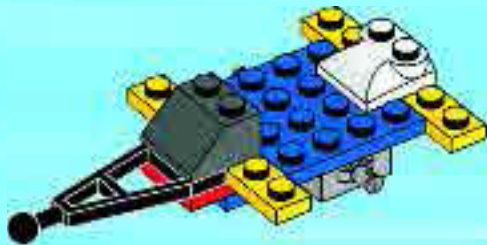



4x

6

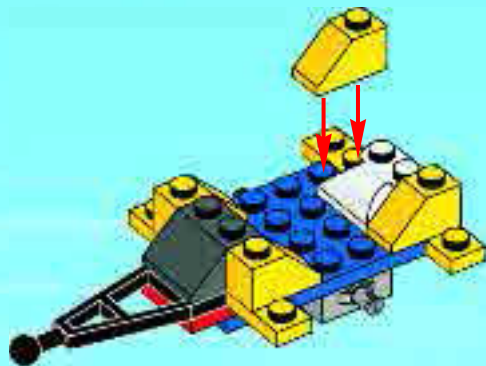



1x



2x



1x

# 7

1



2



3





4x

8





2x

9



1x

10

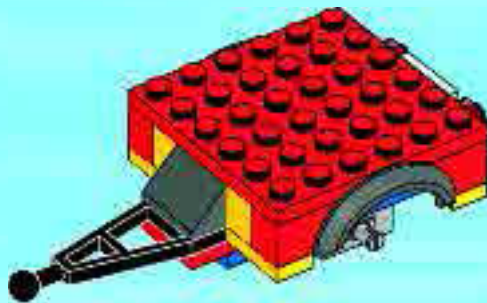



1x



1x

# 11

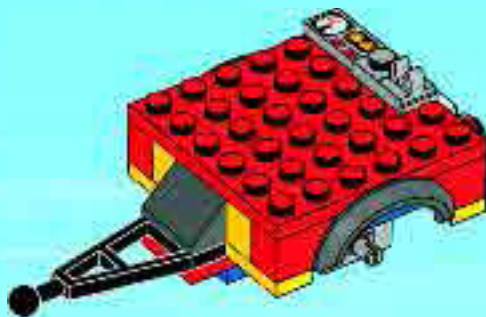





1x



2x

# 12

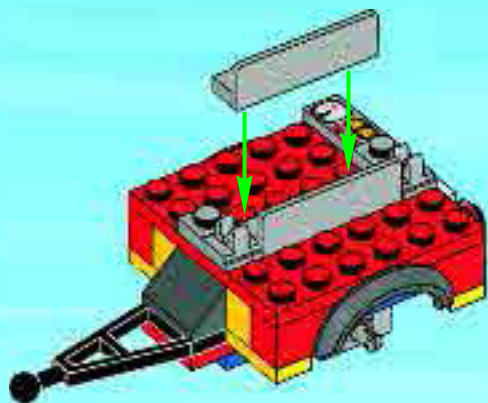

1x



1x



1x

# 13

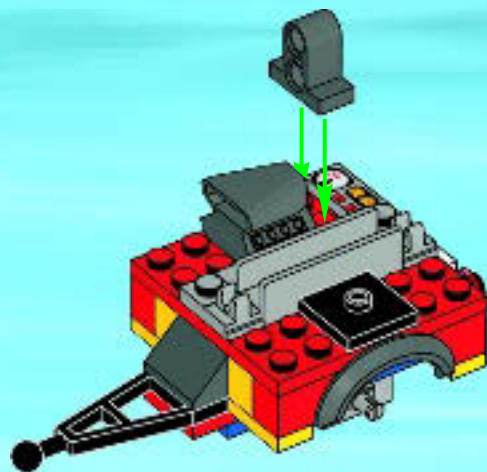

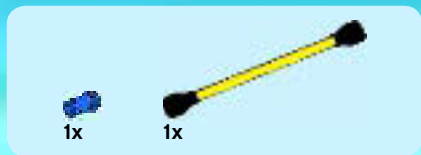

14

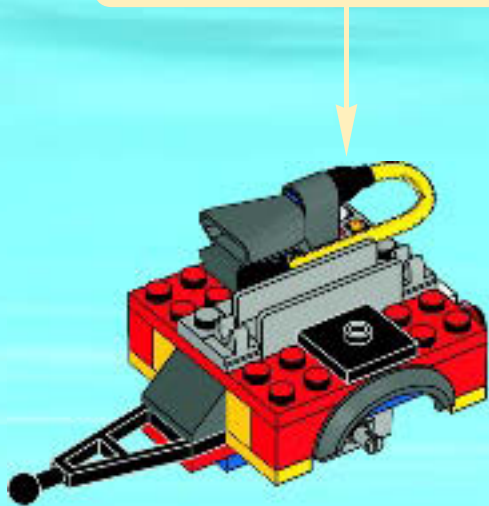
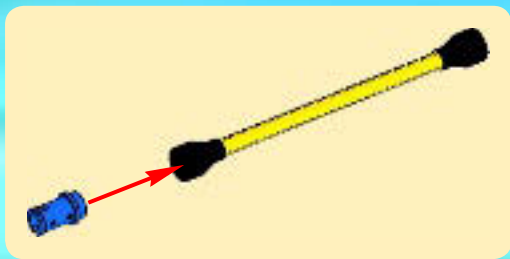

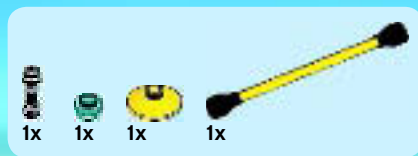

15

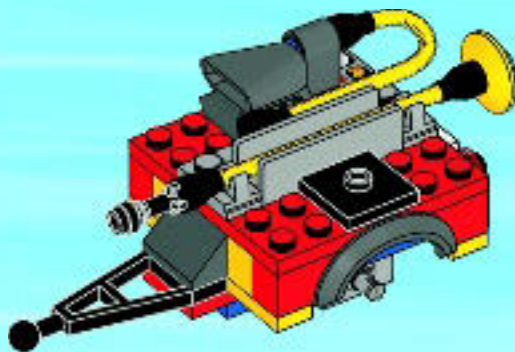
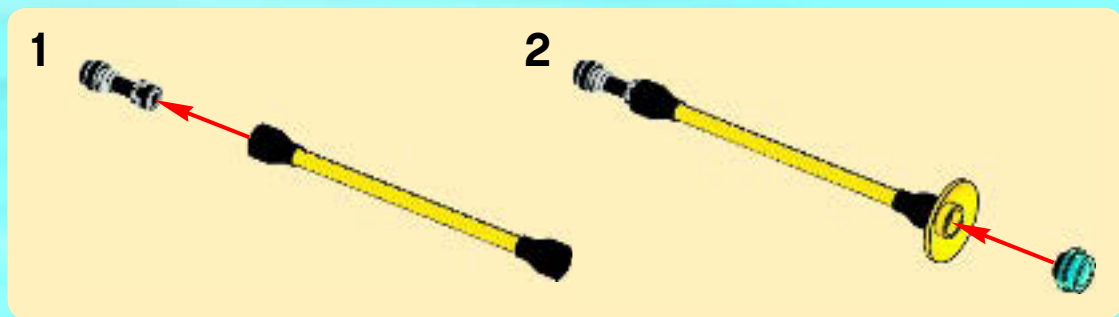



1x



1x



1x



2x

# 16

1

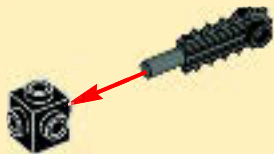

2

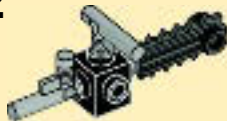

3

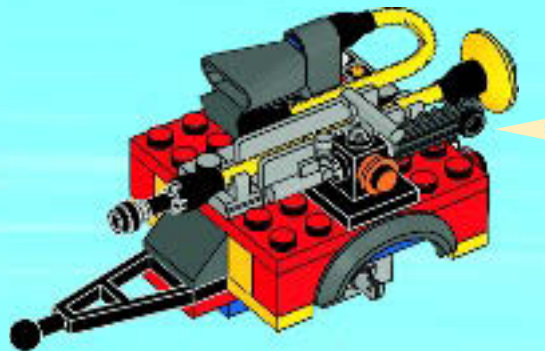



2x



2x

# 17



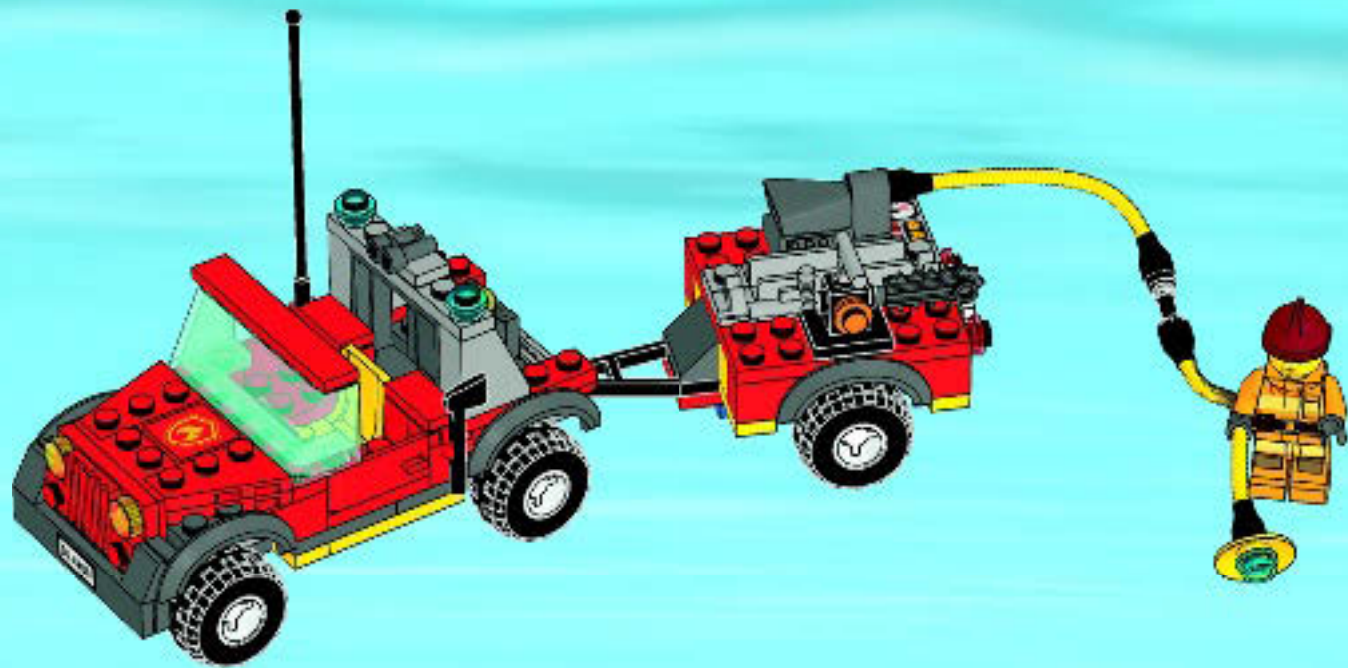



2



2x

1

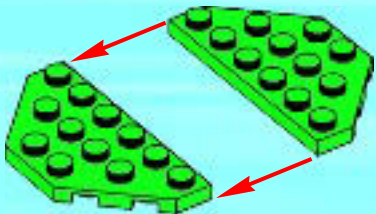

1x

2

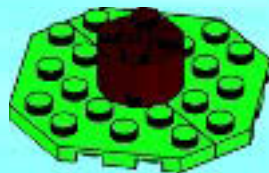



4x

3

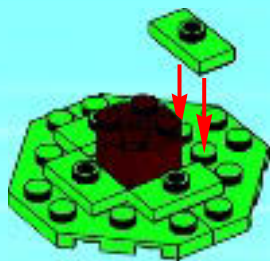

4x

4







1x

5

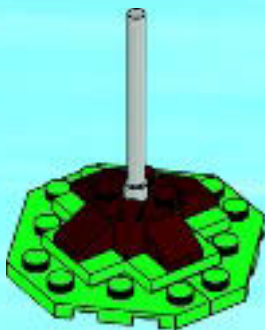

3x

6

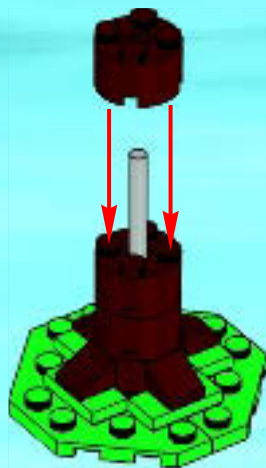



1x

7



4x

8

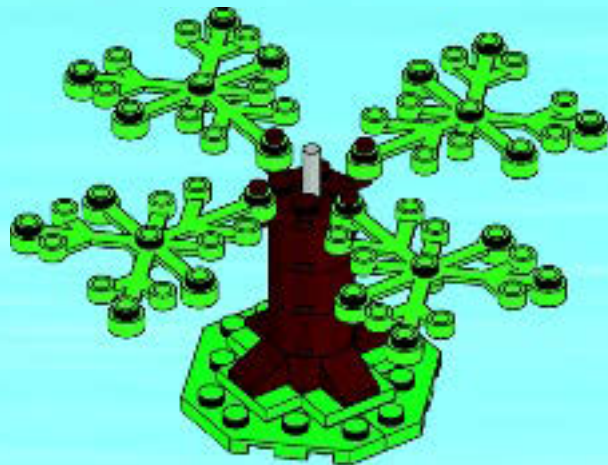



2x

9

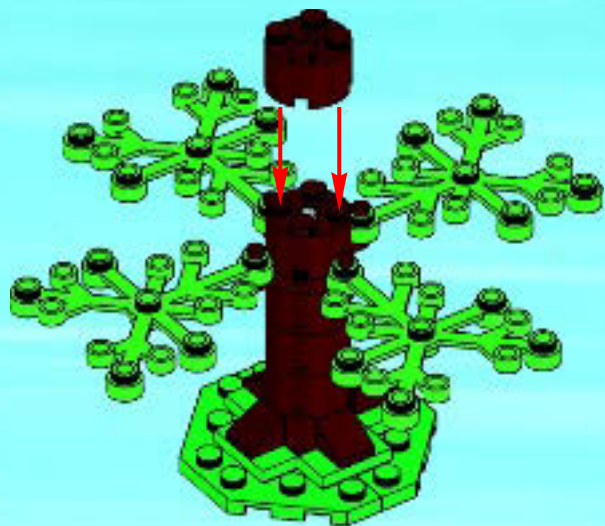

1x

10

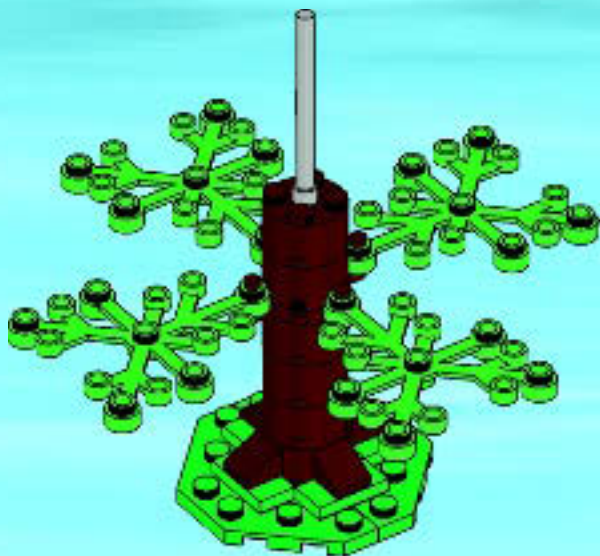



# 11

1



2



3





2x

12

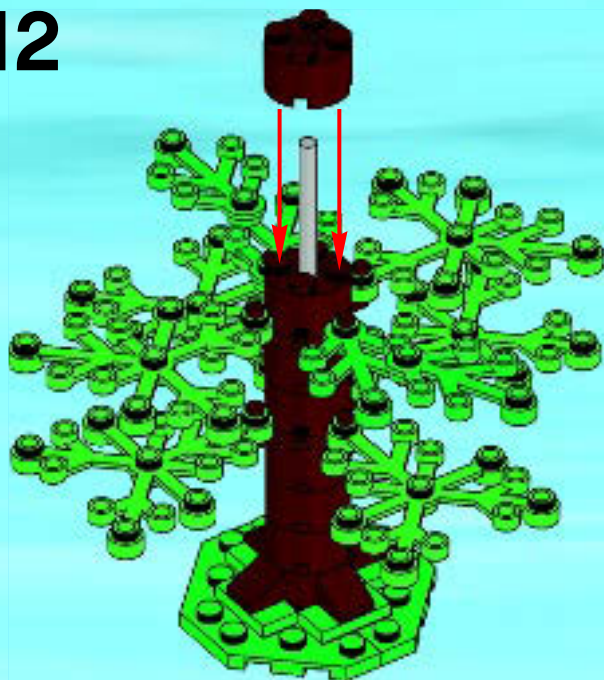



1x



4x

# 13

1



2

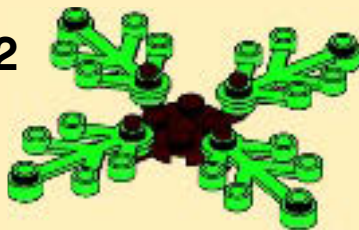





1x

14

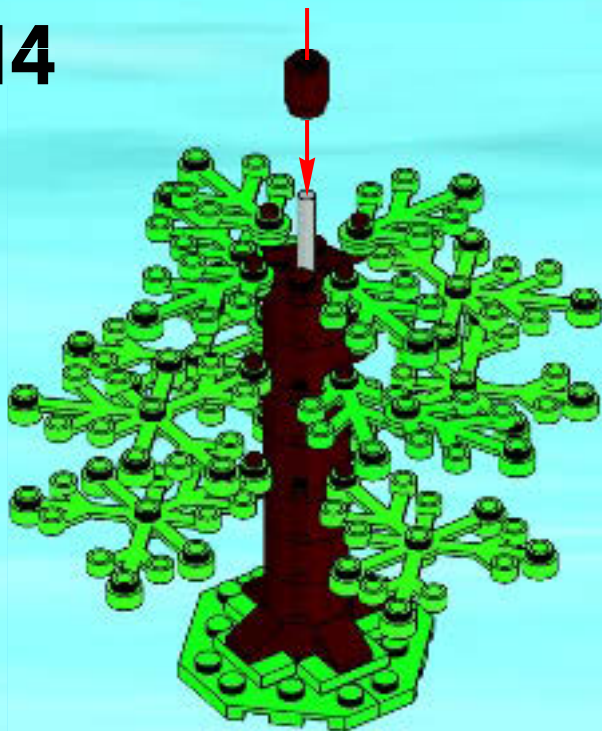
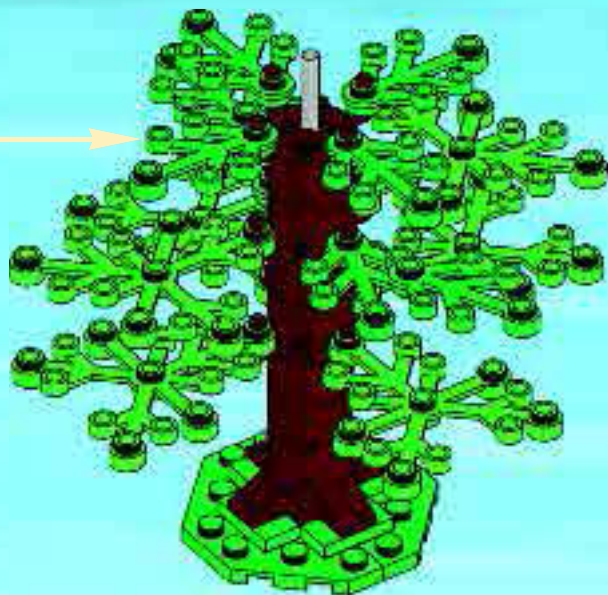



1x

15

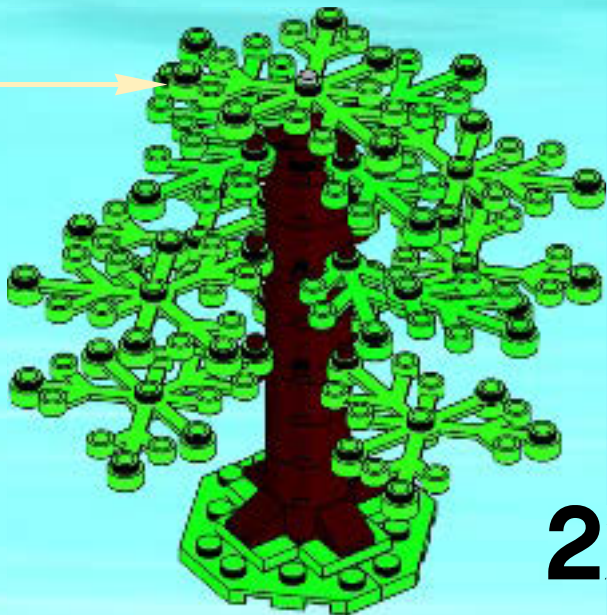

2x





10x

16



10x

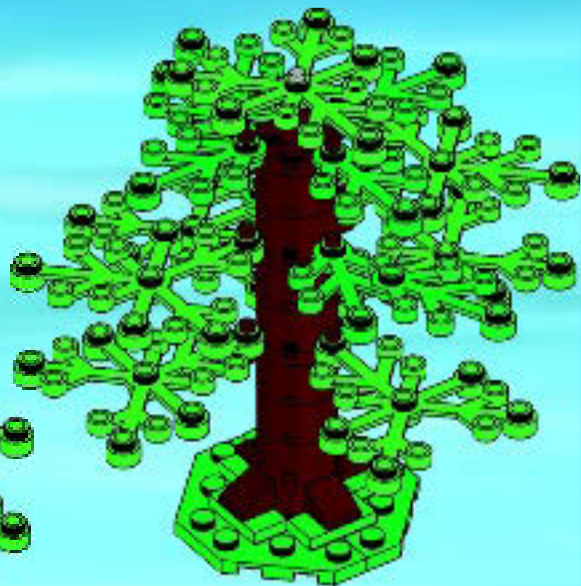
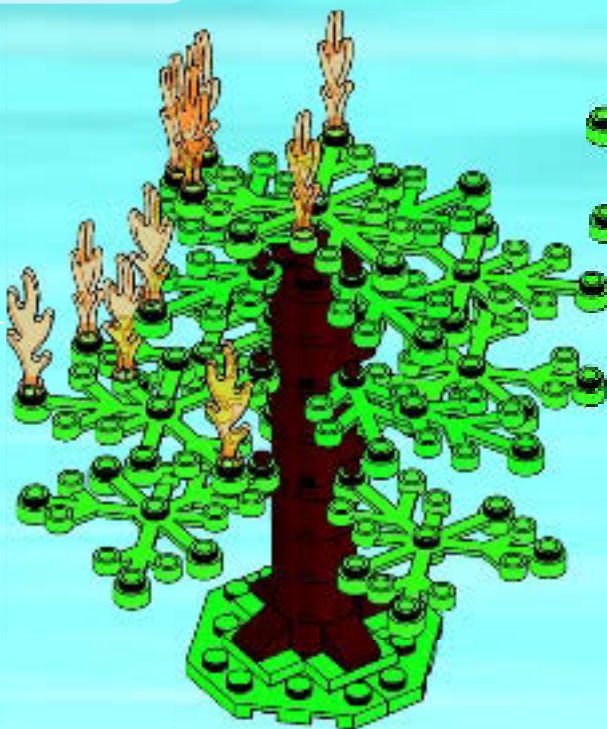

**LEGO** CITY



4209



4208



4427





[www.LEGOclub.com](http://www.LEGOclub.com)



LEGO® Club Email



LEGO® Club Magazine

**LEGO** club™

**FREE! GRATIS! GRATUIT!**

**SIGN UP ONLINE!**

**[www.LEGOclub.com](http://www.LEGOclub.com)**



**00800 5346 5555\***



**1-866-534-6258 • 1-877-518-5346**

REG Canada only

Canada seulement

- \* Freephone. Mobile charges may apply.
- \* Numéro sans frais. Des frais peuvent s'appliquer avec les téléphones cellulaires.
- \* Gebührenfrei, Kosten für Anrufe aus Mobilfunknetzen können abweichen.
- \* Gratis telefoonnummer vanaf vaste lijn.
- \* Det er et gratis nummer, når du ringer fra fasttelefon.
- \* Det är gratis, när du ringer från en fast telefon.
- \* Numéro sans frais. Des frais peuvent s'appliquer avec les téléphones portables.



# WIN!

Go to [www.LEGOsurvey.com/product](http://www.LEGOsurvey.com/product) to fill out a survey for a chance to win a cool LEGO® Product.

No purchase necessary.

Open to all residents where not prohibited.



## [www.LEGOsurvey.com/product](http://www.LEGOsurvey.com/product)

### GEWINNE!

Nimm an der Umfrage auf [www.LEGOsurvey.com/product](http://www.LEGOsurvey.com/product) teil und hab die Chance ein cooles LEGO® Produkt zu gewinnen!

Die Teilnahme am Gewinnspiel führt zu keinerlei Kaufverpflichtungen. Teilnahme in allen nicht ausgeschlossenen Ländern möglich.

### WIN!

Ga naar [www.LEGOsurvey.com/product](http://www.LEGOsurvey.com/product), vul een enquêteformulier in en maak kans op een cool LEGO® product.

Geen aankoopverplichting. Iedereen mag deelnemen, uitgezonderd ingezetenden van landen waar een enquêteverbod geldt.

### GAGNE!

Visite [www.LEGOsurvey.com/product](http://www.LEGOsurvey.com/product) pour répondre à un questionnaire et avoir une chance de gagner un produit LEGO® très cool!

Aucune obligation d'achat. Ouvert à tous les résidents des pays autorisés.

### 当てよう!

[www.LEGOsurvey.com/product](http://www.LEGOsurvey.com/product) にアクセスして、アンケートにご記入ください。当選者にはレゴ®製品を差し上げます。

お買い上げの必要はありません。禁止されていない限り、すべての皆様にご利用いただけます。



[www.LEGO.com](http://www.LEGO.com)

6015562

LEGO and the LEGO logo are trademarks of the/son des marques de commerce de/son marcas registradas de LEGO Group. ©2012 The LEGO Group.