

The LEGO logo is displayed in its characteristic white font with a black outline, set against a red square background.

4625



WARNING: CHOKING HAZARD.
Small parts. Not for children under 3 years.

⚠ AVERTISSEMENT : RISQUE D'ÉTOUFFEMENT.
Contient des petites pièces. Ne convient pas aux enfants de moins de 3 ans.

⚠ ADVERTENCIA: PELIGRO DE ASFIXIA.
No recomendado para niños menores de 3 años. Contiene piezas pequeñas.

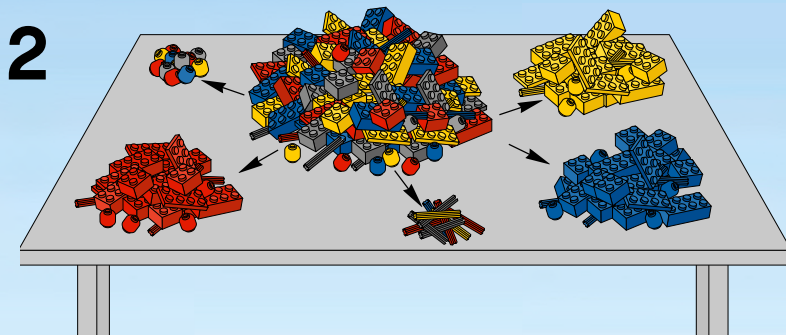
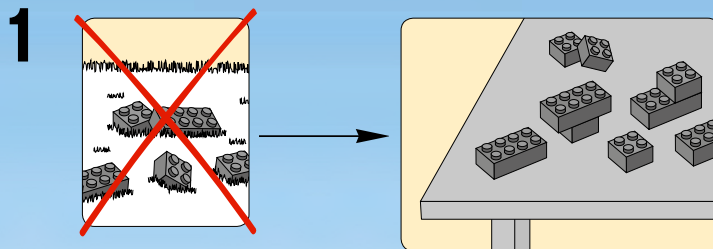

NEW BRICK SEPARATOR INCLUDED.
Loosens and separates bricks from a plate.

NOUVEAU SÉPARATEUR DE BRIQUES INCLUS.
Détache et sépare les briques d'une plaque.

INCLUYE UN NUEVO SEPARADOR DE BLOQUES.
Permite aflojar y separar los bricks unidos a una placa.

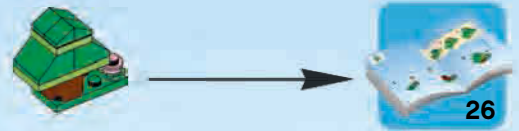
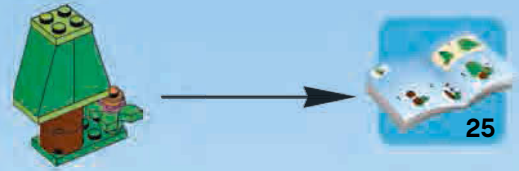
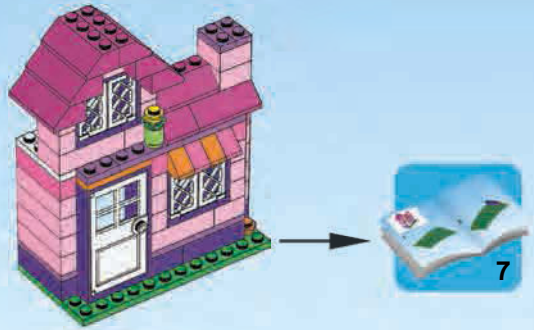
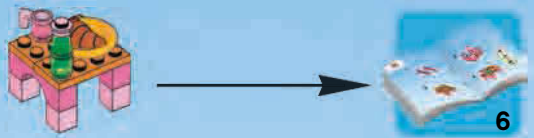

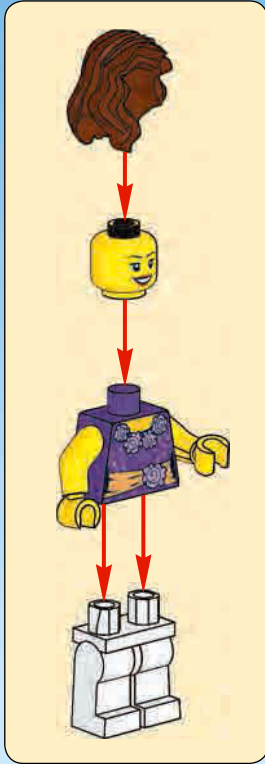

4



1

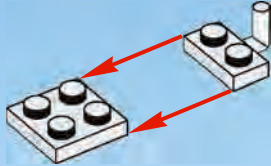

2

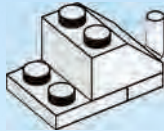

3

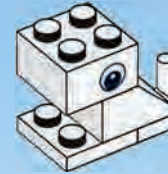

4

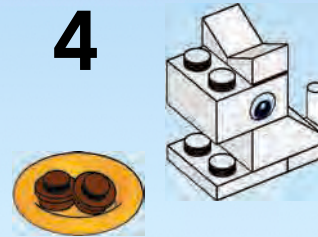

5



1

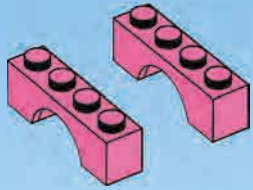

2

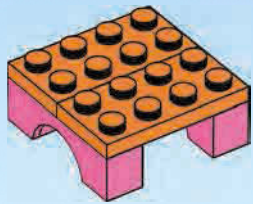

3

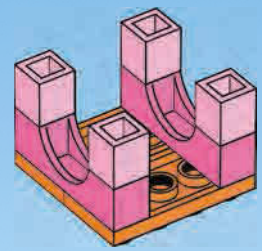

4

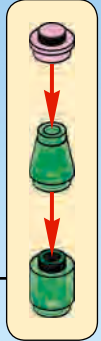
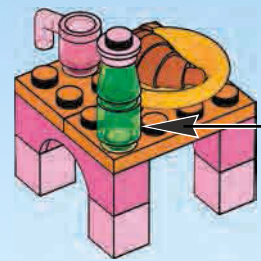



1

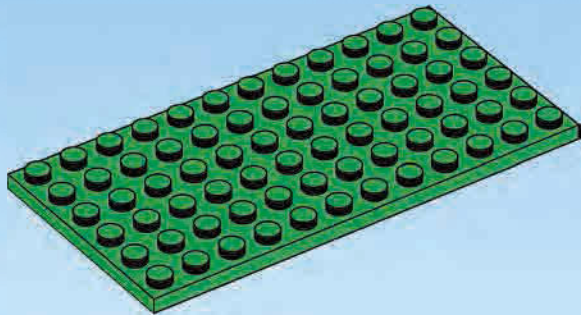

2

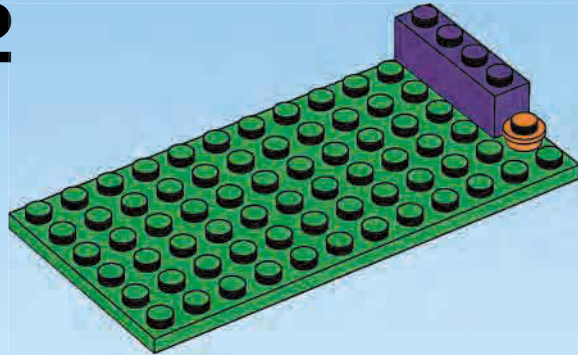

3

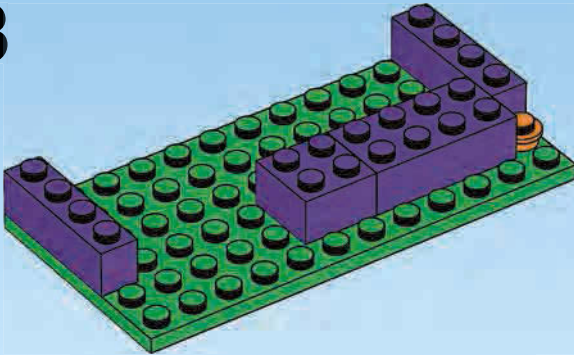

4

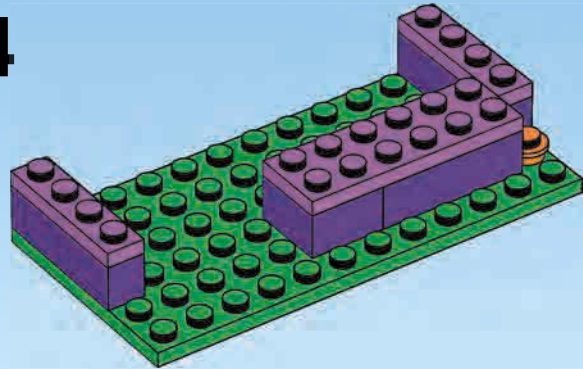

8

5

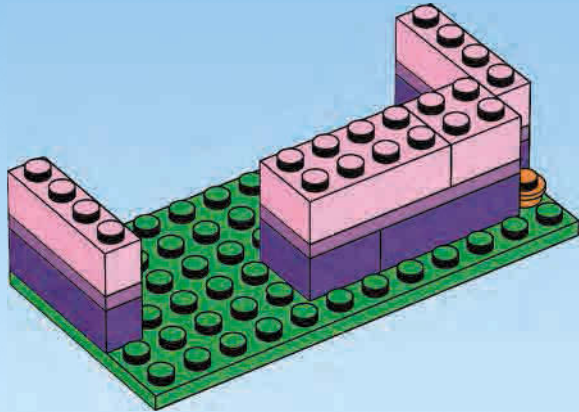

6

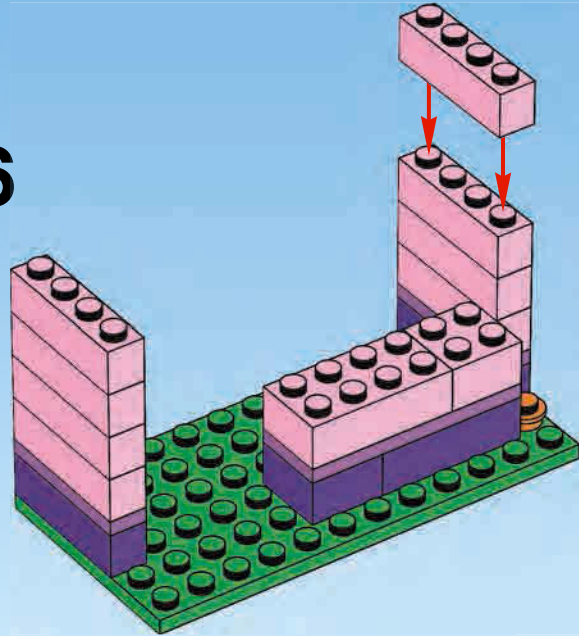

7

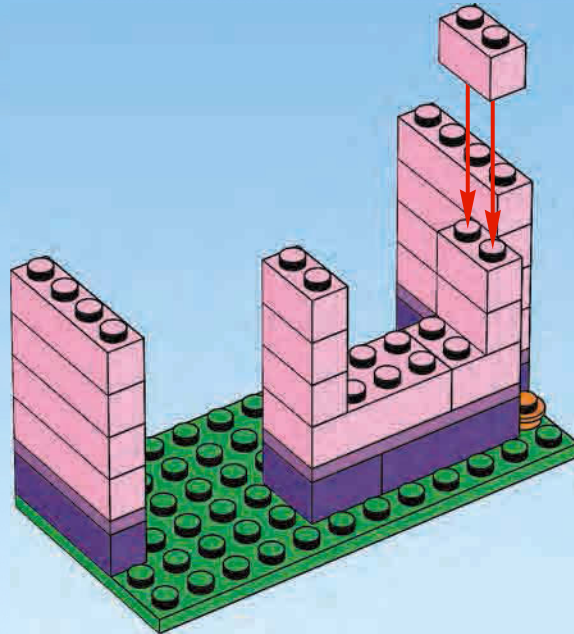

10

8

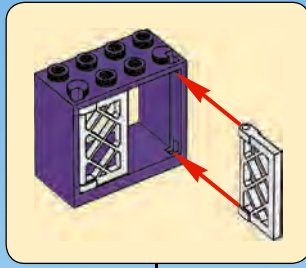
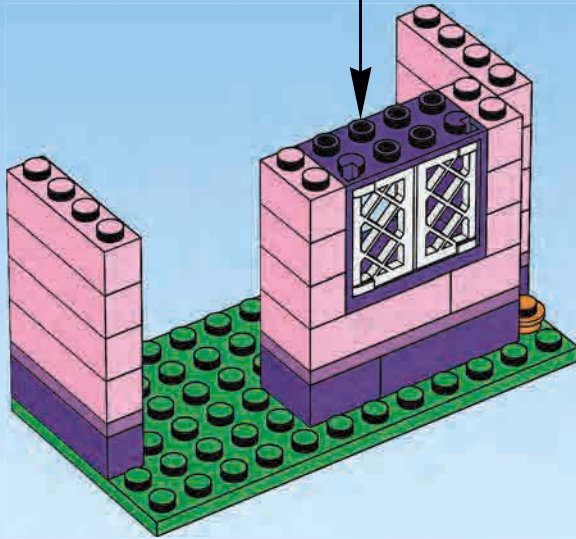

9

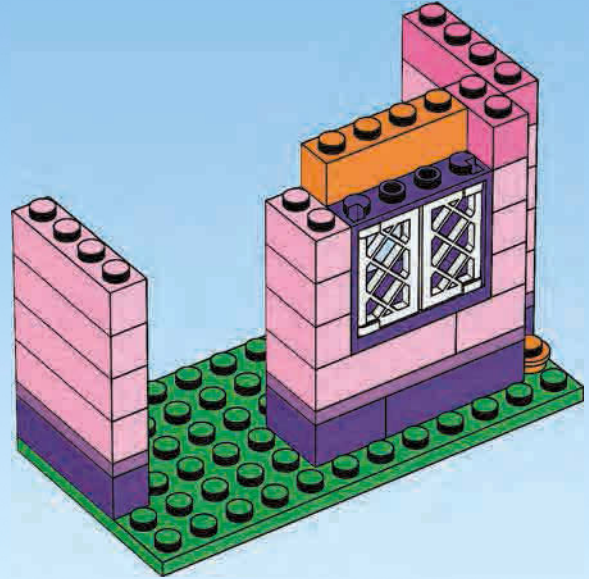

11

10

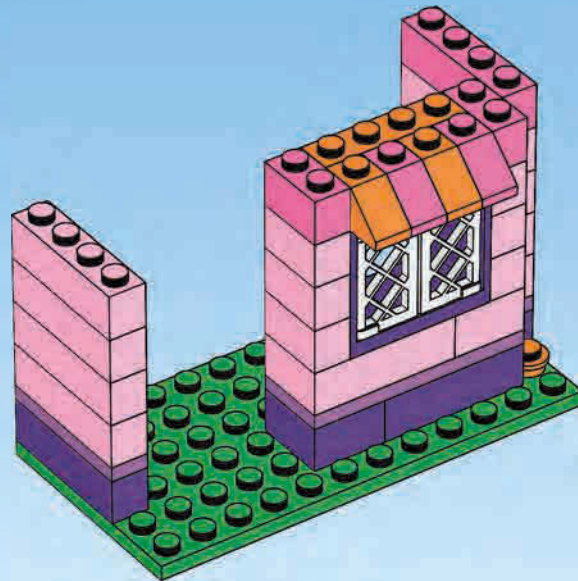

12

11

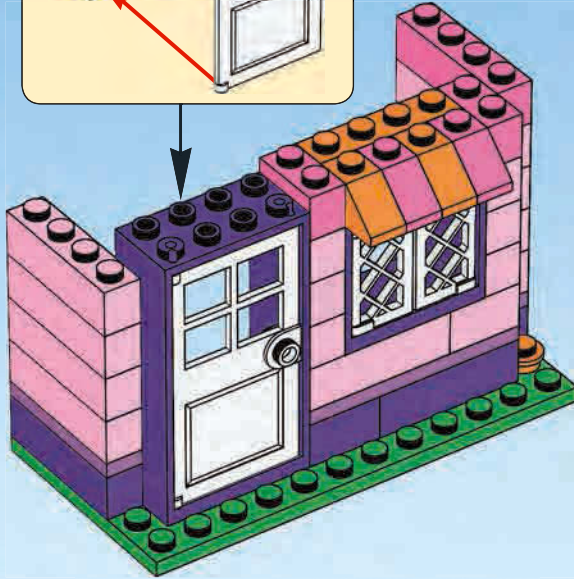
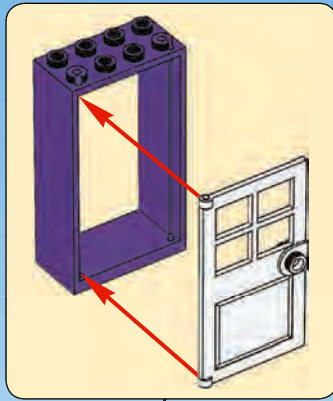

12



13

13



14

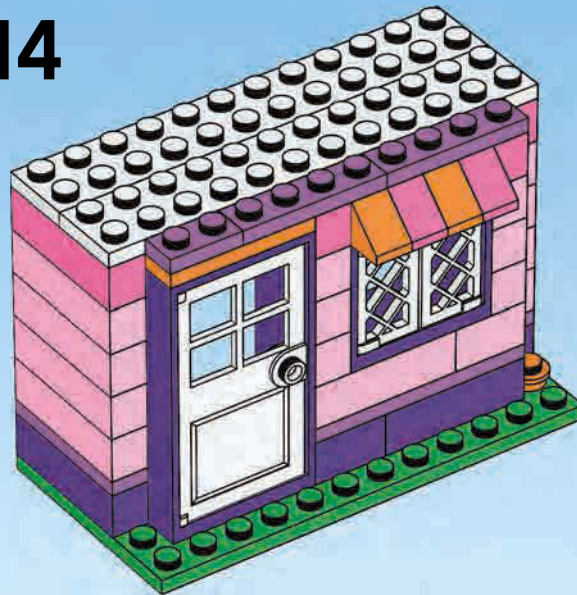

14

15



16



15

17



18



16

19



20

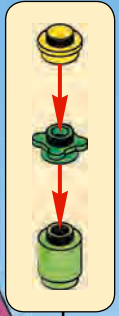
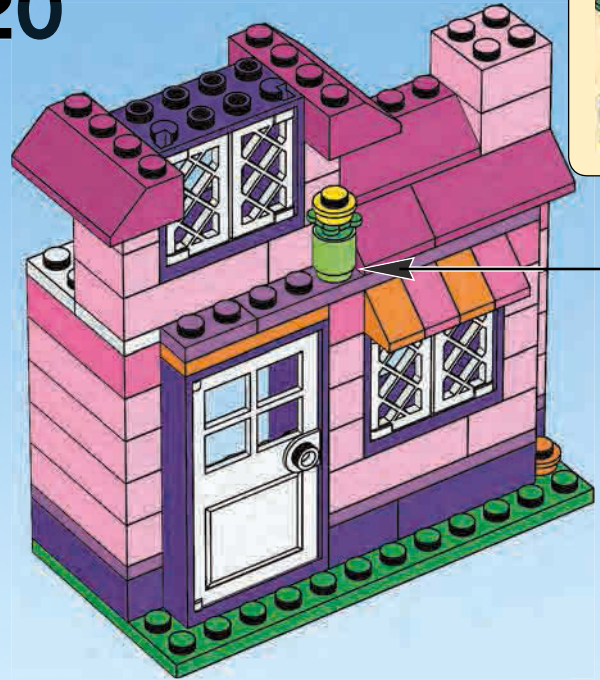

21

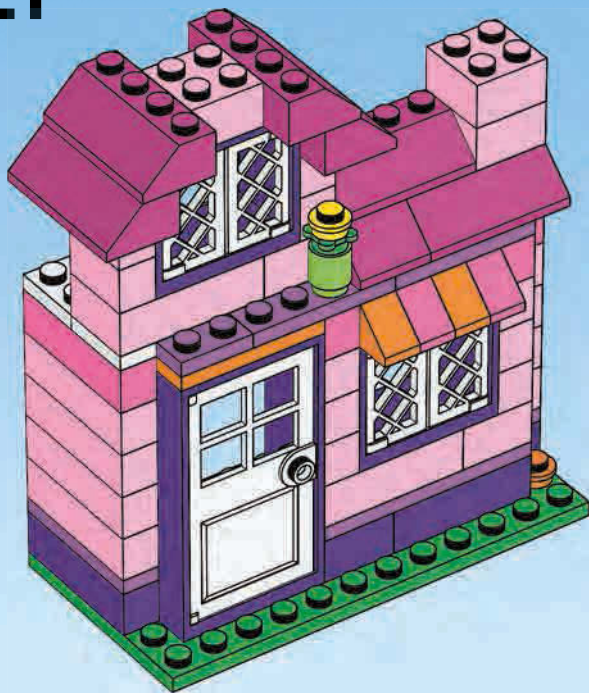

22

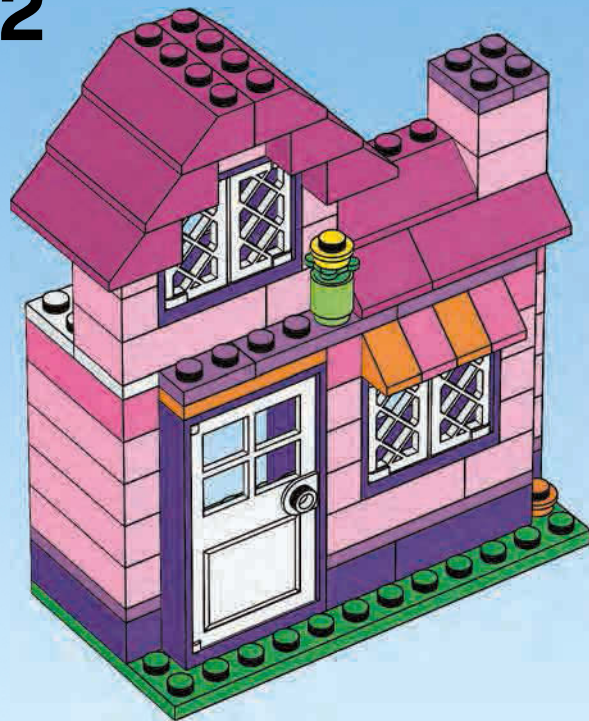

18



1

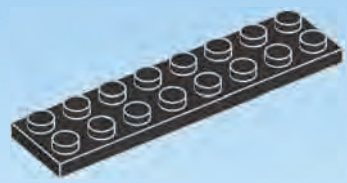

2

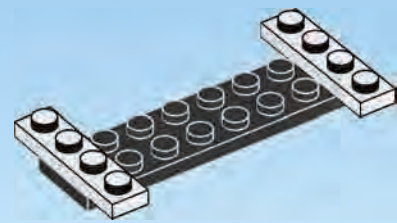

3

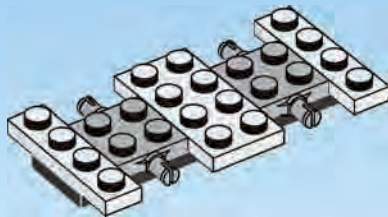

4

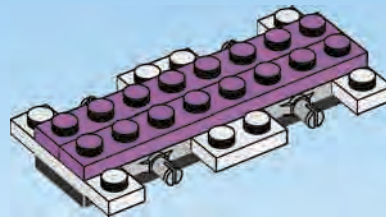

5

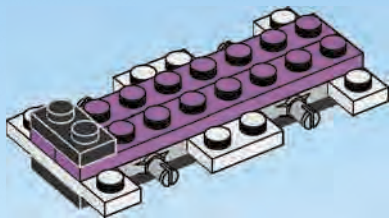

6

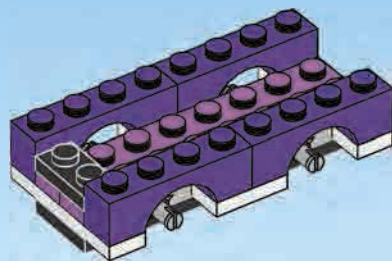

7

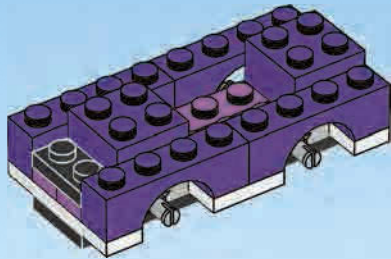

1

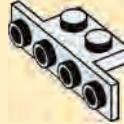

2

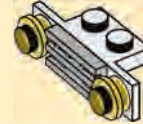

8

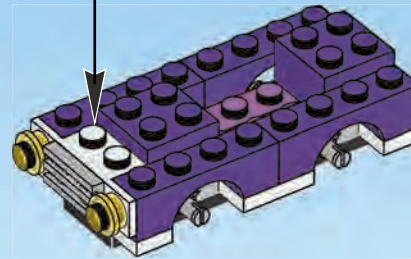

9

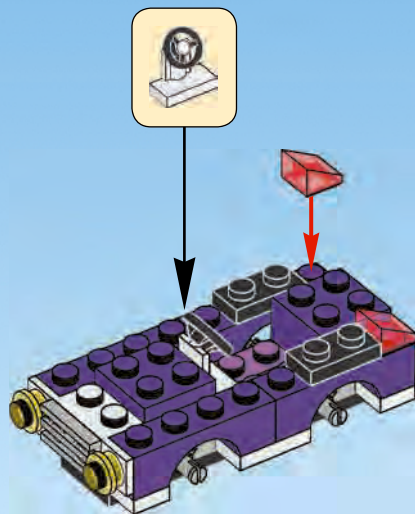

10

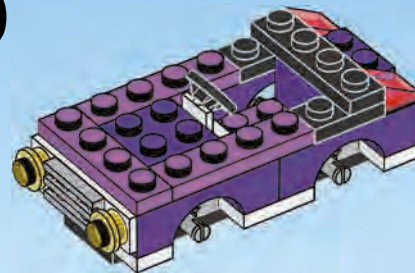

11

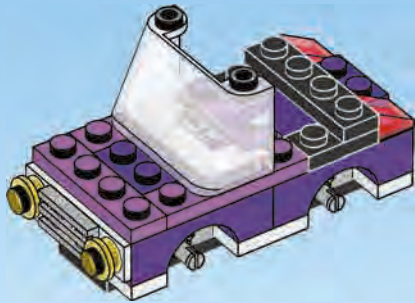

12

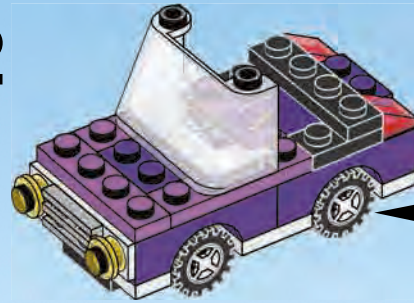

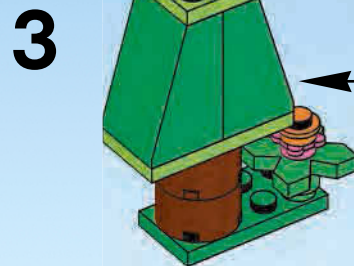
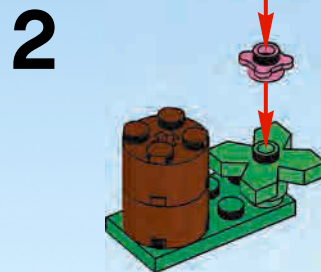
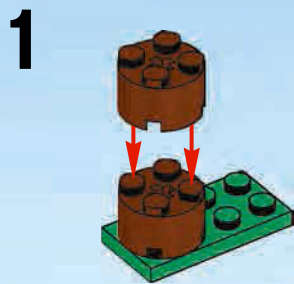
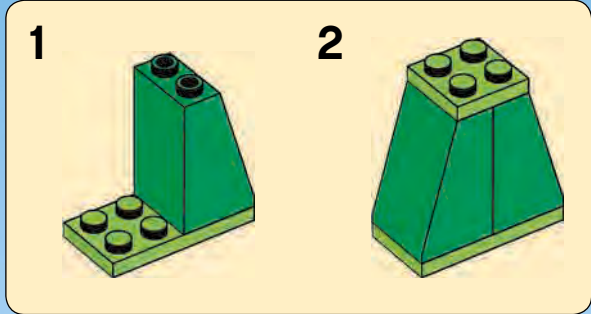

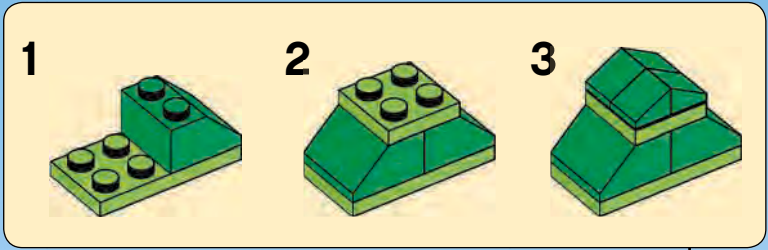

1

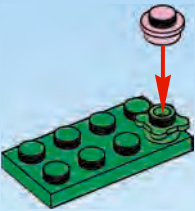

2

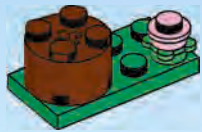

3

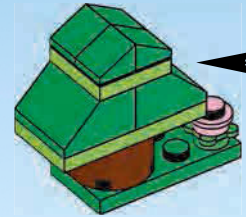



creative.LEGO.com







5560



3936



3061



3942



4626



4637



626



6177





1x
4569079



2x
4504369



1x
303901



2x
4520970



4x
302301



1x
302201



2x
371001



1x
302001

30



2x
244501



1x
4611700



1x
4282737



4x
4538968



2x
4247139



1x
4521943



2x
6000019



1x
9327



4x
462401



1x
9551



4x
614124



1x
4651443



4x
302326



1x
371026



1x
303426



4x
4578677



4x
4546705



2x
303928



2x
4220027



2x
302028



1x
4541414



4x
4619599



2x
4143562



1x
4273743



1x
382340



2x
4244363



2x
3005744



1x
3006848



1x
4567333



4x
4118787



4x
4118827



2x
4121967



3x
4158355

4x
4157103



1x
4654448



1x
4143404



2x
4212454



2x
4537937



2x
4537936



1x
4504850



4x
4550362



10x
4518889



2x
4243920



3x
4211166



2x
4216581



1x
4550736



1x
4211350



2x
4211504



4x
4492224



4x
4621545



4x
4618655



4x
4621542



2x
4518891



2x
4244613



4x
4216479



4x
4286050



10x
4517993



5x
4550359



8x
4518890



4x
4520632



4x
4517996



4x
4640739



4x
4653960



4x
4640611



4x
4626935



4x
4656482



1x
4656624



2x
4656625



1x
4656499



4x
4619512



9x
4619524



2x
4625027



2x
4625022



Customer Service
Kundenservice
Service Consommateurs
Servicio Al Consumidor

www.lego.com/service or dial



: 00800 5346 5555

: 1-800-422-5346



Win!

Go to www.LEGOsurvey.com/product
to fill out a survey for a chance
to win a cool LEGO® Product.
No purchase necessary.
Open to all residents where not prohibited.



www.LEGOsurvey.com/product

Gewinne!

Nimm an der Umfrage auf www.LEGOsurvey.com/product teil und hab die Chance ein cooles LEGO® Produkt zu gewinnen!
Die Teilnahme am Gewinnspiel führt zu keinerlei Kaufverpflichtungen. Teilnahme in allen nicht ausgeschlossenen Ländern möglich.

 www.LEGO.com

4668493

Win!

Ga naar www.LEGOsurvey.com/product, vul een enquêteformulier in en maak kans op een cool LEGO® product.
Geen aankoopverplichting, iedereen mag deelnemen, uitgezonderd ingezetenden van landen waar een enquêteverbod geldt.

Gagne!

Visite www.LEGOsurvey.com/product pour répondre à un questionnaire et avoir une chance de gagner un produit LEGO® très cool!
Aucune obligation d'achat.
Ouvert à tous les résidents des pays autorisés.

当てよう!

www.LEGOsurvey.com/product にアクセスして、アンケートにご記入ください。当選者にはレゴ®製品を差し上げます。
お買い上げの必要はありません。禁止されていない限り、すべての皆様にご利用いただけます。

LEGO and the LEGO logo are trademarks of the/sont des marques de commerce de/son marcas registradas de LEGO Group. ©2012 The LEGO Group.

⚠ AVERTISSEMENT : RISQUE D'ÉTOUFFEMENT.
Contient des petites pièces. Ne convient pas aux enfants de moins de 3 ans.

⚠ ADVERTENCIA: PELIGRO DE ASFIXIA.
No recomendado para niños menores de 3 años. Contiene piezas pequeñas.

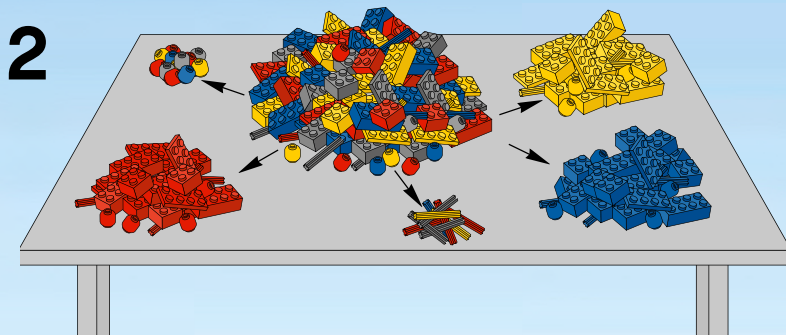
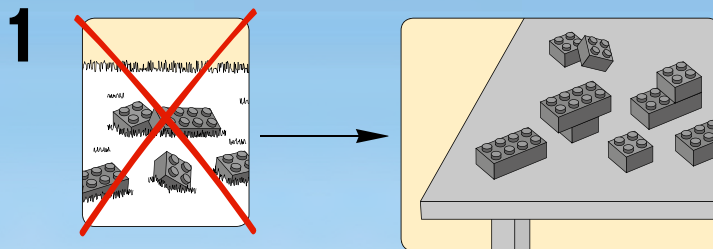

NEW BRICK SEPARATOR INCLUDED.
Loosens and separates bricks from a plate.

NOUVEAU SÉPARATEUR DE BRIQUES INCLUS.
Détache et sépare les briques d'une plaque.

INCLUYE UN NUEVO SEPARADOR DE BLOQUES.
Permite aflojar y separar los bricks unidos a una placa.

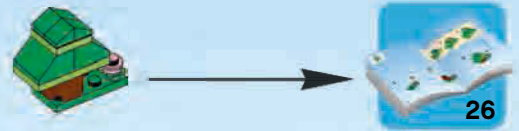
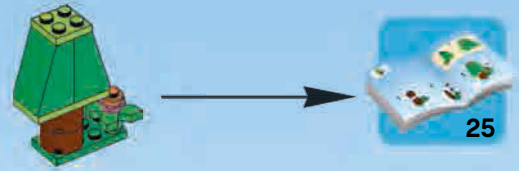
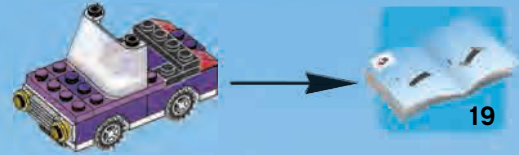
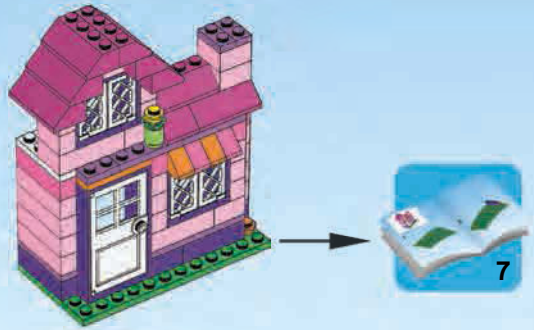
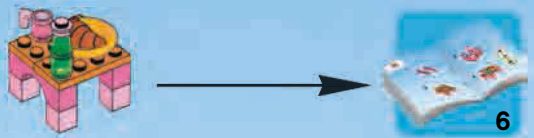
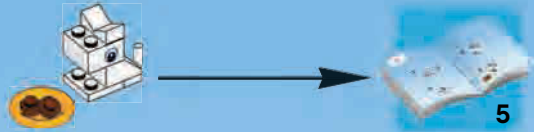

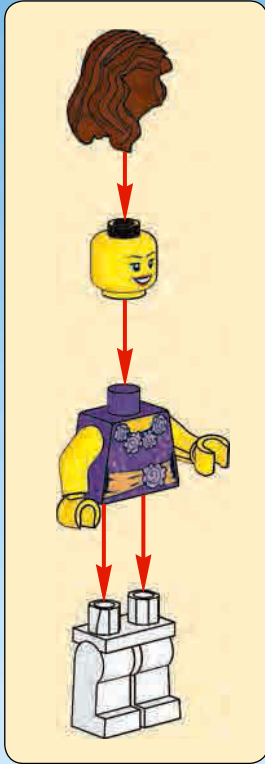

4



1

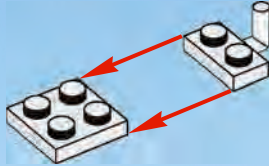

2

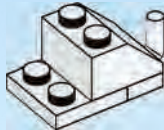

3

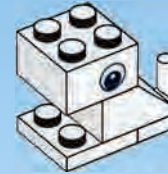

4

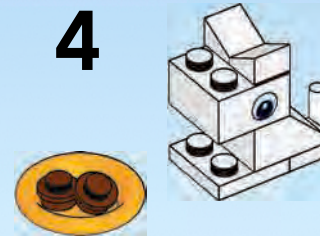

5



1

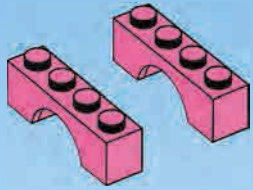

2

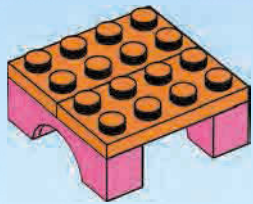

3

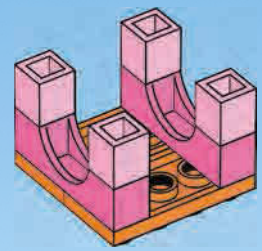

4

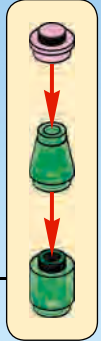
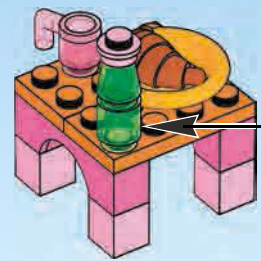



1

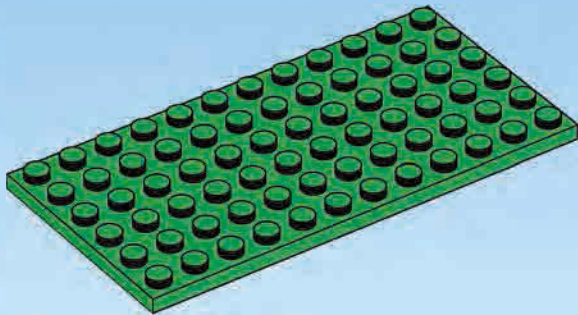

2

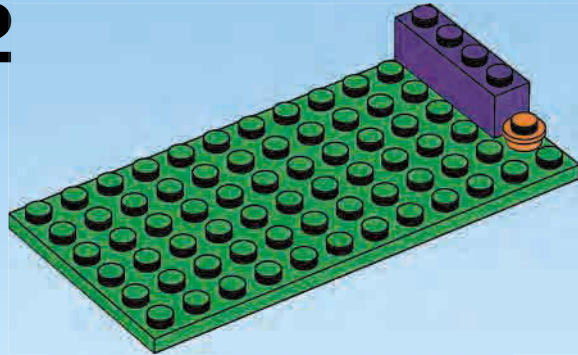

3

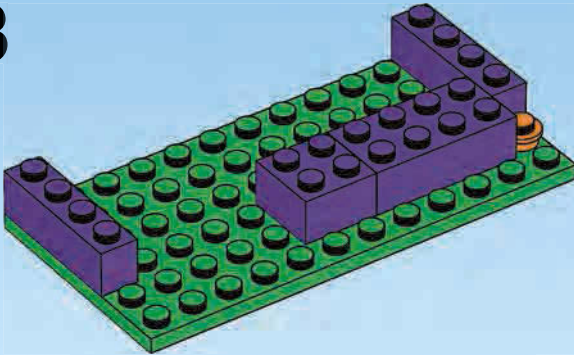

4

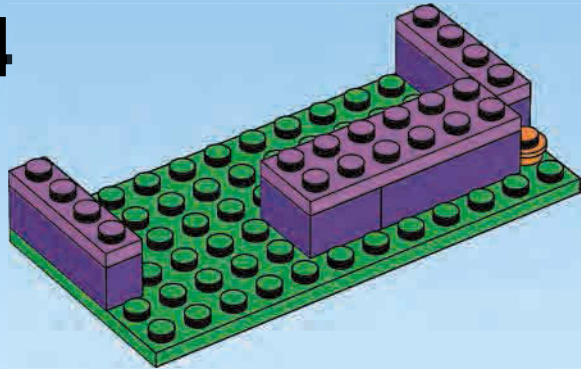

8

5

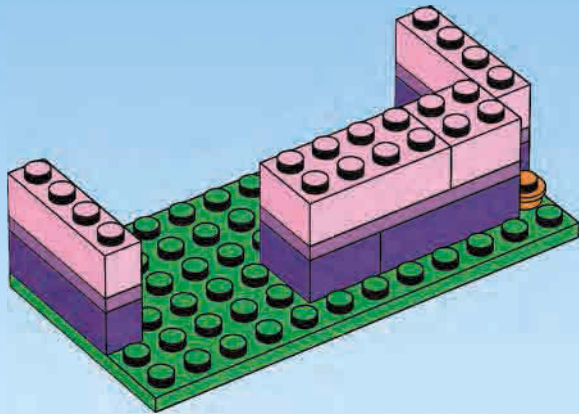

6

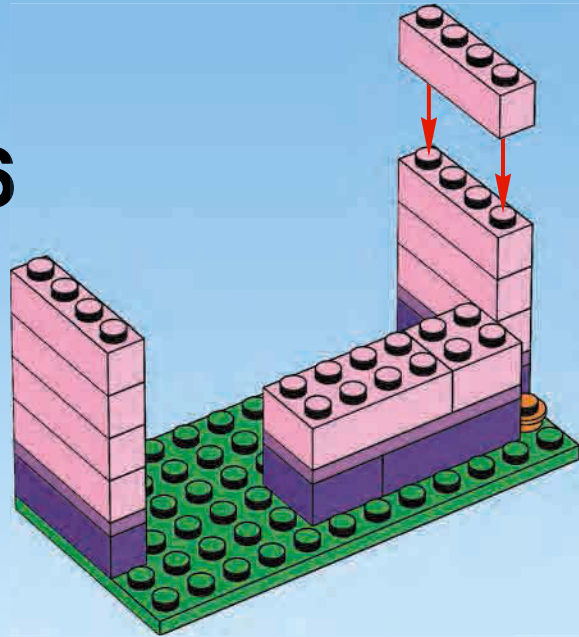

7

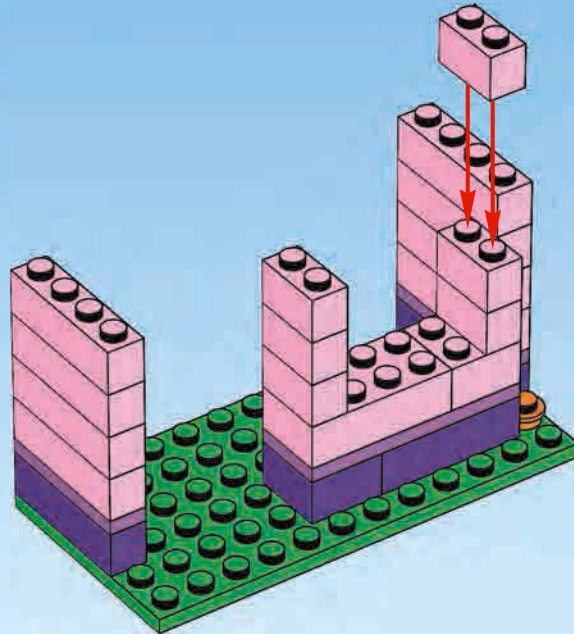

10

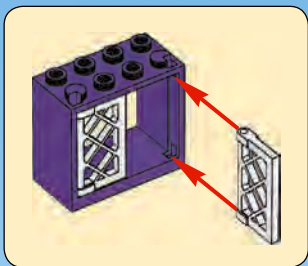

8

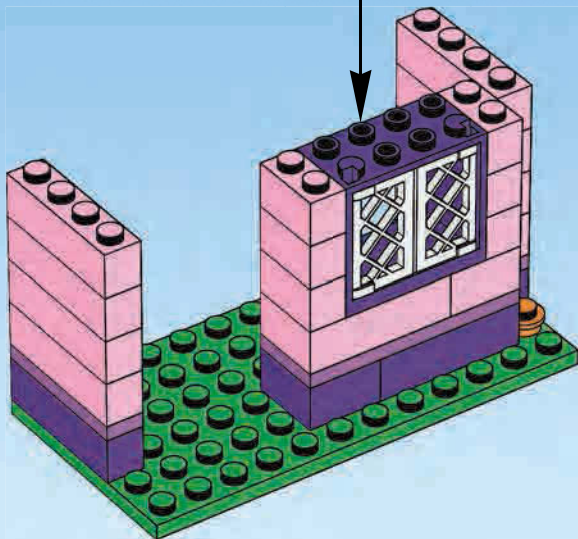

9

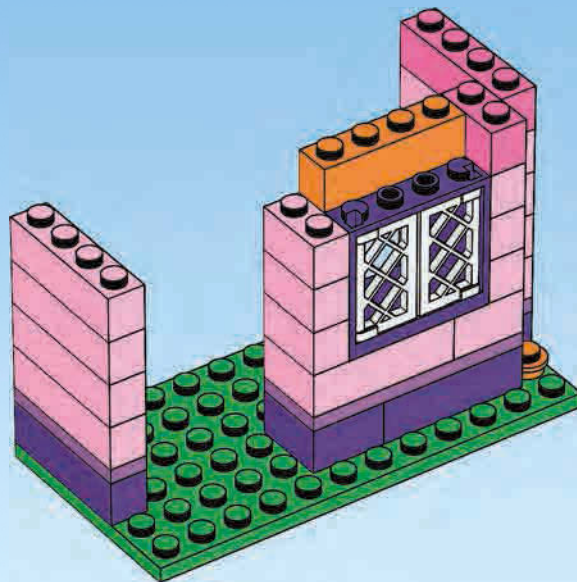

11



10

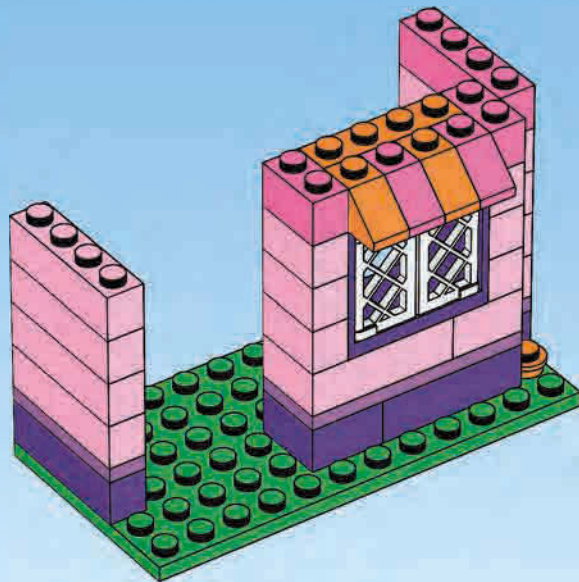

12

11

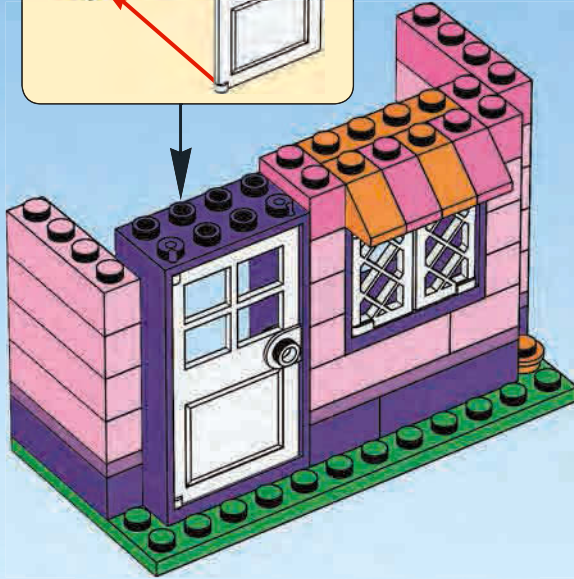
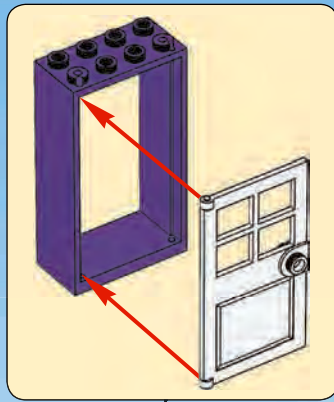

12



13

13



14

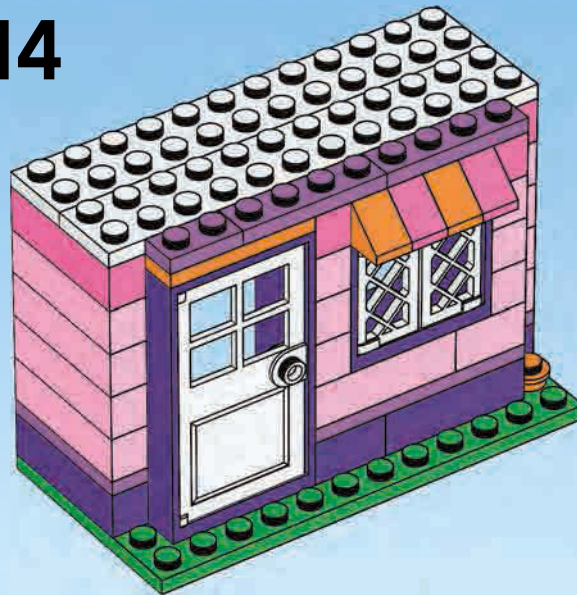

14

15



16



17



18



16

19

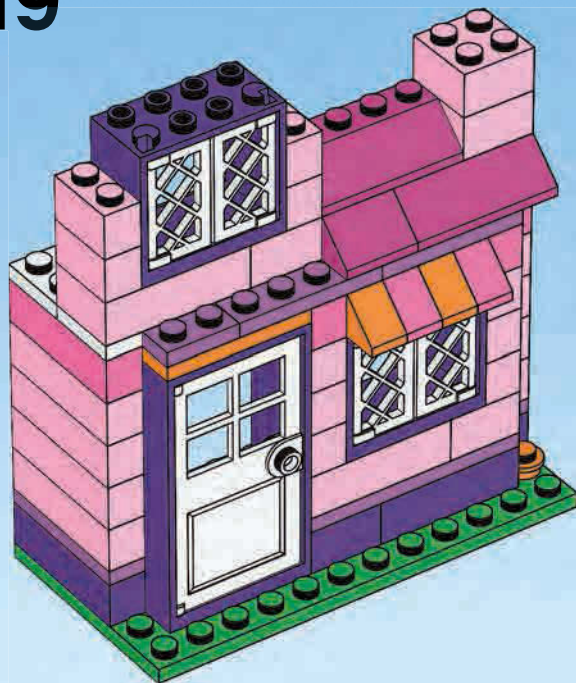

20

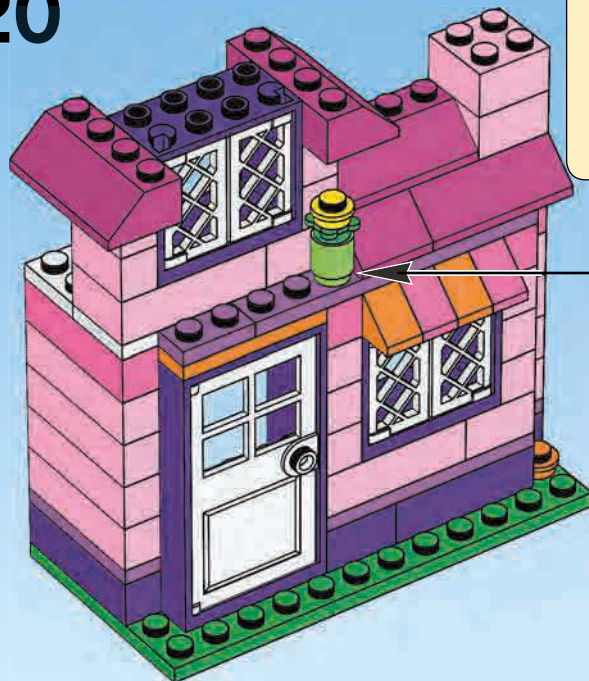

17

21

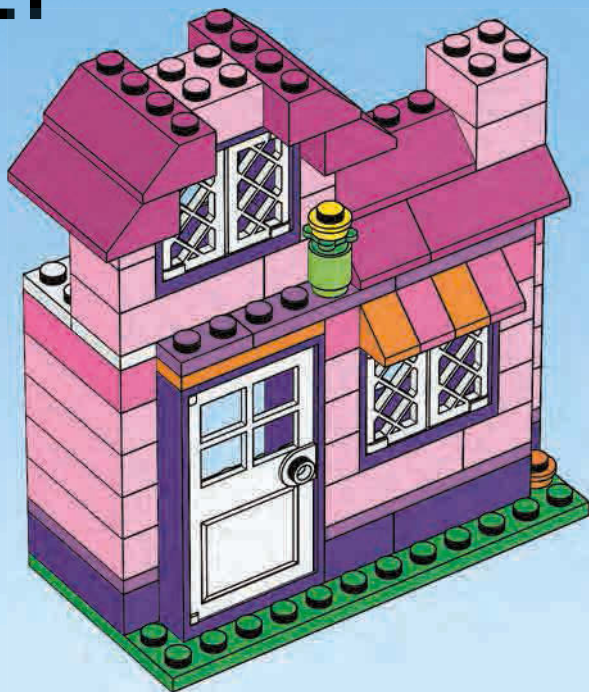

22

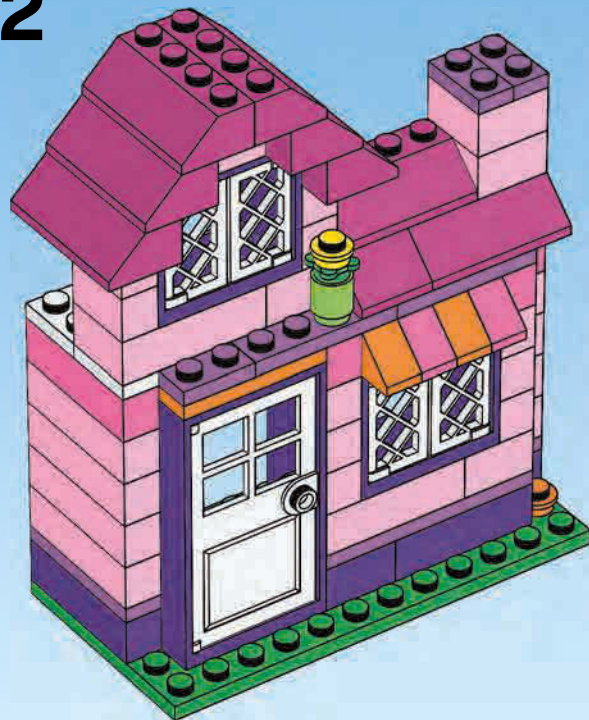

18



1

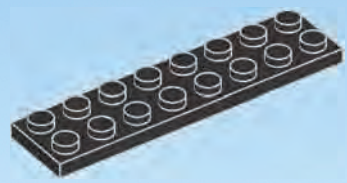

2

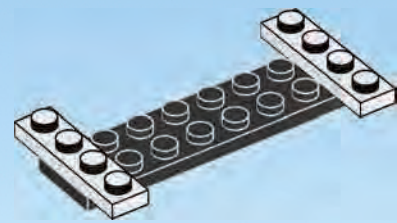

3

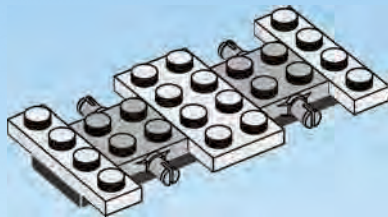

4

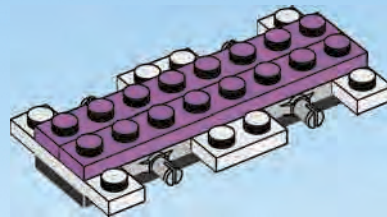

5

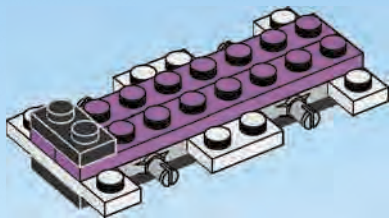

6

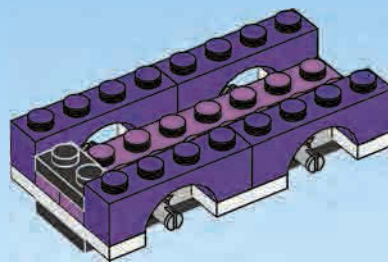

7

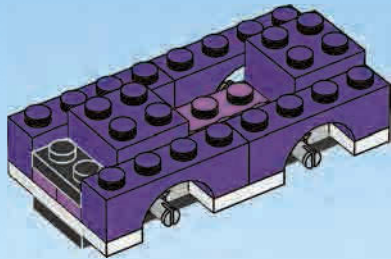

1



2

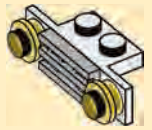

8

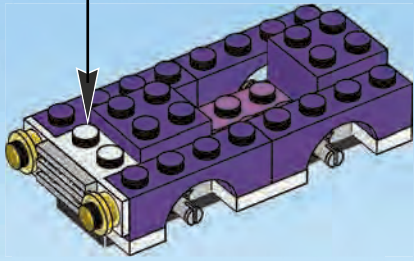

9

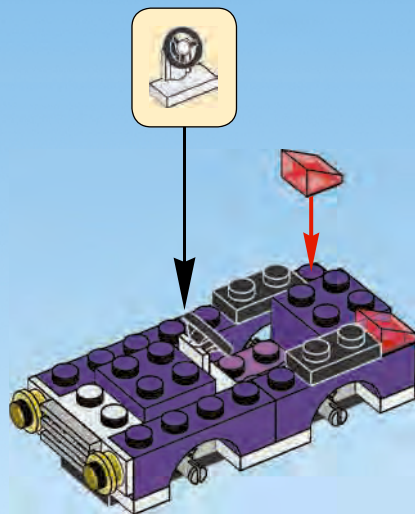

10

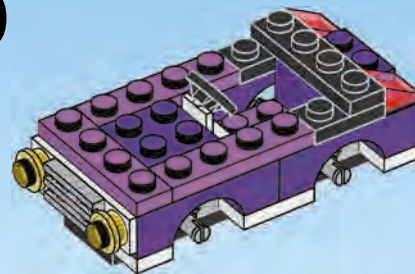

11

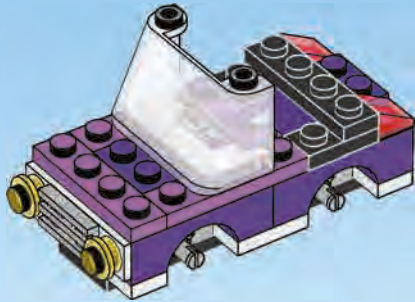

12

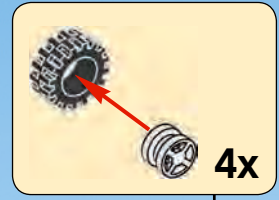
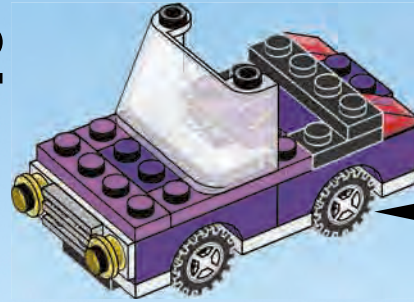

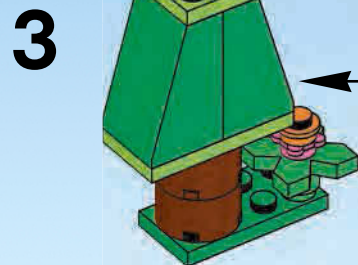
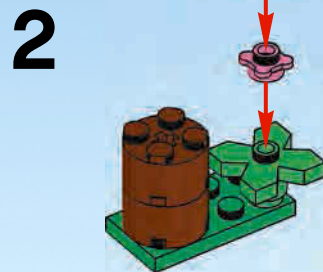
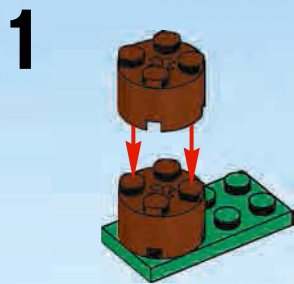
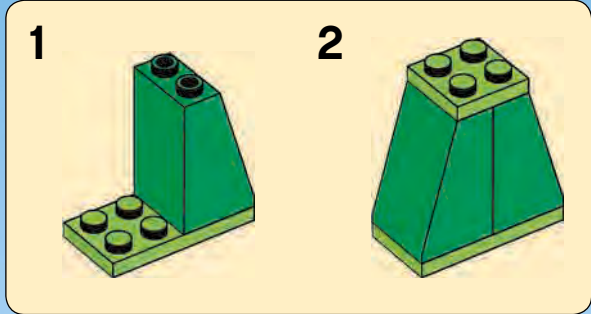

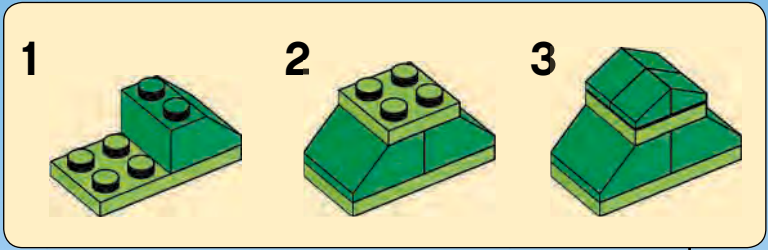

1

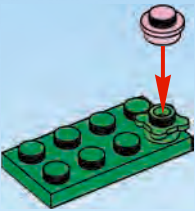

2

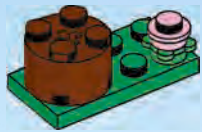

3

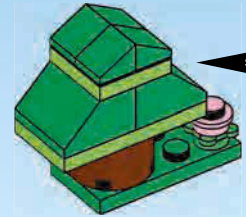







5560



3936



3061



3942



4626



4637



626



6177





1x
4569079



2x
4504369



1x
303901



2x
4520970



4x
302301



1x
302201



2x
371001



1x
302001

30



2x
244501



1x
4611700



1x
4282737



4x
4538968



2x
4247139



1x
4521943



2x
6000019



1x
9327



4x
462401



1x
9551



4x
614124



1x
4651443



4x
302326



1x
371026



1x
303426



4x
4578677



4x
4546705



2x
303928



2x
4220027

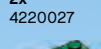

2x
302028

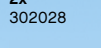

2x
302028



1x
4541414



4x
4619599



2x
4143562



1x
4273743



1x
382340



2x
4244363



2x
3005744



1x
3006848



1x
4567333



4x
4118787



4x
4118827



2x
4121967



3x
4158355

4x
4157103



1x
4654448



1x
4143404



2x
4212454



2x
4537937



2x
4537936



1x
4504850



4x
4550362



10x
4518889



2x
4243920



3x
4211166



2x
4216581



1x
4550736



1x
4211350



2x
4211504



4x
4492224



4x
4621545



4x
4618655



4x
4621542



2x
4518891



2x
4244613



4x
4216479



4x
4286050



10x
4517993



5x
4550359



8x
4518890



4x
4520632



4x
4517996



4x
4640739



4x
4653960



4x
4640611



4x
4626935



4x
4656482



1x
4656624



2x
4656625



1x
4656499



4x
4619512



9x
4619524



2x
4625027



2x
4625022



Customer Service

Kundenservice

Service Consommateurs

Servicio Al Consumidor

www.lego.com/service or dial



: 00800 5346 5555

: 1-800-422-5346



Win!

Go to www.LEGOsurvey.com/product
to fill out a survey for a chance
to win a cool LEGO® Product.
No purchase necessary.
Open to all residents where not prohibited.



www.LEGOsurvey.com/product

Gewinne!

Nimm an der Umfrage auf www.LEGOsurvey.com/product teil und hab die Chance ein cooles LEGO® Produkt zu gewinnen!
Die Teilnahme am Gewinnspiel führt zu keinerlei Kaufverpflichtungen. Teilnahme in allen nicht ausgeschlossenen Ländern möglich.

 www.LEGO.com

4668493

Win!

Ga naar www.LEGOsurvey.com/product, vul een enquêteformulier in en maak kans op een cool LEGO® product.
Geen aankoopverplichting, iedereen mag deelnemen, uitgezonderd ingezetenden van landen waar een enquêteverbod geldt.

Gagne !

Visite www.LEGOsurvey.com/product pour répondre à un questionnaire et avoir une chance de gagner un produit LEGO® très cool !
Aucune obligation d'achat.
Ouvert à tous les résidents des pays autorisés.

当てよう!

www.LEGOsurvey.com/product にアクセスして、アンケートにご記入ください。当選者にはレゴ®製品を差し上げます。
お買い上げの必要はありません。禁止されていない限り、すべての皆様にご利用いただけます。

LEGO and the LEGO logo are trademarks of the/sont des marques de commerce de/son marcas registradas de LEGO Group. ©2012 The LEGO Group.