



4637



WARNING: CHOKING HAZARD.
Small parts. Not for children under 3 years.



2



⚠ Avertissement : Risque d'étouffement.

Contient des petites pièces. Ne convient pas aux enfants de moins de 3 ans.

⚠ Advertencia: Peligro de asfixia.

No recomendado para niños menores de 3 años. Contiene piezas pequeñas.



1

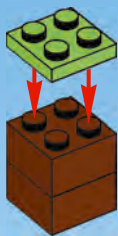

2

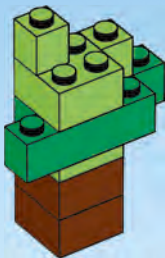

4



1

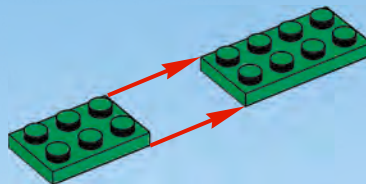

2

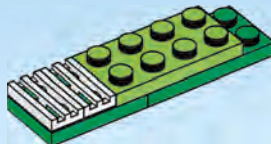

3

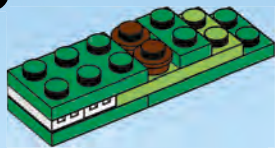

4

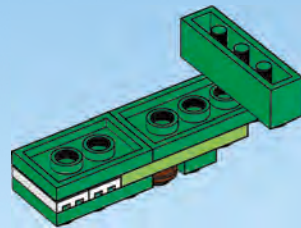

5

5

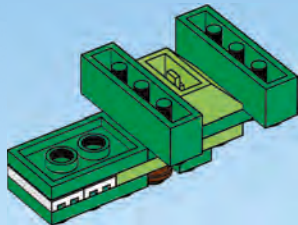

6

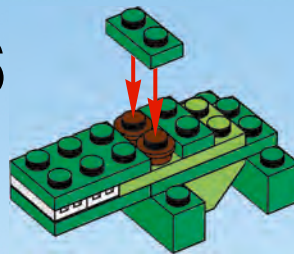

6

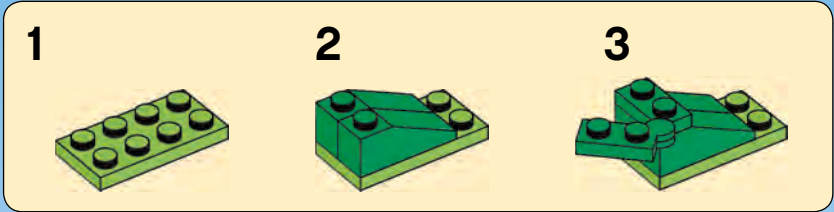

7

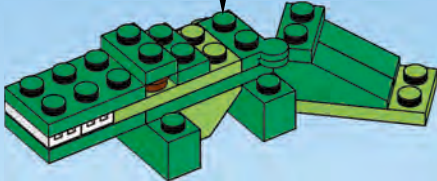

7



1

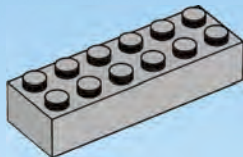

2

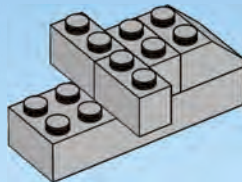

8

3



4

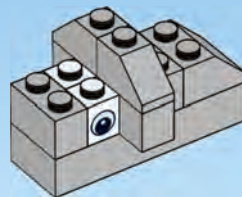

5

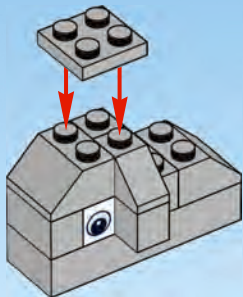

6

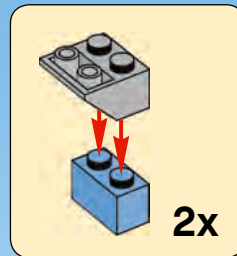
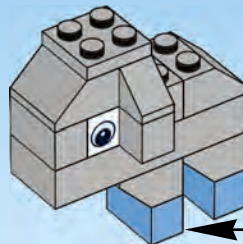

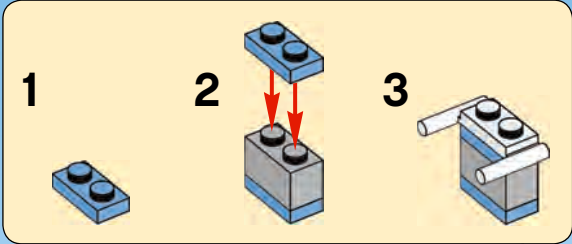

7

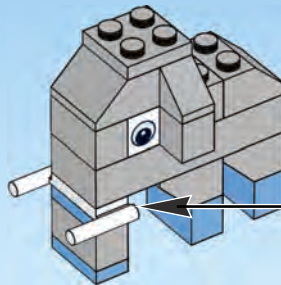

1



2



3



4



8

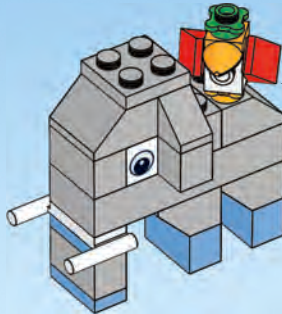

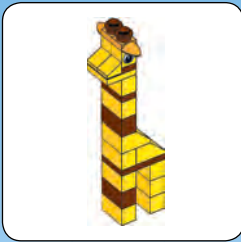

1



2



3



4

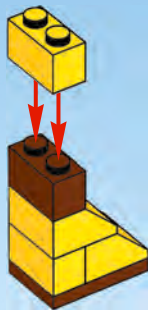

5

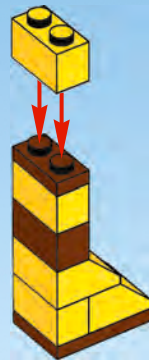



6

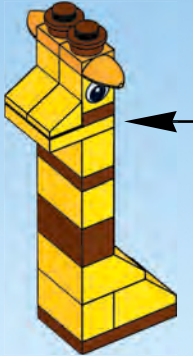

7

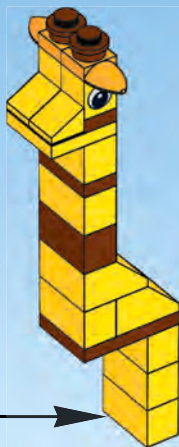
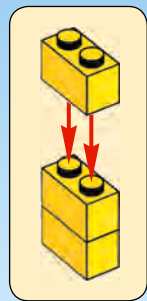

8

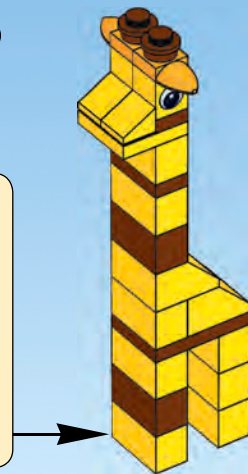
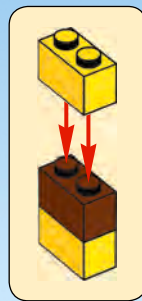

16



1



2

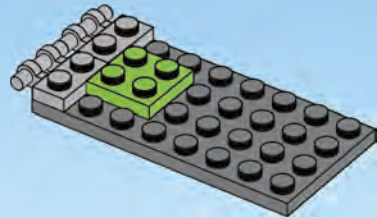

3

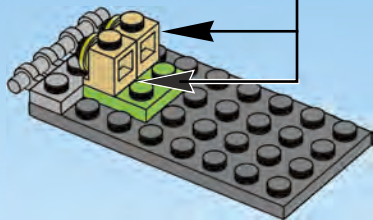

4

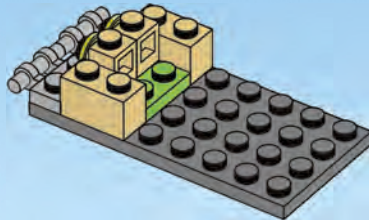

18

5

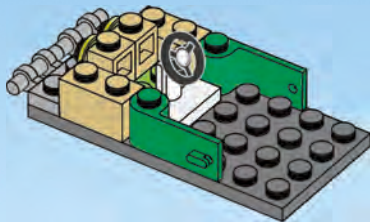

6

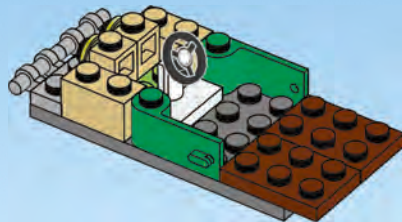

7

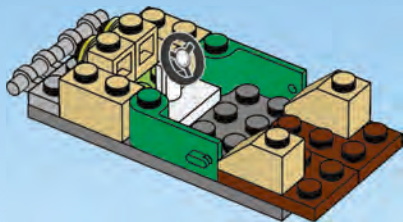

8

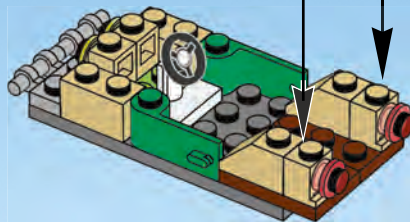

9

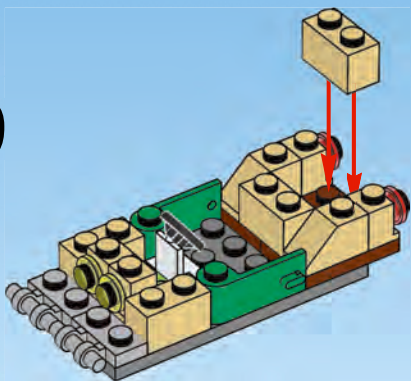

10

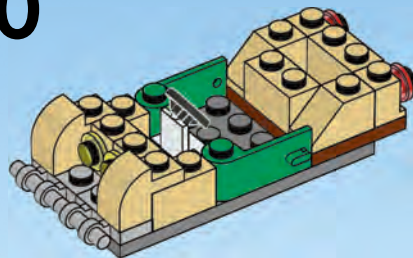

11

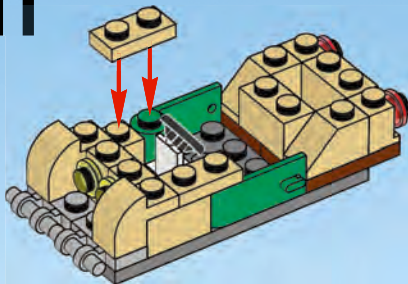

12

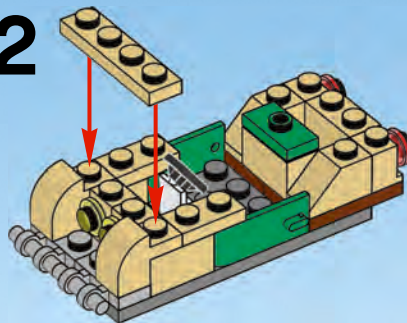

22

13

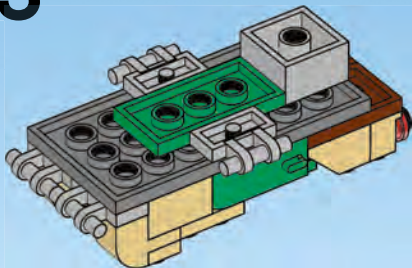

14

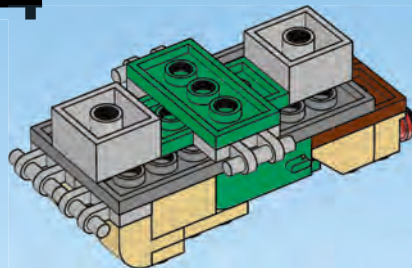

15

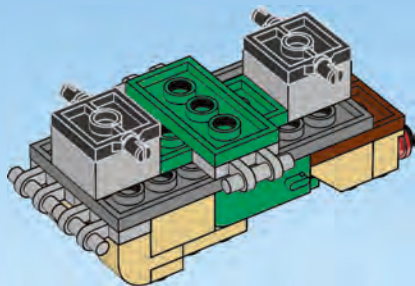

16

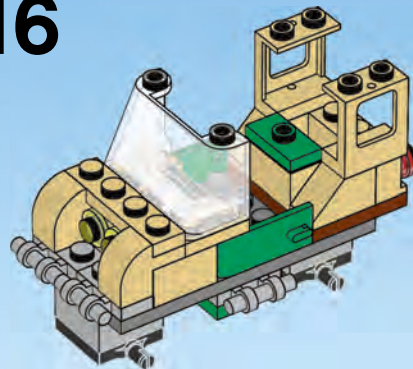

24

17

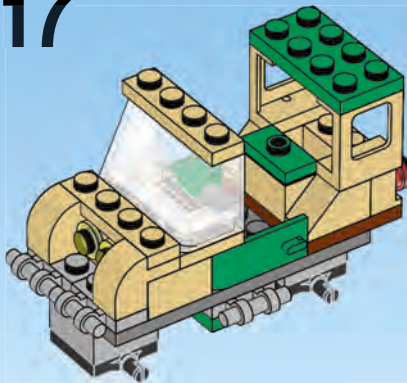

18

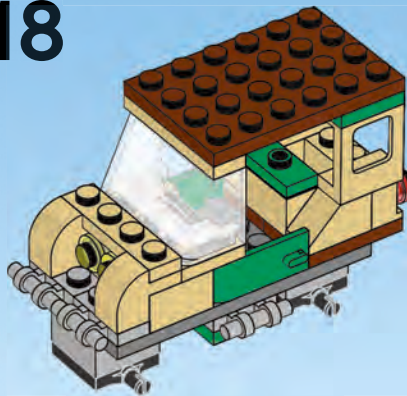

19

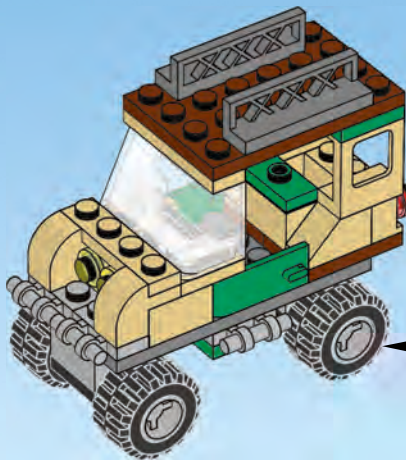

26







5933



6177



6117



6166



5560



5930



626



5929

1:1



4+



2-5



A unique system of compatible bricks
A few bricks are not compatible

Un système unique de briques compatibles
Quelques briques ne sont pas compatibles

Un sistema único de ladrillos compatibles
Algunos ladrillos no son compatibles





2x
4569080



1x
4111971



2x
241201



1x
383901



2x
614101



1x
4637188



1x
9551



4x
4109995
30



4x
4118793



2x
4121972



2x
4273526



2x
4113917



2x
4113233



2x
4543947



2x
4504379



1x
9342



1x
9341



2x
4569076



8x
300424



2x
4504381



2x
303924



1x
302224



1x
4584727



1x
4570043



1x
4106552



1x
4154853



4x
4568644



2x
460026



4x
4112838



2x
4107637



3x
302328



2x
302128



4x
302028



2x
379428



1x
4187931



1x
4567914



1x
4567918



1x
4529755



1x
382340



2x
3005741



2x
3005744



3x
4179833



2x
4179825



1x
4552605



2x
4177932



2x
4220634



3x
4220632



1x
4529679



2x
4537937



2x
4537936



2x
4624184



3x
4282860



2x
4211149



2x
4211210



5x
4211150



3x
4211189



1x
4271874



4x
4216581



5x
4211388



2x
4211387



1x
4211795



2x
4211614



2x
4211410



2x
4211436



1x
4211397



4x
4211632



4x
4211764



2x
4619599



1x
4211061



2x
4219725



1x
4581313



Customer Service

Kundenservice

Service Consommateurs

Servicio Al Consumidor

www.lego.com/service or dial



: 00800 5346 5555

: 1-800-422-5346



WIN!

Go to www.LEGOsurvey.com/product to fill out a survey for a chance to win a cool LEGO® Product. No purchase necessary. Open to all residents where not prohibited.



www.LEGOsurvey.com/product

GEWINNE!

Nimm an der Umfrage auf www.LEGOsurvey.com/product teil und hab die Chance ein cooles LEGO® Produkt zu gewinnen! Die Teilnahme am Gewinnspiel führt zu keinerlei Kaufverpflichtungen. Teilnahme in allen nicht ausgeschlossenen Ländern möglich.

WIN!

Ga naar www.LEGOsurvey.com/product, vul een enquêteformulier in en maak kans op een cool LEGO® product. Geen aankoopverplichting. Iedereen mag deelnemen, uitgezonderd ingezetenden van landen waar een enquêteverbod geldt.

GAGNE!

www.LEGOsurvey.com/product pour répondre à un questionnaire et avoir une chance de gagner un produit LEGO® très cool! Aucune obligation d'achat. Ouvert à tous les résidents des pays autorisés.

当てよう!

www.LEGOsurvey.com/product にアクセスして、アンケートにご記入ください。当選者にはレゴ®製品を差し上げます。お買い上げの必要はありません。禁止されていない限り、すべての皆様にご利用いただけます。



www.LEGO.com

4668519

LEGO and the LEGO logo are trademarks of the/son des marques de commerce de/son marcas registradas de LEGO Group. ©2012 The LEGO Group.



2



⚠ Avertissement : RISQUE D'ÉTOUFFEMENT.

Contient des petites pièces. Ne convient pas aux enfants de moins de 3 ans.

⚠ Advertencia: PELIGRO DE ASFIXIA.

No recomendado para niños menores de 3 años. Contiene piezas pequeñas.



1

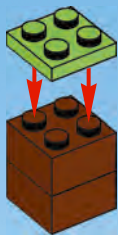

2

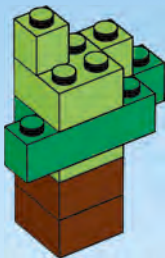

4



1

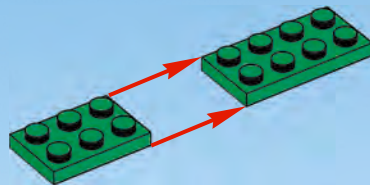

2

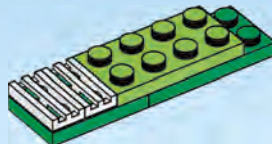

3

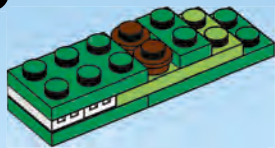

4

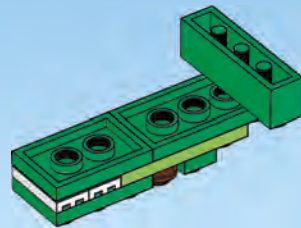

5

5

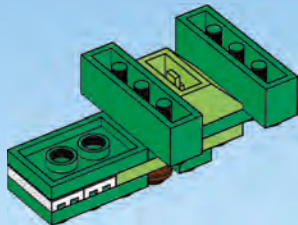

6

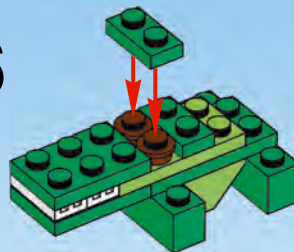

6

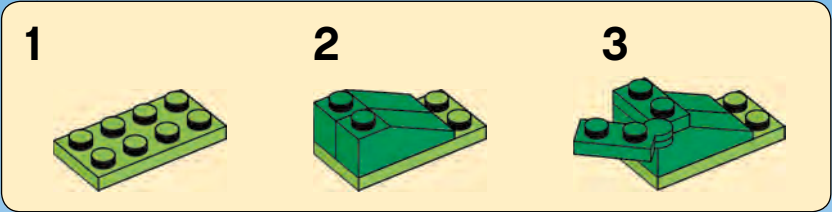

7

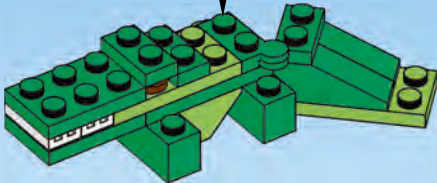

7



1

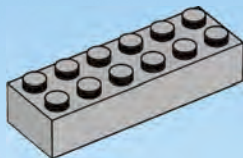

2

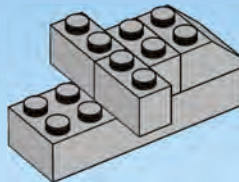

8

3



4

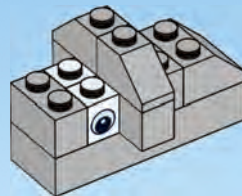

5

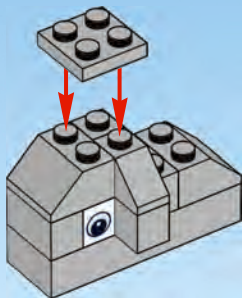

6

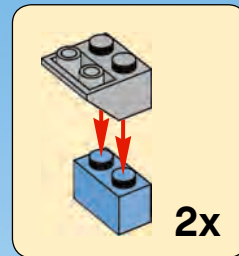
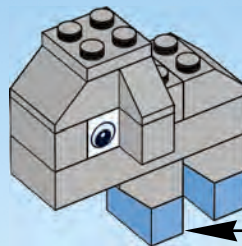

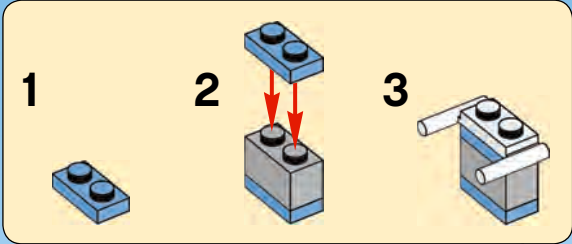

7

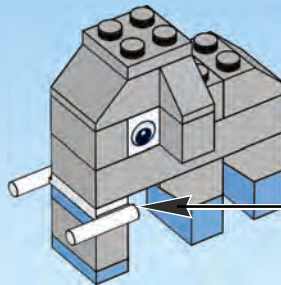

1



2



3



4



8

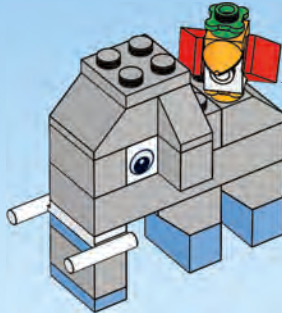

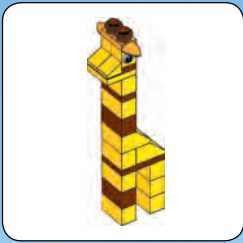

1



2



3



4

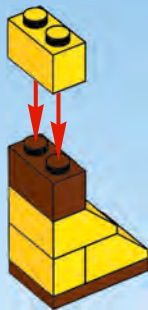

5

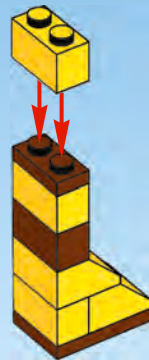



6

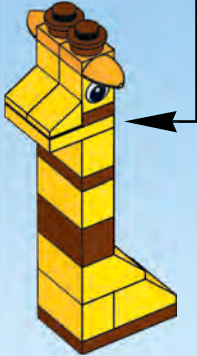

7

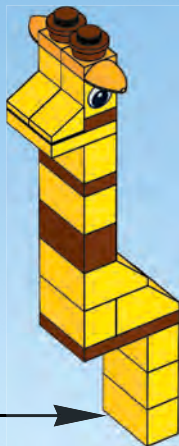
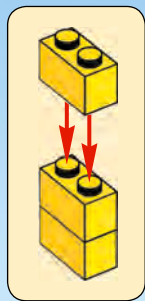

8

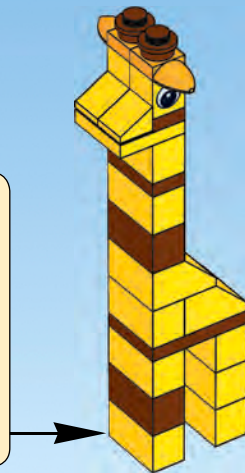
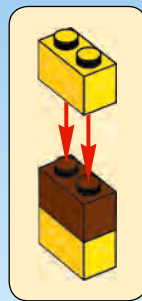

16



1



2

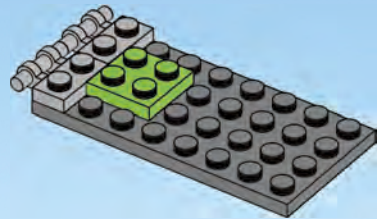

3

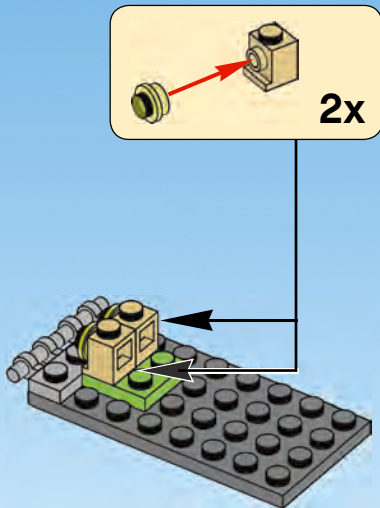

4

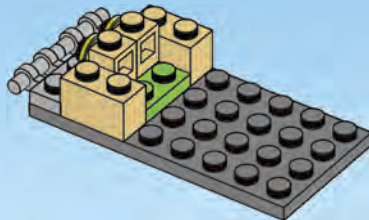

5

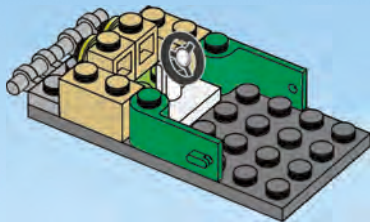

6

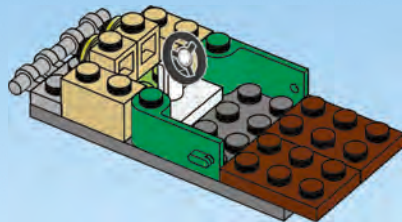

7

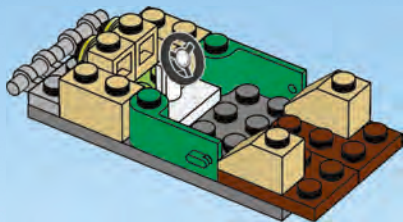

8

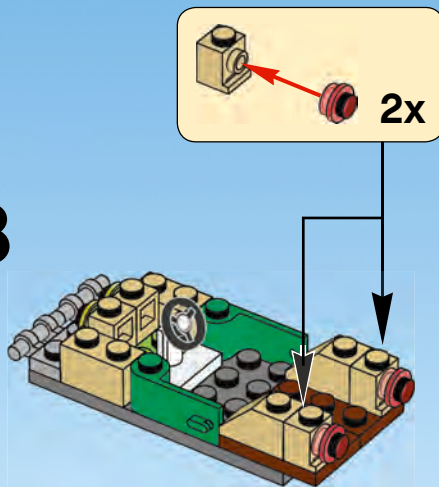

9

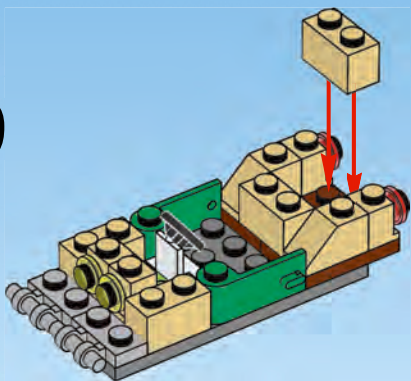

10

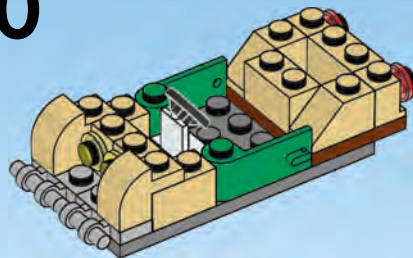

11

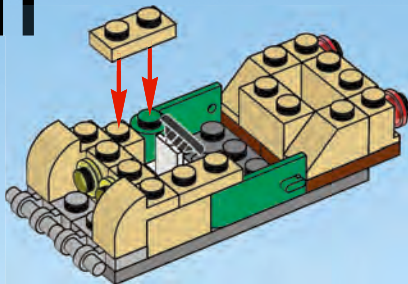

12

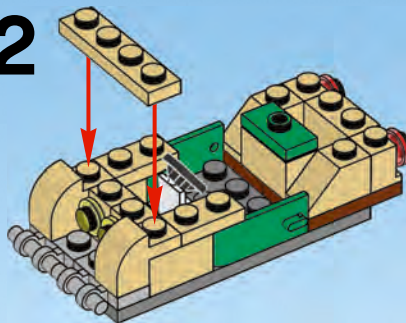

22

13

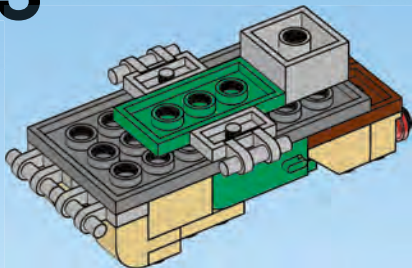

14

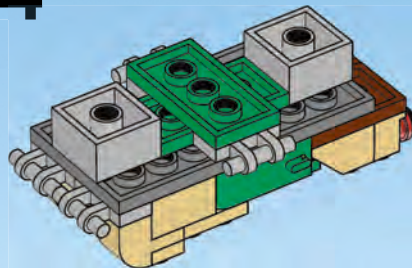

15

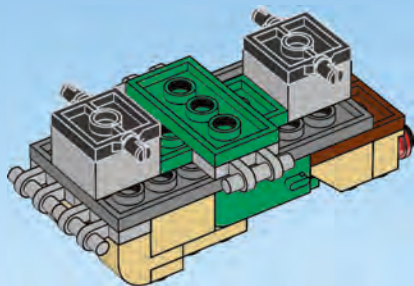

16

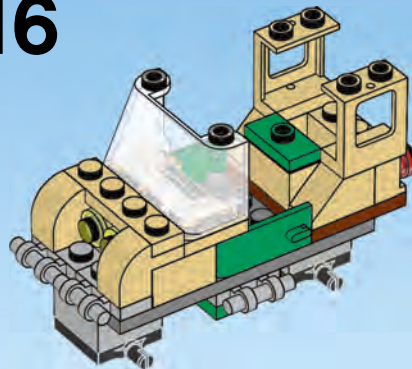

24

17

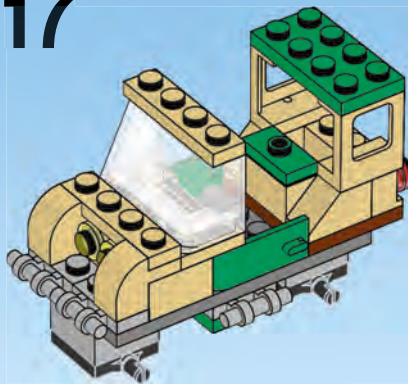

18

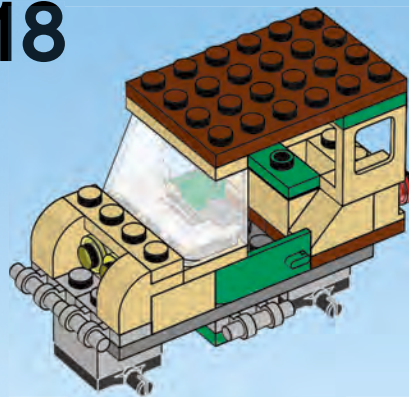

19

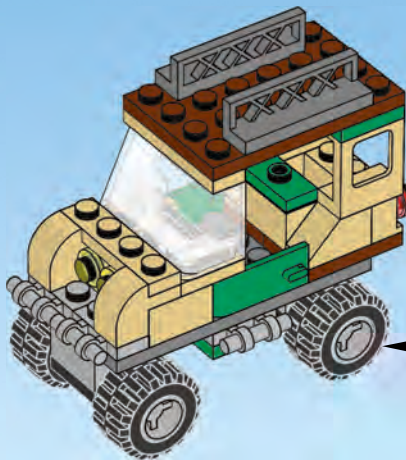

26







5933



6177



6117



6166



5560

1:1



4+



2-5



5930



626



5929



A unique system of compatible bricks
A few bricks are not compatible

Un système unique de briques compatibles
Quelques briques ne sont pas compatibles

Un sistema único de ladrillos compatibles
Algunos ladrillos no son compatibles





2x
4569080



1x
4111971



2x
241201



1x
383901



2x
614101



1x
4637188



1x
9551



4x
4109995
30



4x
4118793



2x
4121972



2x
4273526



2x
4113917



2x
4113233



2x
4543947



4x
4504379



1x
9342



1x
9341



2x
4569076



8x
300424



2x
4504381



2x
303924



1x
302224



1x
4584727



1x
4570043



1x
4106552



1x
4154853



4x
4568644



2x
460026



4x
4112838



2x
4107637



3x
302328



2x
302128



4x
302028



2x
379428



1x
4187931



1x
4567914



1x
4567918



1x
4529755



1x
382340



2x
3005741



2x
3005744



3x
4179833



2x
4179825



1x
4552605



2x
4177932



2x
4220634



3x
4220632



1x
4529679



2x
4537937



2x
4537936



2x
4624184



3x
4282860



2x
4211149



2x
4211210



5x
4211150



3x
4211189



1x
4271874



4x
4216581



5x
4211388



2x
4211387



1x
4211795



2x
4211614



2x
4211410



2x
4211436



1x
4211397



4x
4211632



4x
4211764



2x
4619599



1x
4211061



2x
4219725



1x
4581313



Customer Service

Kundenservice

Service Consommateurs

Servicio Al Consumidor

www.lego.com/service or dial



: 00800 5346 5555

: 1-800-422-5346



WIN!

Go to www.LEGOsurvey.com/product to fill out a survey for a chance to win a cool LEGO® Product.
No purchase necessary.
Open to all residents where not prohibited.



www.LEGOsurvey.com/product

GEWINNE!

Nimm an der Umfrage auf www.LEGOsurvey.com/product teil und hab die Chance ein cooles LEGO® Produkt zu gewinnen!
Die Teilnahme am Gewinnspiel führt zu keinerlei Kaufverpflichtungen.
Teilnahme in allen nicht ausgeschlossenen Ländern möglich.

WIN!

Ga naar www.LEGOsurvey.com/product, vul een enquêteformulier in en maak kans op een cool LEGO® product.
Geen aankoopverplichting.
Iedereen mag deelnemen, uitgezonderd ingezetenden van landen waar een enquêteverbod geldt.

GAGNE !

www.LEGOsurvey.com/product pour répondre à un questionnaire et avoir une chance de gagner un produit LEGO® très cool !
Aucune obligation d'achat.
Ouvert à tous les résidents des pays autorisés.

当てよう!

www.LEGOsurvey.com/product にアクセスして、アンケートにご記入ください。
当選者にはレゴ®製品を差し上げます。
お買い上げの必要はありません。
禁止されていない限り、すべての皆様にご利用いただけます。



www.LEGO.com

4668519

LEGO and the LEGO logo are trademarks of the/son des marques de commerce de/son marcas registradas de LEGO Group. ©2012 The LEGO Group.