

The LEGO logo is displayed in its characteristic white, bold, sans-serif font with a thick black outline, set against a solid red rectangular background.

# DINO

The word "DINO" is rendered in large, yellow, 3D block letters with a black outline and a cracked, stone-like texture. A green dinosaur head with its mouth open is integrated into the letter "O".

5884



**WARNING:** CHOKING HAZARD.  
Small parts. Not for children under 3 years.

1

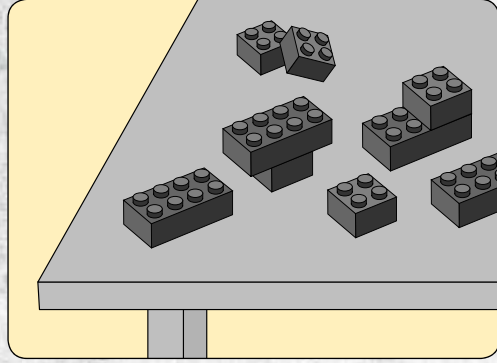
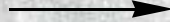
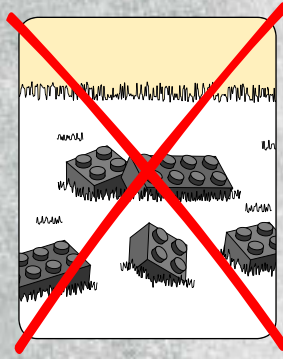

2



**AVERTISSEMENT : RISQUE D'ÉTOUFFEMENT.**  
Contient des petites pièces. Ne convient pas aux enfants de moins de 3 ans.



**ADVERTENCIA: PELIGRO DE ASFIXIA.**  
No recomendado para niños menores de 3 años. Contiene piezas pequeñas.

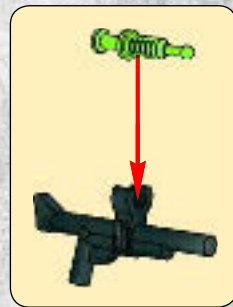





1



4



2





3

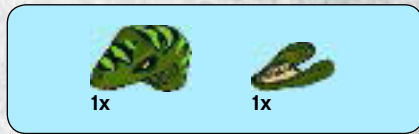
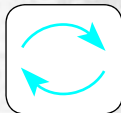

4





1



2

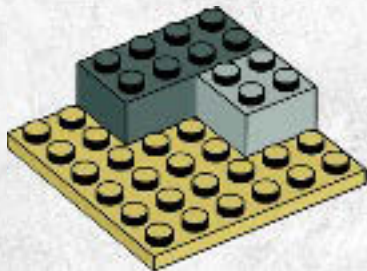



3

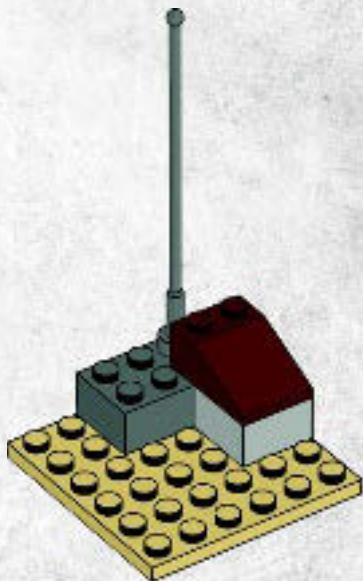

4

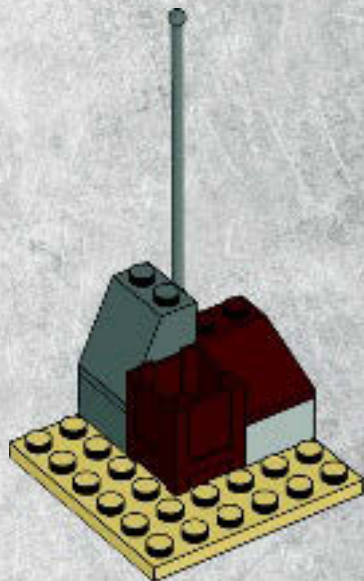





5

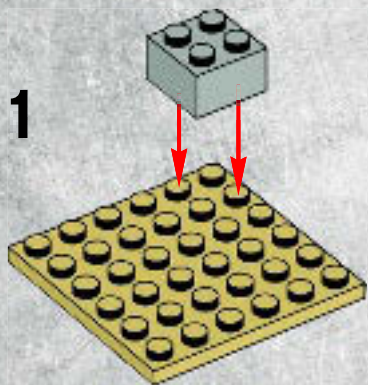

2

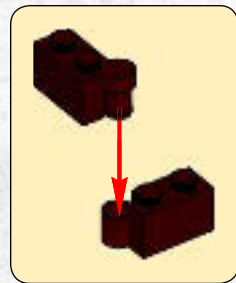
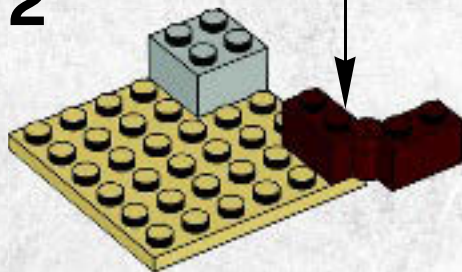



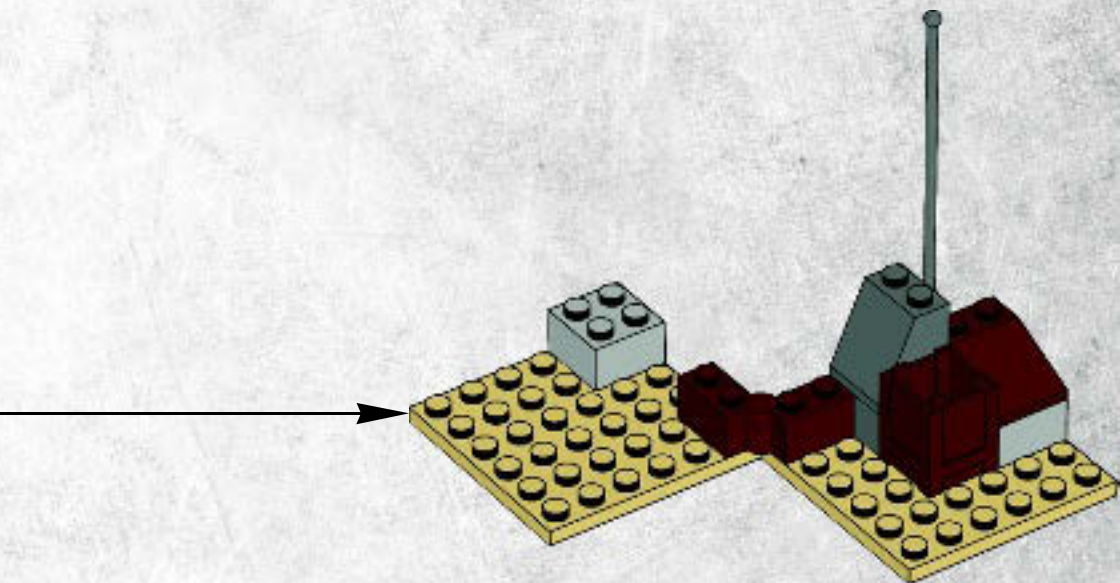



1x



1x

6

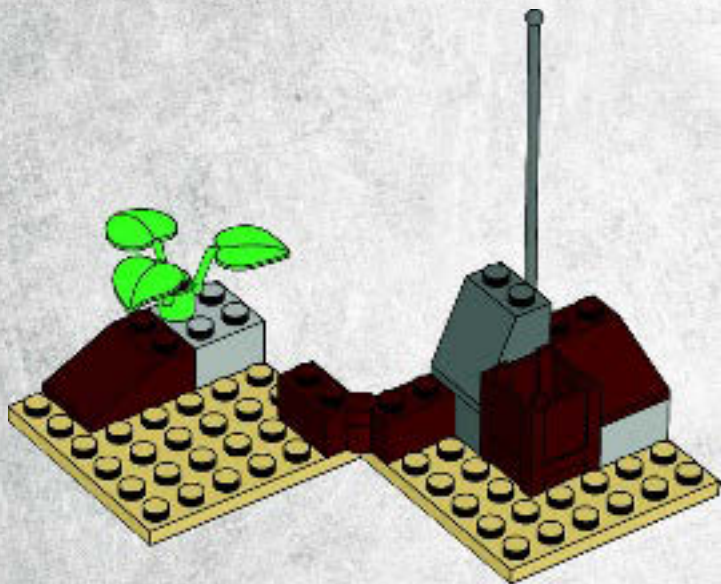

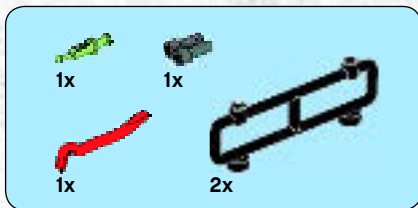

7

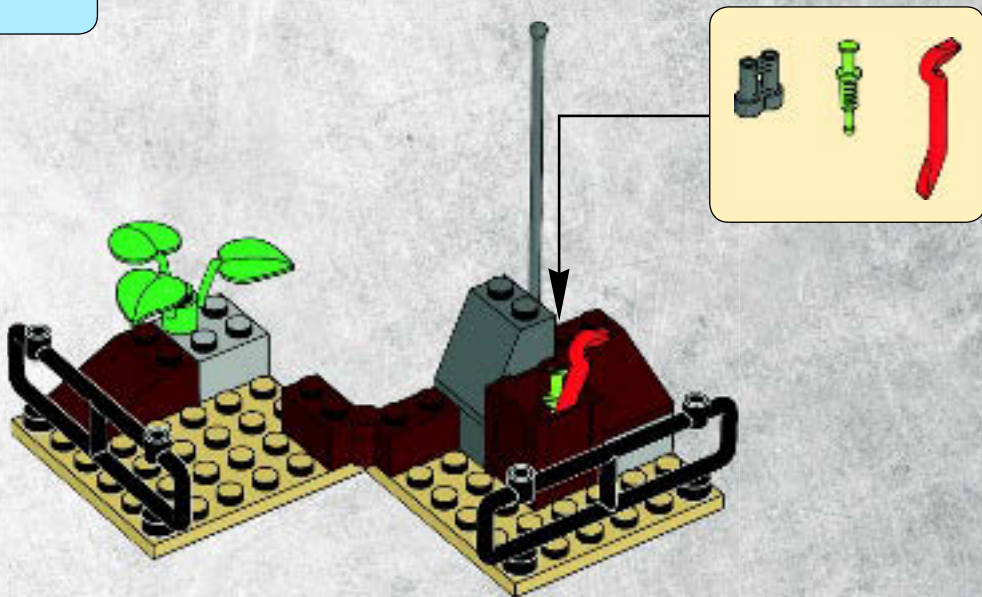





1x



2x

8

1

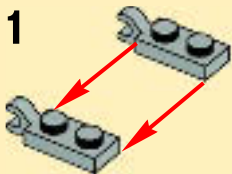

2

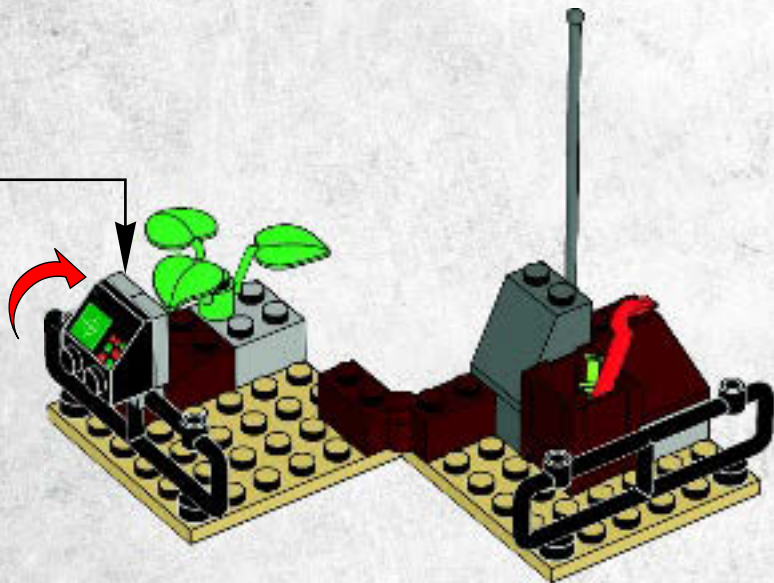



9

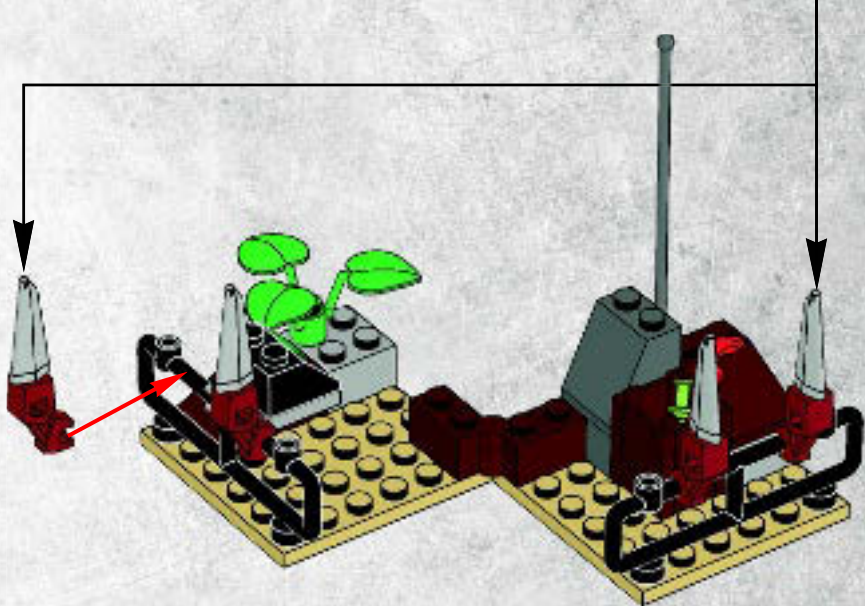
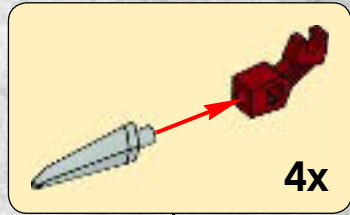



10

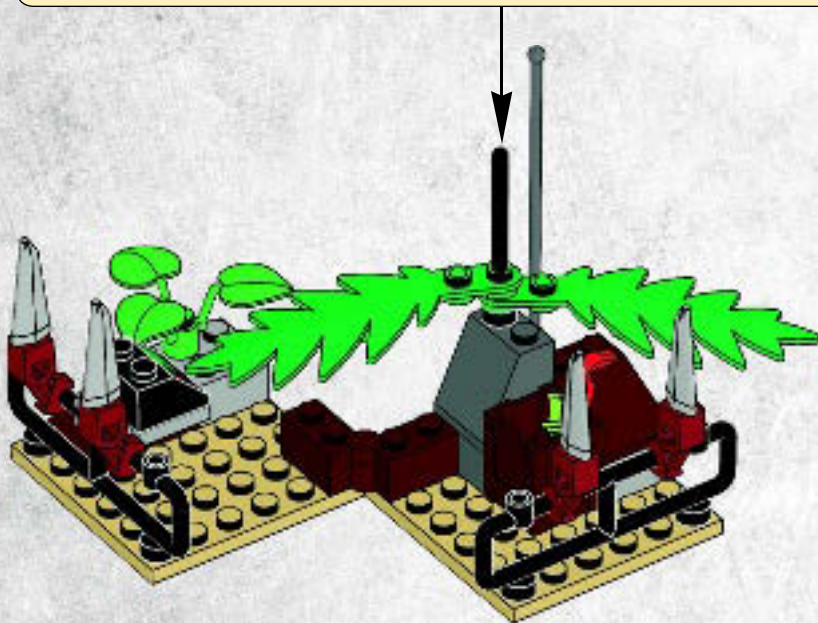
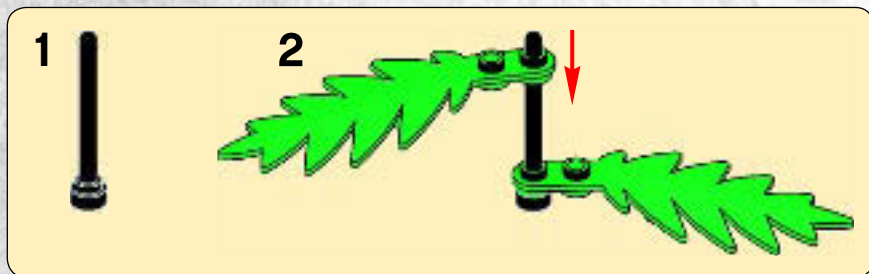





11

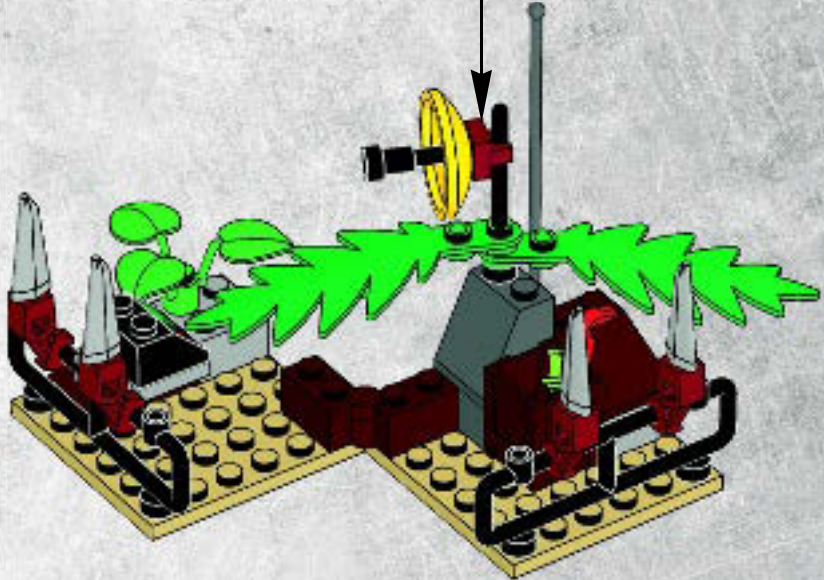



2x

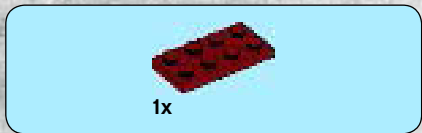

1x

1



1x

2





3

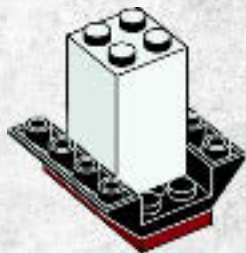

4

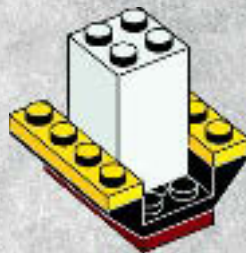



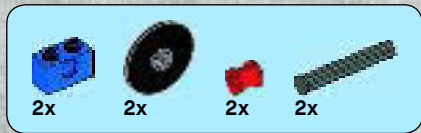

5

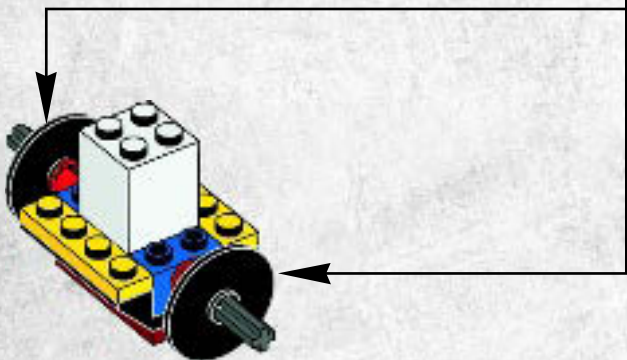
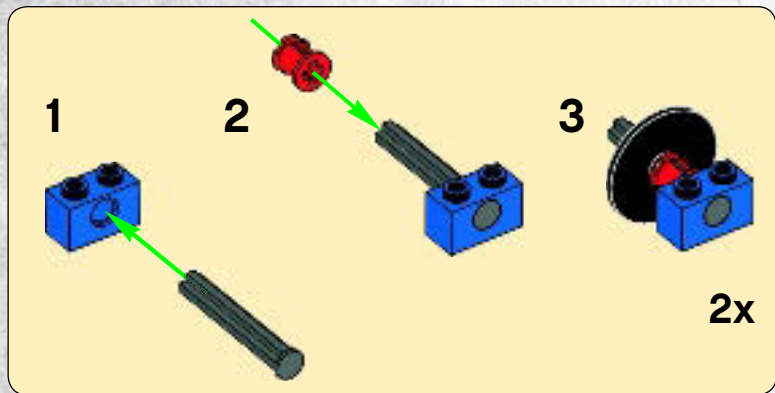



2x

6



1x

7

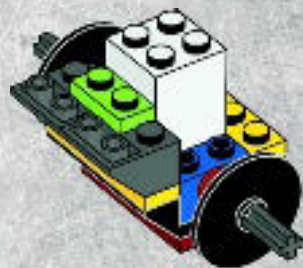

2x

8

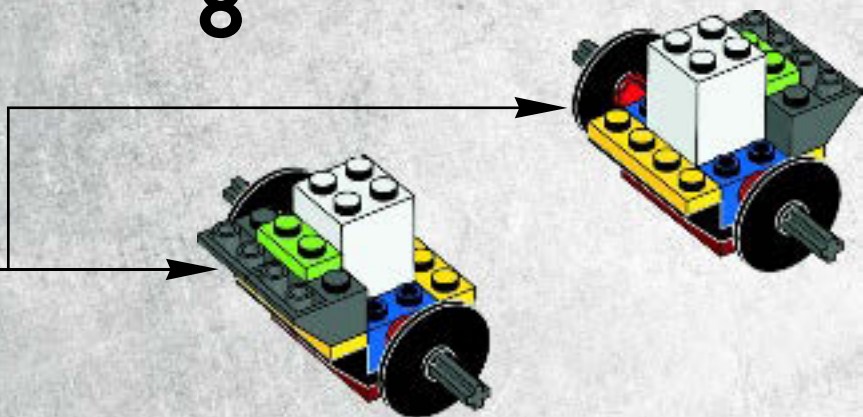



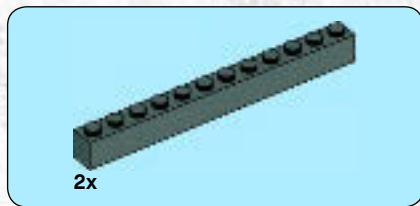

9

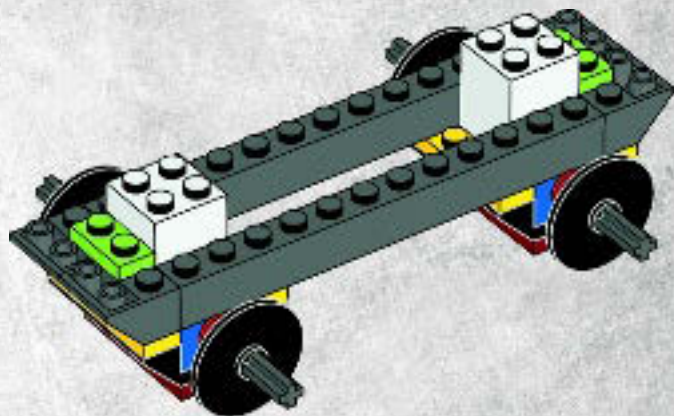



4x

10

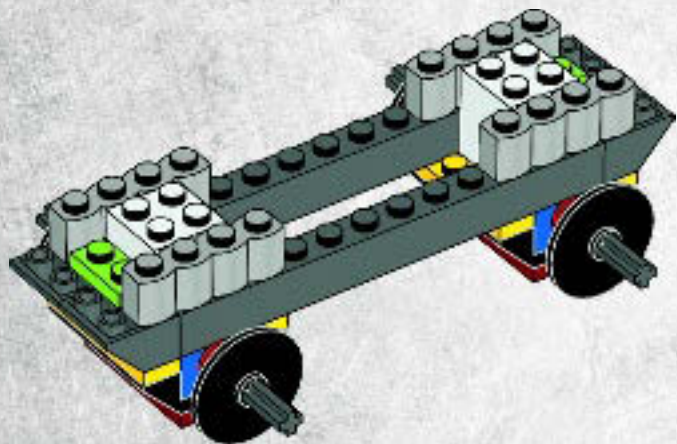



2x



1x

2x



1x

1x



1x

# 11

## 1



## 2

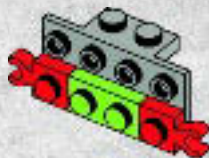

## 3

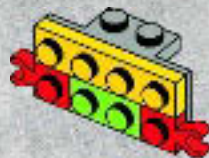



4

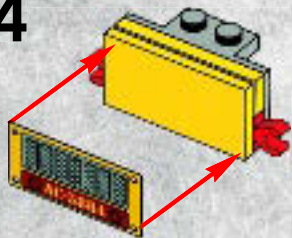

5

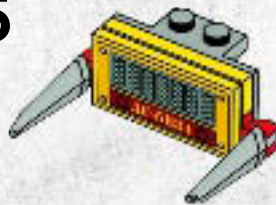

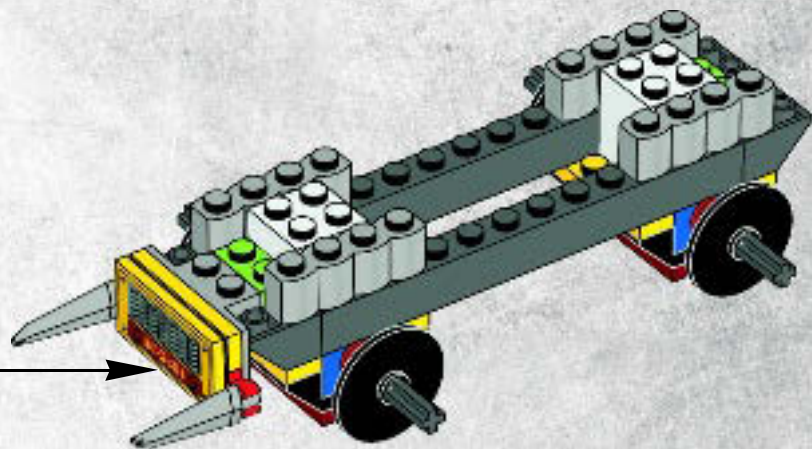



12

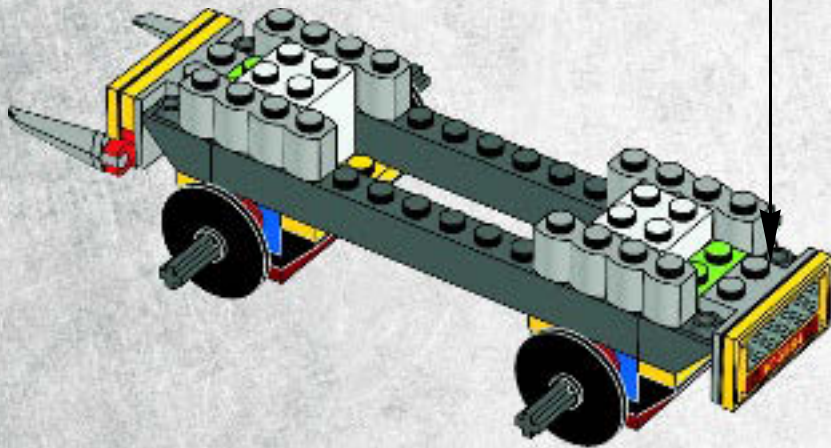
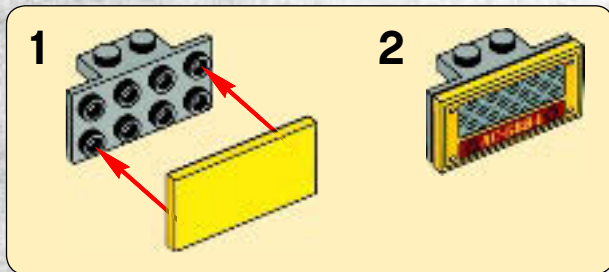





2x

# 13

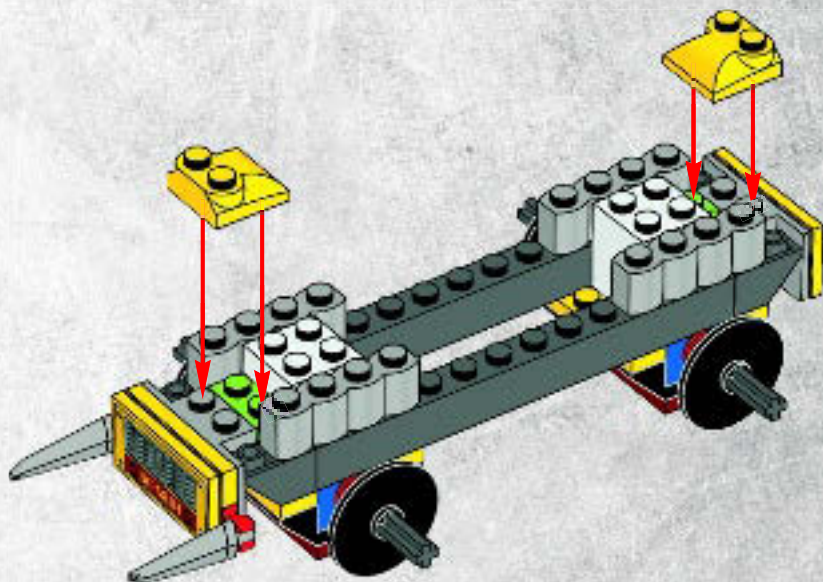



4x

14

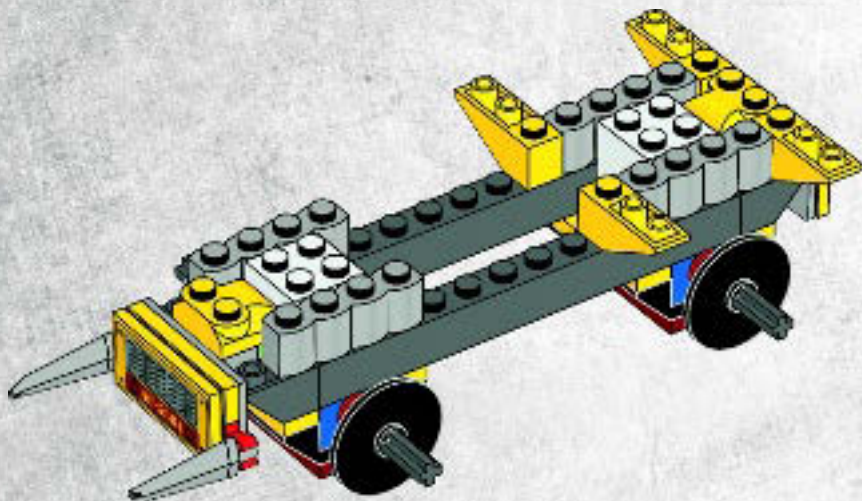



15

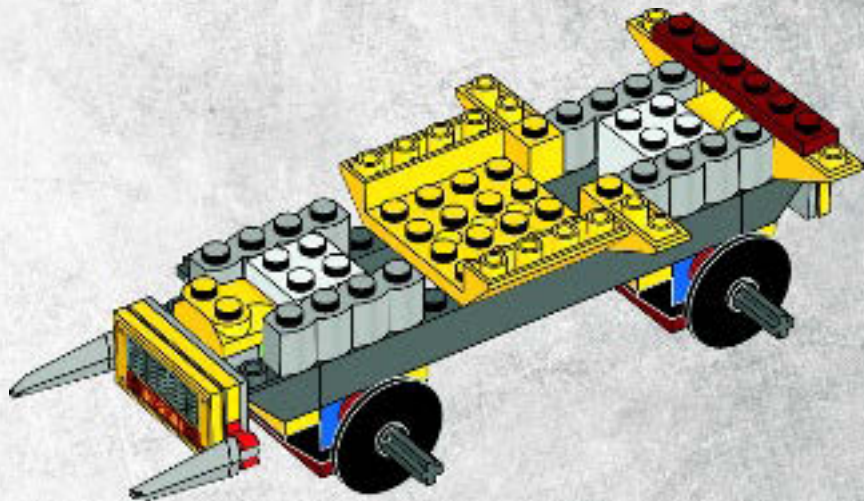





4x

16

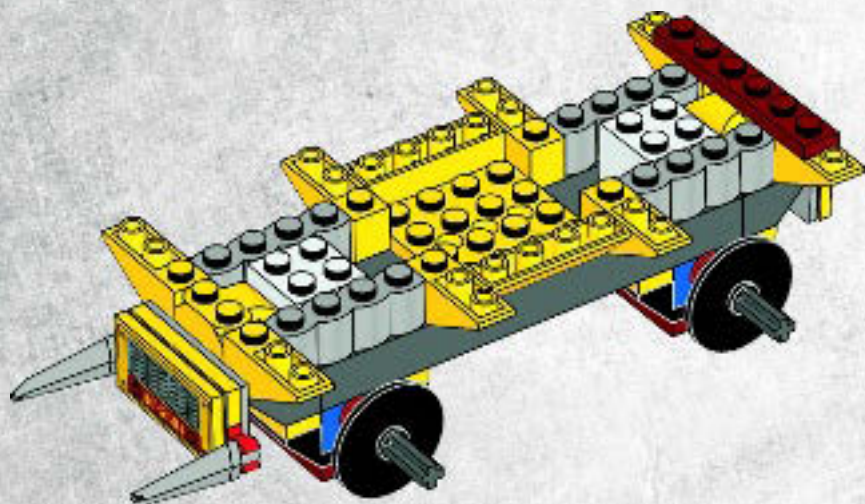

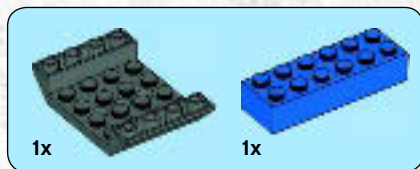

17

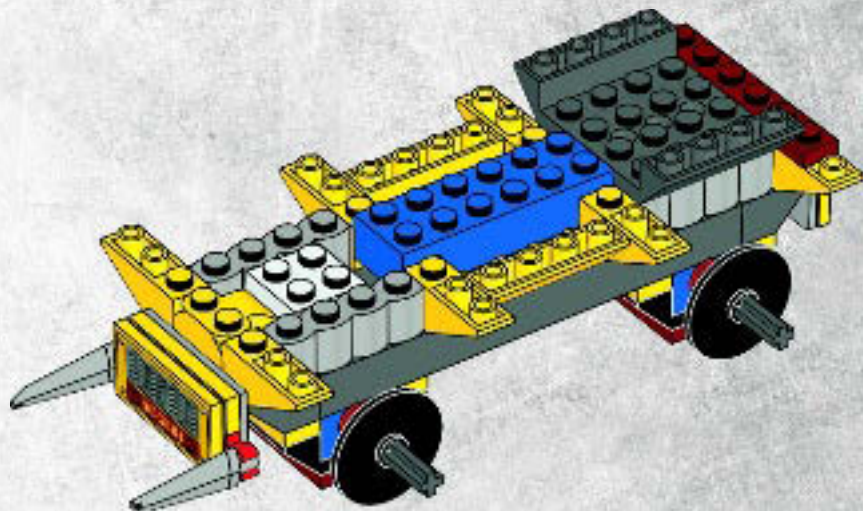

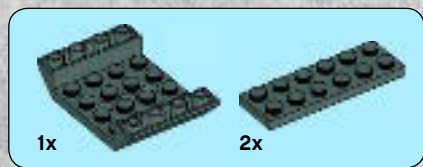

18

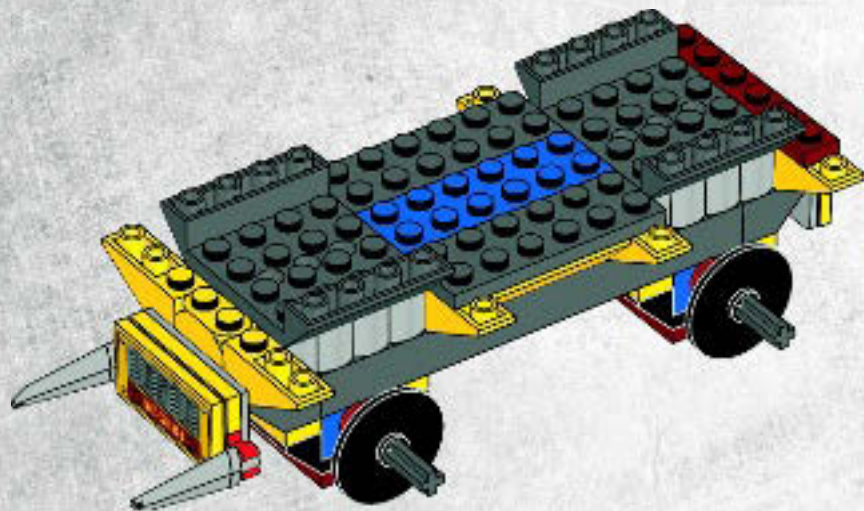





1x



2x

# 19

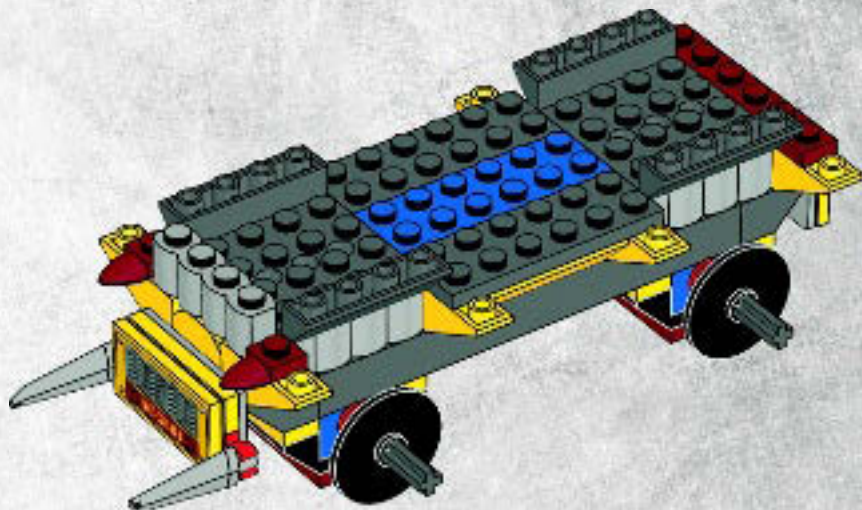





2



4x

20

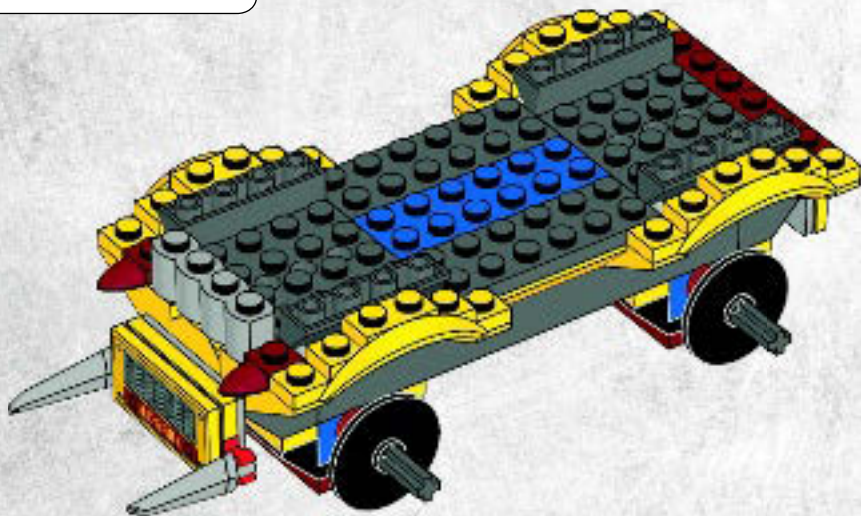



8x

21

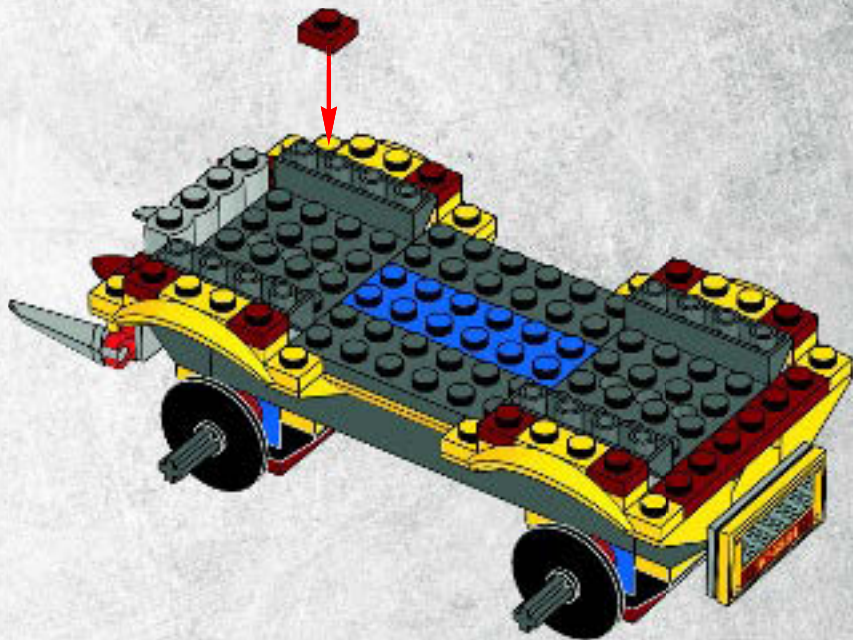



2x



2x

# 22



2x

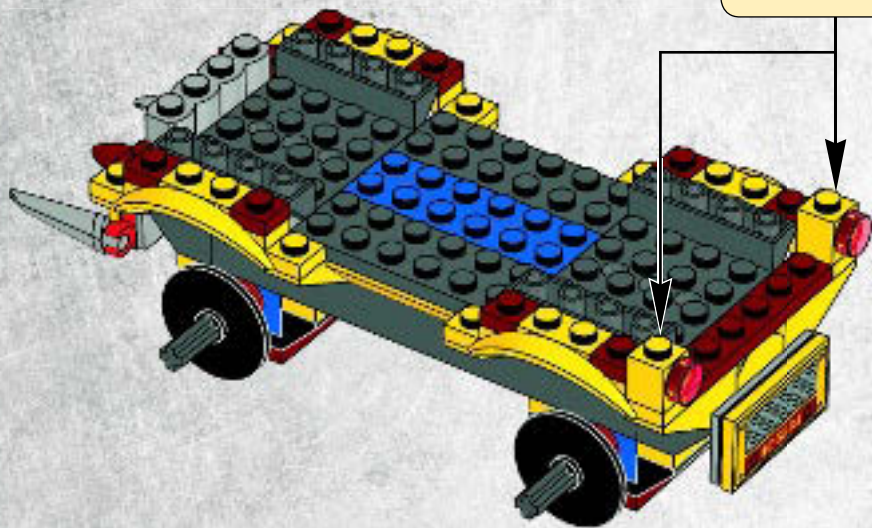





1x



2x

# 23

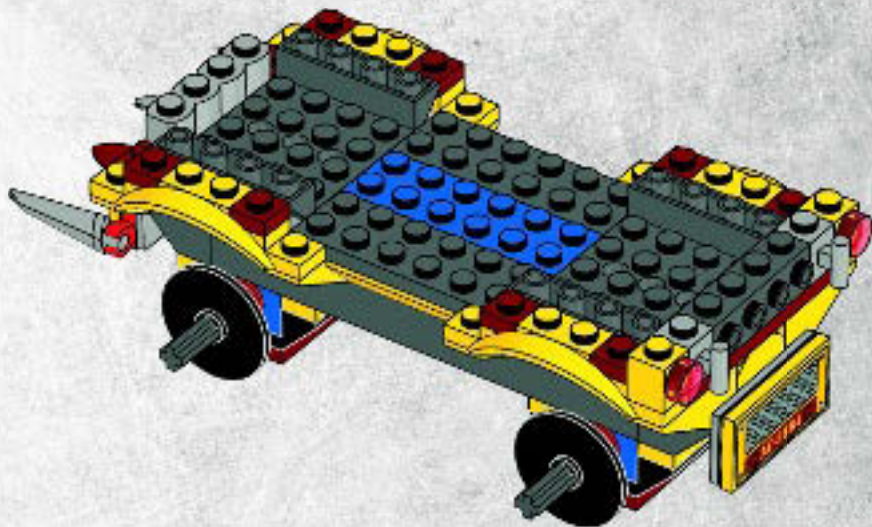





2x

# 24

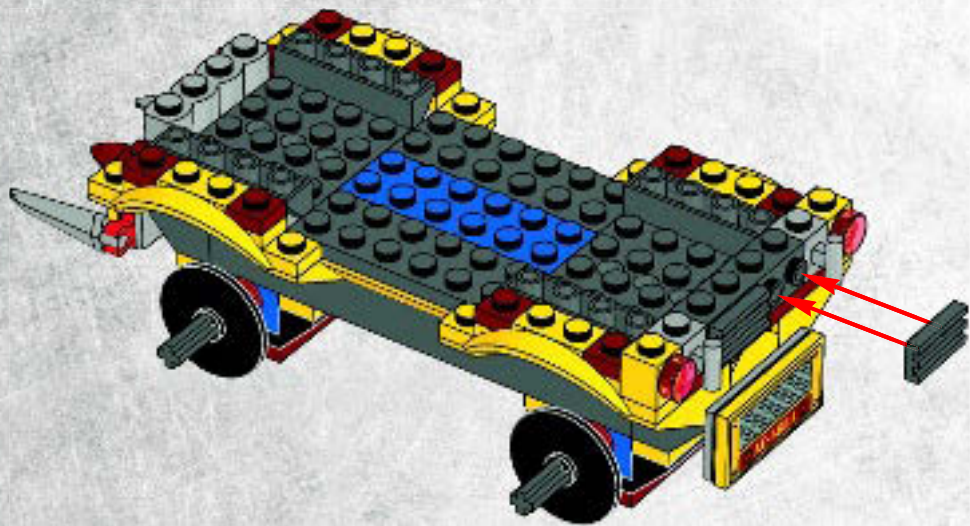



1x

25

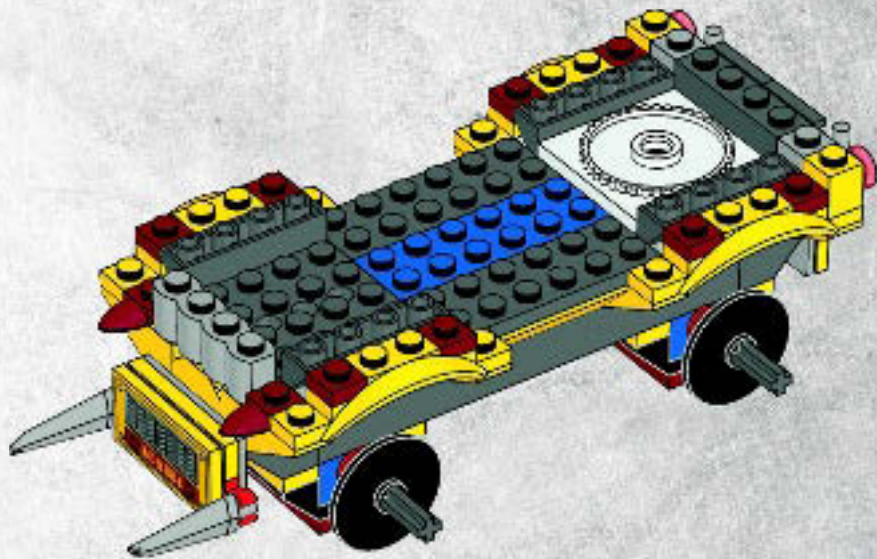



2x



4x

# 26

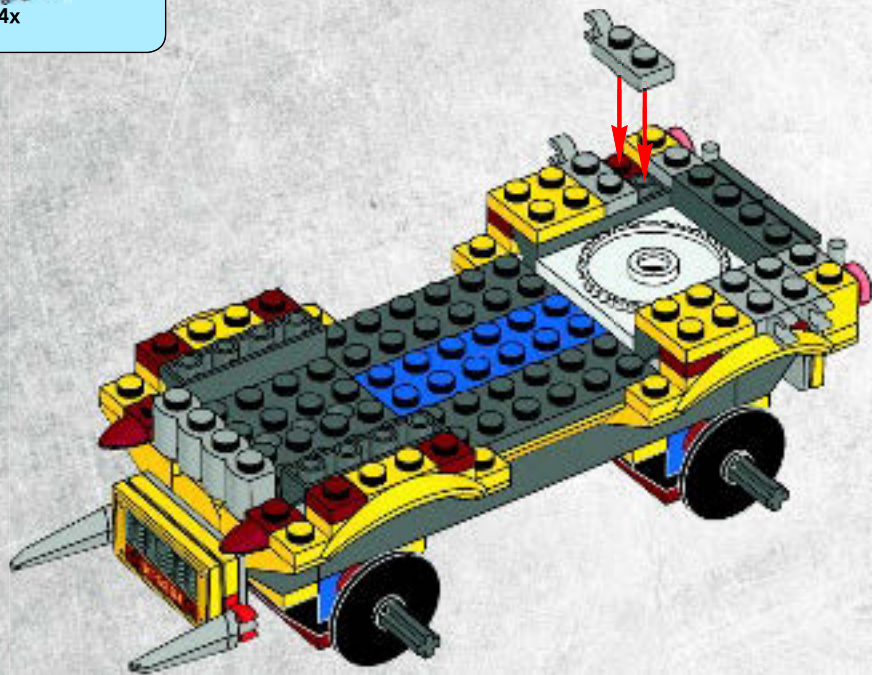





27

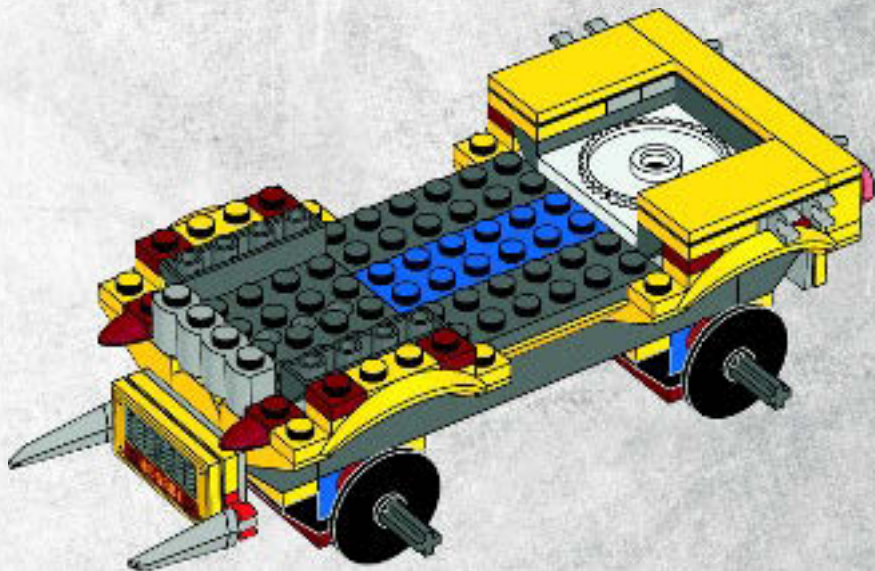



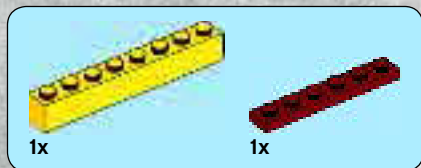

28

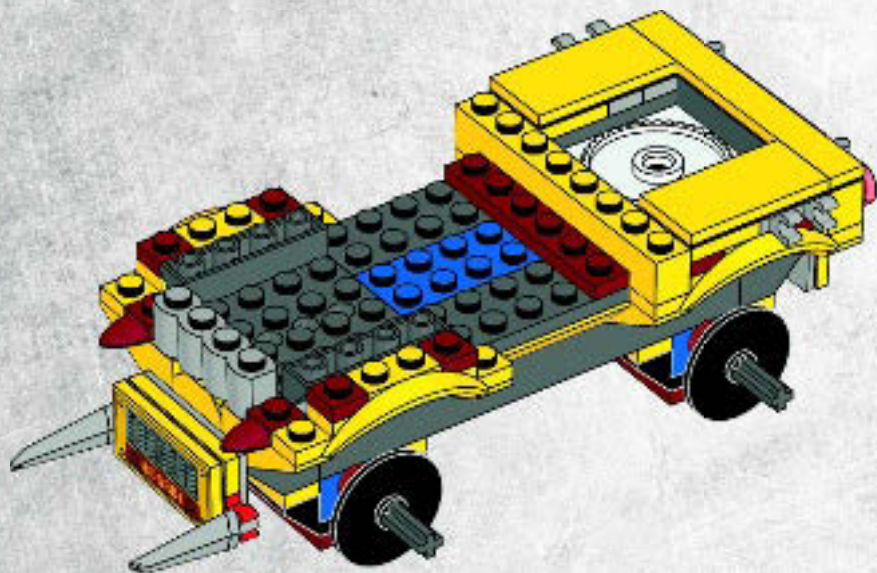



4x



1x

# 29

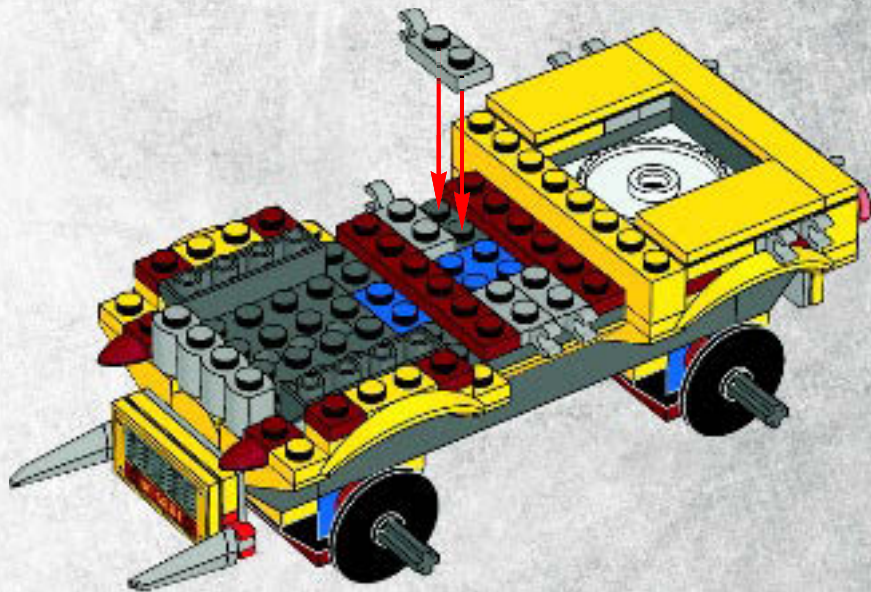



2x



1x

30

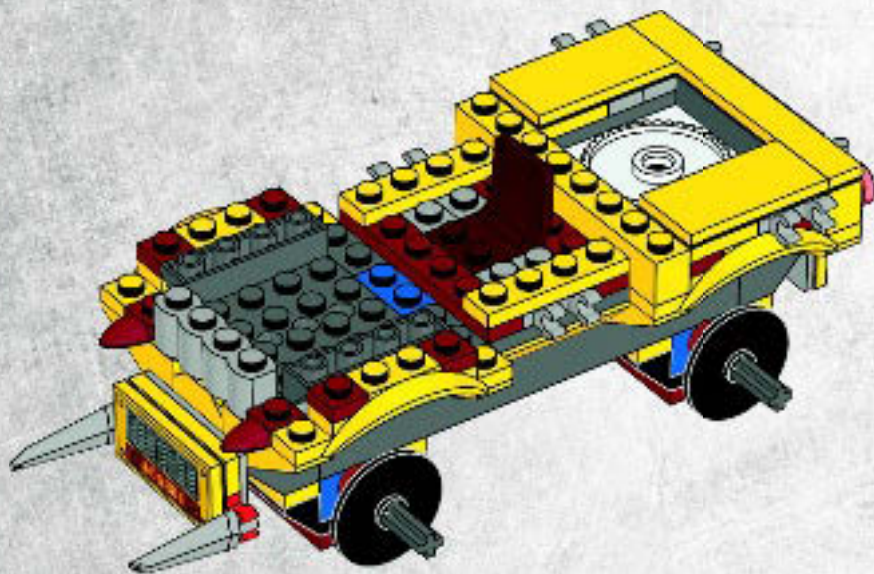



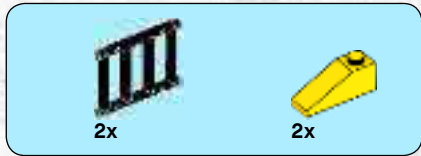

31

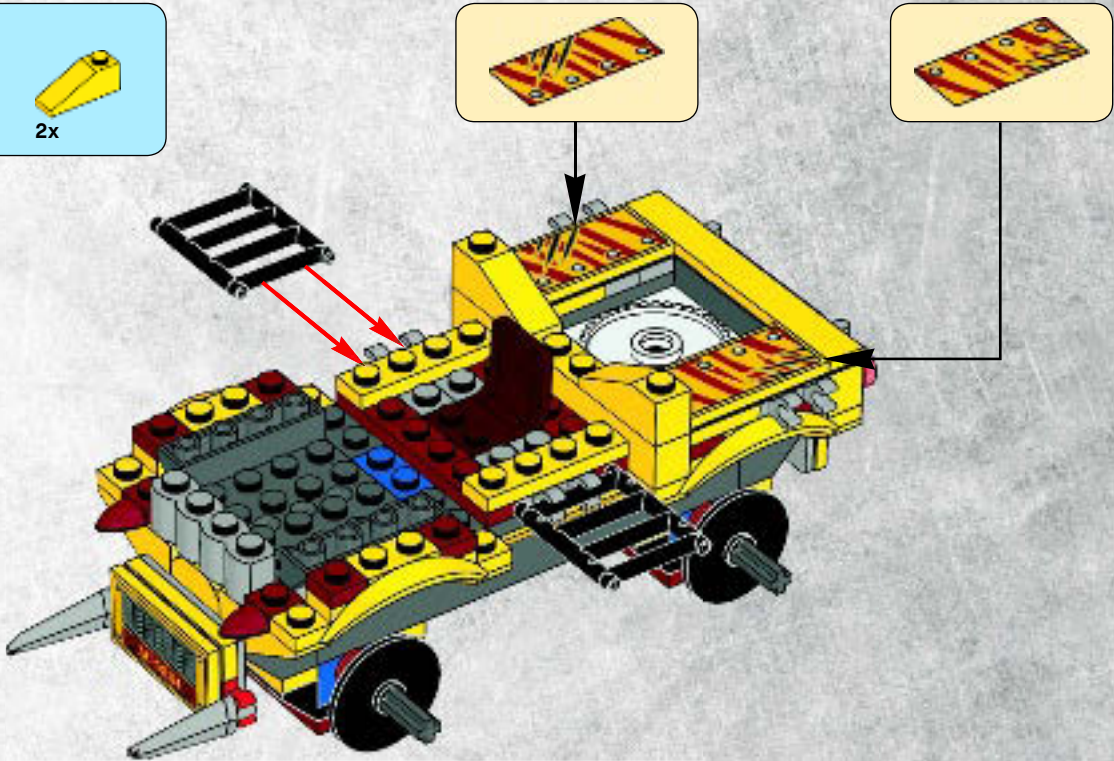





1x



1x



1x

# 32

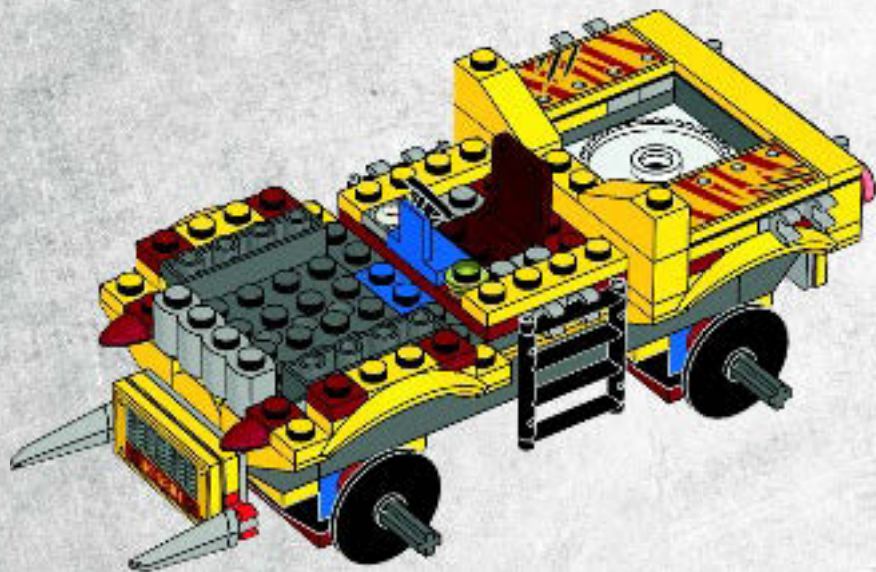

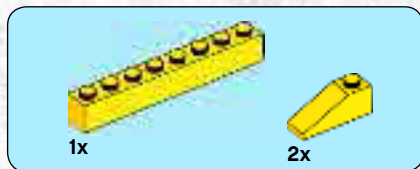

33

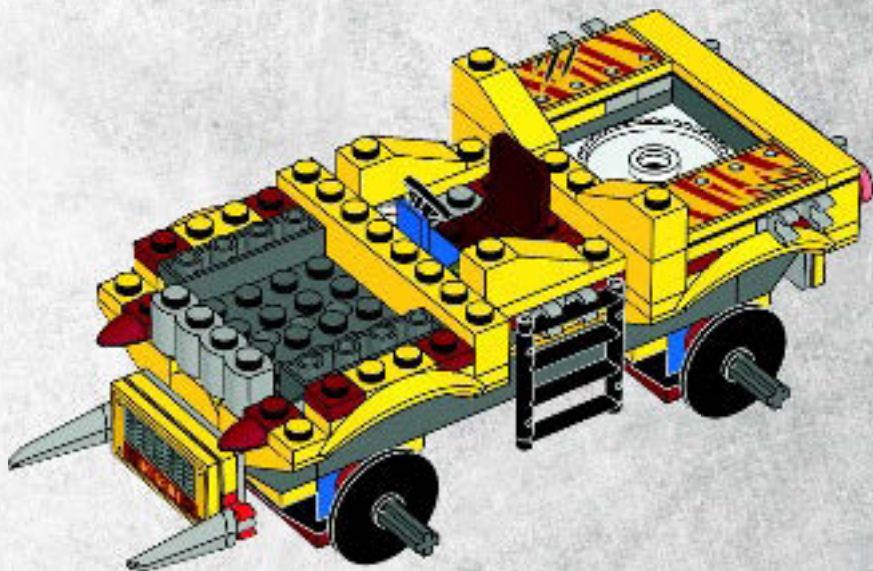



2x



2x

# 34

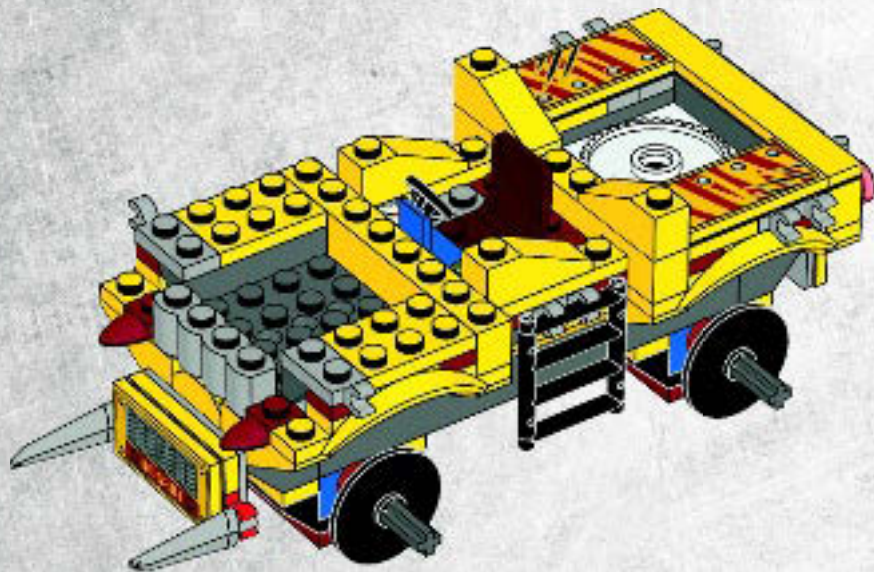





4x



4x



4x

# 35

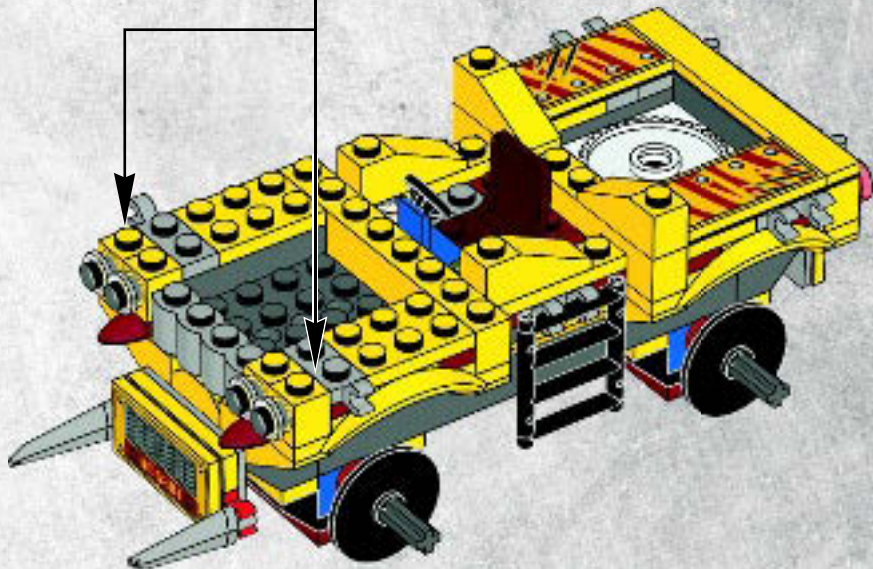



2x

# 36

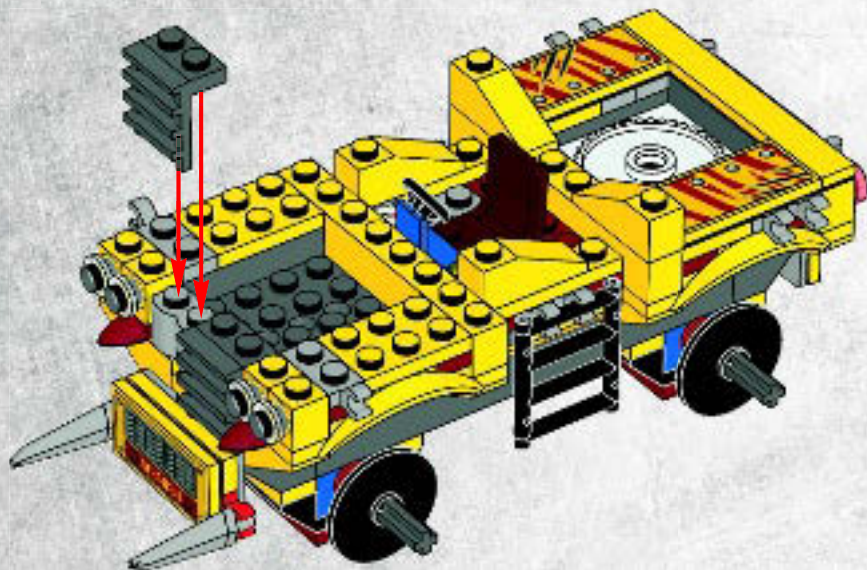

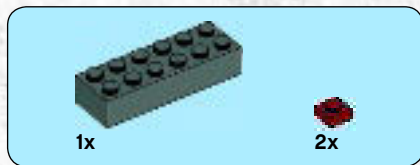

37

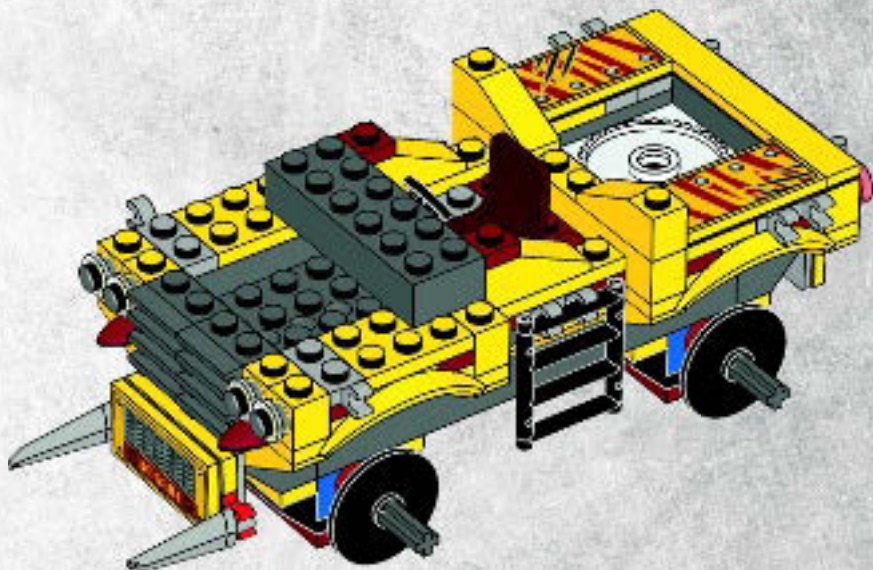





3x



2x

# 38

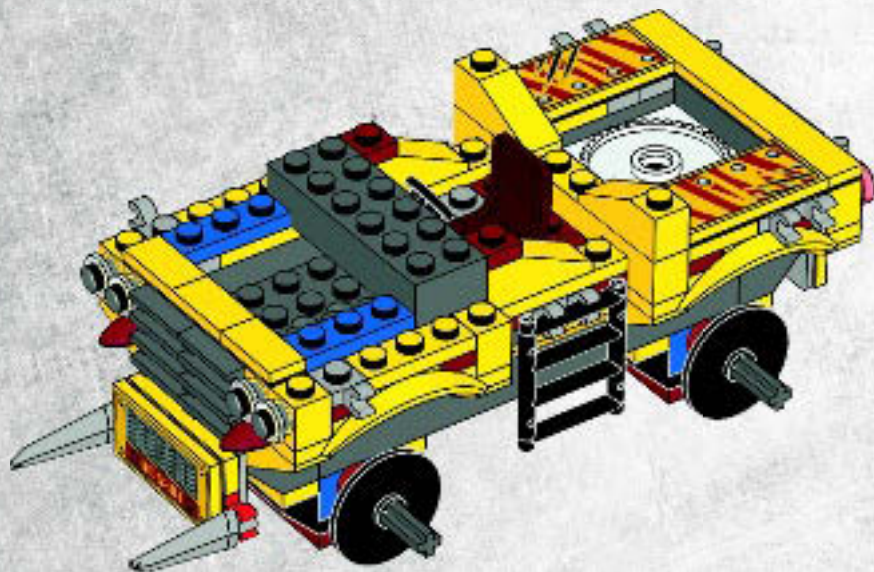



2x

39

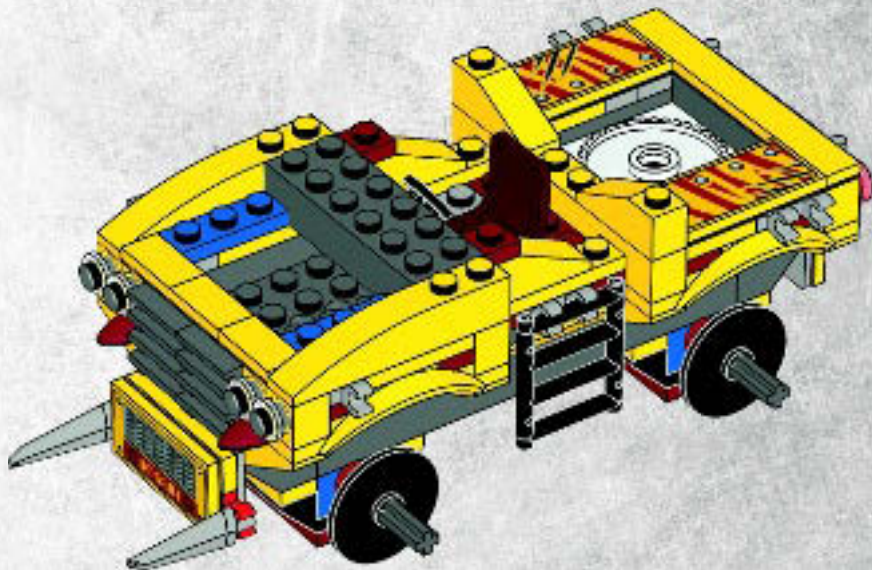



40

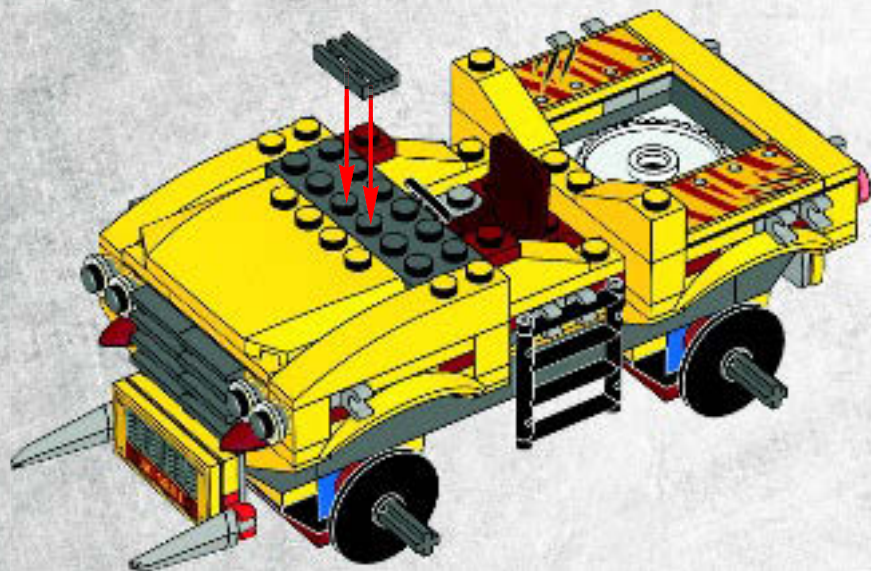





1x

# 41

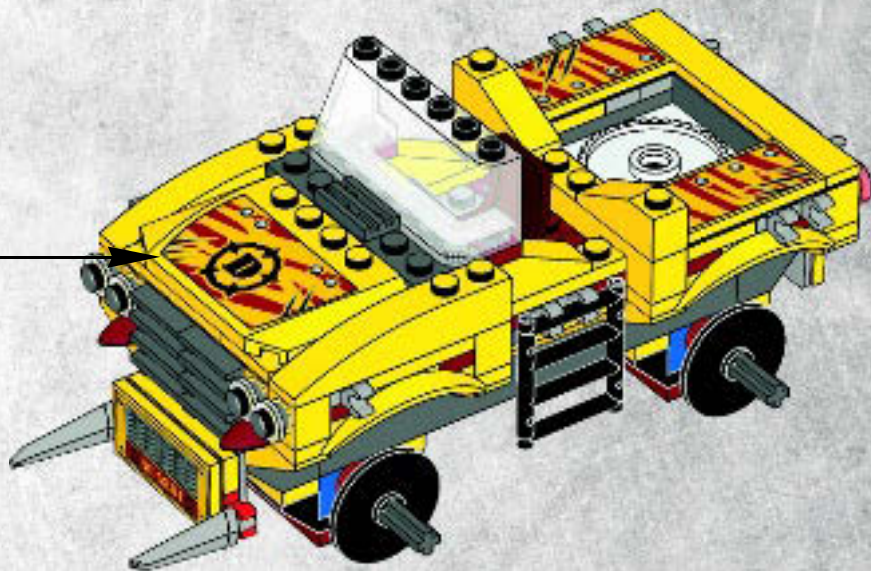

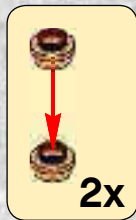
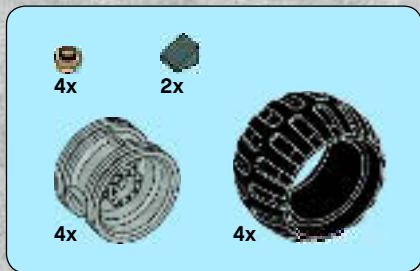

42

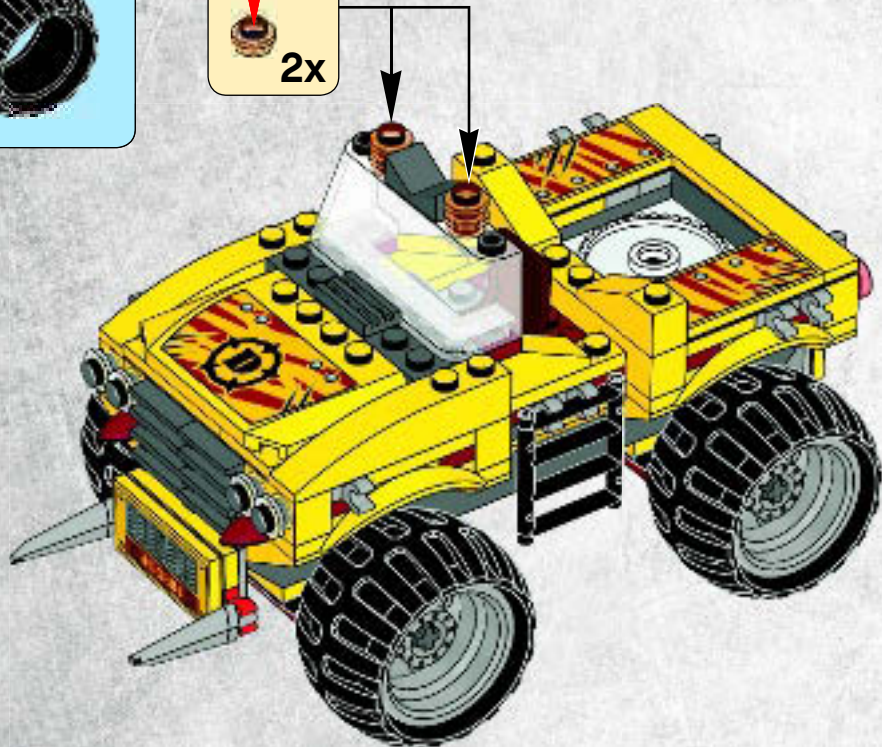

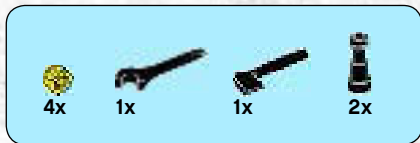

43

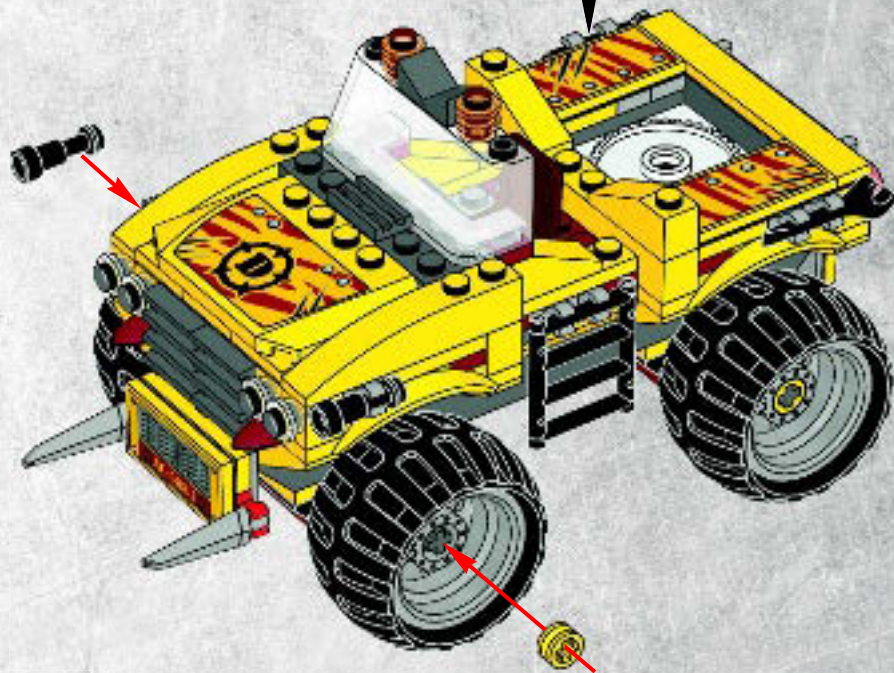





1

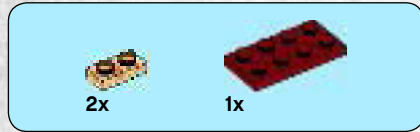
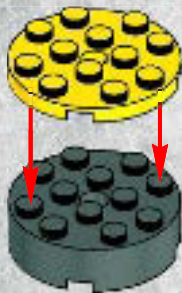

2

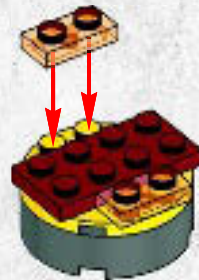



3

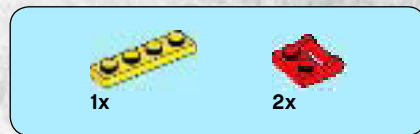

4

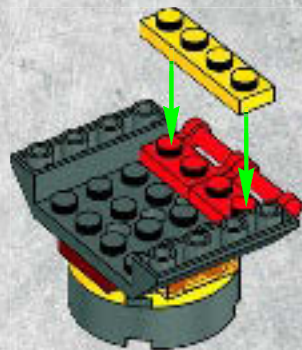

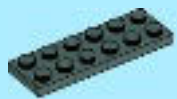

1x

5



2x



2x

6







7

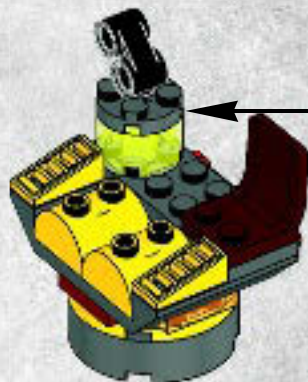
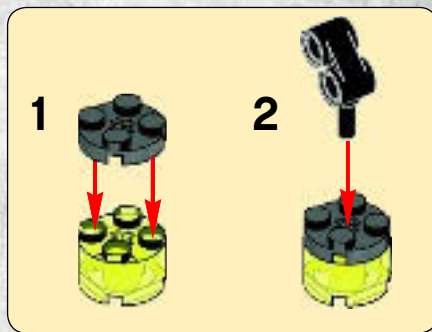

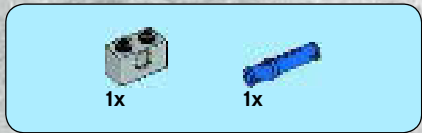

1

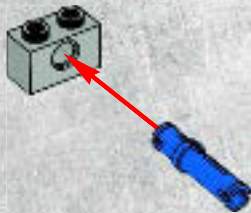

2





1x

3



1x

4

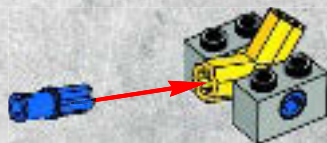





5

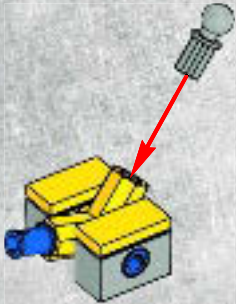

6

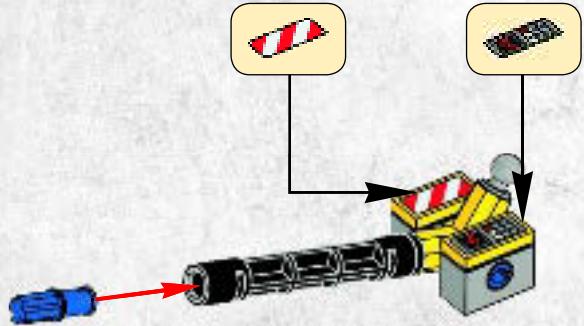



1x



1x

7



1x

8



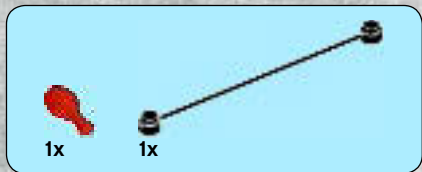

9

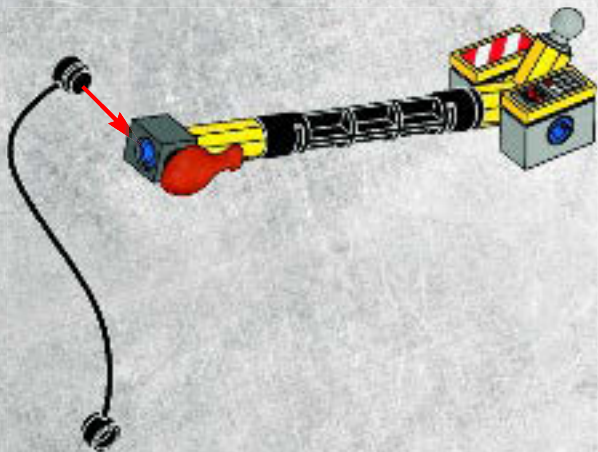

10





11

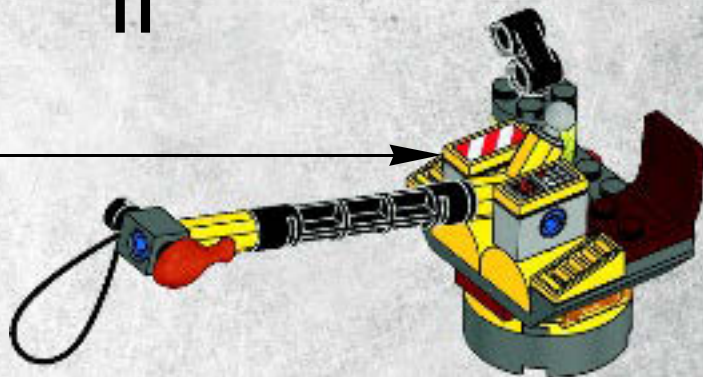



12

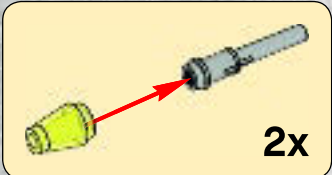
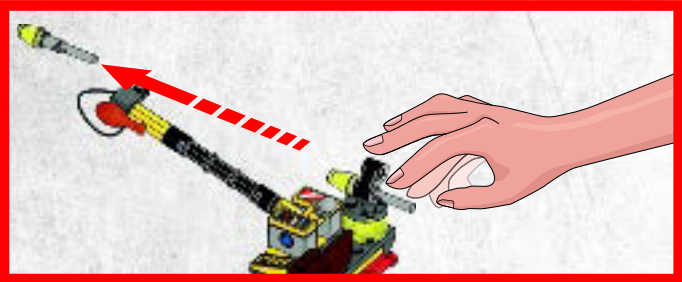

44

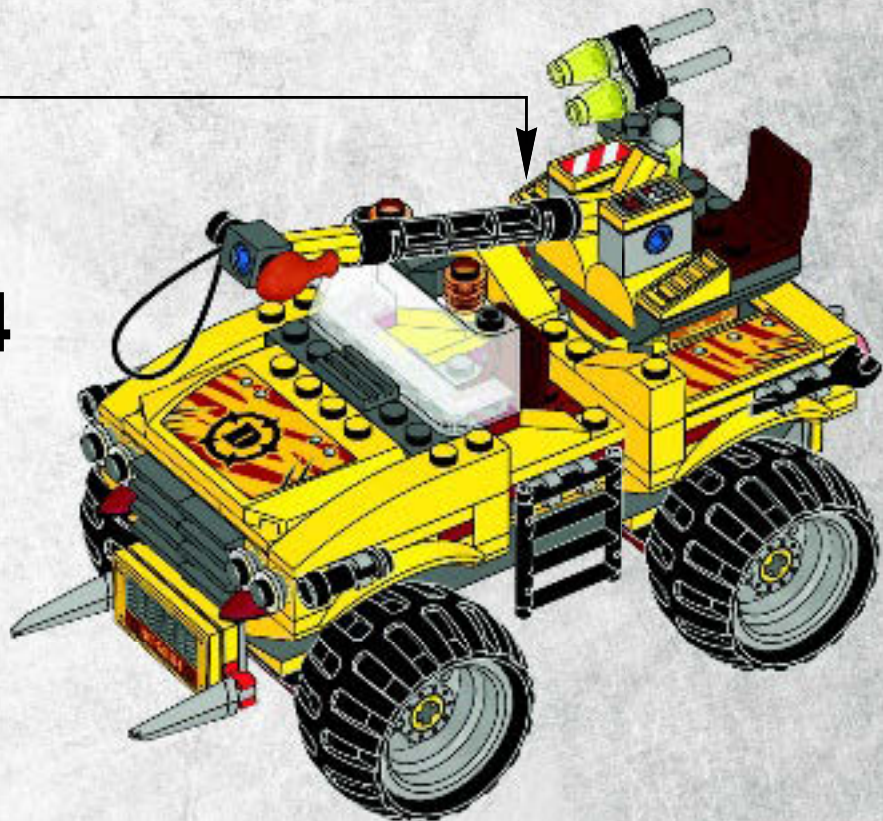



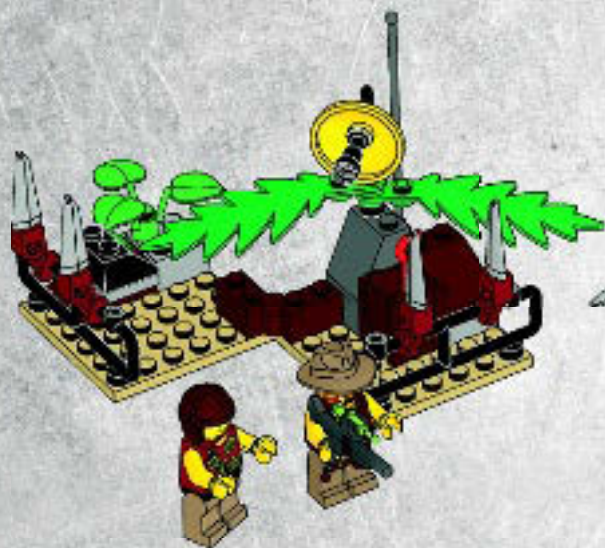



2x  
4109791



1x  
4611927



2x  
4258459



1x  
4107432



1x  
4263142



1x  
4549996



4x  
4523558



1x  
4189400



5x  
306924



6x  
4624985



8x  
428724



4x  
428624



2x  
4540384



2x  
4218699



1x  
4521998



1x  
4519010



1x  
4656483



1x  
4655810



4x  
4239601



2x  
4187061



2x  
302224



2x  
302124



1x  
4616180



8x  
371024



4x  
4560181



1x  
4515349



2x  
4160392



2x  
300824



2x  
4588003



2x  
4226876



1x  
4599453



4x  
4227155



3x  
4206482



1x  
9566



4x  
370023



1x  
4514553



2x  
362323



1x  
4181139



4x  
4218868



2x  
4521681



1x  
395726



2x  
4658977



4x  
4518826

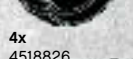

2x  
4544645



1x  
4155558



1x  
4528331



3x  
4538456



1x  
4562148



1x  
4121715



1x  
383526



1x  
400626



1x  
4295400



1x  
4278013



4x  
3005740



2x  
4646864



2x  
4216625



1x  
4520638



2x  
4211206



1x  
4656487



1x  
4507049



1x  
4215448



1x  
4215449



2x  
4125217



1x  
4502193



2x  
4567334



1x  
611649



1x  
3005749



3x  
4164037



2x  
4654583



10x  
4539114

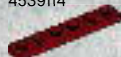

3x  
4539062



3x  
4539071



1x  
4541522



1x  
4655815



4x  
4626928



2x  
4275573



2x  
4225532



5x  
4211833



2x  
4211440



1x  
4255629



12x  
4535738



2x  
4613165

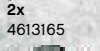

4x  
4297210



2x  
4520320



1x  
4211375



2x  
4211387



6x  
4616840



1x  
4655847



1x  
4578851



1x  
4656727



2x  
4280341



4x  
4222960



1x  
4654423



1x  
4656246



1x  
4656237



1x  
4656243



1x  
4656269



1x  
4656265



1x  
4656251



1x  
4656256



1x  
4656256

1x  
4656256

1x  
4211051



1x  
4211085



1x  
4558959



3x  
4549999



3x  
4549999



3x  
4211002



1x  
4210875



1x  
4210875



1x  
4210642



2x  
4210798



1x  
4210725

1x  
421042



1x  
4210725



4x  
4560177



1x  
4210639



2x  
4504378



1x  
4234534



4x  
4211000



3x  
4210631



2x  
4603504



1x  
4211042



1x  
4211042

1x  
4211042



**Customer Service**  
**Kundenservice**  
**Service Consommateurs**  
**Servicio Al Consumidor**

[www.lego.com/service](http://www.lego.com/service) or dial



00800 5346 5555 :

1-800-422-5346 :





5882



5884



5883



5885



5886



5887







www.LEGOclub.com



LEGO® Club Email



LEGO® Club Magazine

**LEGO** club™

**FREE! GRATIS! GRATUIT!**

**SIGN UP ONLINE!**

**www.LEGOclub.com**



**00800 5346 5555\***



**1-866-534-6258 • 1-877-518-5346**

US & Canada only

Canada only

- \* Freephone. Mobile charges may apply.
- \* Numéro sans frais. Des frais peuvent s'appliquer avec les téléphones cellulaires.
- \* Gebührenfrei, Kosten für Anrufe aus Mobilfunknetzen können abweichen.
- \* Gratis telefonnummer vanaf vaste lijn.
- \* Det er et gratis nummer, når du ringer fra fasttelefon.
- \* Det är gratis, när du ringer från en fast telefon.
- \* Numéro sans frais. Des frais peuvent s'appliquer avec les téléphones portables.





# WIN!

Go to [www.LEGOsurvey.com/product](http://www.LEGOsurvey.com/product) to fill out a survey for a chance to win a cool LEGO® Product.

No purchase necessary.

Open to all residents where not prohibited.



## [www.LEGOsurvey.com/product](http://www.LEGOsurvey.com/product)

### GEWINNE!

Nimm an der Umfrage auf [www.LEGOsurvey.com/product](http://www.LEGOsurvey.com/product) teil und hab die Chance ein cooles LEGO® Produkt zu gewinnen!

Die Teilnahme am Gewinnspiel führt zu keinerlei Kaufverpflichtungen. Teilnahme in allen nicht ausgeschlossenen Ländern möglich.

### WIN!

Ga naar [www.LEGOsurvey.com/product](http://www.LEGOsurvey.com/product), vul een enquêteformulier in en maak kans op een cool LEGO® product.

Geen aankoopverplichting. Iedereen mag deelnemen, uitgezonderd ingezetenden van landen waar een enquêteverbod geldt.

### GAGNE!

Visite [www.LEGOsurvey.com/product](http://www.LEGOsurvey.com/product) pour répondre à un questionnaire et avoir une chance de gagner un produit LEGO® très cool!

Aucune obligation d'achat. Ouvert à tous les résidents des pays autorisés.

### 当てよう!

[www.LEGOsurvey.com/product](http://www.LEGOsurvey.com/product) にアクセスして、アンケートにご記入ください。当選者にはレゴ®製品を差し上げます。

お買い上げの必要はありません。禁止されていない限り、すべての皆様にご利用いただけます。



[www.LEGO.com](http://www.LEGO.com)

6005744

LEGO and the LEGO logo are trademarks of the/son des marques de commerce de/son marcas registradas de LEGO Group. ©2012 The LEGO Group.