



DINO



5885



1

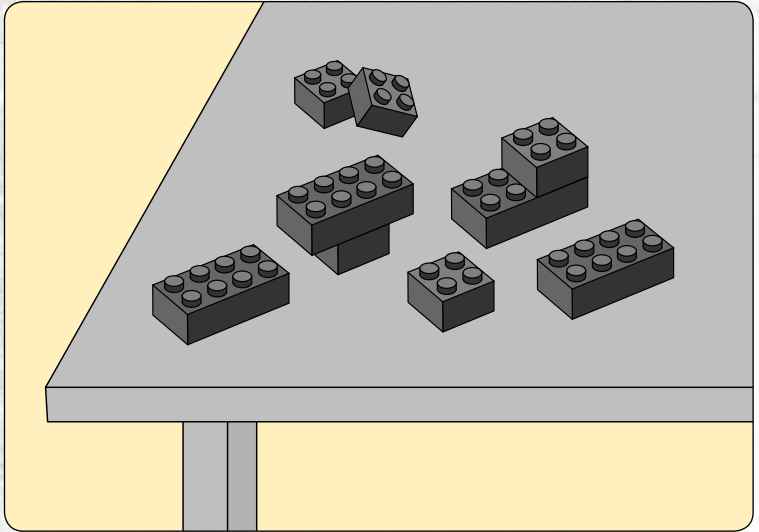
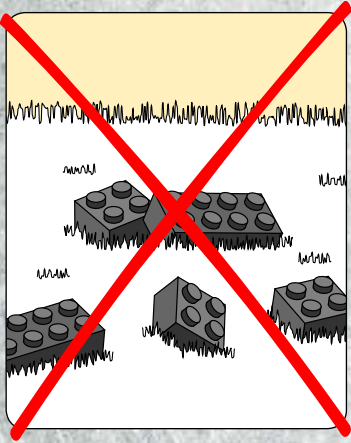

2



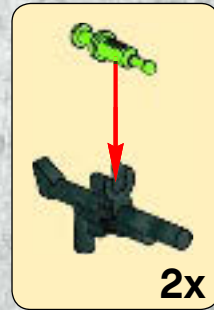
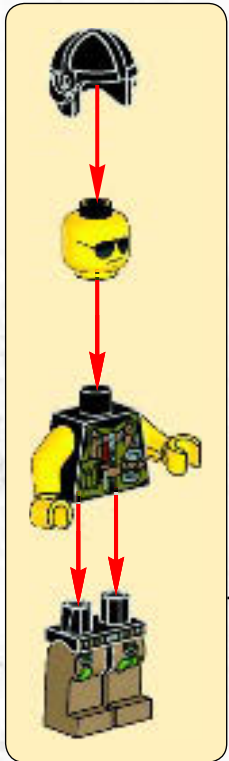
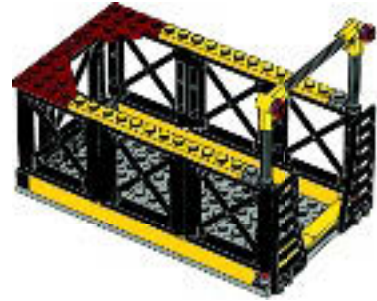
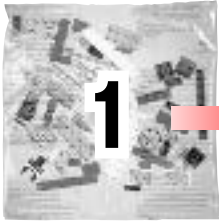

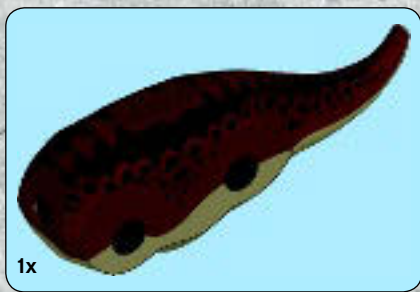

1

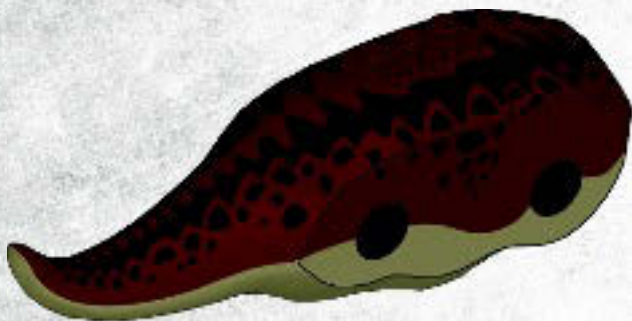

2

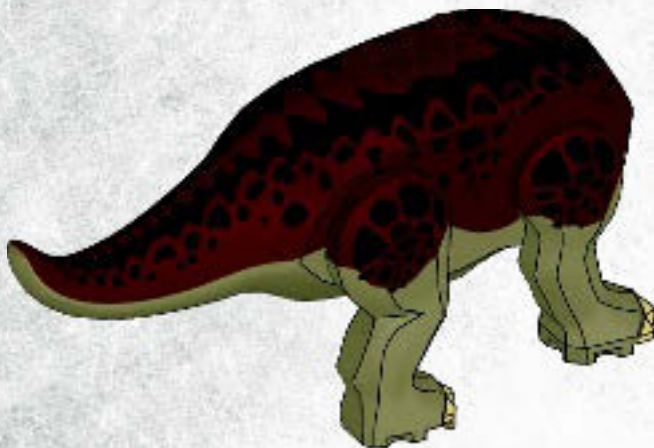

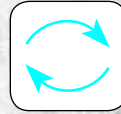
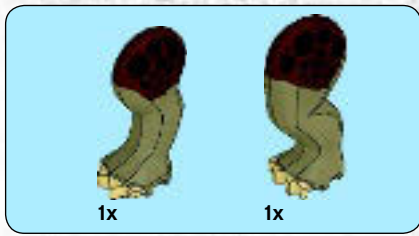

3

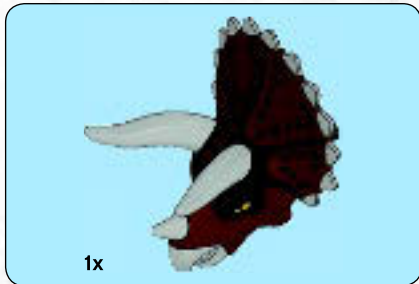

4



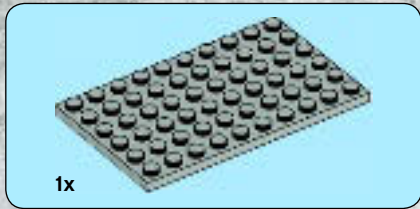
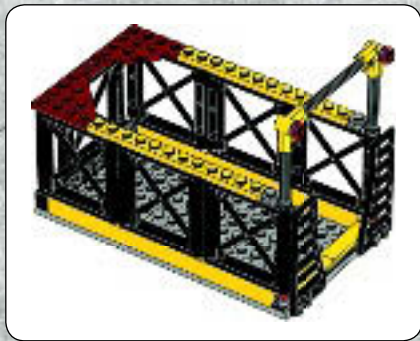

1

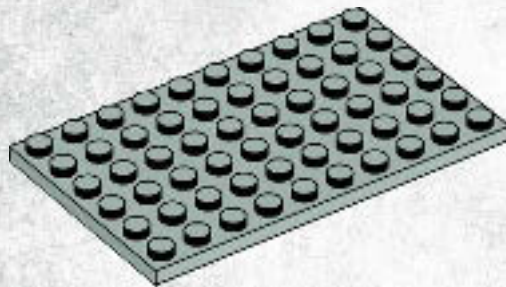

2

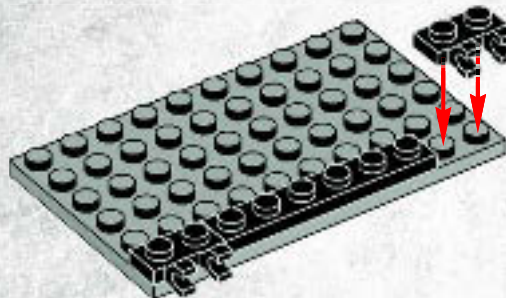



3

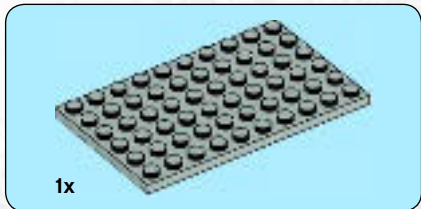
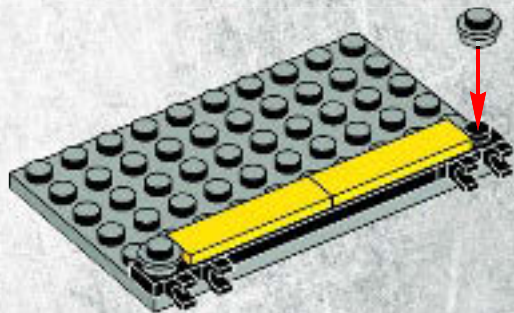

4

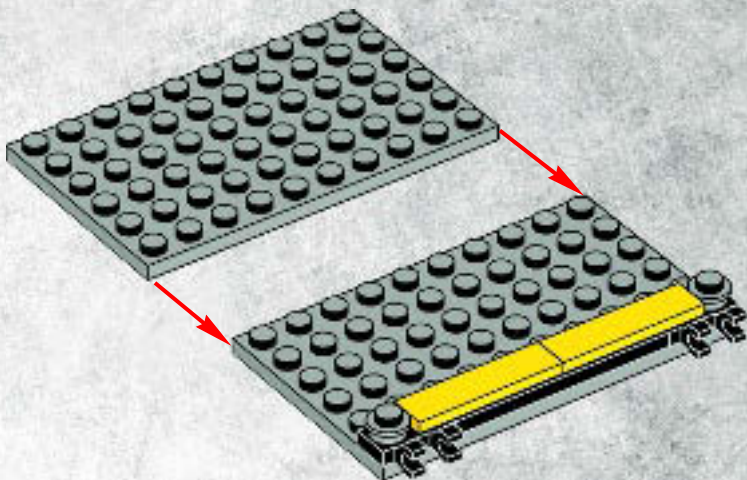

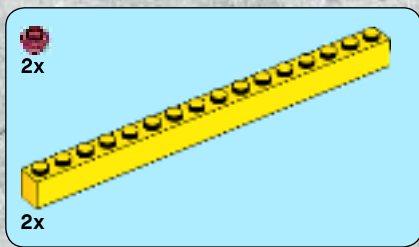

5

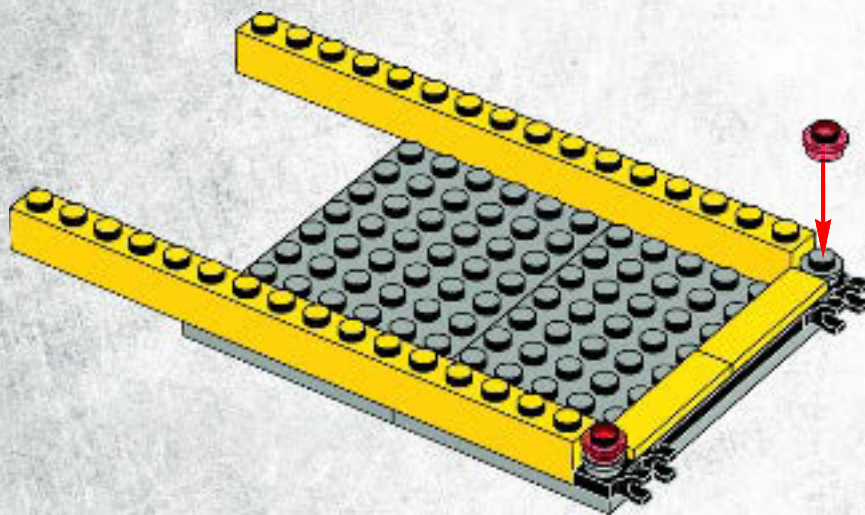

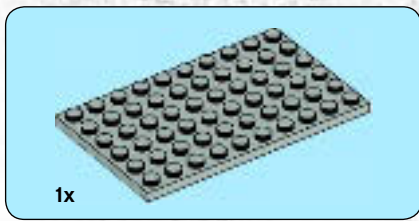

6

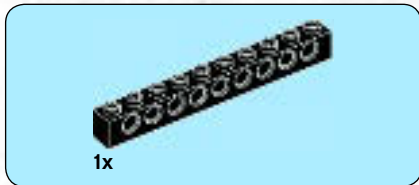
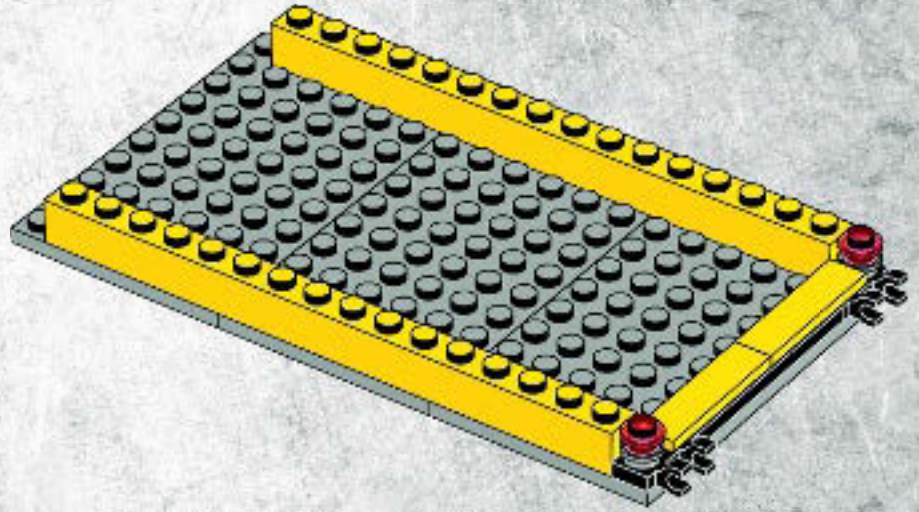

7

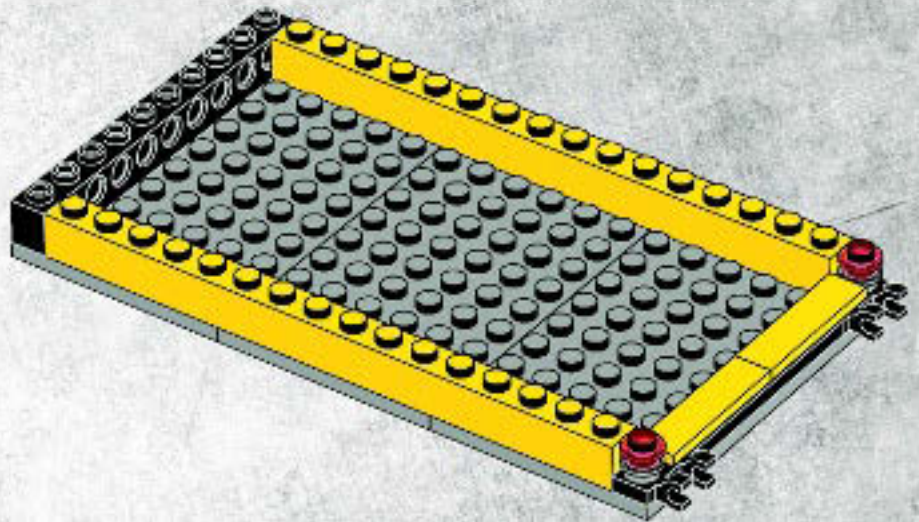

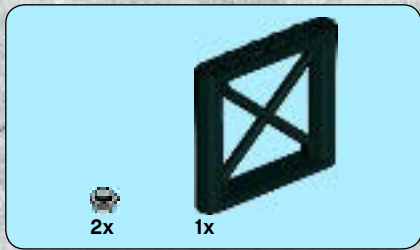

8

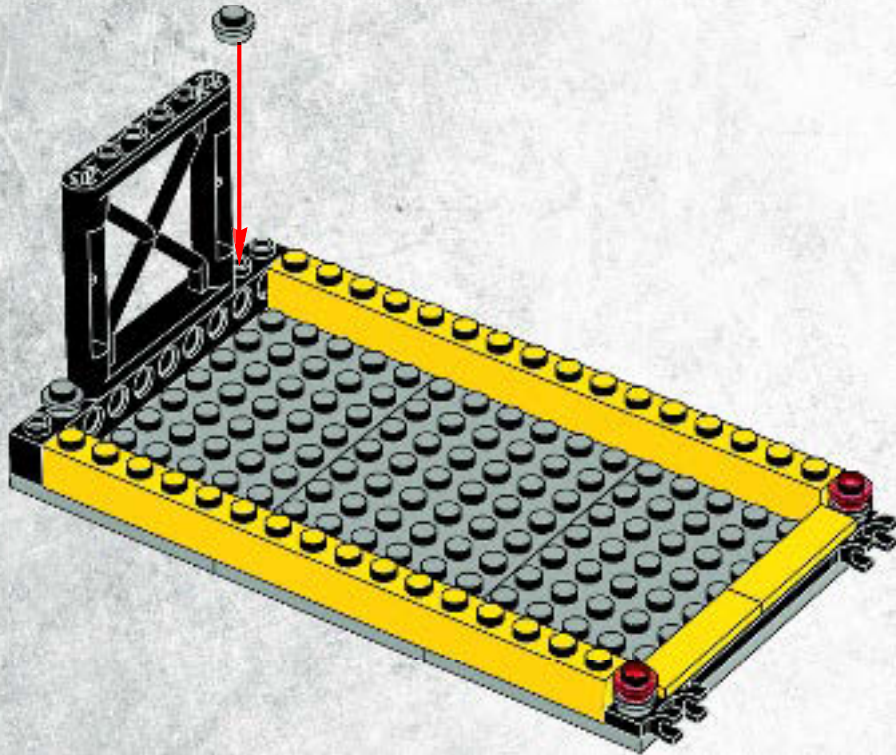



9

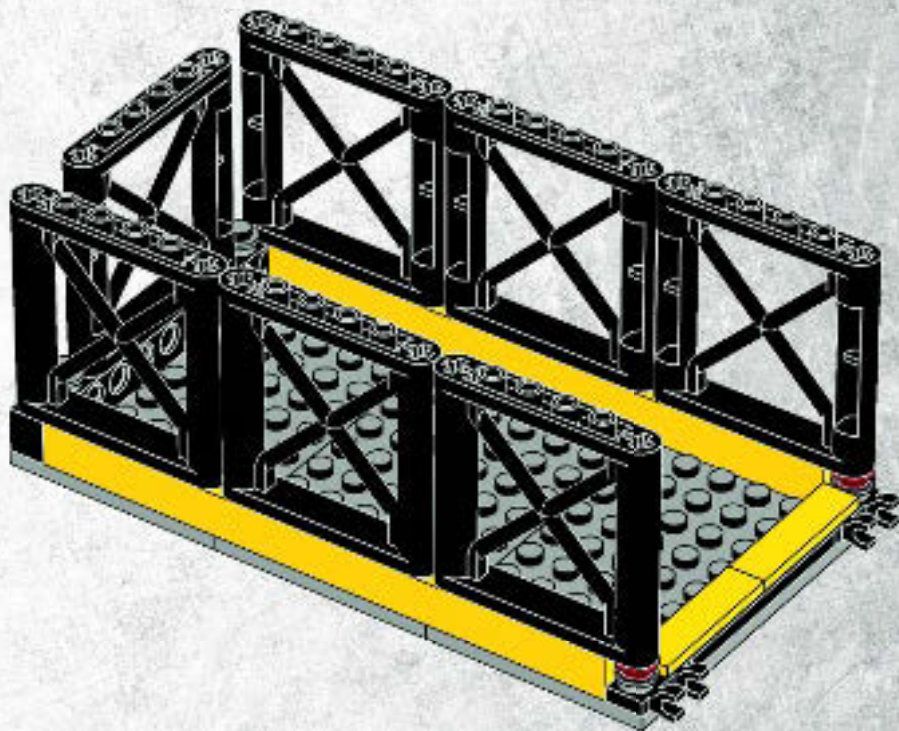



10

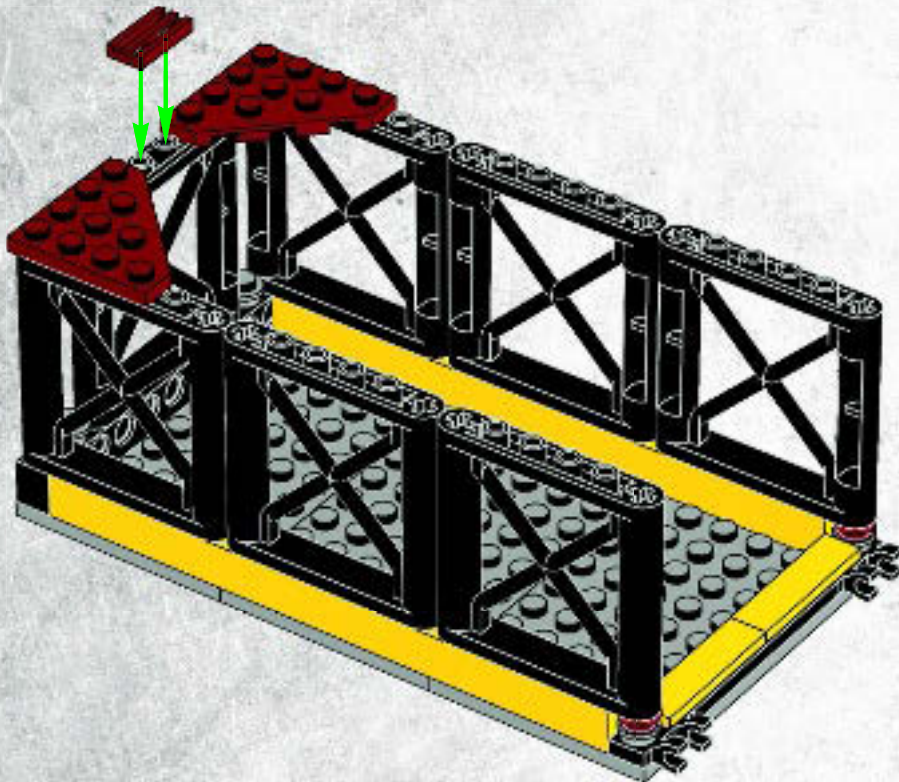



2x



2x

11

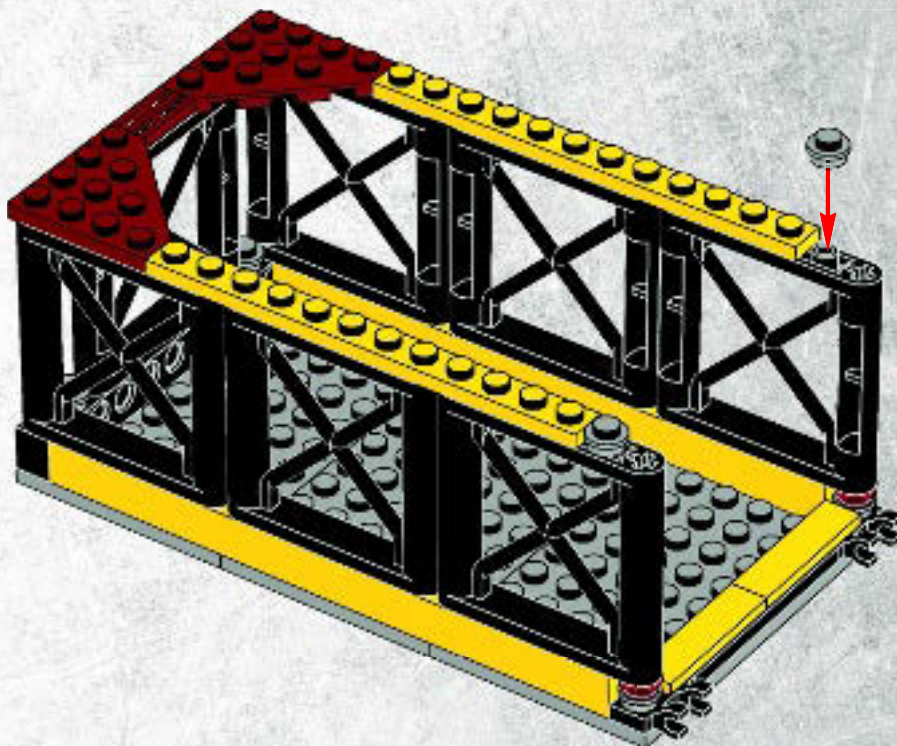



2x

12

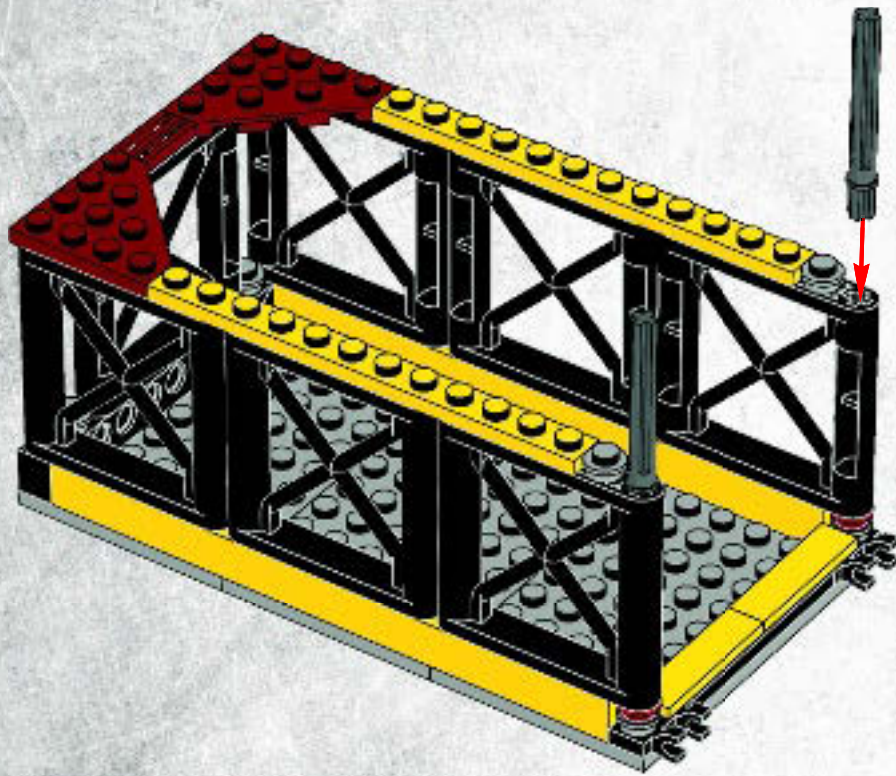

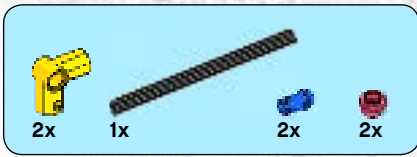

13

1



2

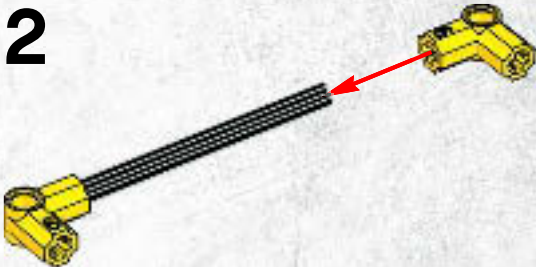

3

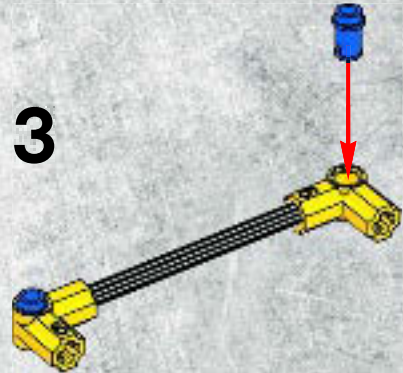

4

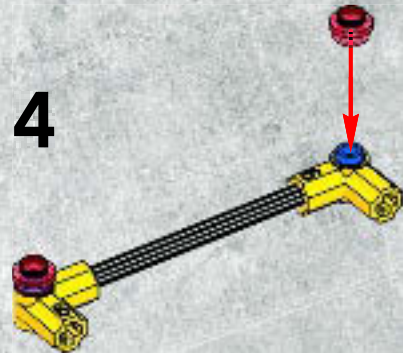

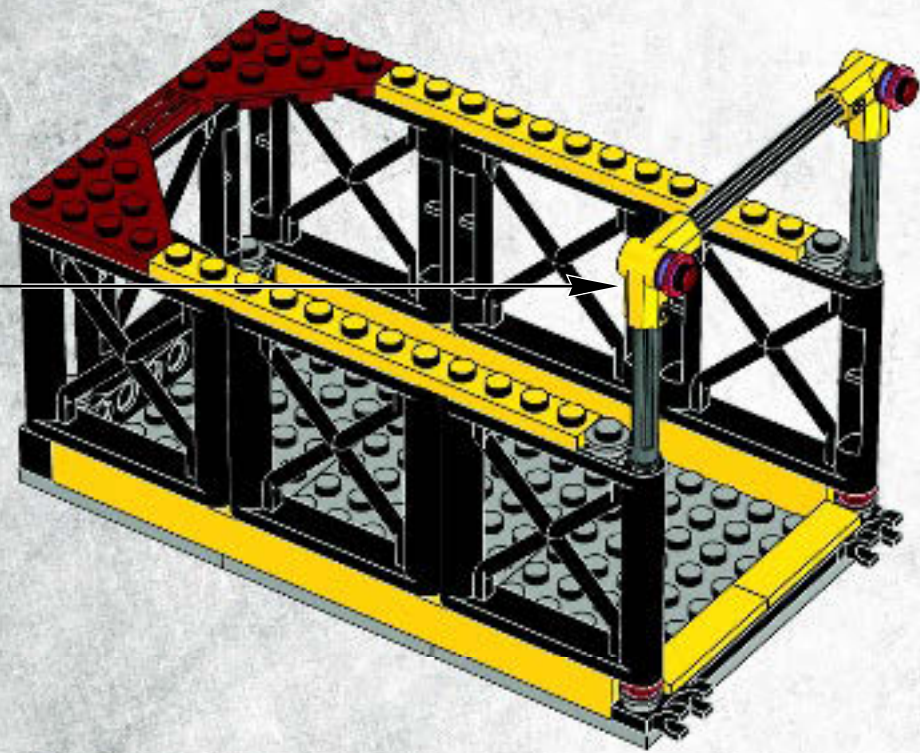



2x

14

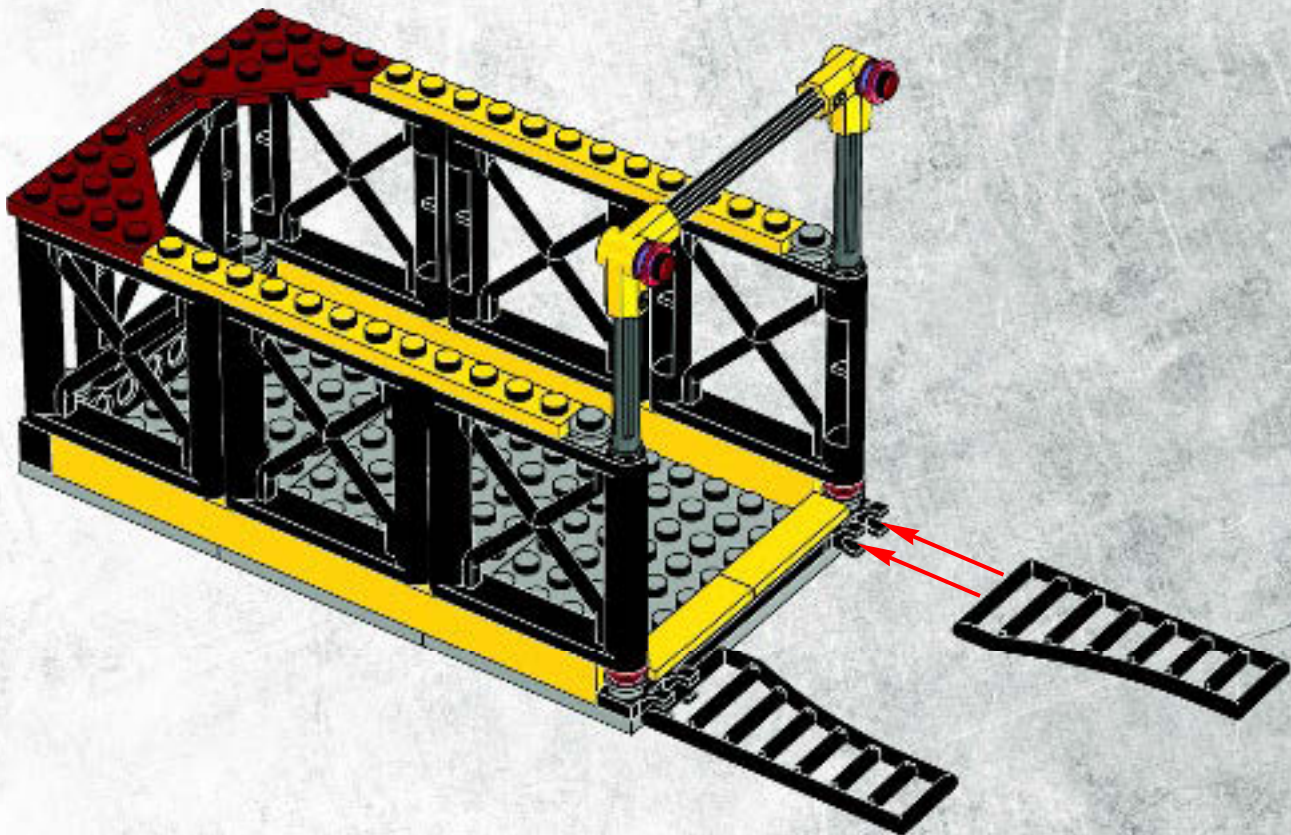

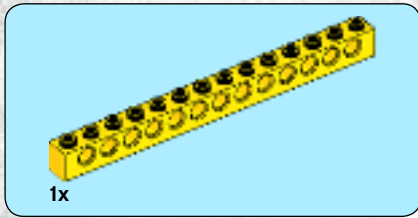

1

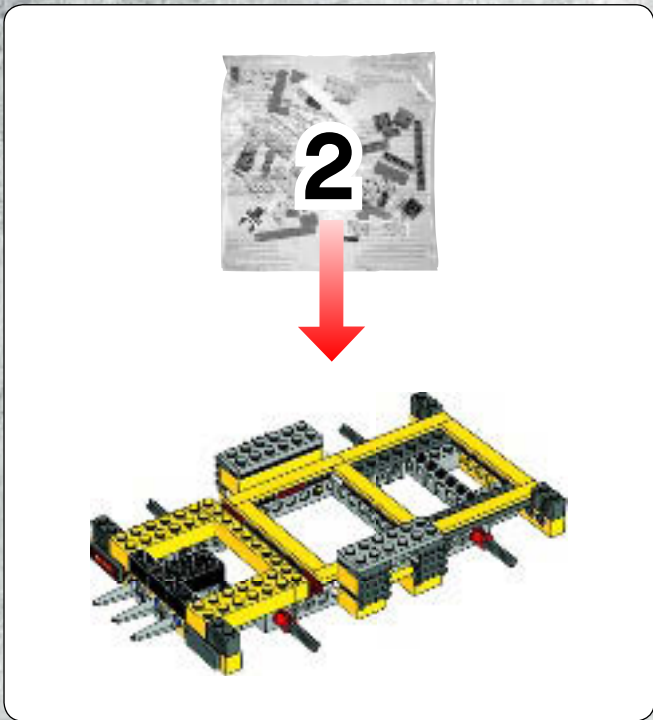
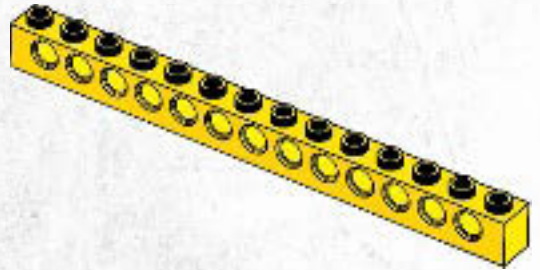

2

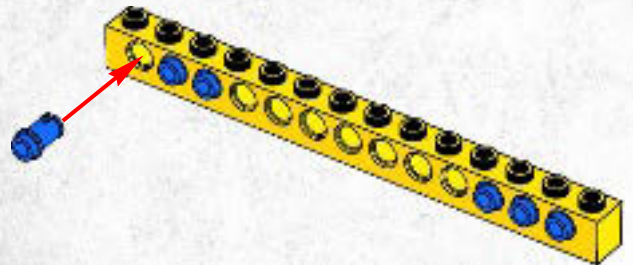



3

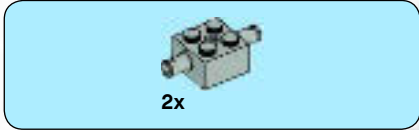

4

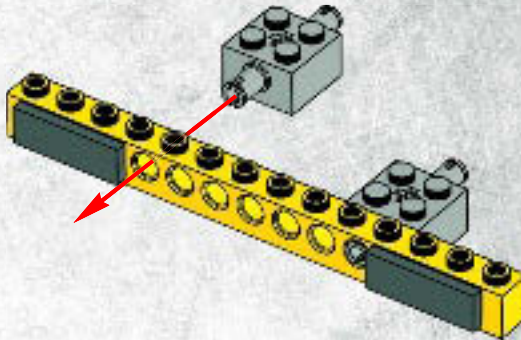



5x

5

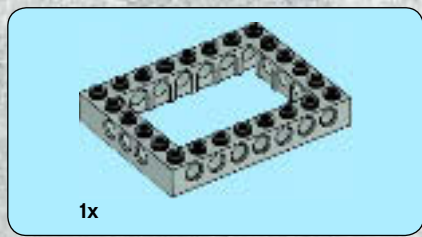
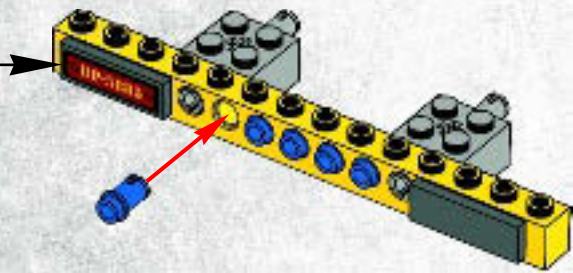

1x

6

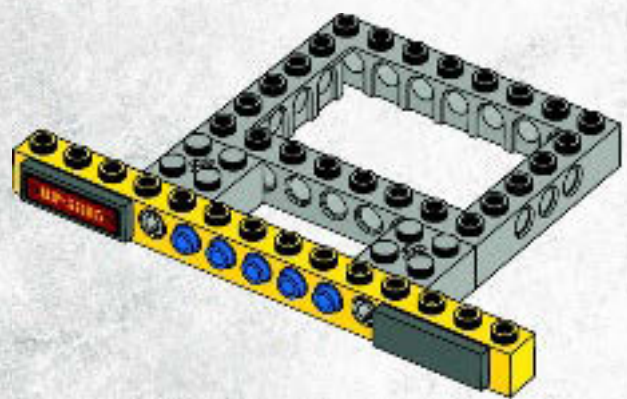



2x



3x

7

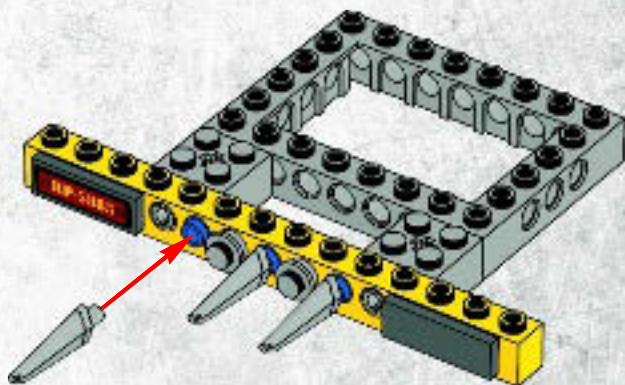

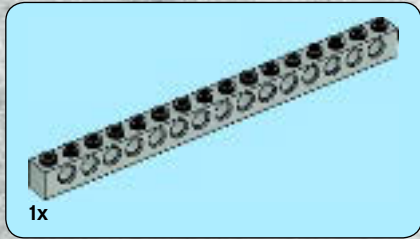

1x

1



1x

1x

2

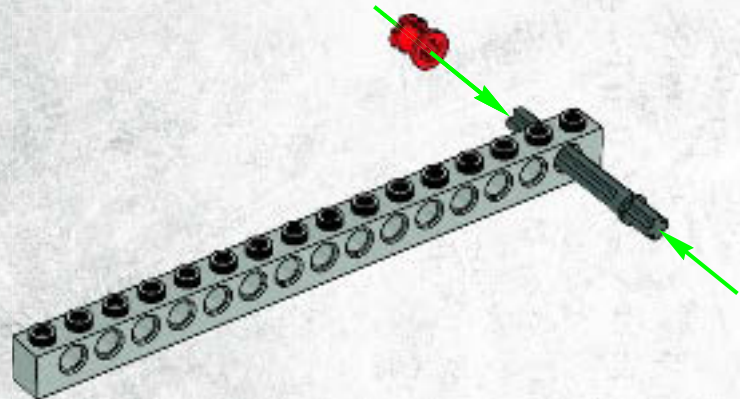



3

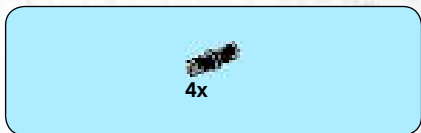
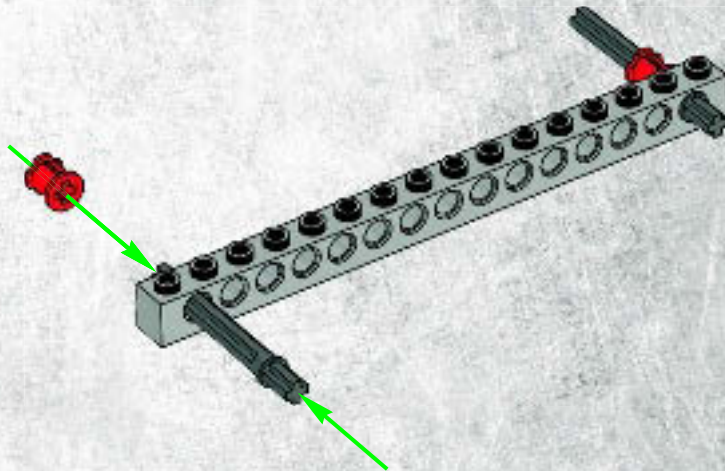

4

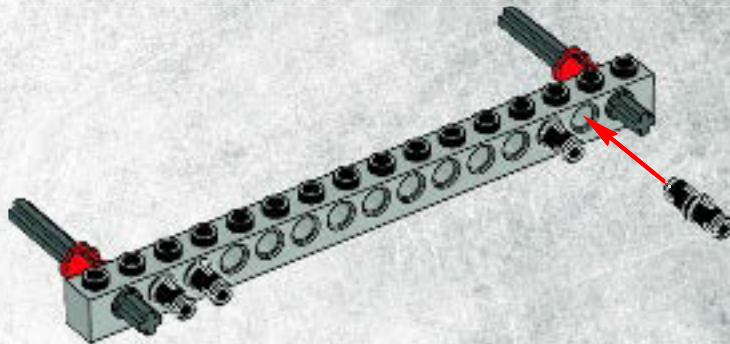

8

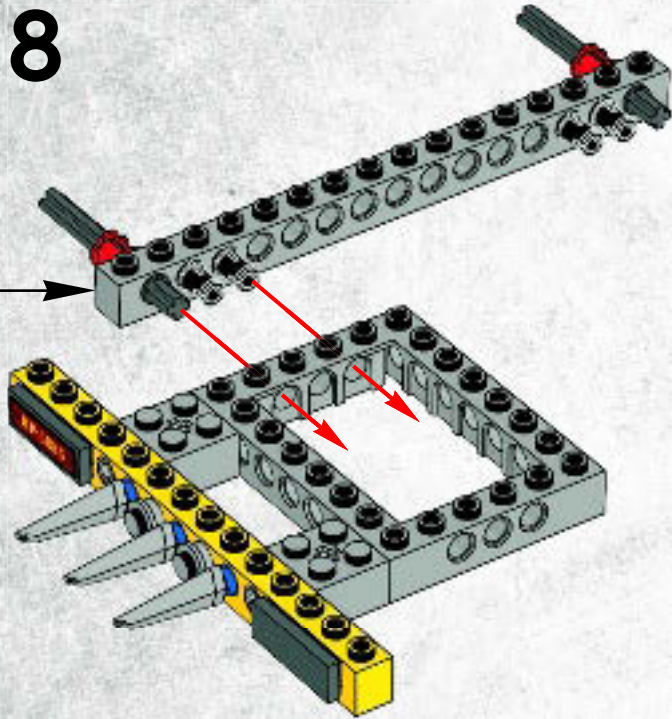

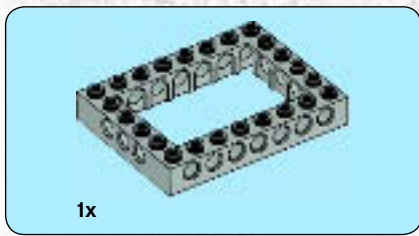

9

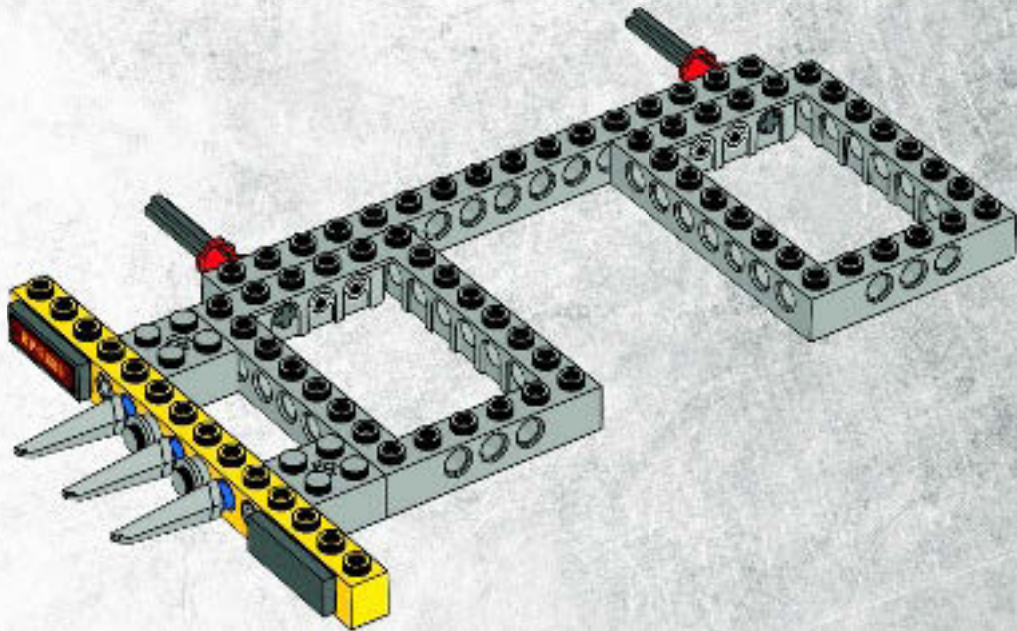

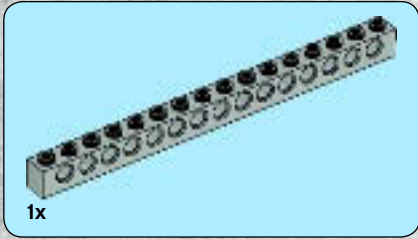

1x

1

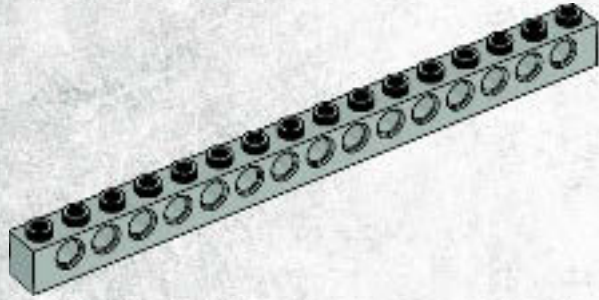

1x

1x

2

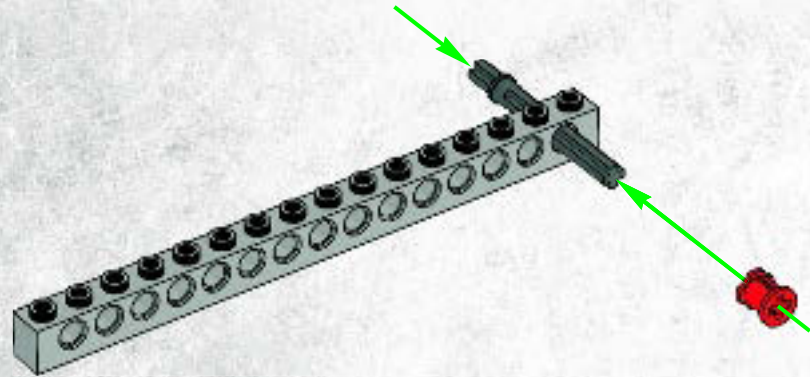

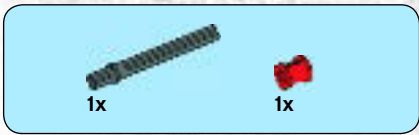

3

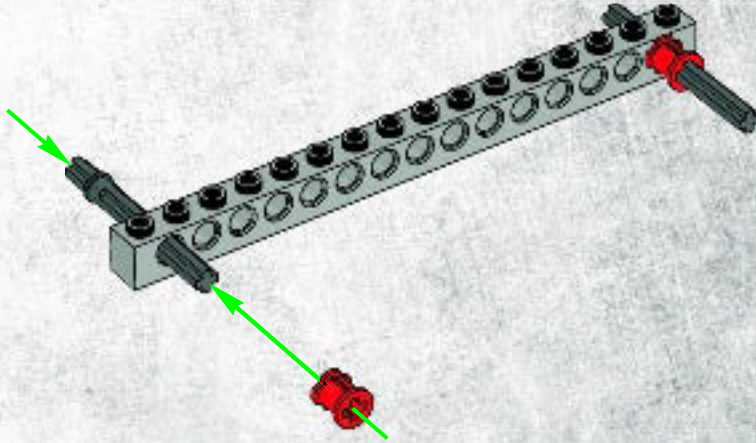

4



10

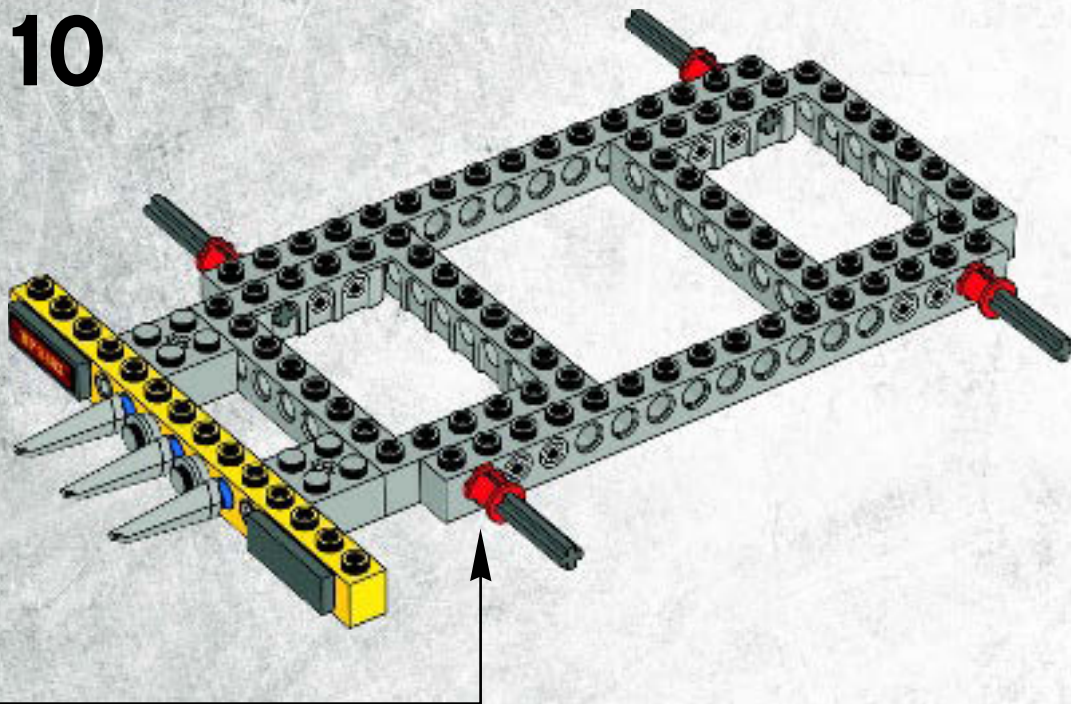

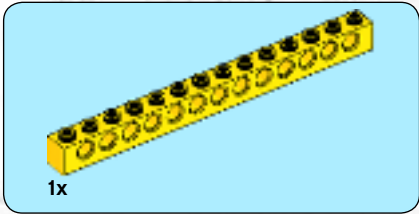
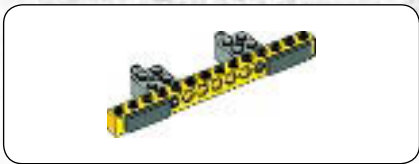

1

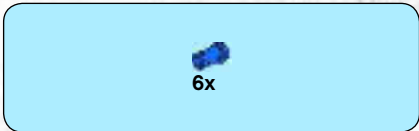

2





2x

3

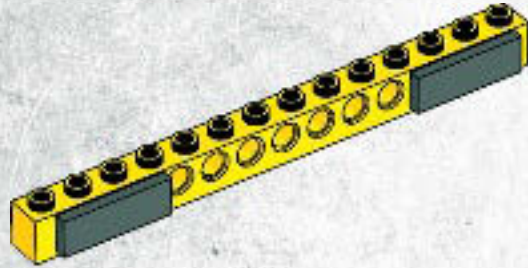

2x

4

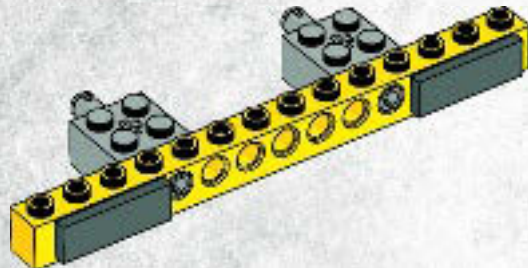

11

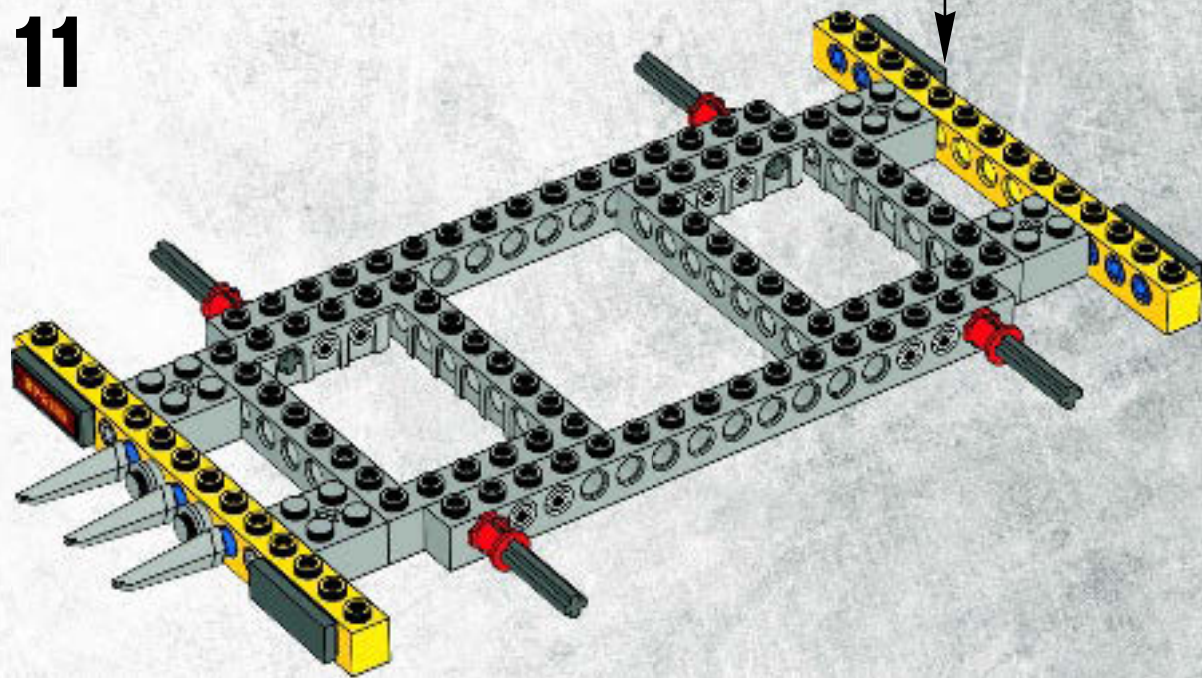

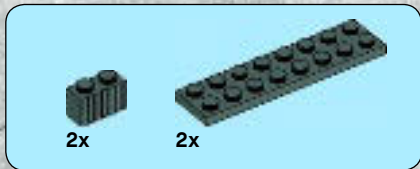

12

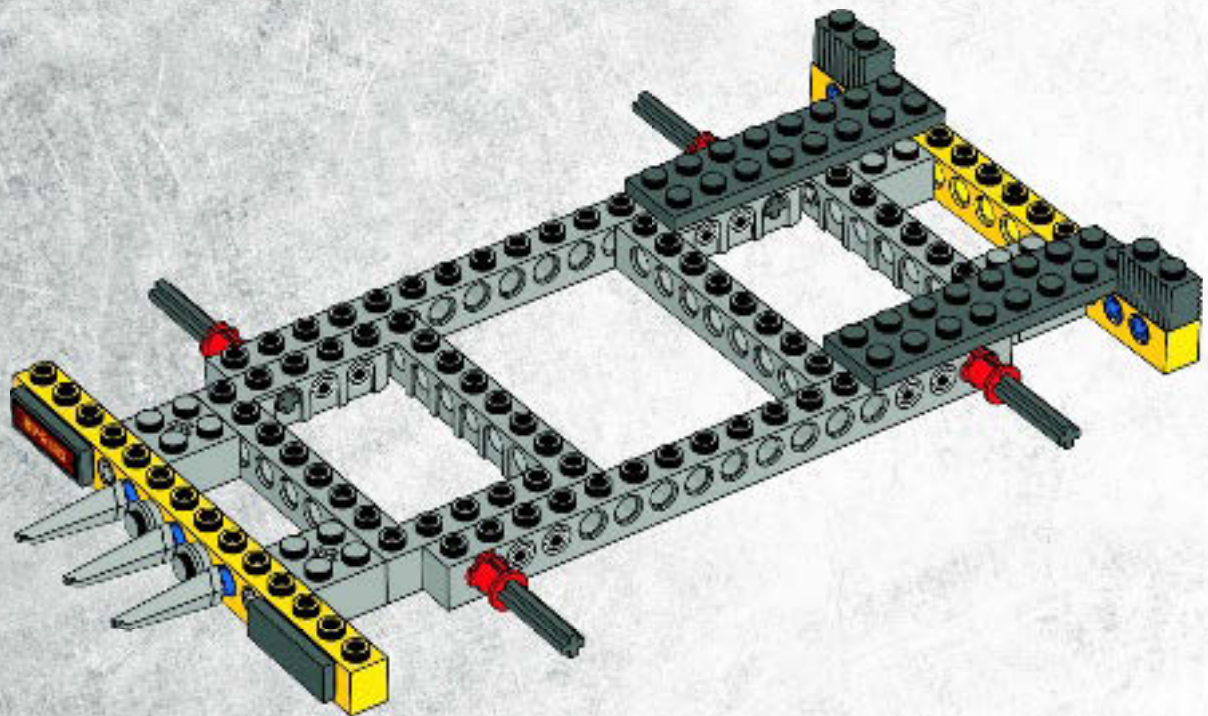



13

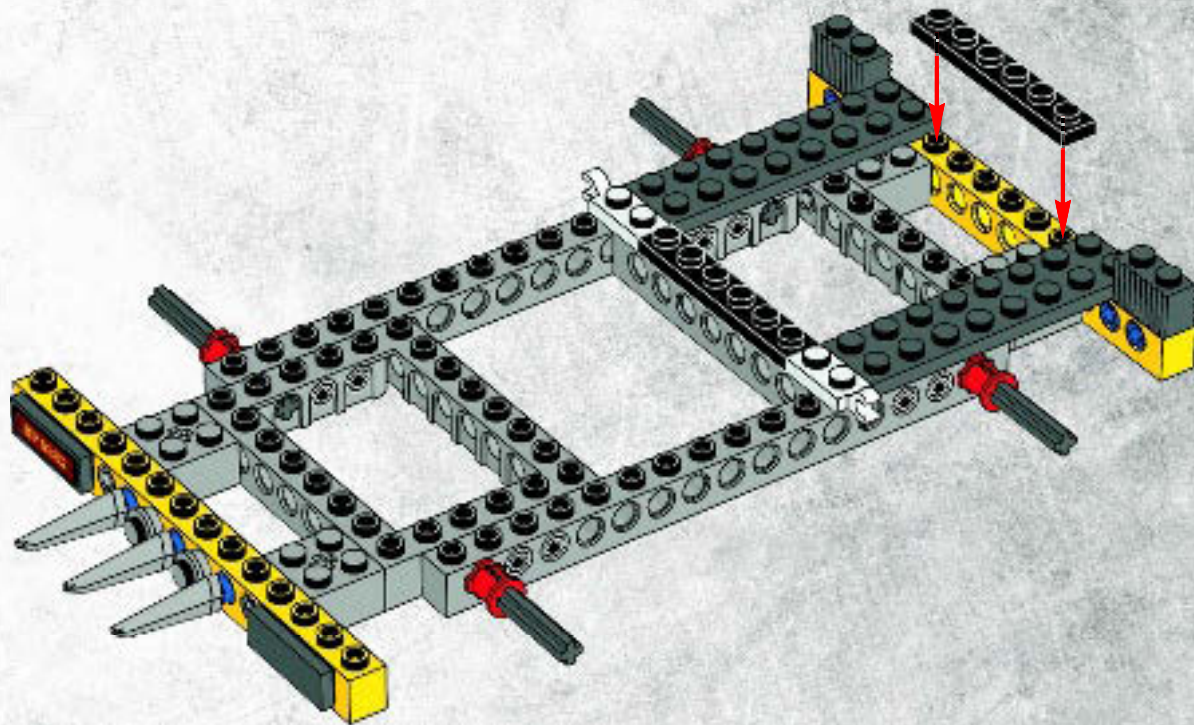



2x

14

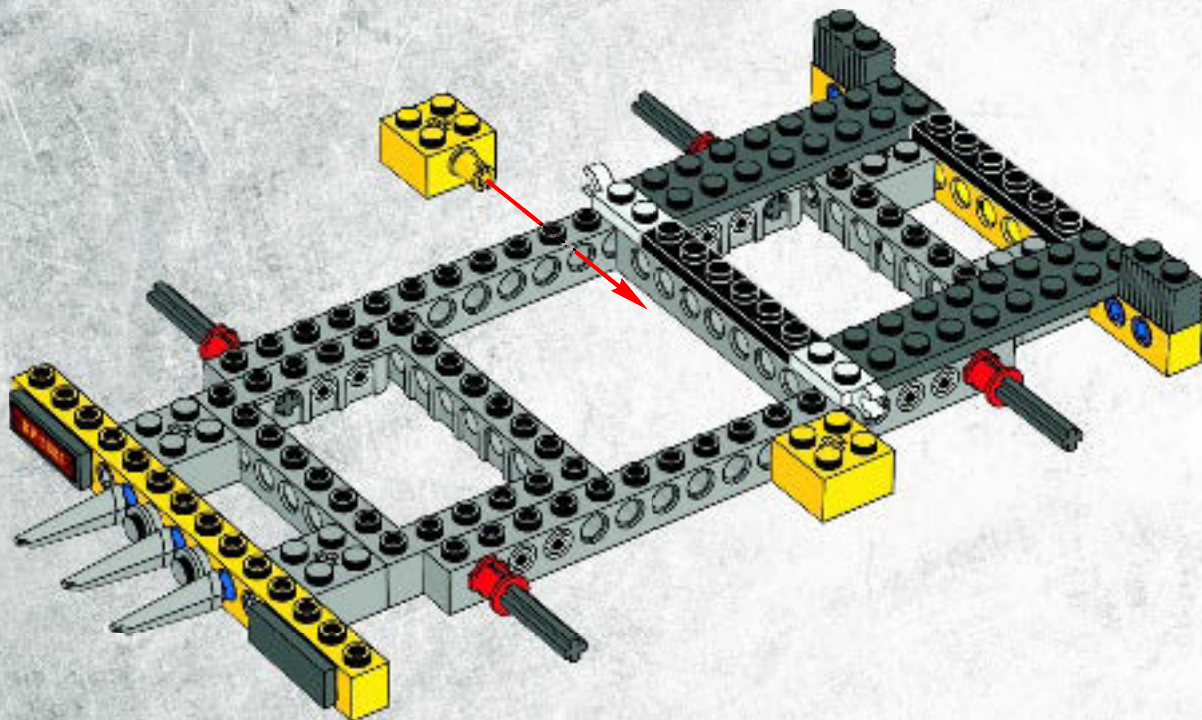



15

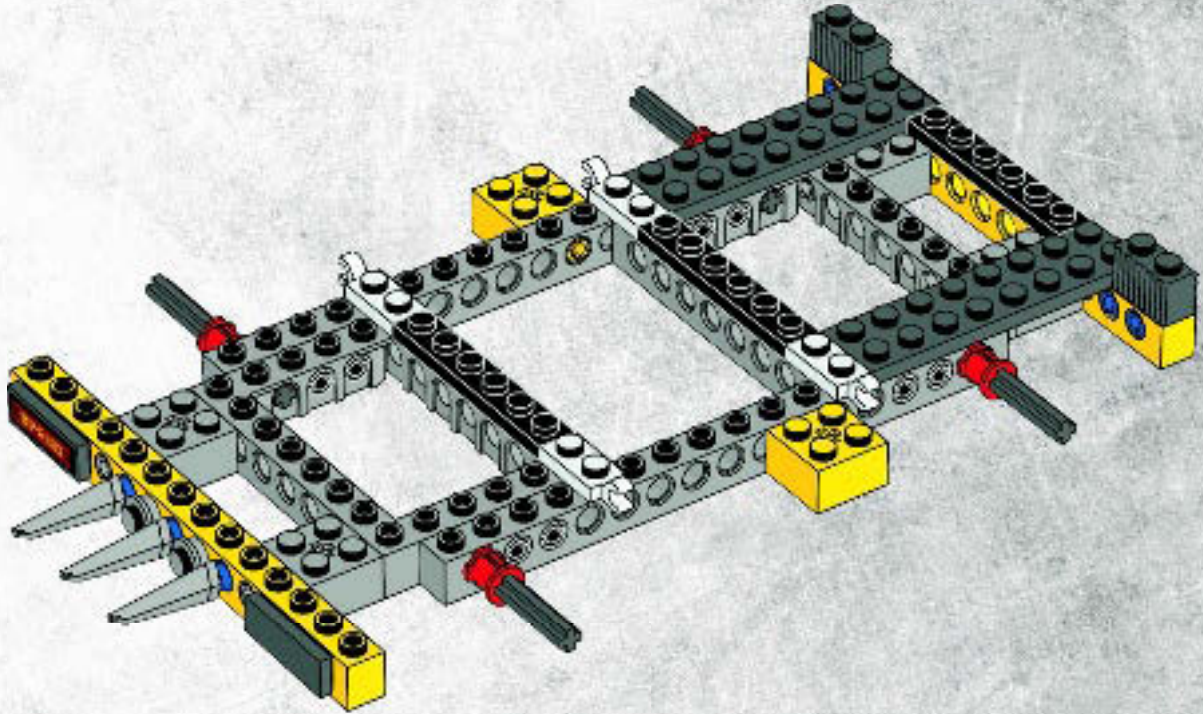



2x



2x

16

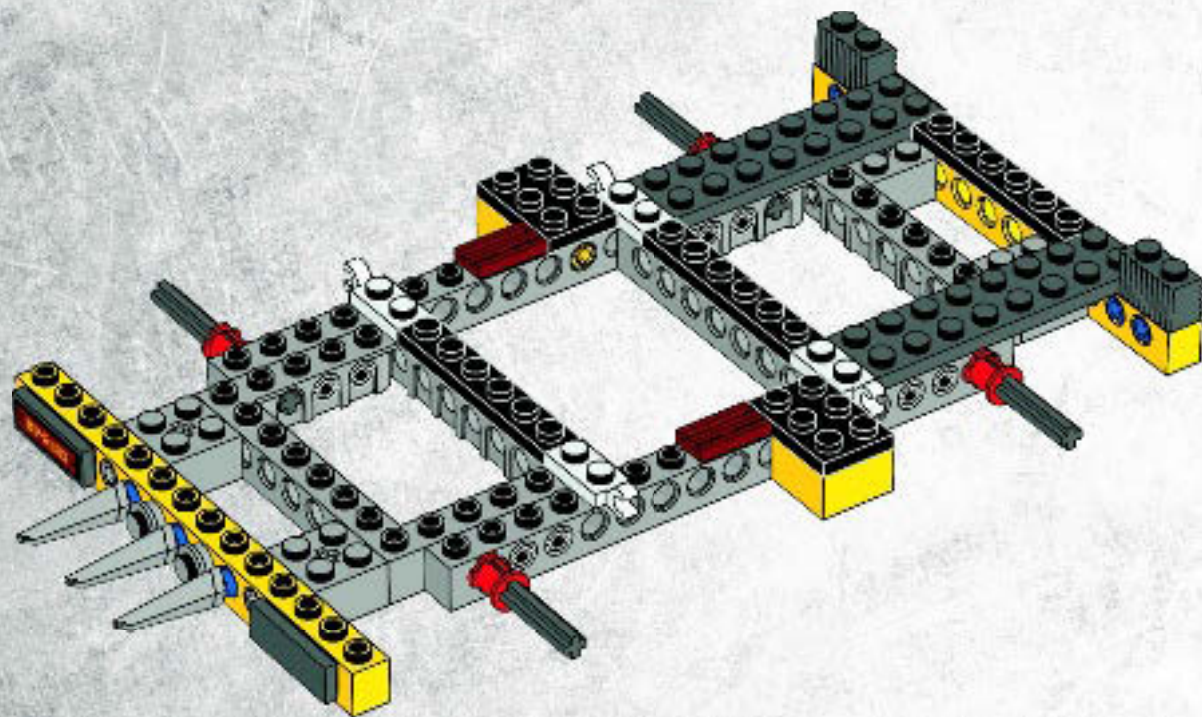



2x

17

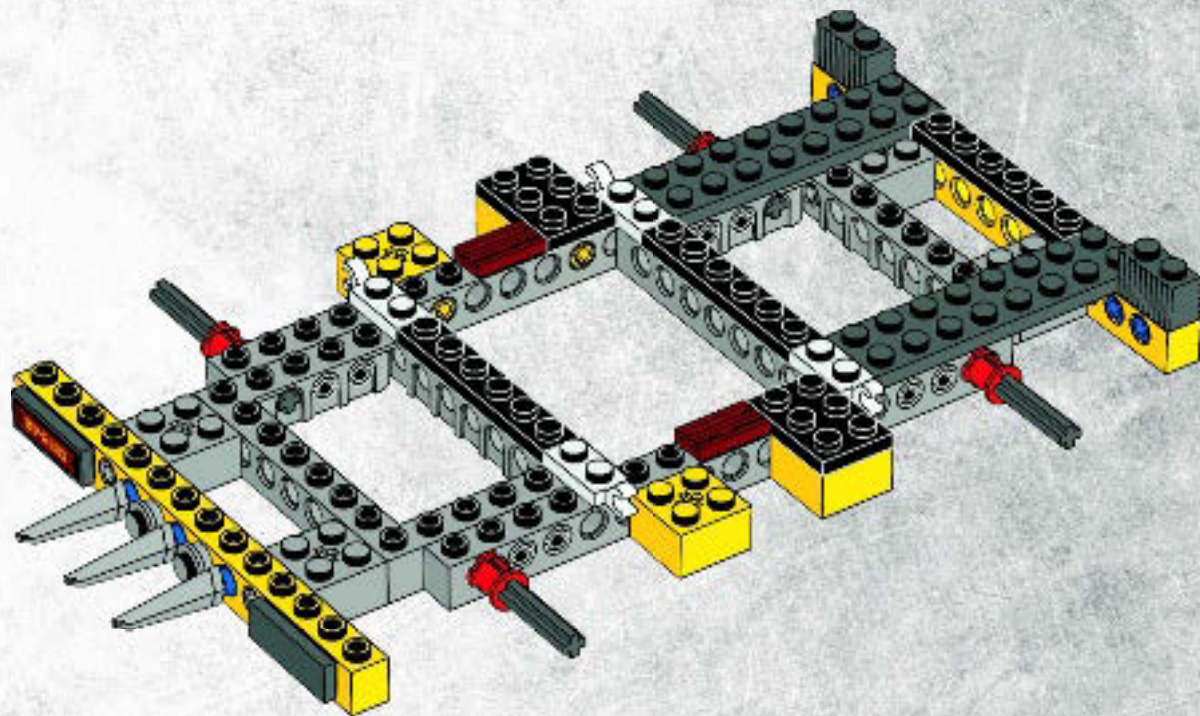



2x

18

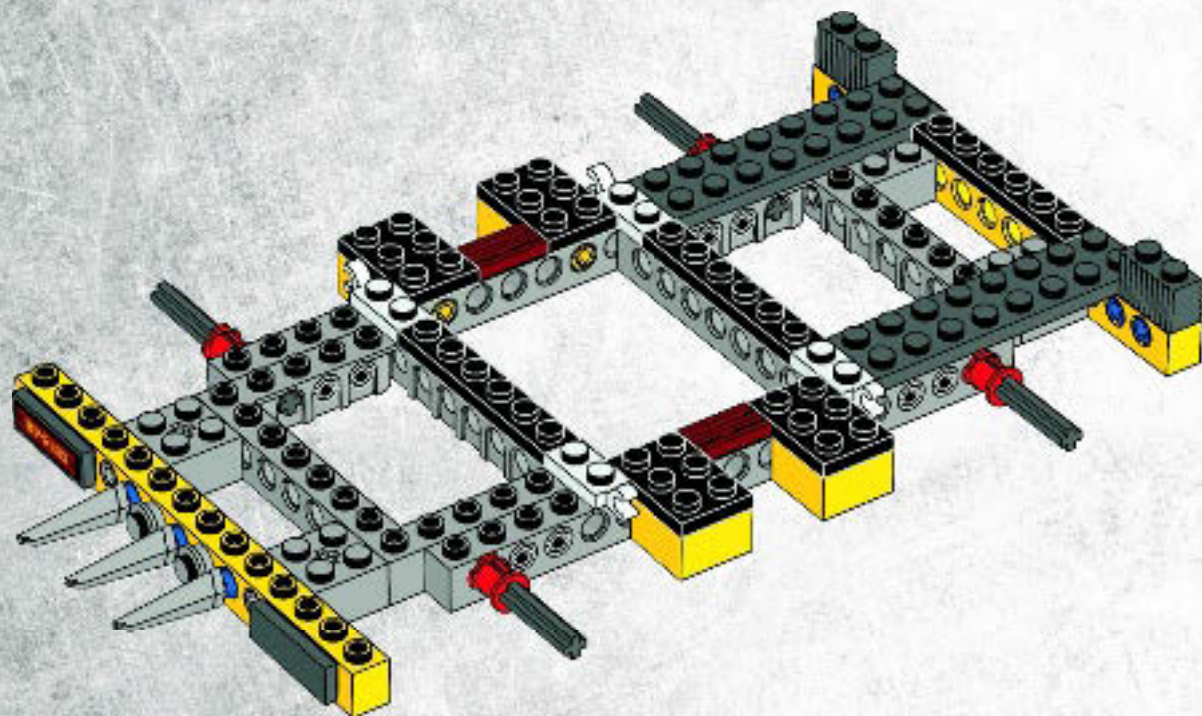

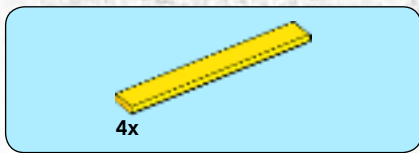

19

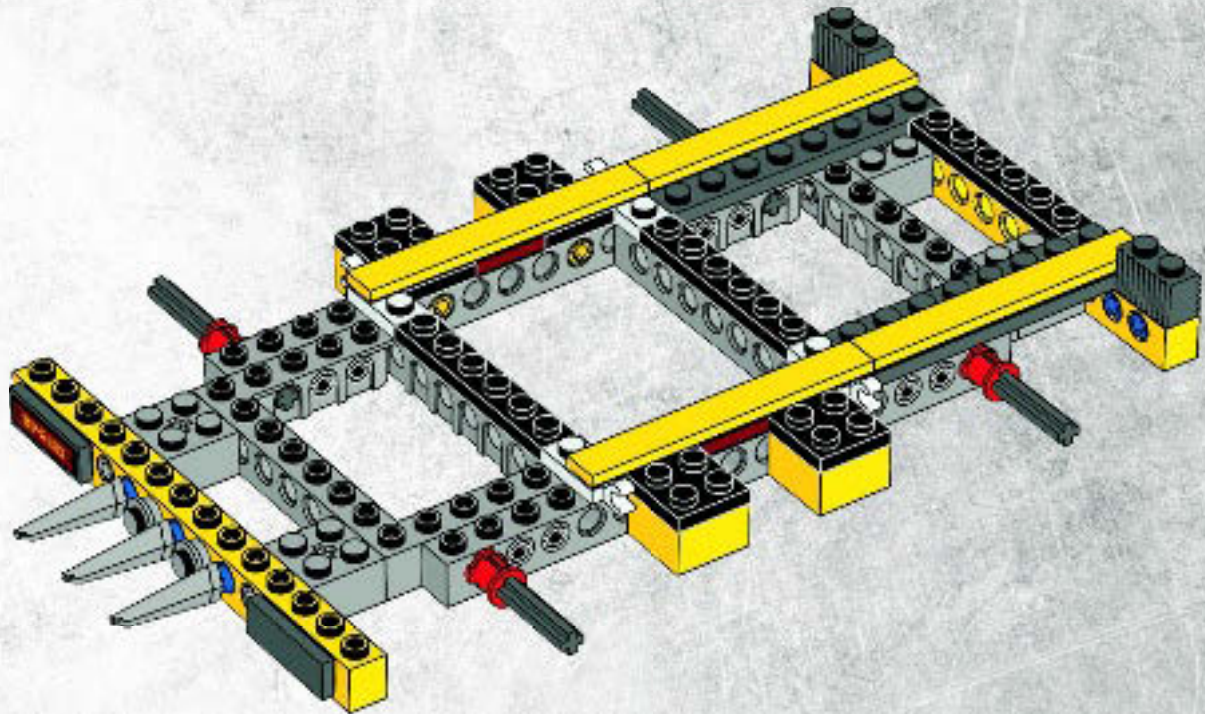

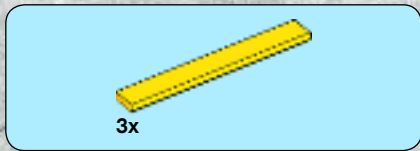

20

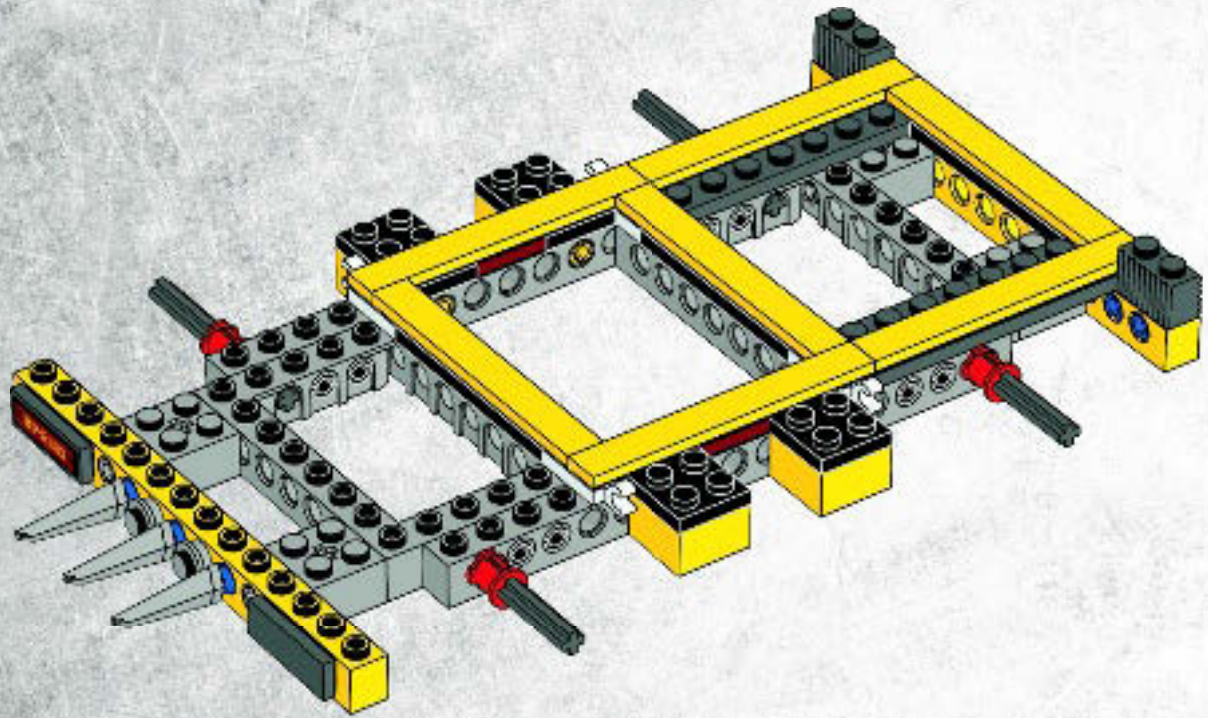



2x



2x

21

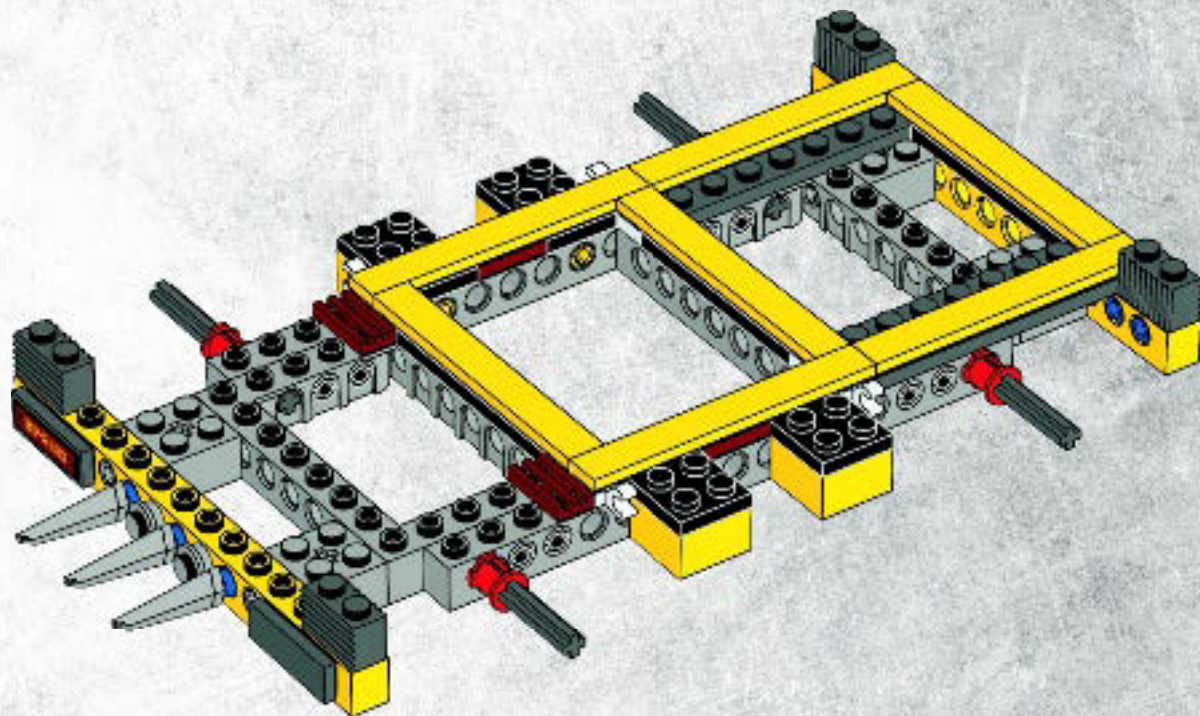

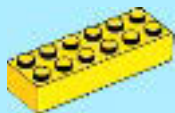

2x

22

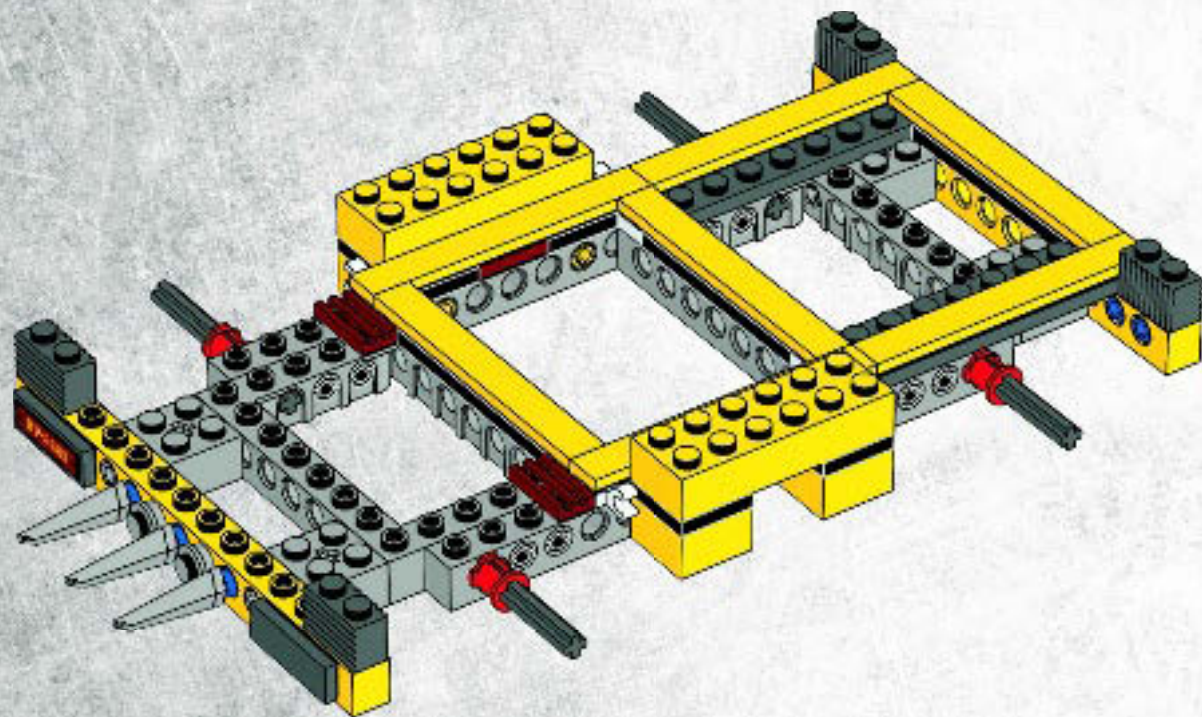



4x

23

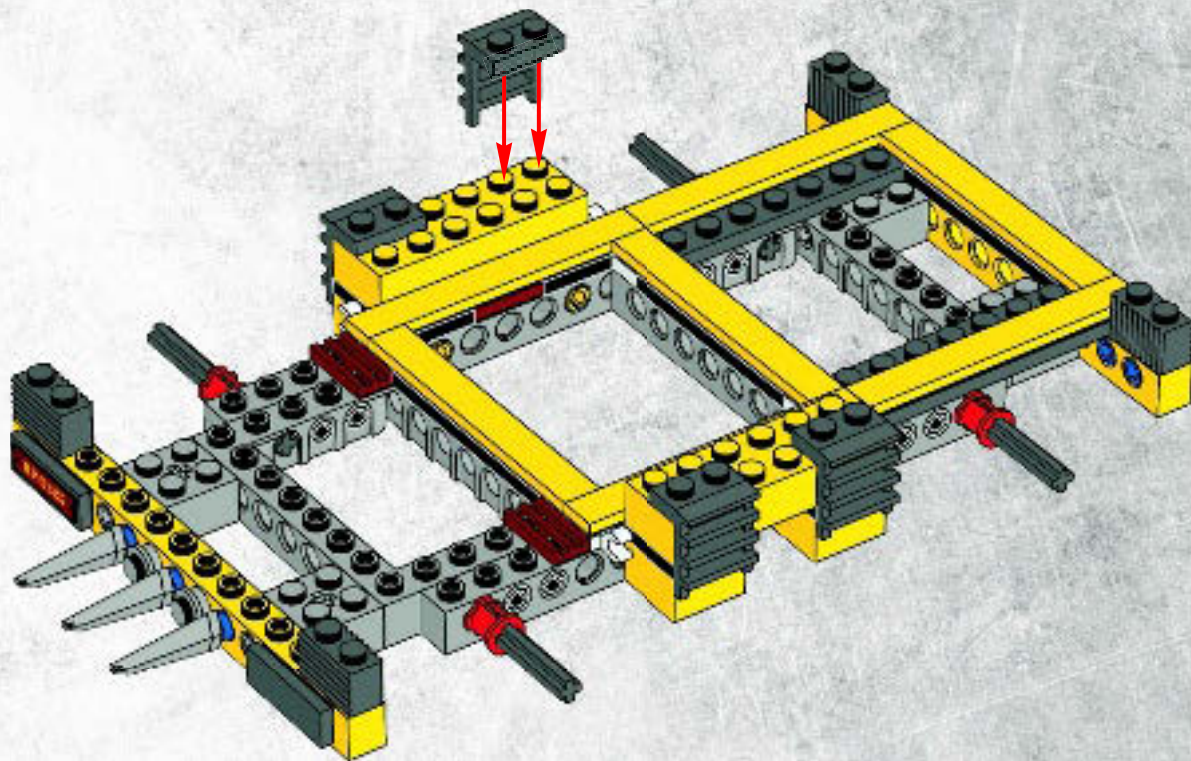



2x



4x

24

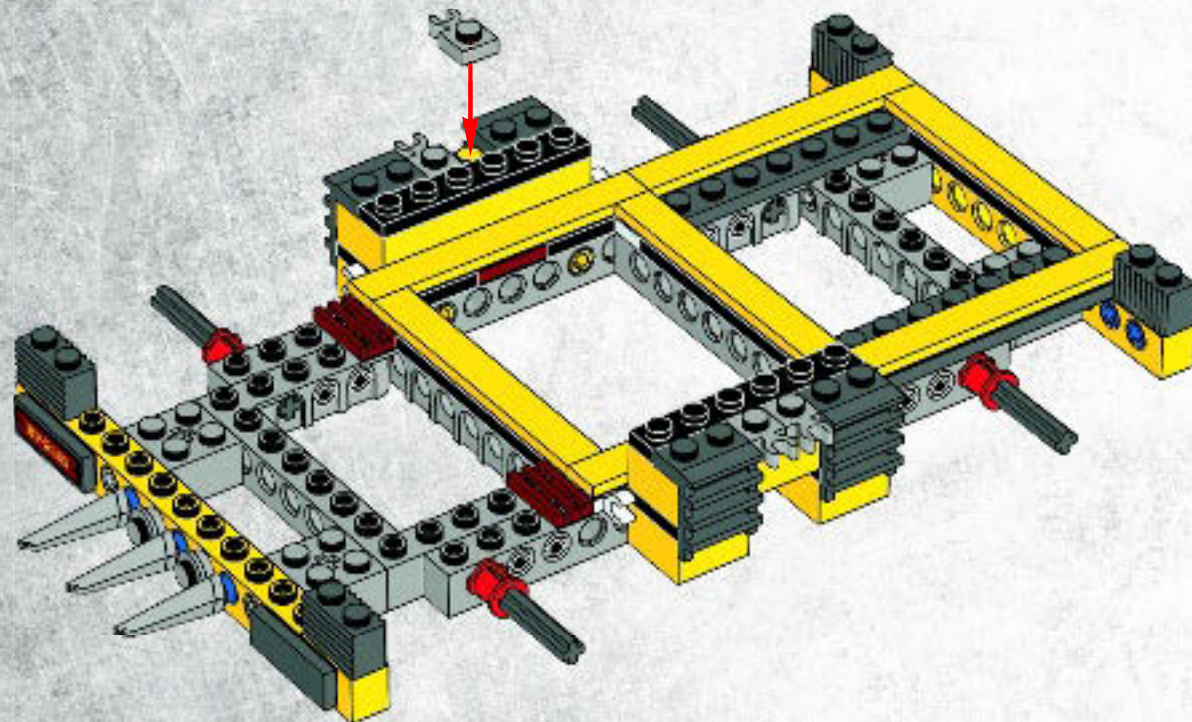

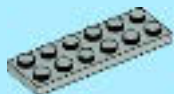

2x

25

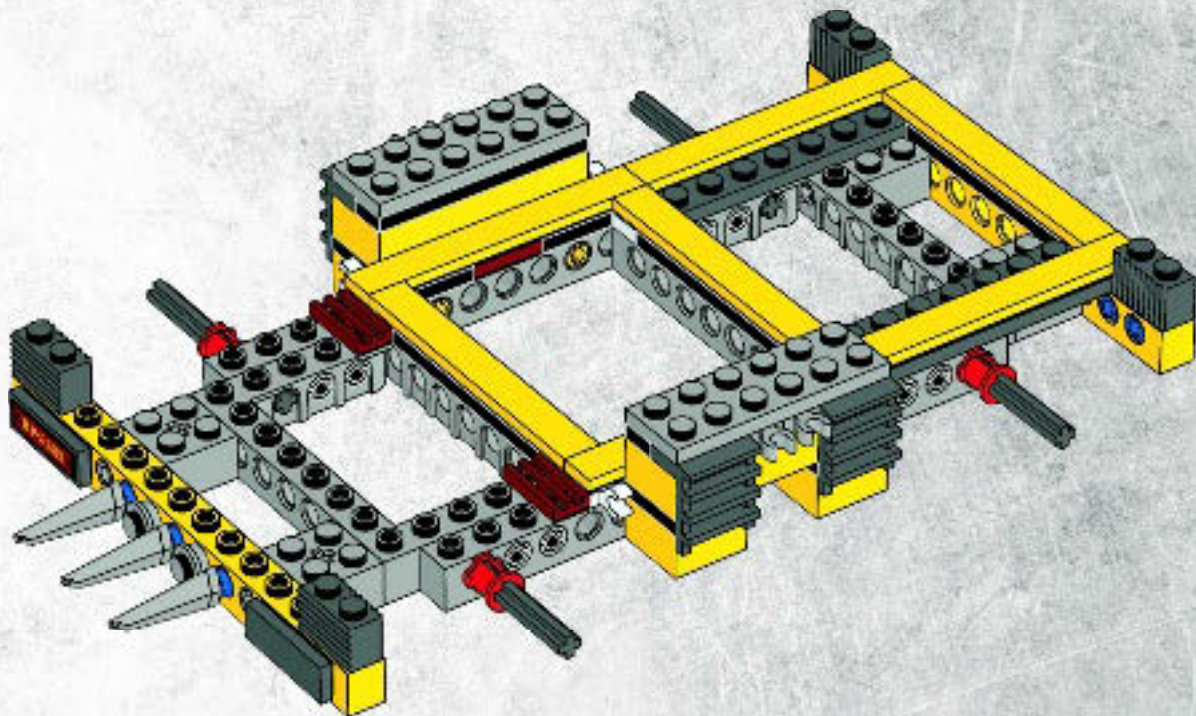

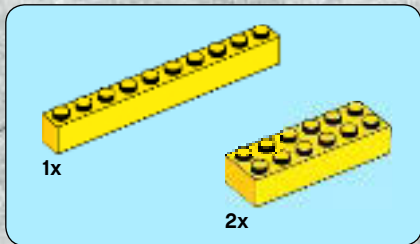

26

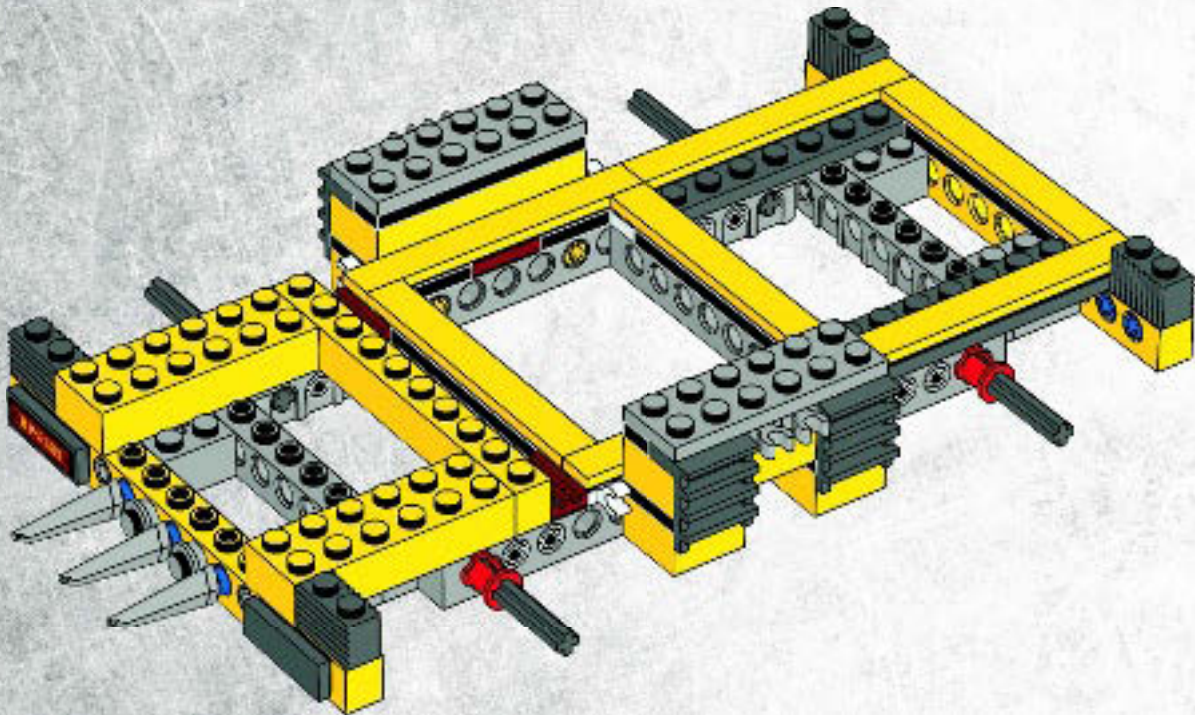



1x



2x

27

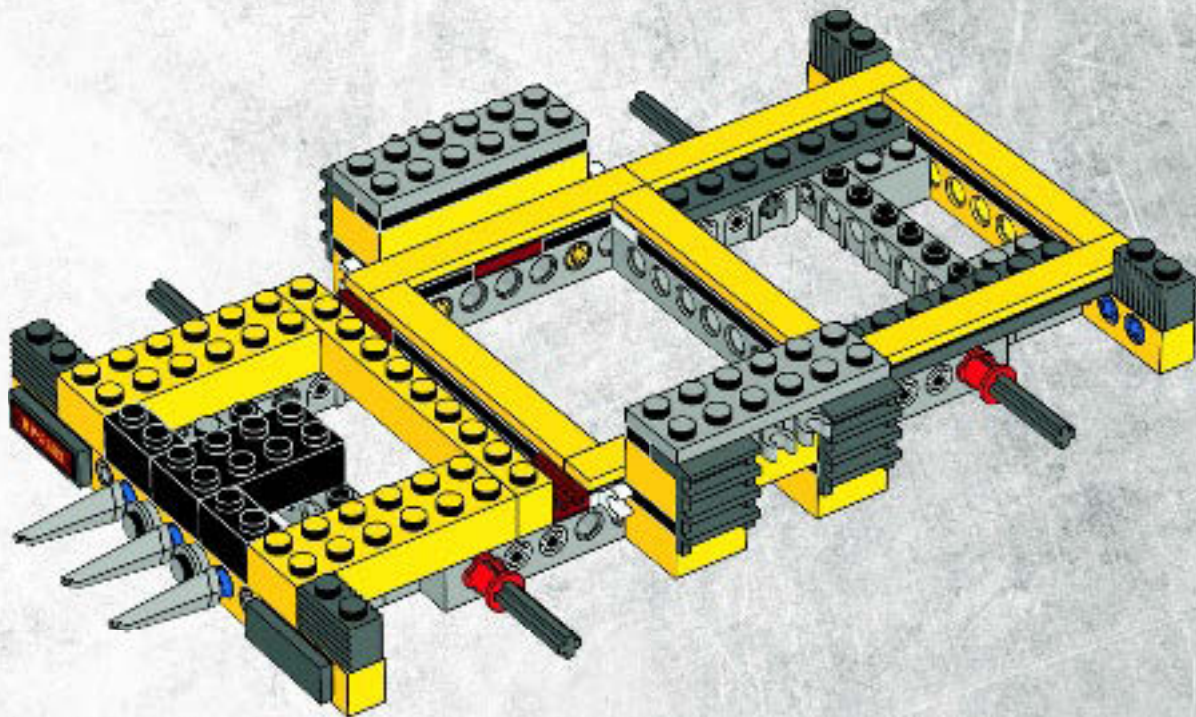

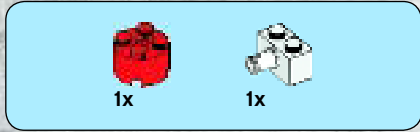
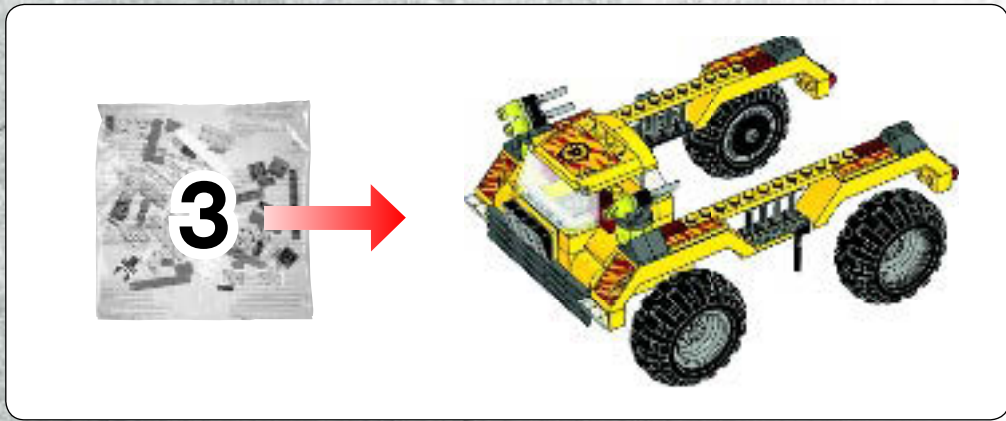

28

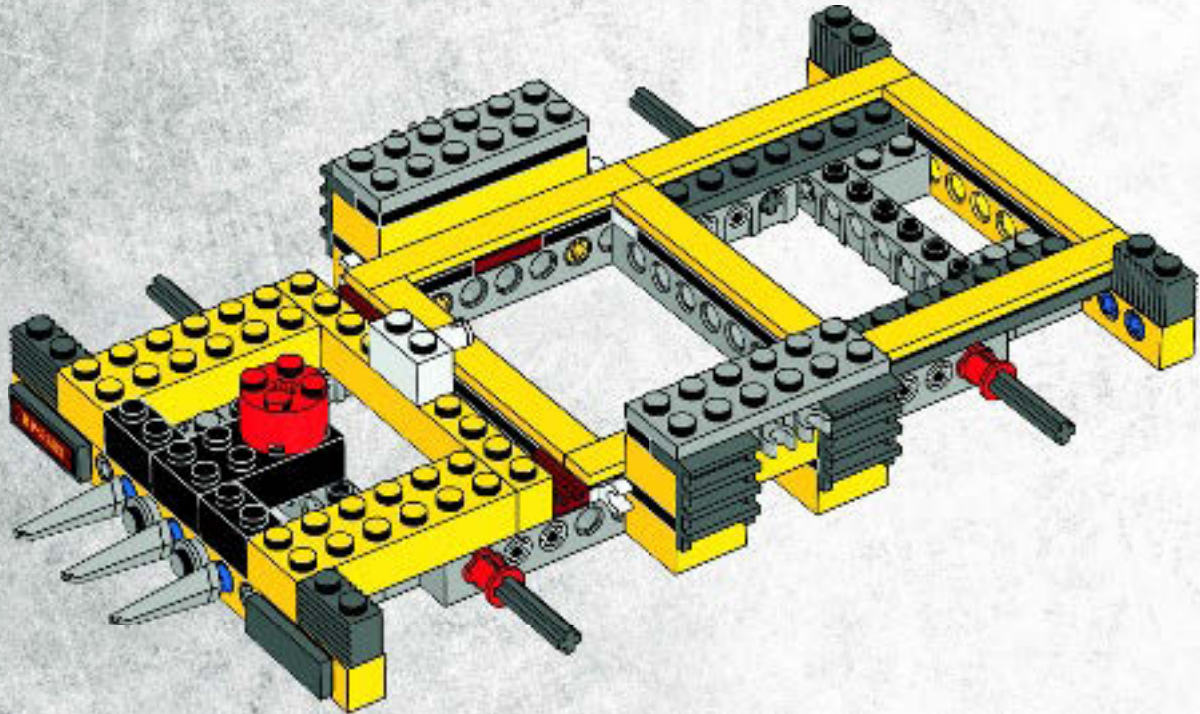

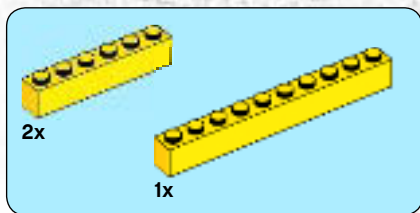

29

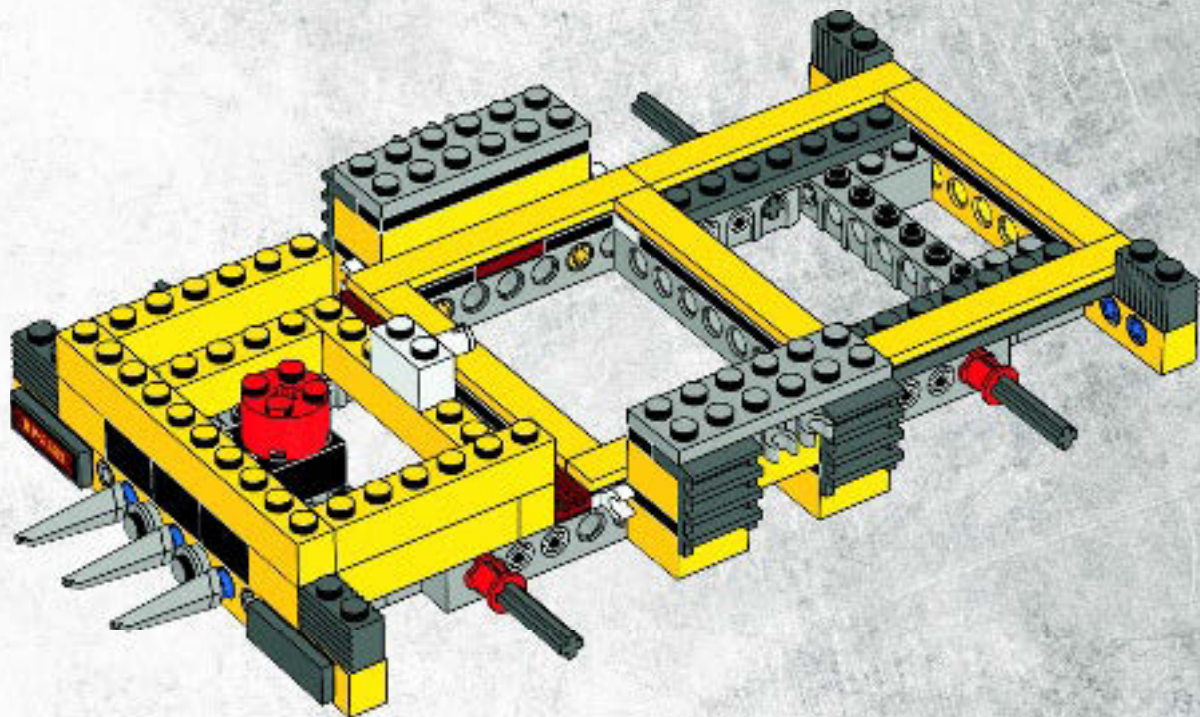



4x



2x

30

1



2



2x

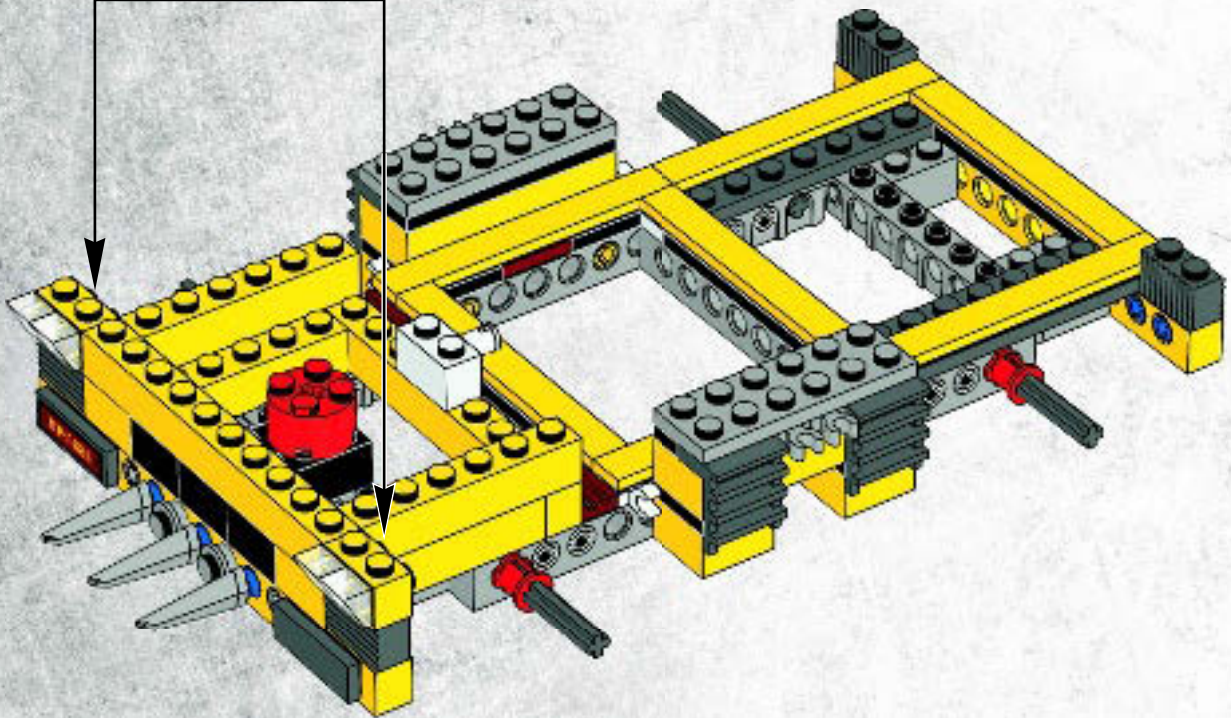



5x

31

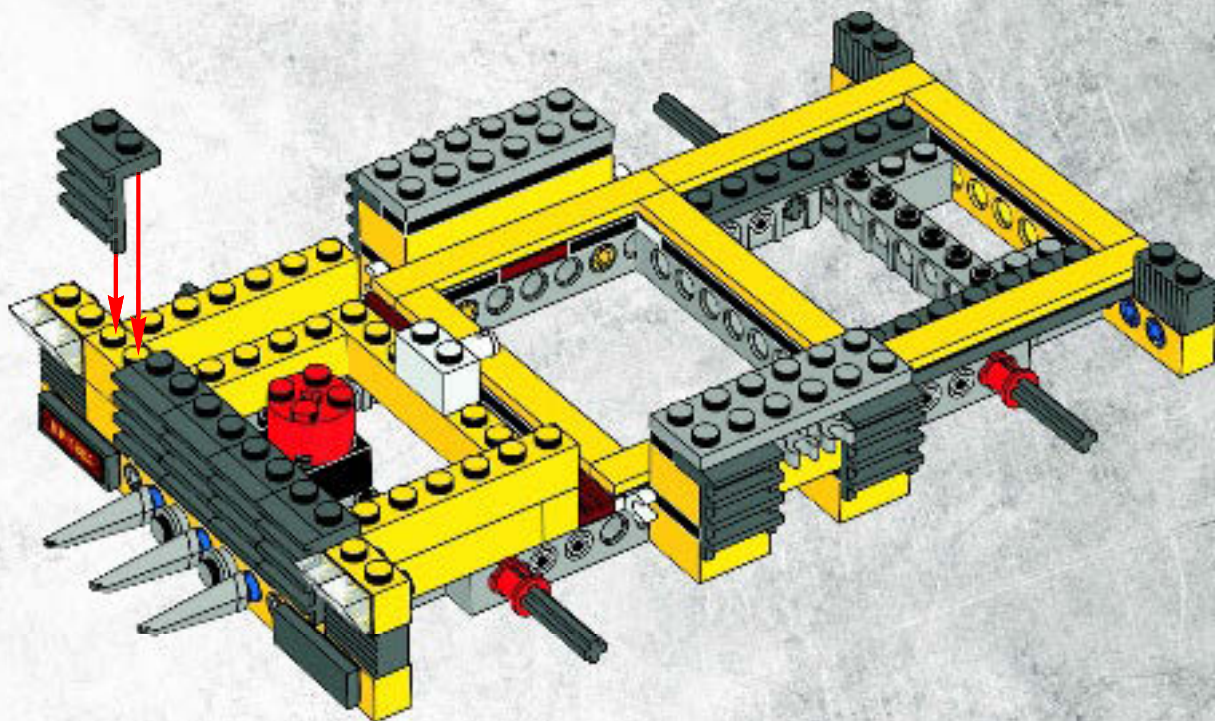



32

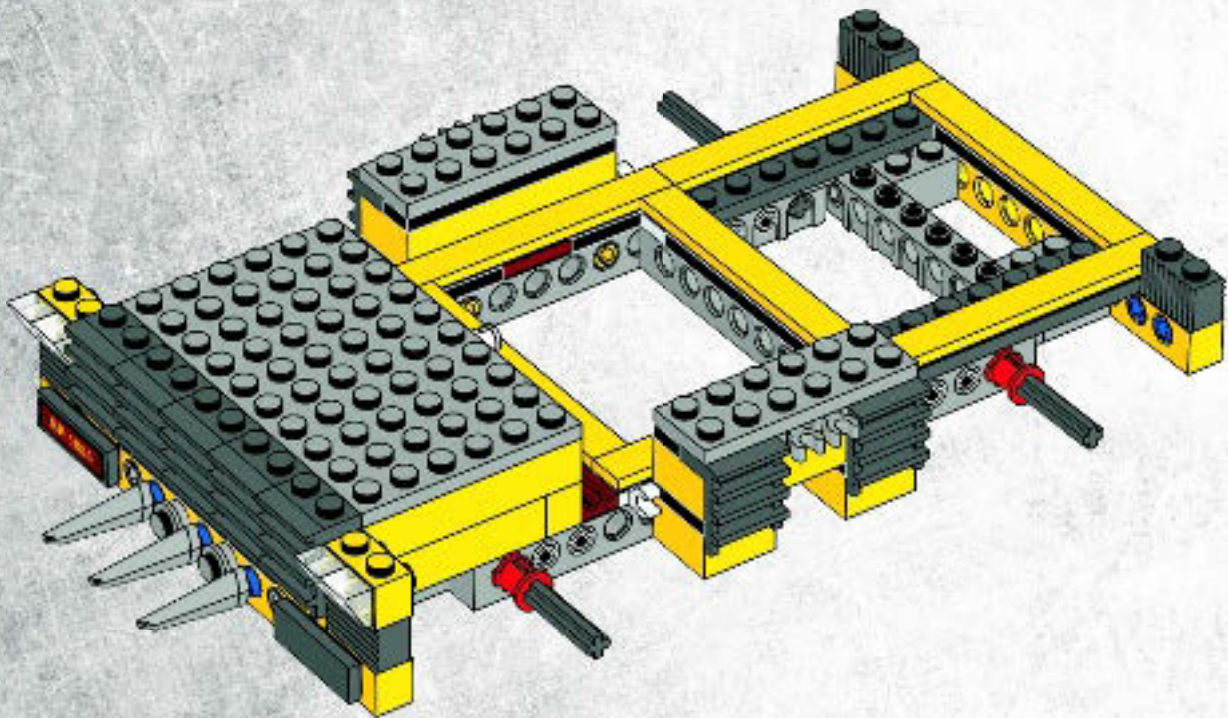

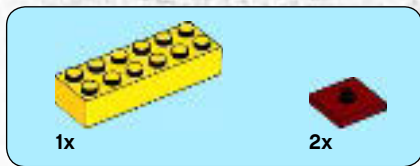

33

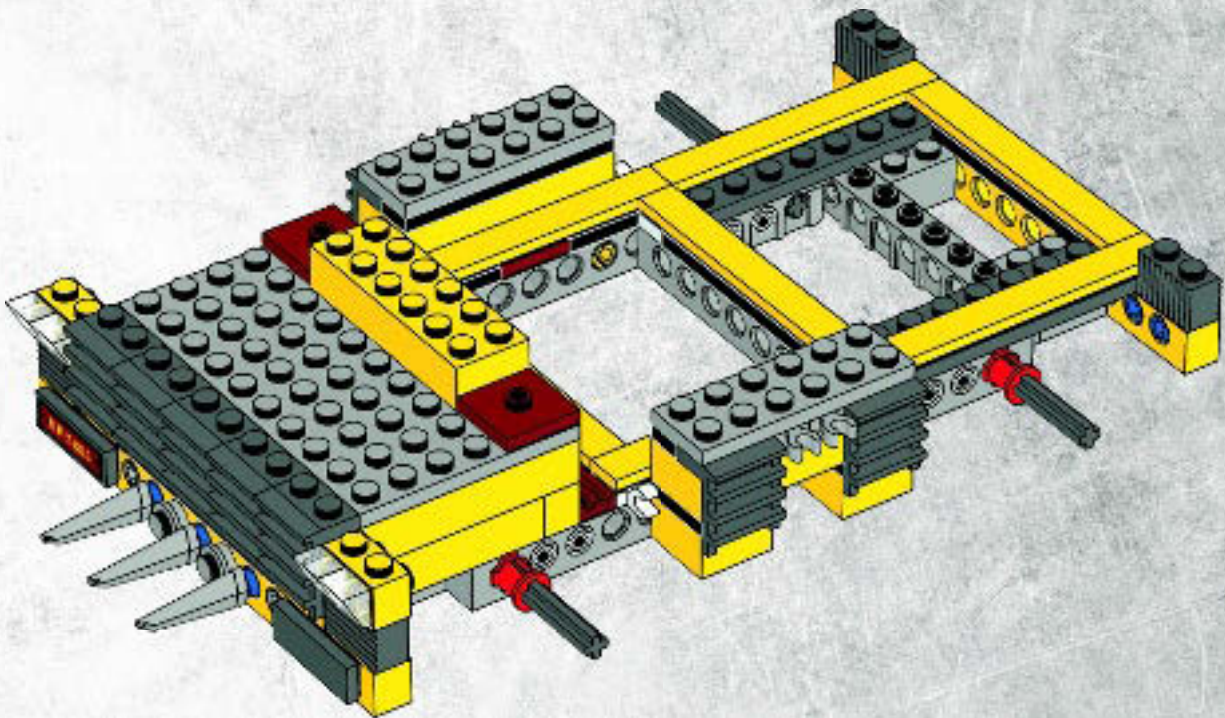



34

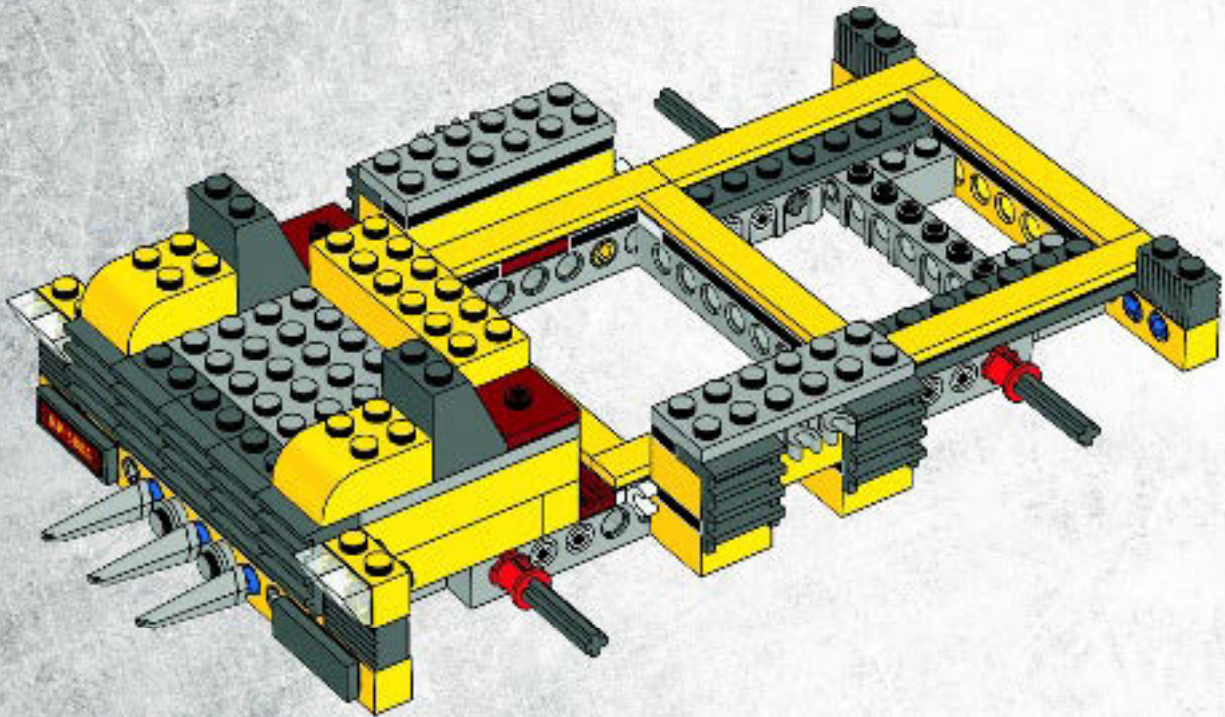



35

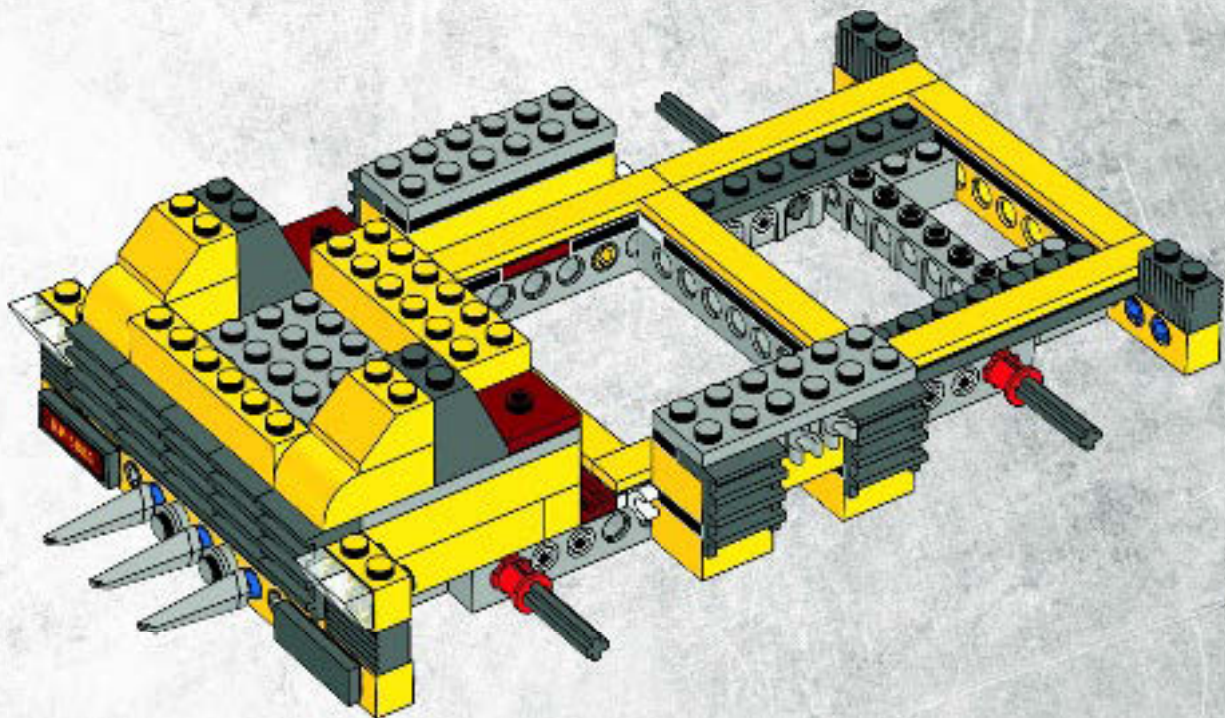



1x



1x

36

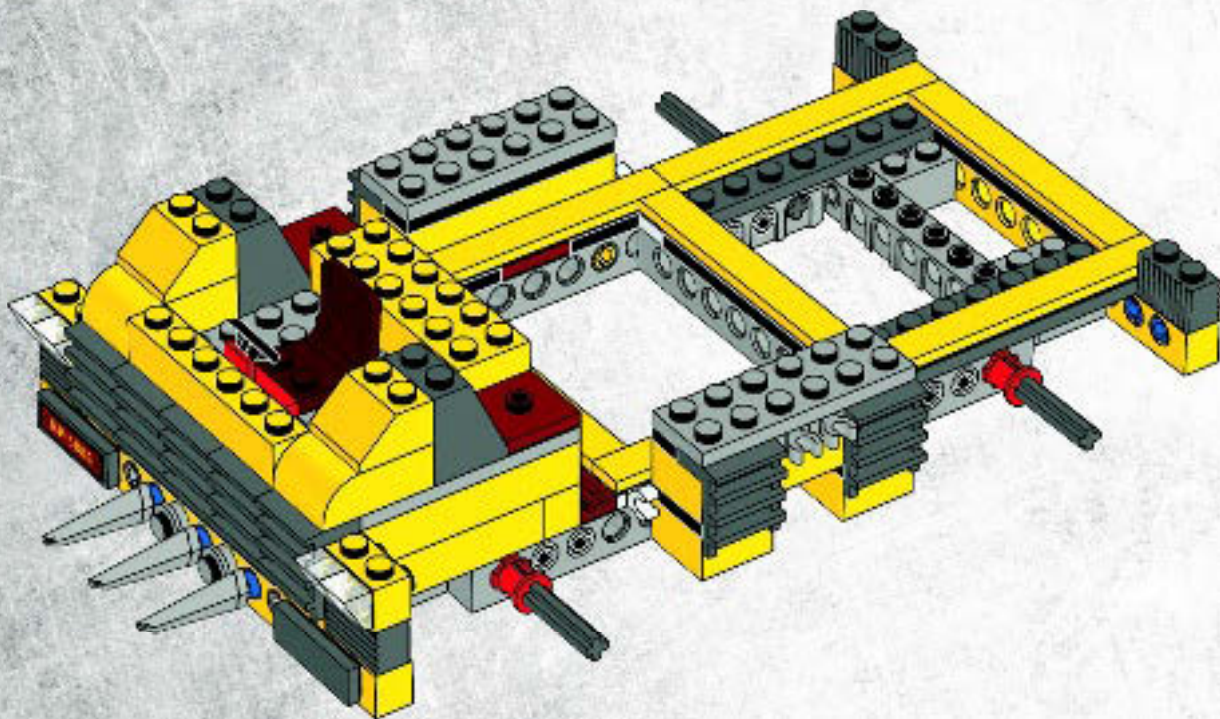



3x

37

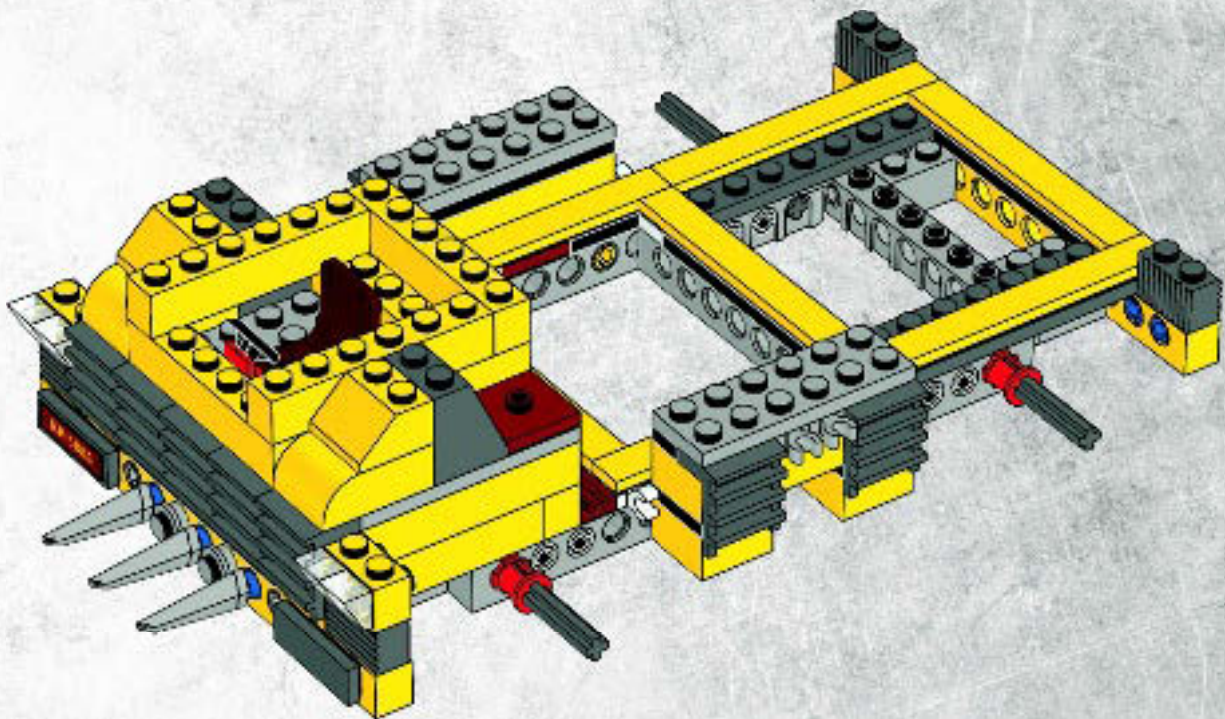



1x

38

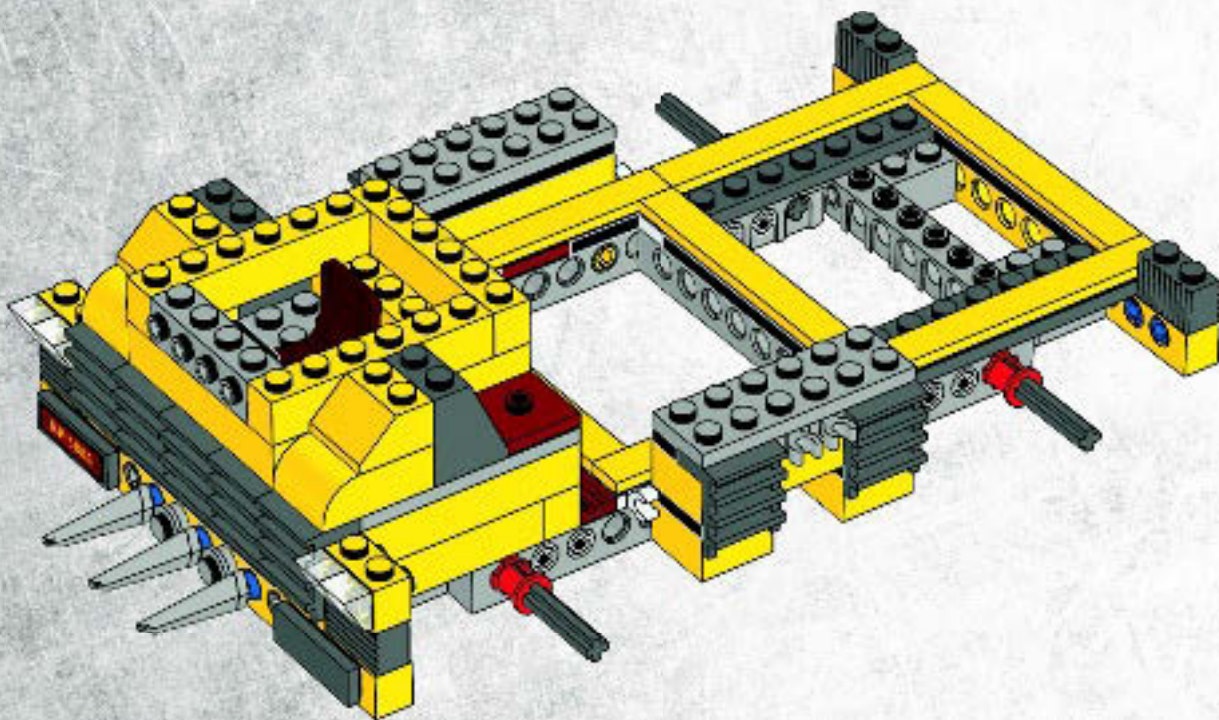



4x



2x

39

1



2



2x

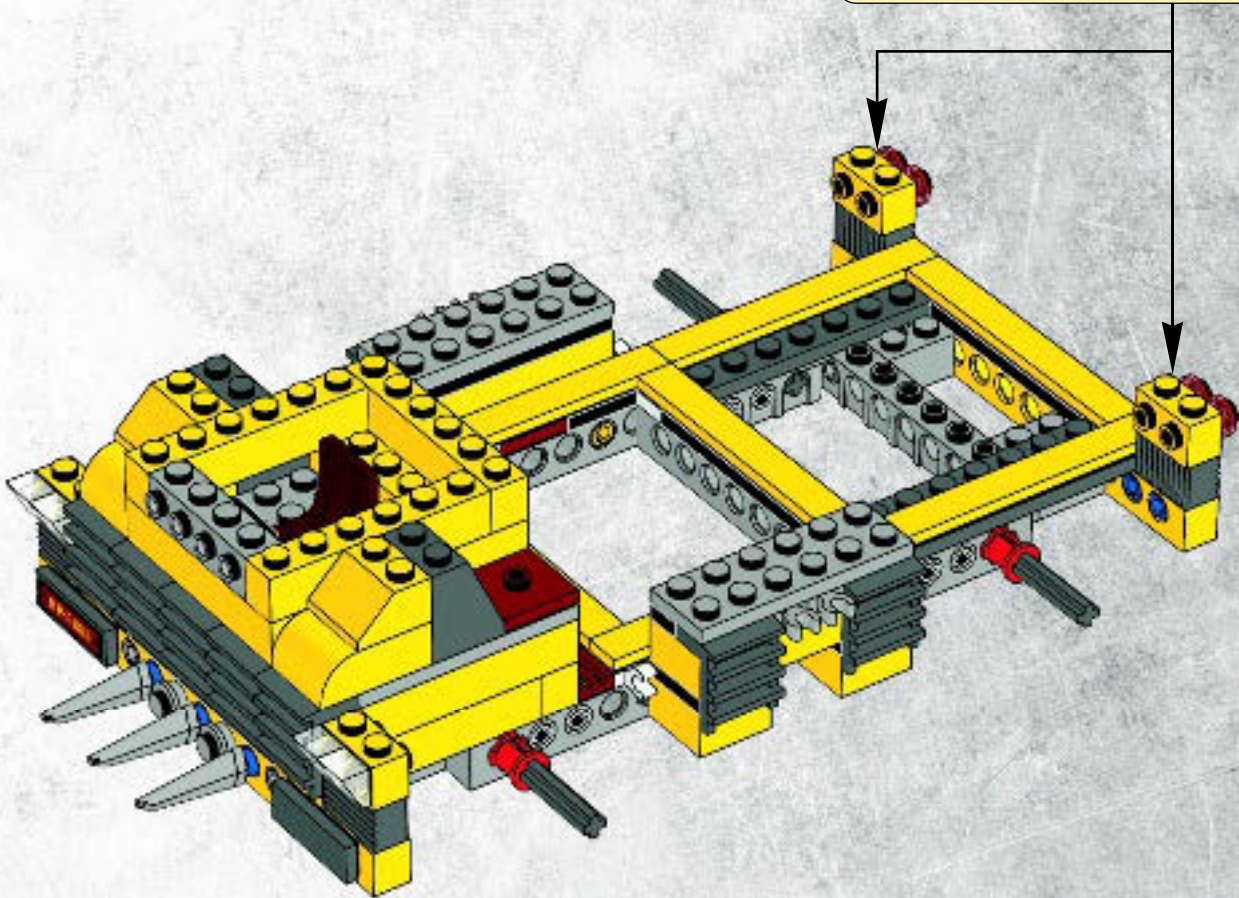

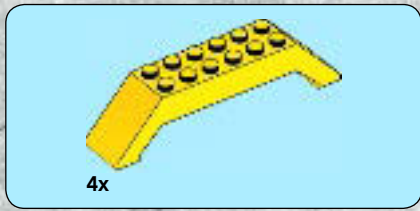

40

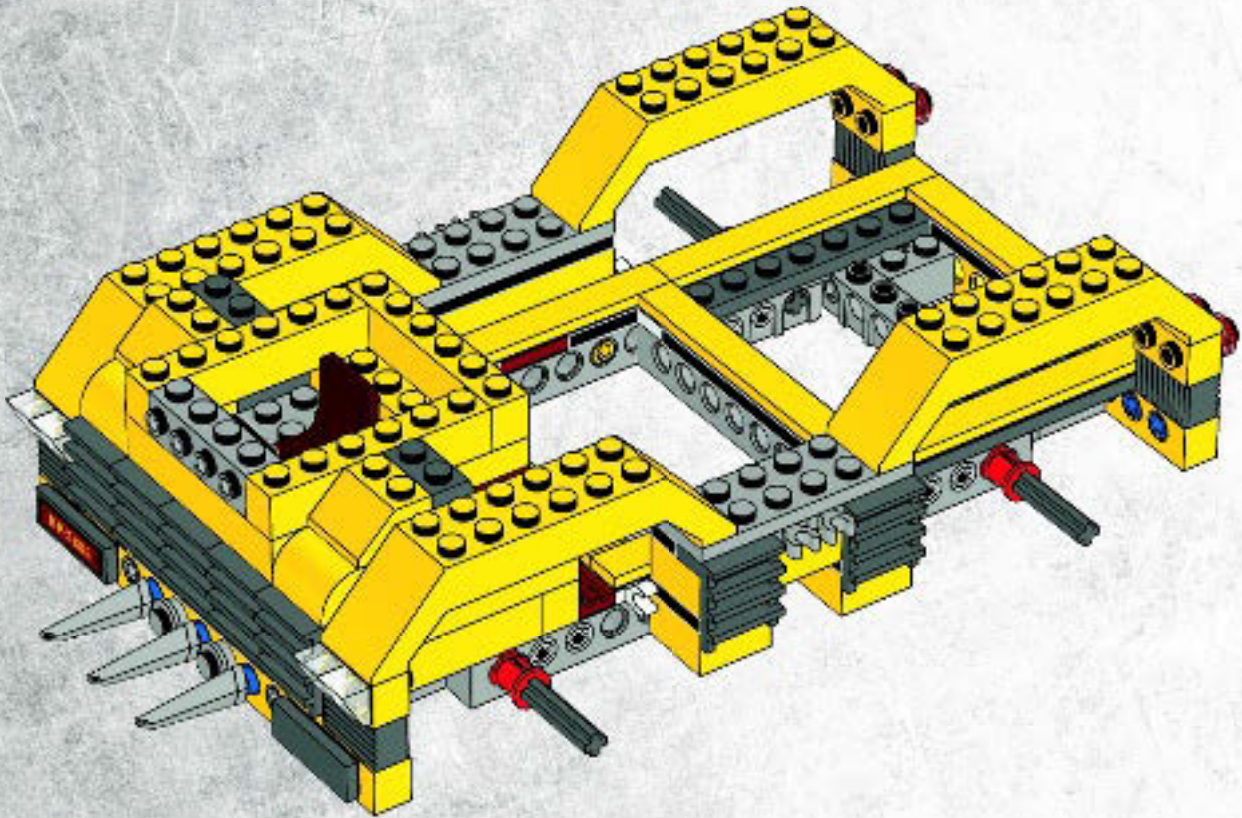

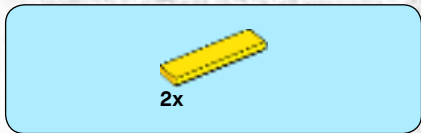

41

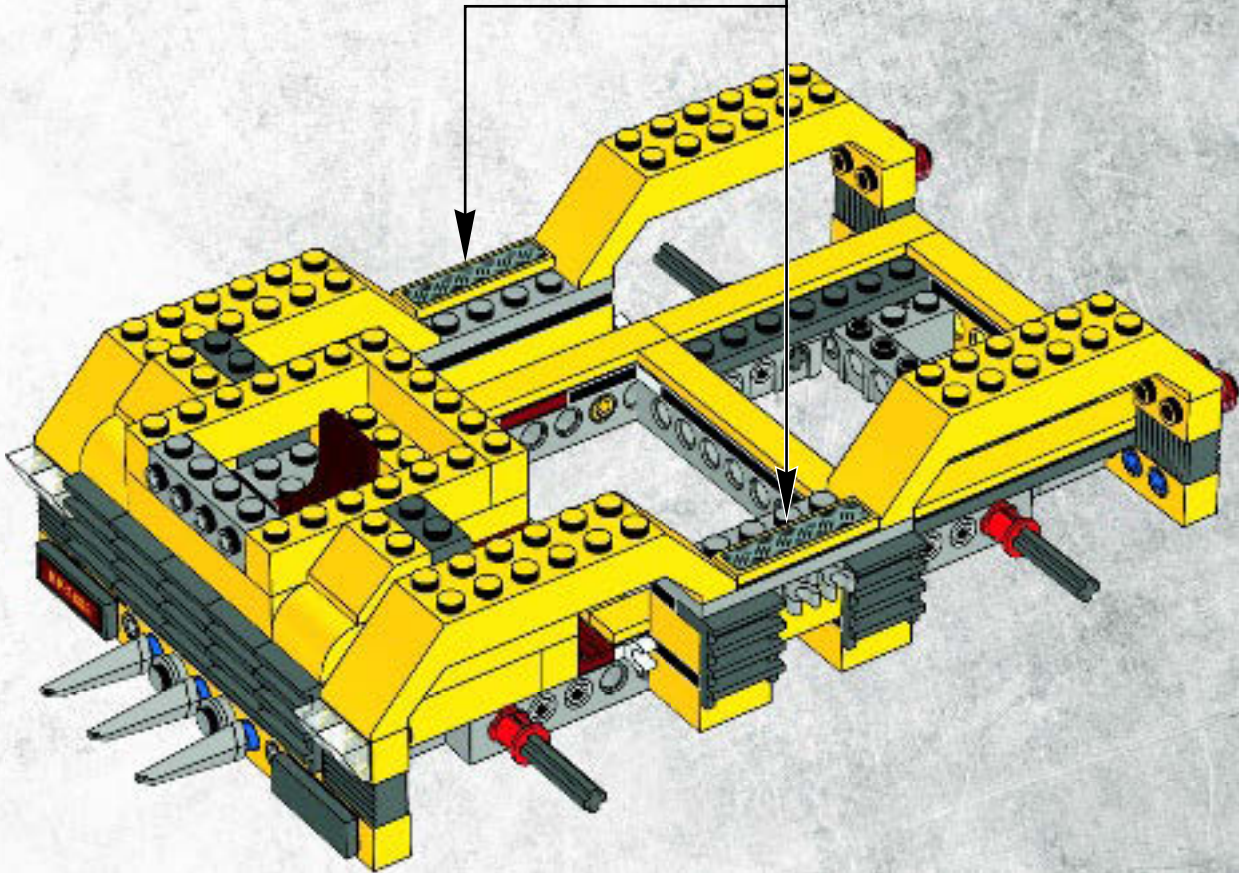
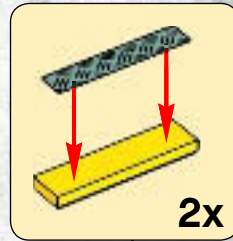



42

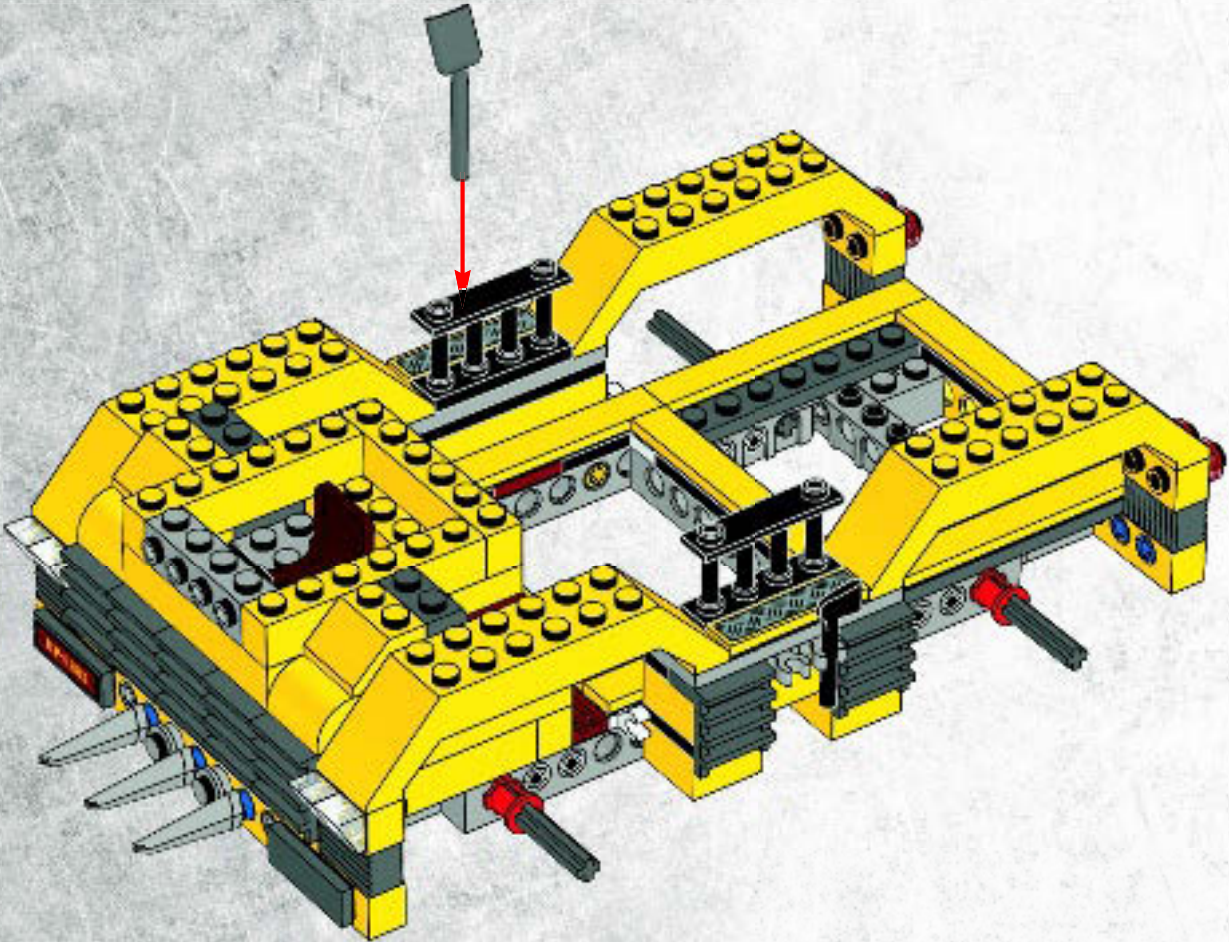



2x



2x

43

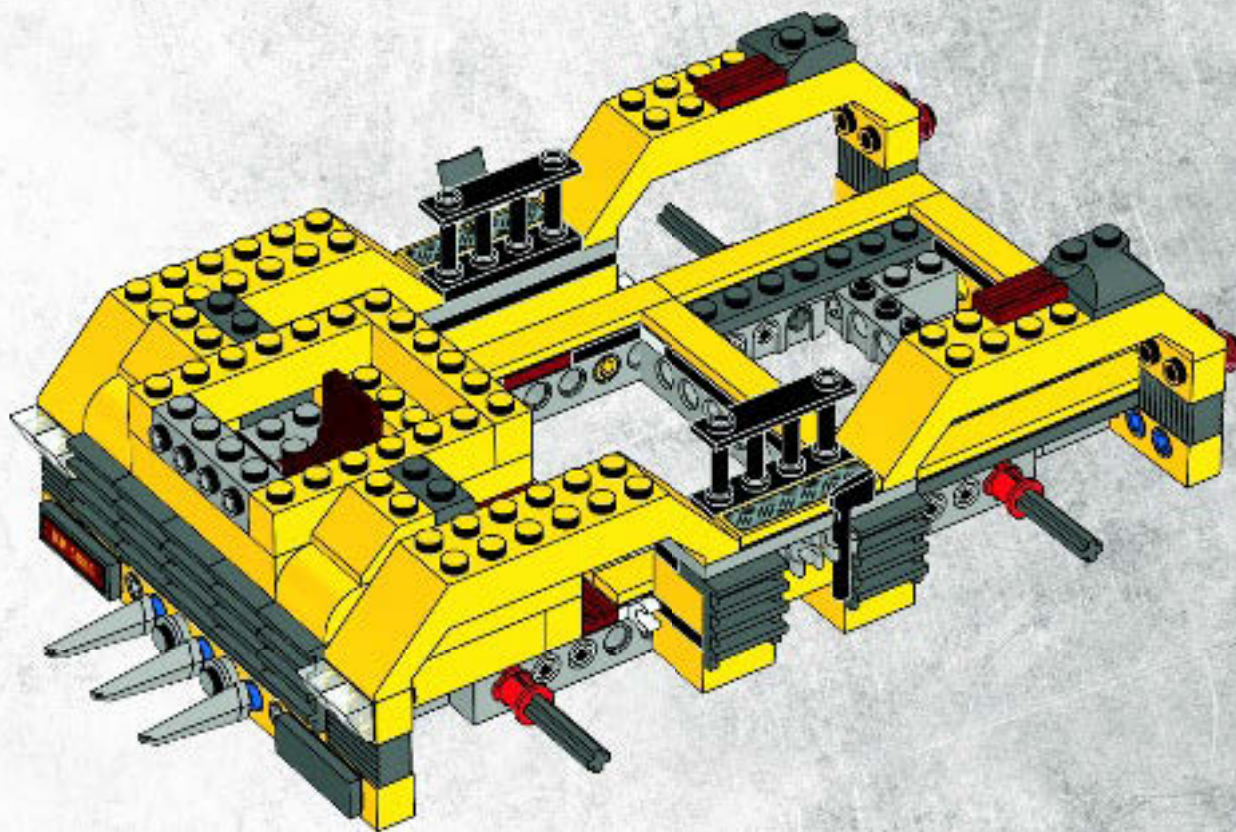

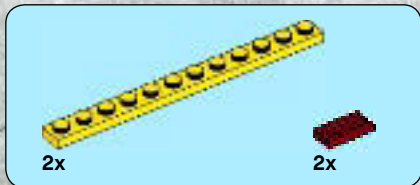

44

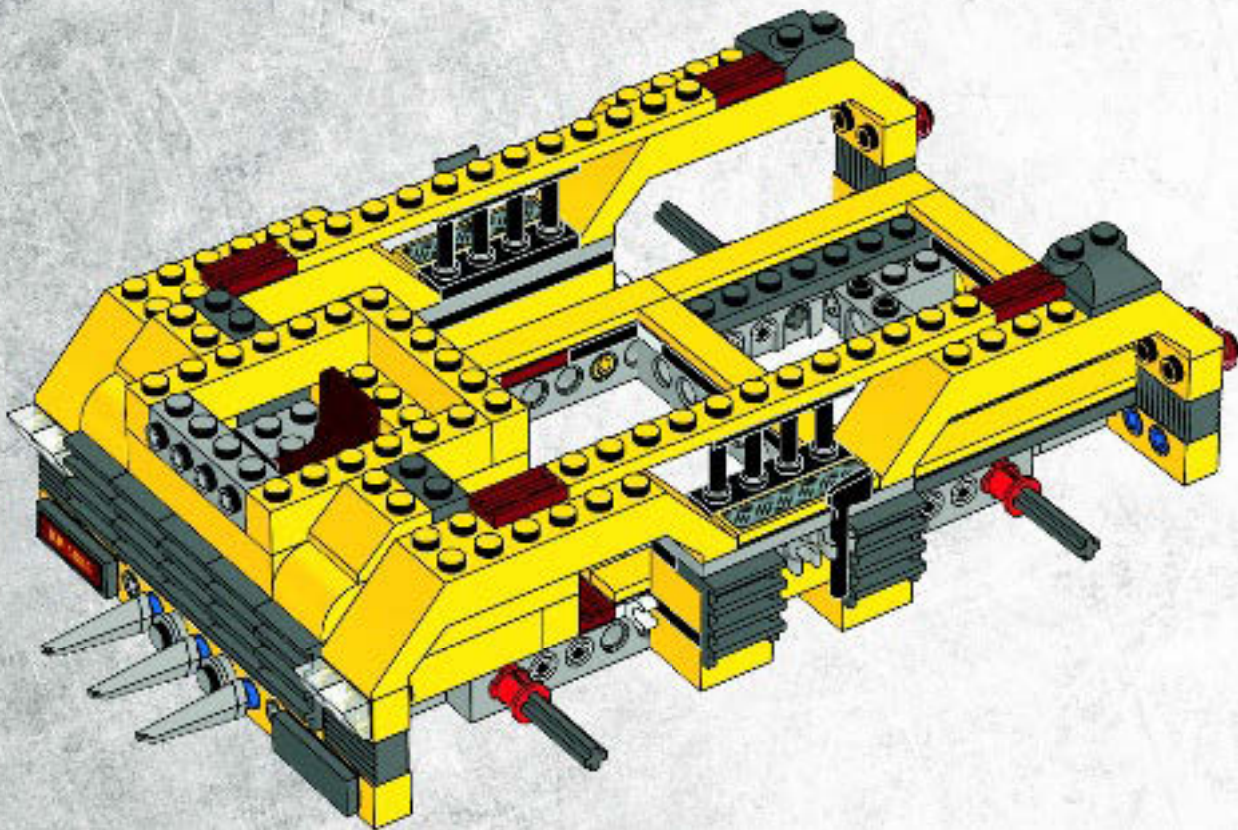



4x

45

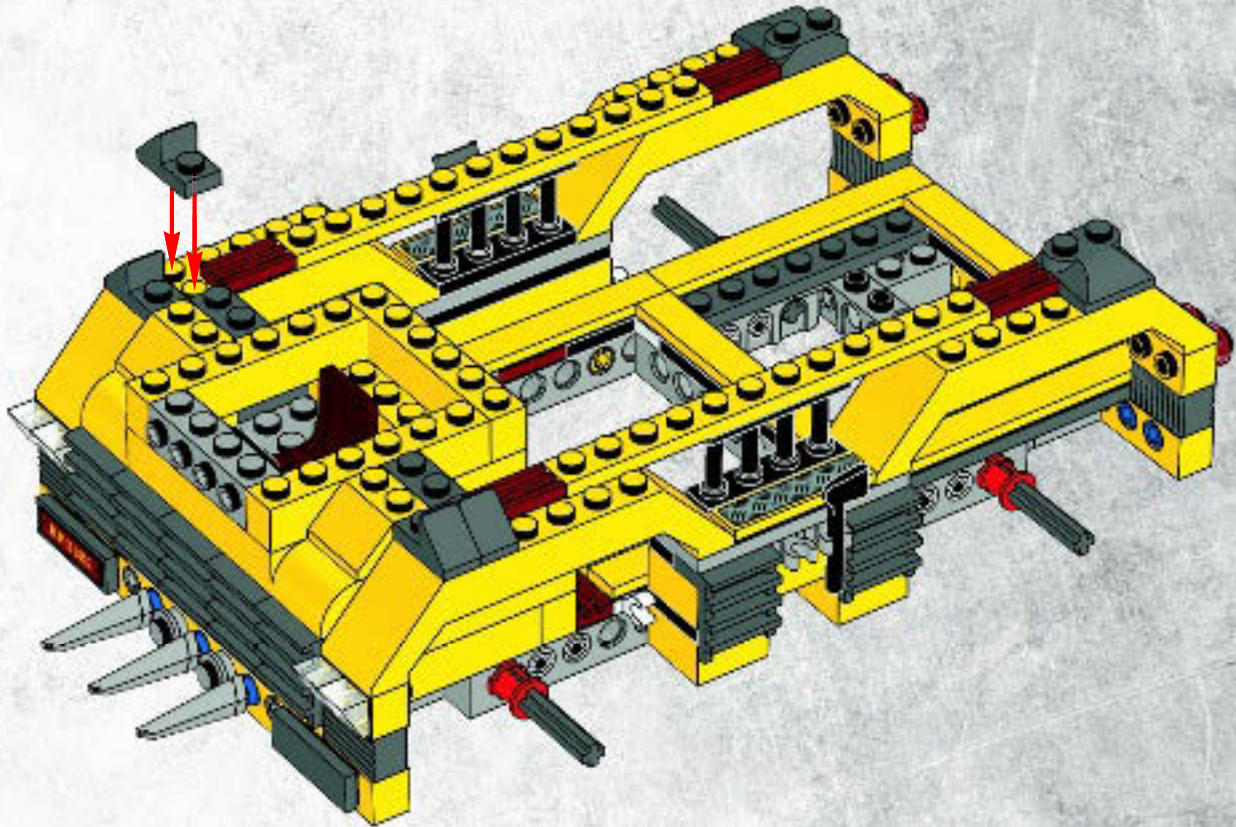



46

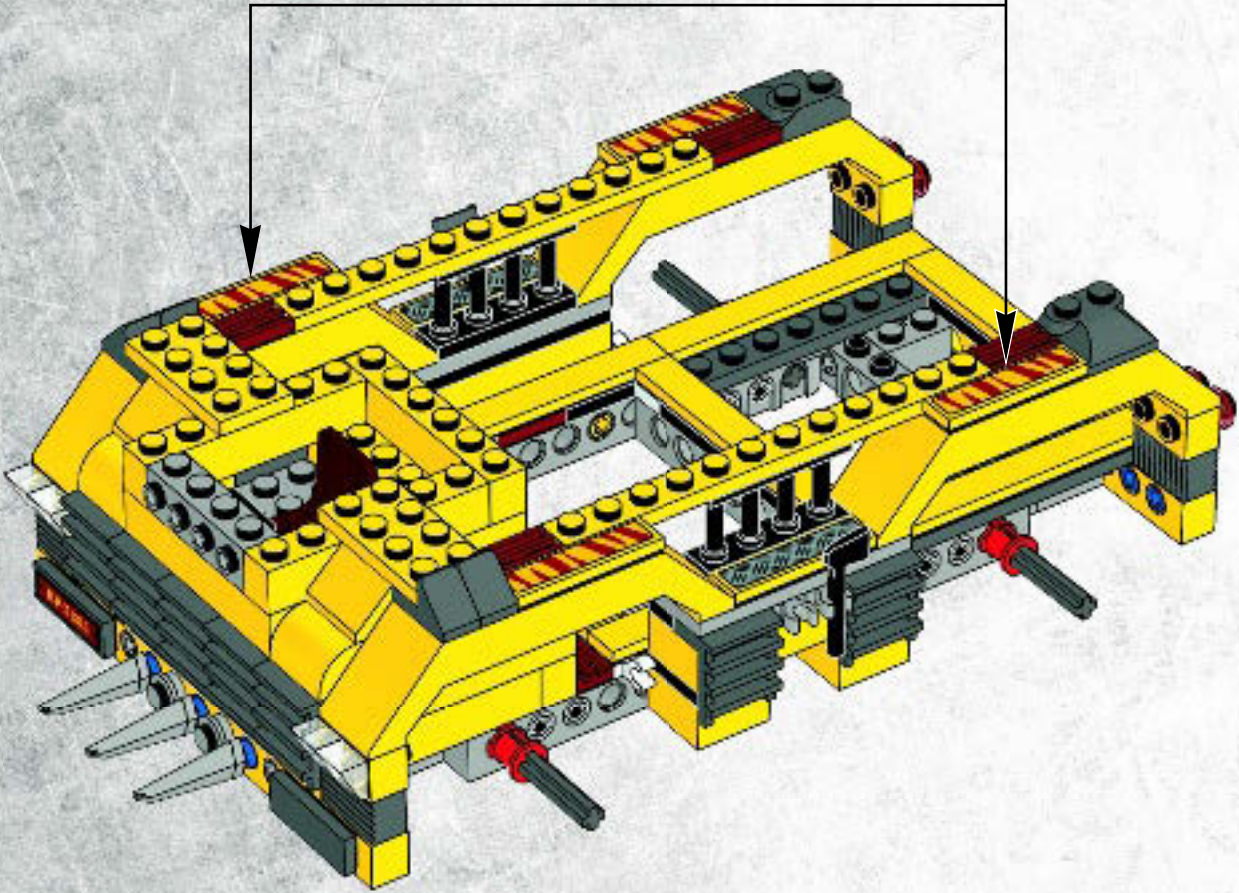
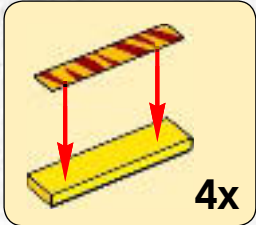



2x



2x

47

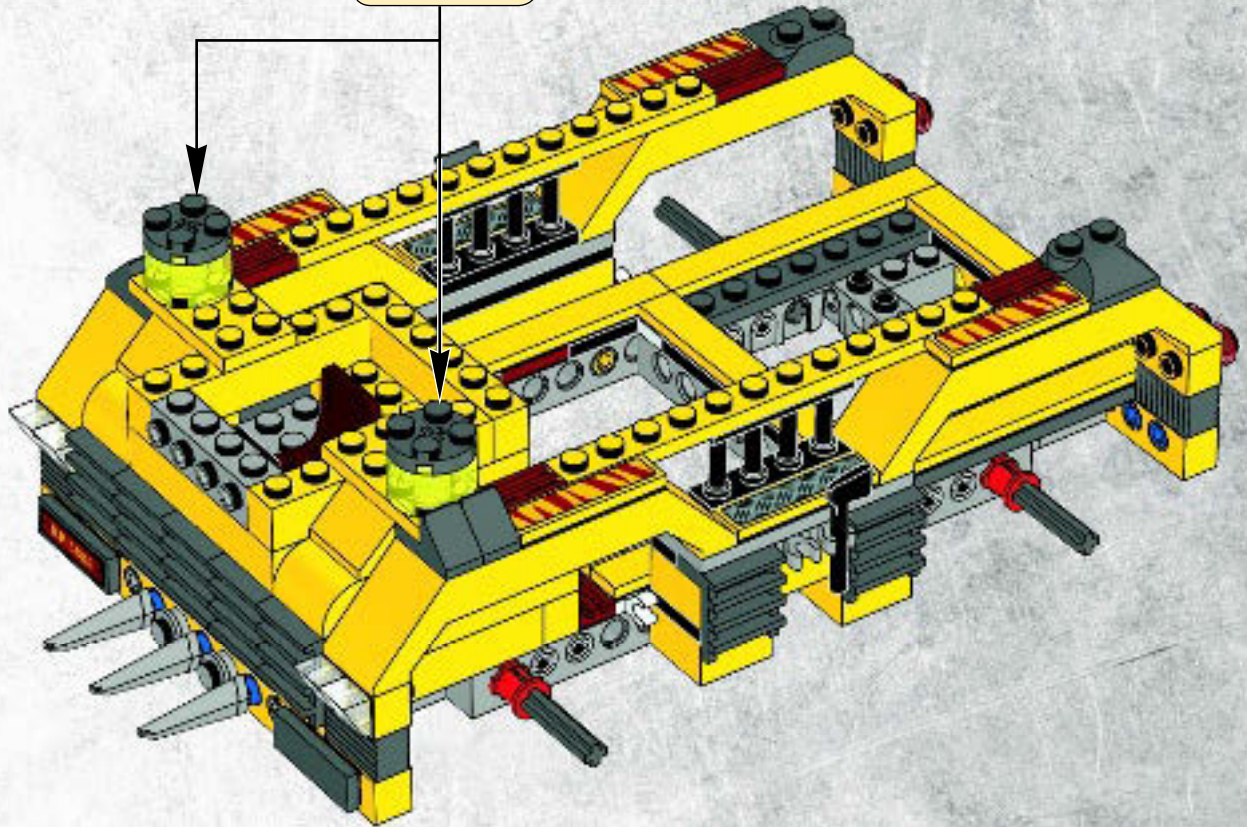
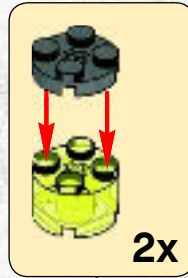



2x

48



2x

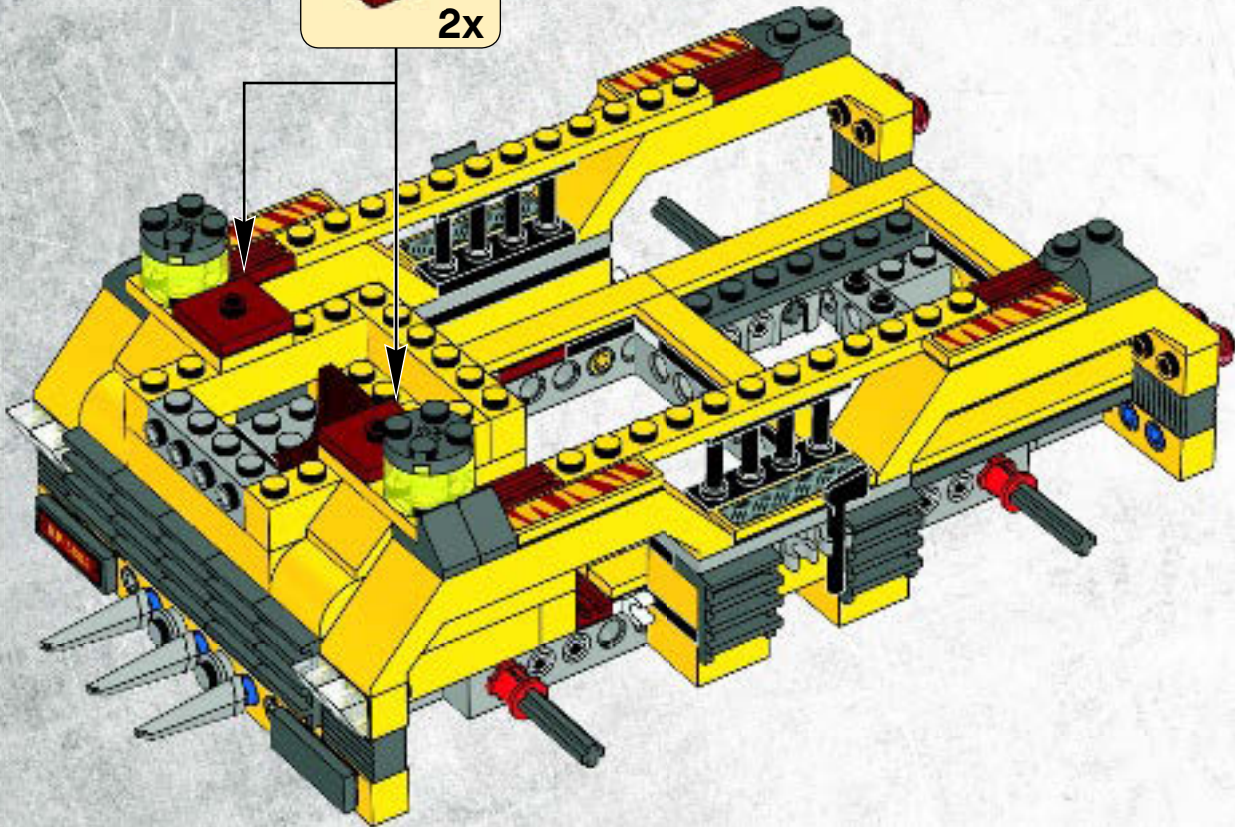

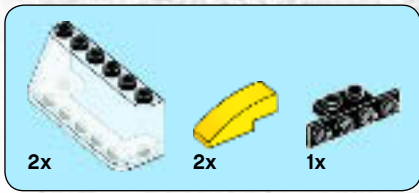

49

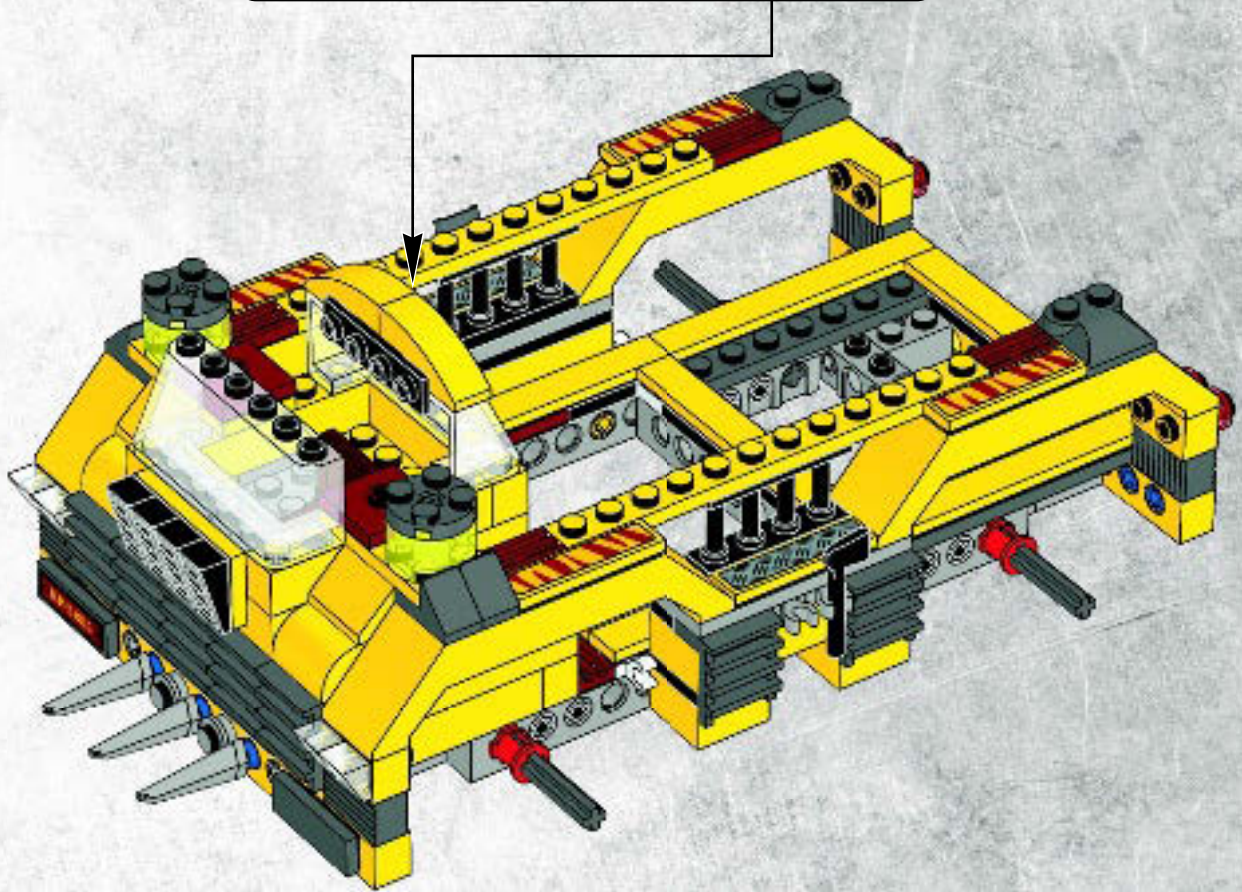
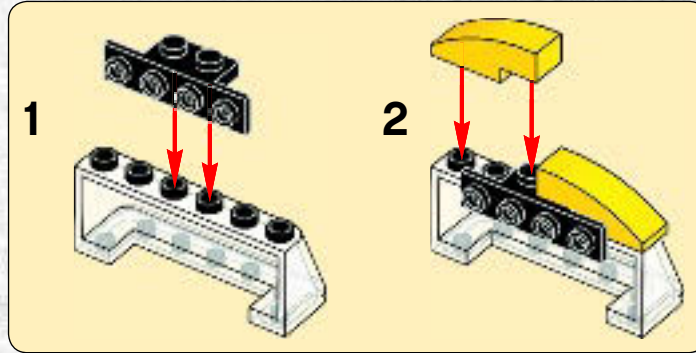



1x



4x

50

1

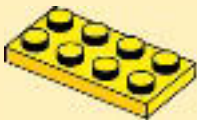

2

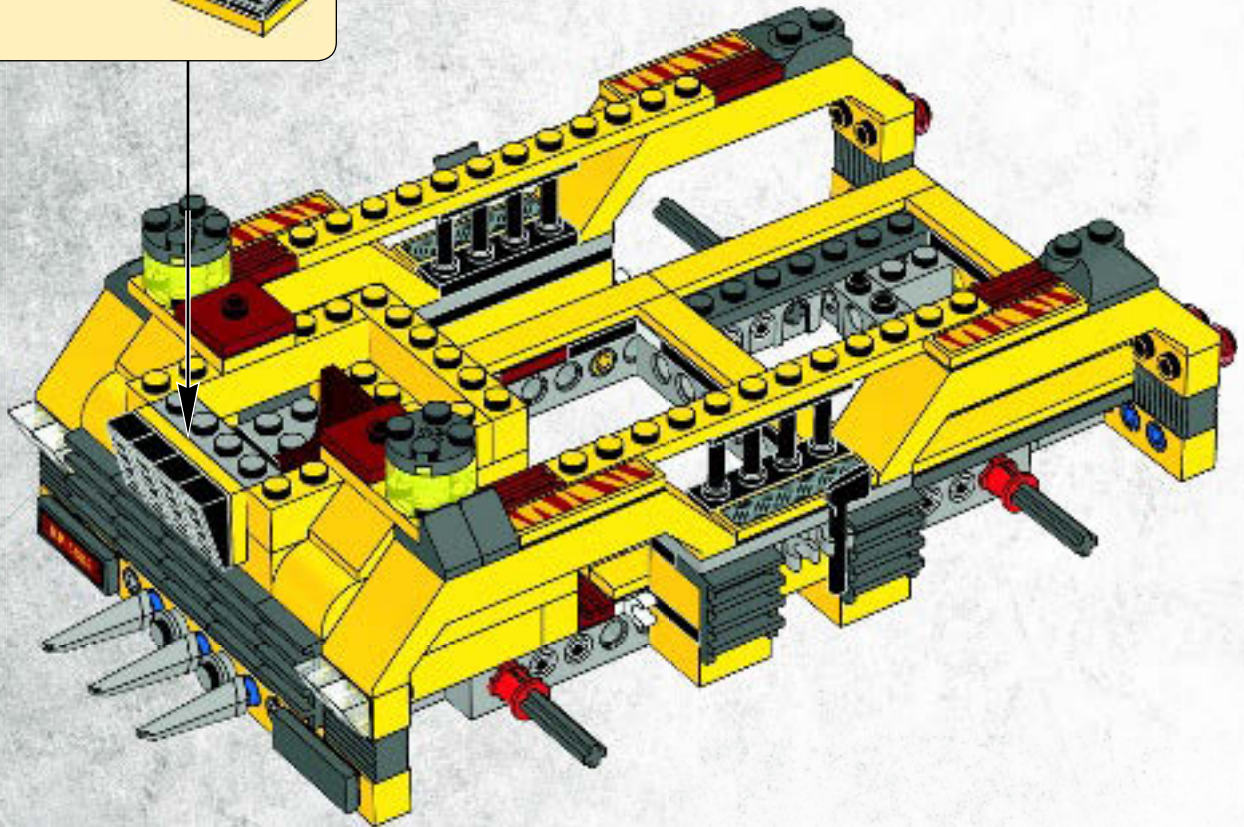
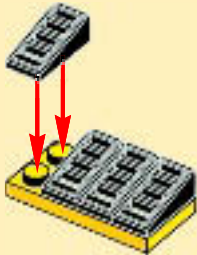



1x

51

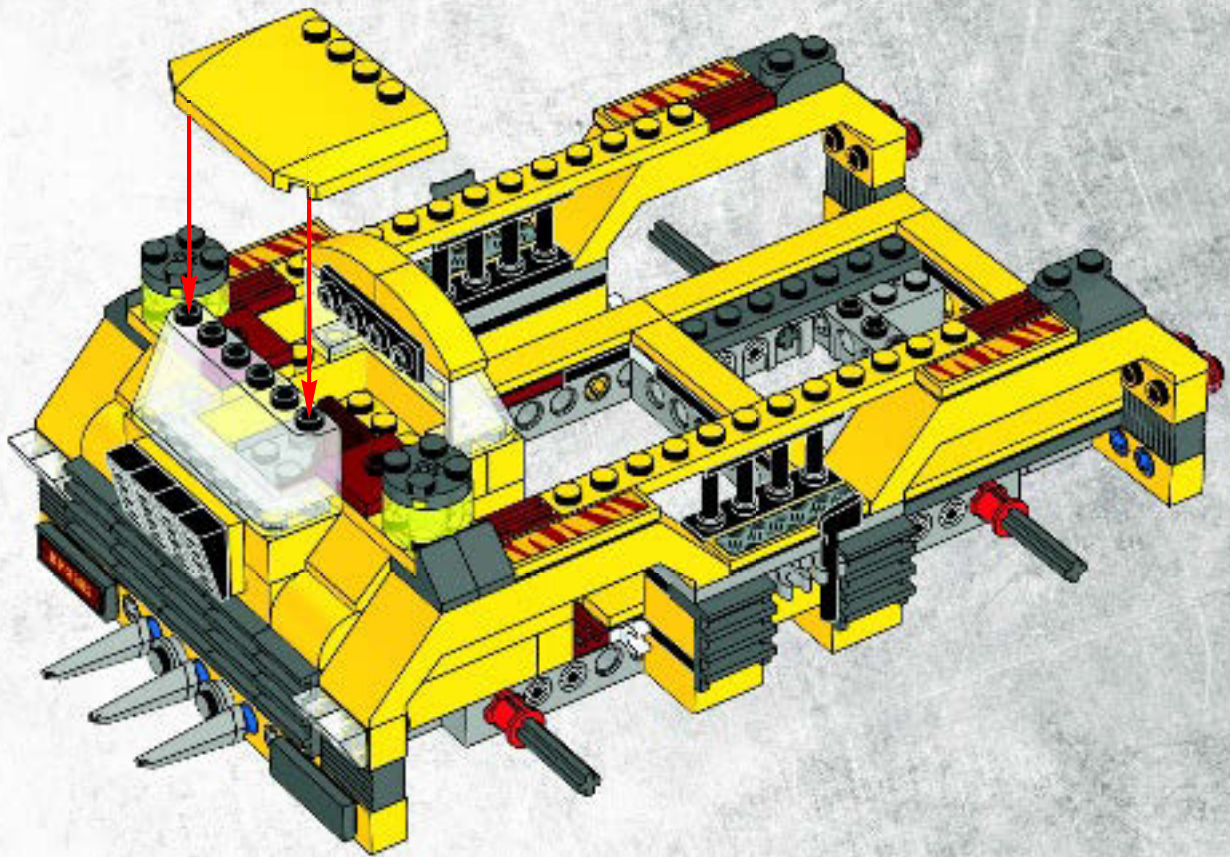



2x

52

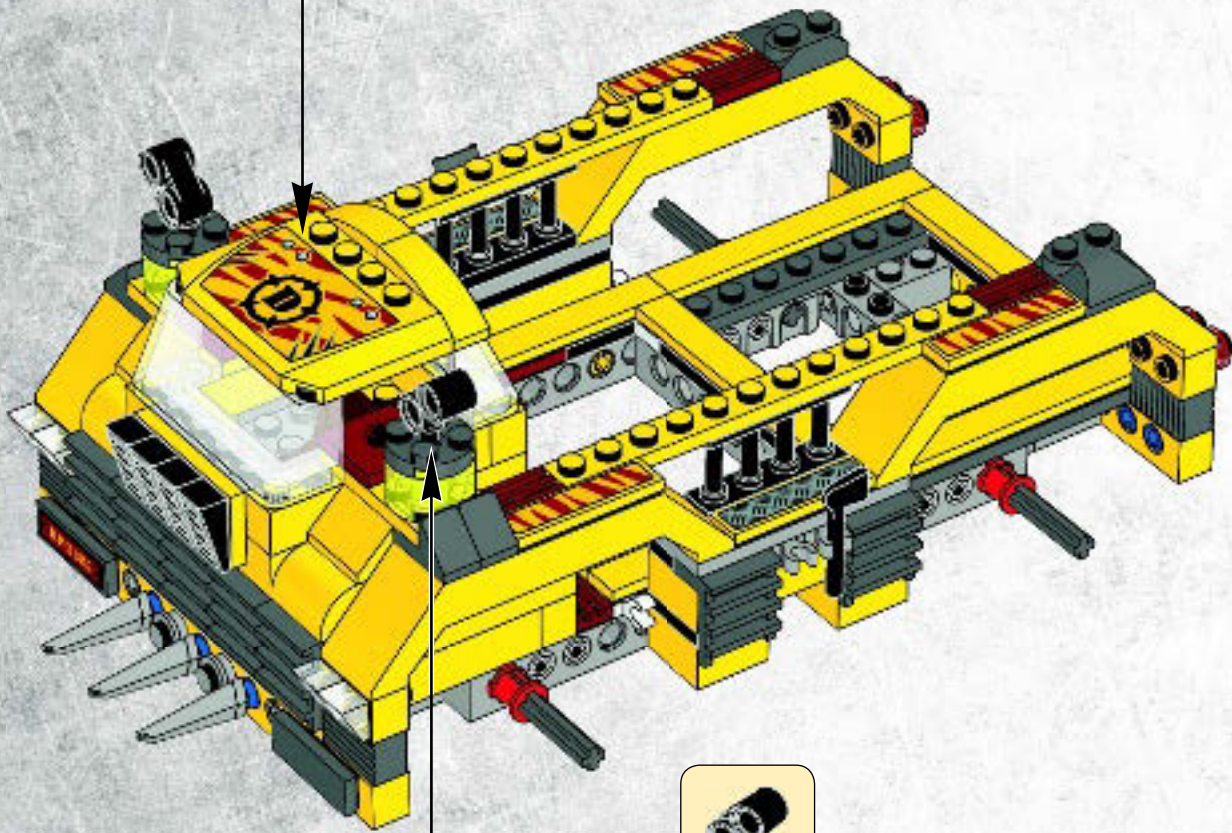



4x

53



4x

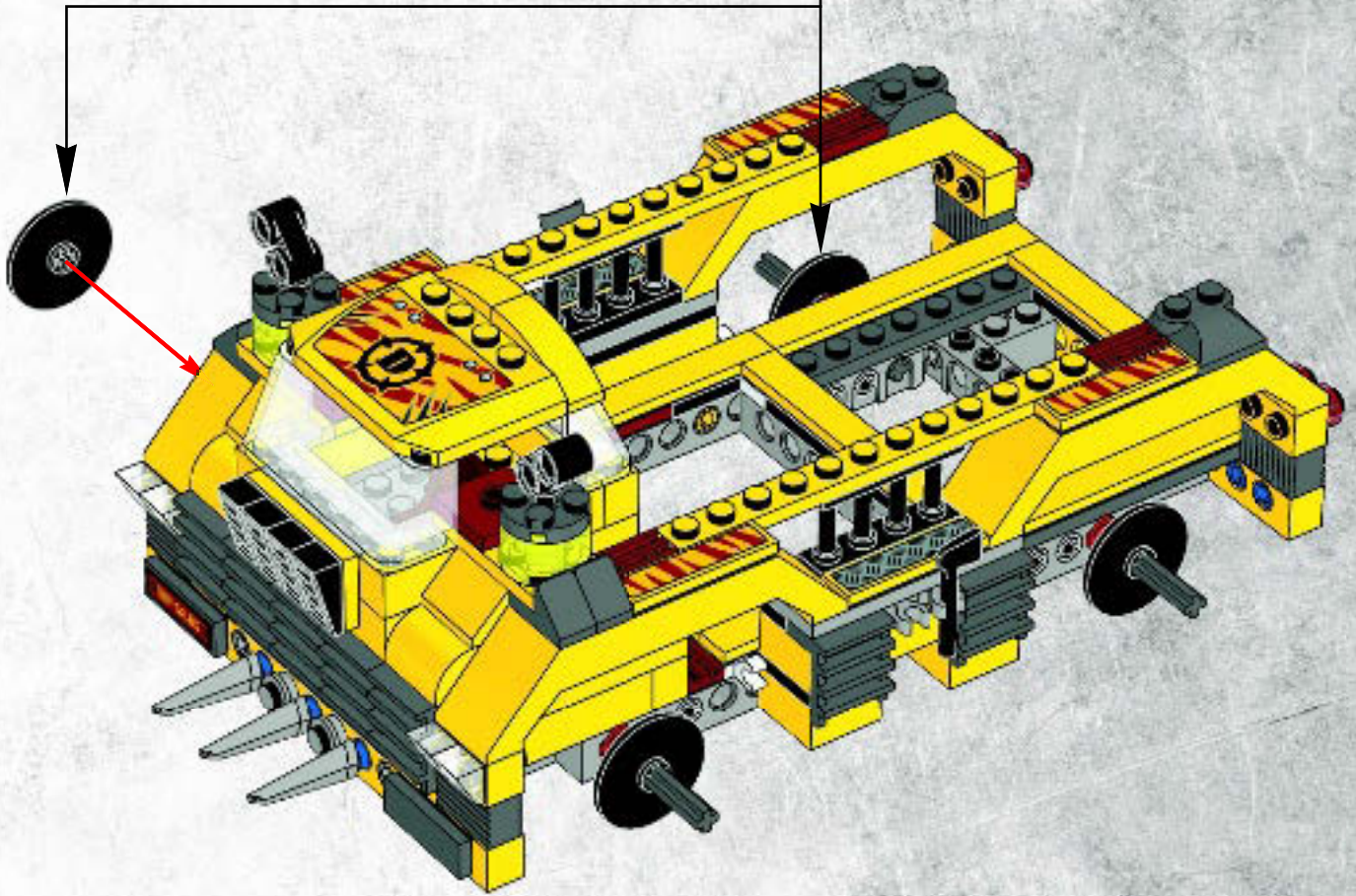

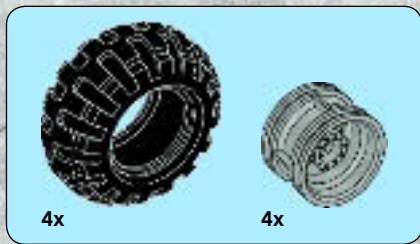

54

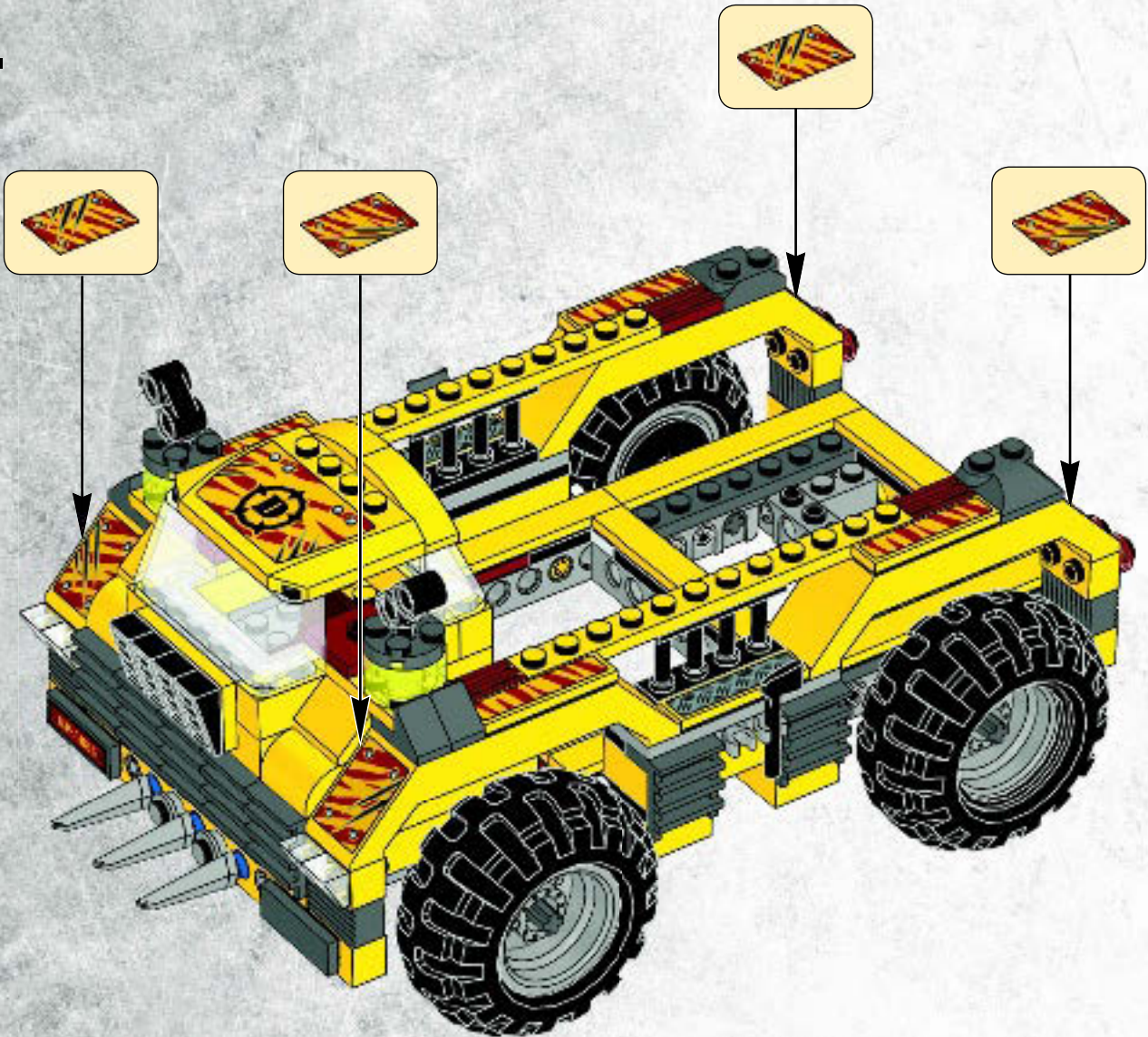

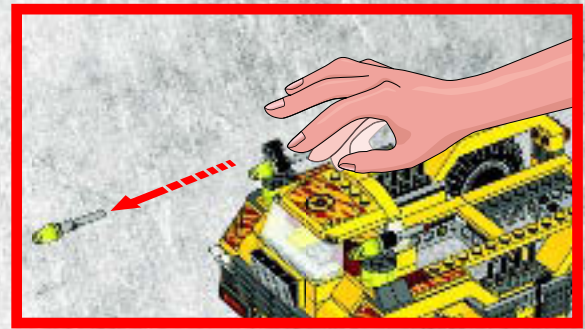
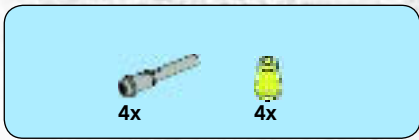

55

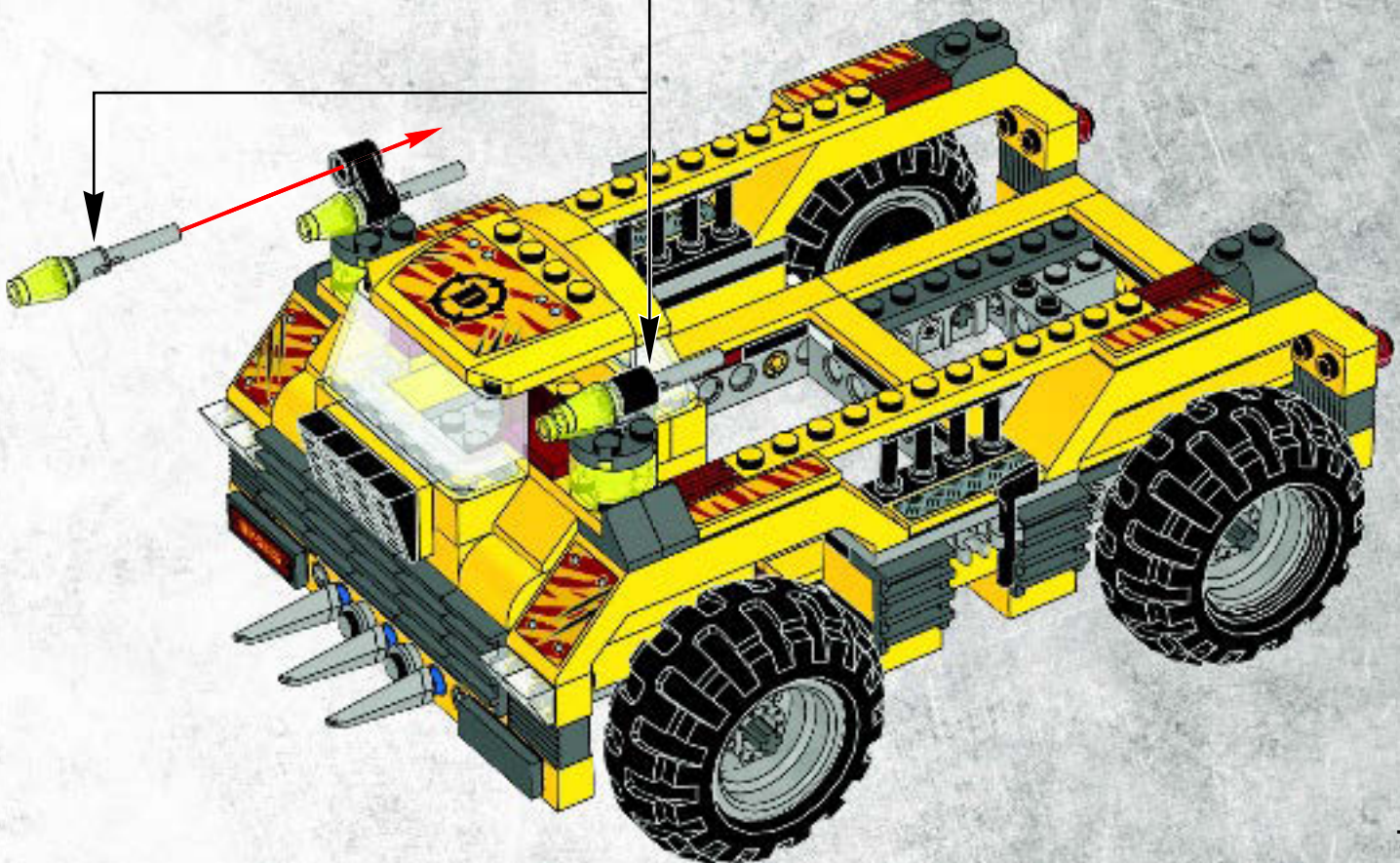
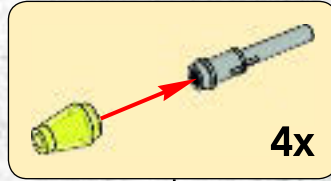

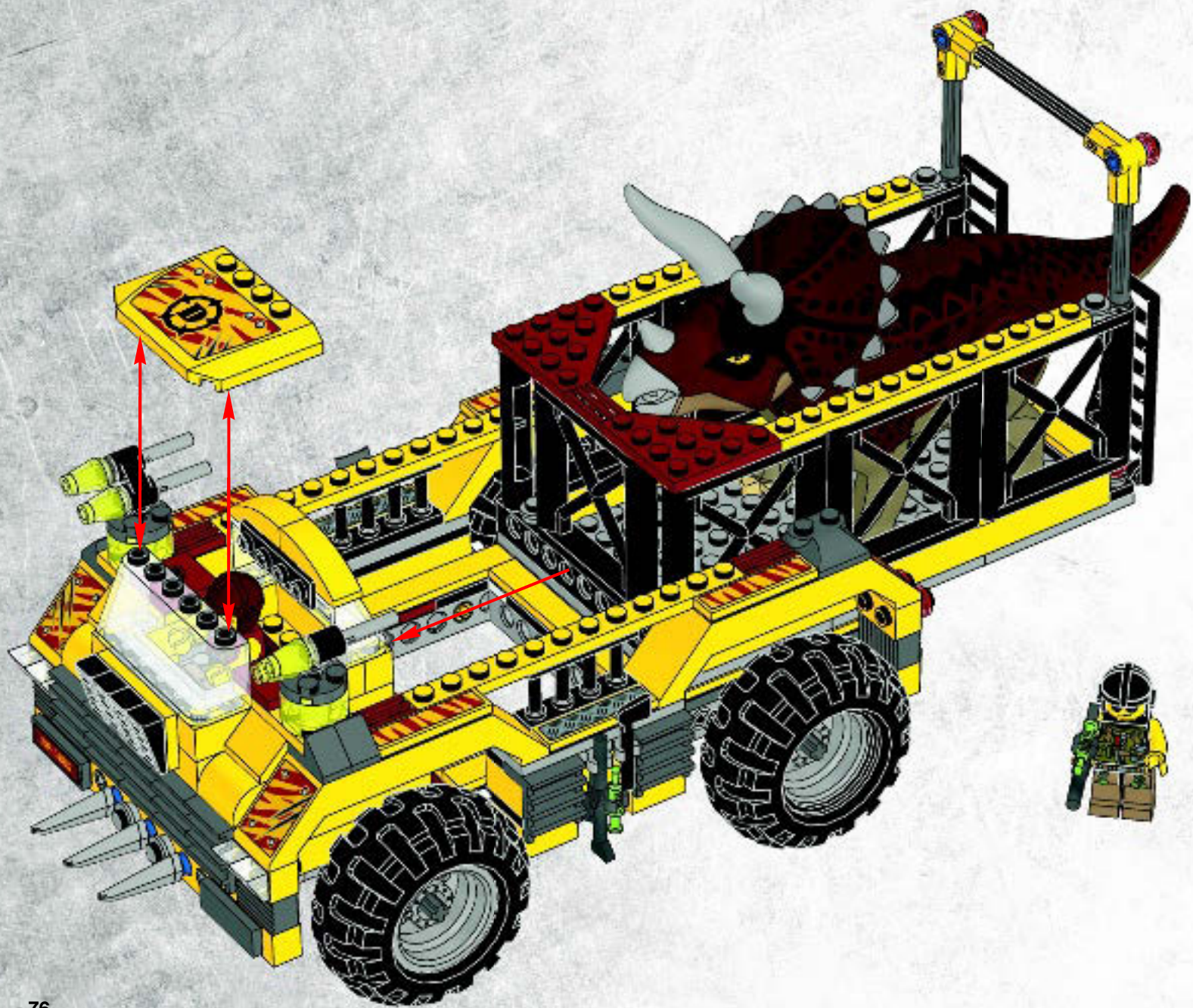

Customer Service
Kundenservice
Service Consommateurs
Servicio Al Consumidor
www.lego.com/service or dial

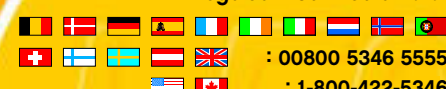
: 00800 5346 5555
: 1-800-422-5346

5882



5884



5883



5885



5886

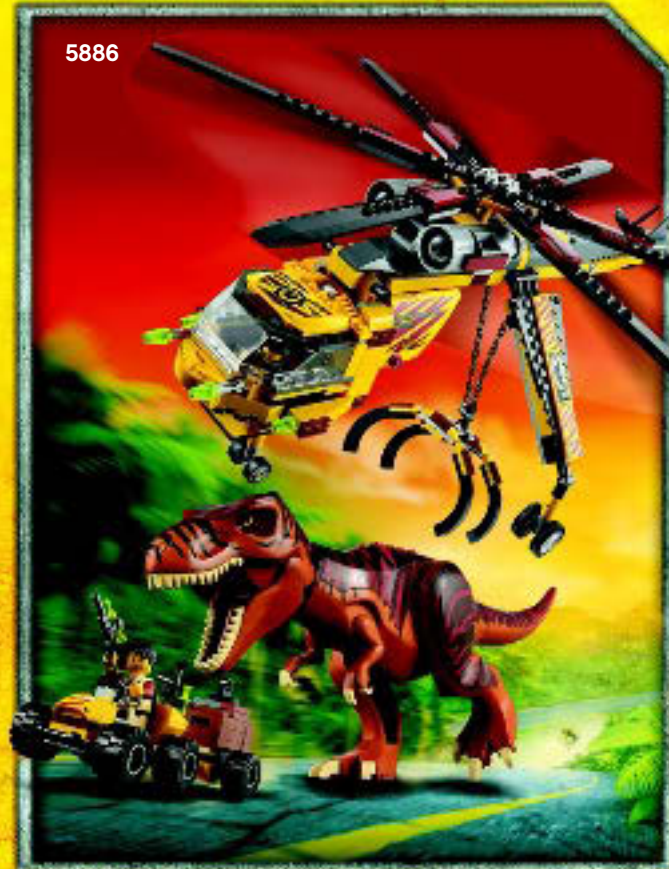

5887





www.LEGOclub.com



LEGO® Club Email

LEGO club™

FREE! GRATIS! GRATUIT!



LEGO® Club Magazine

SIGN UP ONLINE!

www.LEGOclub.com



00800 5346 5555*



1-866-534-6258 • 1-877-518-5346

US & Canada only

Canada seulement

* Freephone. Mobile charges may apply.
* Numéro sans frais. Des frais peuvent s'appliquer avec les téléphones cellulaires.
* Gebührenfrei, Kosten für Anrufe aus Mobilfunknetzen können abweichen.
* Gratis telefonnummer vanaf vaste lijn.
* Det är gratis, när du ringer från fasttelefon.
* Det är gratis, när du ringer från en fast telefon.
* Numéro sans frais. Des frais peuvent s'appliquer avec les téléphones portables.

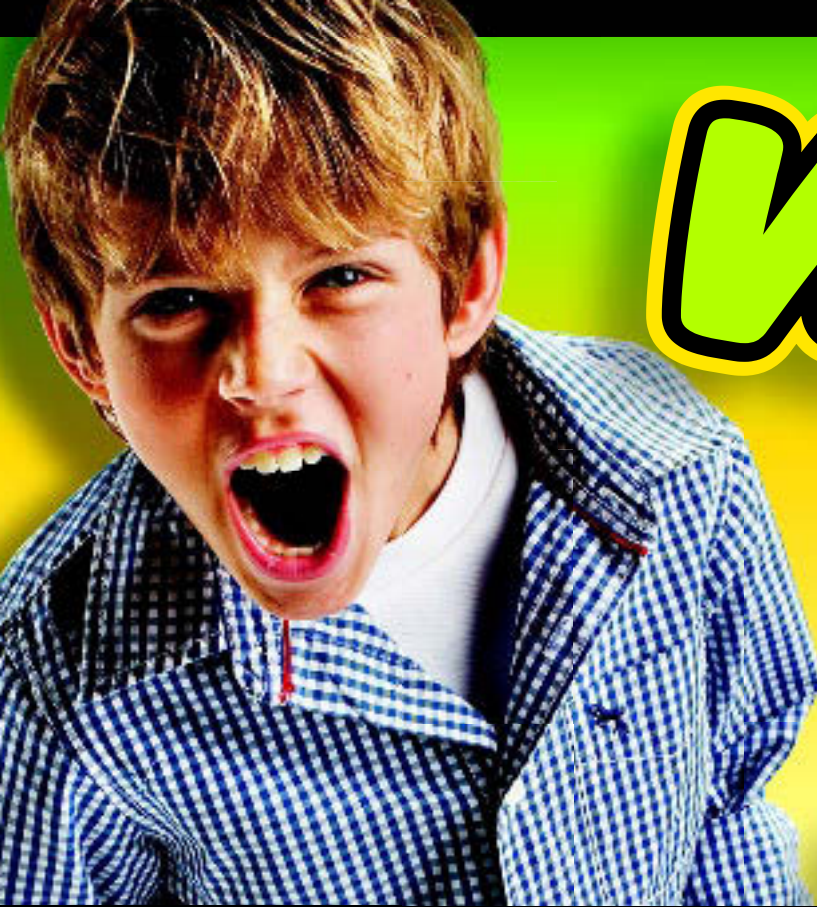

WIN!

Go to www.LEGOsurvey.com/product to fill out a survey for a chance to win a cool LEGO® Product.

No purchase necessary.

Open to all residents where not prohibited.



www.LEGO.com



www.LEGOsurvey.com/product

GEWINNE! WIN!

Nimm an der Umfrage auf www.LEGOsurvey.com/product teil und hab die Chance ein cooles LEGO® Produkt zu gewinnen!

Die Teilnahme am Gewinnspiel führt zu keinerlei Kaufverpflichtungen. Teilnahme in allen nicht ausgeschlossenen Ländern möglich.

Ga naar www.LEGOsurvey.com/product, vul een enquêteformulier in en maak kans op een cool LEGO® product.

Geen aankoopverplichting. Iedereen mag deelnemen, uitzonderend ingezetenden van landen waar een enquêteverbod geldt.

GAGNE! 当てよう!

Visite www.LEGOsurvey.com/product pour répondre à un questionnaire et avoir une chance de gagner un produit LEGO® très cool!

Aucune obligation d'achat. Ouvert à tous les résidents des pays autorisés.

www.LEGOsurvey.com/product にアクセスして、アンケートにご記入ください。当選者にはレゴ®製品を差し上げます。

お買い上げの必要はありません。

禁止されていない限り、すべての皆様にご利用いただけます。