

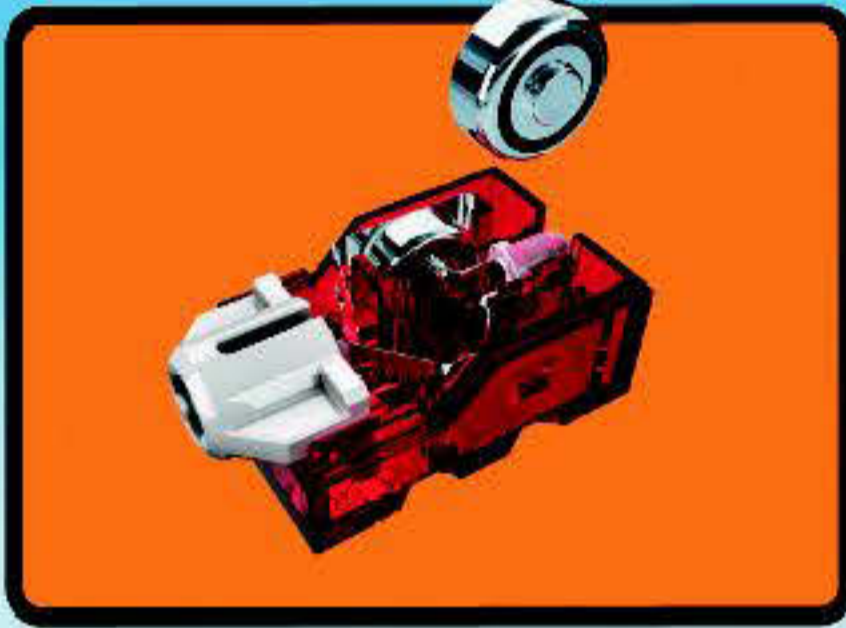

# CREATOR

5892





**GB**

**Important information about batteries**  
Never use different types of batteries together, or a combination of old and new batteries. Always remove the batteries if the product is not to be used for a long time or if the batteries have run down. Never use charged batteries. Only use batteries of the type recommended, or a corresponding type. Insert the batteries so that the poles are correctly positioned. Rechargeable batteries must be recharged using the correct battery charger under the supervision of an adult. You cannot recharge batteries while they are still in the product, and you must never try to do so. Never attempt to recharge non-rechargeable batteries. Never short-circuit the battery holder.

**IT**

**Importanti informazioni sulle batterie**  
Non usare mai contemporaneamente batterie di tipo diverso e batterie nuove e usate insieme. Rimuovere sempre le batterie quando il prodotto non venga utilizzato per periodi prolungati, oppure se le batterie sono esaurite. Non utilizzare mai batterie sbagliate. Usare esclusivamente batterie del tipo raccomandato o un equivalente. Inserire le batterie avendo cura che le loro polarità siano corrette. Le batterie ricaricabili vanno ricaricate in un caricabatterie di tipo idoneo e con la supervisione di un adulto. Non è possibile a noi bisogna mai tentare di ricaricare le batterie mentre queste sono inserite nel prodotto. Non tentare mai di ricaricare le batterie non ricaricabili. Non cortocircuitare mai il portabatterie.

**DA**

**Viktig information om batterier**  
Brug aldrig forskellige typer batterier sammen, eller nye og gamle batterier samtidig. Tag altid batterierne ud, hvis du ikke skal bruge produktet i længere tid, eller hvis batterierne er brugt op. Anvend aldrig opladte batterier. Der må kun anvendes batterier af samme eller tilsvarende type som anbefalet. Batterierne skal vendes rigtigt når de i sættes. Genopladelige batterier skal oplades i en dedet beregnet oplader under opsyn af en voksen. Genopladelige batterier kan og må ikke forsøges opladet i produktet. Forsøg aldrig at genoplade ikke-genopladelige batterier. Kædet aldrig batterisættet sammenfæstet.

**PT**

**Informações importantes acerca das pilhas**  
Nunca use tipos diferentes de pilhas em conjunto, nem uma combinação de pilhas novas e usadas. Retire sempre as pilhas se o produto não vai ser utilizado durante muito tempo ou se as pilhas se tiverem gasto. Nunca use pilhas recarregáveis. Use apenas pilhas do tipo recomendado ou de um tipo correspondente. Insira as pilhas de forma a que os seus pólos fiquem correctamente posicionados. Pilhas recarregáveis deverão ser recarregadas utilizando o recarregador de pilhas correcto sob a supervisão de um adulto. Não é possível recarregar pilhas recarregáveis enquanto elas estão inseridas dentro do produto, e nunca devem ser feitas tentativas nessa sentido. Nunca tente recarregar pilhas não recarregáveis. Nunca ligue curto-circuitos de compartimento das pilhas.

**DE**

**Wichtige Information zu Batterien**  
Benutzen Sie niemals unterschiedliche Arten von Batterien oder alte und neue gleichzeitig. Nehmen Sie stets alle Batterien heraus, wenn sich das Modell längere Zeit nicht gespielt wird oder wenn die Batterien leer sind. Verwenden Sie niemals beschädigte Batterien. Verwenden Sie ausschließlich empfohlenen bzw. geeigneten Batterien. Achten Sie beim Einsetzen der Batterien auf die richtige Polung. Wiederaufladbare Batterien sollten mit einem geeigneten Ladegerät aufgeladen werden – unter der Aufsicht eines Erwachsenen. Batterien können und sollten niemals während des Einsatzes im Produkt aufgeladen werden, während die Zellen im Modell bleiben. Versuchen Sie zwar keinen Umkehrlauf, „normale“ Batterien wiederzuladen. Schließen Sie die Batteriefach niemals kurz.

**NL**

**Bekrijnlijke informatie over batterijen**  
Gebruik nooit verschillende soorten of nieuwe en oude batterijen tegelijkertijd. Verwijder de batterijen altijd als je het product lange tijd niet wilt gebruiken of als de batterijen leeg zijn. Nooit beschadigde batterijen gebruiken. Uitsluitend batterijen van het aanbevolen of overeenkomstige type gebruiken. Leg de batterijen niet de polen in de juiste richting. Opladbare batterijen moeten in een voor dit doel bestemde oplader en onder toezicht van een volwassene opgeladen worden. Opladbare batterijen kunnen niet in het product worden opgeladen en je mag dit ook niet proberen te doen. Probeer nooit niet-oplaadbare batterijen op te laden. Nooit de batterijhouder kortsluiten.

**FI**

**Tärkeä tieto paristoista**  
Älä koskaan käytä eriyppisiä paristoja yhdessä. Älä myöskään käytä vanhoja lattuksia sekä uusia paristoja. Poista paristot tuotteen ulos, kun se on pitkäaikaan silloin käytettävä, tai jos paristot ovat tyhjiä. Älä koskaan käytä viallisia paristoja. Käytä vain suositeltua mallia tai vastaavaa tyyppisiä paristoja. Aseta paristot oikein, sillä ne ovat suunniteltut oikeaan suuntaan. Latausparistot lataa erillään olevassa laitteessa. Latausparistot eivät voi ladata tuotteen sisällä. Älä koskaan yritä ladata paristoja, jolloin et ole tarkoituksella ladattavissa. Älä koskaan yhdistä useita paristoja koskettamalla niitä.

**EL**

**Σημαντικές πληροφορίες για τις μπαταρίες**  
Μην χρησιμοποιείτε ποτέ διαφορετικού τύπου μπαταρίες, ή παλιές και καινούριες μπαταρίες μαζί. Θυμάστε πάντα τις μπαταρίες αν δεν χρησιμοποιήσετε το προϊόν για μεγάλο χρονικό διάστημα ή αν οι μπαταρίες έχουν εξαντληθεί. Ποτέ μη χρησιμοποιείτε χαλασμένες μπαταρίες. Χρησιμοποιείτε μόνο μπαταρίες του συνιστάμενου τύπου, ή αντίστοιχου τύπου. Βεβαιώστε τις μπαταρίες με την σωστή πολικότητα. Οι παρτίες να φορτίζετε τις επαναφορτιζόμενες μπαταρίες χρησιμοποιώντας τον κατάλληλο φορτιστή μπαταριών υπό την επίβλεψη ενός ενήλικου. Δεν μπορείτε να επαναφορτίσετε τις μπαταρίες όταν αυτές βρίσκονται μέσα στο προϊόν, και ποτέ μην επιχειρήσετε να κάνετε κάτι τέτοιο. Μην επιχειρήσετε ποτέ να επαναφορτίσετε μη επαναφορτιζόμενες μπαταρίες. Ποτέ μη βραχυκυκλώσετε τη θήκη των μπαταριών.

**FR**

**Informations importantes concernant les piles**  
Ne jamais utiliser un mélange de différents types de piles, ou de piles neuves et de piles usées ou déjà utilisées. Toujours retirer les piles si le produit n'est pas utilisé durant une période prolongée ou si les piles sont vides. Ne jamais utiliser de piles endommagées. Utiliser uniquement des piles du type recommandé ou d'un type équivalent. Insérer les piles, respecter scrupuleusement le sens d'orientation des pôles (+/-). Les piles rechargeables doivent être rechargées en utilisant un chargeur de piles adéquat et sous la surveillance d'un adulte. Il est impossible de recharger les piles quand elles sont installées dans le produit. Ne jamais tenter de le faire. Ne jamais essayer de recharger des piles non-rechargeables. Ne jamais court-circuiter le compartiment des piles.

**ES**

**Importante información sobre las baterías**  
No mezclar nunca diferentes tipos de baterías, ni utilizar baterías antiguas y nuevas a la vez. Siempre sacar las baterías, si el producto no se usará por un largo periodo de tiempo o si las baterías están agotadas. No utilizar nunca baterías dañadas. Utilizar solo el tipo de batería recomendada o una correspondiente. Colocar las baterías de manera que las puestas estén en su posición correcta. Las baterías recargables deben cargarse con un cargador adecuado bajo la supervisión de un adulto. Las baterías no pueden, ni deben recargarse mientras permanecen en el producto. No intentar nunca recargar baterías no recargables. Asegurarse que no se produce un cortocircuito en el porta baterías.

**SV**

**Viktig information om batterier**  
Använd aldrig olika sorters batterier samtidigt och inte heller en kombination av gamla och nya batterier. Ta alltid ur batterierna om produktens inte ska användas under en längre tid eller om batterierna är utslutna. Använd aldrig skadade batterier. Använd bara batterier av den typ som rekommenderats, eller av en motsvarande typ. Sätt i batterierna på rätt polering. Laddningsbara batterier måste laddas med rätt typ av laddningsbara och under en vuxens övervakning. De kan inte ladda batterierna medan de fortfarande sitter i produktens, och du får heller aldrig försöka göra det. Försök aldrig ladda inte laddningsbara batterier. Kædet aldrig batterisättningsenheten.

**JA**

**重要な電池に関する情報**  
異なる種類の電池を混合して使用しないでください。古い電池と新しい電池を一緒に使用しないでください。製品が長い期間使われないか、電池が消耗した場合は、必ず電池を取り出してください。破損した電池は決して使用しないでください。推奨の電池の種類、または同等の種類の電池のみを使用してください。電池の向きを正しく確認してください。充電可能な電池は、適切な充電器を使用して、大人が監視する中で充電してください。製品に電池が装着されている間は、充電可能な電池を充電することはできません。充電可能な電池を充電しないでください。充電可能な電池を充電しないでください。電池のショート回路を絶対に避けてください。

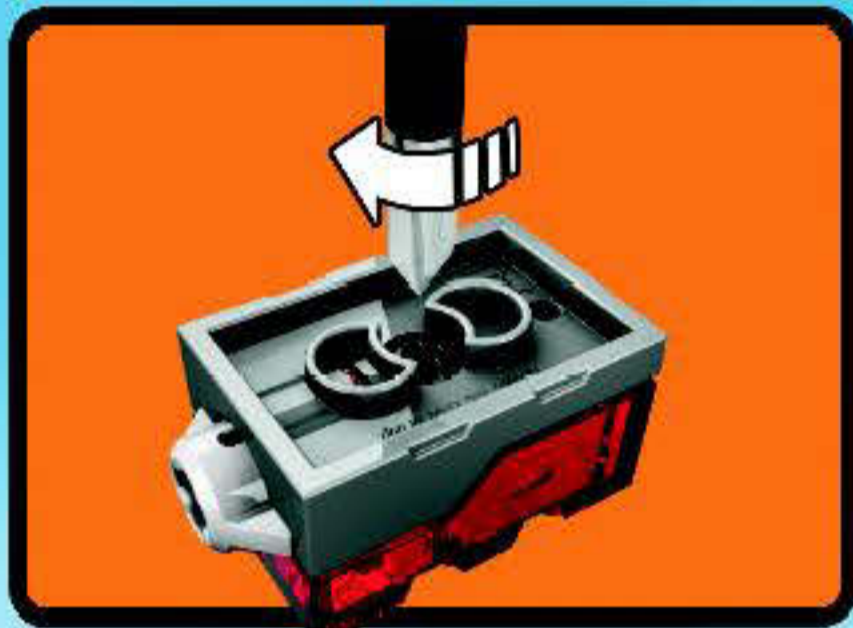

ZH

電池使用須知
切勿將不同類型的電池一併使用，亦不要混用電池與新電池聯合使用...

KO

배터리 사용 주의 사항
다른 전압의, 또는 다른 구동력 용량의 배터리와 함께 사용하지 마세요.
배터리와 새 배터리를 함께 사용하지 마세요.

RU

Необходима информация об элементах питания
Ни в каком случае не используйте одновременно элементы питания различных типов, а также элементы питания с разным сроком годности...

PL

Ważne informacje dotyczące baterii
Nigdy nie należy stosować razem różnych rodzajów baterii ani stosować równoczesnie starych i nowych baterii...

CZ

Důležitá informace o bateriích
Nikdy nepoužívejte společně různé typy baterií nebo kombinovat staré baterie s novými...

SK

Dôležitá informácia o batériách
Nikdy nepoužívajte súčasne rôzne typy batérií ani kombinovať staré batérie s novými...

HU

Főként tudnivalók az elemekről
Soha ne használjunk különböző típusú elemeket, illetve ne használjunk új és lemerült elemet egyaránt...

UA

Неободна інформація про батареї
Ніколи не використовуйте одночасно батареї різних типів або батареї з різним строком закінчення...

HR

Važne informacije o baterijama
Nikada ne koristite različite vrste baterija zajedno, kao ni kombinirati stare i nove baterije...

SR

Важна информација о батеријама
Никада не користите различите врсте батерија заједно, н ни комбиновати старе и нове батерије...

SL

Pomenljiva informacija o baterijskih vtičnikih
Nikoli ne uporabite različne vrste baterijskih vtičnikov skupaj ali pa nove vtičnike skupaj z rabljenimi...

RO

Informații importante cu privire la baterii
Nu folosiți niciodată împreună tipuri diferite de baterii și nici combinații de baterii noi și vechi...

BG

Важна информация за батериите
Не използвайте различни типове батерии едновременно, нито комбинации от стари и нови батерии...

LV

Svarīga informācija par baterijas elementiem
Nekad vienlaikus nelietojiet dažādu tipu, kā arī jaunas un vecas baterijas elementus...

ET

Oluline teave patareide kohta
Mõnda korrald ära sama tüüpi või vanusega patareid, eriti vanu ja uusi patareid...

LT

Svarbi informacija apie elementus
Niekada nenaudokite vienu metu skirtingų tipų, skirtingo amžiaus, taip pat su naujais elementais nenaudojate senų elementus...

TR

Piller hakkında önemli bilgiler
Pilleri zaman zaman değişik tipin pillerle ya da eski pillerle yeni pillerle bir arada kullanmayın...

1

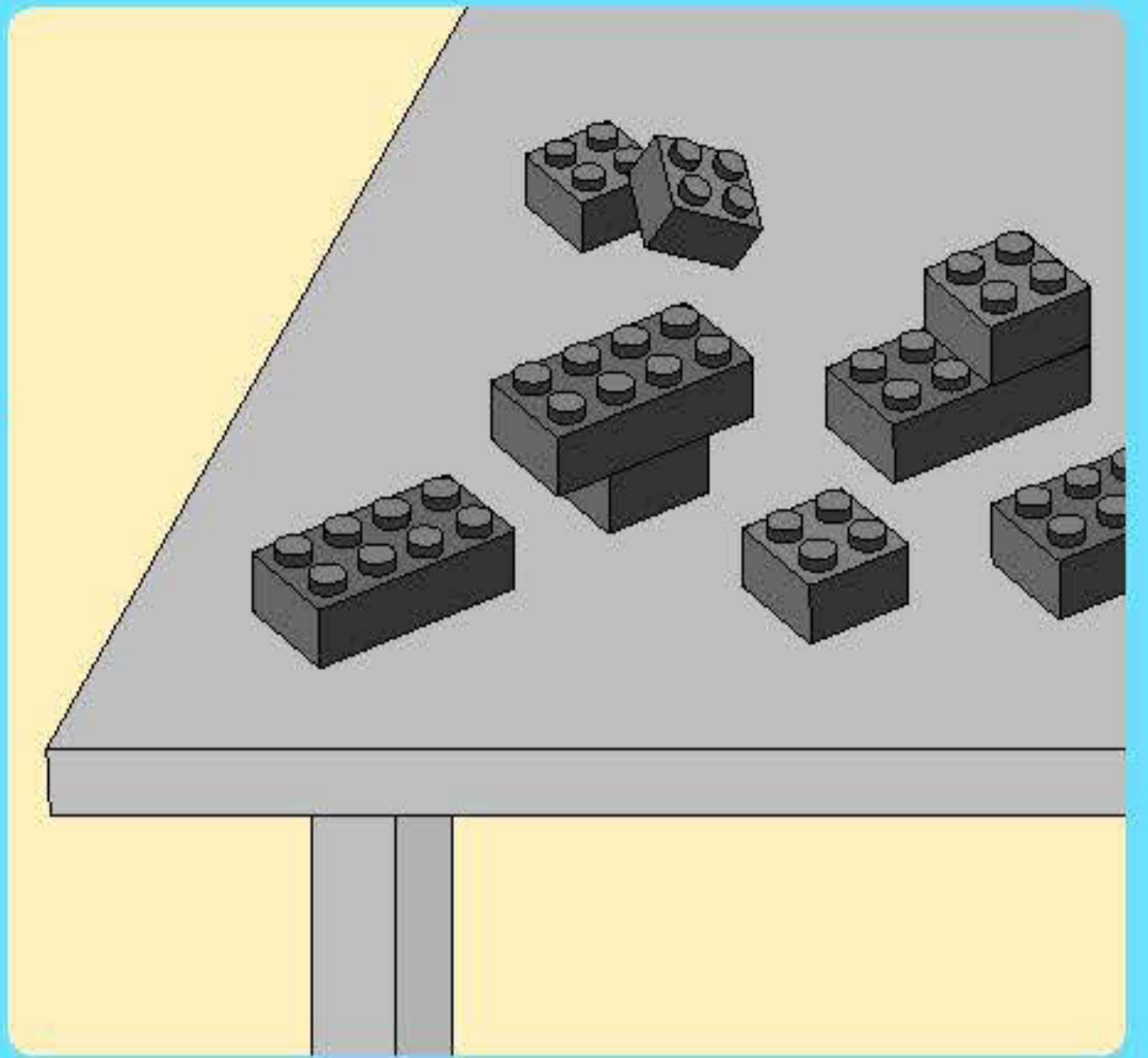
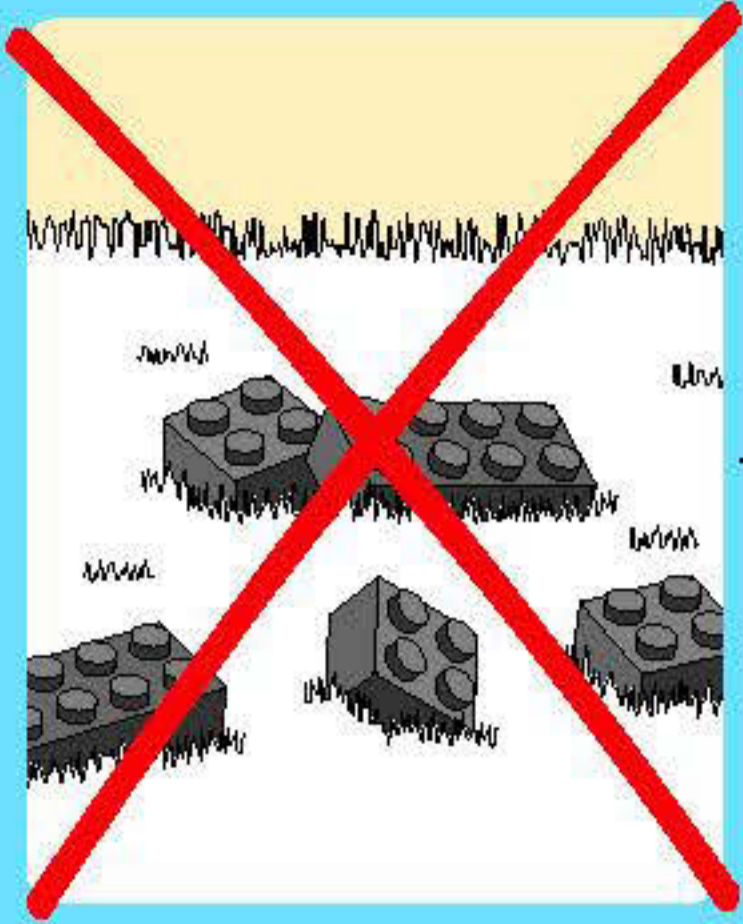

2

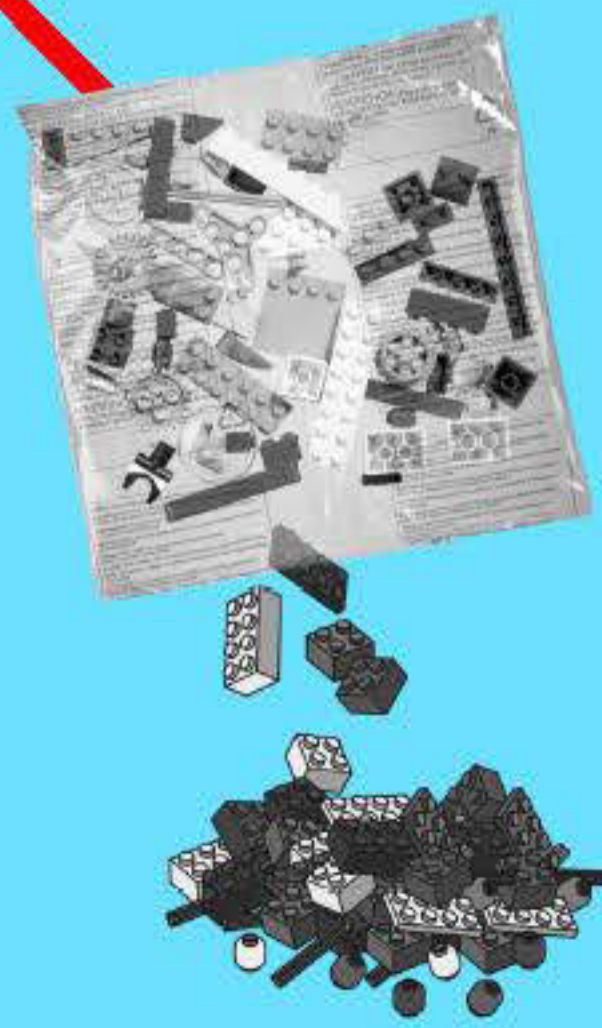
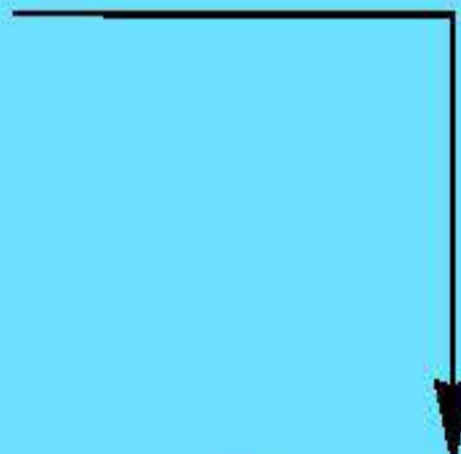



## Quick Build

Anfängermodelle  
Construction Facile  
Construcción rápida  
Construção Rápida  
Egyszerűen és gyorsan - kezdőknek



## Medium Build

Fortgeschrittenenmodelle  
Construction  
moyenne  
Construcción  
de nivel Intermedio  
Construção  
Intermédia  
Egyszerűen  
és gyorsan - gyakorlóknak



## Advanced Build

Profilmodelle  
Construction  
avancée  
Construcción  
de nivel avanzado  
Construção Avançada  
Egyszerűen és gyorsan -  
tapasztalt építőknek





2x

1



1x

2



2x



1x



1x

3

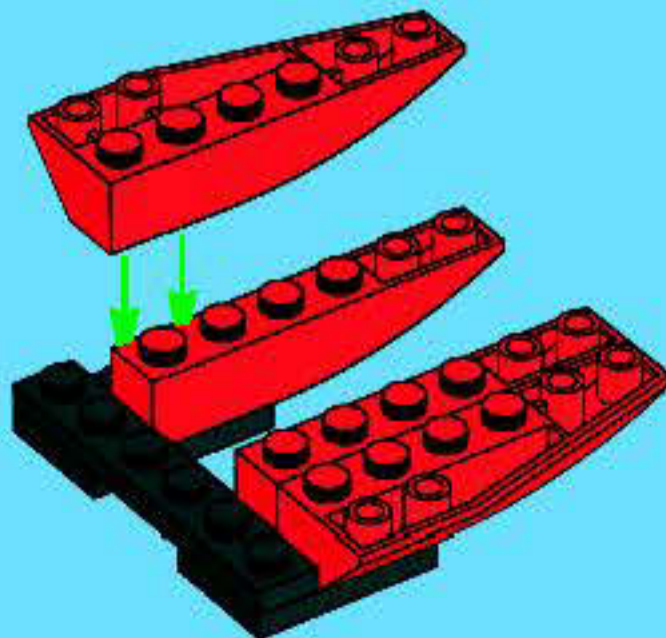



1x



2x



2x

# 4

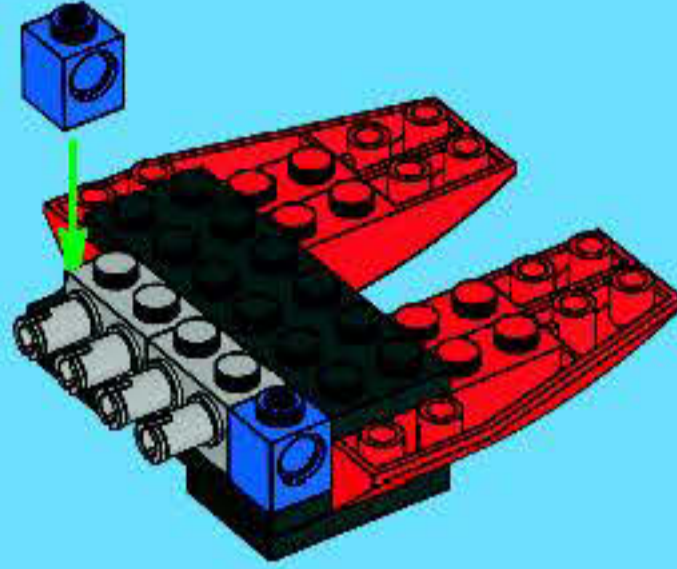

2x



2x

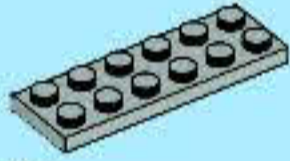

2x

# 5

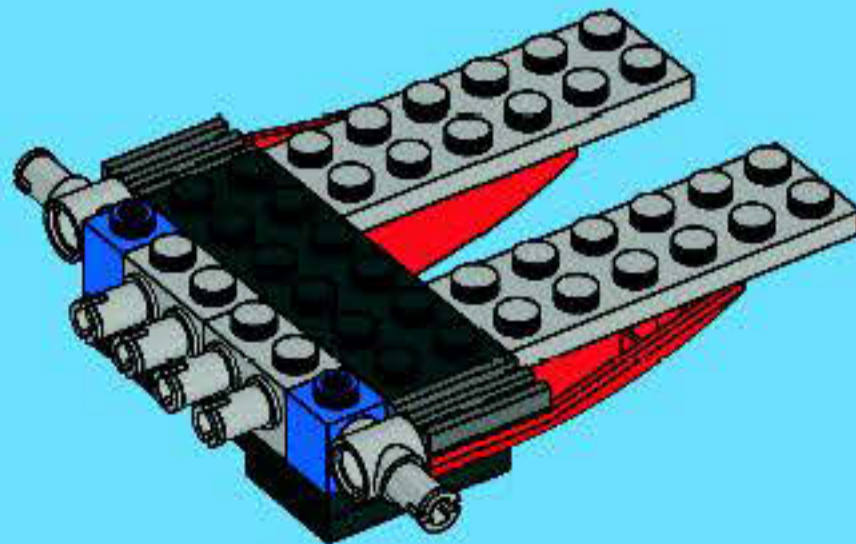







2x



2x

8

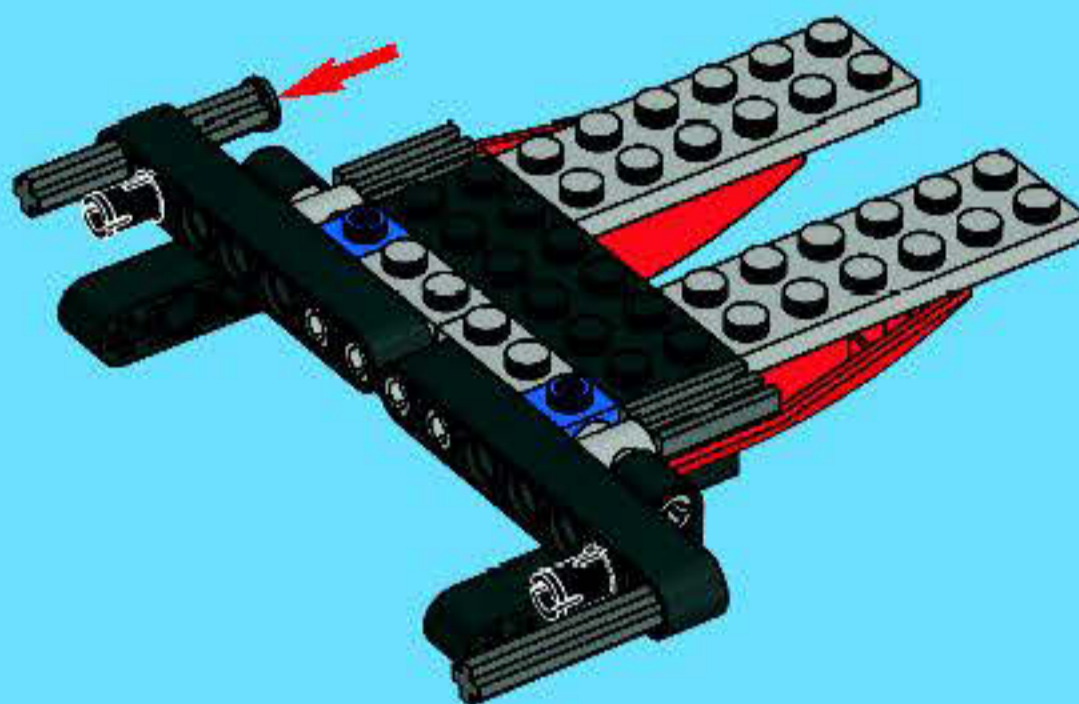

2x



2x

9



2x

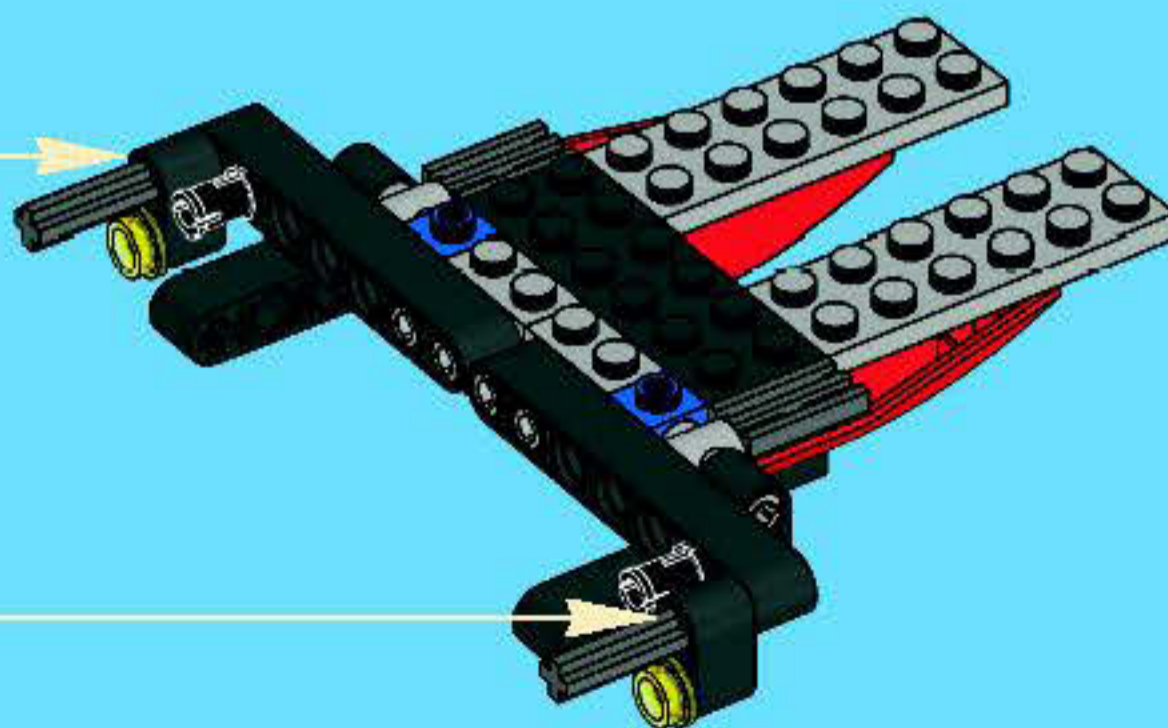

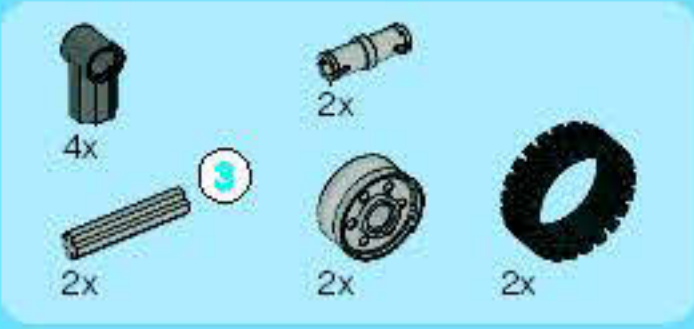

# 10

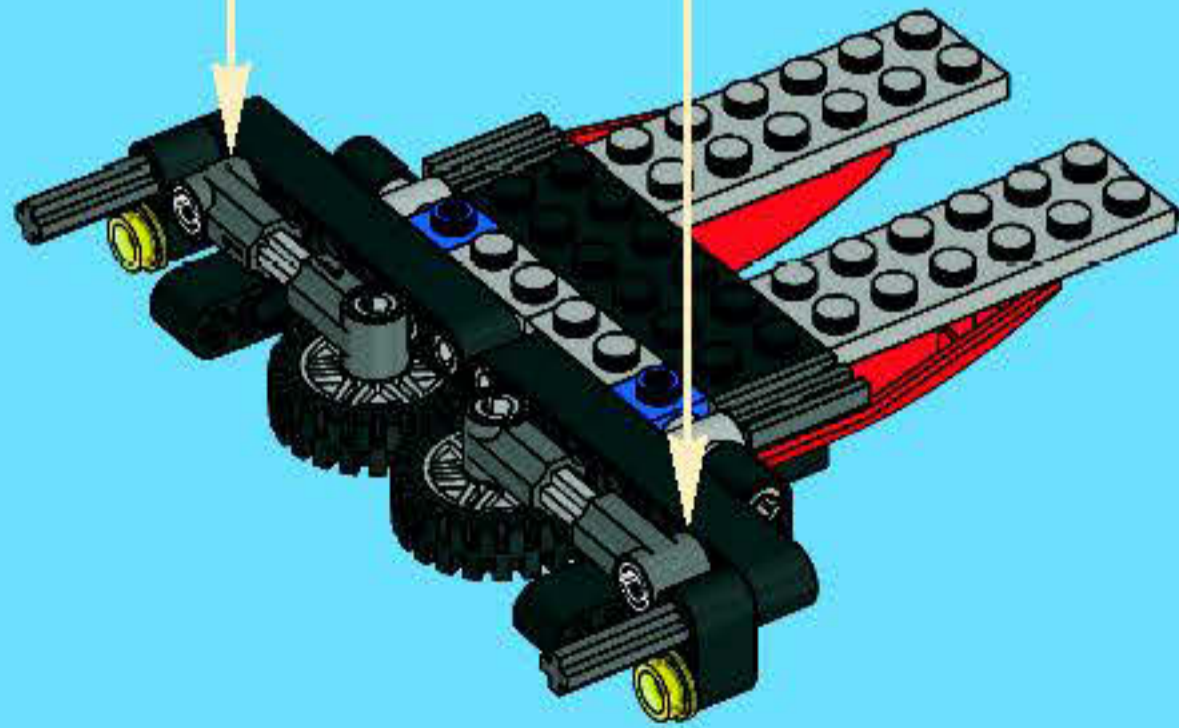
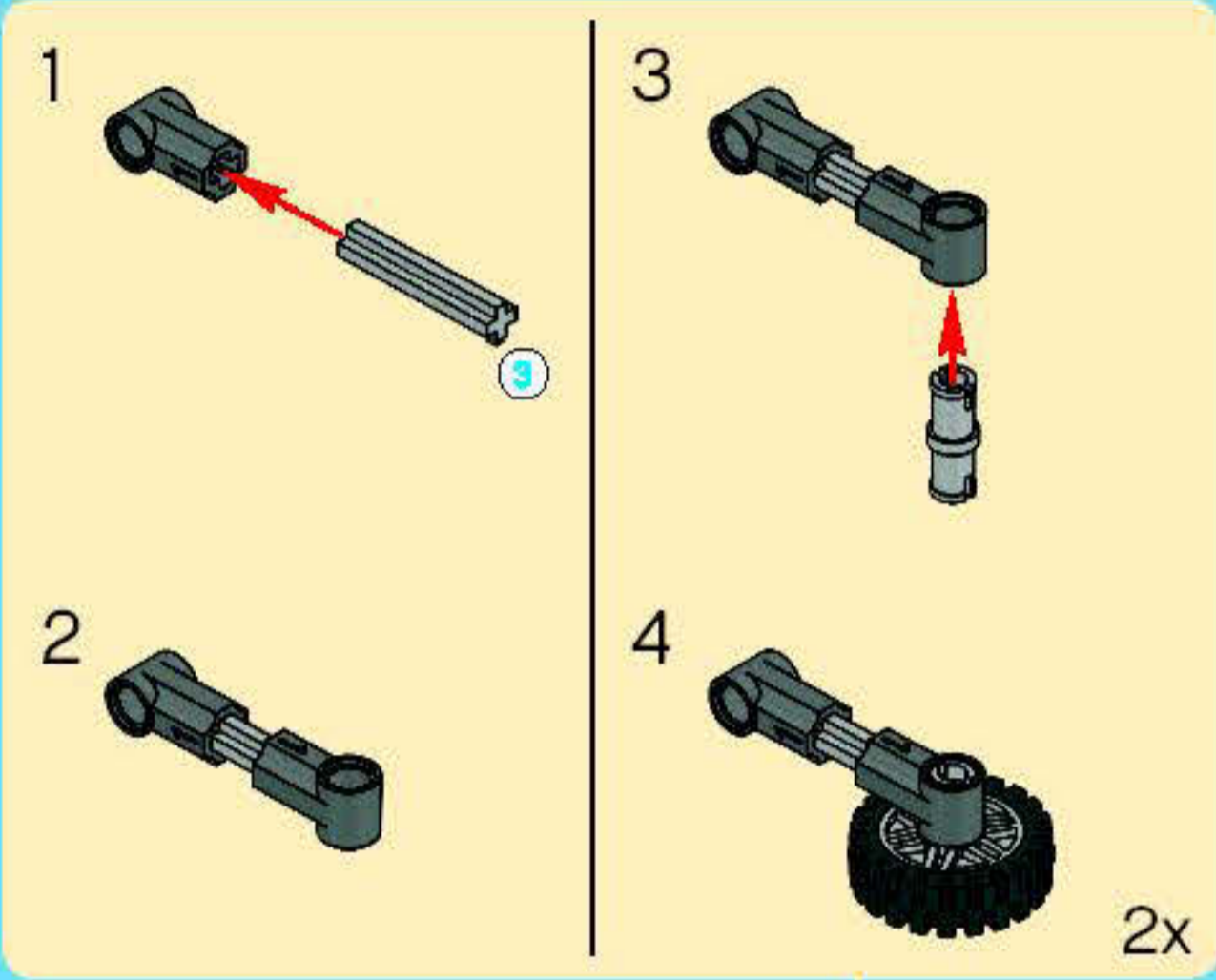

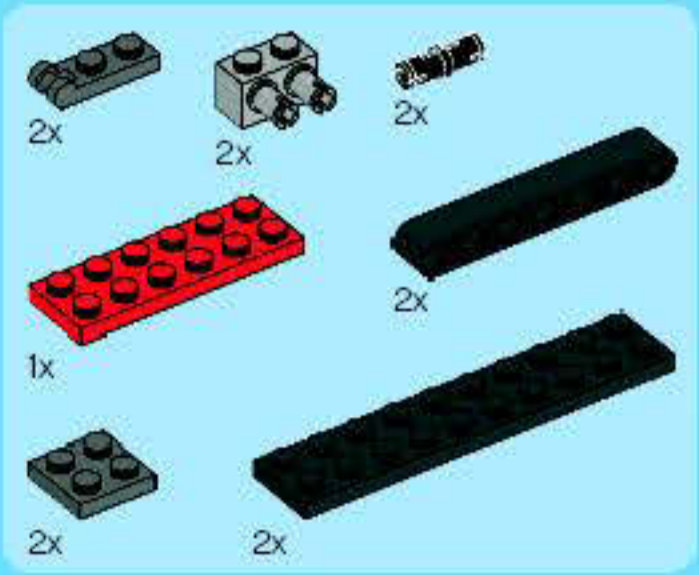
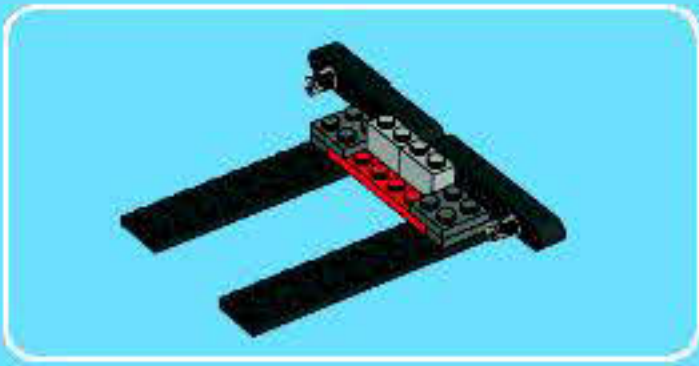

11

1

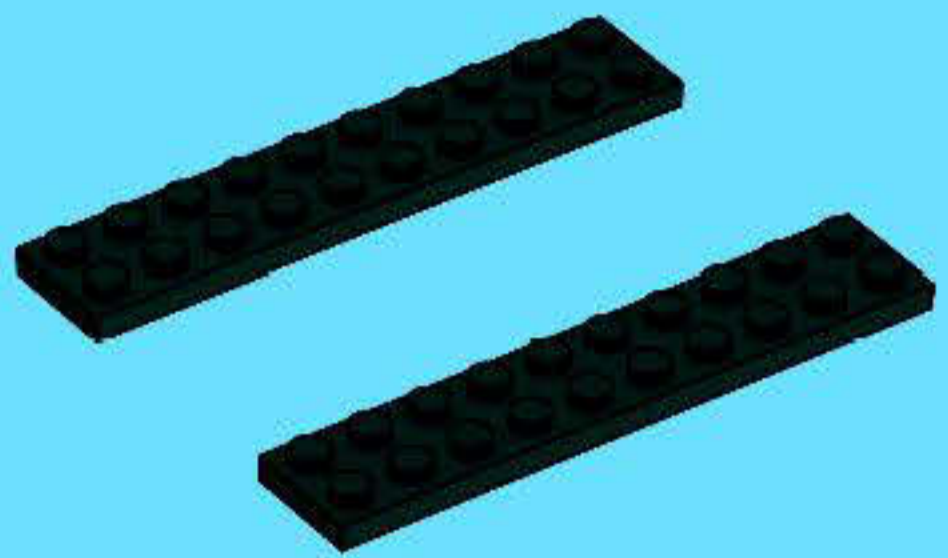

2

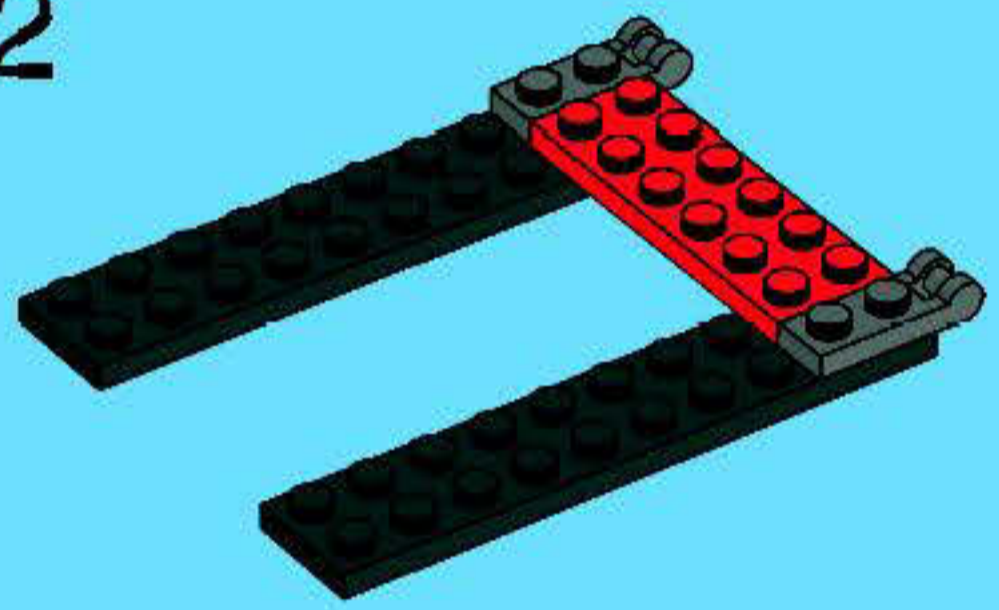

3

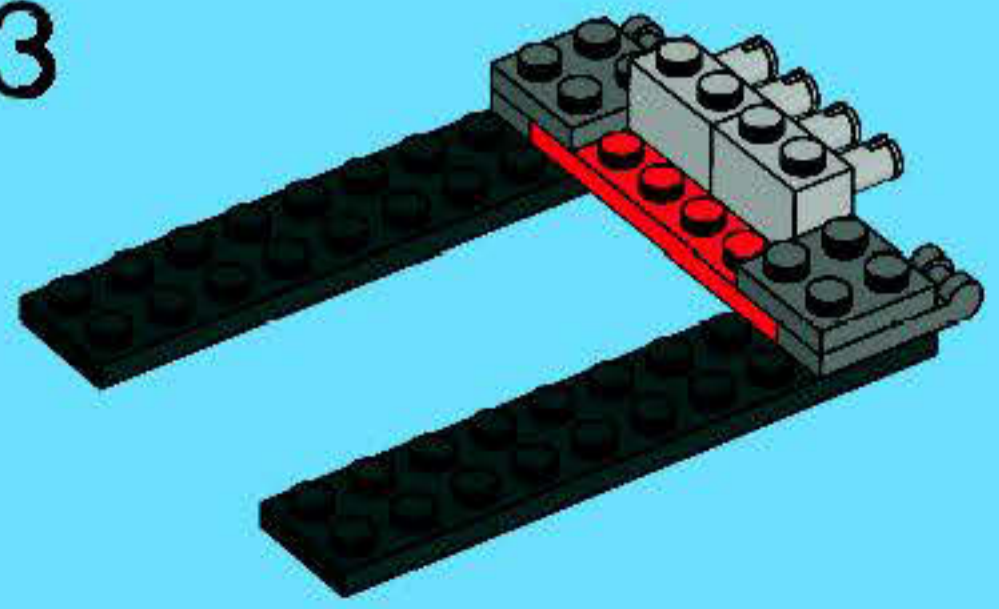

4

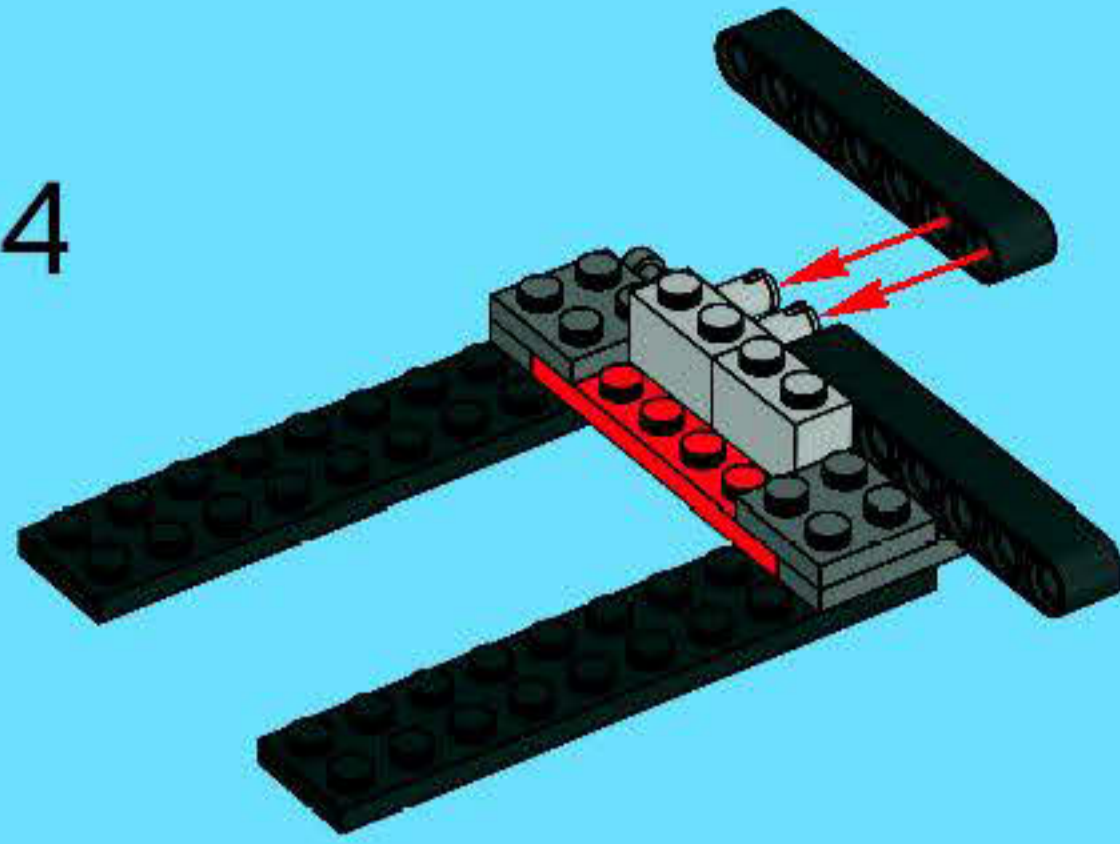

5

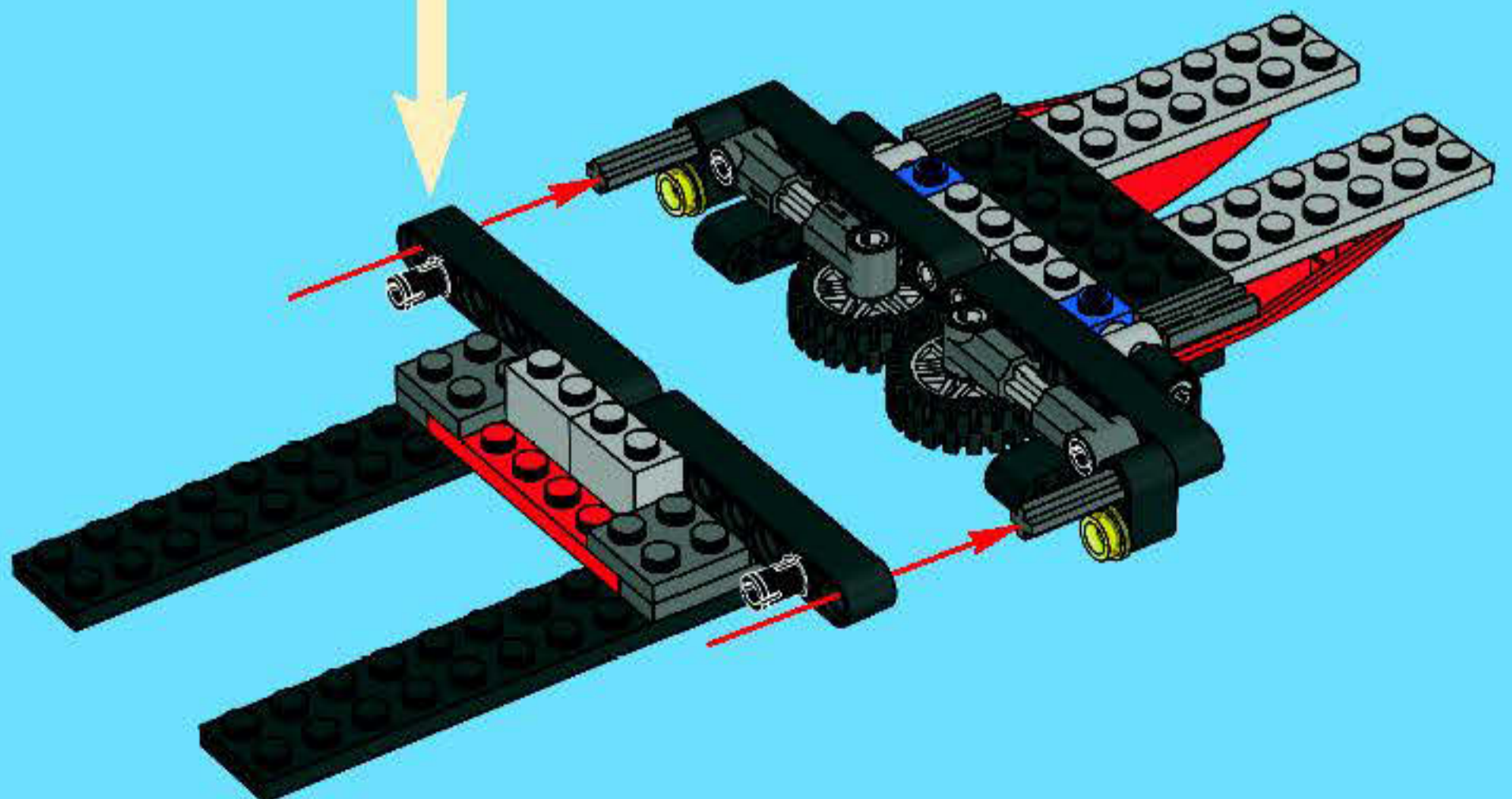
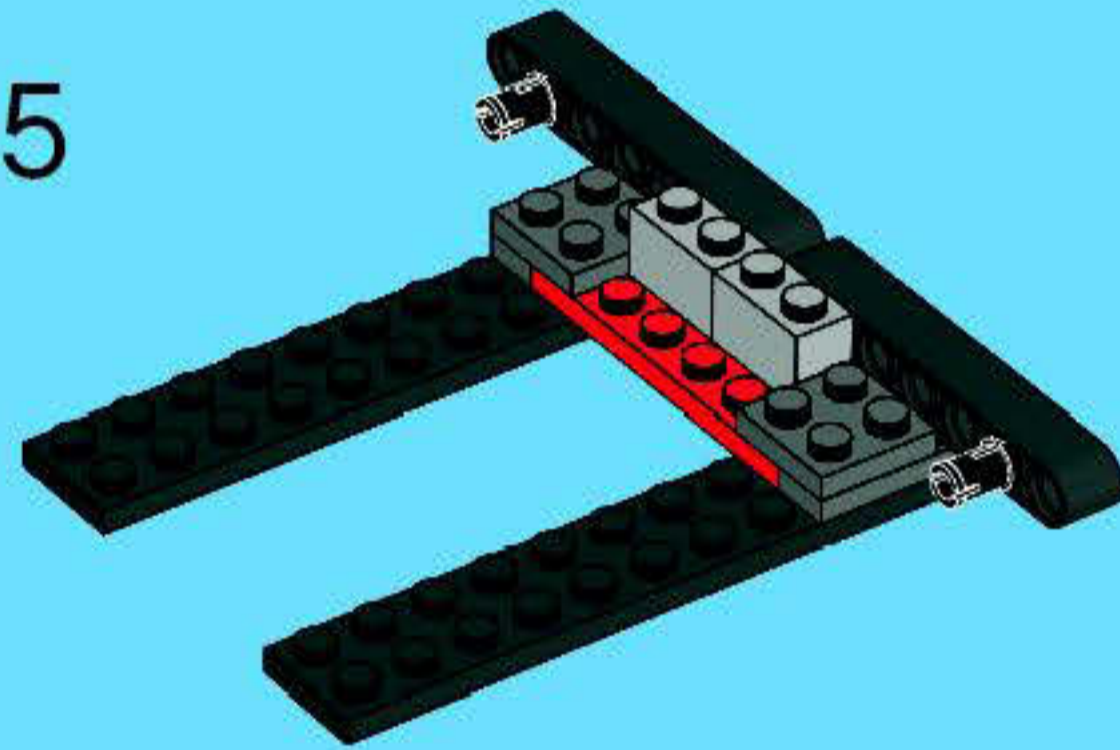



2x

# 12

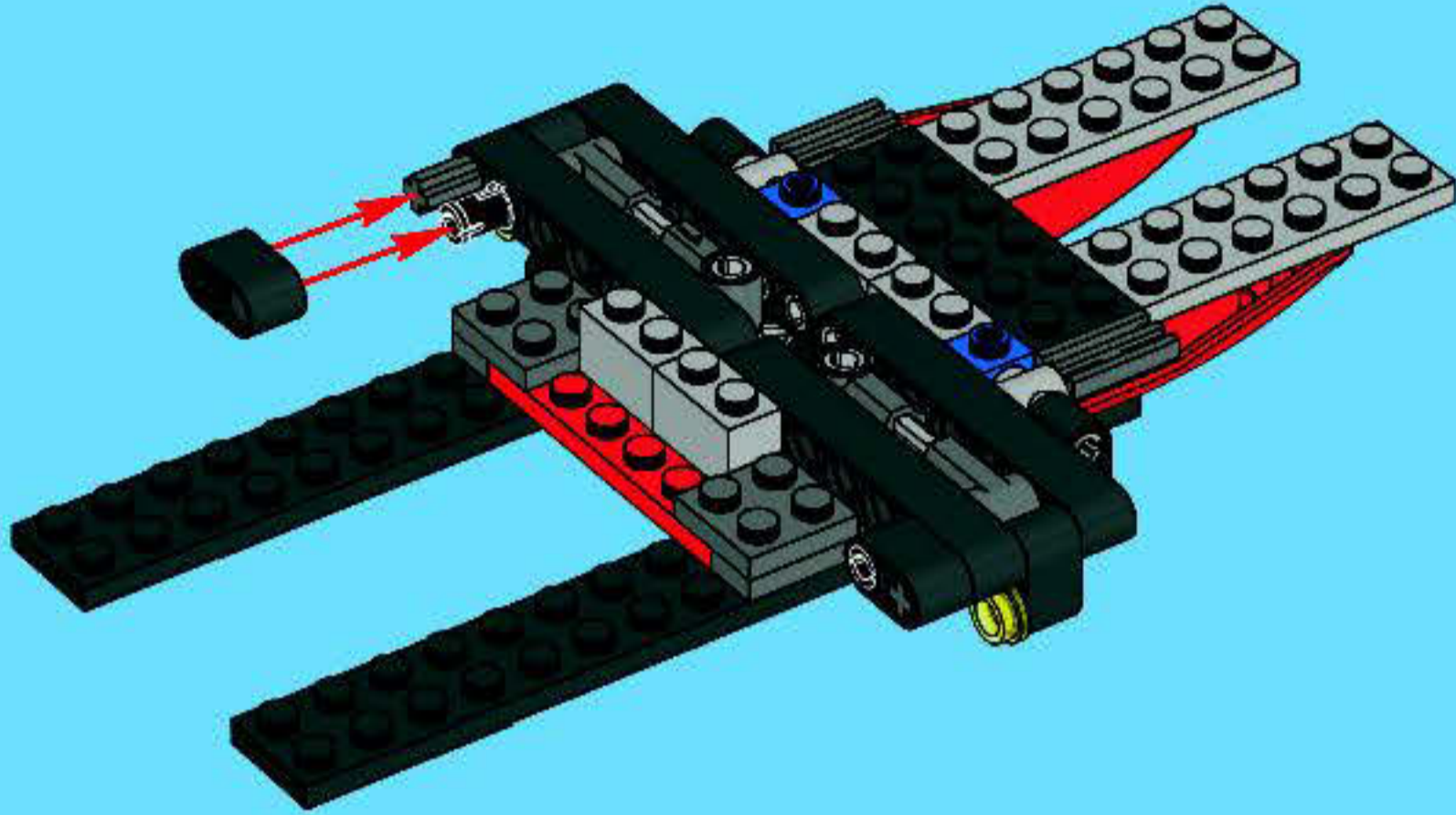

2x



2x



2x

# 13

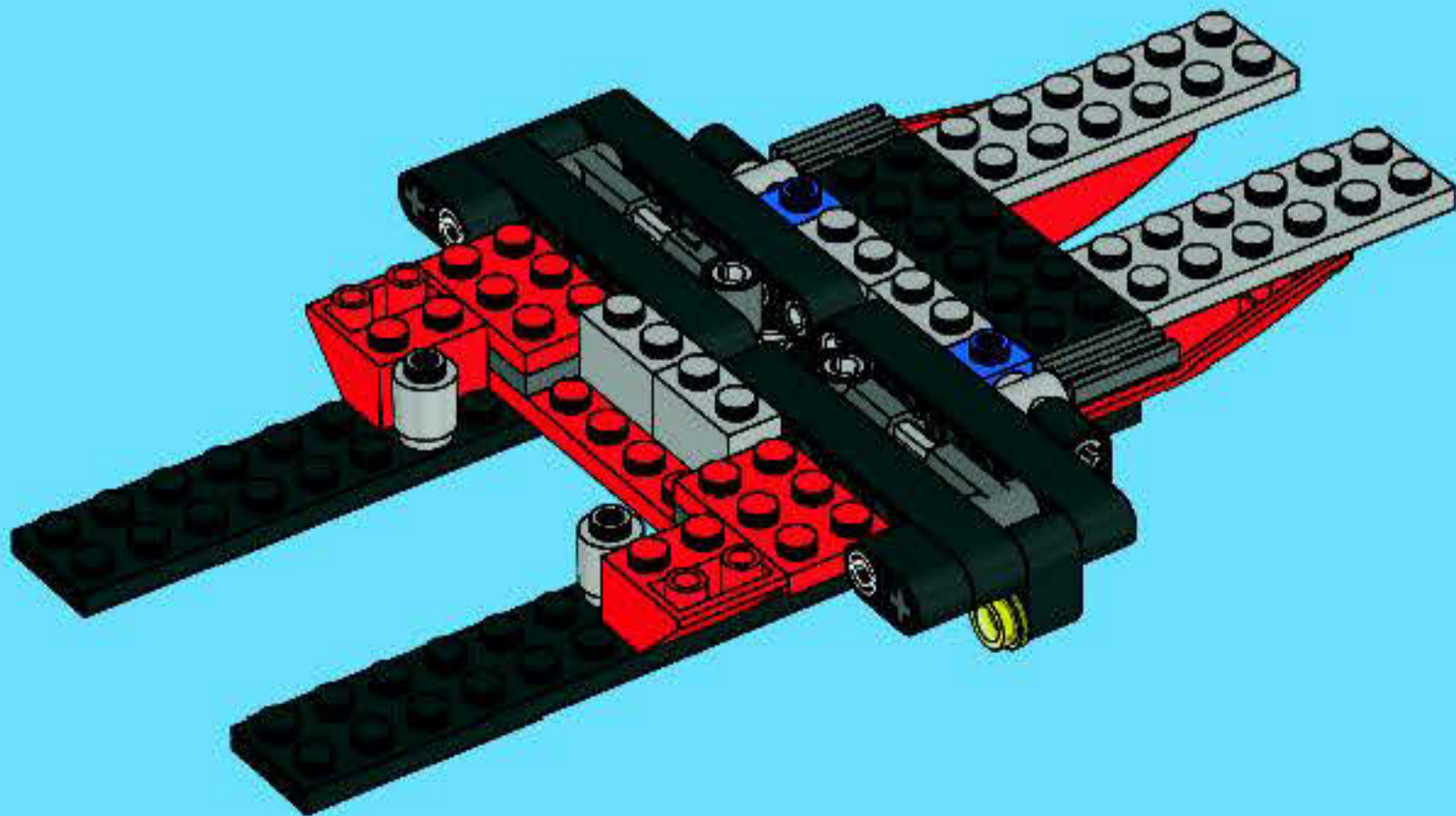



4x

14

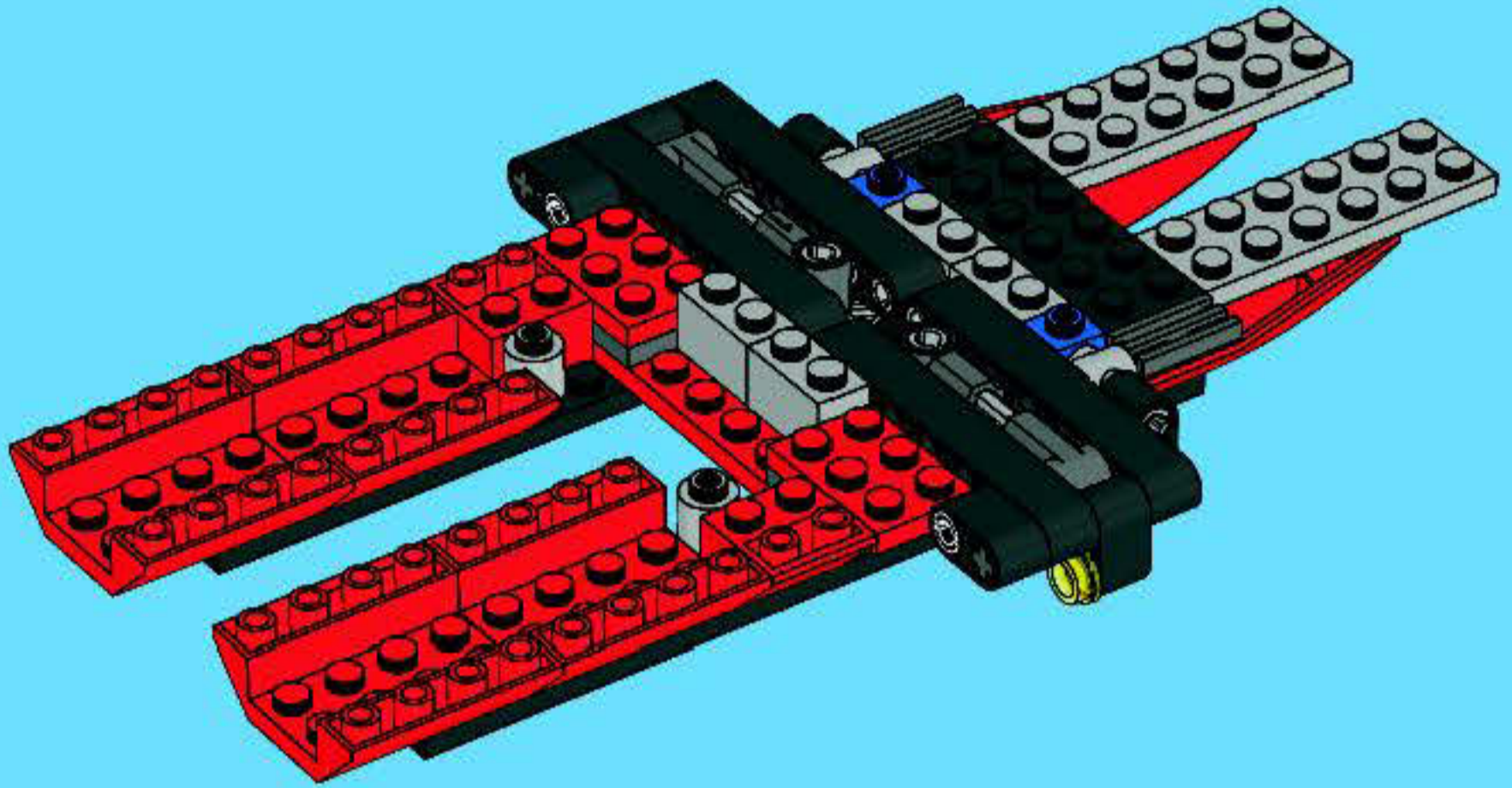

2x



15

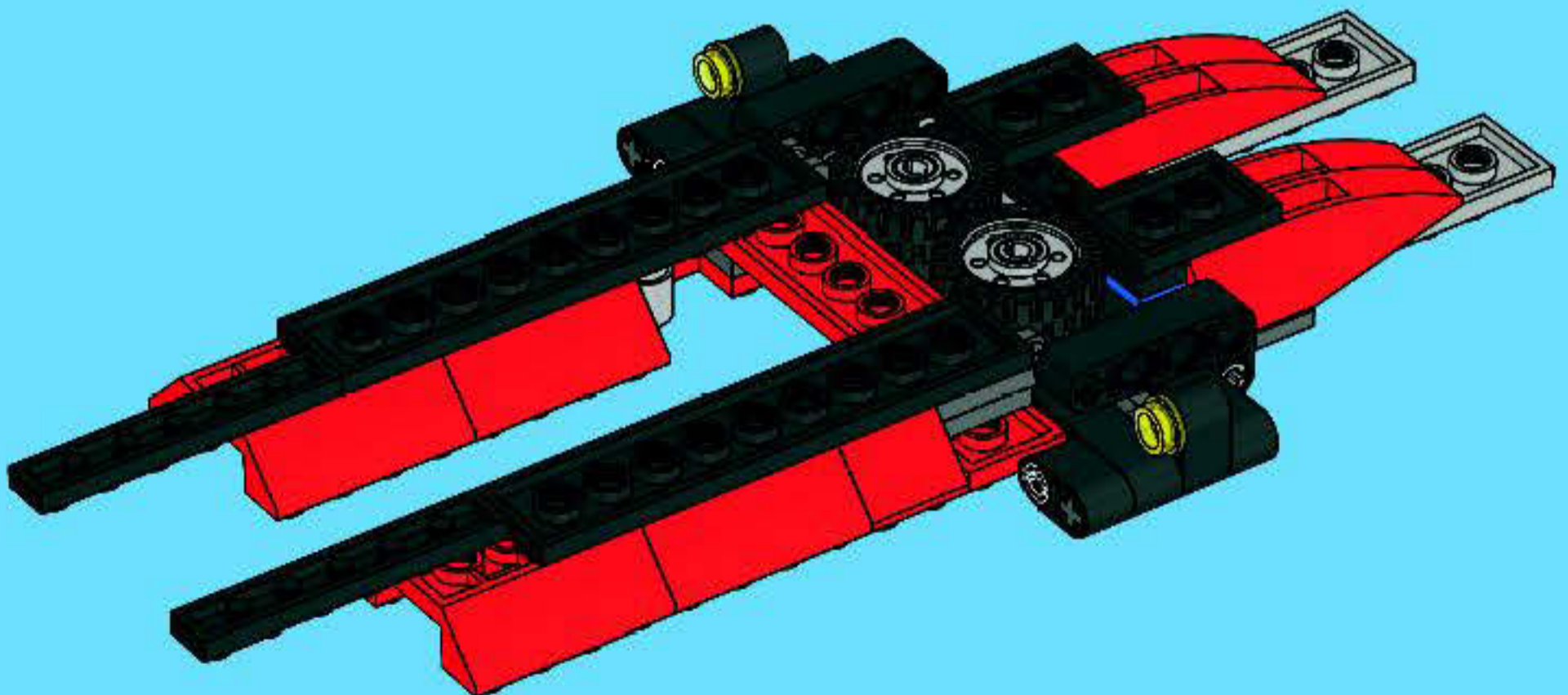

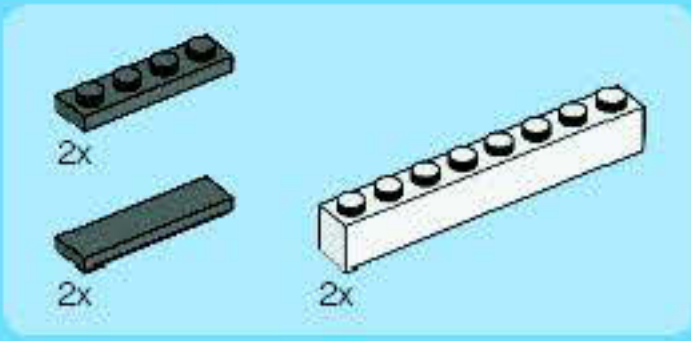

16

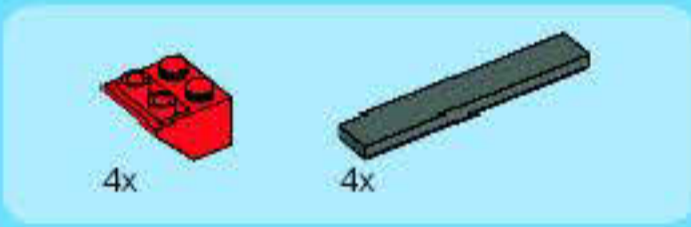
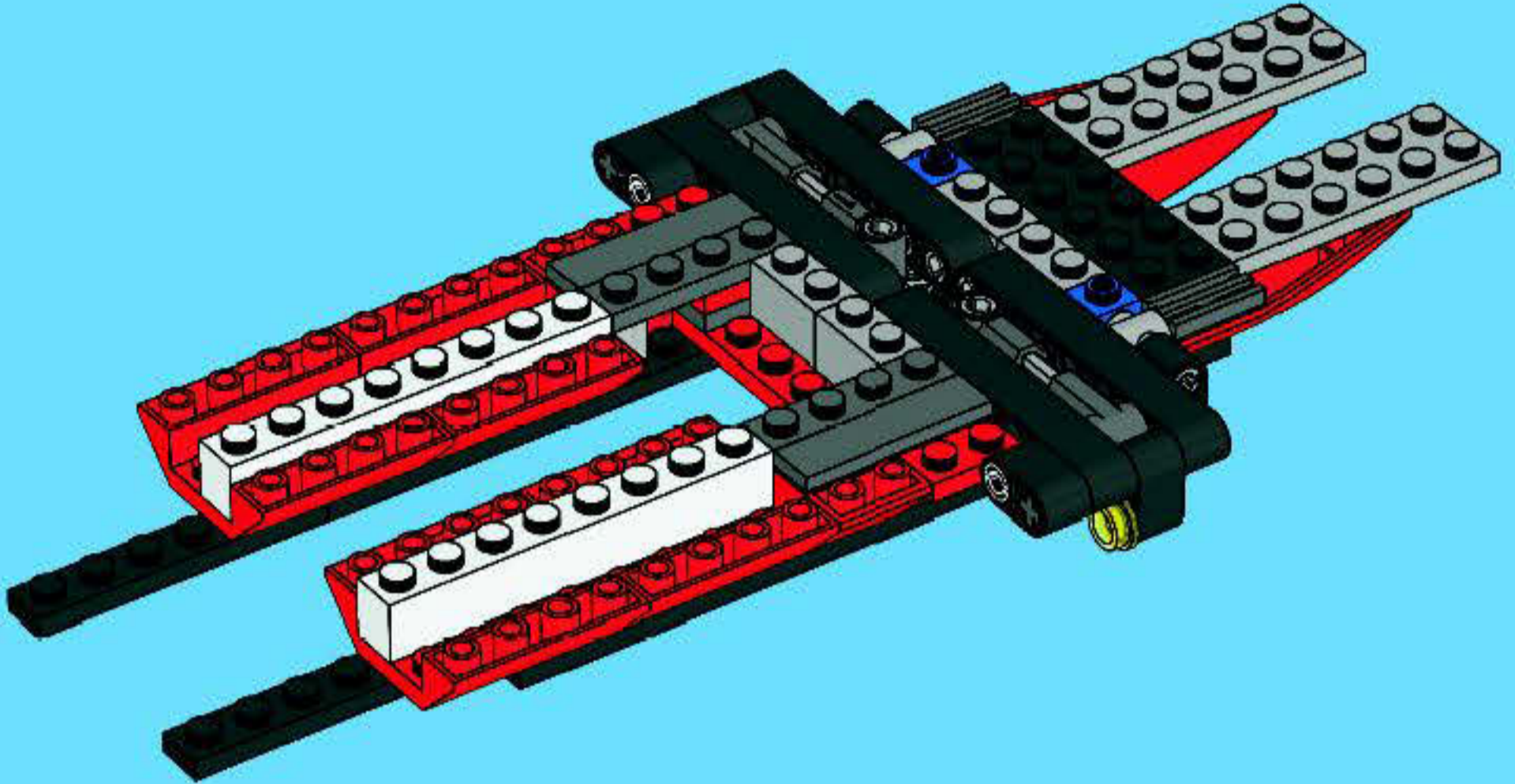

17

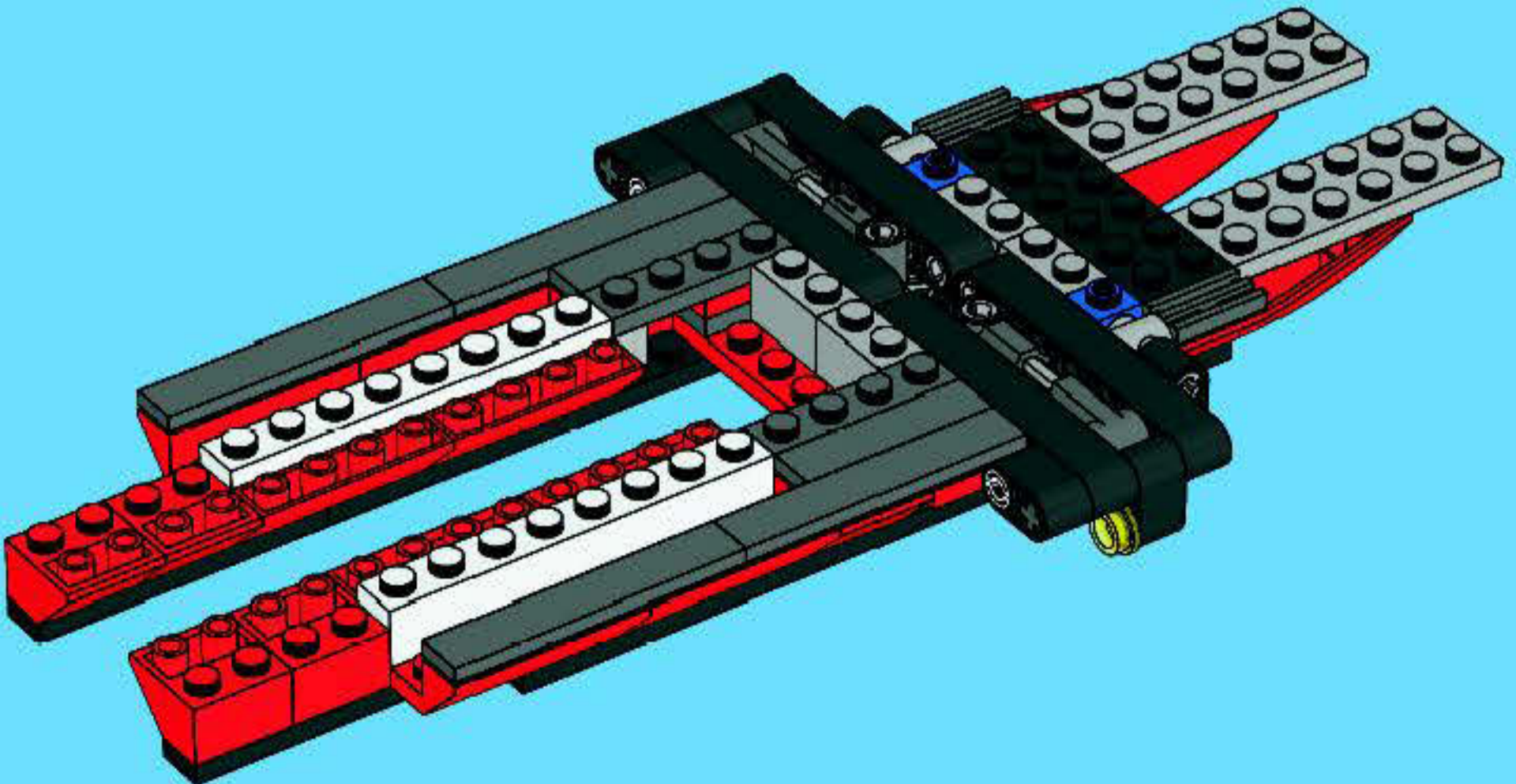

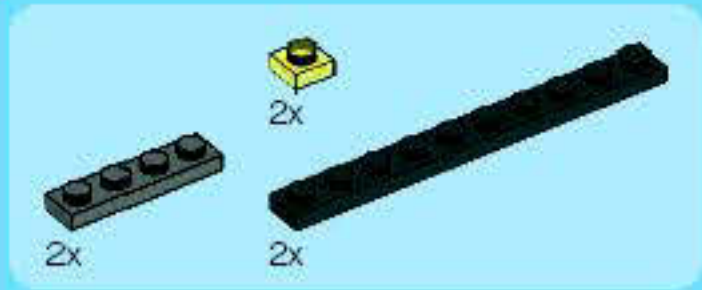

18

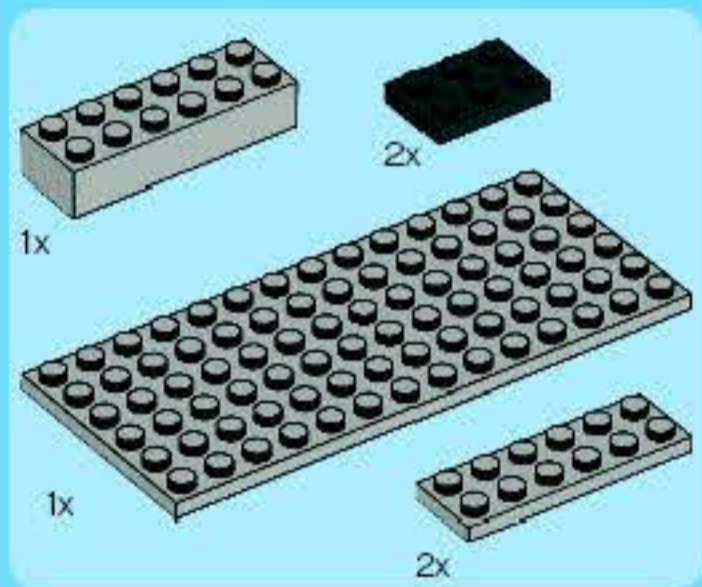
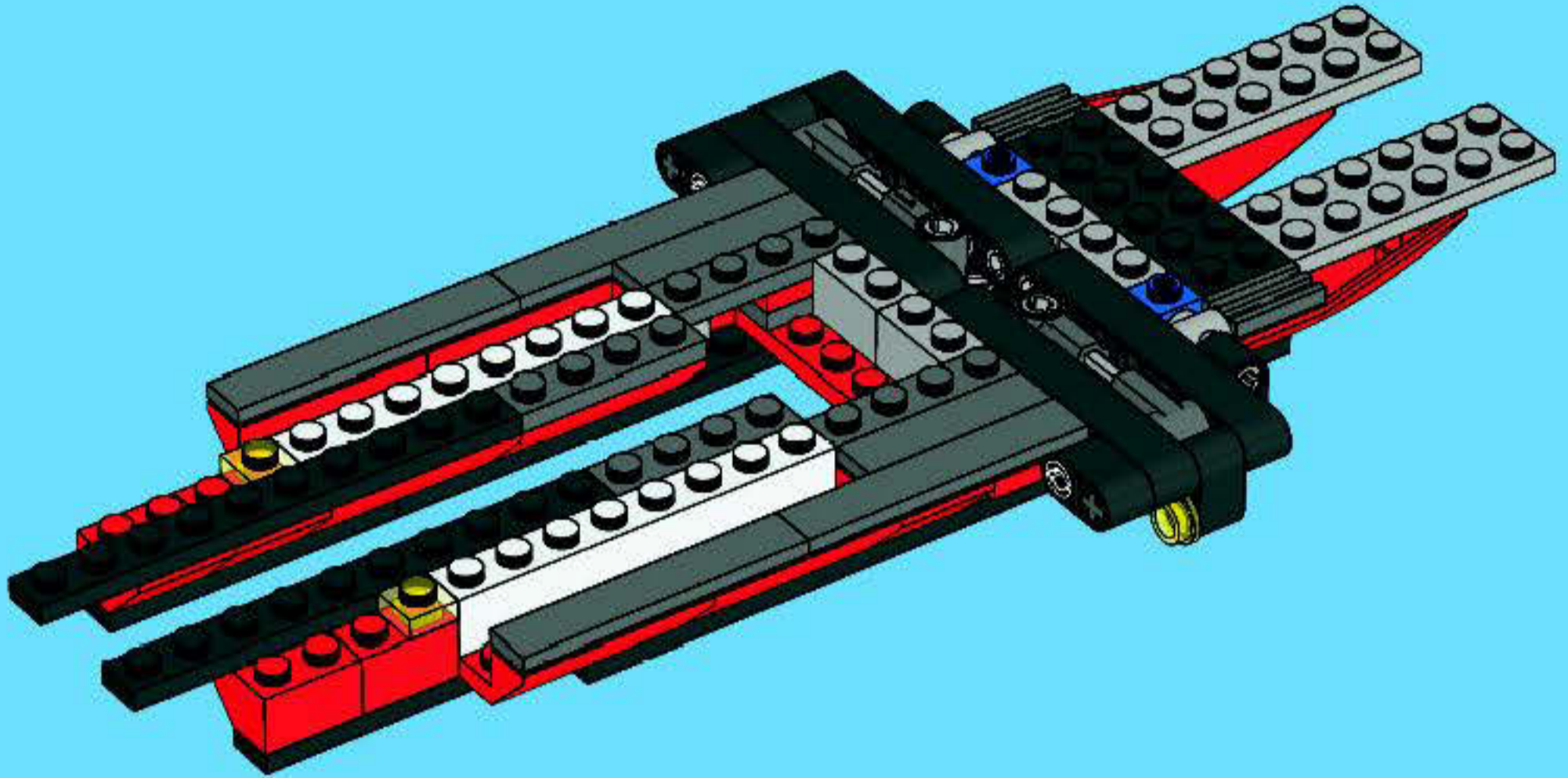

19

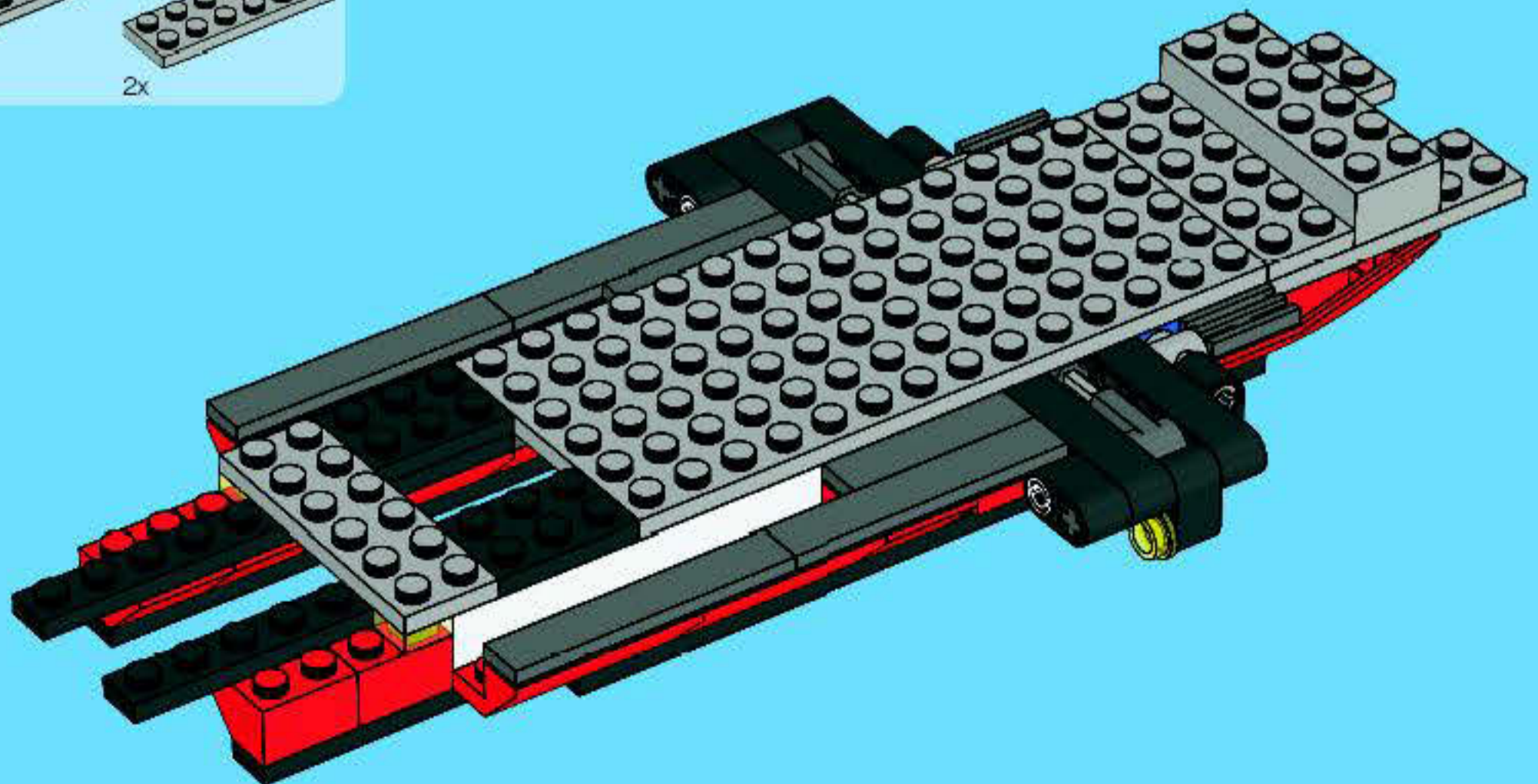





# 20

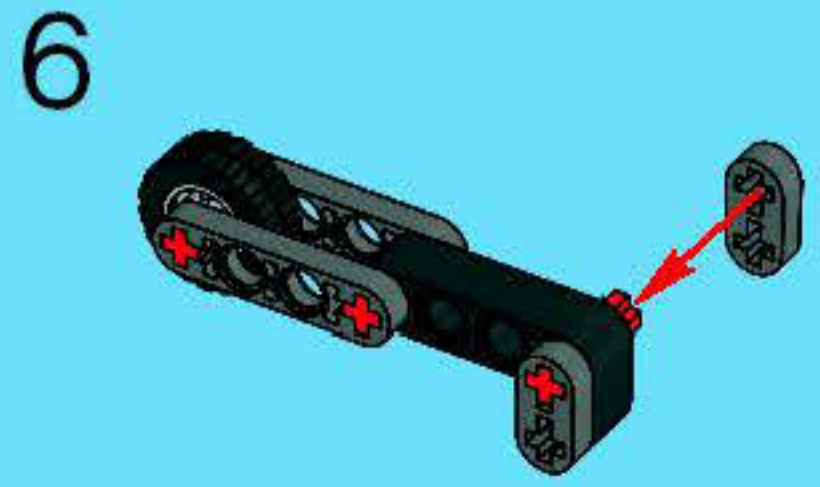
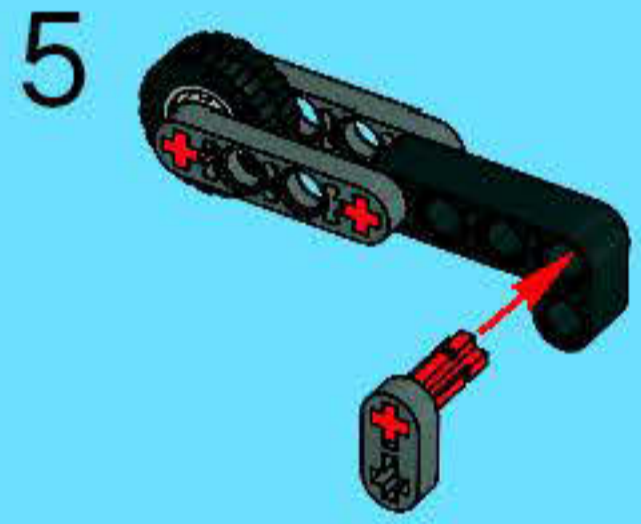
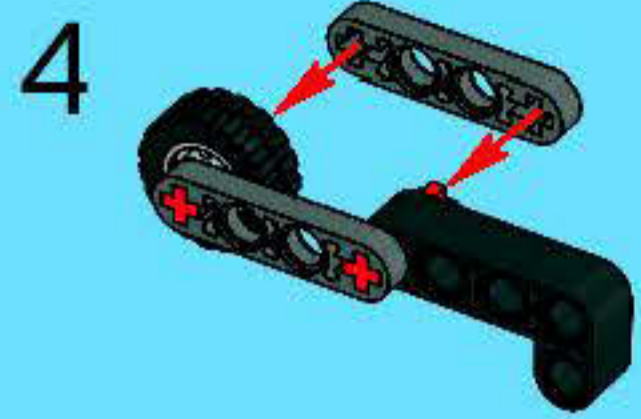
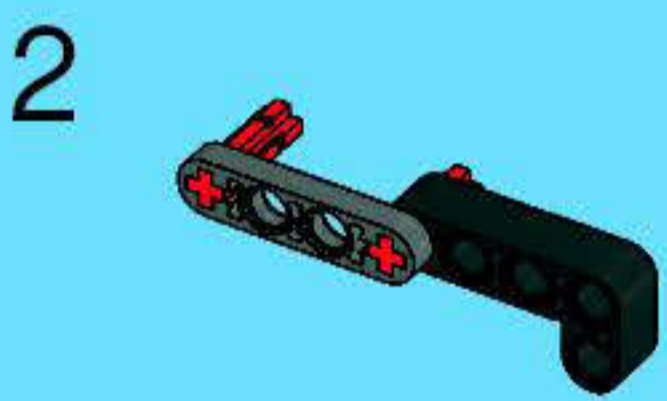

7

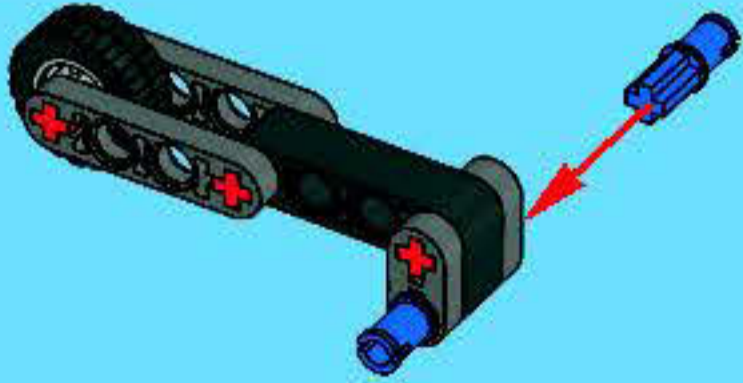

8

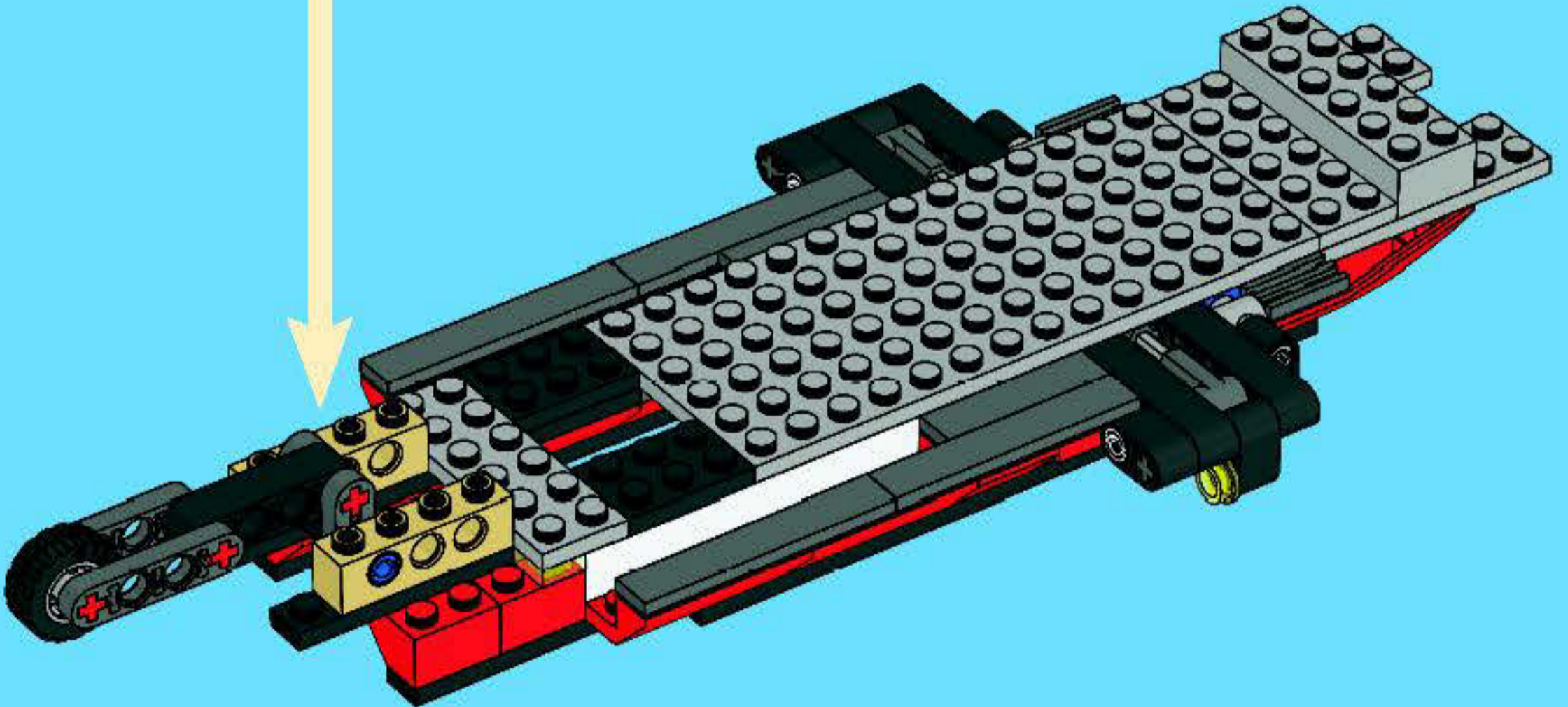
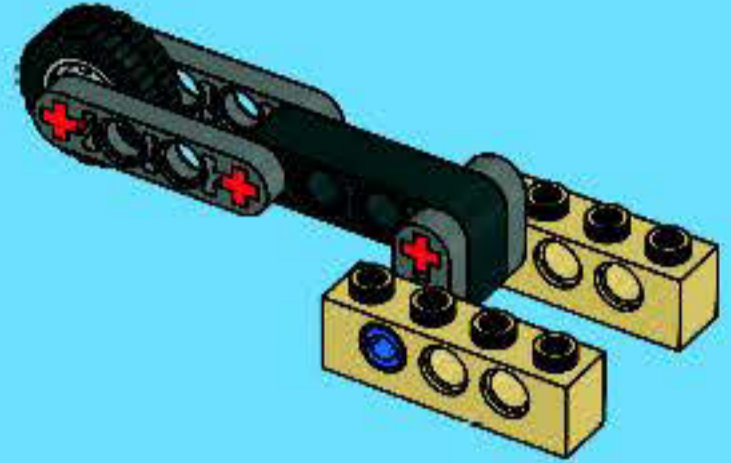

21

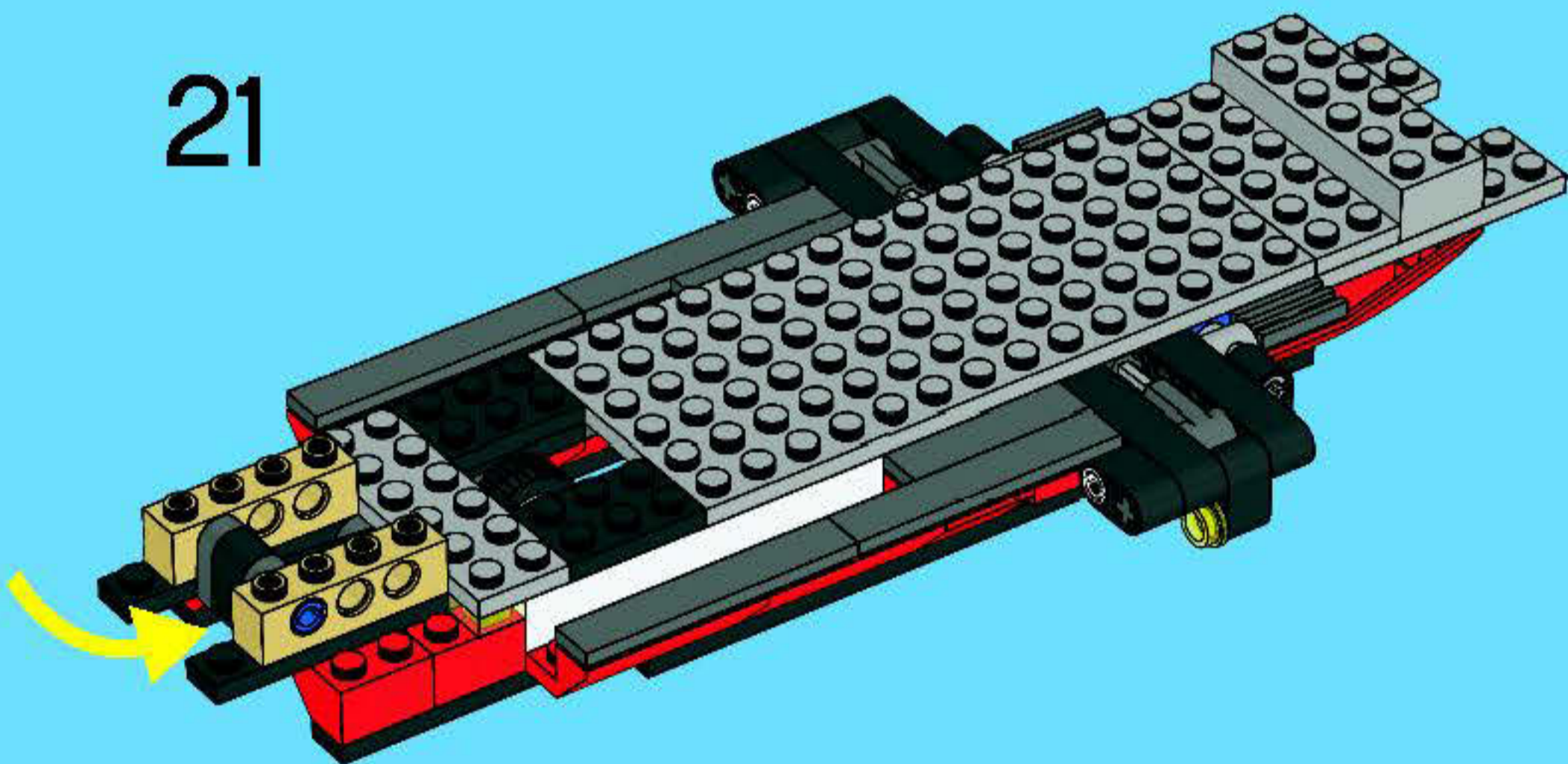

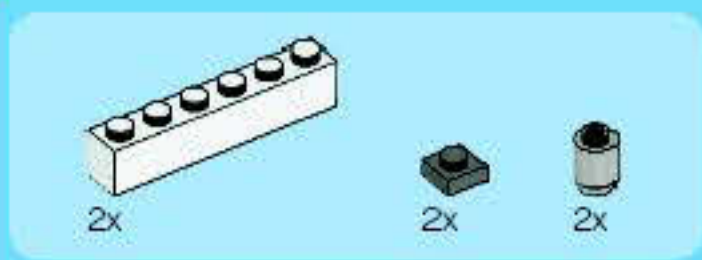

22

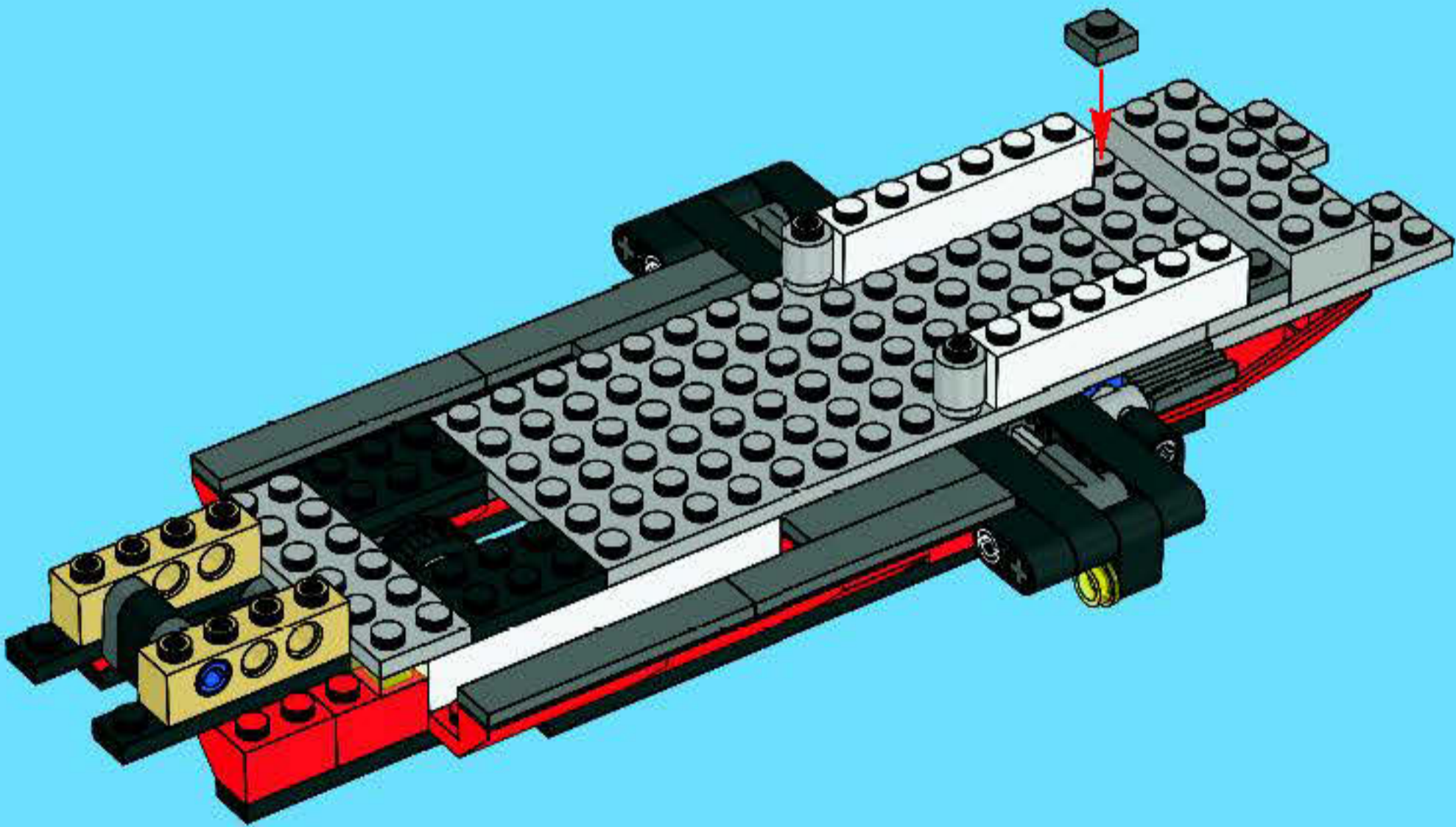

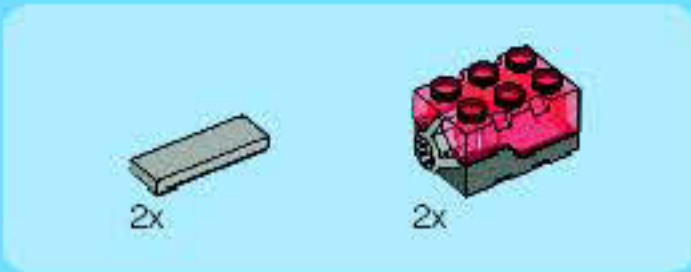

23

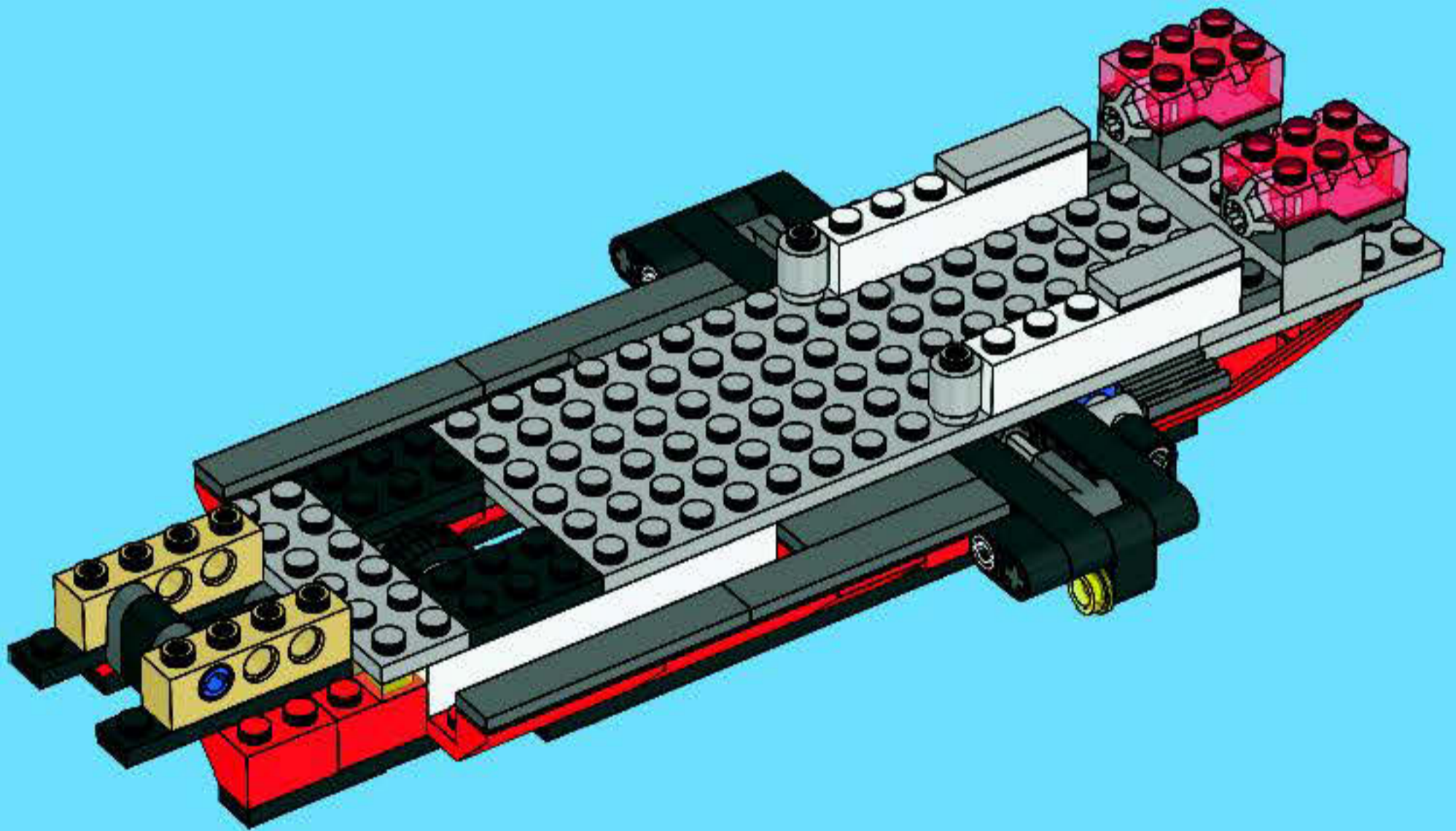



4x



2x

# 24

1

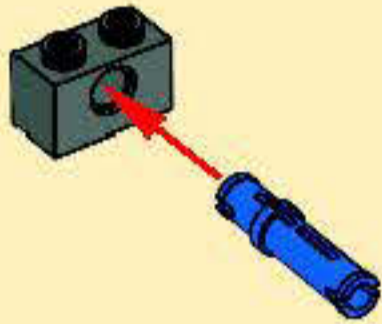

2

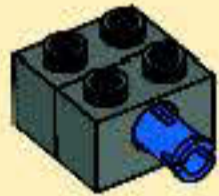

2x

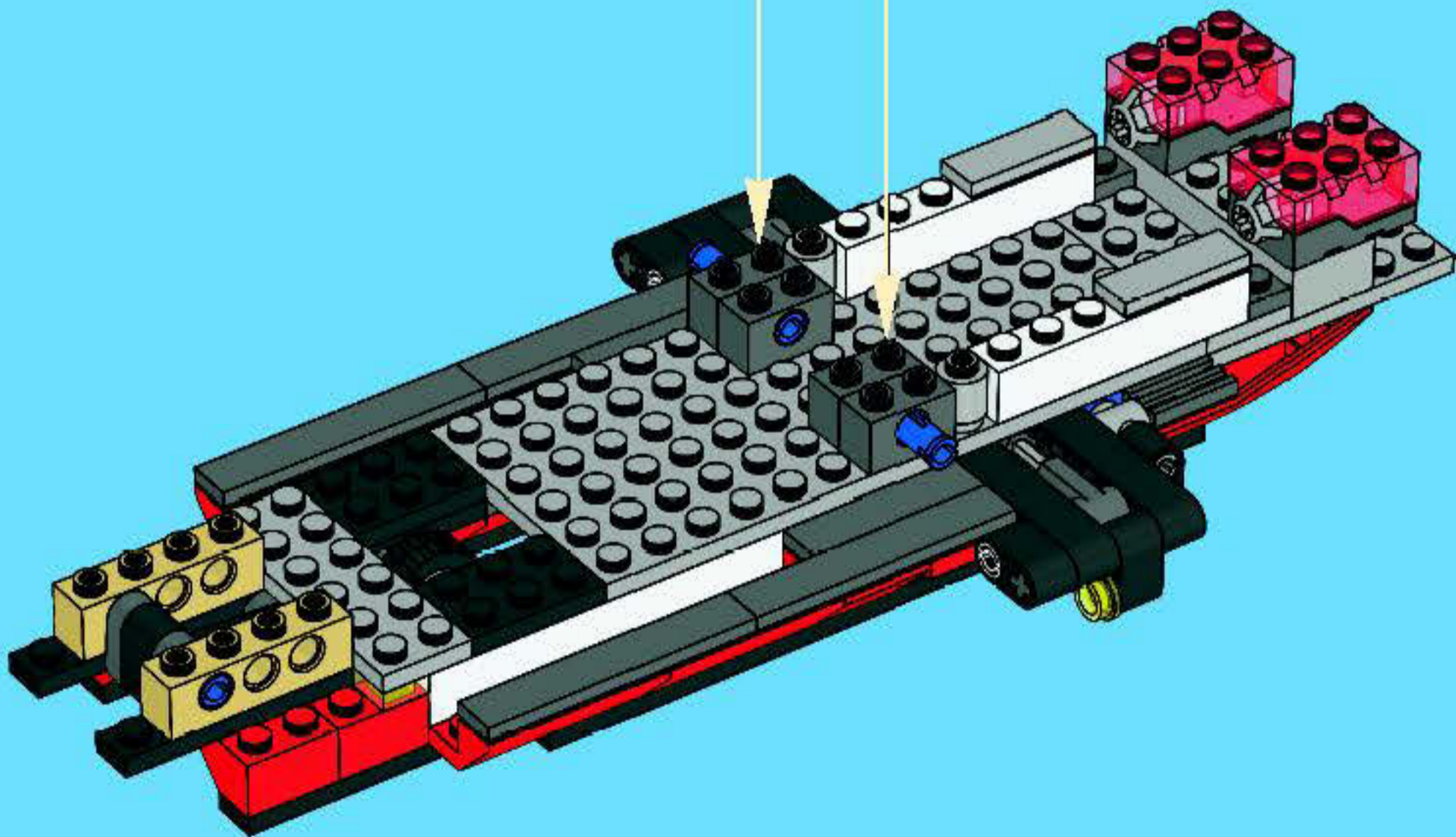

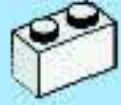

2x

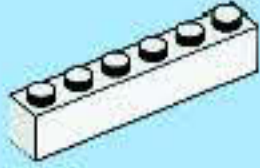

2x

# 25

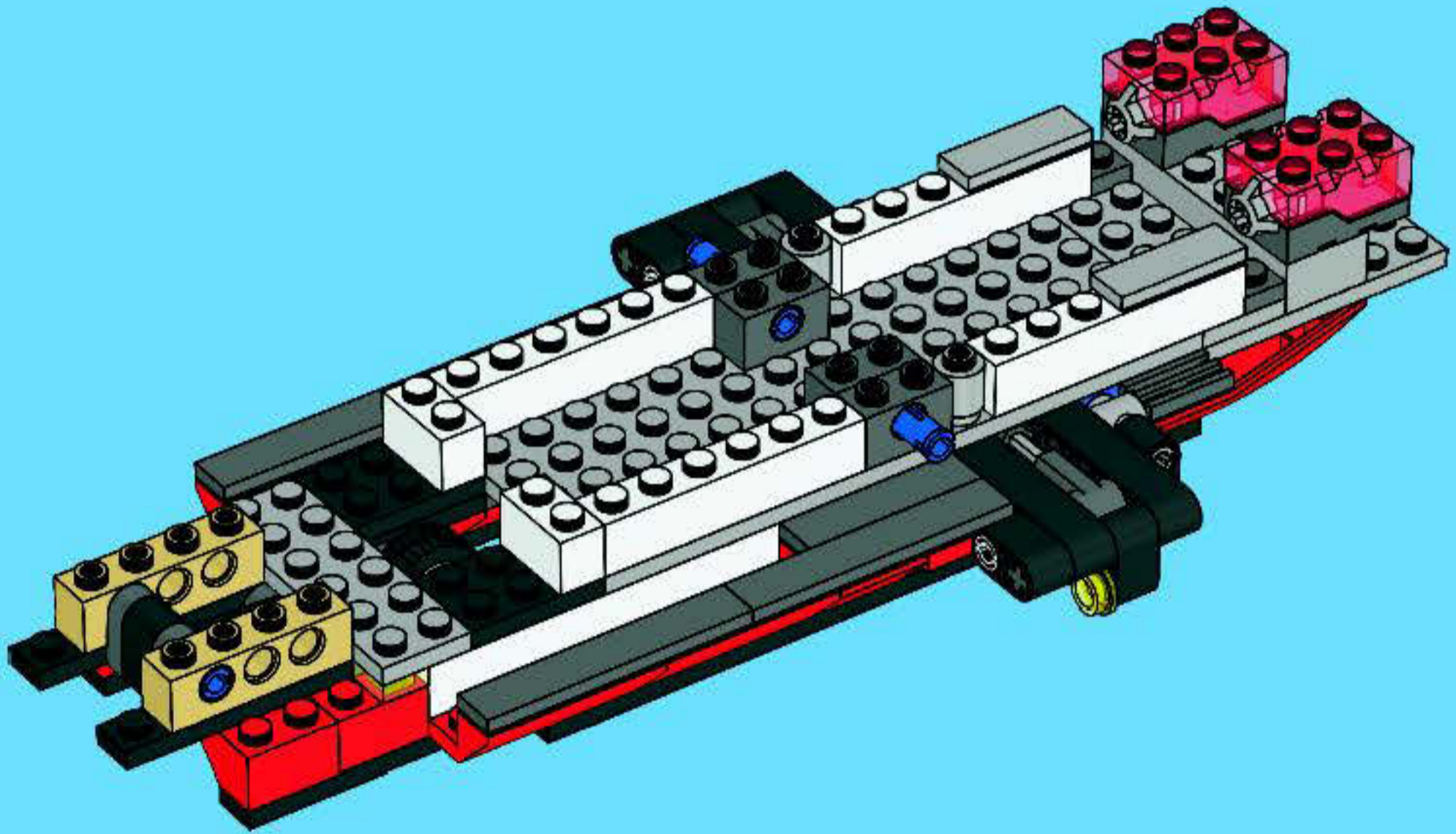

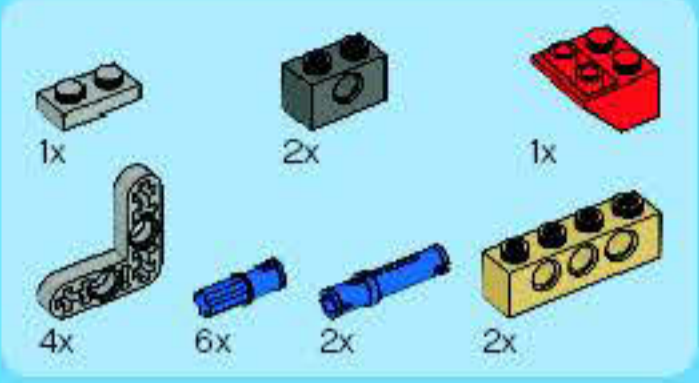
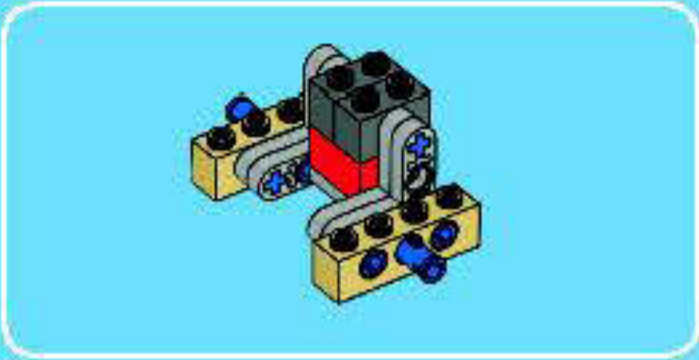

26

1

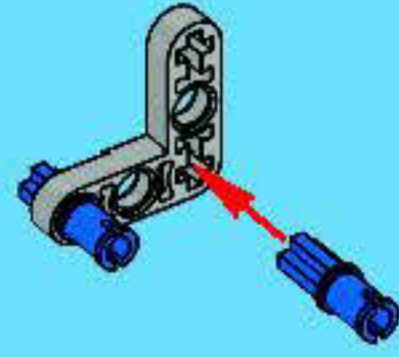

2

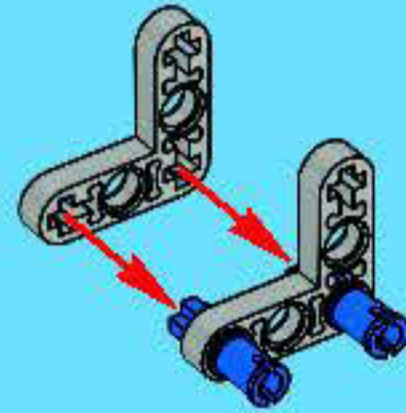

3

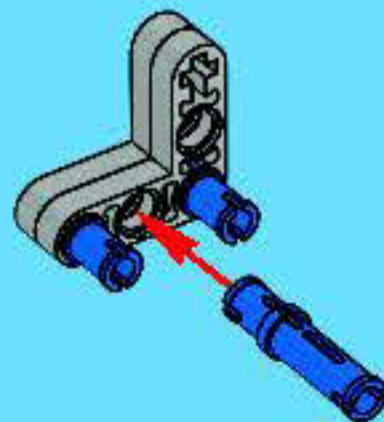



4

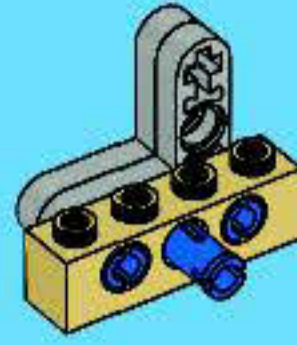

5

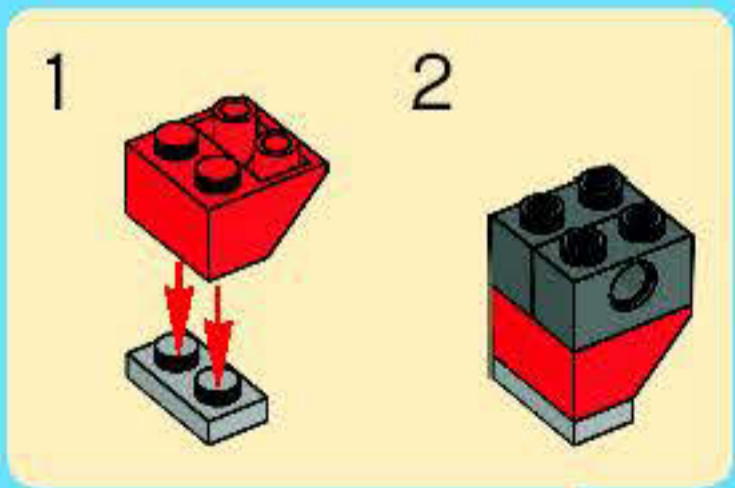
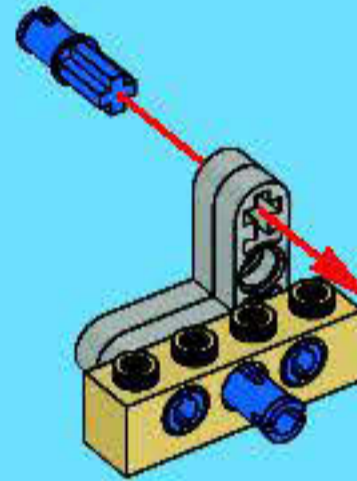

6

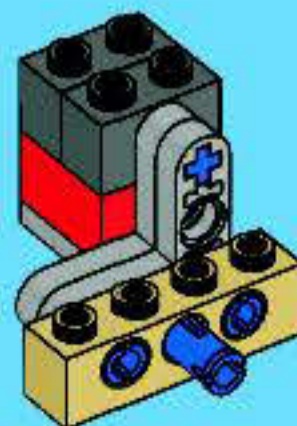

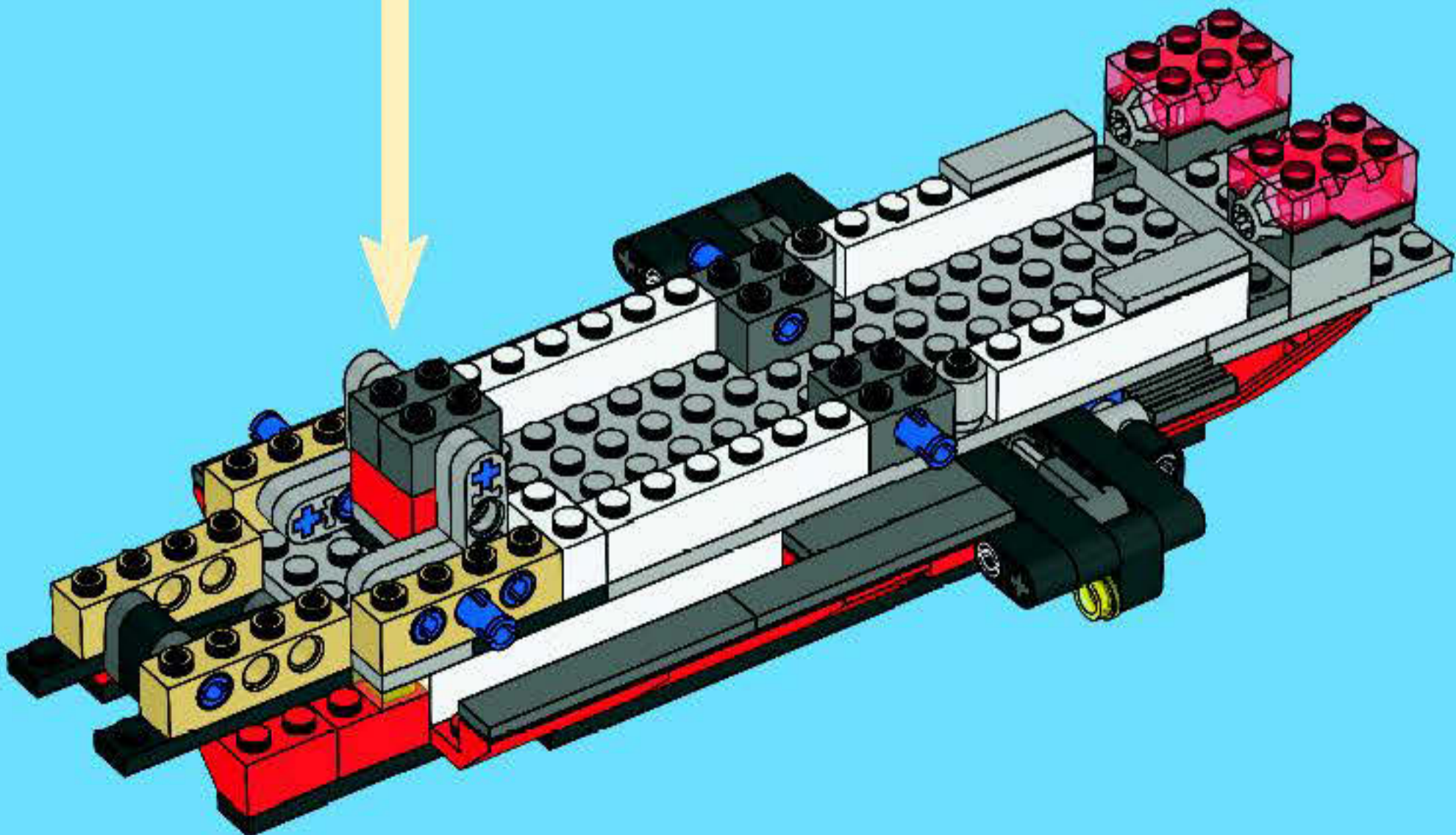
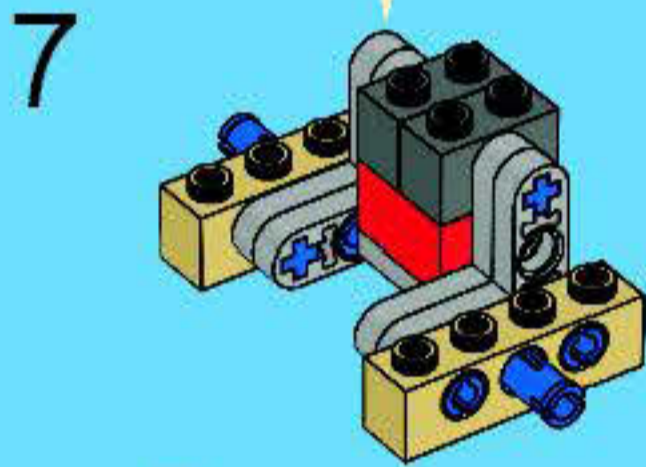
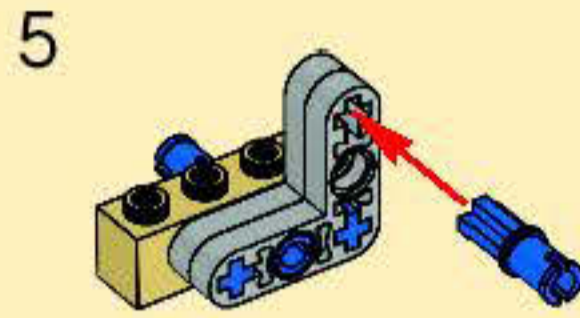
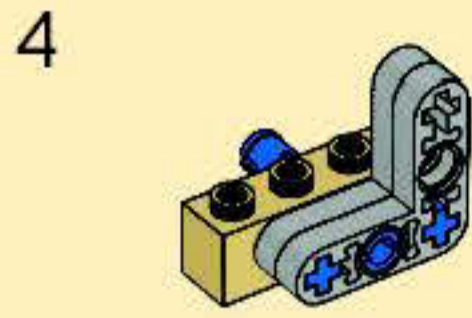
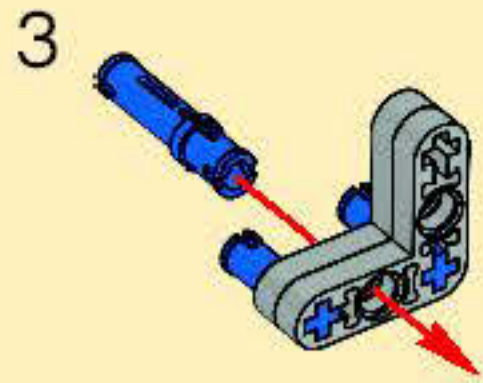
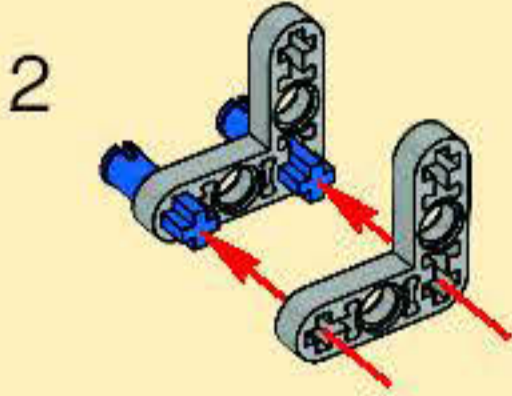
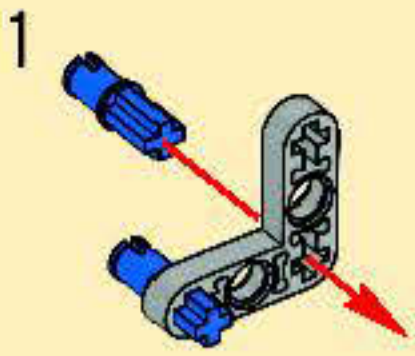



27

1

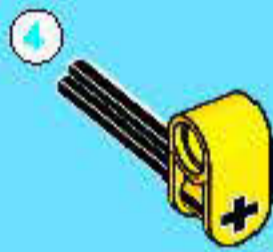

3

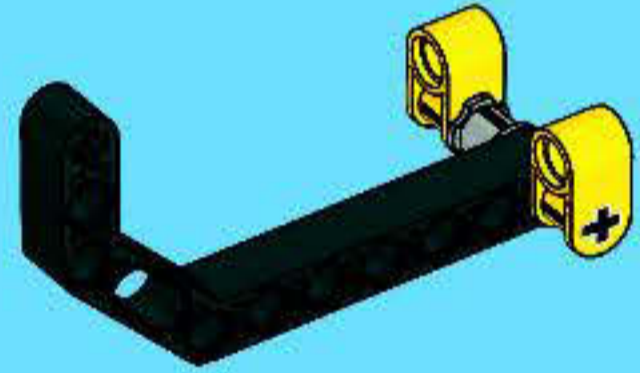

2

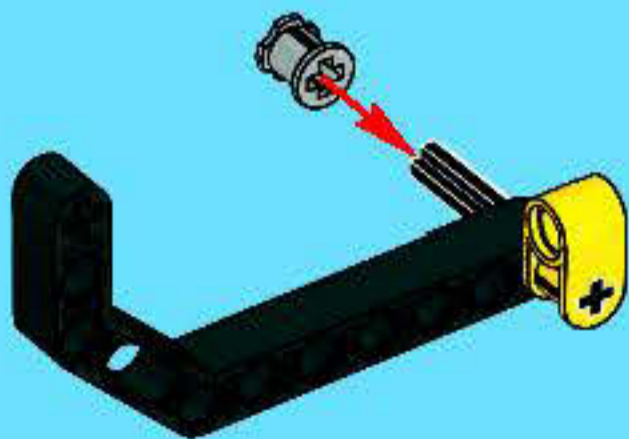

4

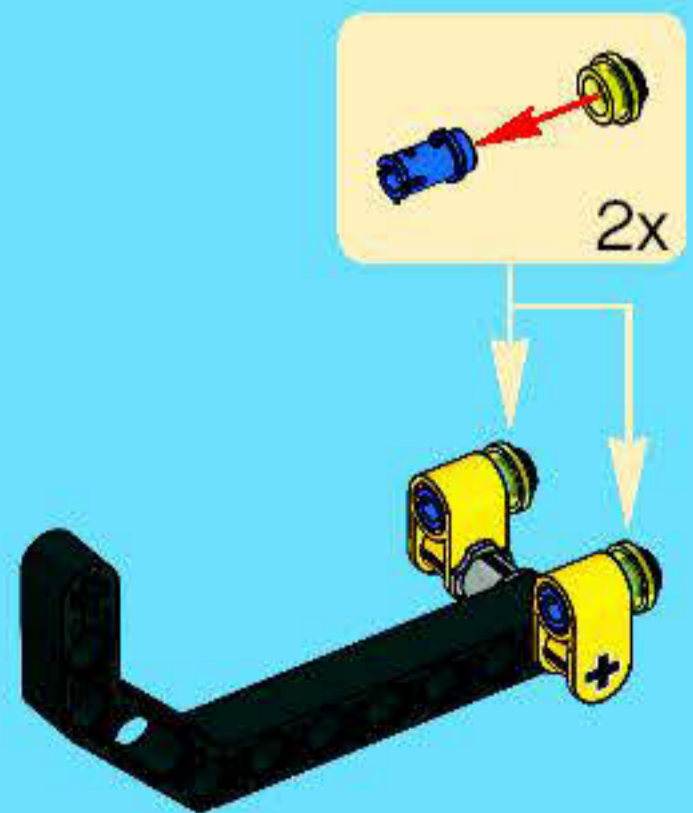

5

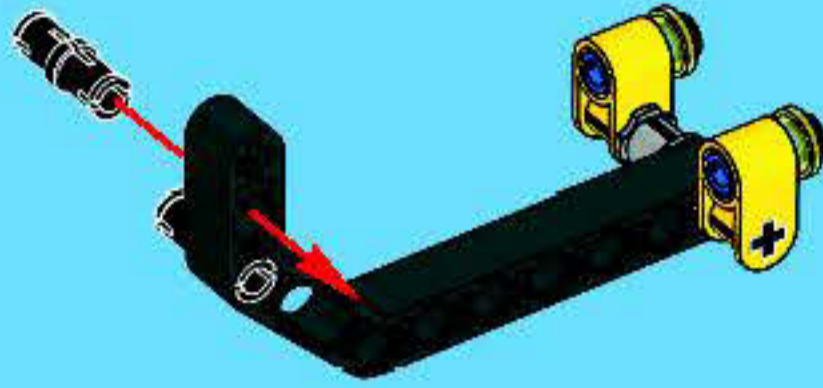

6

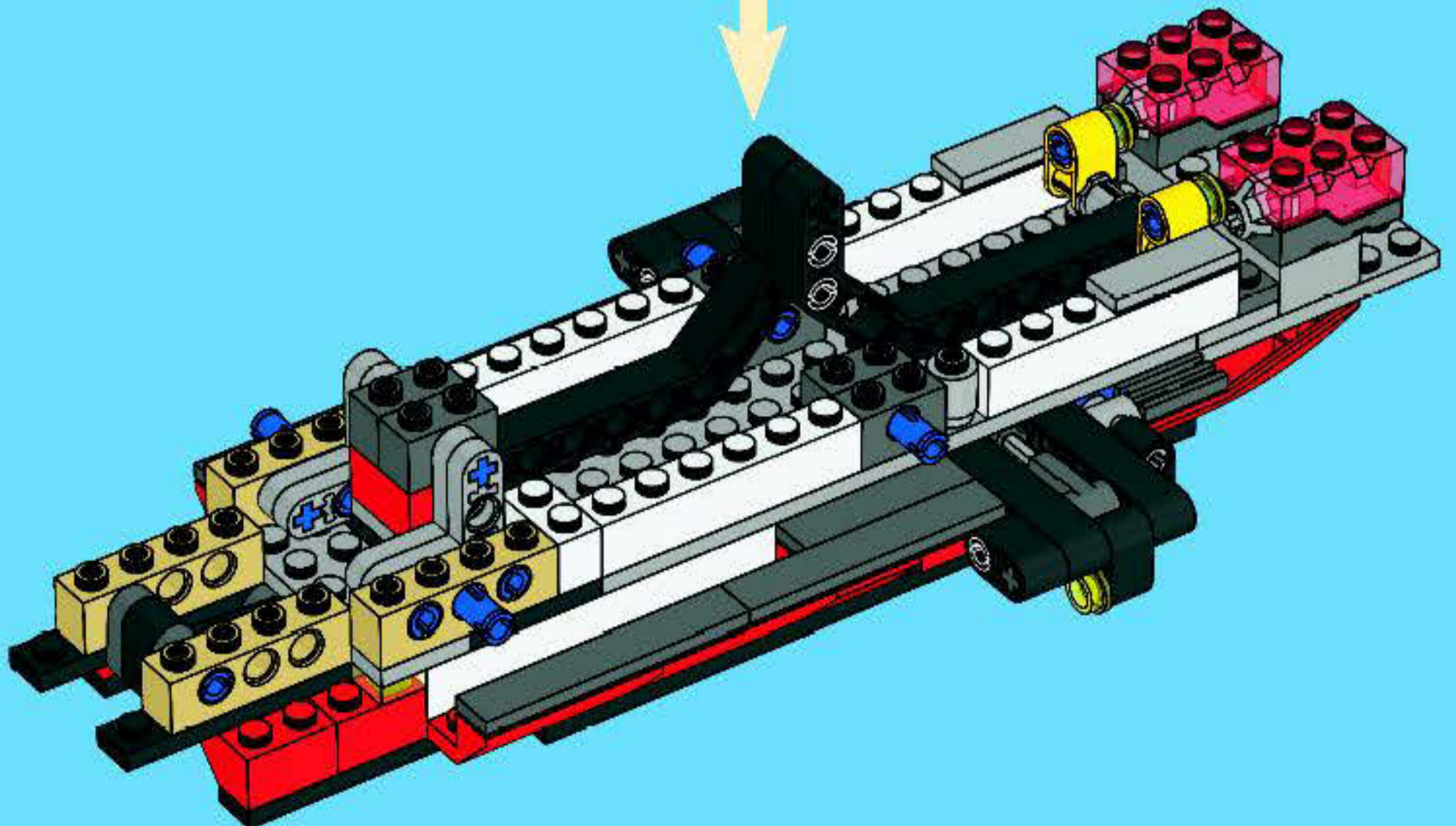

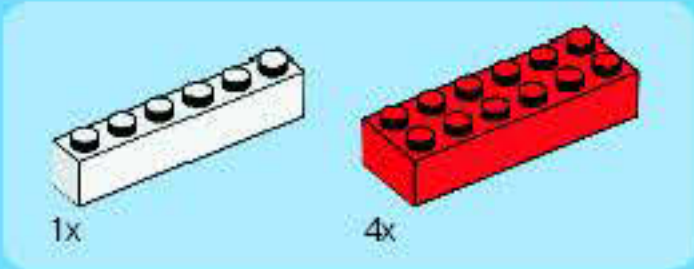

28

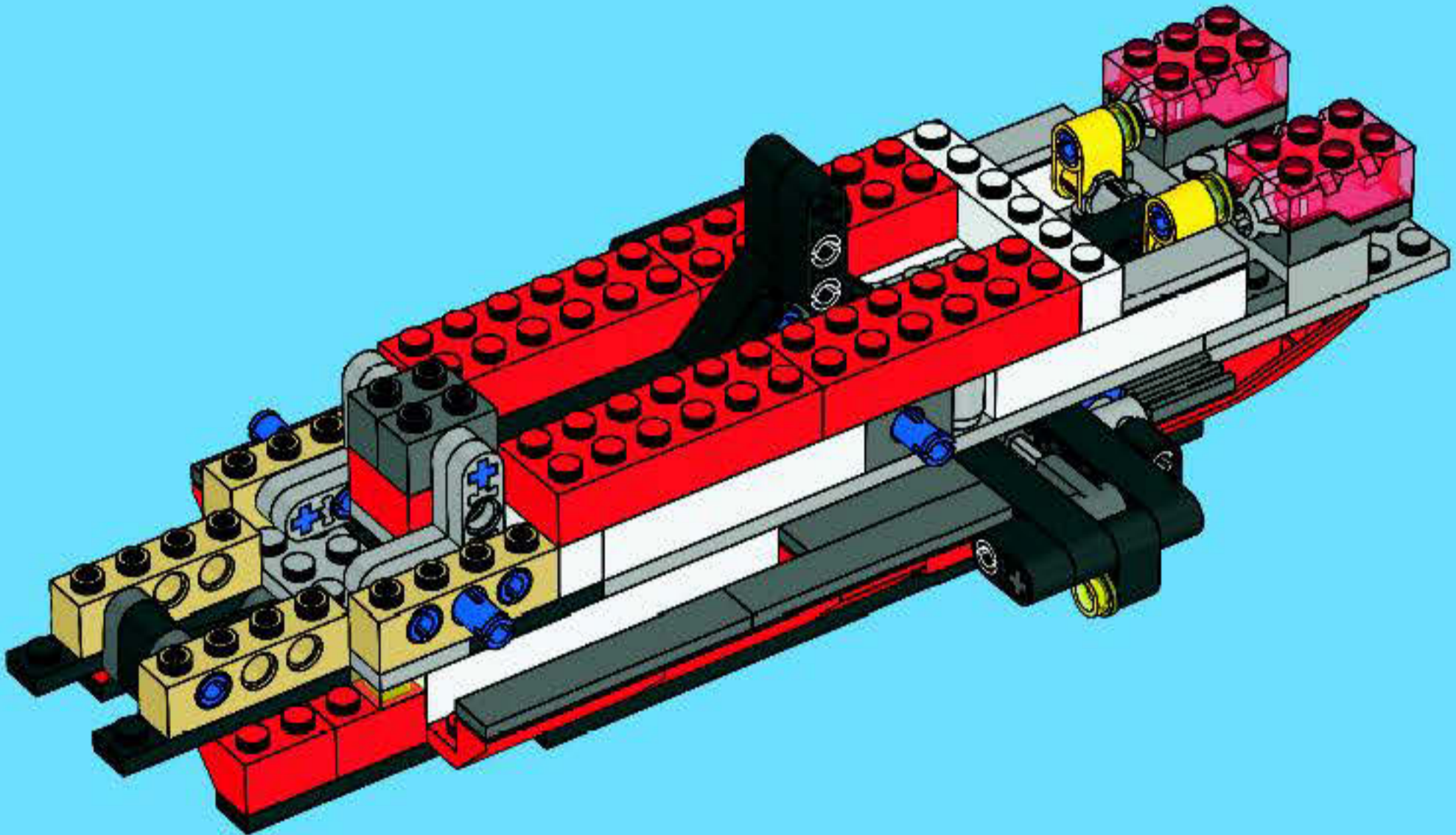



4

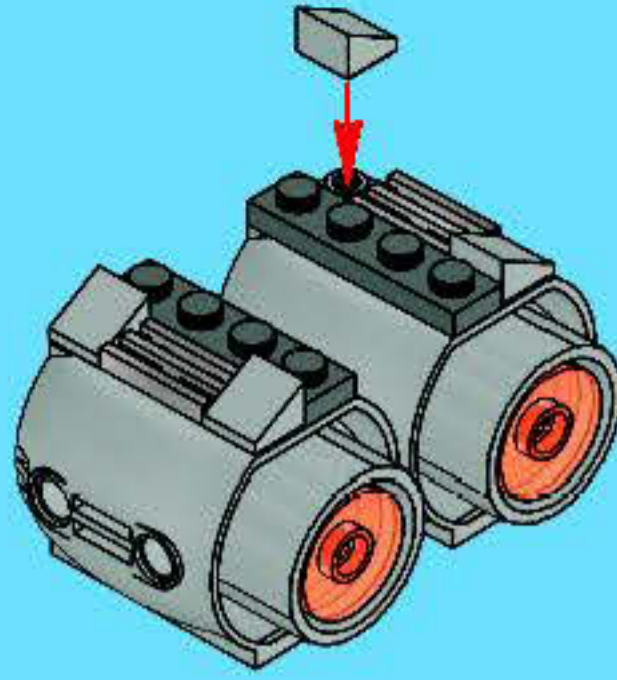

5

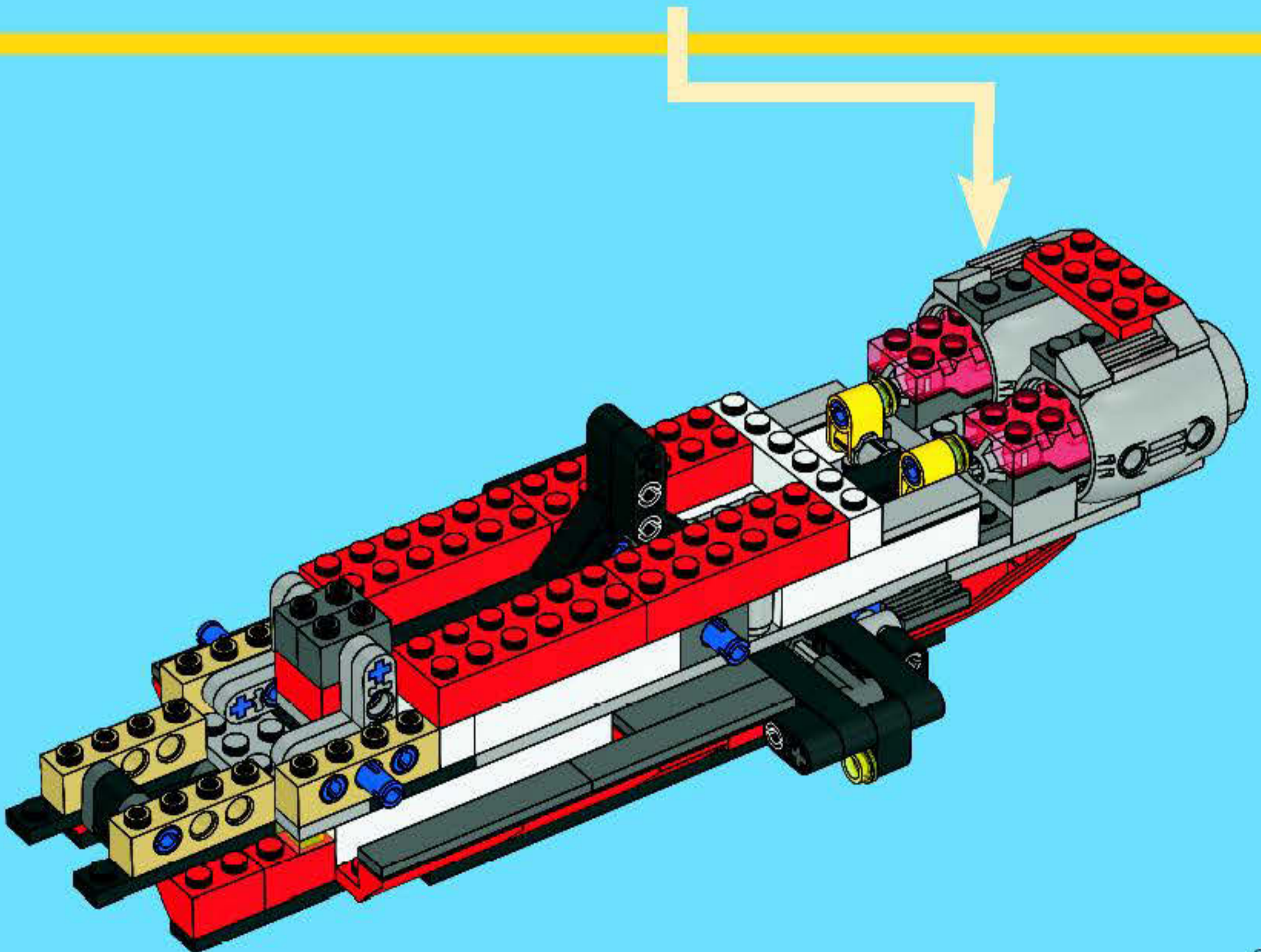
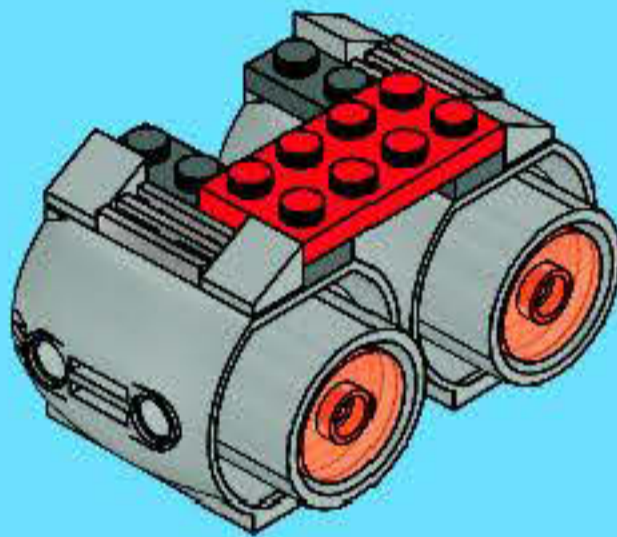



2x

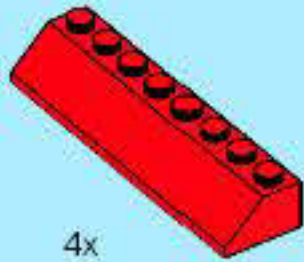

4x

# 30

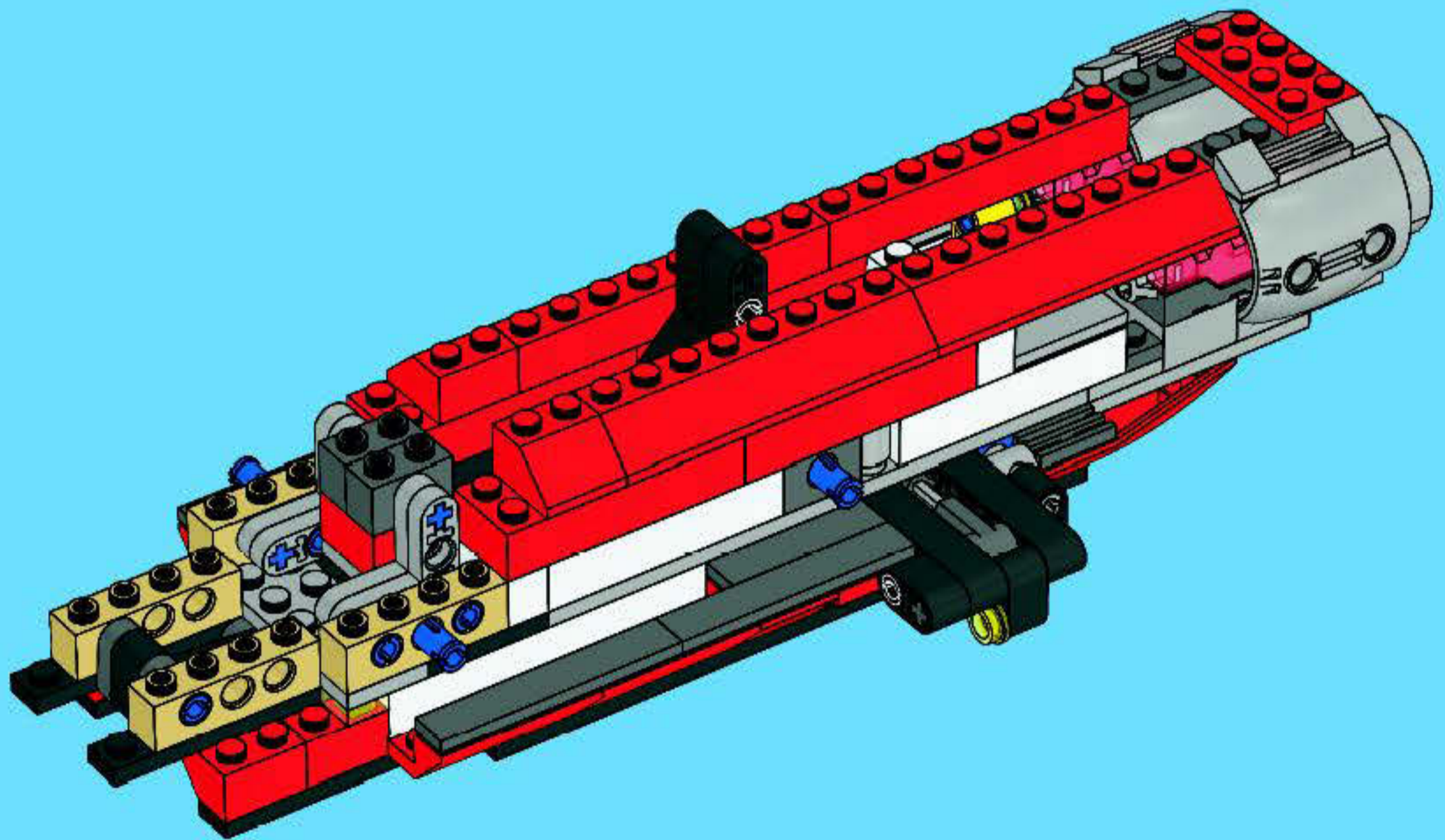





31

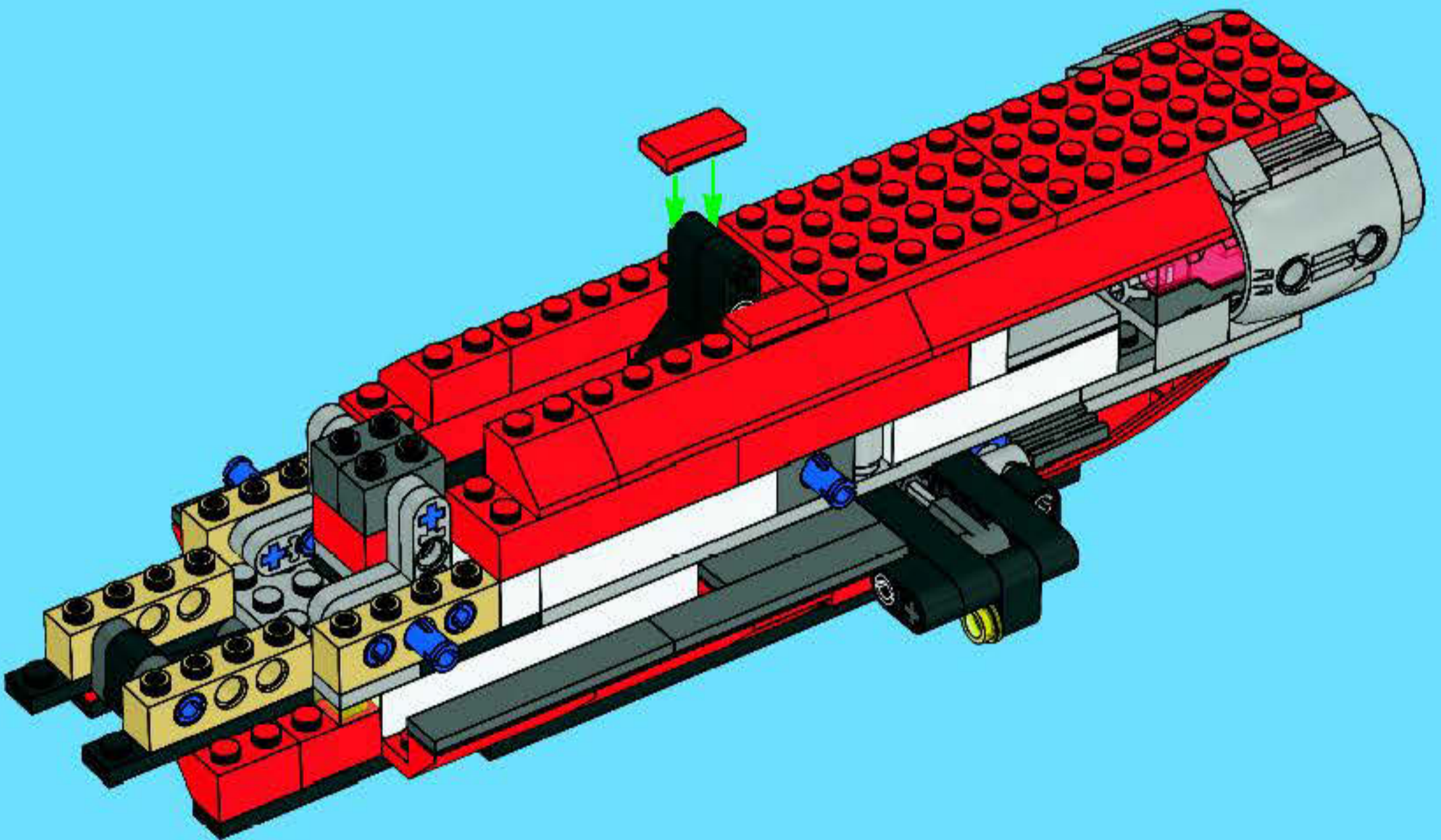



10x



2x

# 32

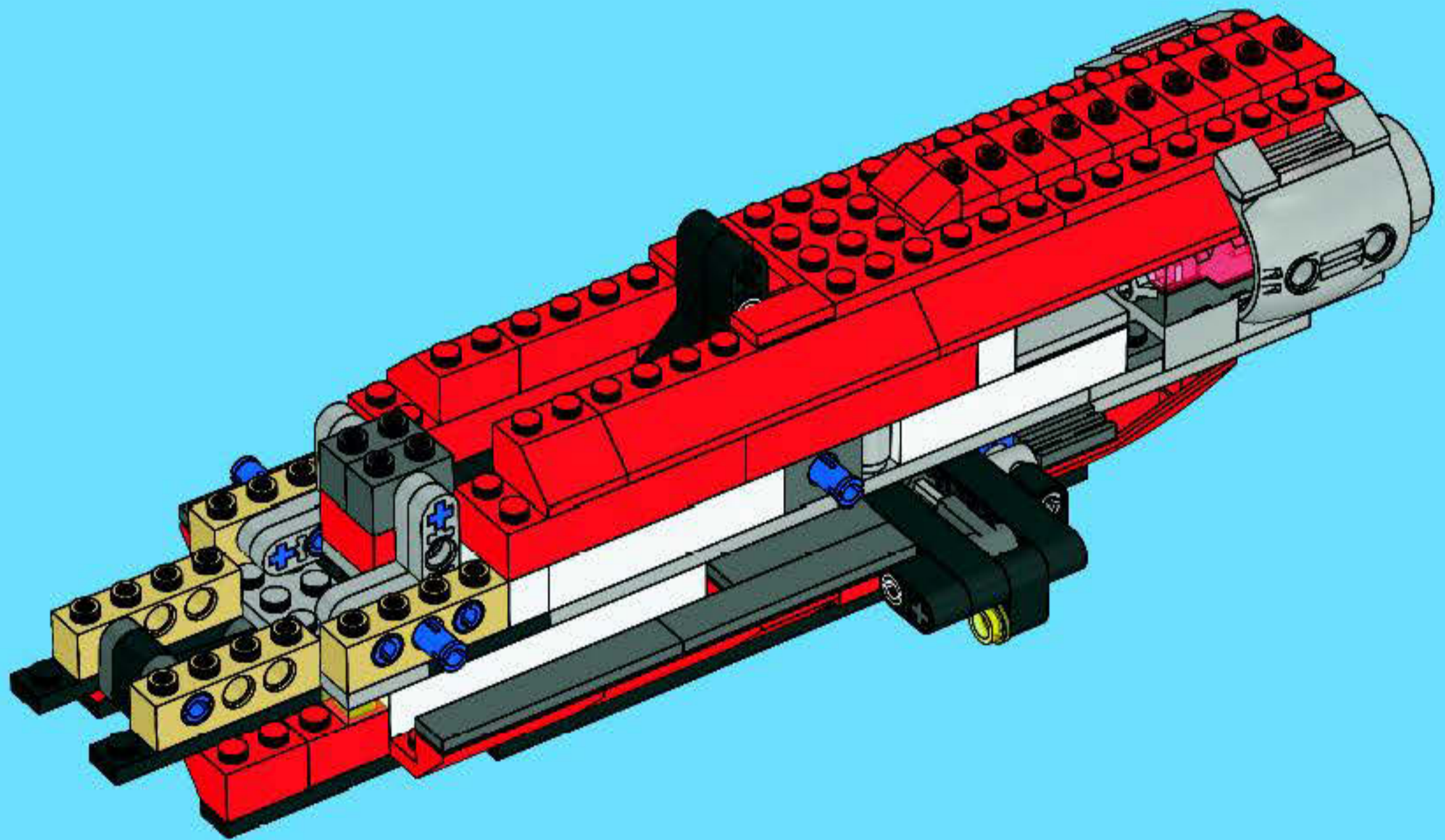

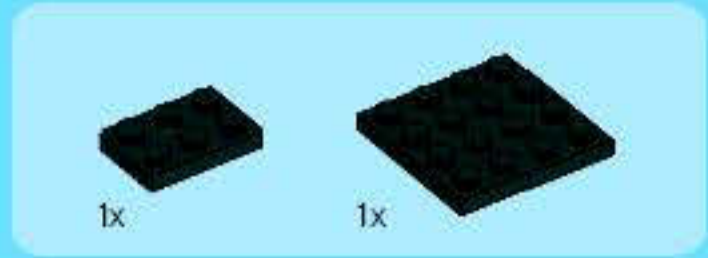
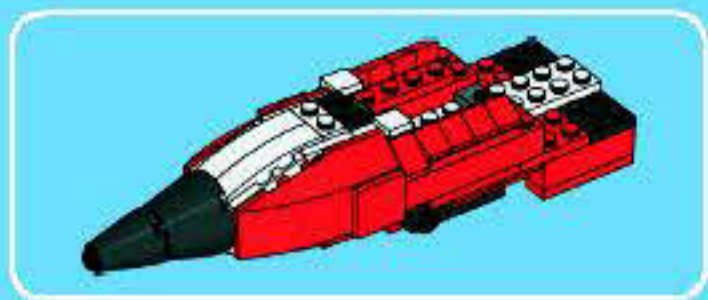

1



2

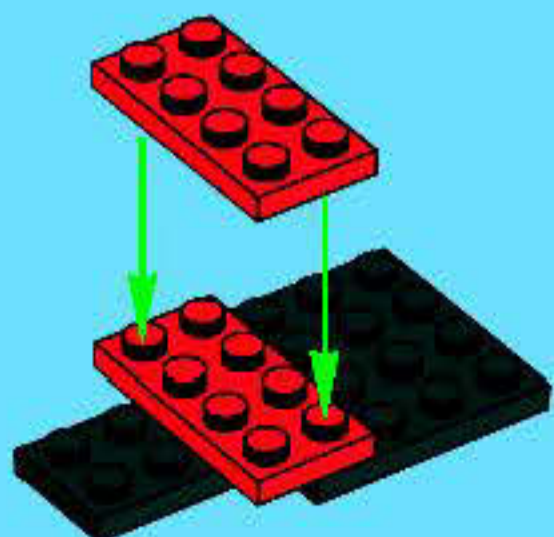

3

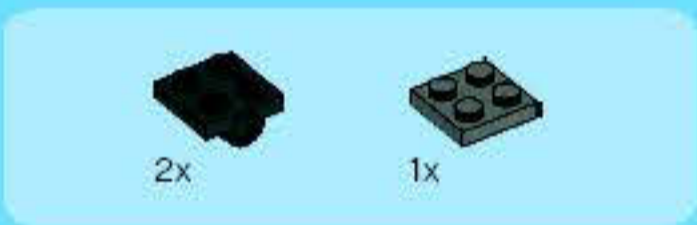
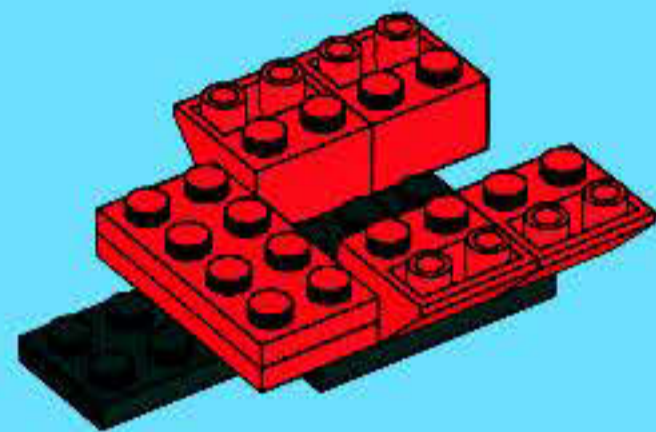

4

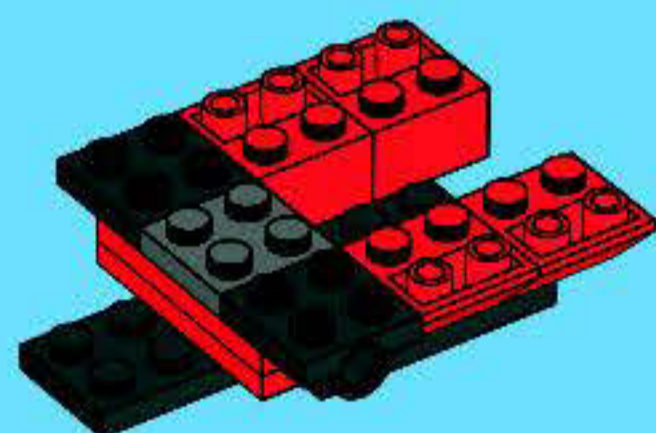

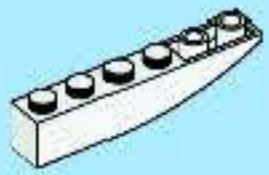

2x

5

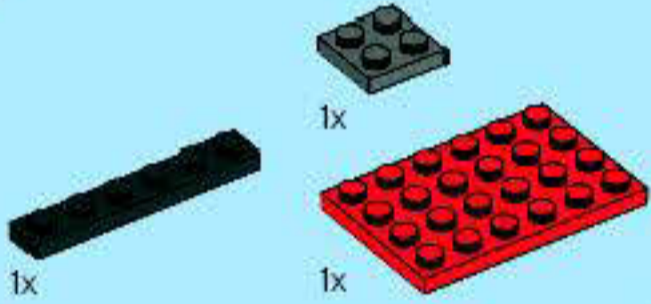
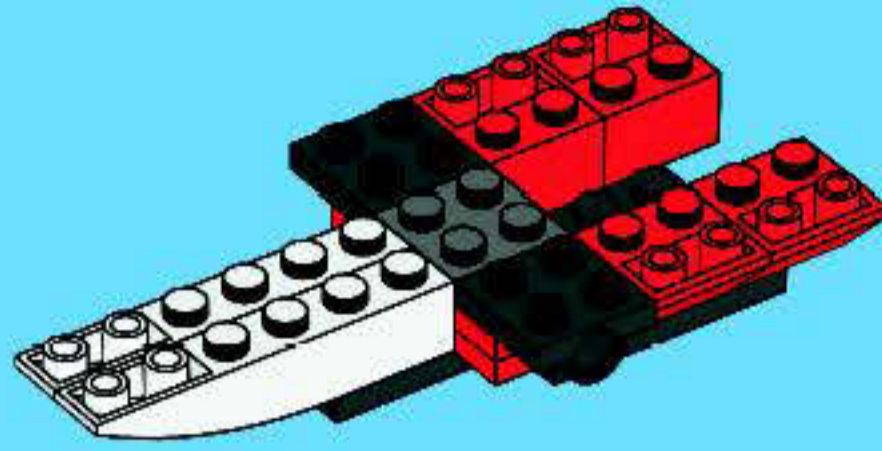

6

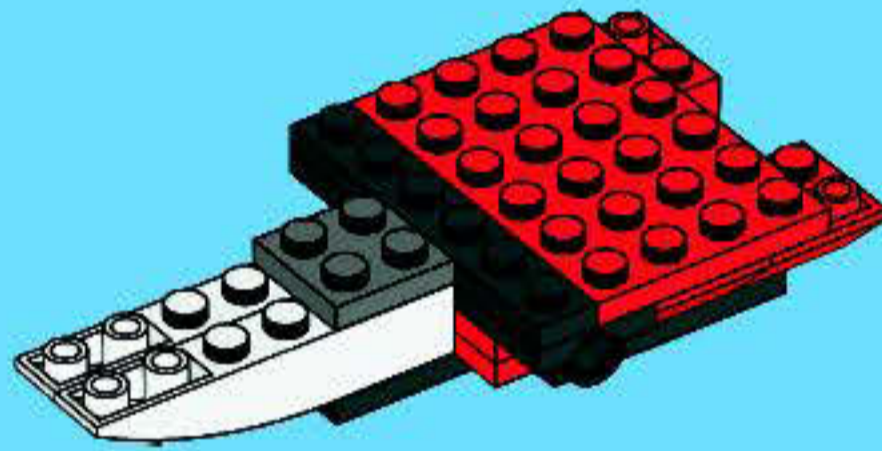

7

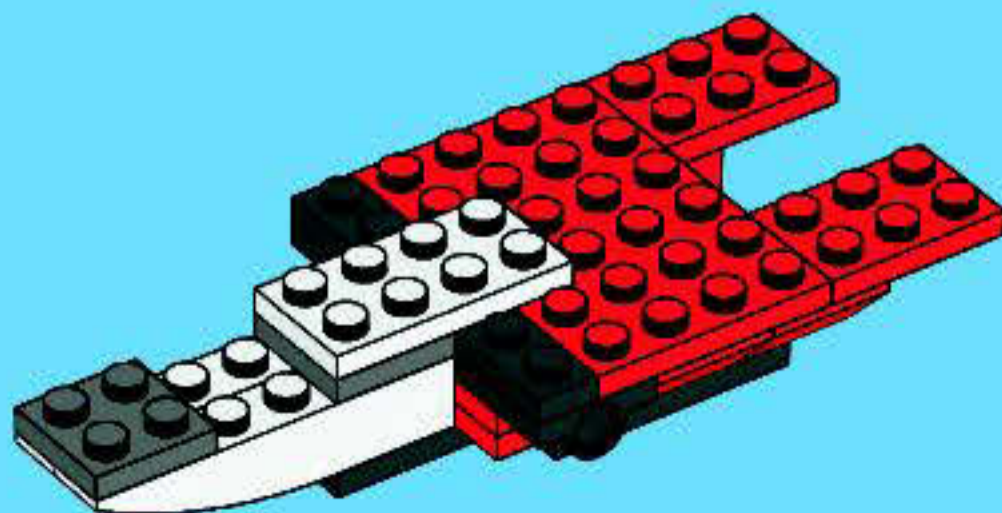

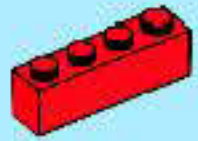

2x



2x

8

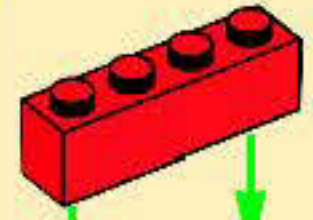

2x

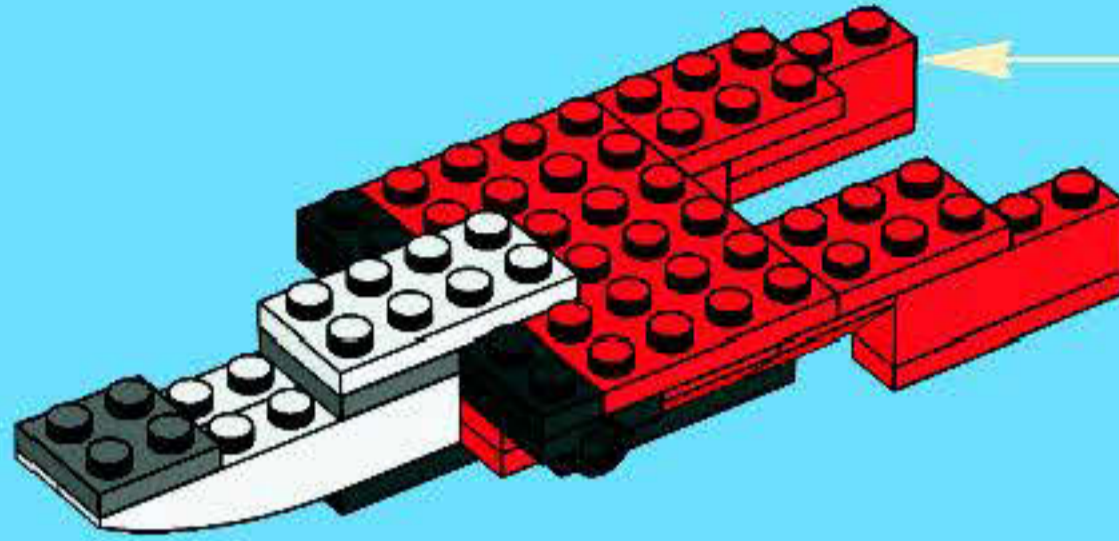

1x

9

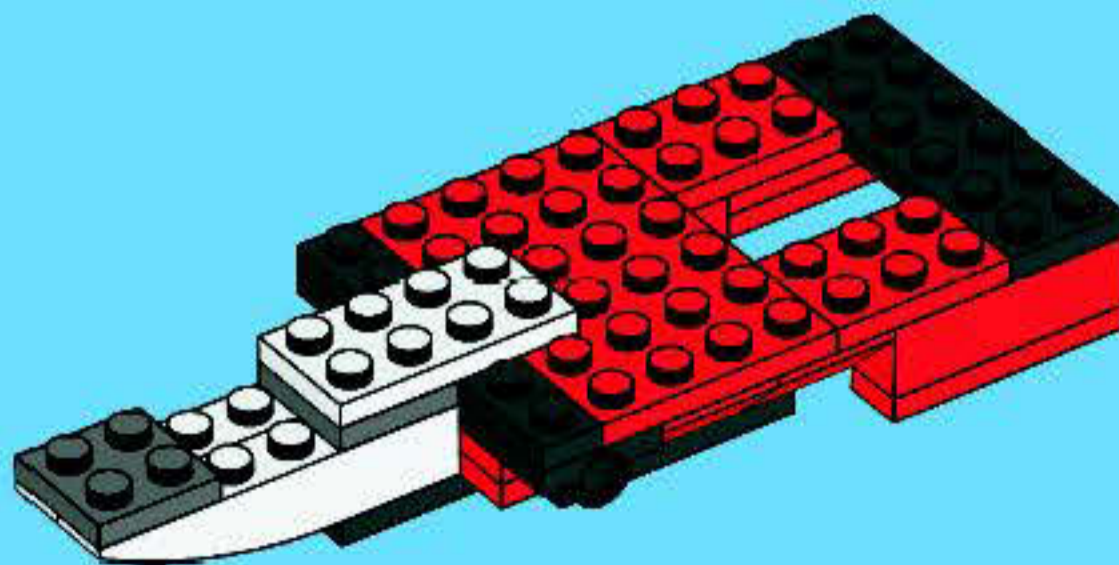

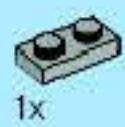

1x

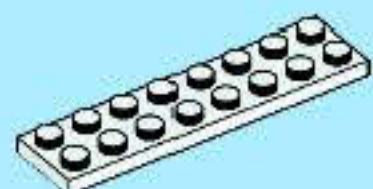

1x

# 10

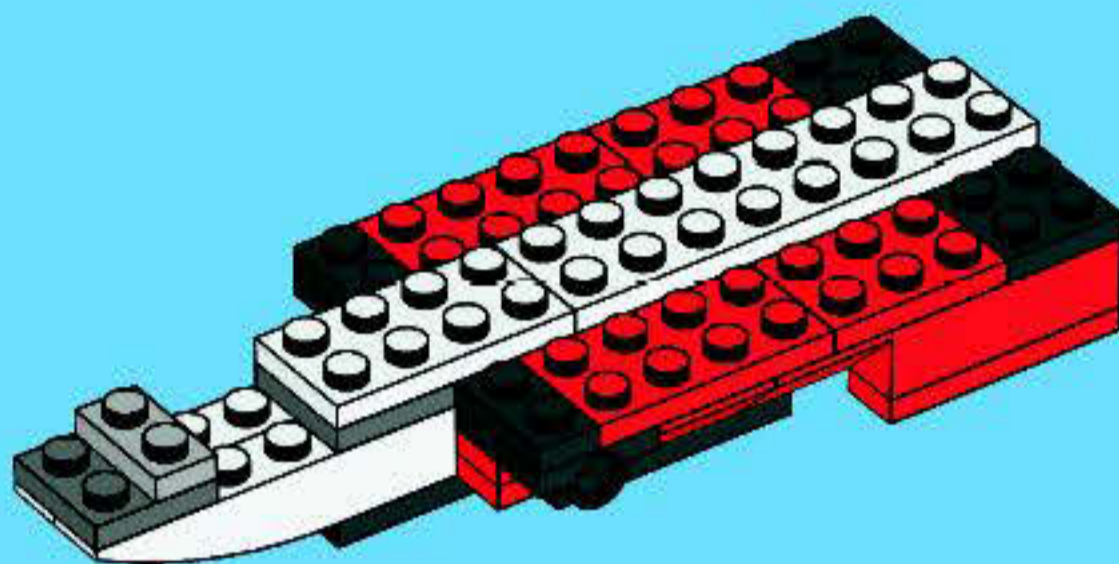

2x



2x



1x

# 11

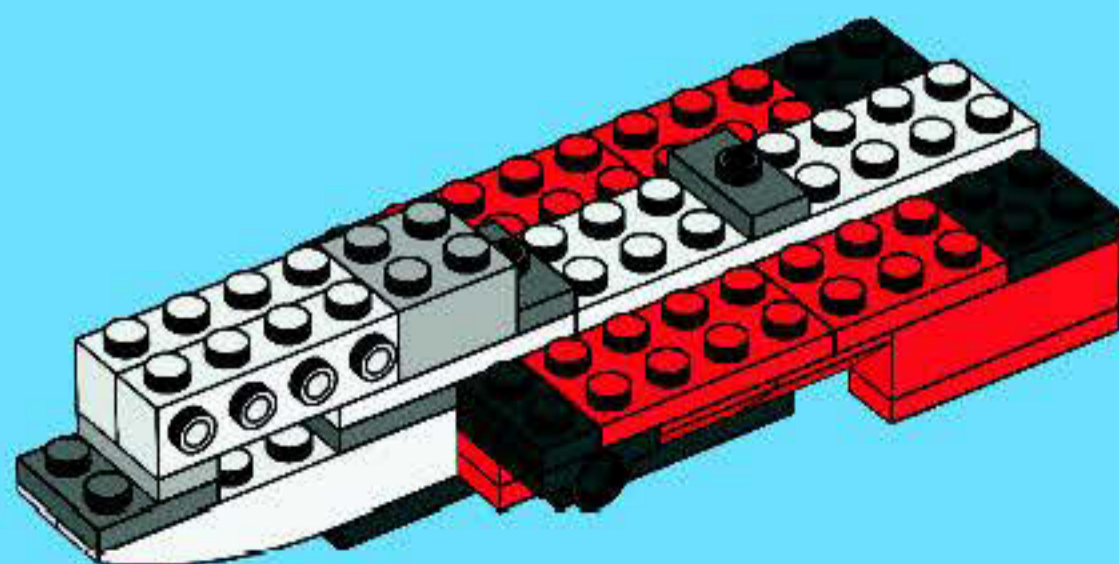

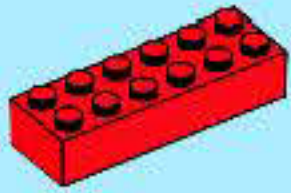

2x



1x

# 12

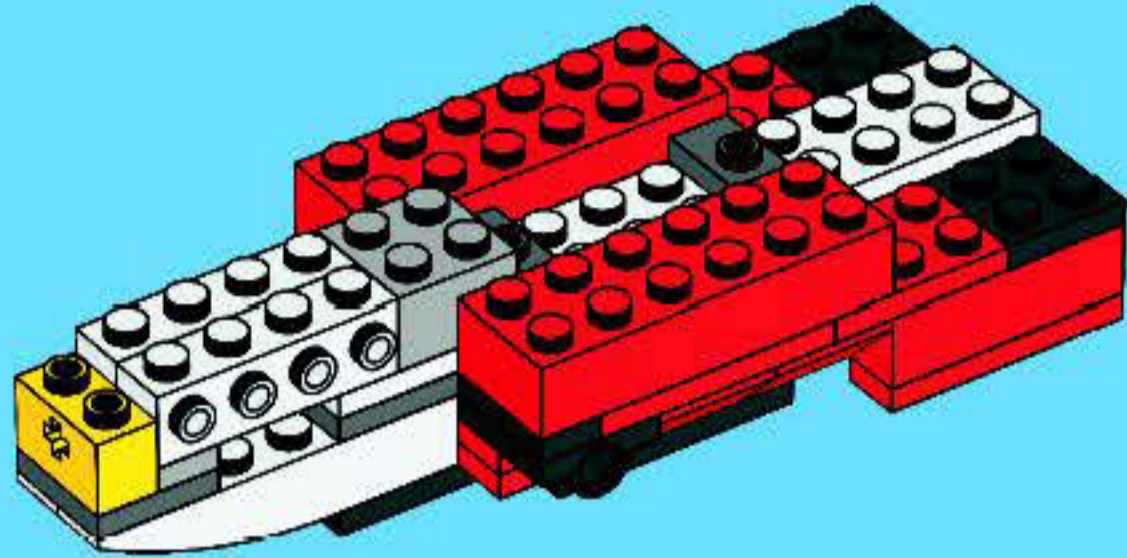

2x



1x

# 13

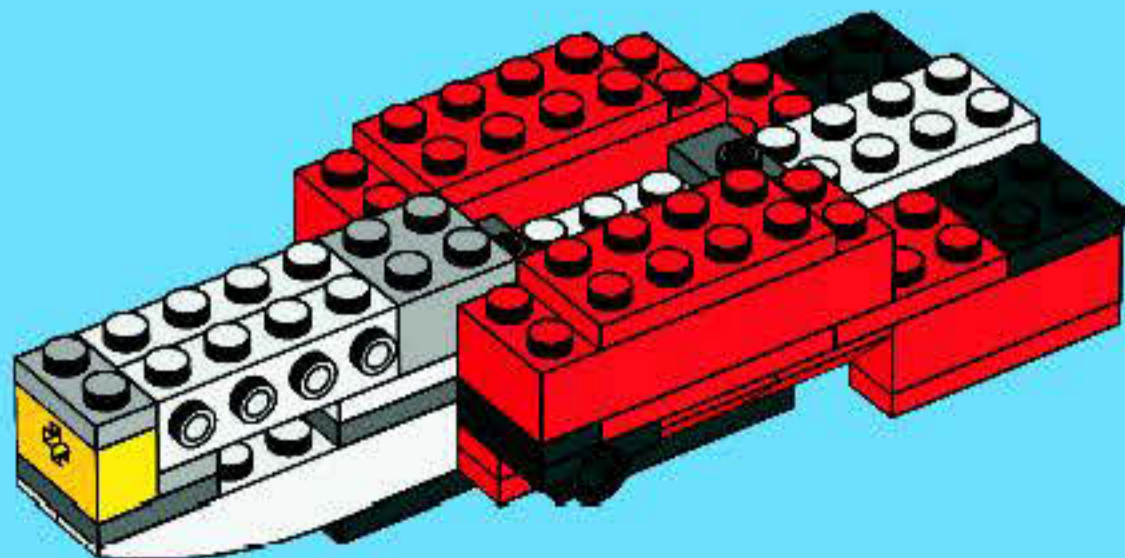



2x



8x

14

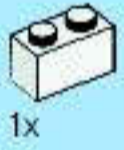
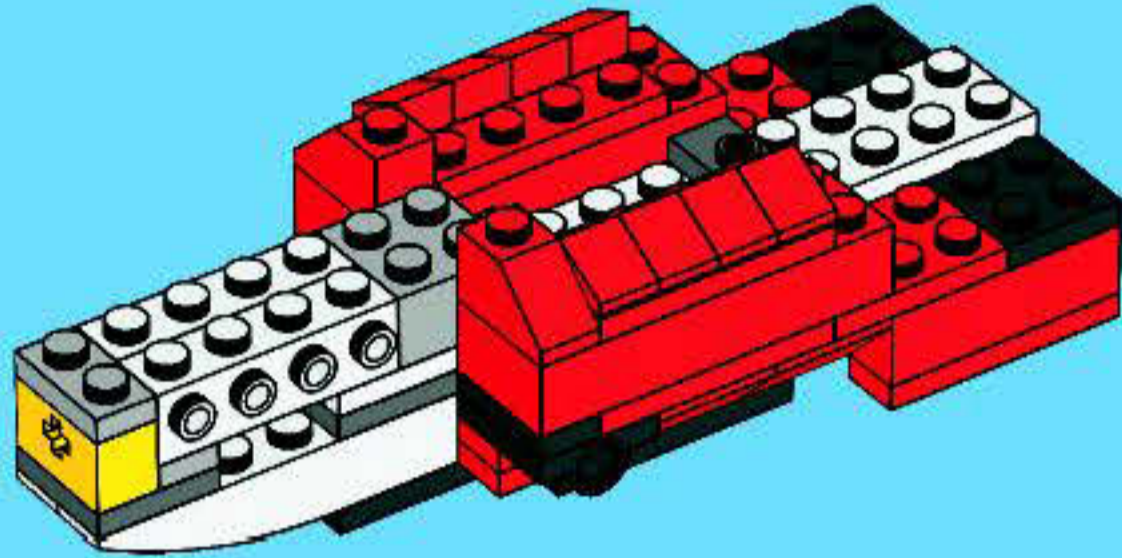

1x



1x



1x

15

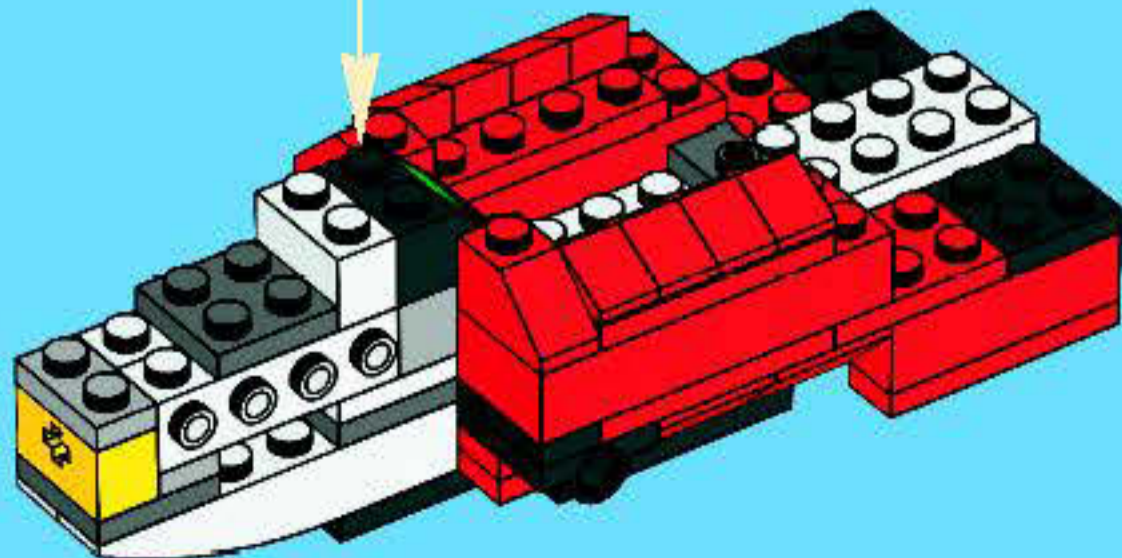





1x

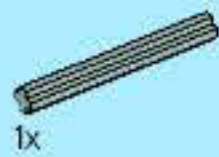

1x

5



5

1:1

# 16

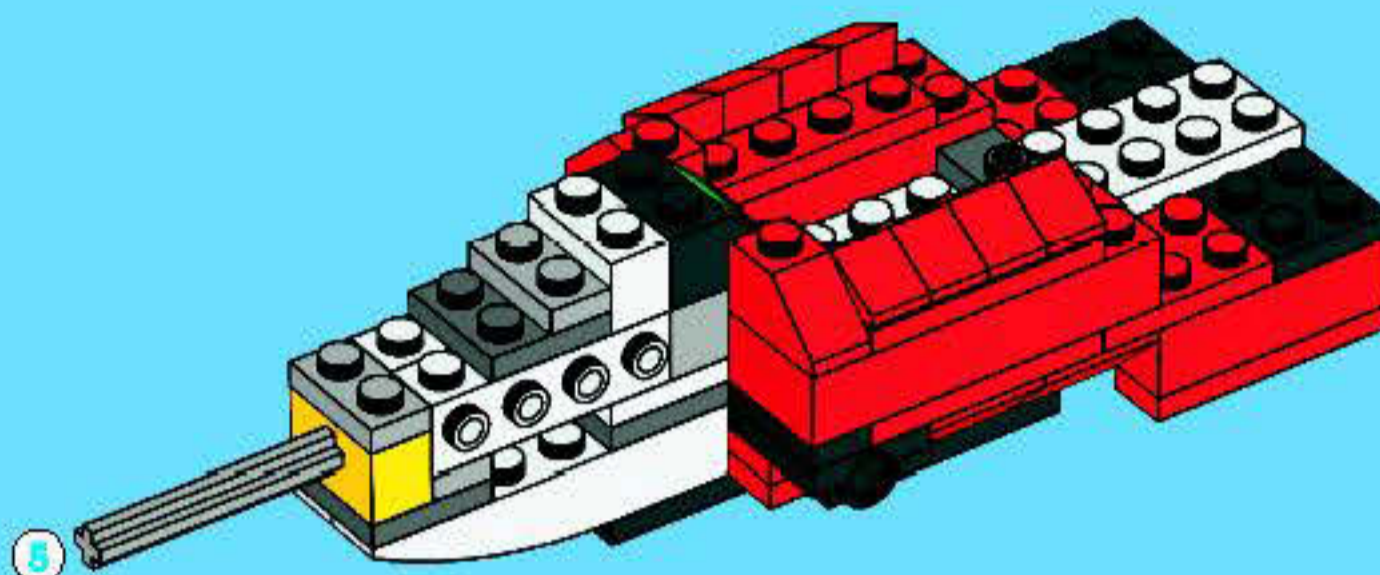

2x



2x

# 17

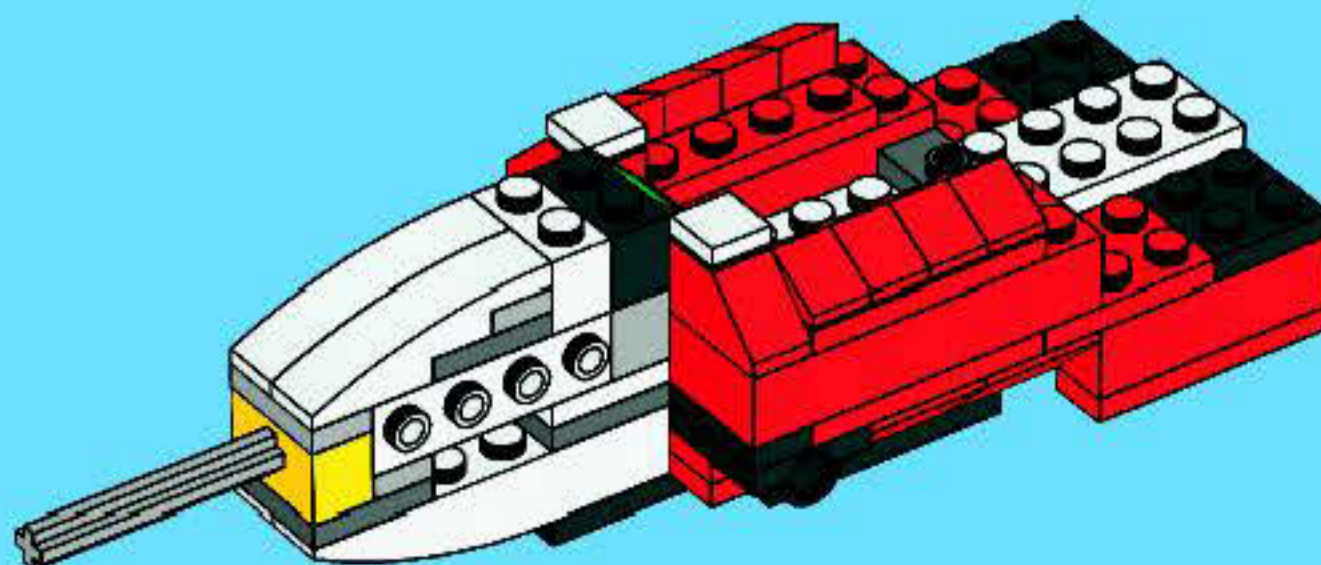

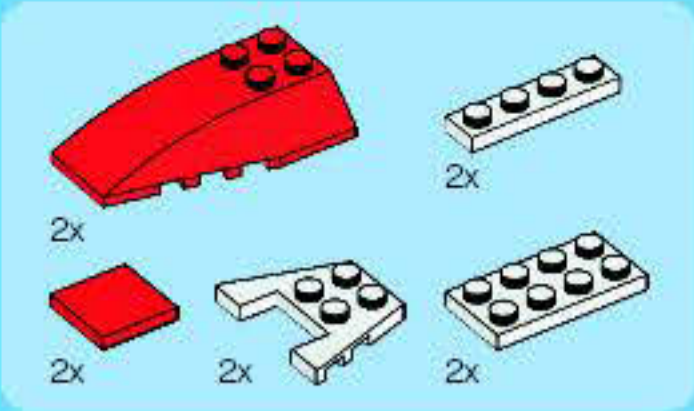

18

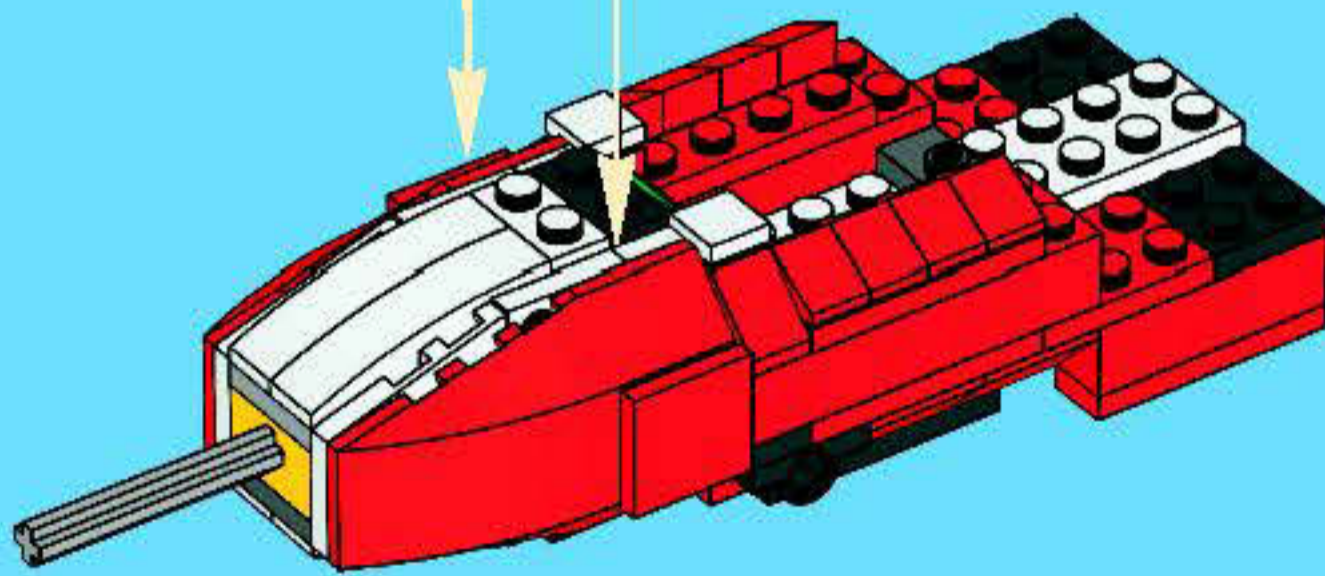
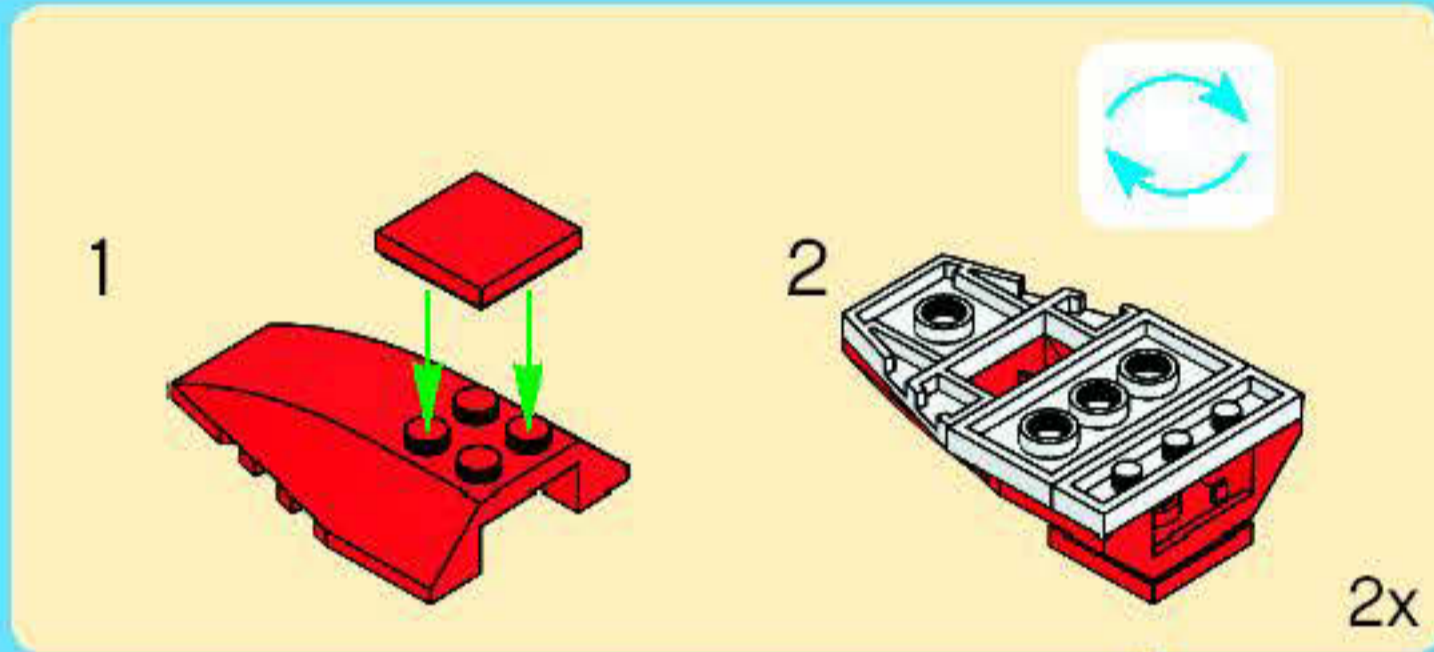



1x



1x

19

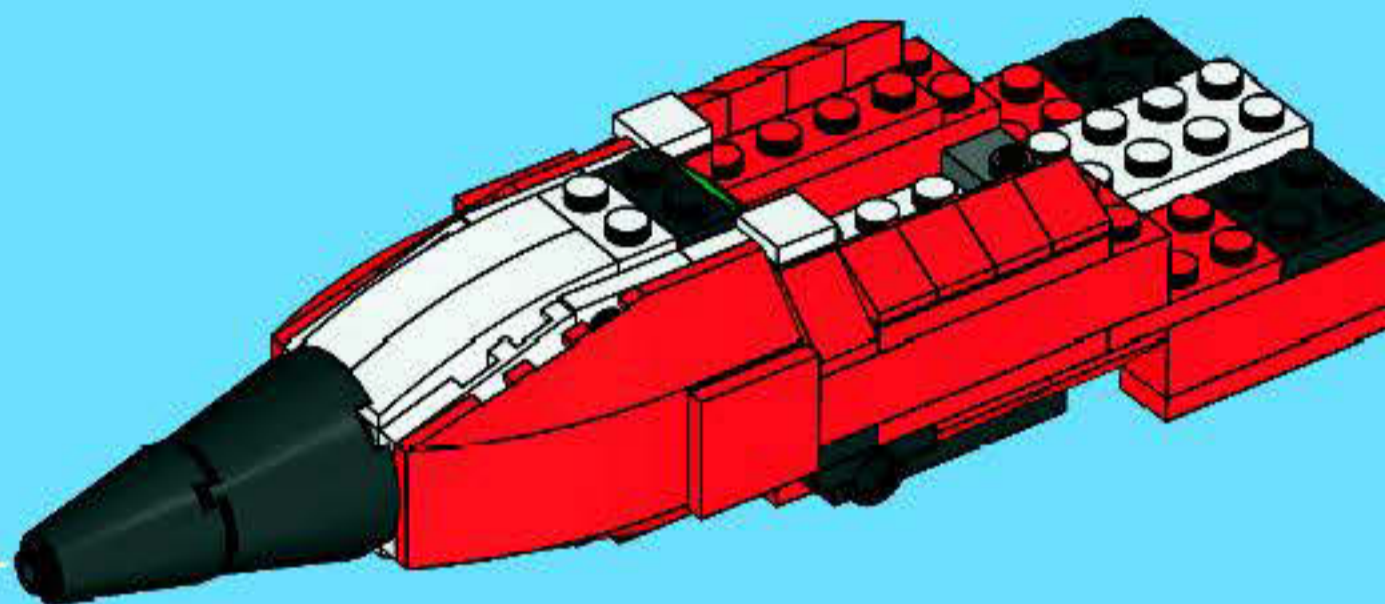

33

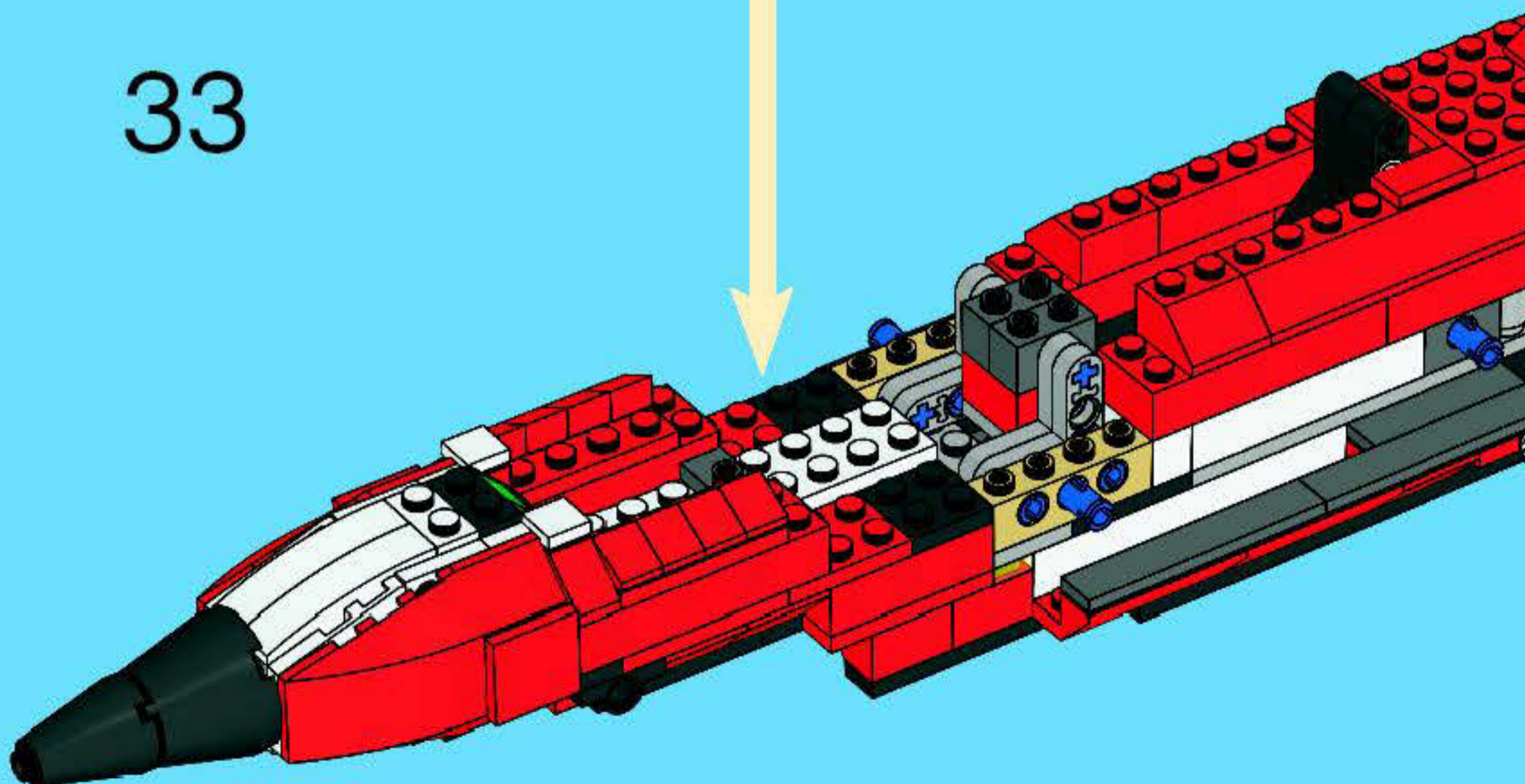

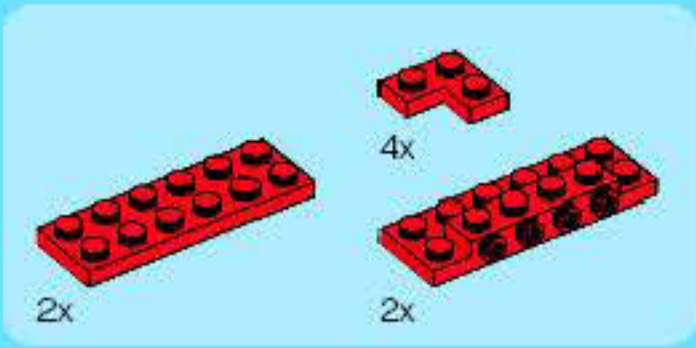

# 34

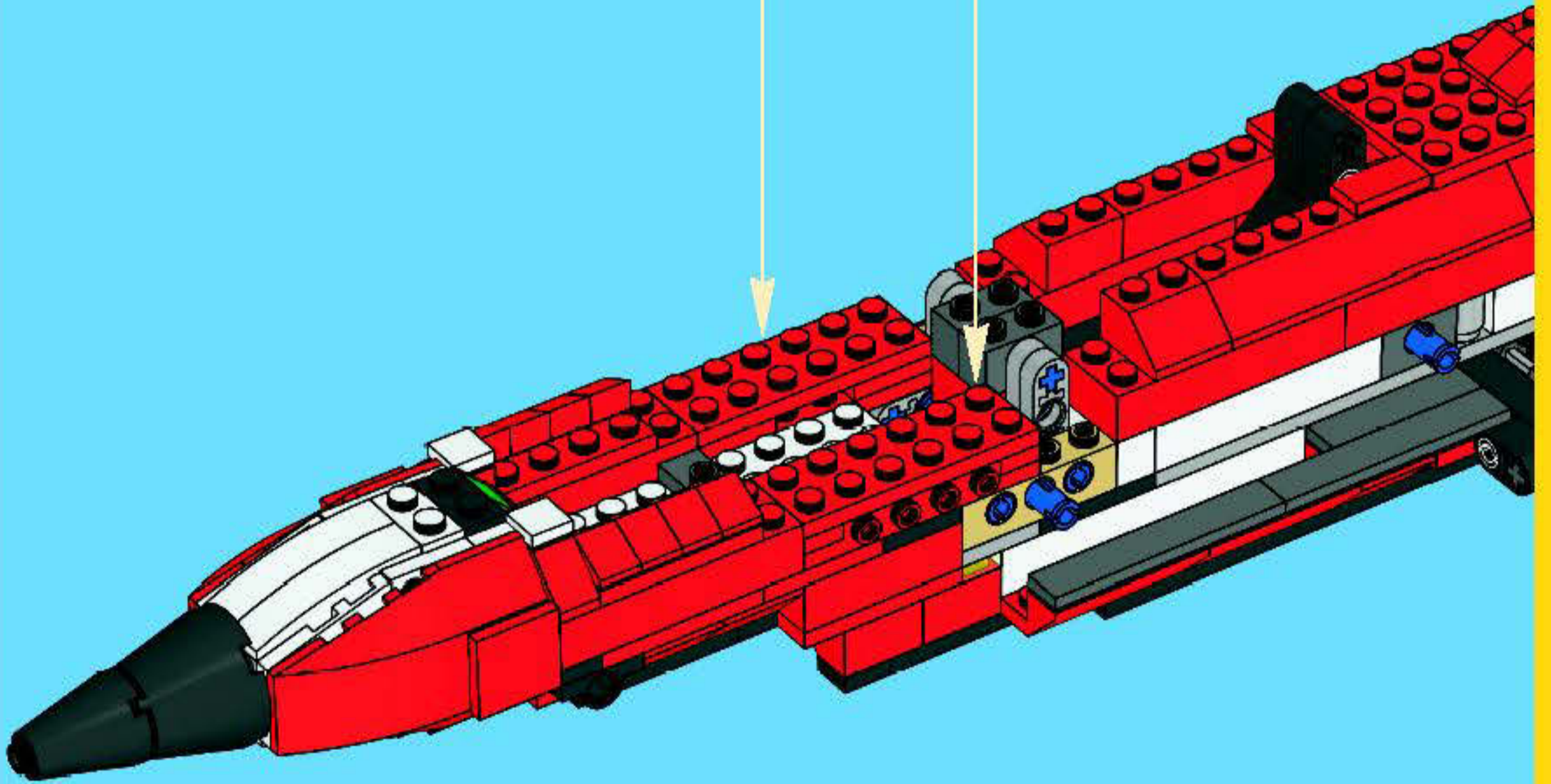
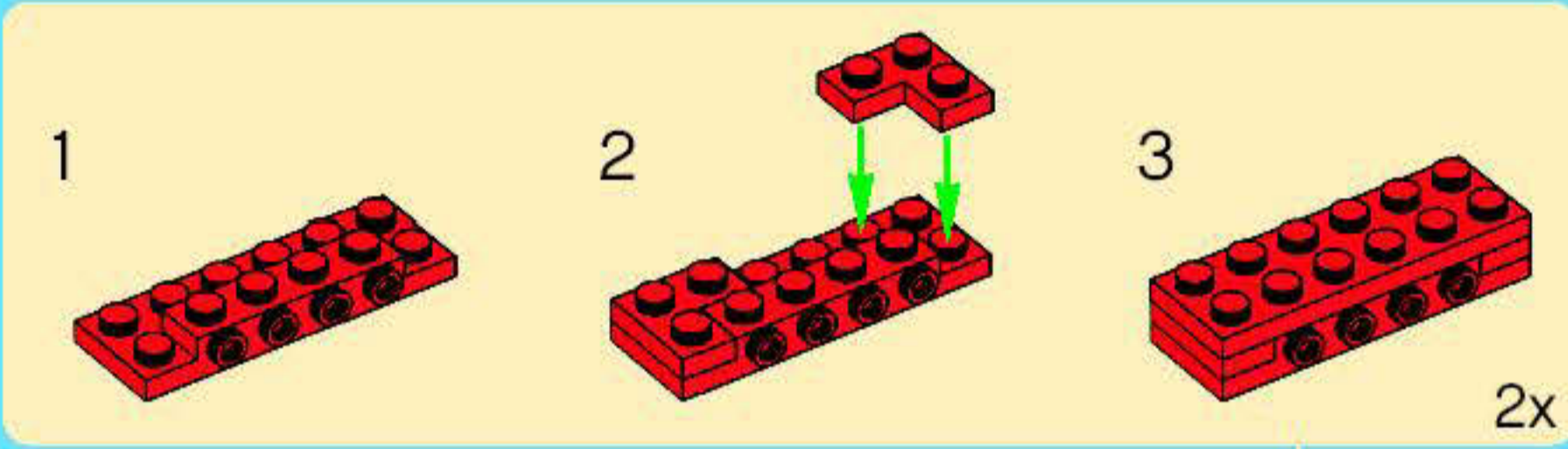



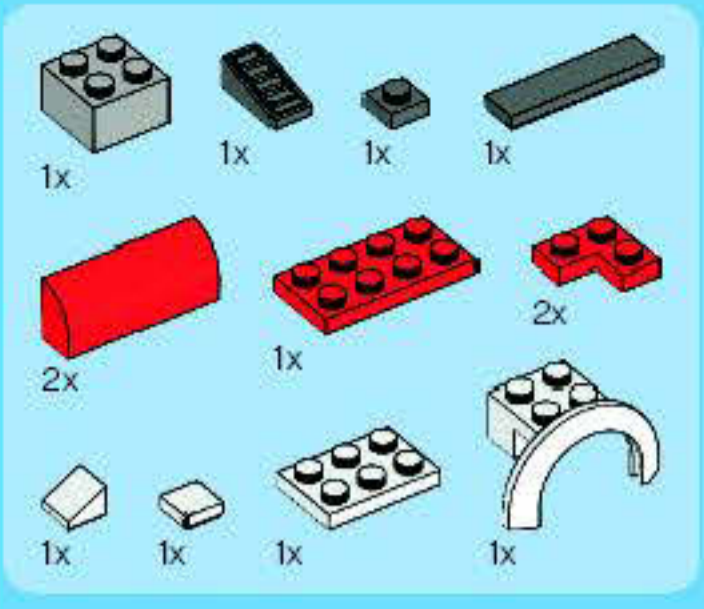

36

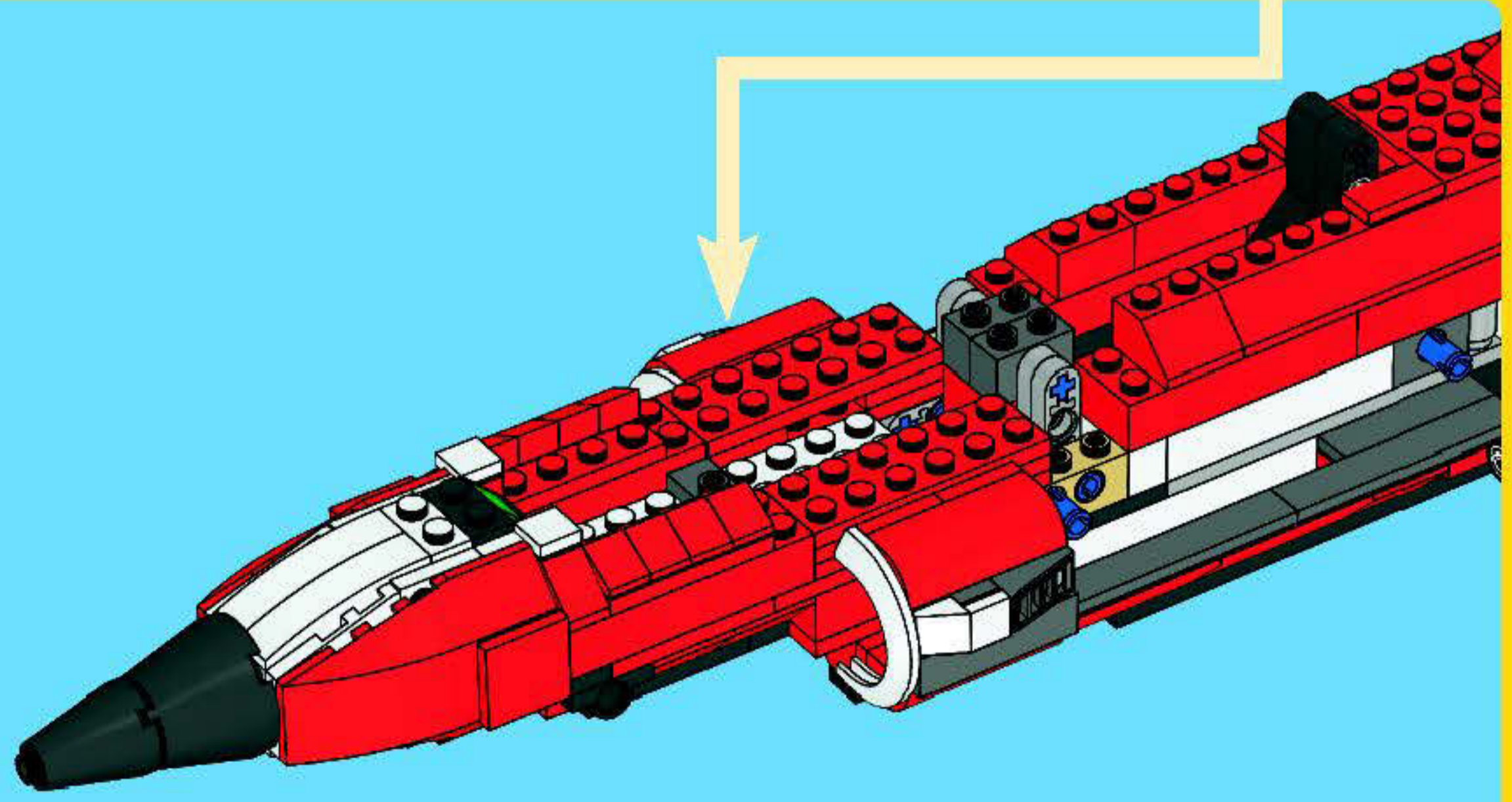
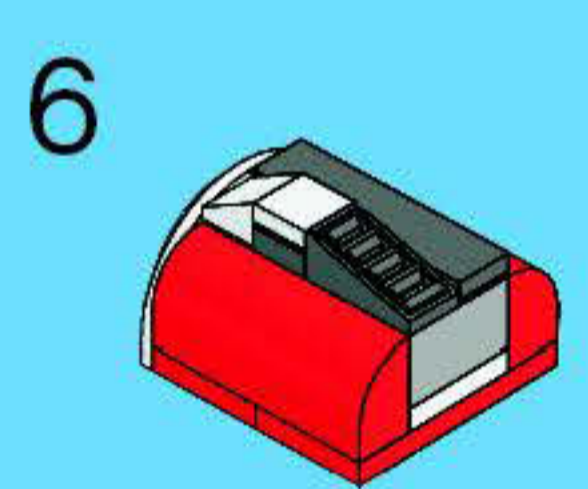
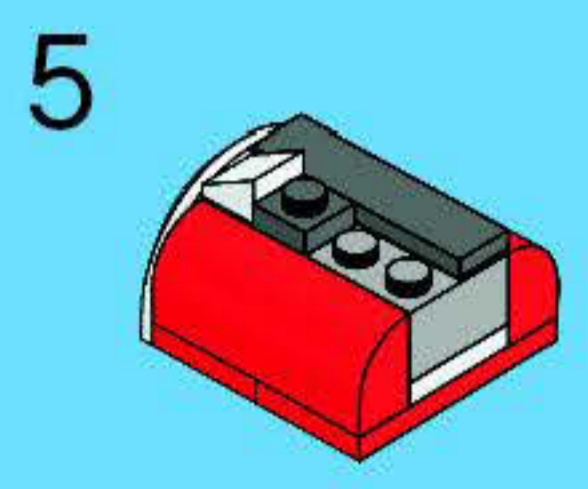
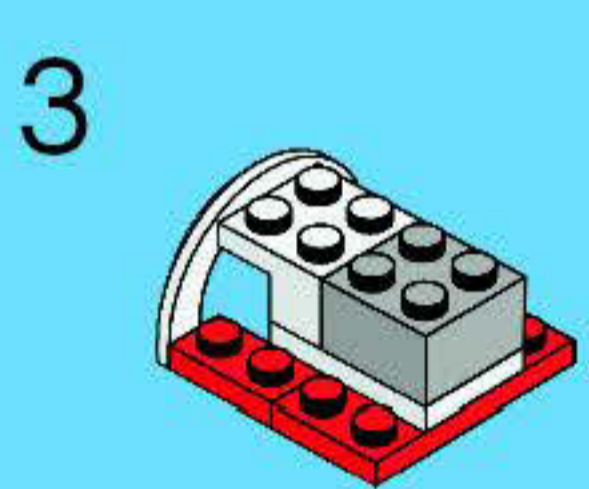
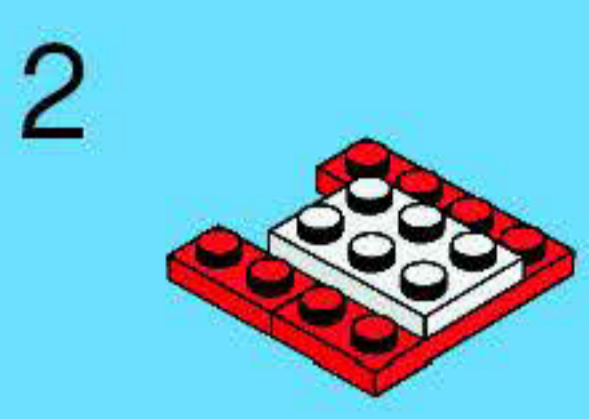
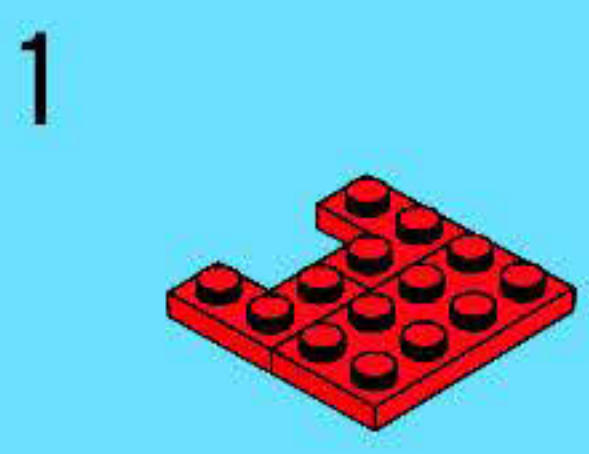

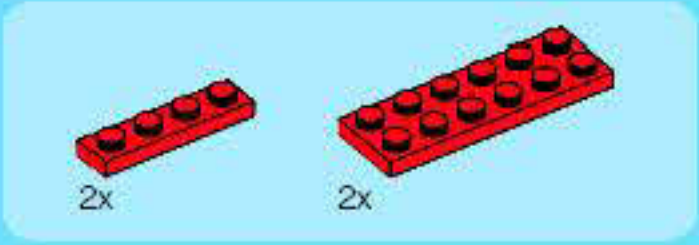

37

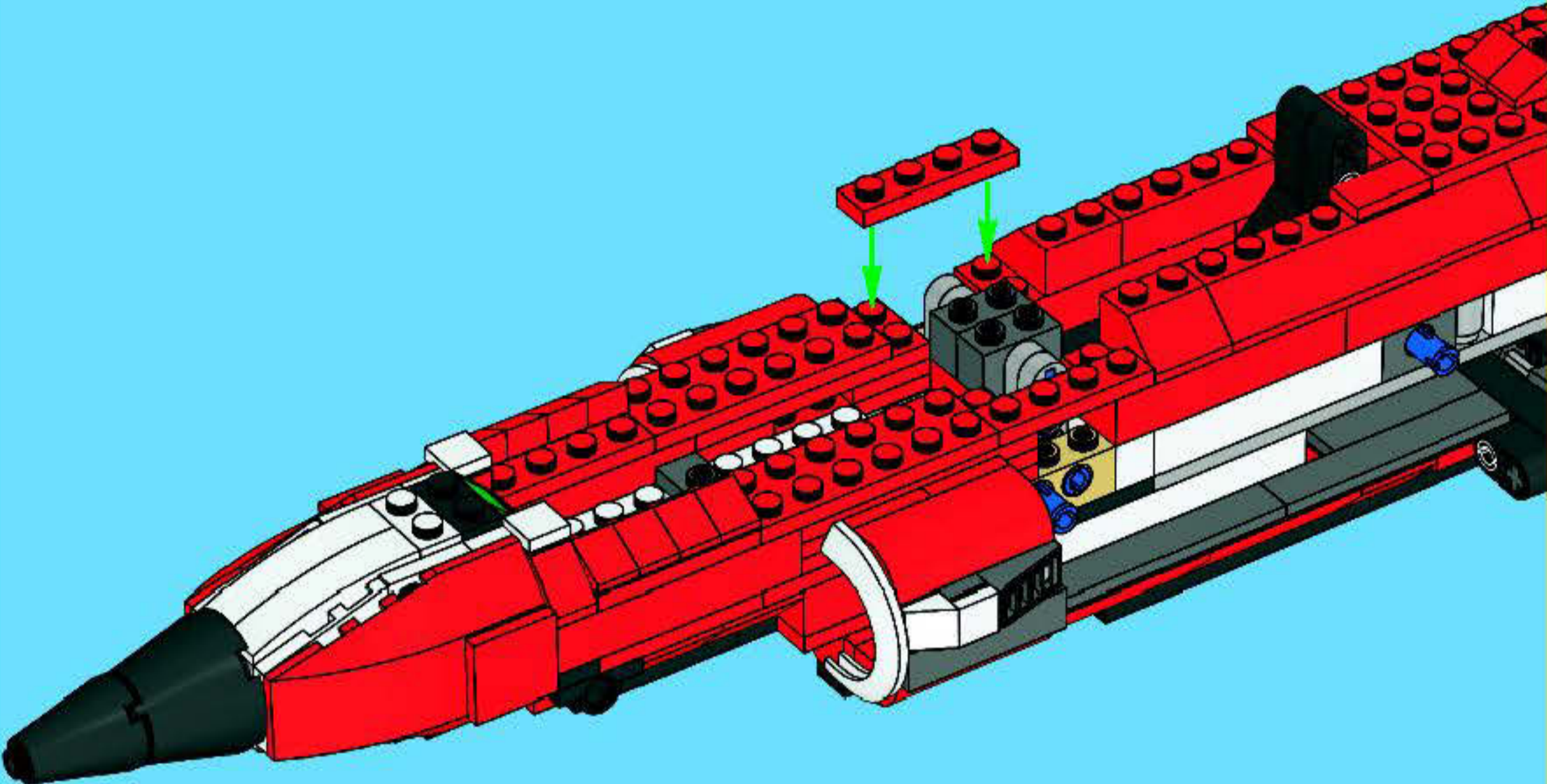

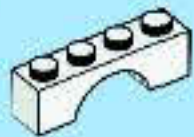

2x



1x



2x

# 38

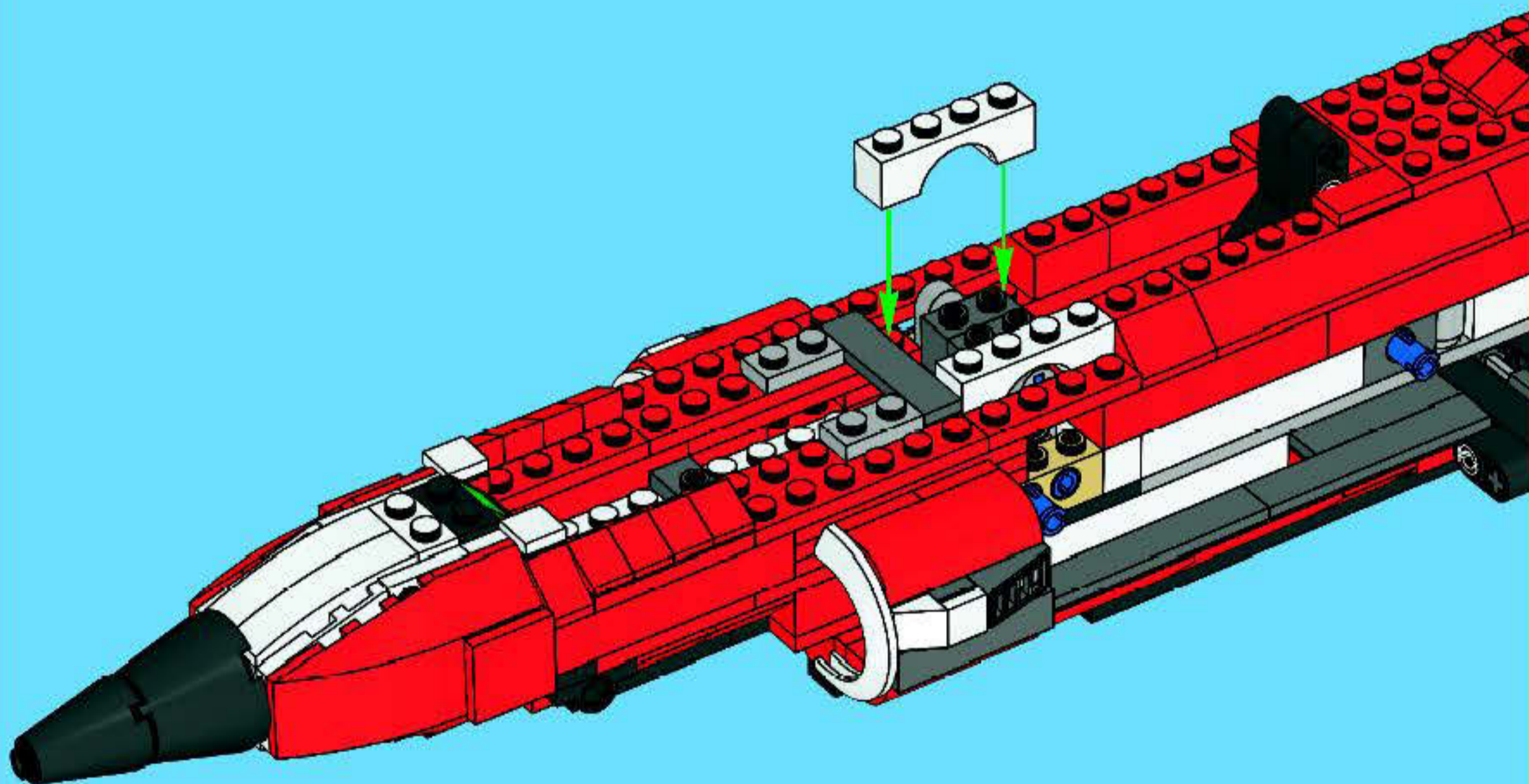



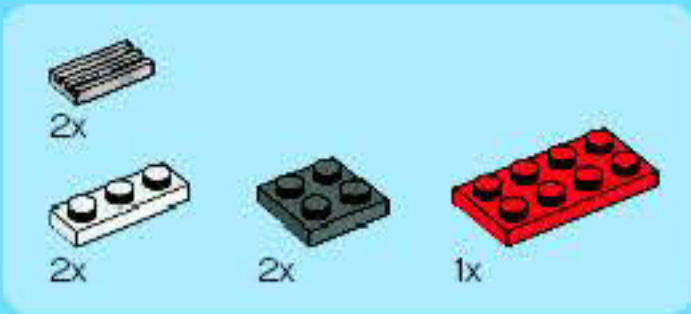

# 39

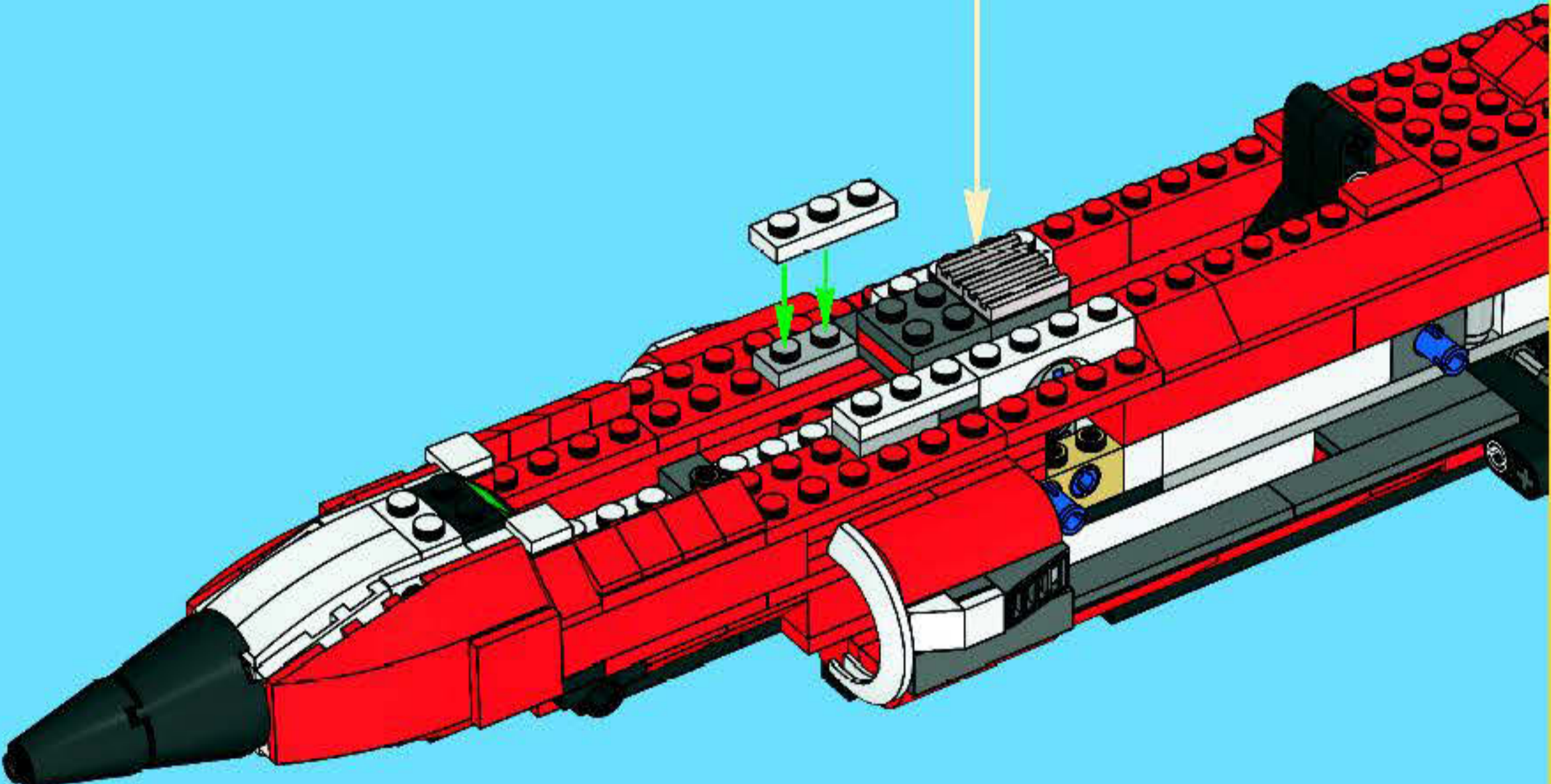
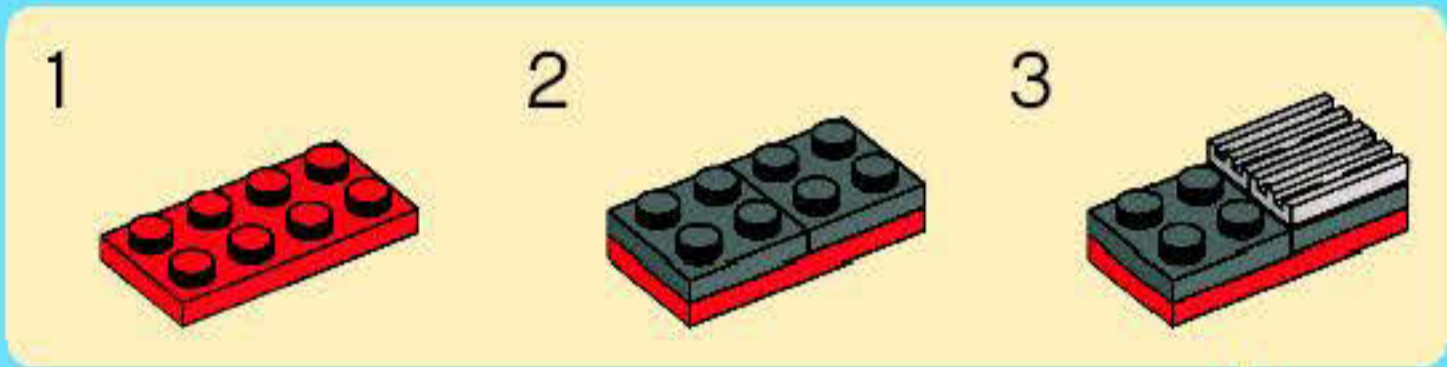



2x



20x

# 40

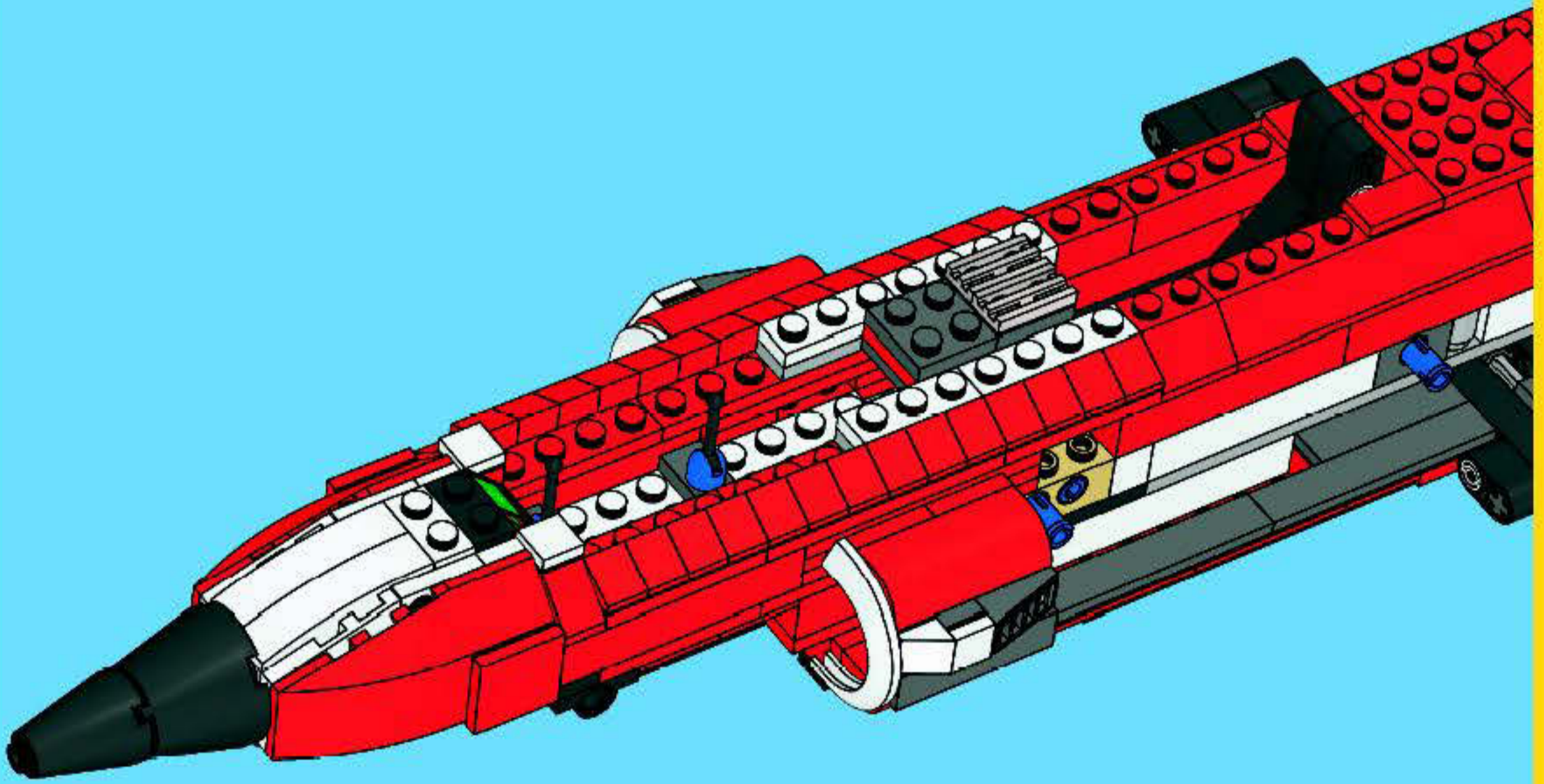

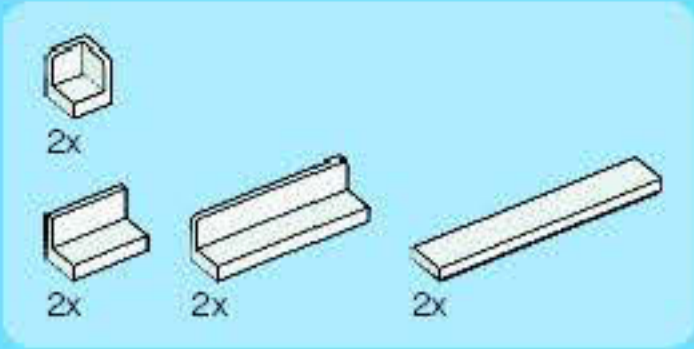

41

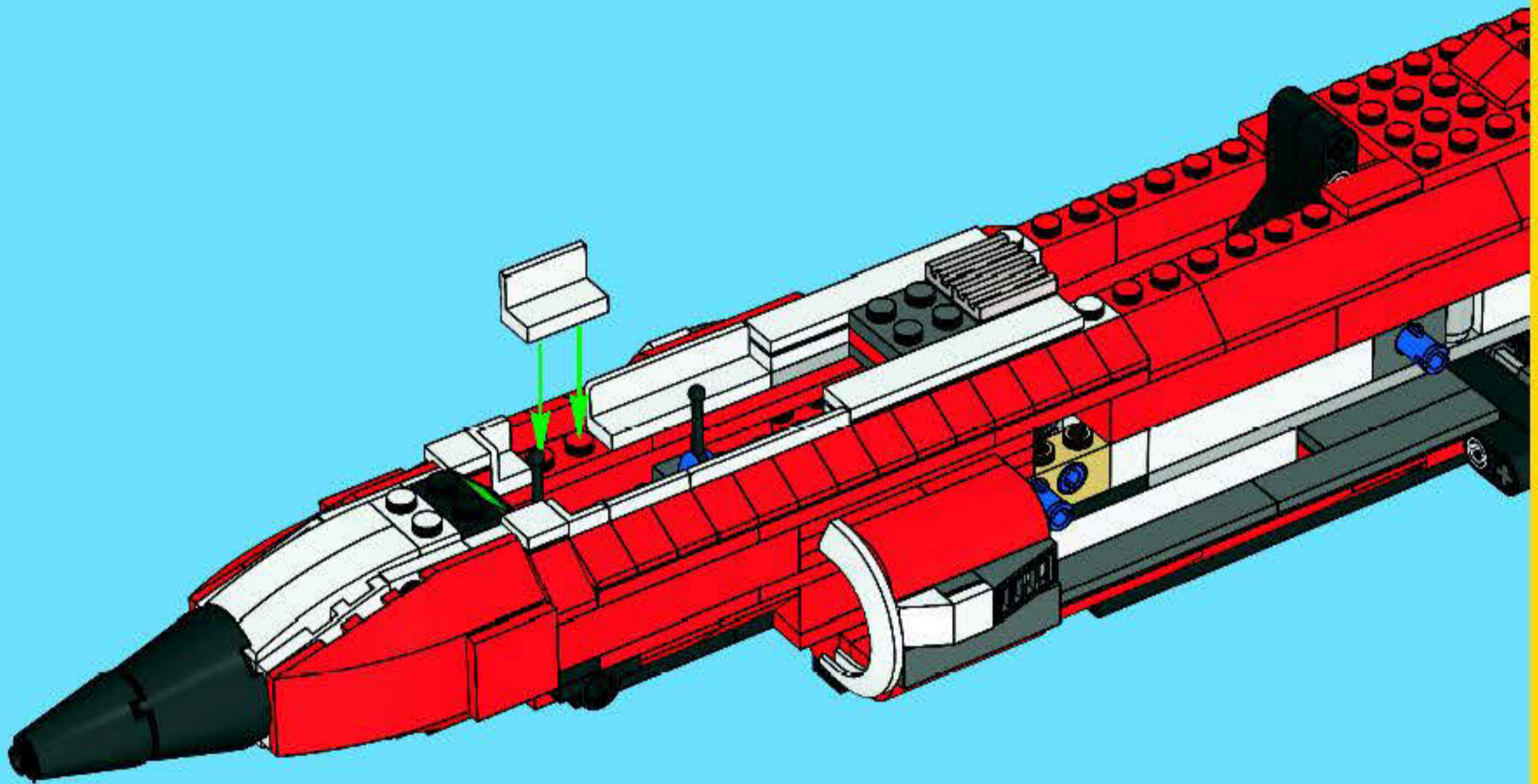

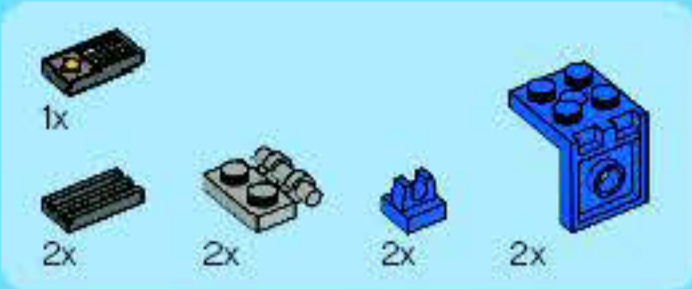

# 42

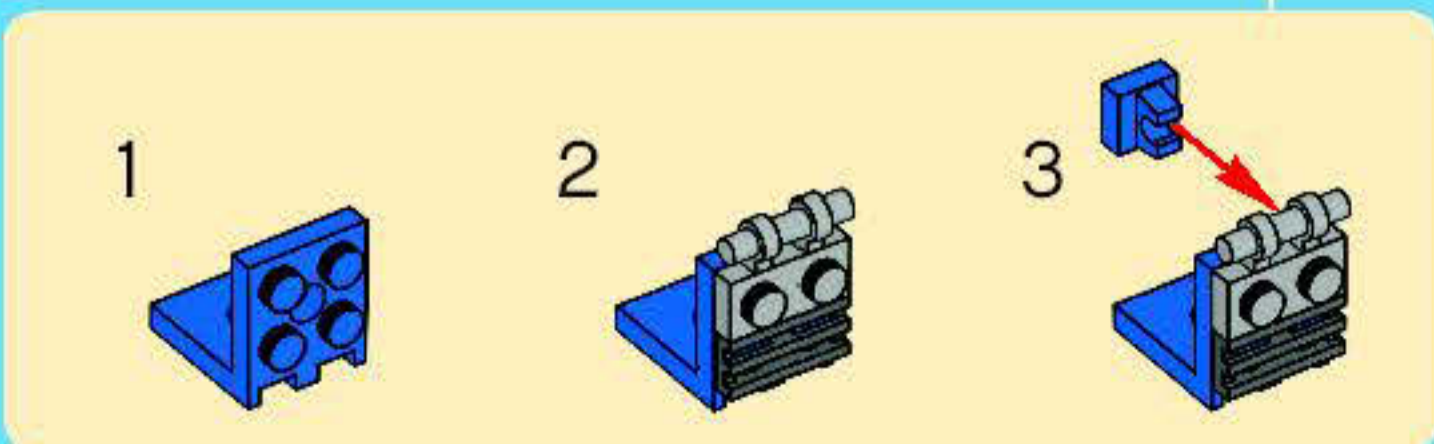
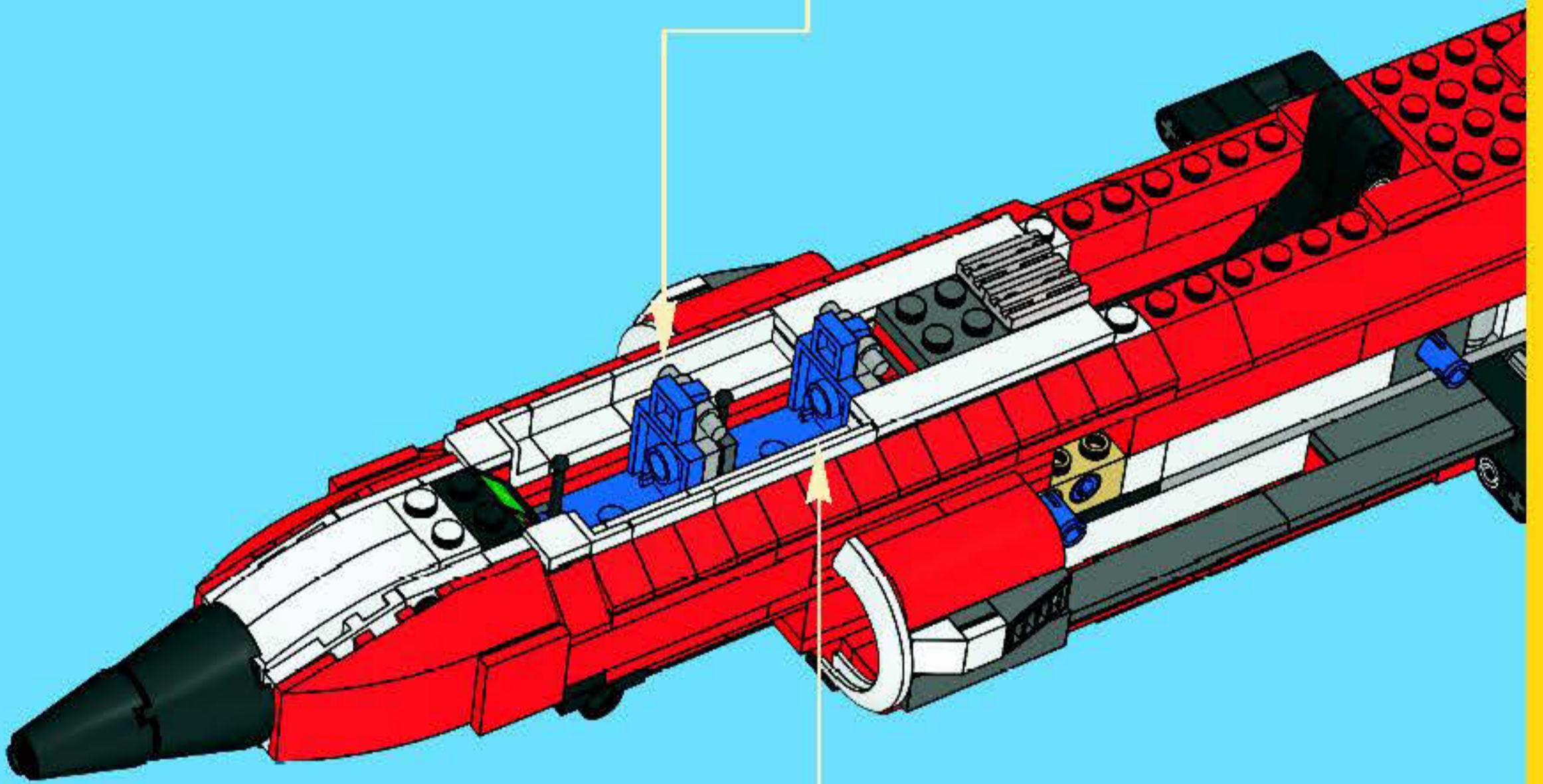
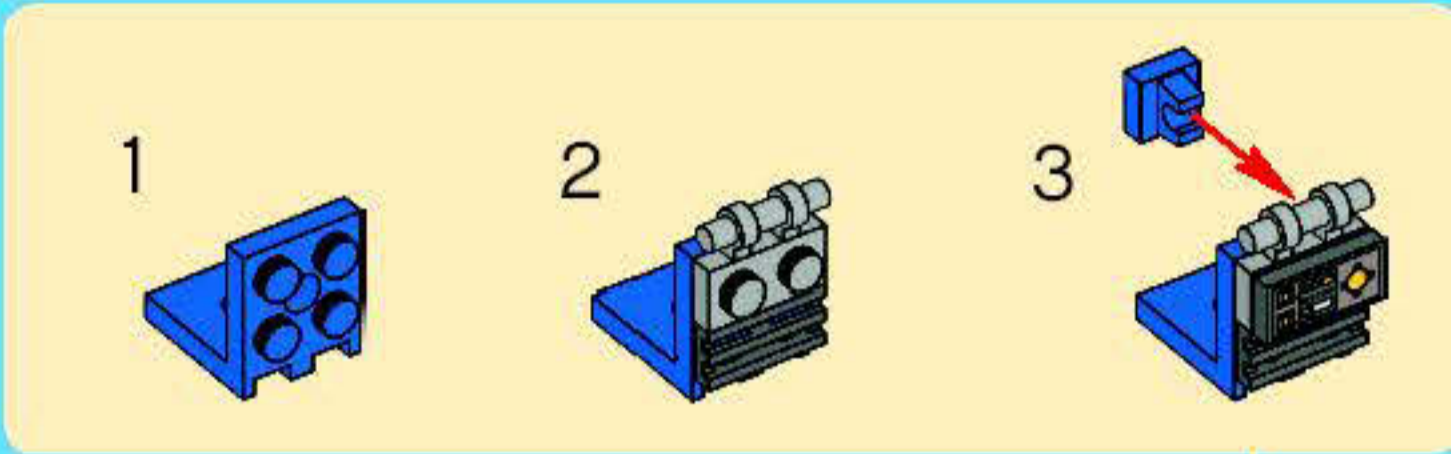



2x



2x



2x

# 43

1



2

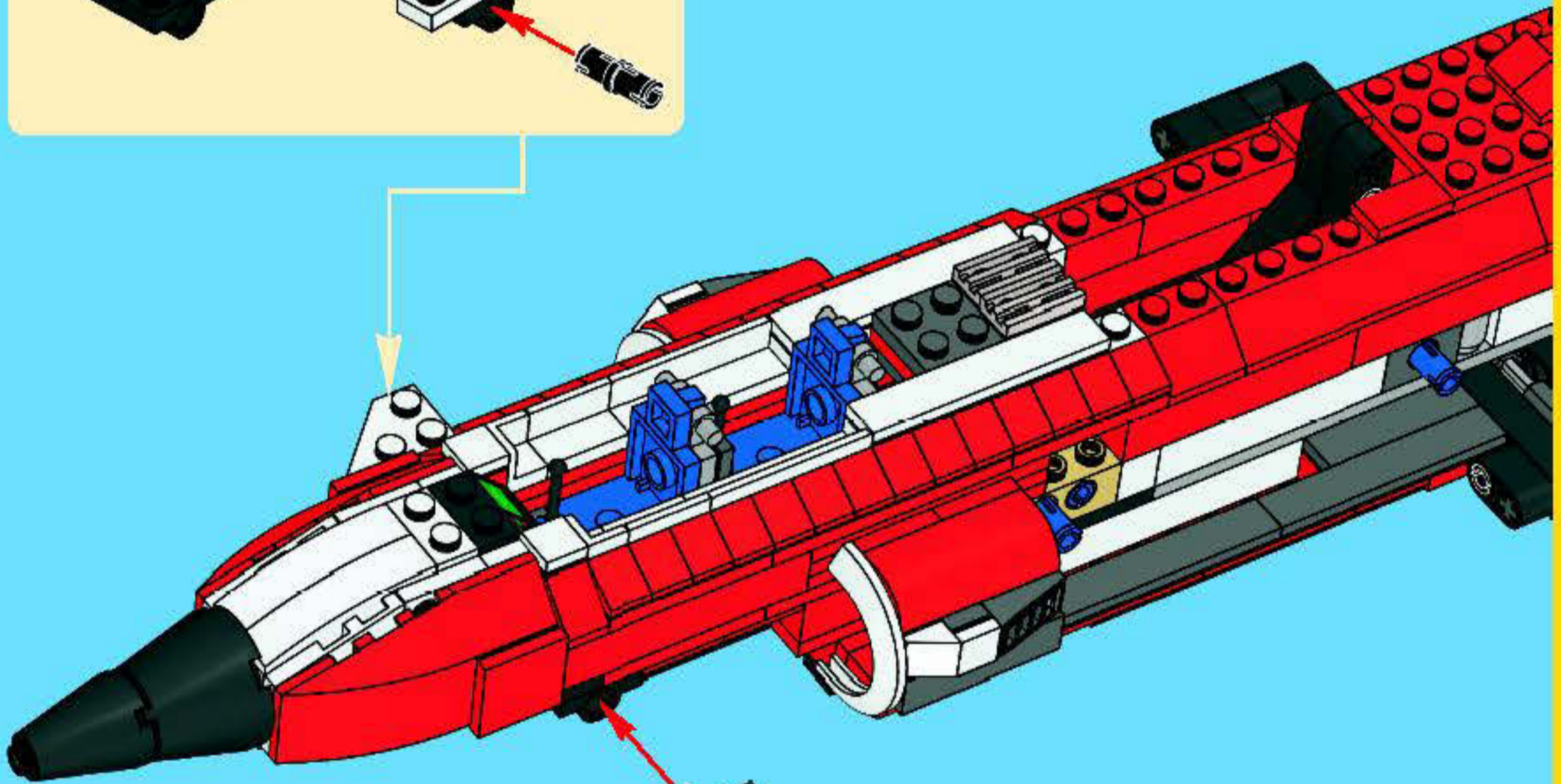

1



2









1x

5



1x

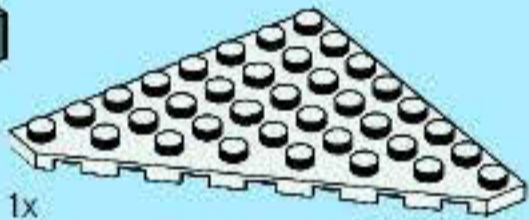

1x

6

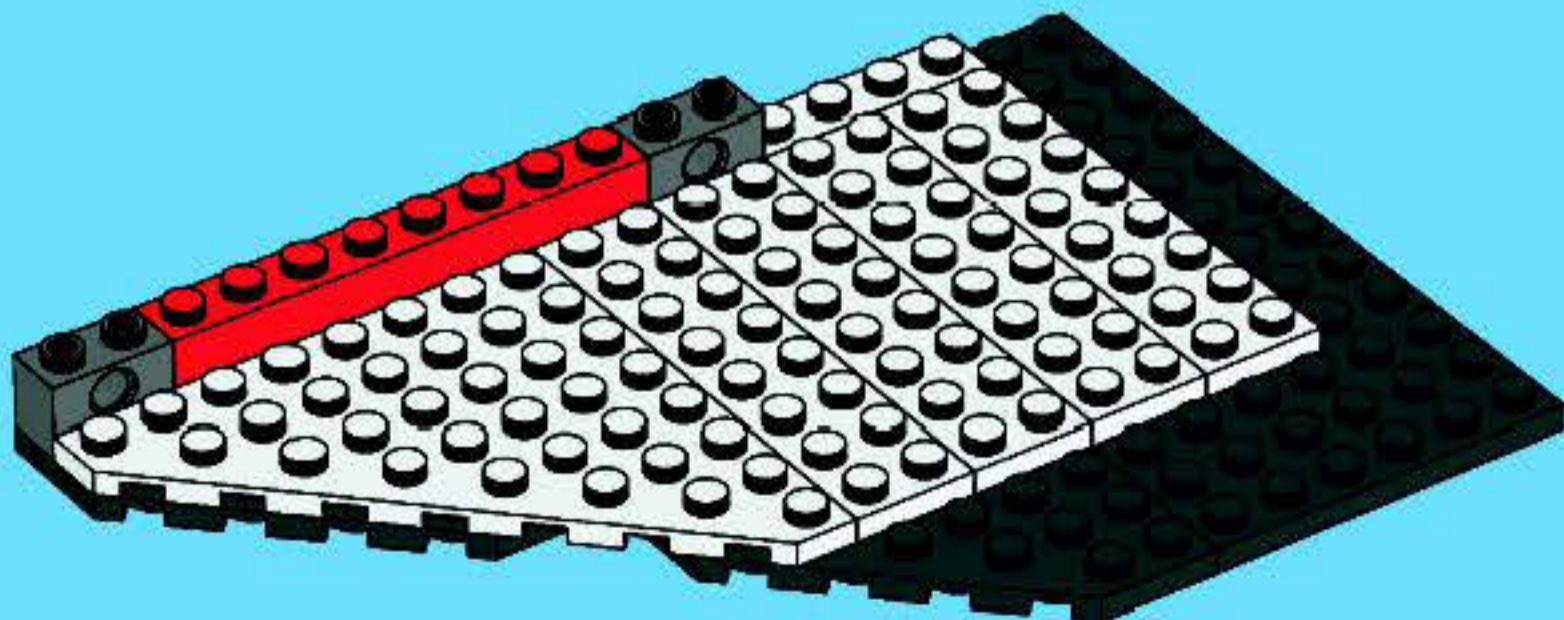





1x

7

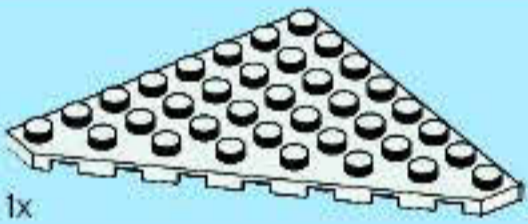
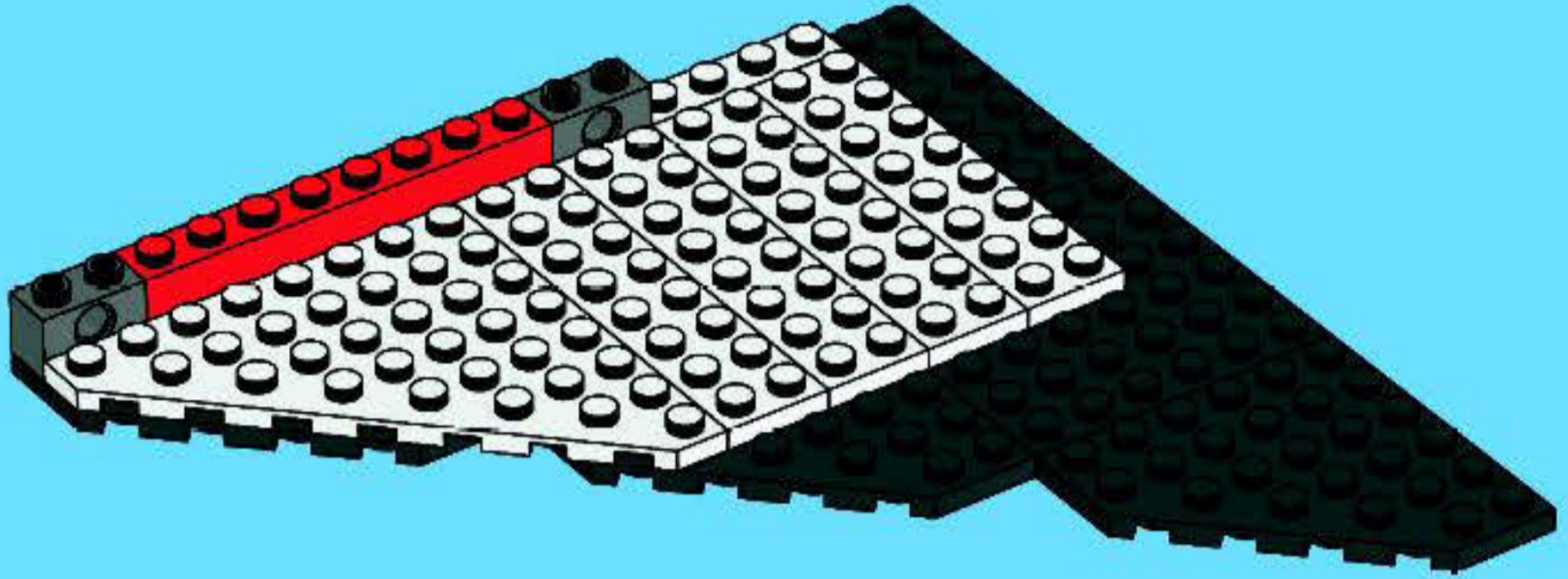

1x

8

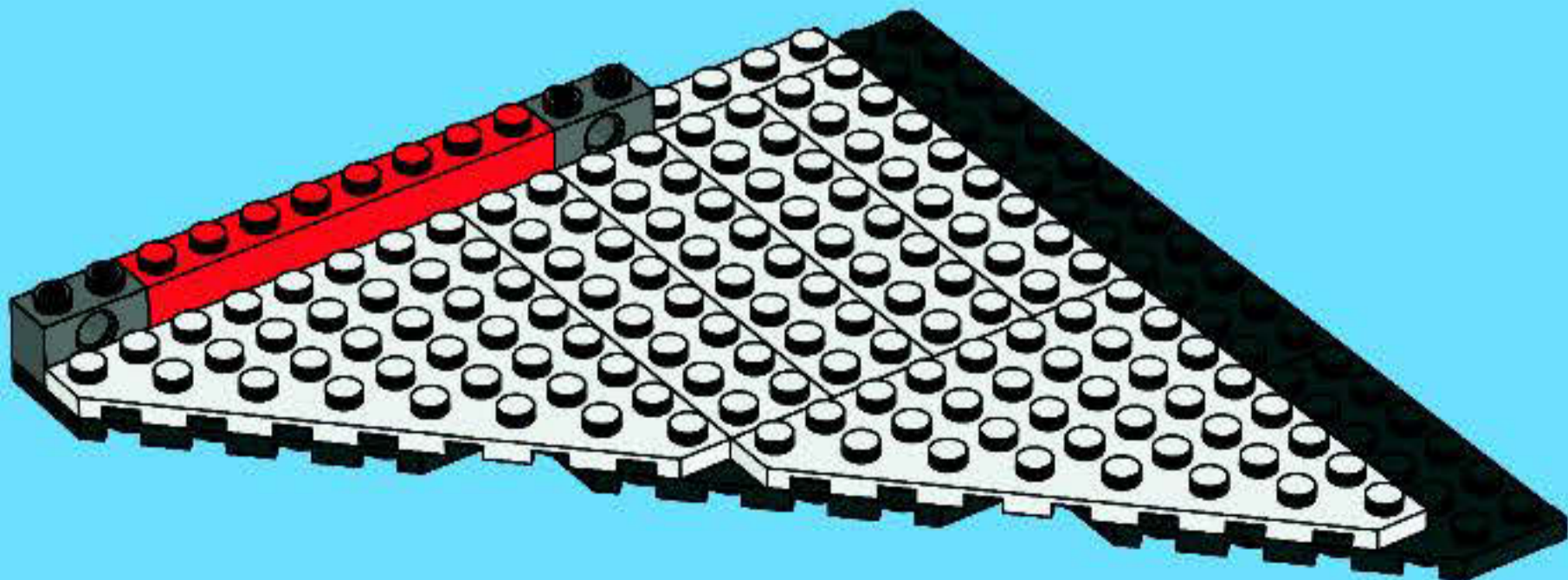

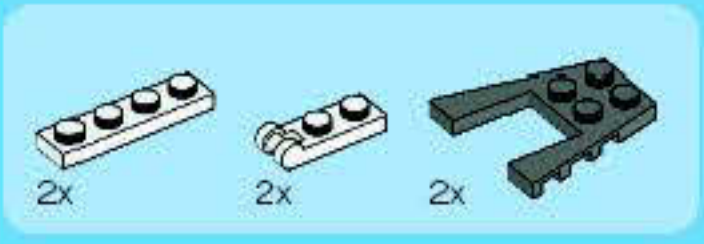

9

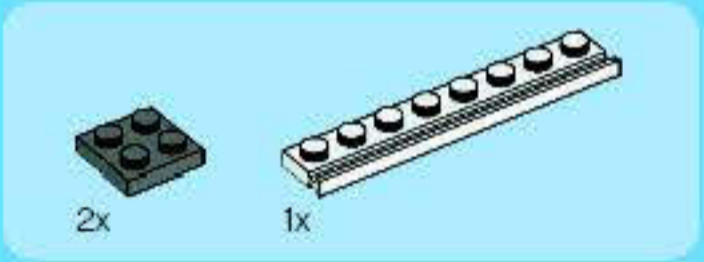
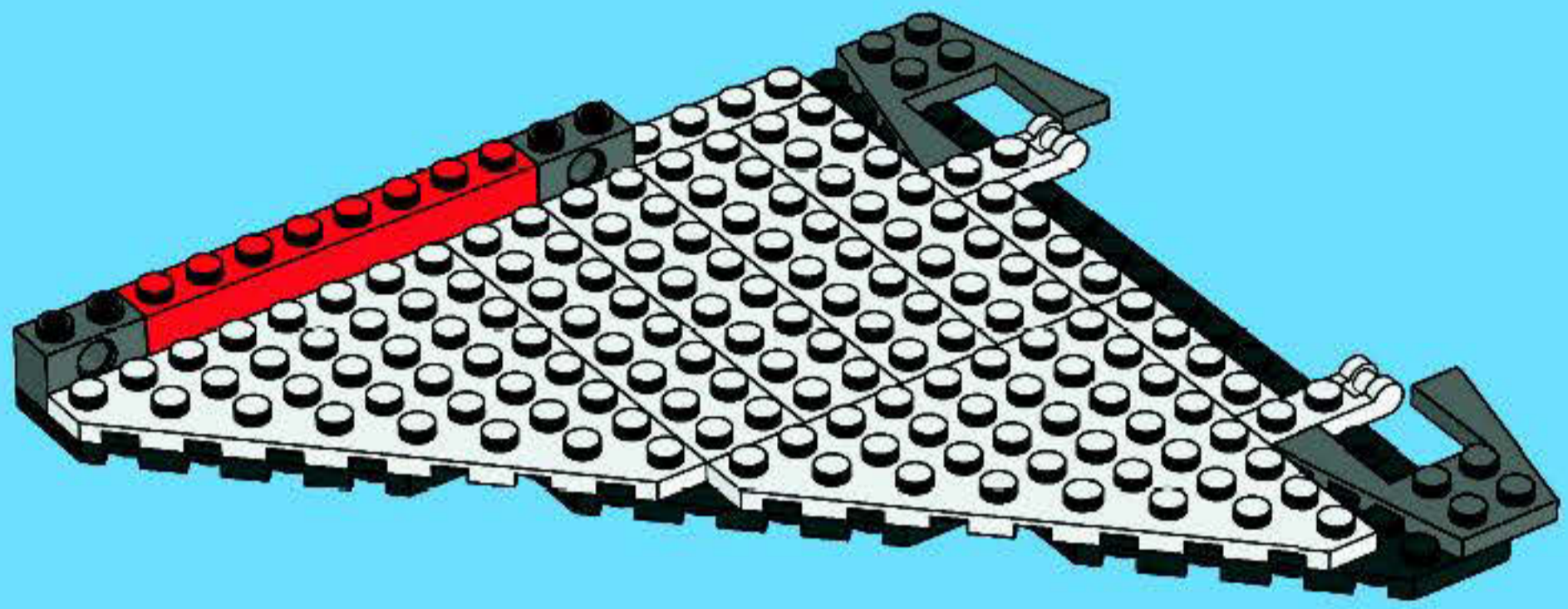

10

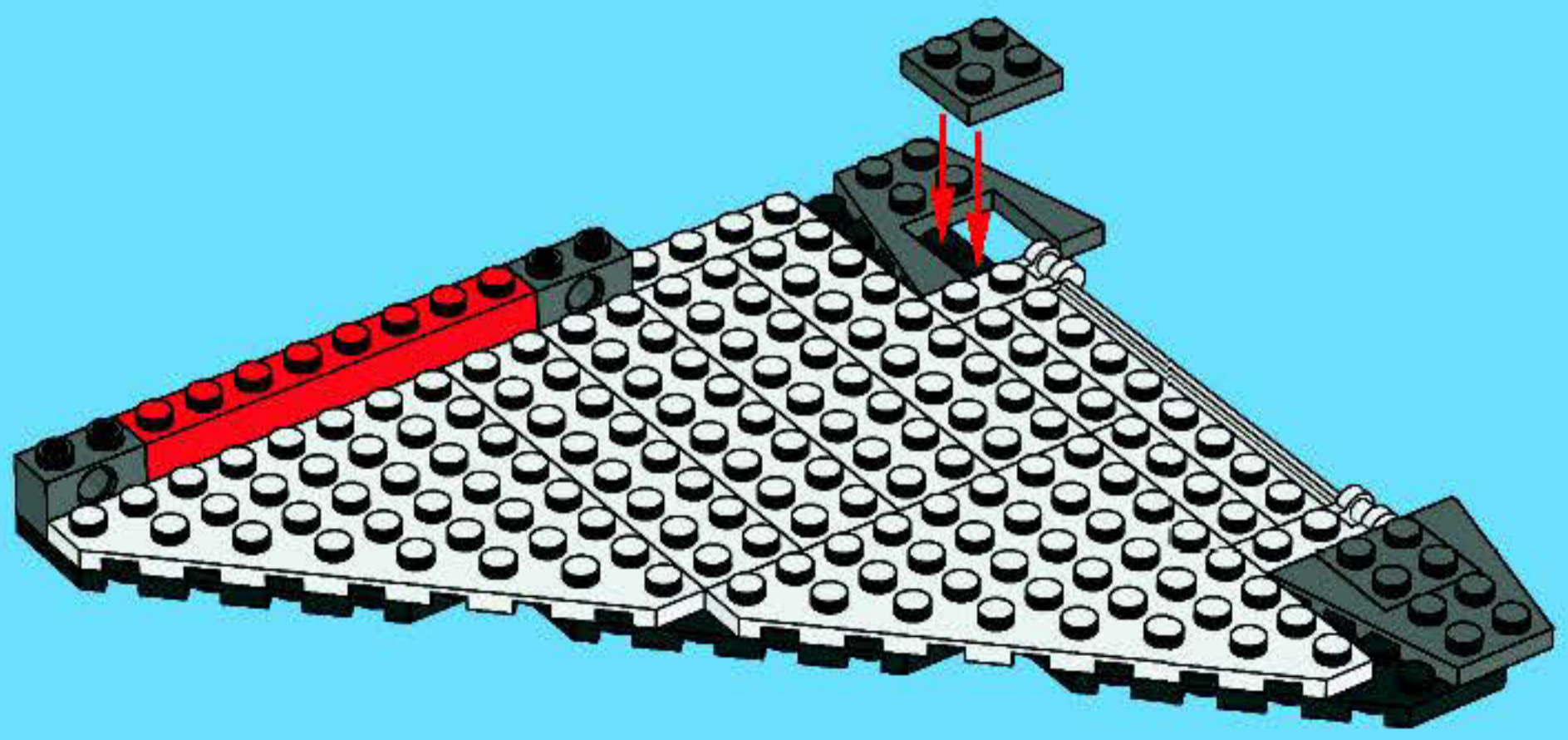

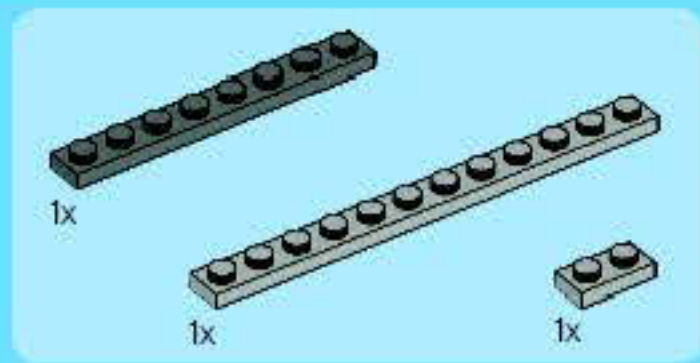

11

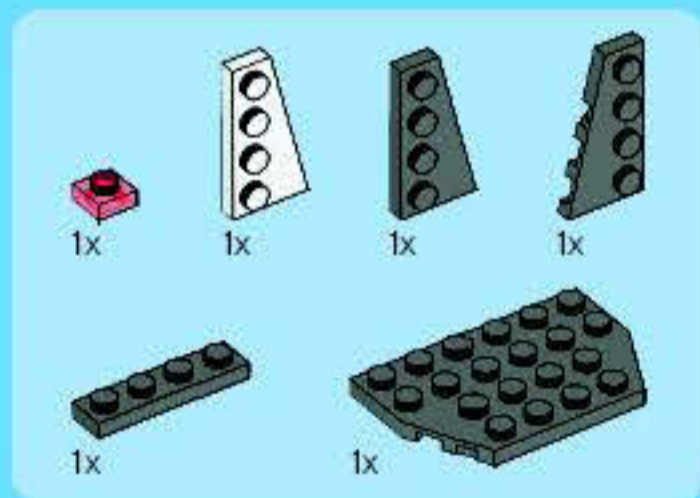
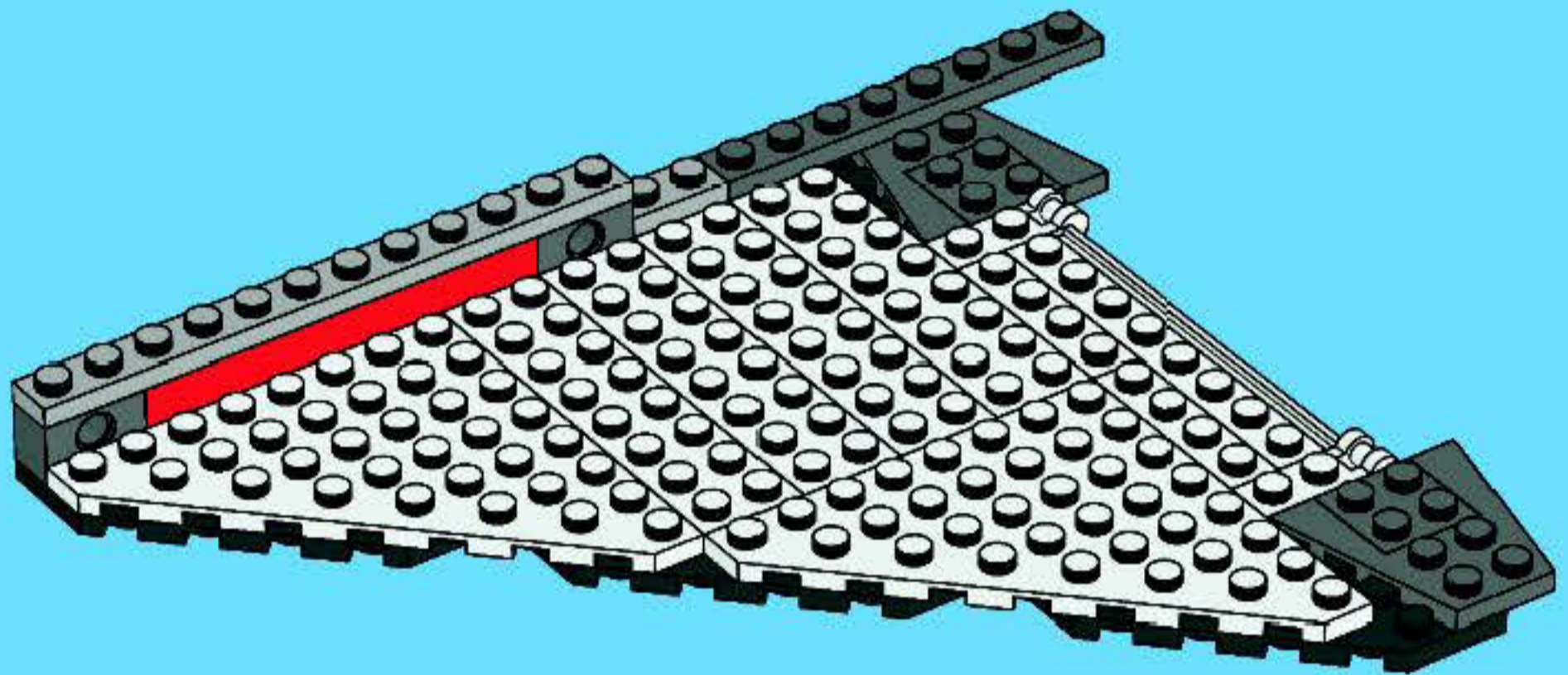

12

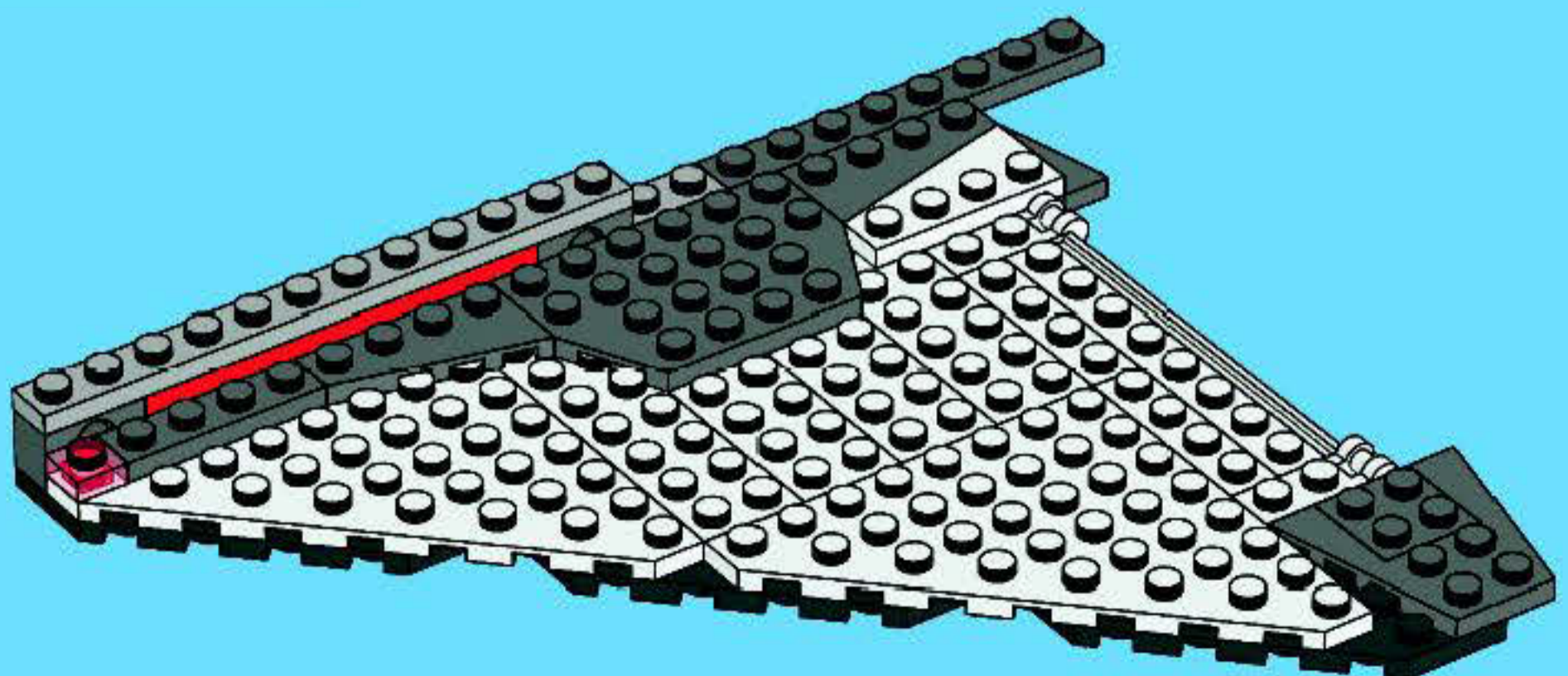

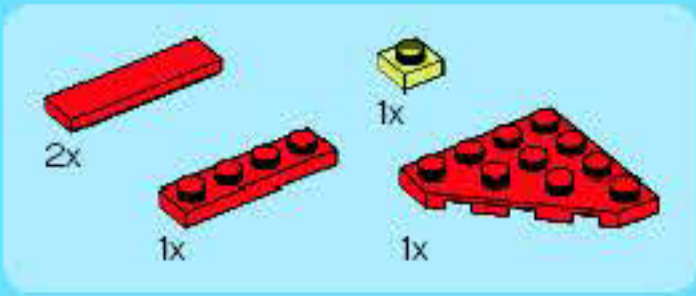

13

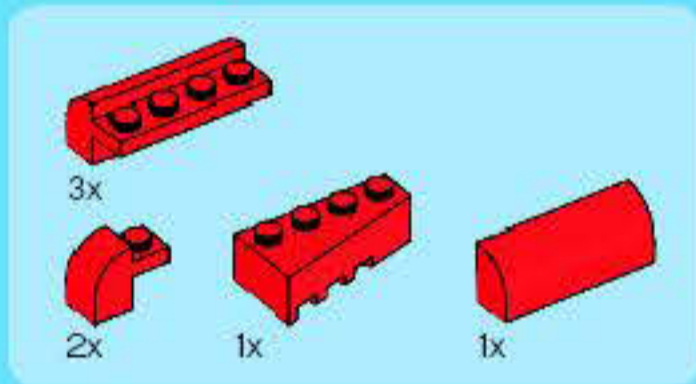
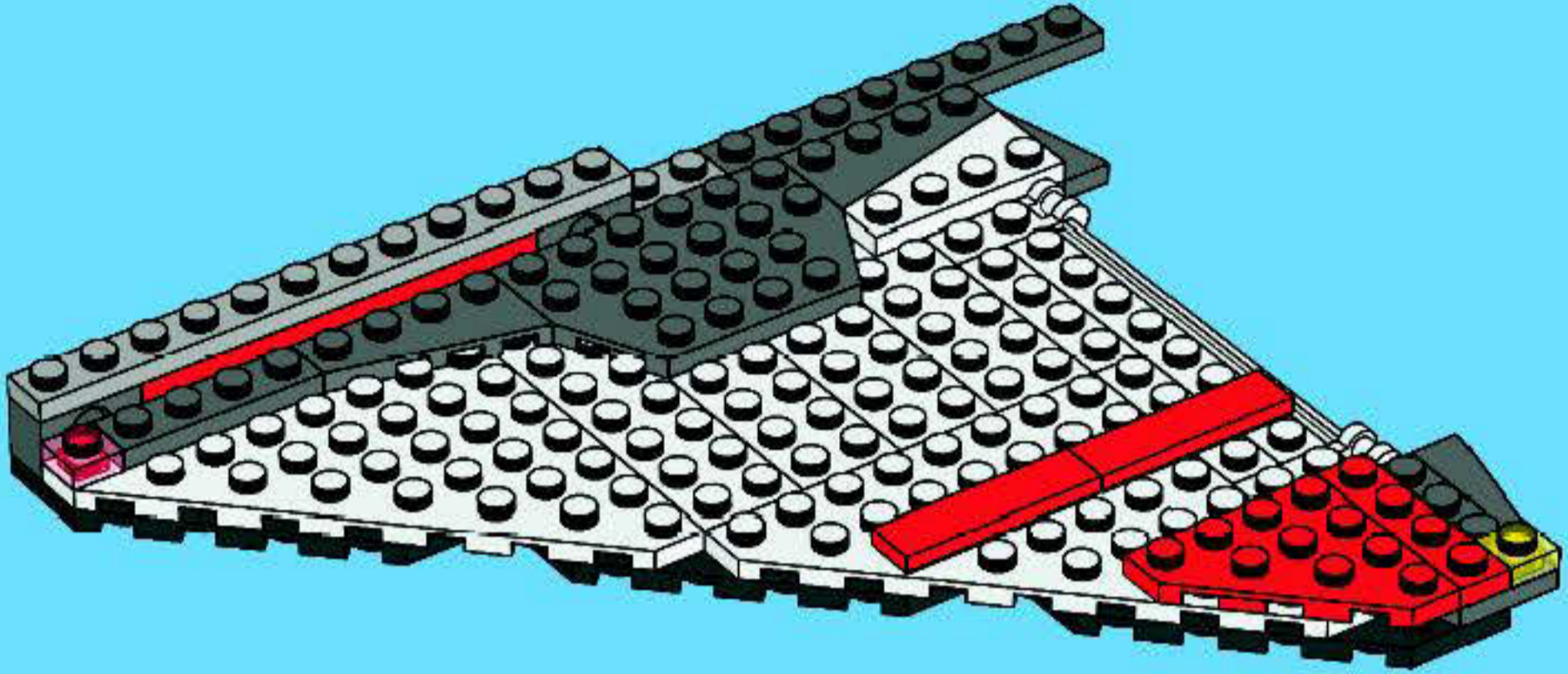

14

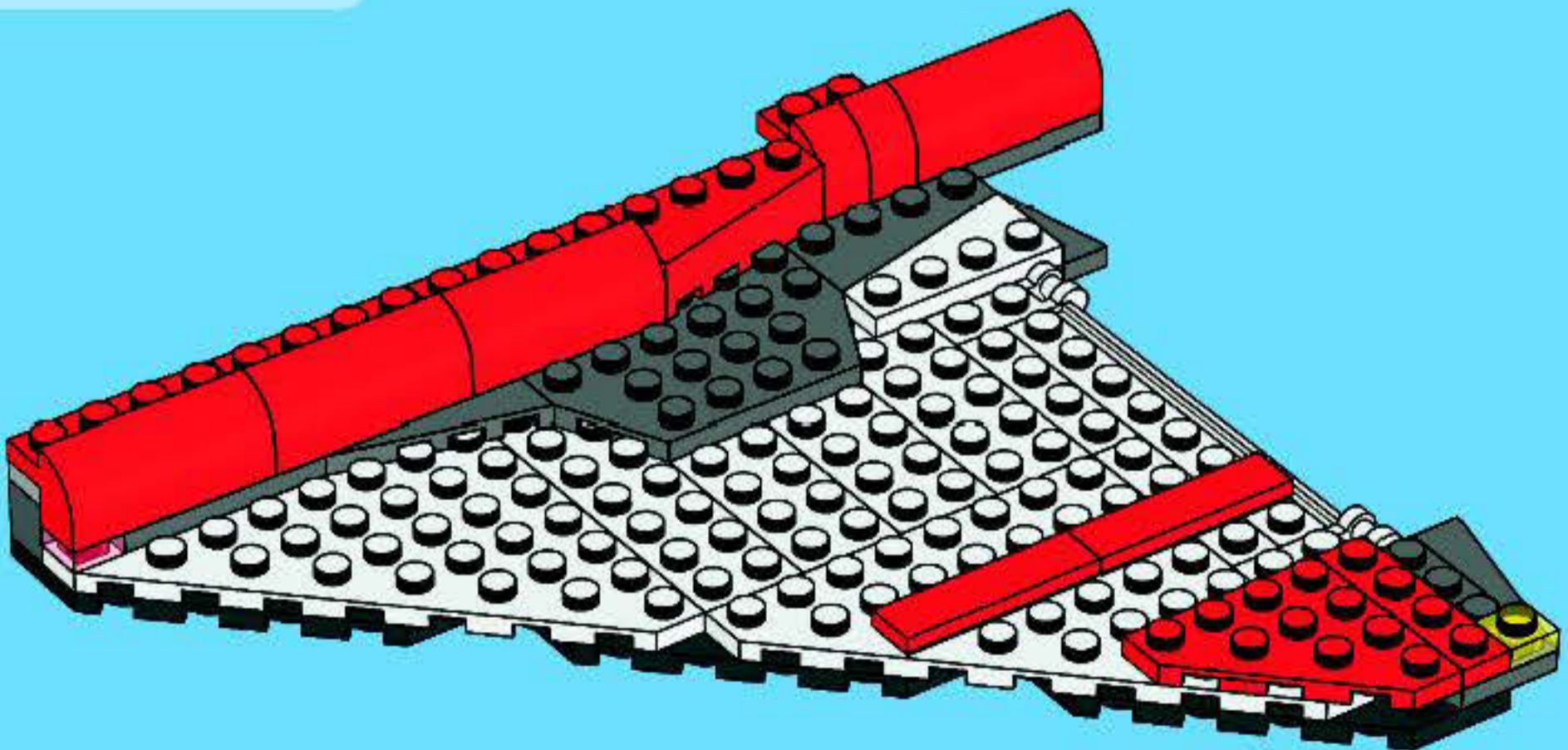

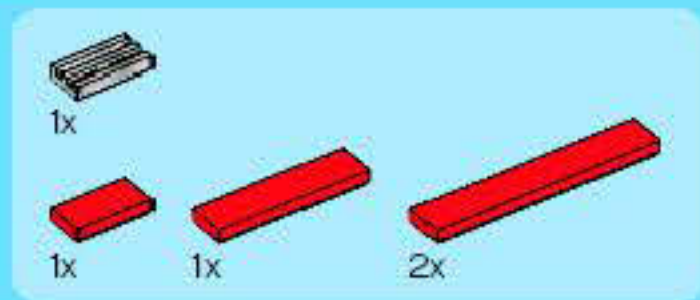

15

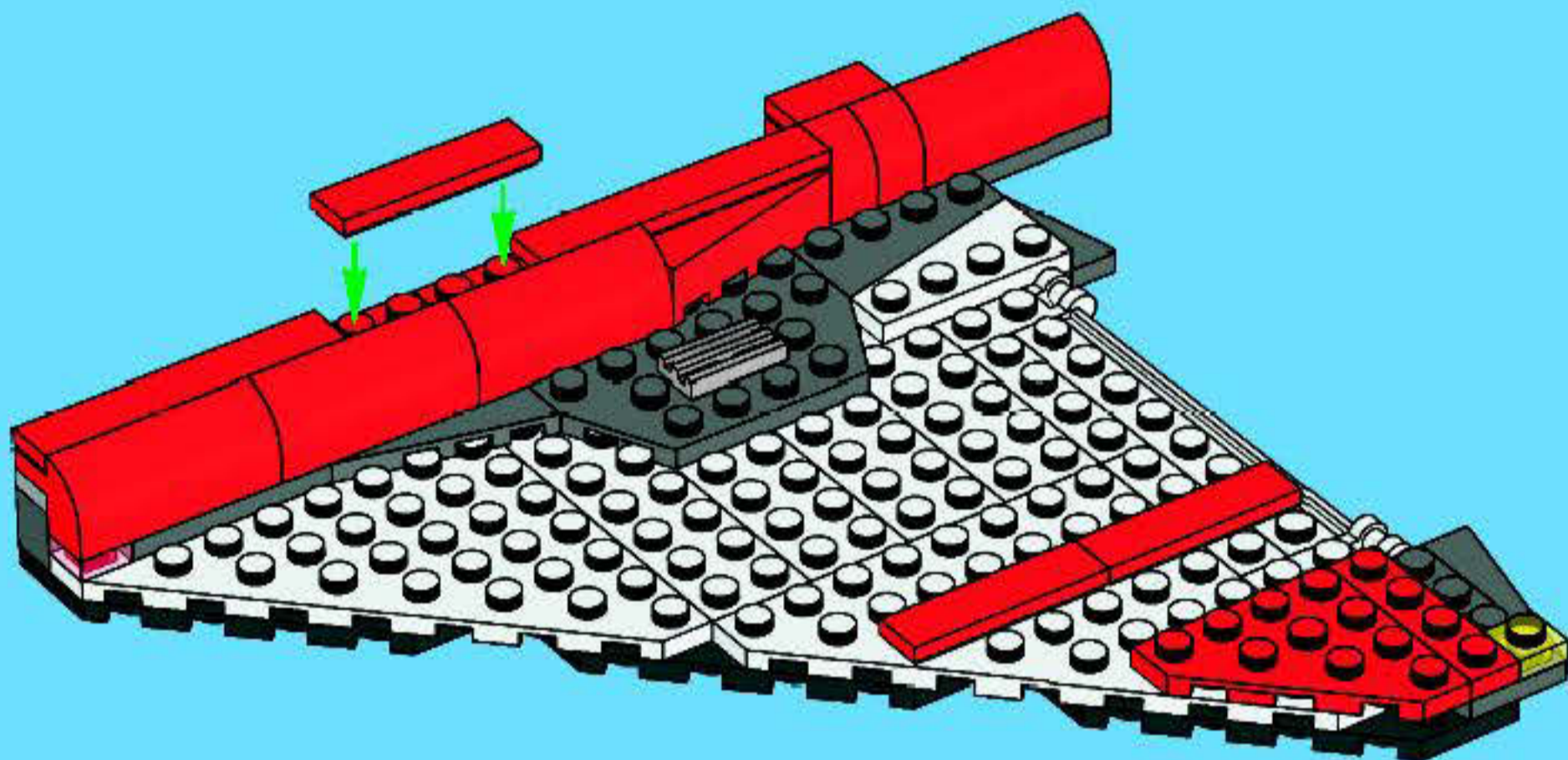

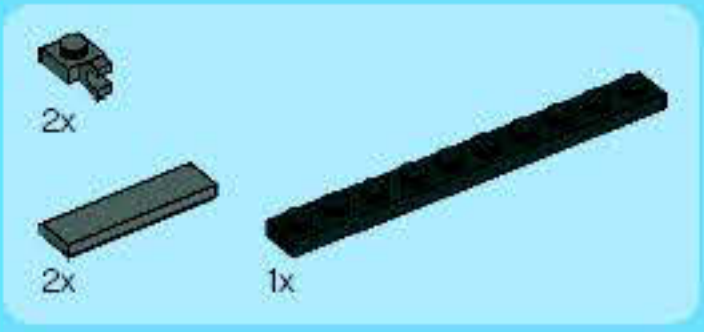

16

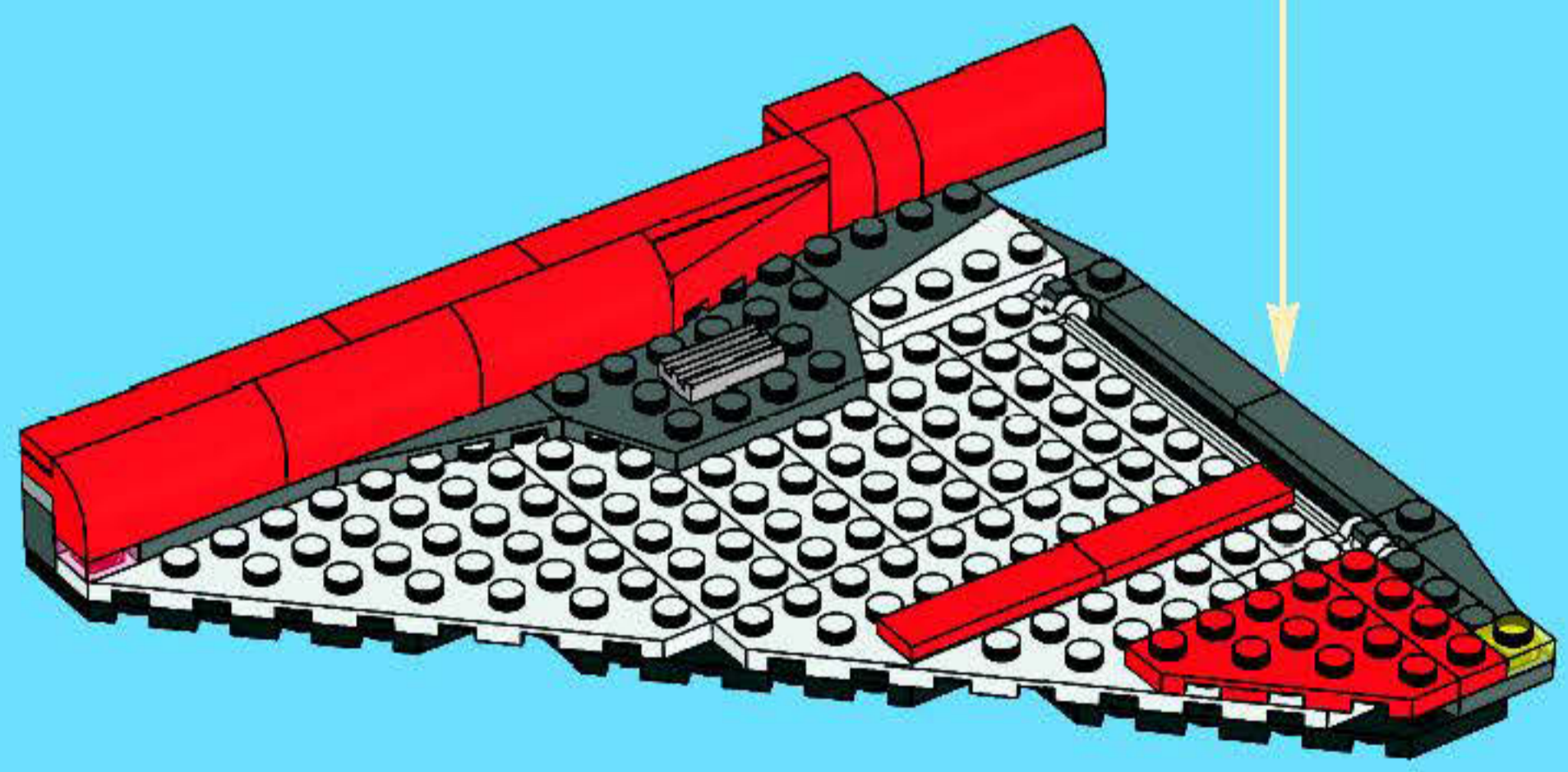
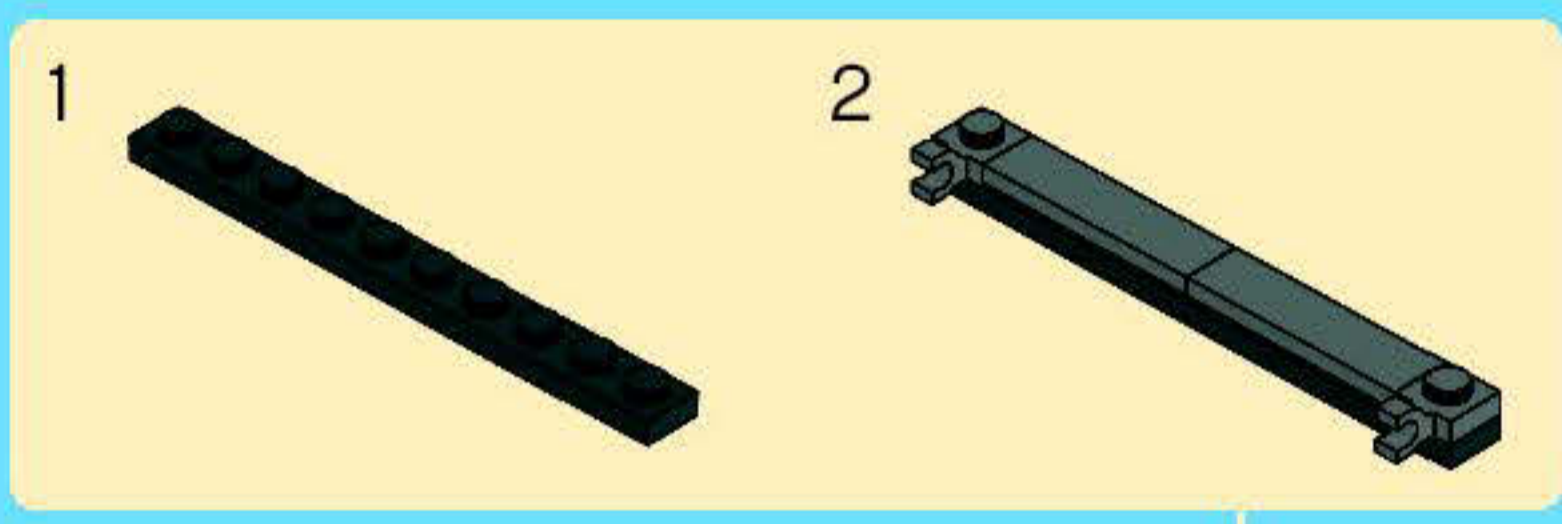

44

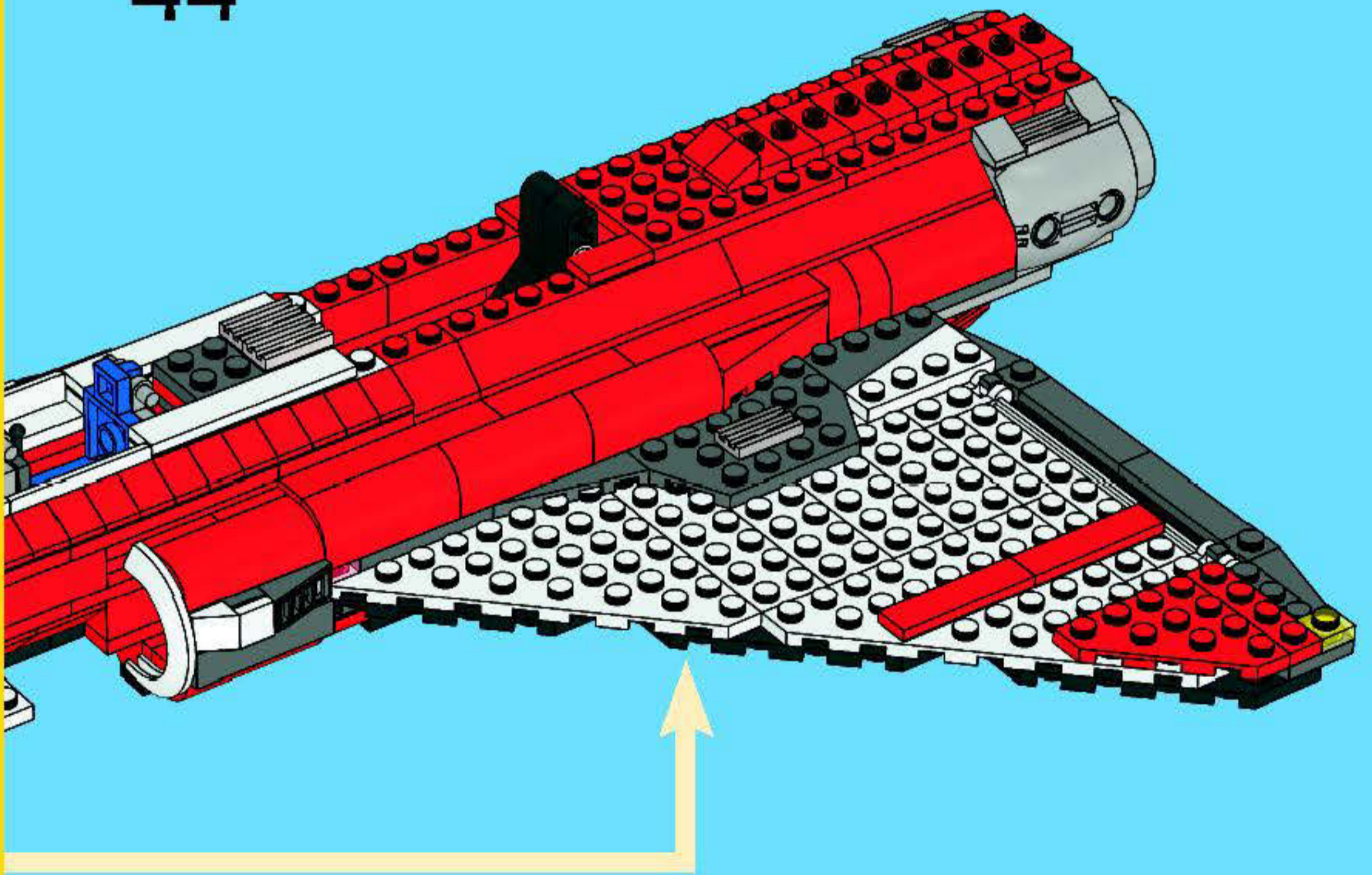







1x

3

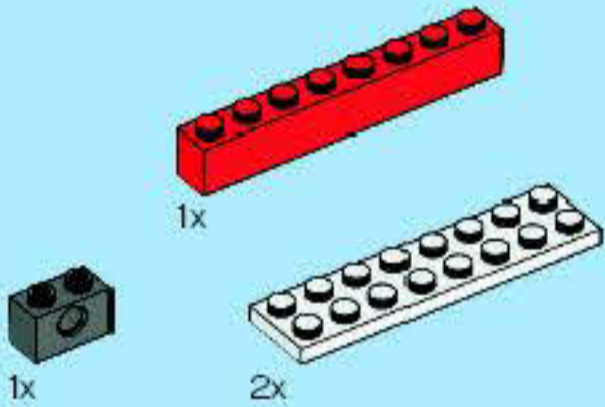
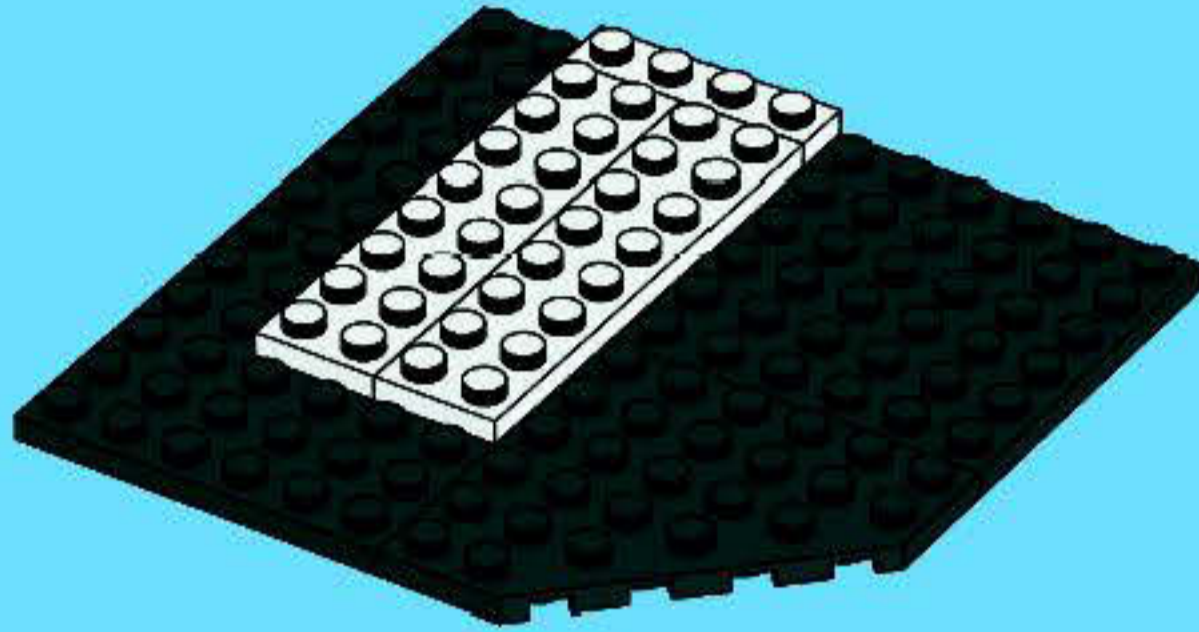

1x

1x

2x

4

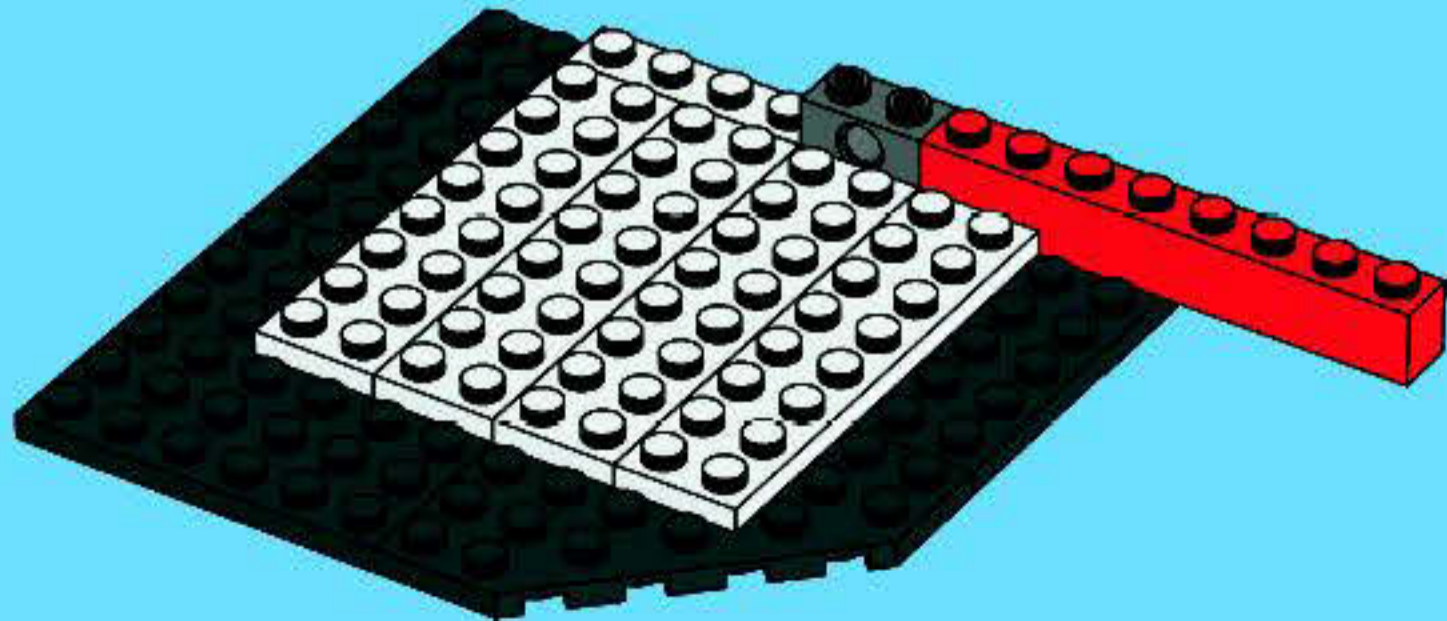



1x

5

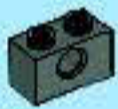

1x

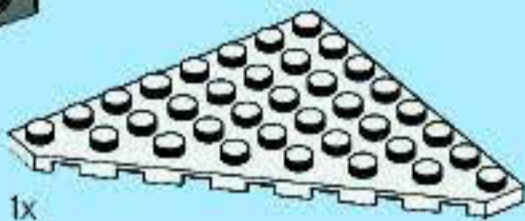

1x

6

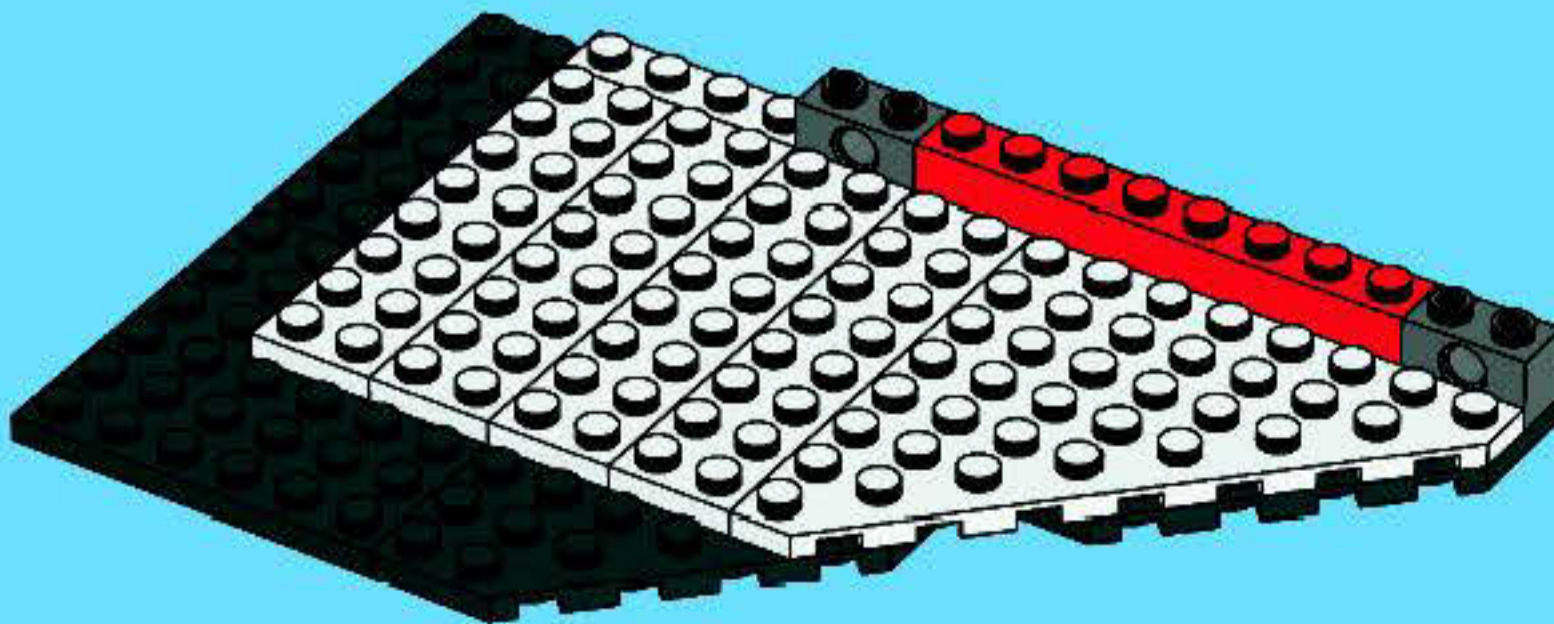



1x

7

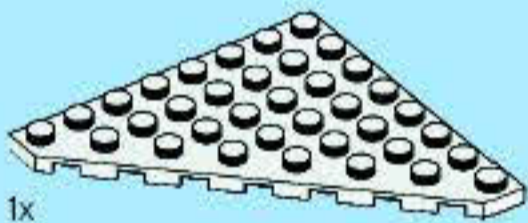
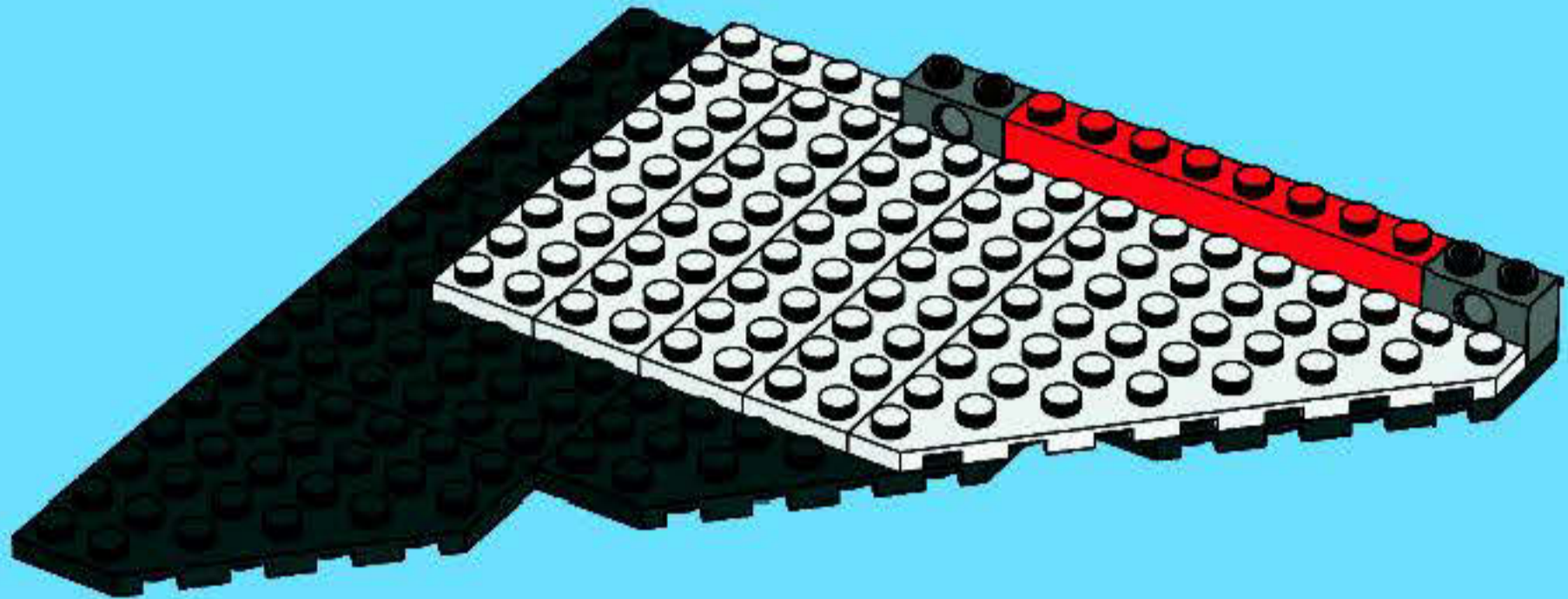

1x

8

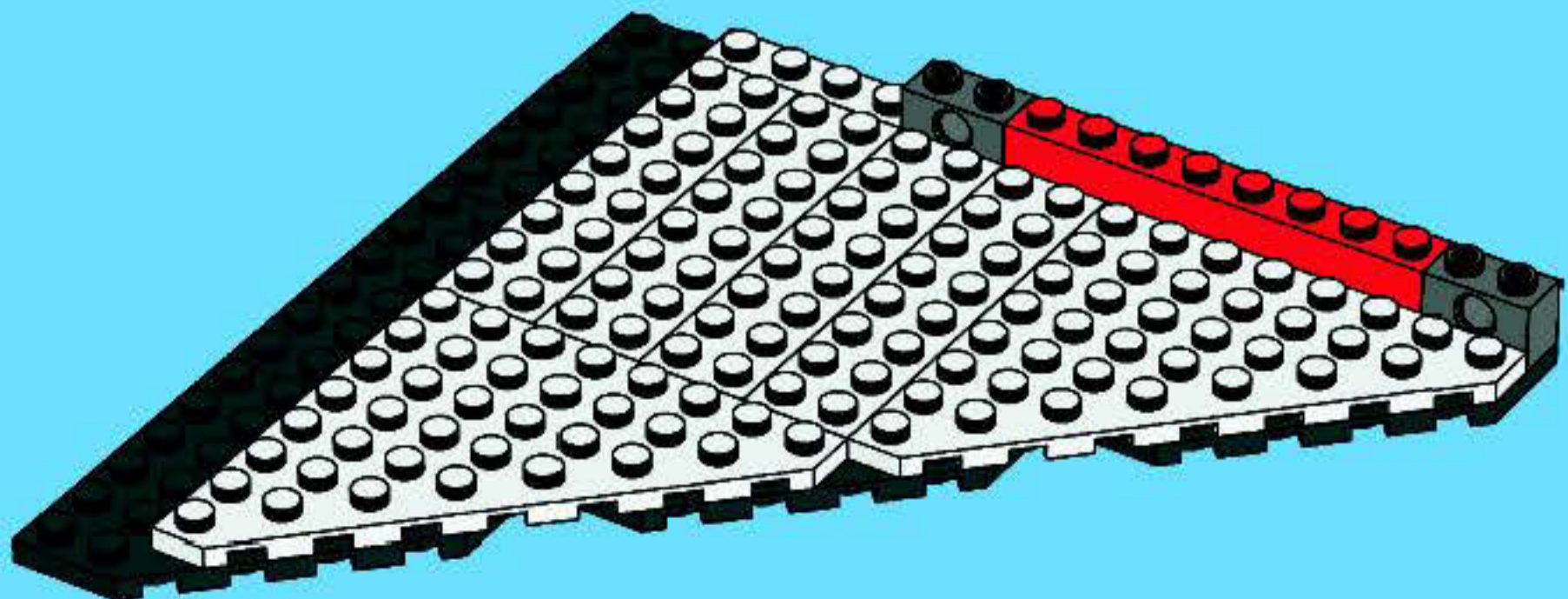

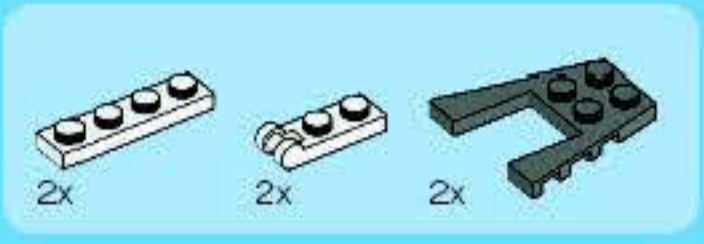

9

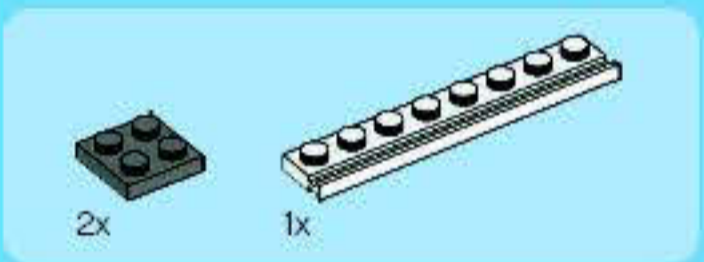
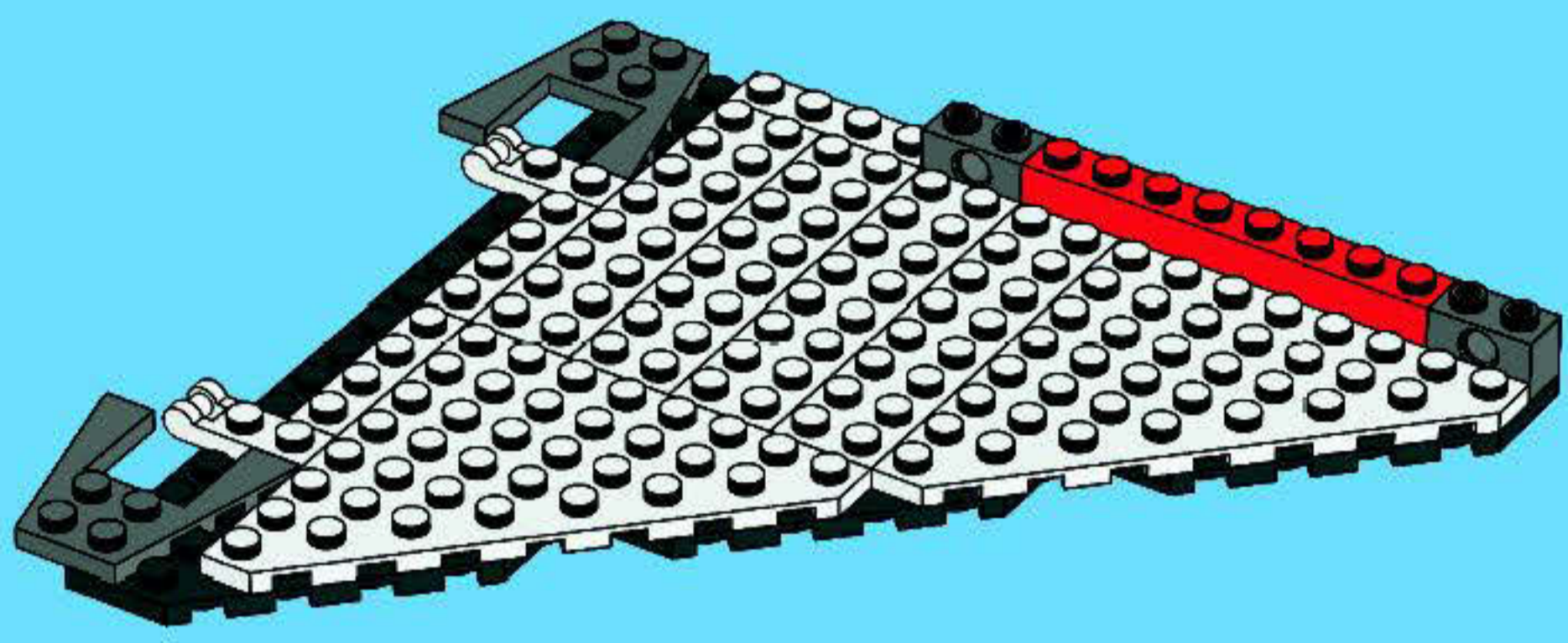

10

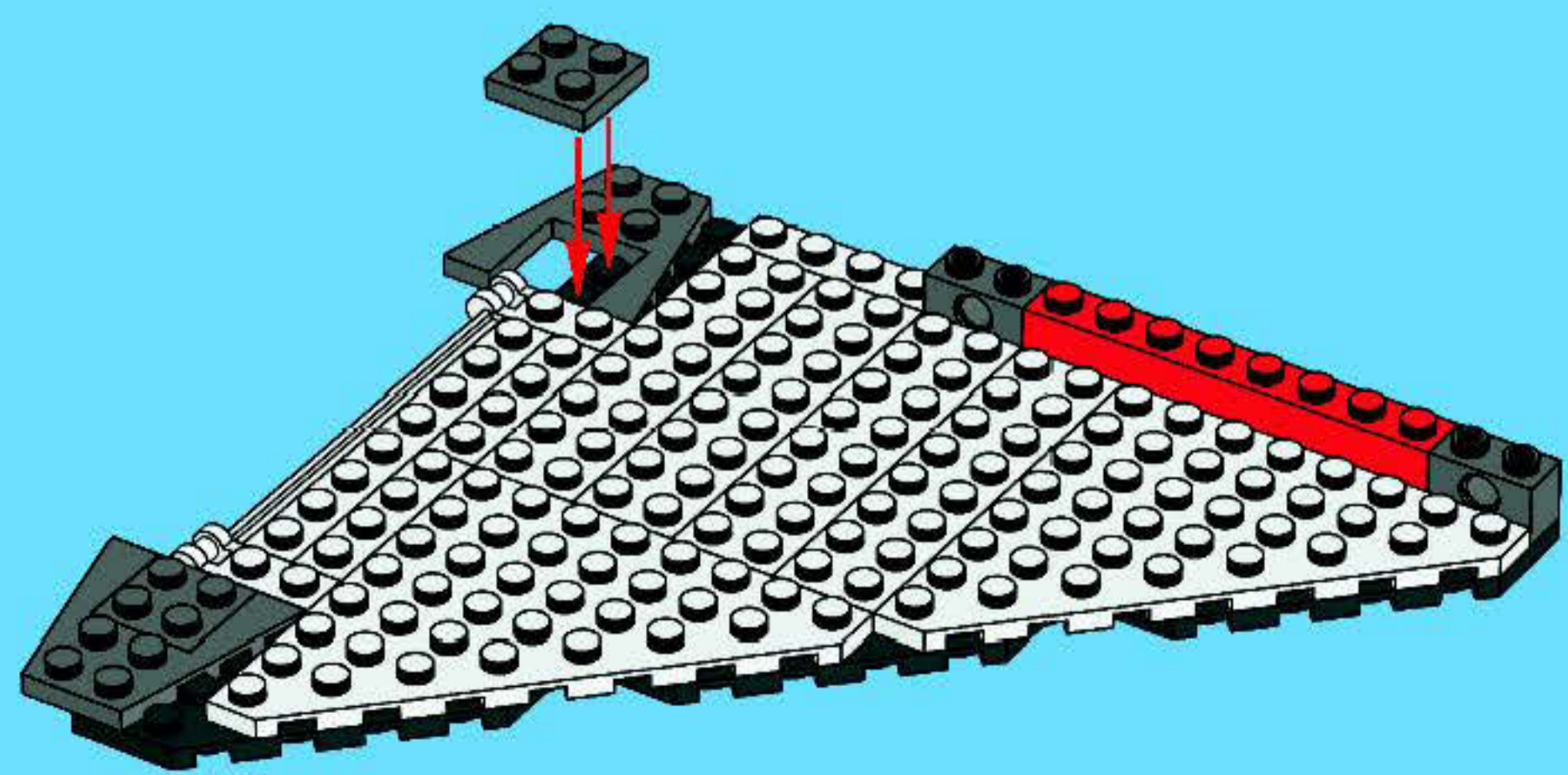

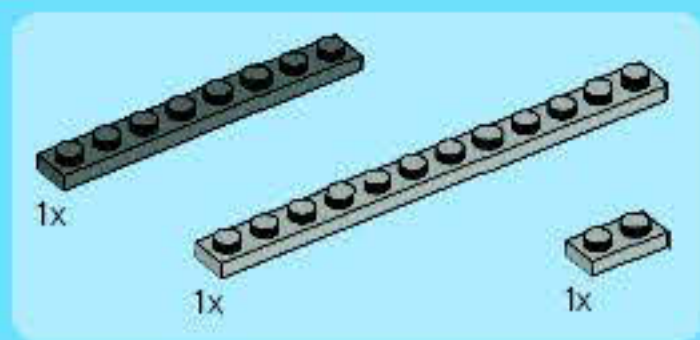

11

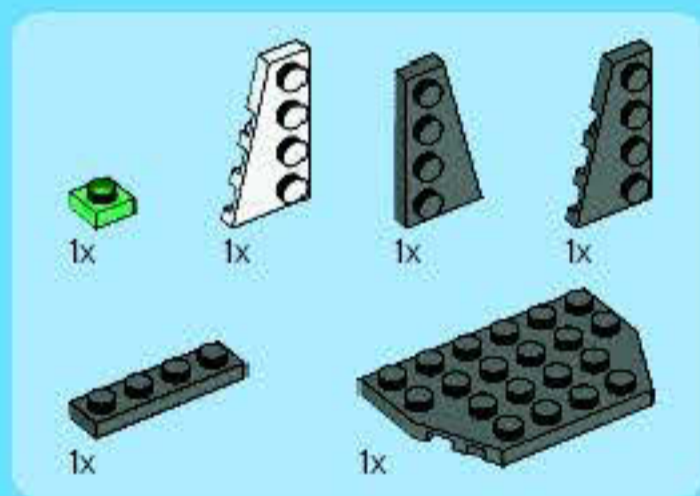
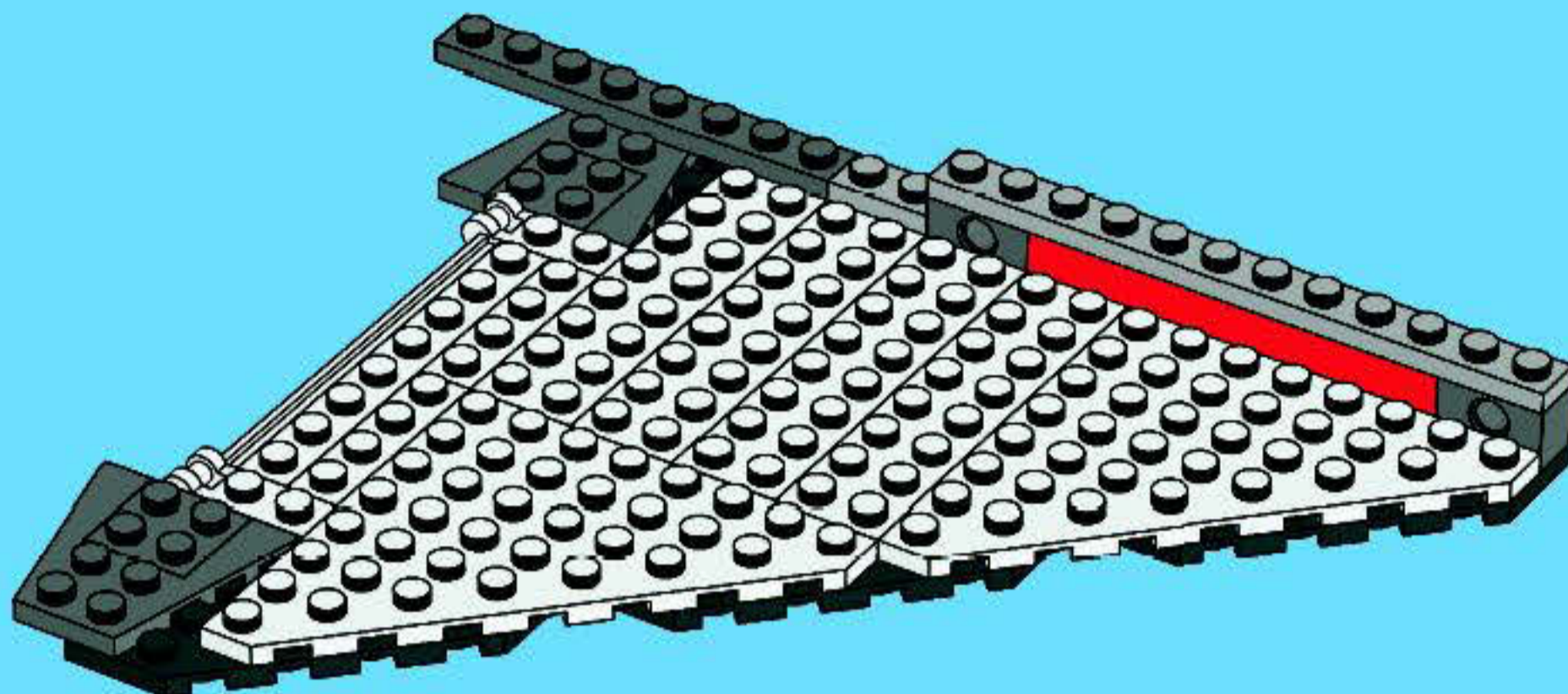

12

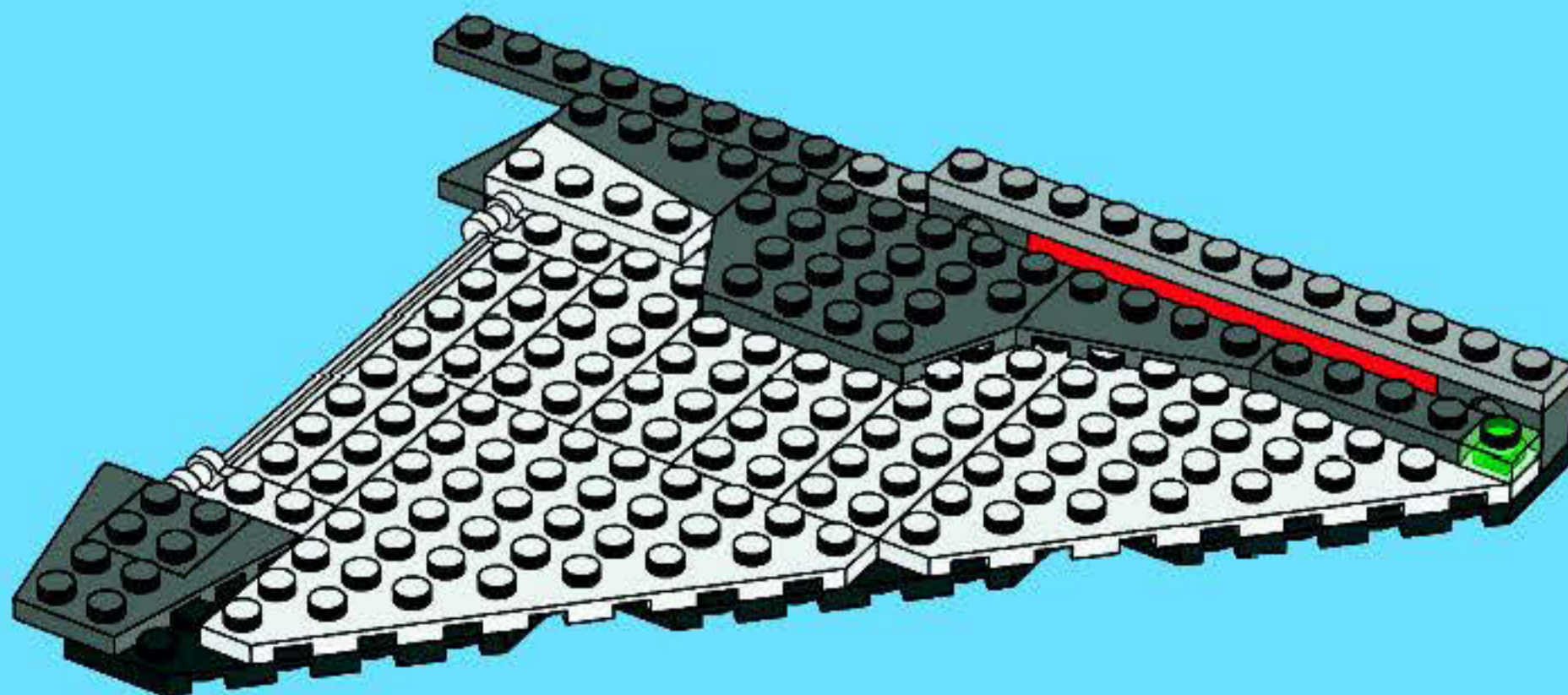

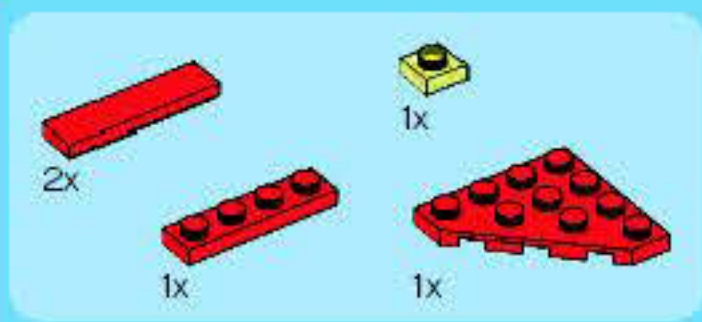

13

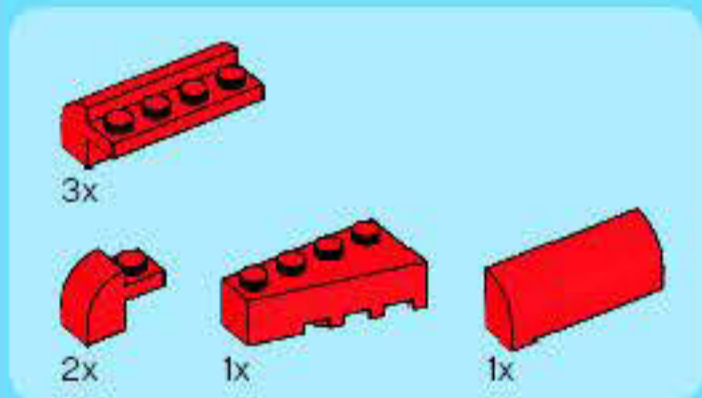
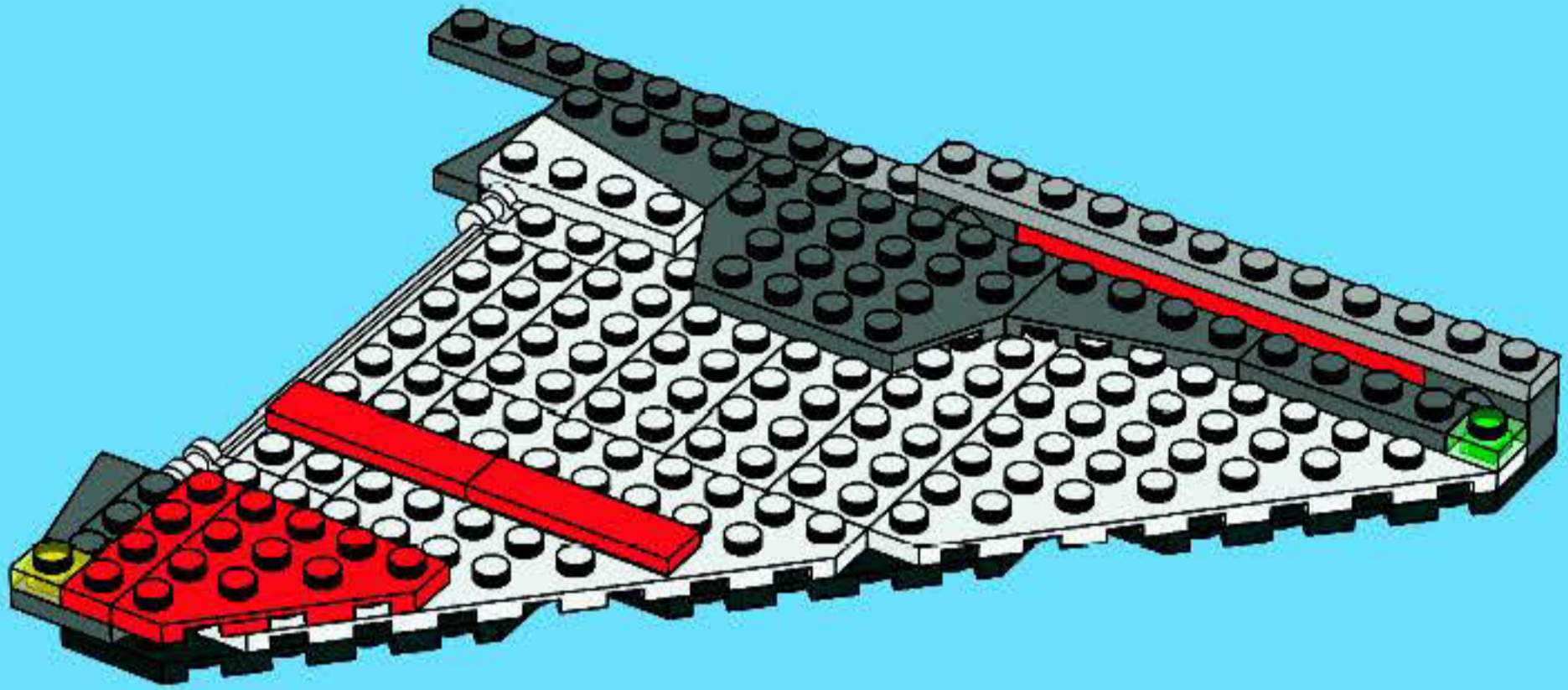

14

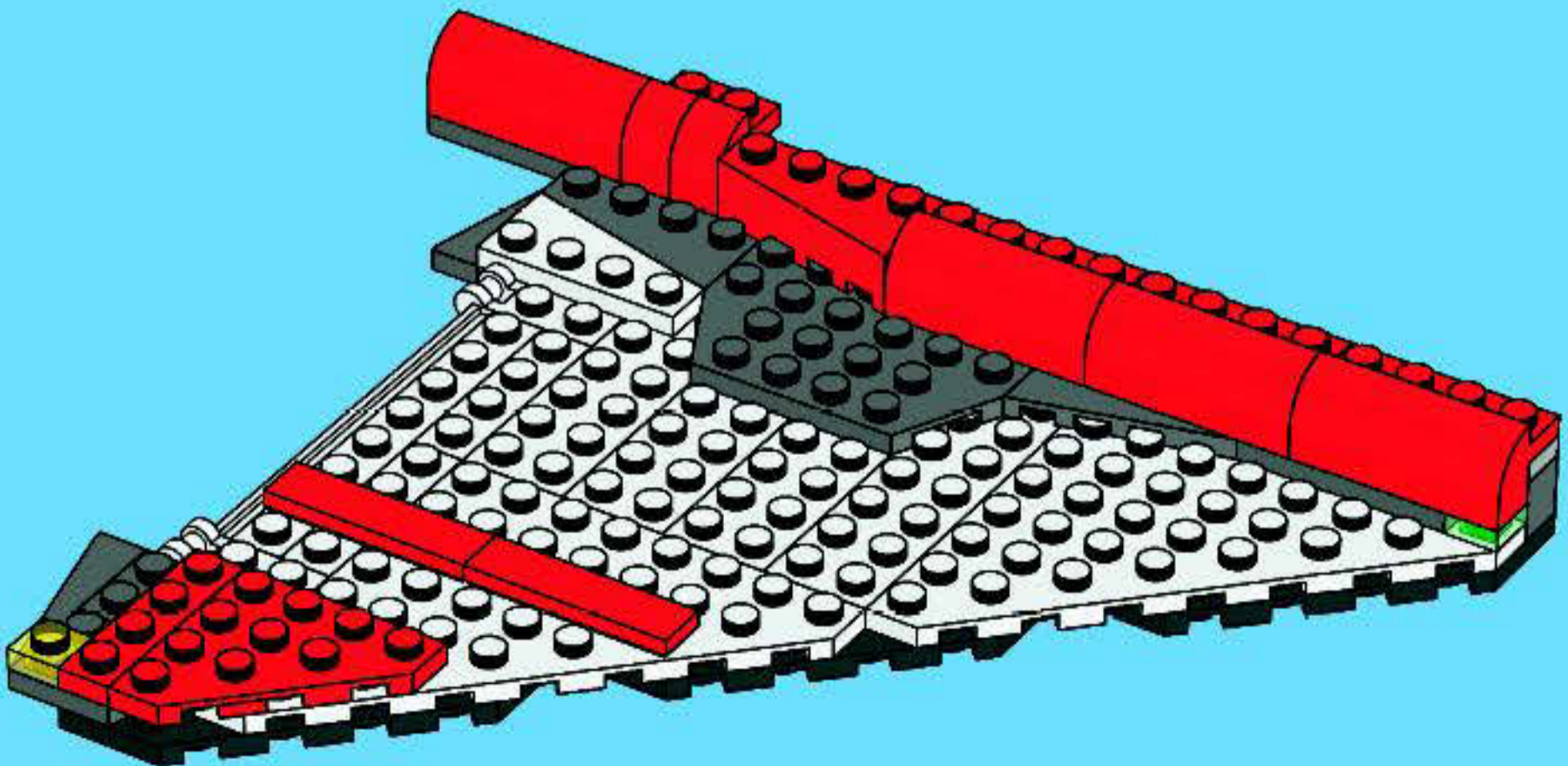

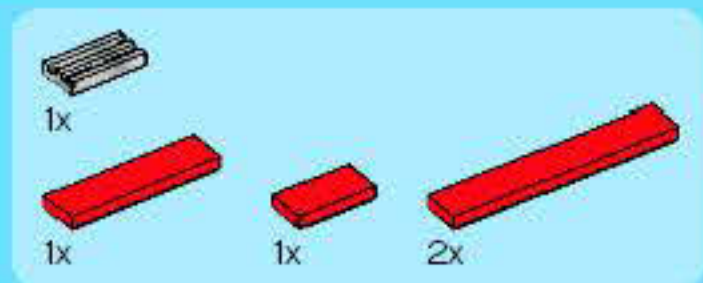

15

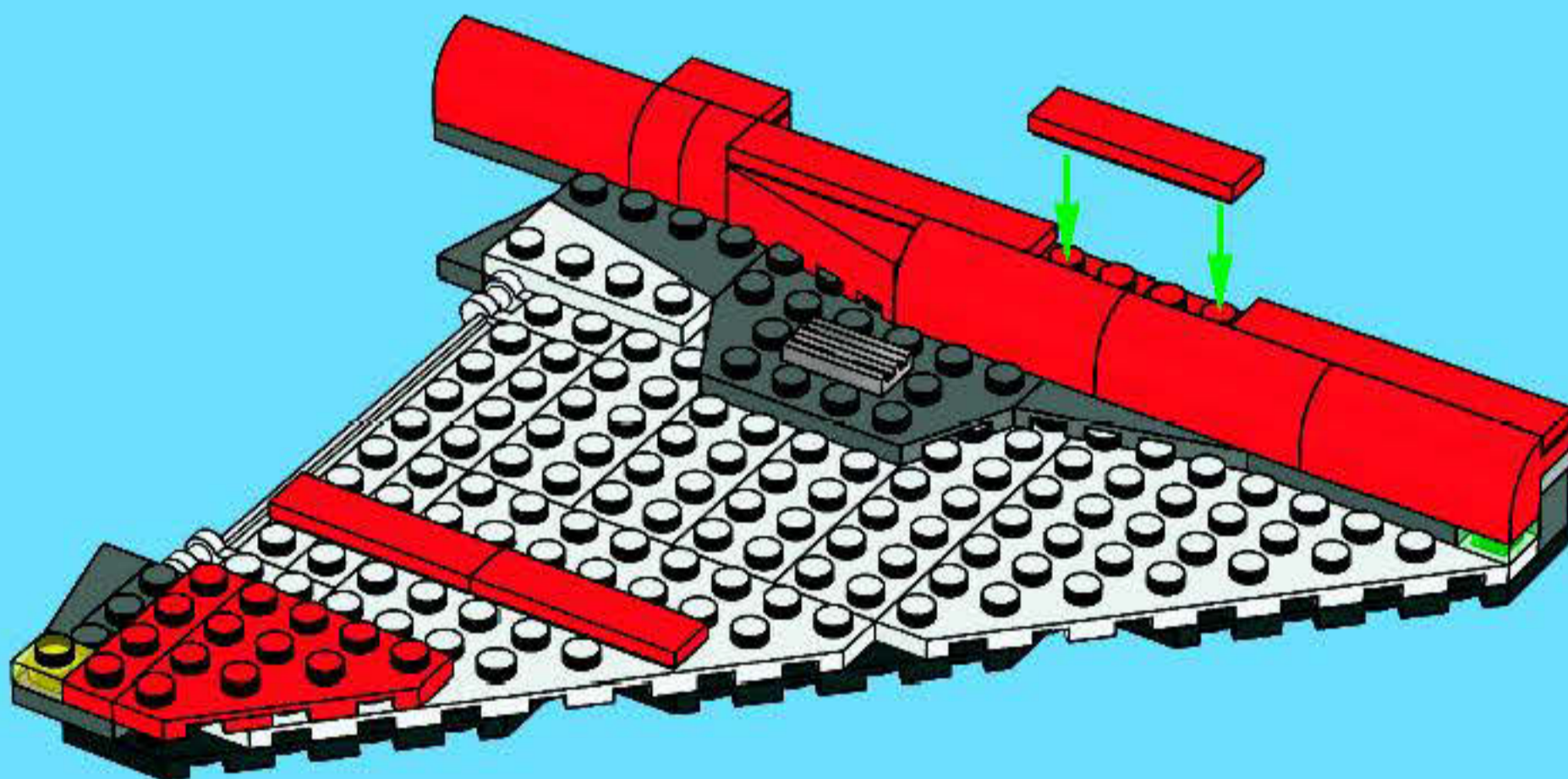

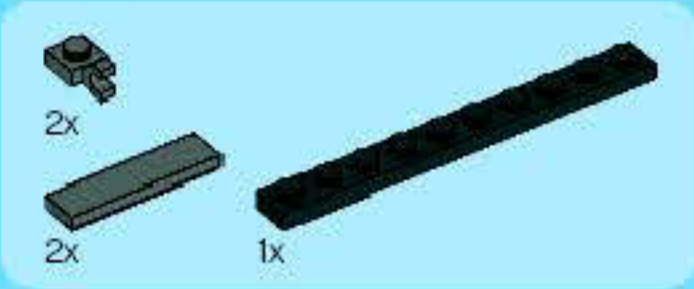

16

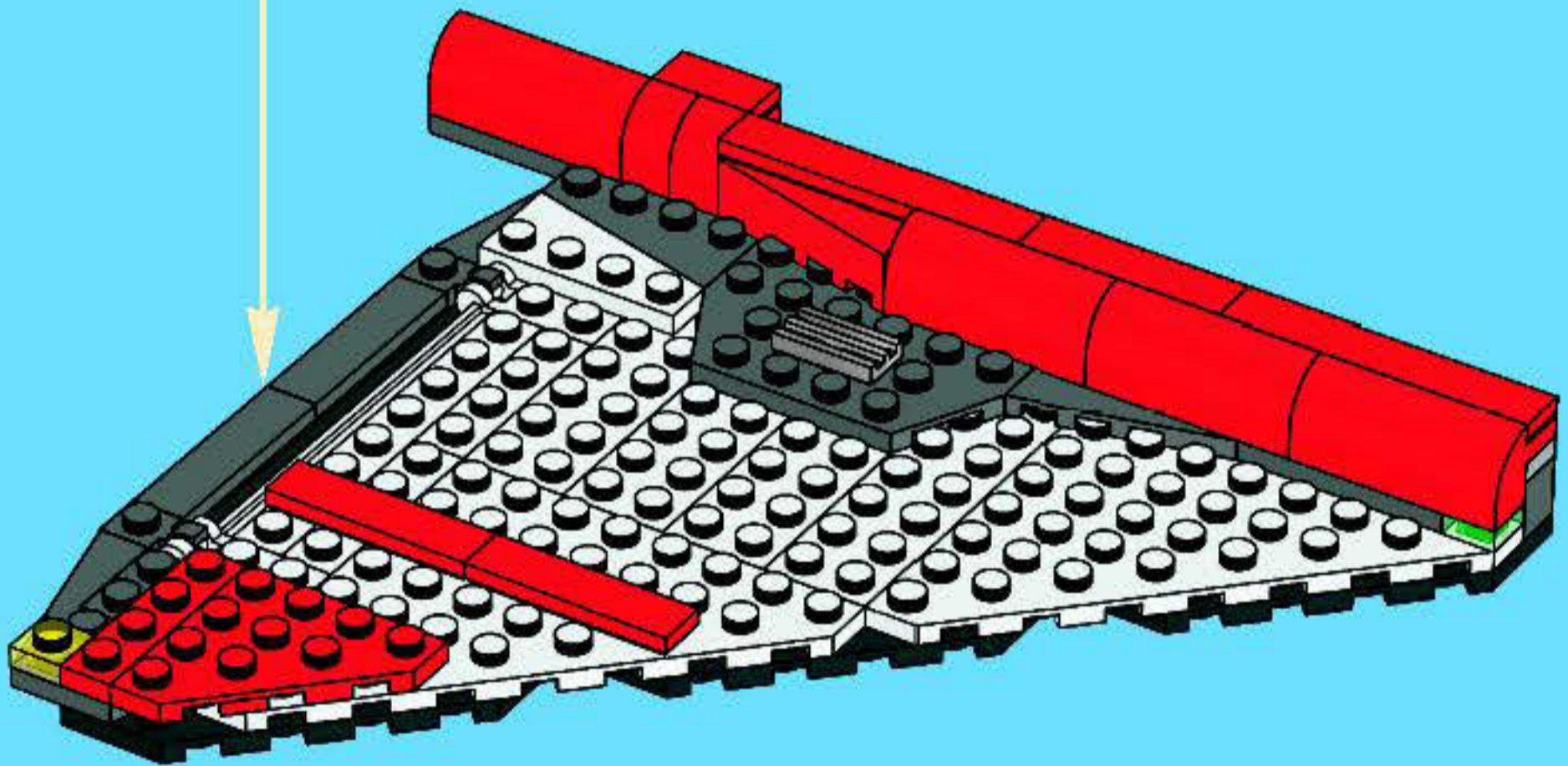
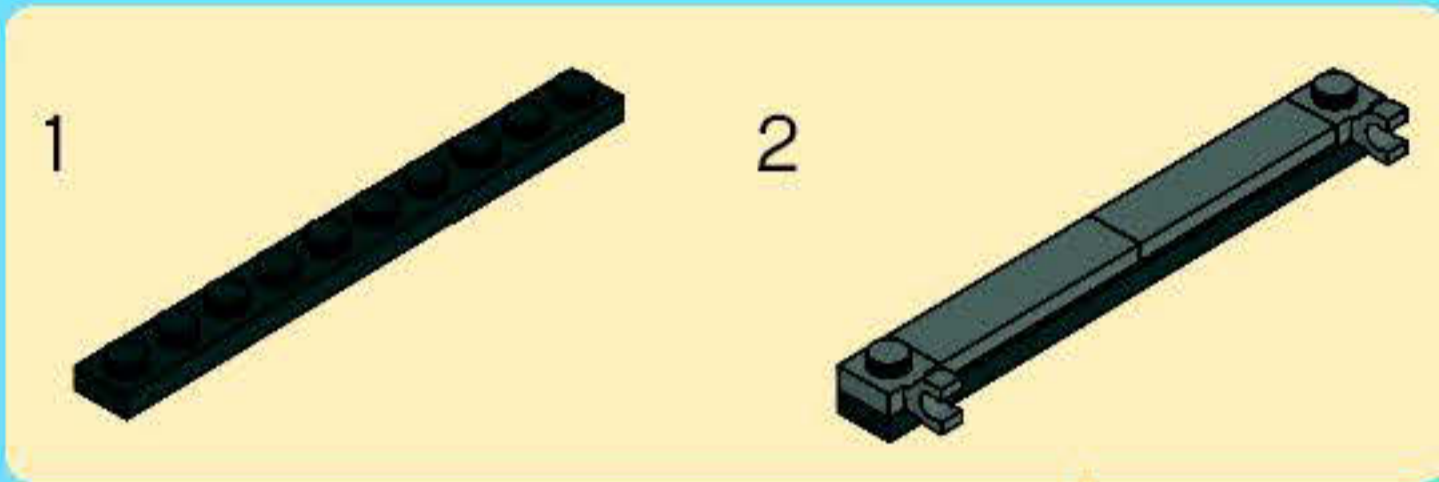



45

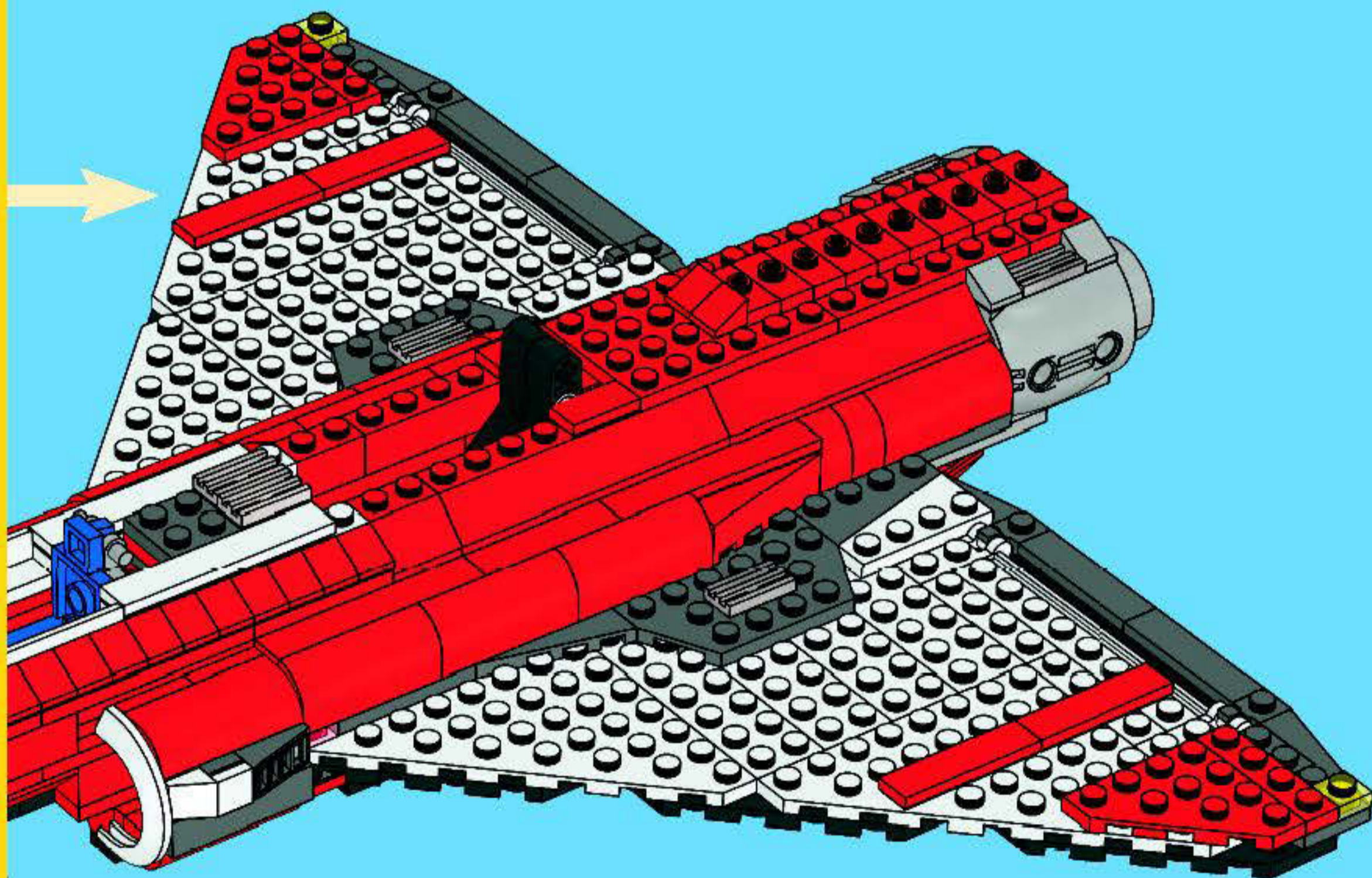

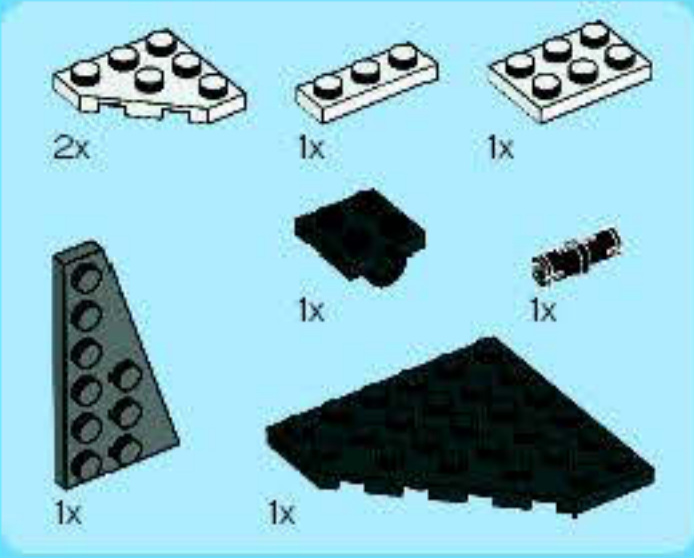

46

1



2



3



4



5

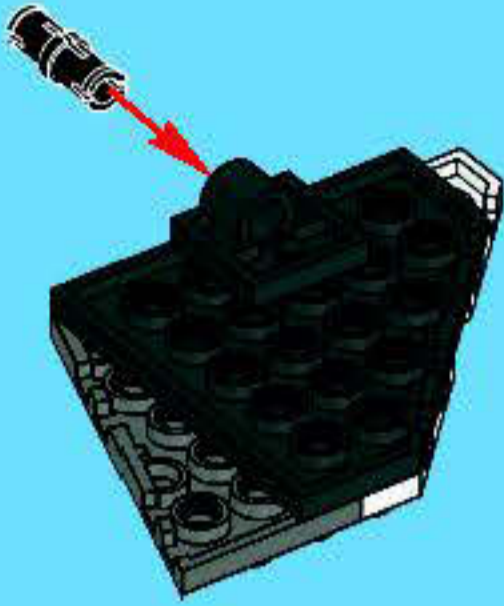

6

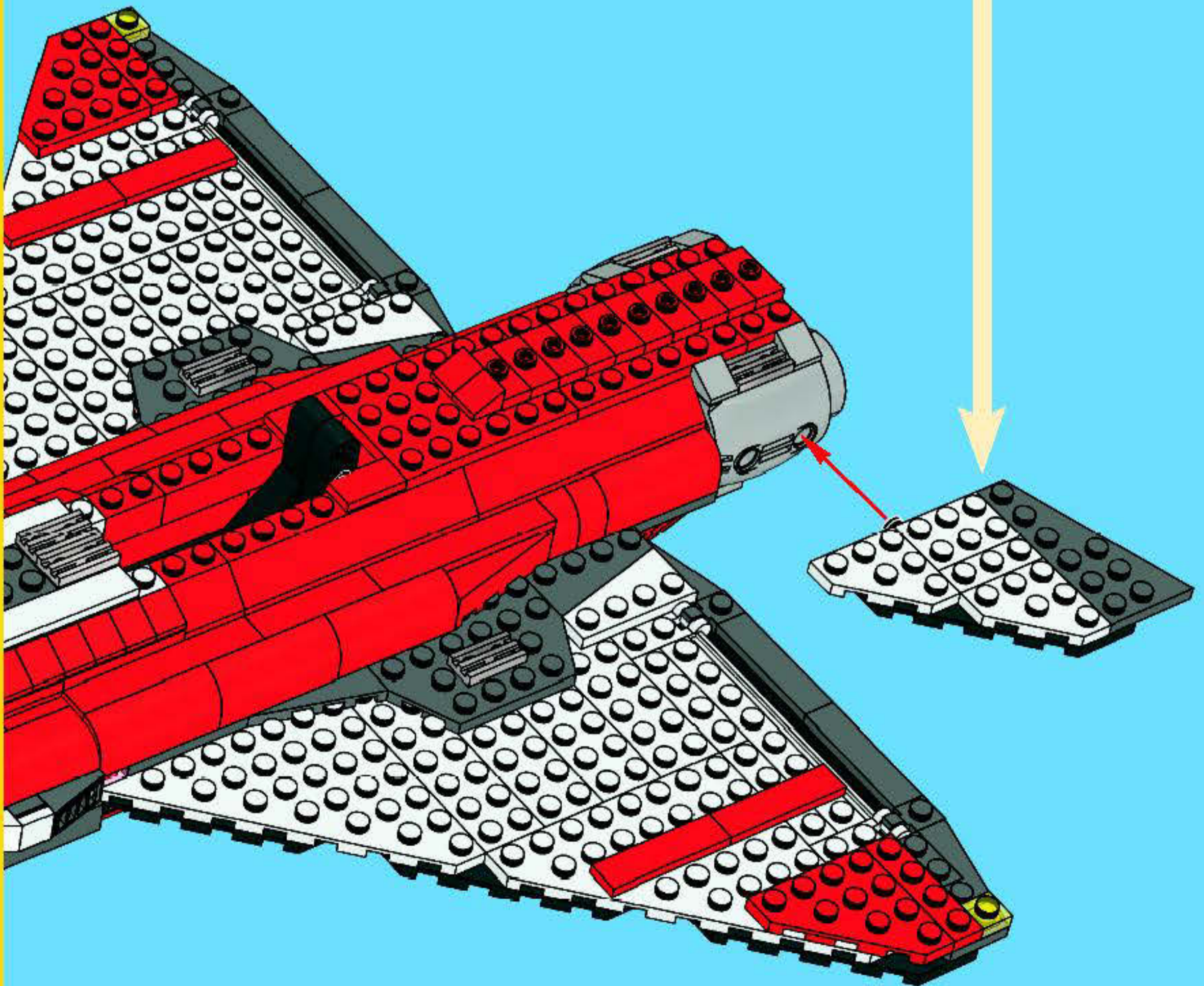
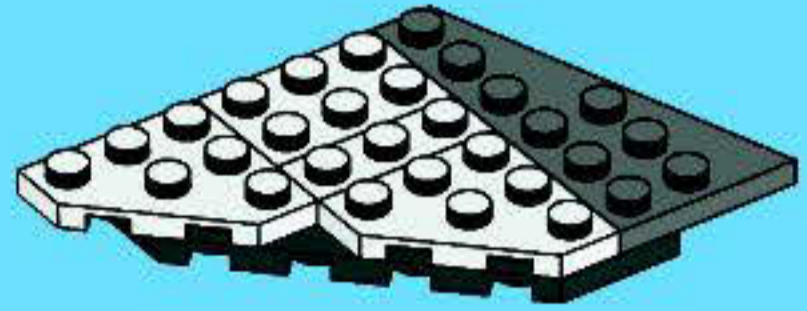

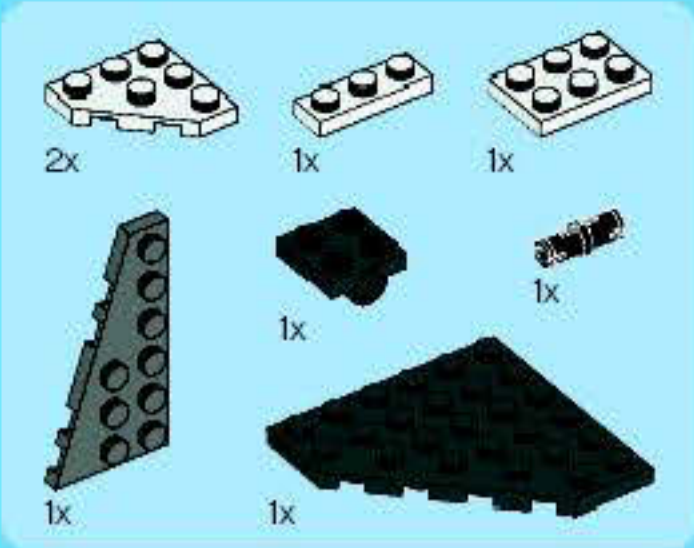

47

1



2



3



4

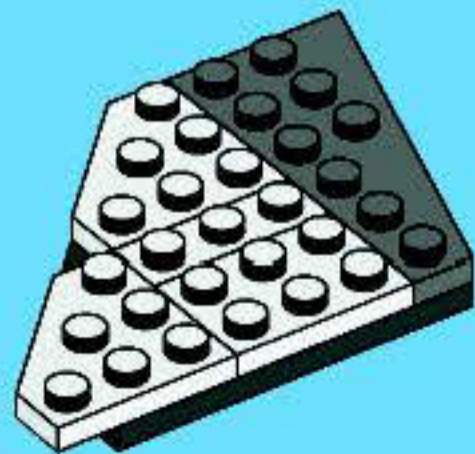

5

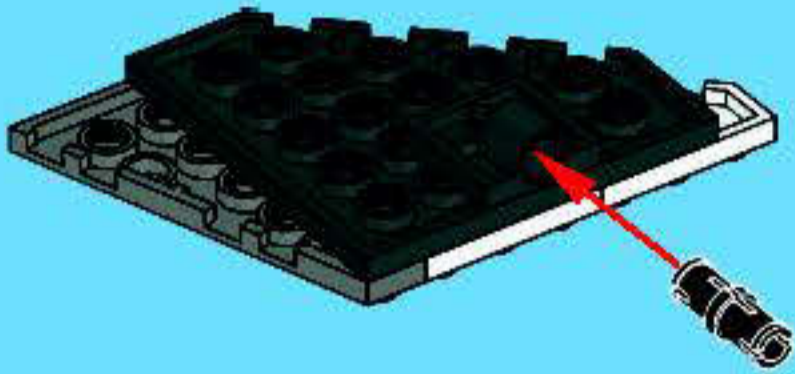

6

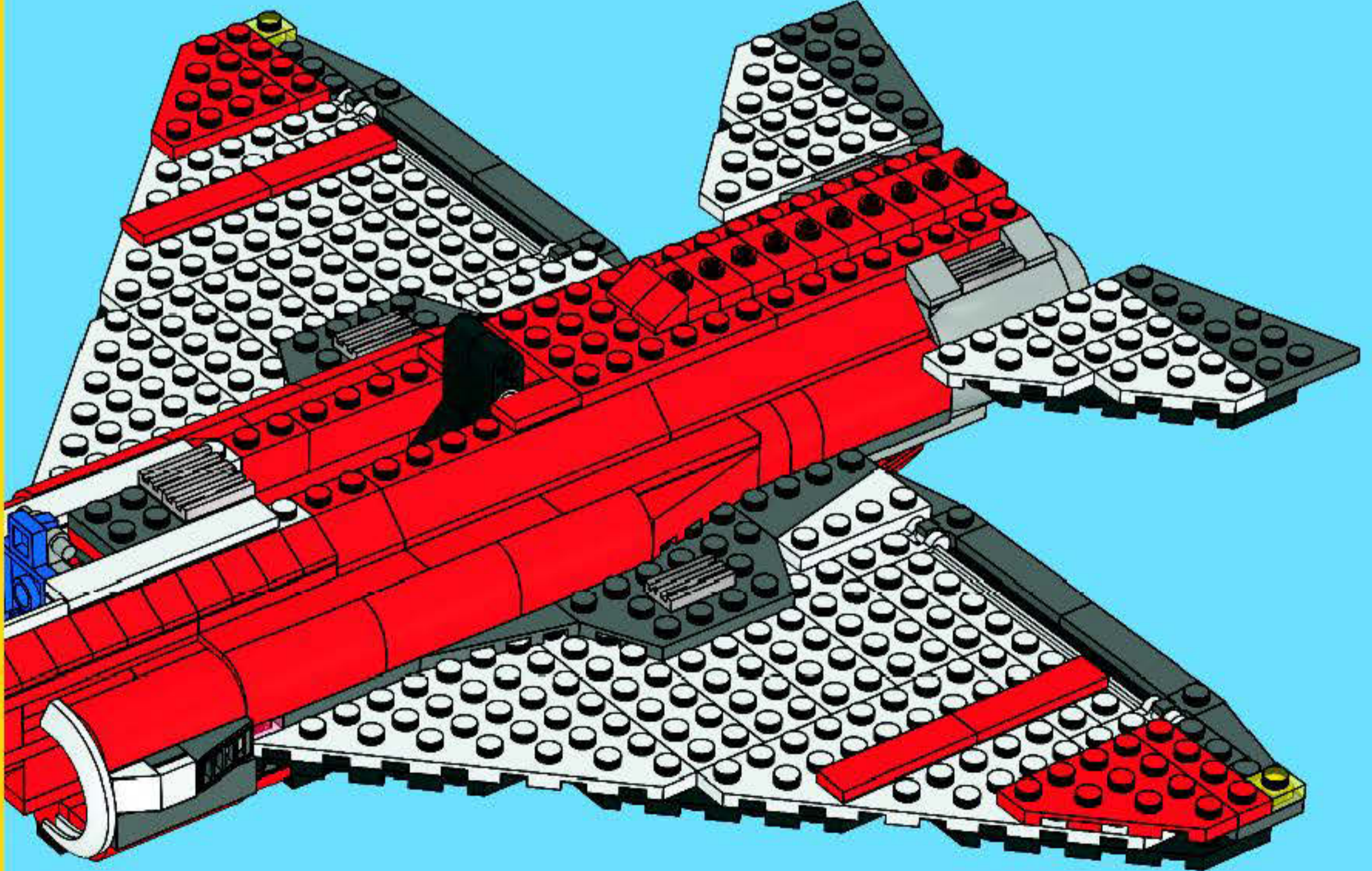
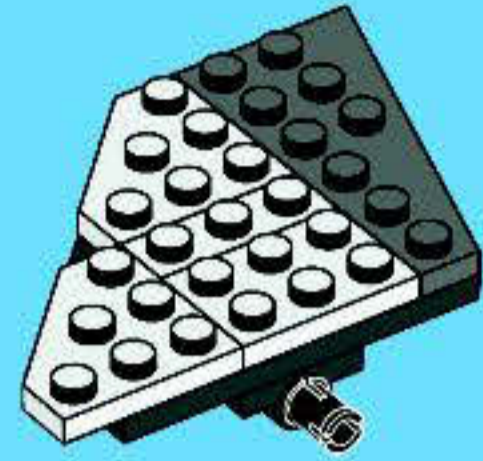

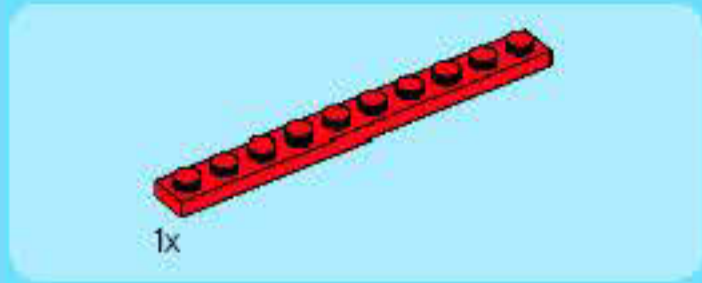
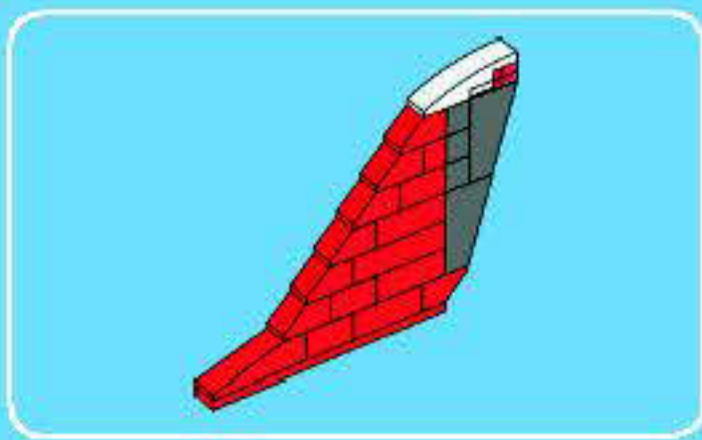

1

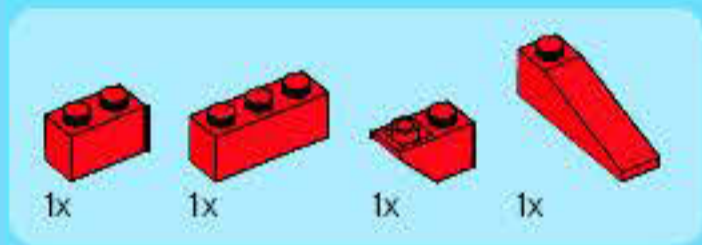
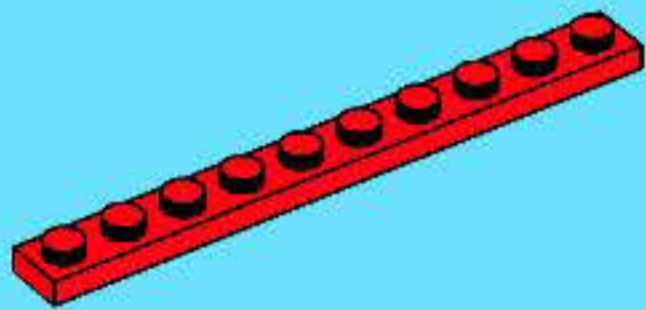

2

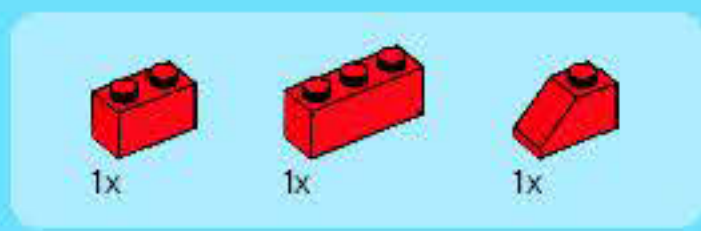
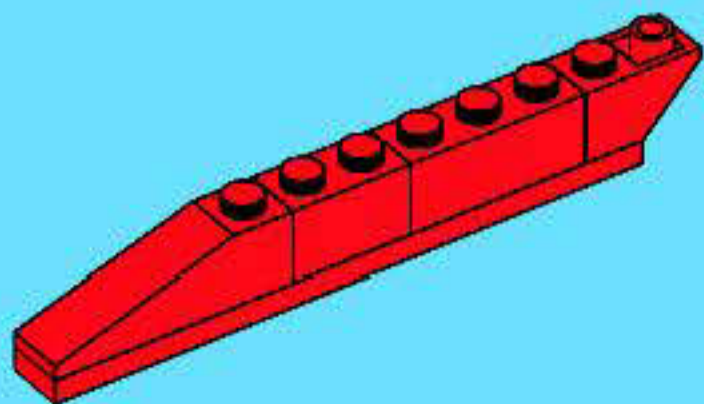

3

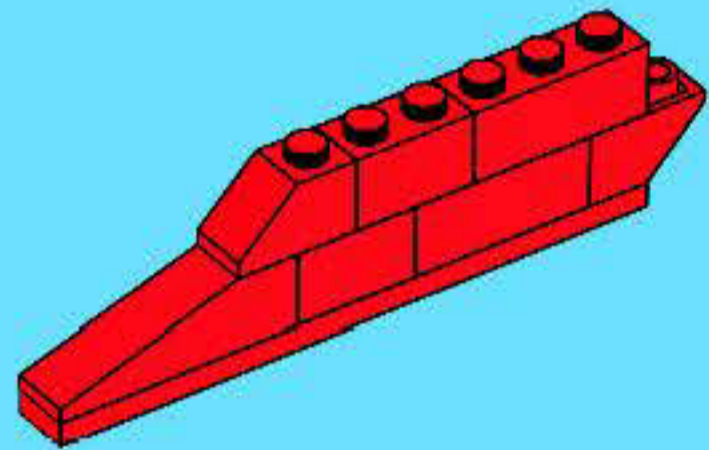

4

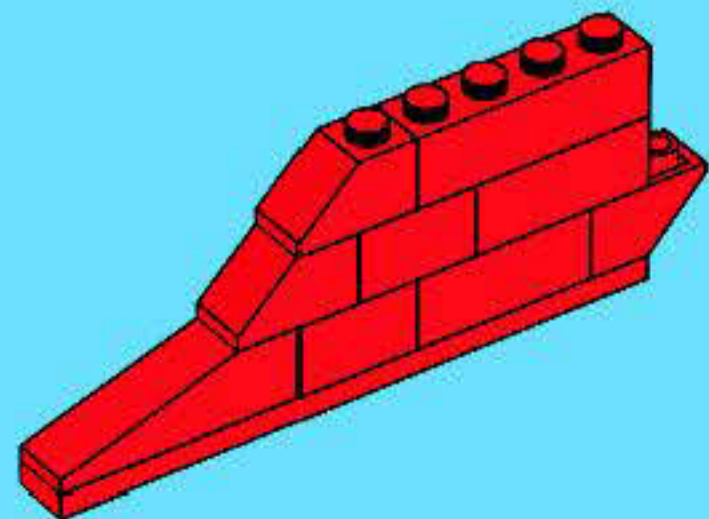

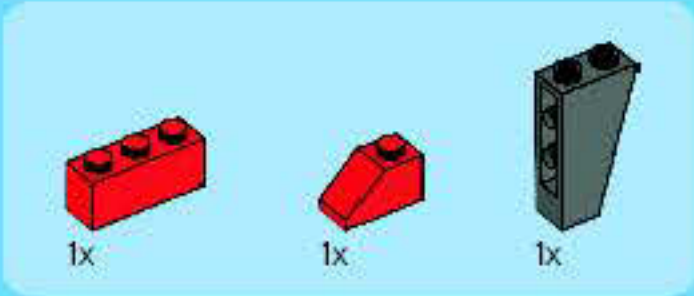

5

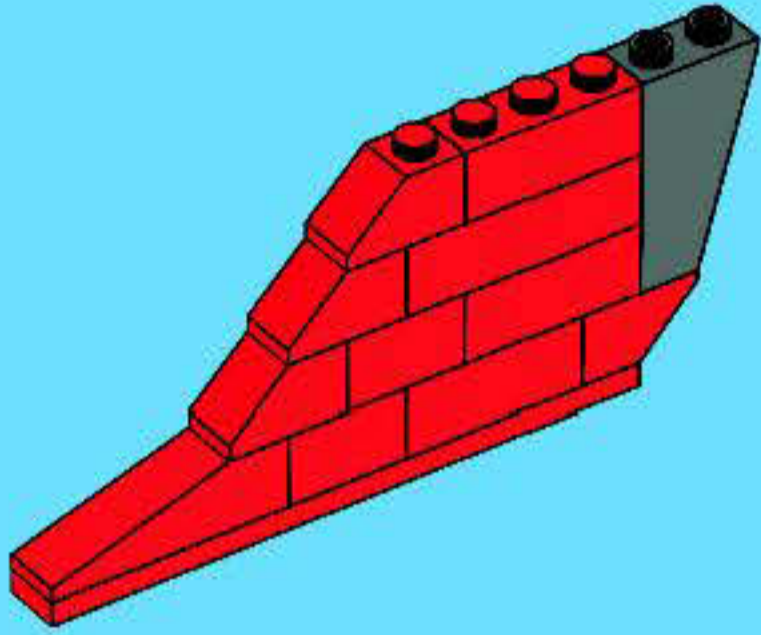

6

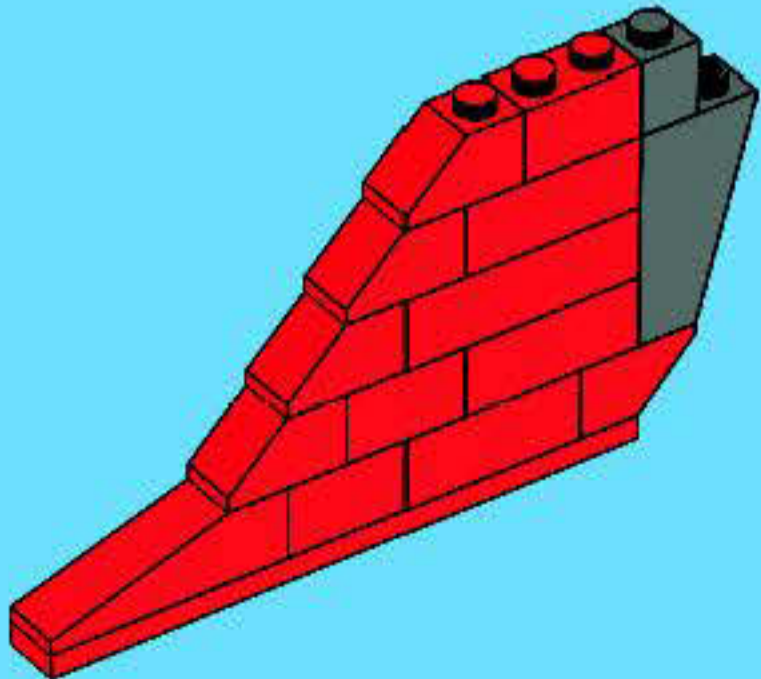

7

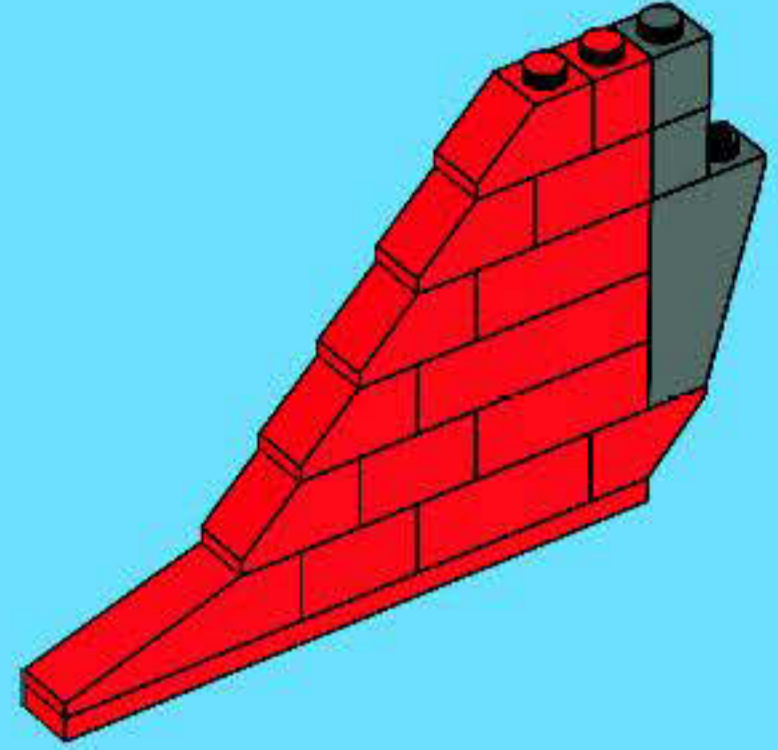

8

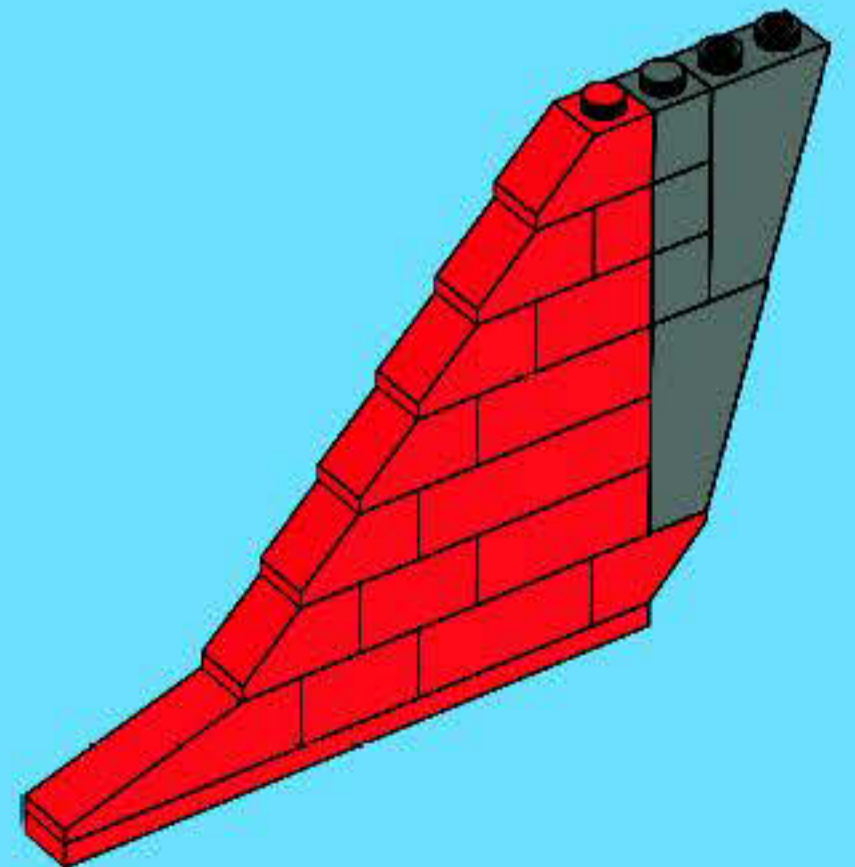



1x



2x

9

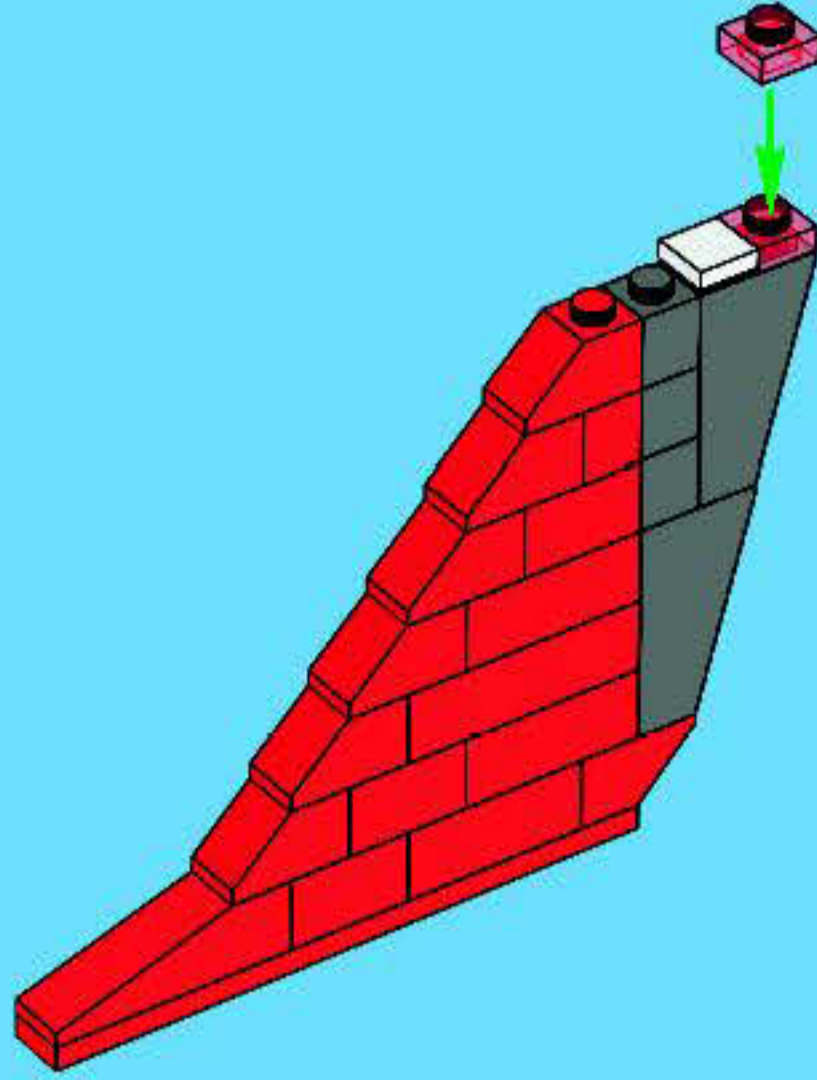

1x

10

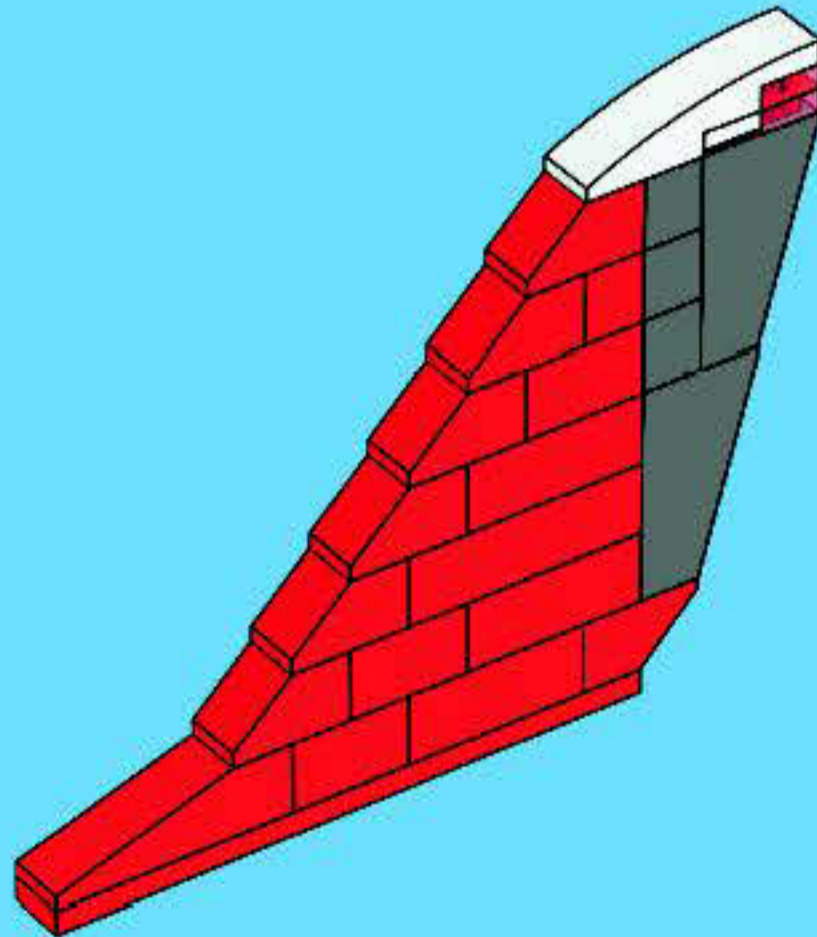



48

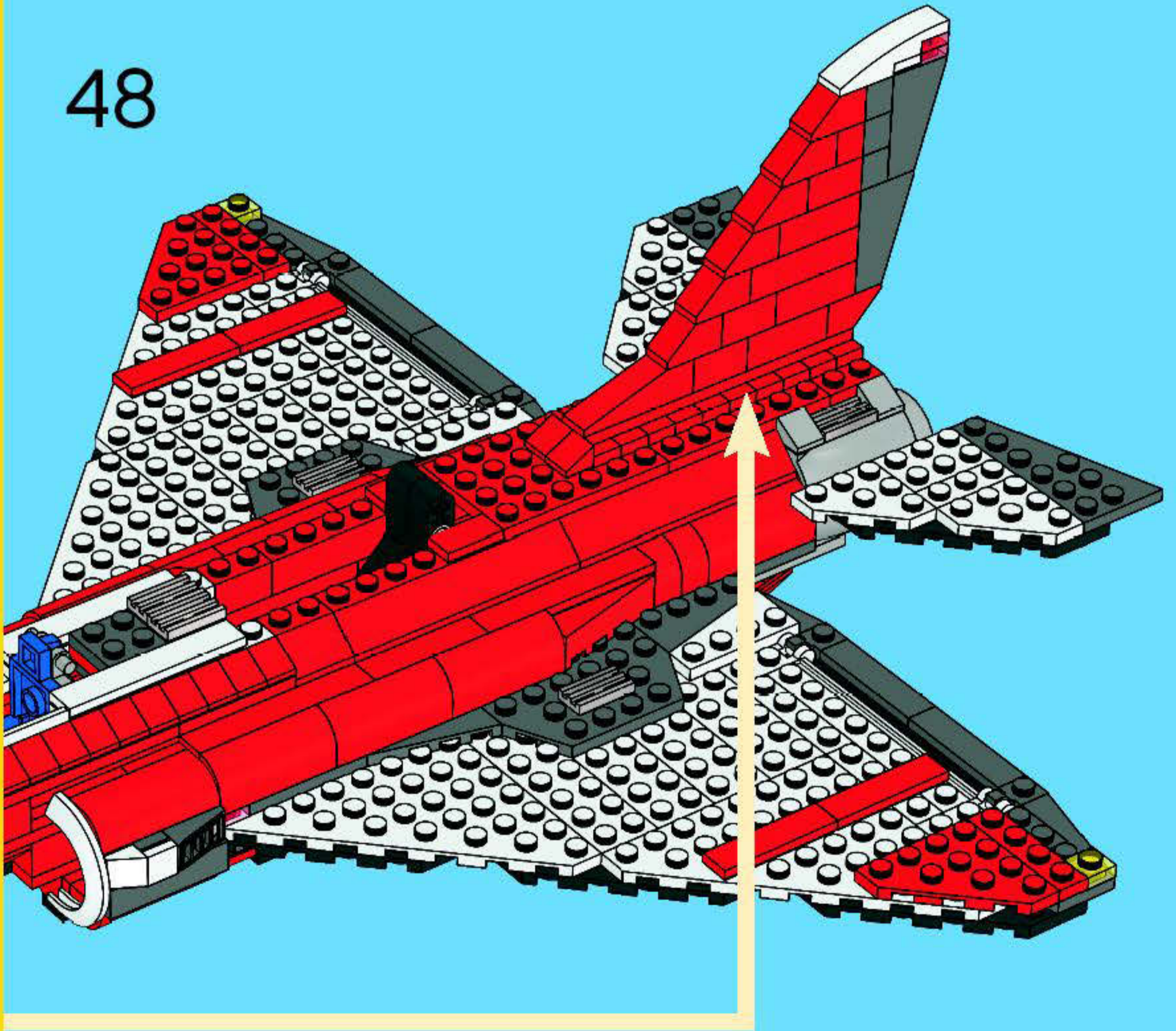

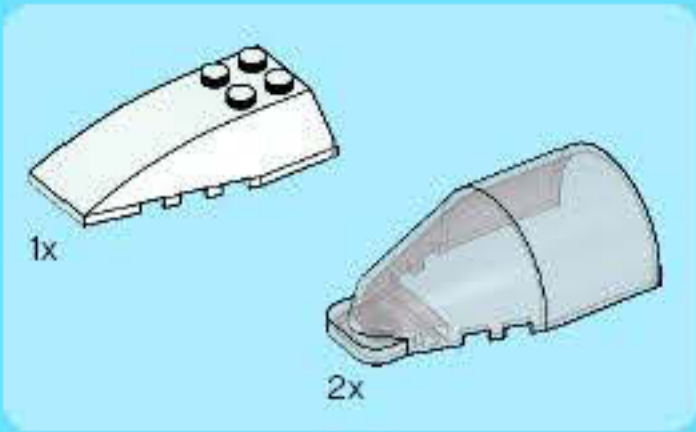

49

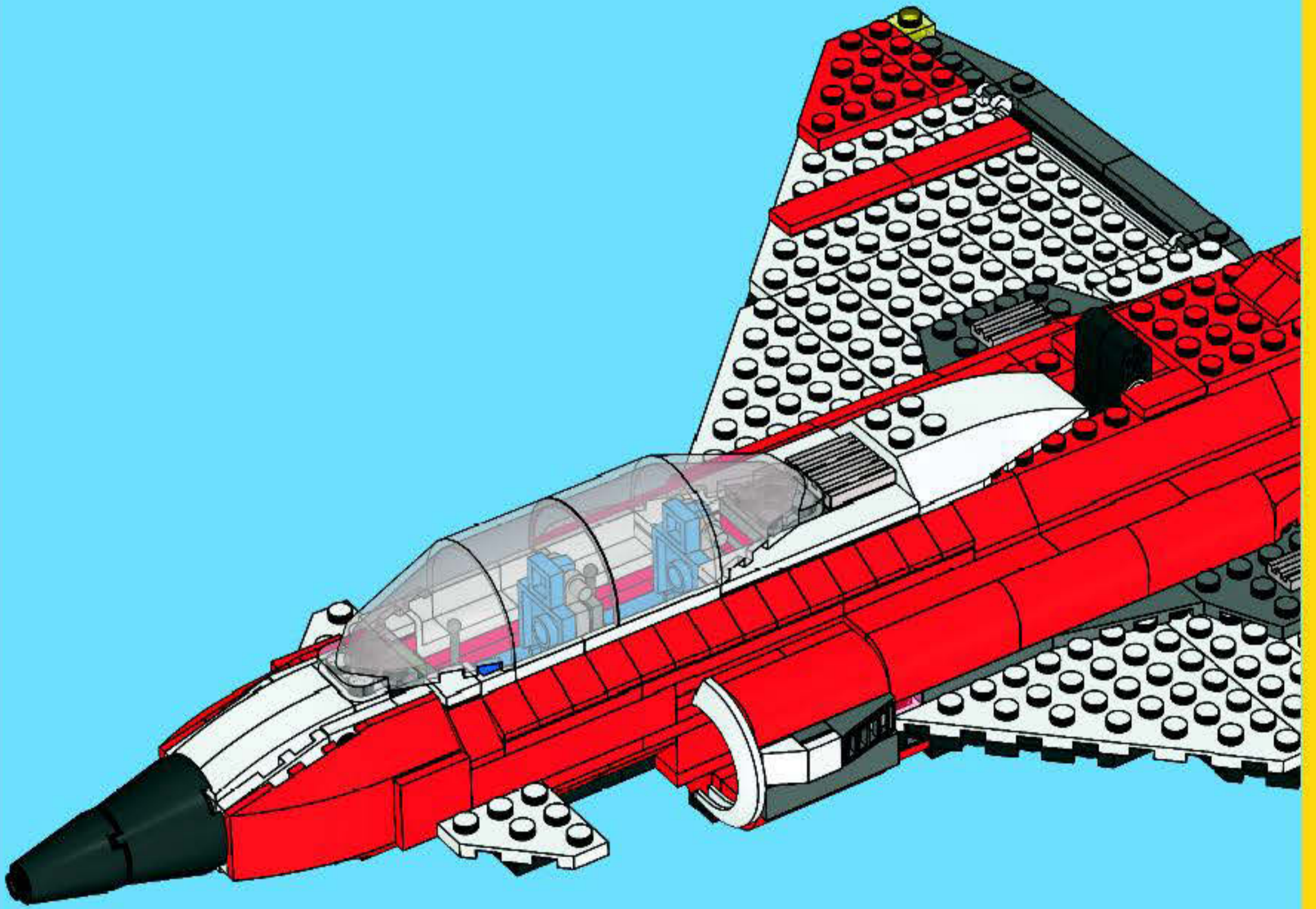

1

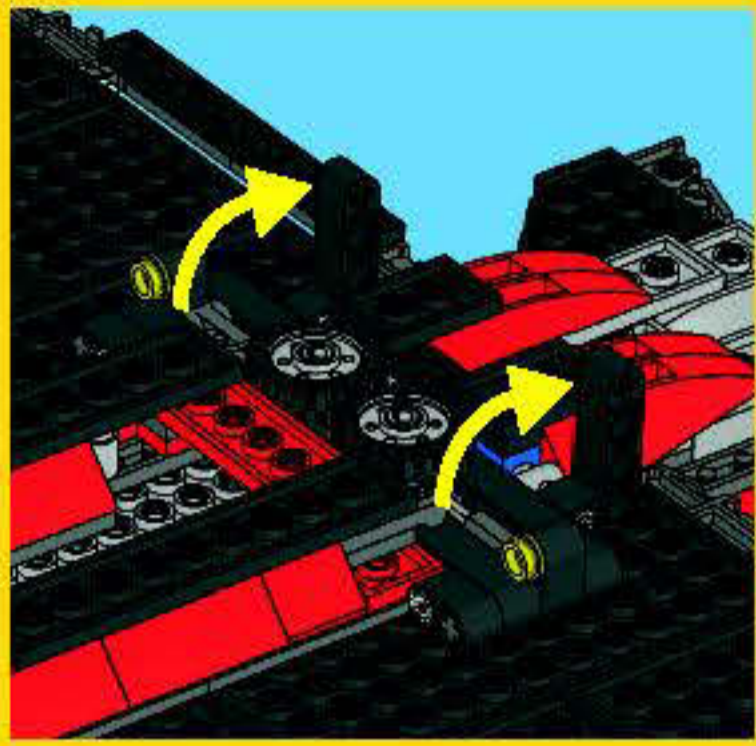

2

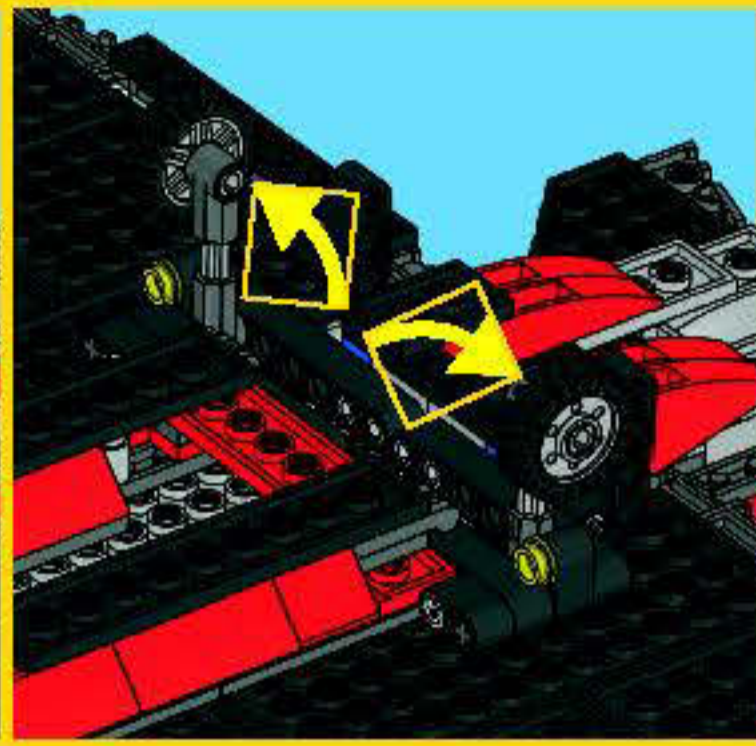

3

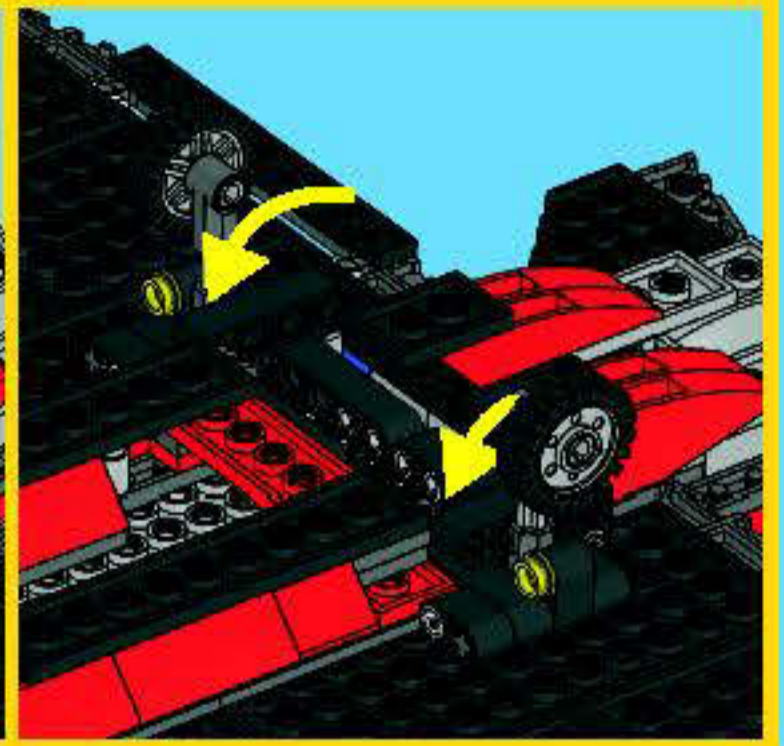

50

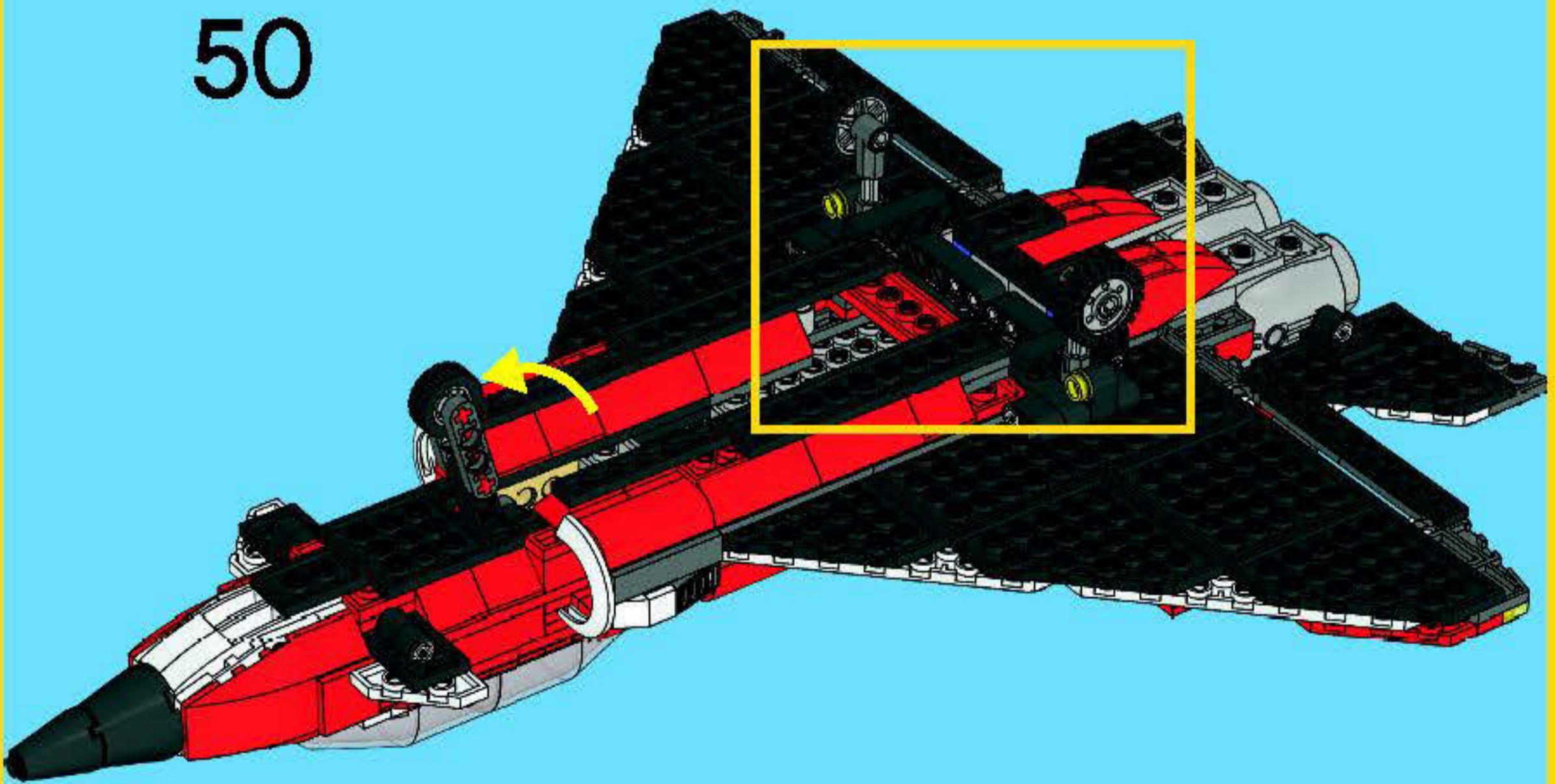

51

